

Model DAQ6510 Data Acquisition and Multimeter System

User's Manual

DAQ6510-900-01 Rev. A / April 2018



DAQ6510-900-01A

DAQ6510

Data Acquisition / Multimeter System

User's Manual

© 2018, Keithley Instruments, LLC

Cleveland, Ohio, U.S.A.

All rights reserved.

Any unauthorized reproduction, photocopy, or use of the information herein, in whole or in part, without the prior written approval of Keithley Instruments, LLC, is strictly prohibited.

These are the original instructions in English.

TSP®, TSP-Link®, and TSP-Net® are trademarks of Keithley Instruments, LLC. All Keithley Instruments product names are trademarks or registered trademarks of Keithley Instruments, LLC. Other brand names are trademarks or registered trademarks of their respective holders.

The Lua 5.0 software and associated documentation files are copyright © 1994 - 2015, Lua.org, PUC-Rio. You can access terms of license for the Lua software and associated documentation at the Lua licensing site (<http://www.lua.org/license.html>).

Microsoft, Visual C++, Excel, and Windows are either registered trademarks or trademarks of Microsoft Corporation in the United States and/or other countries.

Document number: DAQ6510-900-01Rev. A / April 2018

The following safety precautions should be observed before using this product and any associated instrumentation. Although some instruments and accessories would normally be used with nonhazardous voltages, there are situations where hazardous conditions may be present.

This product is intended for use by personnel who recognize shock hazards and are familiar with the safety precautions required to avoid possible injury. Read and follow all installation, operation, and maintenance information carefully before using the product. Refer to the user documentation for complete product specifications.

If the product is used in a manner not specified, the protection provided by the product warranty may be impaired.

The types of product users are:

Responsible body is the individual or group responsible for the use and maintenance of equipment, for ensuring that the equipment is operated within its specifications and operating limits, and for ensuring that operators are adequately trained.

Operators use the product for its intended function. They must be trained in electrical safety procedures and proper use of the instrument. They must be protected from electric shock and contact with hazardous live circuits.

Maintenance personnel perform routine procedures on the product to keep it operating properly, for example, setting the line voltage or replacing consumable materials. Maintenance procedures are described in the user documentation. The procedures explicitly state if the operator may perform them. Otherwise, they should be performed only by service personnel.

Service personnel are trained to work on live circuits, perform safe installations, and repair products. Only properly trained service personnel may perform installation and service procedures.

Keithley Instruments products are designed for use with electrical signals that are measurement, control, and data I/O connections, with low transient overvoltages, and must not be directly connected to mains voltage or to voltage sources with high transient overvoltages. Measurement Category II (as referenced in IEC 60664) connections require protection for high transient overvoltages often associated with local AC mains connections. Certain Keithley Instruments measuring instruments may be connected to mains. These instruments will be marked as category II or higher.

Unless explicitly allowed in the specifications, operating manual, and instrument labels, do not connect any instrument to mains.

Exercise extreme caution when a shock hazard is present. Lethal voltage may be present on cable connector jacks or test fixtures. The American National Standards Institute (ANSI) states that a shock hazard exists when voltage levels greater than 30 V RMS, 42.4 V peak, or 60 VDC are present. A good safety practice is to expect that hazardous voltage is present in any unknown circuit before measuring.

Operators of this product must be protected from electric shock at all times. The responsible body must ensure that operators are prevented access and/or insulated from every connection point. In some cases, connections must be exposed to potential human contact. Product operators in these circumstances must be trained to protect themselves from the risk of electric shock. If the circuit is capable of operating at or above 1000 V, no conductive part of the circuit may be exposed.

Do not connect switching cards directly to unlimited power circuits. They are intended to be used with impedance-limited sources. NEVER connect switching cards directly to AC mains. When connecting sources to switching cards, install protective devices to limit fault current and voltage to the card.

Before operating an instrument, ensure that the line cord is connected to a properly-grounded power receptacle. Inspect the connecting cables, test leads, and jumpers for possible wear, cracks, or breaks before each use.

When installing equipment where access to the main power cord is restricted, such as rack mounting, a separate main input power disconnect device must be provided in close proximity to the equipment and within easy reach of the operator.

For maximum safety, do not touch the product, test cables, or any other instruments while power is applied to the circuit under test. ALWAYS remove power from the entire test system and discharge any capacitors before: connecting or disconnecting cables or jumpers, installing or removing switching cards, or making internal changes, such as installing or removing jumpers.

Do not touch any object that could provide a current path to the common side of the circuit under test or power line (earth) ground. Always make measurements with dry hands while standing on a dry, insulated surface capable of withstanding the voltage being measured.

For safety, instruments and accessories must be used in accordance with the operating instructions. If the instruments or accessories are used in a manner not specified in the operating instructions, the protection provided by the equipment may be impaired.

Do not exceed the maximum signal levels of the instruments and accessories. Maximum signal levels are defined in the specifications and operating information and shown on the instrument panels, test fixture panels, and switching cards.

When fuses are used in a product, replace with the same type and rating for continued protection against fire hazard.

Chassis connections must only be used as shield connections for measuring circuits, NOT as protective earth (safety ground) connections.

If you are using a test fixture, keep the lid closed while power is applied to the device under test. Safe operation requires the use of a lid interlock.

If a  screw is present, connect it to protective earth (safety ground) using the wire recommended in the user documentation.

The  symbol on an instrument means caution, risk of hazard. The user must refer to the operating instructions located in the user documentation in all cases where the symbol is marked on the instrument.

The  symbol on an instrument means warning, risk of electric shock. Use standard safety precautions to avoid personal contact with these voltages.

The  symbol on an instrument shows that the surface may be hot. Avoid personal contact to prevent burns.

The  symbol indicates a connection terminal to the equipment frame.

If this  symbol is on a product, it indicates that mercury is present in the display lamp. Please note that the lamp must be properly disposed of according to federal, state, and local laws.

The **WARNING** heading in the user documentation explains hazards that might result in personal injury or death. Always read the associated information very carefully before performing the indicated procedure.

The **CAUTION** heading in the user documentation explains hazards that could damage the instrument. Such damage may invalidate the warranty.

The **CAUTION** heading with the  symbol in the user documentation explains hazards that could result in moderate or minor injury or damage the instrument. Always read the associated information very carefully before performing the indicated procedure. Damage to the instrument may invalidate the warranty.

Instrumentation and accessories shall not be connected to humans.

Before performing any maintenance, disconnect the line cord and all test cables.

To maintain protection from electric shock and fire, replacement components in mains circuits — including the power transformer, test leads, and input jacks — must be purchased from Keithley Instruments. Standard fuses with applicable national safety approvals may be used if the rating and type are the same. The detachable mains power cord provided with the instrument may only be replaced with a similarly rated power cord. Other components that are not safety-related may be purchased from other suppliers as long as they are equivalent to the original component (note that selected parts should be purchased only through Keithley Instruments to maintain accuracy and functionality of the product). If you are unsure about the applicability of a replacement component, call a Keithley Instruments office for information.

Unless otherwise noted in product-specific literature, Keithley Instruments instruments are designed to operate indoors only, in the following environment: Altitude at or below 2,000 m (6,562 ft); temperature 0 °C to 50 °C (32 °F to 122 °F); and pollution degree 1 or 2.

To clean an instrument, use a cloth dampened with deionized water or mild, water-based cleaner. Clean the exterior of the instrument only. Do not apply cleaner directly to the instrument or allow liquids to enter or spill on the instrument. Products that consist of a circuit board with no case or chassis (e.g., a data acquisition board for installation into a computer) should never require cleaning if handled according to instructions. If the board becomes contaminated and operation is affected, the board should be returned to the factory for proper cleaning/servicing.

Safety precaution revision as of June 2017.

Table of contents

Introduction	1-1
Welcome	1-1
Introduction to this manual	1-1
Extended warranty	1-2
Contact information	1-2
Documentation set	1-2
Organization of manual sections.....	1-2
Application examples	1-3
Front-panel overview	2-1
Front-panel overview.....	2-1
Instrument power	2-3
Connect the power cord	2-4
Turn the DAQ6510 on or off.....	2-4
Touchscreen display	2-5
Select items on the touchscreen	2-5
Scroll bars	2-5
Enter information.....	2-6
Adjust the backlight brightness and dimmer.....	2-6
Review event messages	2-7
Interactive swipe screens.....	2-7
Swipe screen heading bar.....	2-7
FUNCTIONS swipe screen	2-9
SETTINGS swipe screen	2-9
STATISTICS swipe screen.....	2-10
SECONDARY swipe screen.....	2-11
USER swipe screen	2-12
GRAPH swipe screen	2-12
SCAN swipe screen	2-14
Menu overview	2-16
Channel menu.....	2-17
Measure Menu	2-17
Views menu.....	2-18
Trigger menu.....	2-18
Scripts menu	2-18
System menu	2-19
Using a remote interface	3-1
Remote communications interfaces.....	3-1
Supported remote interfaces.....	3-2
LAN communications	3-2
Set up LAN communications on the instrument	3-3
Set up LAN communications on the computer	3-4
USB communications.....	3-5

Connect a computer to the DAQ6510 using USB	3-5
Communicate with the instrument	3-6
 GPIB communications.....	3-9
Install the KTTI-GPIB accessory card	3-9
Set the GPIB address	3-12
 RS-232	3-12
Install the KTTI-RS232 accessory card.....	3-12
 TSP-Link	3-14
Install the KTTI-TSP accessory card.....	3-14
 Using the web interface.....	3-15
Connect to the instrument web interface.....	3-15
LAN troubleshooting suggestions.....	3-16
Web interface Home page.....	3-17
Identify the instrument.....	3-18
 Determining the command set you will use	3-18
 Making basic front-panel measurements	4-1
Introduction	4-1
Equipment required for this example	4-1
Device connections	4-2
Basic front-panel measurements	4-3
 Scanning temperature using thermocouples	5-1
Introduction	5-1
Equipment required.....	5-1
Device connections	5-2
Thermocouple temperature scanning	5-3
Using the front panel	5-4
Using SCPI commands	5-5
Using TSP commands	5-6
Test results.....	5-7
 Scanning low-level DCV	6-1
Introduction	6-1
Equipment required.....	6-1
Device connections	6-2
Scanning low-level DCV.....	6-3
Using the front panel	6-4
Using SCPI commands	6-4
Using TSP commands	6-6
 Scanning resistors using 4W measurement.....	7-1
Introduction	7-1
Equipment required.....	7-2

Device connections	7-3
Scanning resistors using 4-wire measurements	7-5
Using the front panel	7-5
Using SCPI commands	7-6
Using TSP commands	7-7
Test results.....	7-8
Mixed function multi-channel scanning	8-1
Introduction	8-1
Equipment required.....	8-1
Device connections	8-2
Mixed function multi-channel scanning	8-3
Using the front panel	8-4
Using SCPI commands	8-5
Using TSP commands	8-6
Test results.....	8-7
Speed scanning for increased test throughput	9-1
Introduction	9-1
Equipment required.....	9-1
Device connections	9-2
Speed scanning for increased production test throughput	9-3
Using SCPI commands	9-4
Using TSP commands	9-6
Test results.....	9-7
Pre-scan monitor	10-1
Introduction	10-1
Equipment required.....	10-1
Device connections	10-2
Pre-scan monitor.....	10-3
Using the front panel	10-3
Using SCPI commands	10-4
Using TSP commands	10-5
Troubleshooting/FAQ	11-1
About this section.....	11-1
Where can I find updated drivers?	11-1
Is there any software to help me get started.....	11-2
How do I upgrade the firmware?	11-2
Why can't the DAQ6510 read my USB flash drive?.....	11-3
How do I change the command set?	11-3
How do I save the present state of the instrument?	11-4

Why did my settings change? 11-5

What is the ethernet port number? 11-5

Next steps 12-1

 Additional DAQ6510 information..... 12-1

Index I-1

Introduction

In this section:

Welcome	1-1
Introduction to this manual	1-1
Extended warranty	1-2
Contact information	1-2
Documentation set	1-2
Organization of manual sections	1-2
Application examples	1-3

Welcome

Thank you for choosing a Keithley Instruments product. The DAQ6510 is a 6½ digit graphical sampling data-acquisition system that provides high-speed digitizing and a large graphical color touchscreen display. This DAQ offers a broad range of measurement capabilities, including 15 measurement functions. In addition to industry-leading DC accuracies, functions such as capacitance, 3 A current, and 16-bit current and voltage digitizing are included. Tying all these features together is a large 5-inch color touchscreen display that brings users an unprecedented combination of data visualization and interaction, enabling users to gain deeper insight into their measurements.

The DAQ6510 provides superior measurement accuracy and the speed necessary for a broad range of applications including system, production testing, and benchtop applications. The DAQ6510 meets application requirements for production engineers, research and development engineers, test engineers, and scientists.

Introduction to this manual

This manual provides detailed applications to help you achieve success with your Keithley Instruments DAQ6510. In addition, this manual provides information about the basics of the front panel to familiarize you with the instrument.

This manual presents an overview of each application, followed by instructions to complete the application using the front panel, SCPI code, TSP code, or Keithley KickStart Startup Software.

More information about the commands that are used in these applications is available. Refer to the SCPI and TSP command reference sections of the *Model DAQ6510 Reference Manual*. This manual is on tek.com/keithley.

Extended warranty

Additional years of warranty coverage are available on many products. These valuable contracts protect you from unbudgeted service expenses and provide additional years of protection at a fraction of the price of a repair. Extended warranties are available on new and existing products. Contact your local Keithley Instruments office, sales partner, or distributor for details.

Contact information

If you have any questions after you review the information in this documentation, please contact your local Keithley Instruments office, sales partner, or distributor. You can also call the corporate headquarters of Keithley Instruments (toll-free inside the U.S. and Canada only) at 1-800-935-5595, or from outside the U.S. at +1-440-248-0400. For worldwide contact numbers, visit tek.com/keithley.

Documentation set

The DAQ6510 documentation is supported by the following technical/product information documentation.

- **Quick Start Guide:** Provides unpacking instructions, describes basic connections, reviews basic operation information, and provides a quick test procedure to ensure the instrument is operational.
- **User's Manual:** Provides application examples that you can use as a starting point to create your own applications.
- **Reference Manual:** Includes advanced operation topics, maintenance information, troubleshooting procedures, and in-depth descriptions of programming commands.
- **Accessories information:** Documentation for accessories that are available for the DAQ6510.

For the latest drivers and additional support information, see tek.com/keithley.

Organization of manual sections

This manual is organized into the following sections:

- [Using the front-panel interface:](#) (on page 2-1) Describes the basics of using the front-panel interface.
- [Using a remote interface:](#) (on page 3-1) Describes the basics of remote communications and using the instrument web interface.
- Application examples (see below): Provides detailed examples of how to use the DAQ6510 in some typical situations.
- [Troubleshooting FAQs:](#) (on page 11-1) Provides answers to frequently asked questions to help you troubleshoot common problems encountered with the DAQ6510.
- [Next steps:](#) (on page 12-1) Provides information about additional resources that can help you use the DAQ6510.

The PDF version of this manual contains bookmarks for each section. The manual sections are also listed in the Table of Contents at the beginning of this manual.

For more information about bookmarks, see Adobe® Acrobat® or Reader® help.

Application examples

This manual provides application examples that show you how to perform tests from the front panel and over a remote interface. The applications include:

- [Making basic front-panel measurements](#): (on page 4-1) Shows the basic measure functionality using a single DAQ6510 and a two-terminal device under test.
- [Making basic scans](#): (on page 4-1) Shows the basic measure scan functionality using a single DAQ6510.
- [Scanning temperature using thermocouples](#): (on page 5-1) Shows how to use the DAQ6510 to log thermocouple-based temperature measurement scans.
- [Scanning low-level DCV](#): (on page 6-1) Shows how to use the DAQ6510 to accurately measure DC voltage in a variety of ranges
- [Scanning resistors using 4W measurement](#): (on page 7-1) Shows how to use the DAQ6510 to accurately measure resistance devices
- [Mixed function multi-channel scanning](#): (on page 8-1) Shows how to use the DAQ6510 to perform complex multi-channel, mixed function scanning in a production-test environment.
- [Speed scanning for increased production test throughput](#): (on page 9-1) Shows how selecting the right multiplexer module can increase your productivity by reducing overall test time.
- [Pre-scan monitoring](#): (on page 10-3) Shows how to configure the DAQ6510 to delay its scanning function until the testing environment has reached a specific temperature.

Front-panel overview

In this section:

Front-panel overview	2-1
Instrument power	2-3
Touchscreen display	2-5
Interactive swipe screens	2-7
Menu overview	2-16

Front-panel overview

The front panel of the DAQ6510 is shown below. Descriptions of the controls on the front panel follow the figure.

Figure 1: DMM6500 front panel

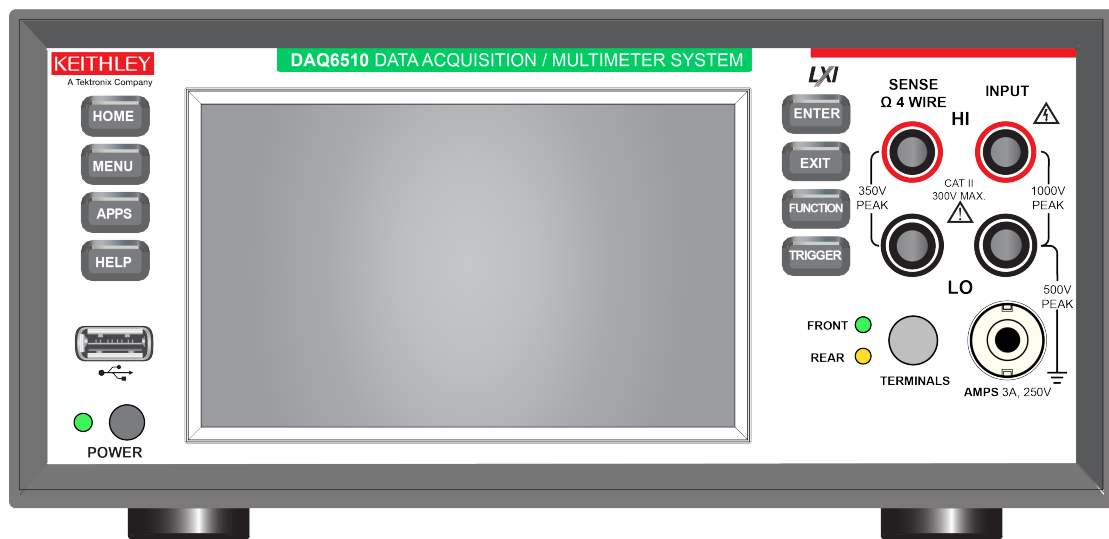

POWER switch











Turns the instrument on or off. To turn the instrument on, press and hold the power switch. To turn it off, press and hold the power switch again. The LED is green when the instrument is on and the LED is amber when turned off.

HOME key



Returns the display to the Home screen.

MENU key		Opens the main menu. Press the icons on the main menu to open channel, measure, views, trigger, scripts, and system screens. For details, refer to Menu overview (on page 2-16).
APPS key		Opens a menu of of preconfigured TSP scripts with a graphical user interface.
HELP key		Opens help for the area or item that is selected on the display. If there is no selection when you press the HELP key, it displays overview information for the screen you are viewing.
USB port		Saves reading buffer data and screen snapshots to a USB flash drive. You can also store and retrieve scripts to and from a USB flash drive. The flash drive must be formatted as a FAT or FAT32 drive.
Touchscreen		The DAQ6510 has a high-resolution, five-inch color touchscreen display. The touchscreen accesses swipe screens and menu options. You can access additional interactive screens by pressing the front-panel MENU, APPS, and FUNCTION keys. Refer to Touchscreen display (on page 2-5) for details.
ENTER key		Selects the highlighted choice or allows you to edit the selected field.
EXIT key		Returns to the previous screen or closes a dialog box. For example, press the EXIT key when the main menu is displayed to return to the Home screen. When you are viewing a subscreen (for example, the Event Log screen), press the EXIT key to return to the main menu screen.
FUNCTION key		Displays instrument functions. To select a function, touch the function name on the screen.
TRIGGER key		Accesses trigger-related settings and operations. The action of the TRIGGER key depends on the instrument state. For details, see "Switching between measurement methods" in the <i>Model DAQ6510 Reference Manual</i> .

SENSE terminals

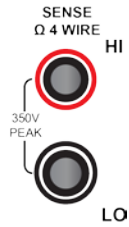

Use the SENSE HI and SENSE LO terminals and the INPUT terminals with the 4-wire resistance, 3-wire and 4-wire RTD temperature, and DC voltage ratio functions.

INPUT terminals

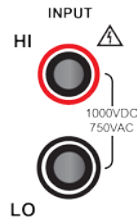

Use the INPUT HI and INPUT LO terminals for all measurements except current.

AMPS



Use the AMPS connection with the INPUT LO terminal to measure $\leq 3A$ DC or AC_{RMS} current.

TERMINALS switch

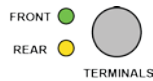

Activates the terminals on the front or rear panel. Selecting the rear panel provides the proper connections to an inserted module. When the front-panel terminals are active, the green LED is visible. When the rear-panel terminals are active, the amber LED is visible.

Instrument power

Follow the steps below to connect the DAQ6510 to line power and turn on the instrument. The DAQ6510 operates from a line voltage of 100 V to 240 V at a frequency of 50 Hz or 60 Hz. Make sure the operating voltage in your area is compatible. The default setting is 240V.

Before plugging in the line cord, check the line setting block on the rear of the instrument. If it doesn't match their mains installation setting, remove the block and reinsert to select voltage.

You must turn on the DAQ6510 and allow it to warm up for at least 30 minutes to achieve rated accuracies.

CAUTION

Operating the instrument on an incorrect line voltage may cause damage to the instrument, possibly voiding the warranty.

WARNING

The power cord supplied with the DAQ6510 contains a separate protective earth (safety ground) wire for use with grounded outlets. When proper connections are made, the instrument chassis is connected to power-line ground through the ground wire in the power cord. In the event of a failure, not using a properly grounded protective earth and grounded outlet may result in personal injury or death due to electric shock.

Do not replace detachable mains supply cords with inadequately rated cords. Failure to use properly rated cords may result in personal injury or death due to electric shock.

Connect the power cord

To connect the power cord:

1. Make sure that the front-panel POWER switch is in the off (O) position.
2. Connect the female end of the supplied power cord to the AC receptacle on the rear panel.
3. Connect the male end of the power cord to a grounded AC outlet.

Turn the DAQ6510 on or off

WARNING

Hazardous voltages may be present on all output and guard terminals. To prevent electrical shock that could cause injury or death, remove power from the instrument or test system and discharge any energy storage components (for example, capacitors or cables) before changing any connections that might allow contact with an uninsulated conductor.

NOTE

On some sensitive or easily damaged devices under test (DUTs), the instrument power-up or power-down sequence can apply transient signals to the DUT that may affect or damage it.

When testing this type of DUT, do not make final connections to it until the instrument has completed its power-up sequence and is in a known operating state. Disconnect it from the instrument before turning the instrument off.

To prevent any human contact with a live conductor, connections to the DUT must be fully insulated and the final connections to the DUT must only use safety-rated safety jack socket connectors that do not allow bodily contact.

To turn a DAQ6510 on:

1. Disconnect any devices under test (DUTs) from the DAQ6510.

Press and hold the front-panel **POWER** switch to place it in the on position.

The instrument displays a status bar as the instrument powers on. The Home screen is displayed when power on is complete.

To turn a DAQ6510 off:

1. Press and hold the front-panel **POWER** switch to place it in the off position.

Touchscreen display

The touchscreen display gives you quick front-panel access to measure settings, system configuration, instrument and test status, reading buffer information, and other instrument functionality. The display has multiple swipe screens that you can access by swiping the front panel. You can access additional interactive screens by pressing the front-panel MENU, APPS, and FUNCTION keys.

CAUTION

Do not use sharp metal objects, such as tweezers or screwdrivers, or pointed objects, such as pens or pencils, to touch the touchscreen. It is strongly recommended that you use only fingers to operate the instrument. Use of clean-room gloves to operate the touchscreen is supported.

Select items on the touchscreen

To select an item on the displayed screen:

- Press the corresponding icon on the screen.

The following topics describe the DAQ6510 touchscreen in more detail.

Scroll bars

Some of the interactive screens have additional options that are only visible when you scroll down the screen. A scroll indicator on the right side of the touchscreen identifies these screens. Swipe the screen up or down to view the additional options.

The figure below shows a screen with a scroll bar.

Figure 2: Scroll bar

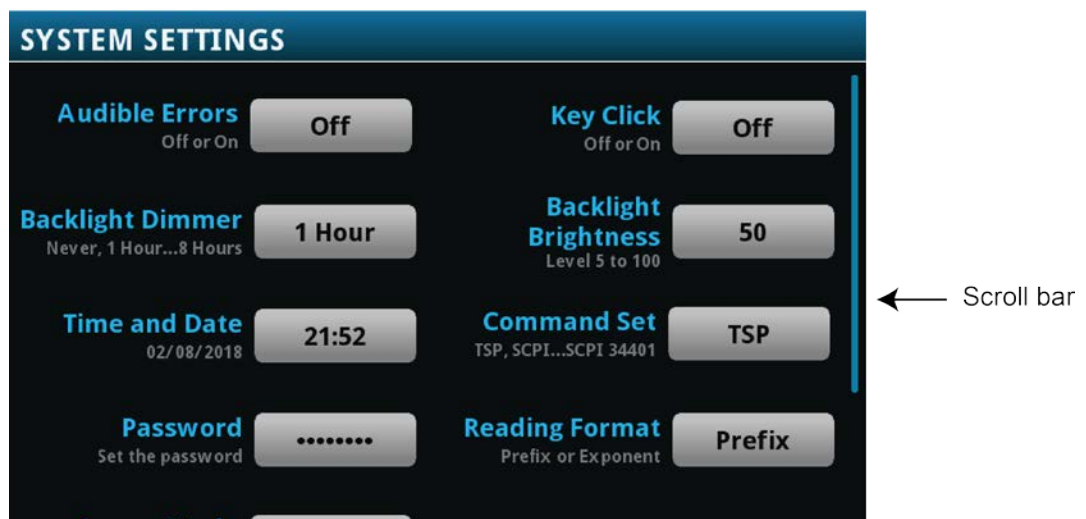

Enter information

Some of the menu options open a keypad or keyboard that you can use to enter information. For example, if you are creating a new reading buffer from the front panel, you see the keypad shown in the following figure.

Figure 3: DAQ6510 front-panel keyboard for information entry



You can enter information by touching the screen to select characters and options from the keypad or keyboard. You can move the cursor in the entry box by touching the screen. The cursor is moved to the spot in the entry box where you touched the screen.

Adjust the backlight brightness and dimmer

You can adjust the brightness of the DAQ6510 touchscreen display and buttons from the front panel or over a remote interface. You can also set the backlight to dim after a specified time has passed with no front-panel activity (available from the front-panel display only). The backlight settings set through the front-panel display are saved through a reset or power cycle.

NOTE

Screen life is affected by how long the screen is on at full brightness. The higher the brightness setting and the longer the screen is bright, the shorter the screen life.

To adjust the backlight brightness from the front panel:

1. Press the **MENU** key.
2. Under System, select **Settings**.
3. Select the **Backlight Brightness**. The Backlight Brightness dialog box opens.
4. Drag the adjustment to set the backlight.
5. Select **OK**.

To set the backlight dimmer from the front panel:

1. Press the **MENU** key.
2. Under System, select **Settings**.
3. Select **Backlight Dimmer**. The Backlight Dimmer dialog box opens.
4. Select a dimmer setting.

Review event messages

During operation and programming, front-panel messages may be briefly displayed. Messages are either information, warning, or error notifications. For information on event messages, refer to "Using the event log" in the *Model DAQ6510 Reference Manual*.

Figure 4: Example front-panel event message

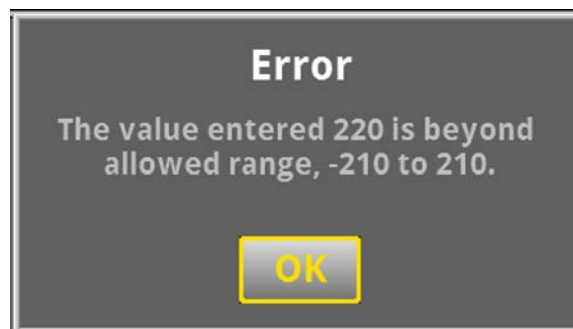

Interactive swipe screens





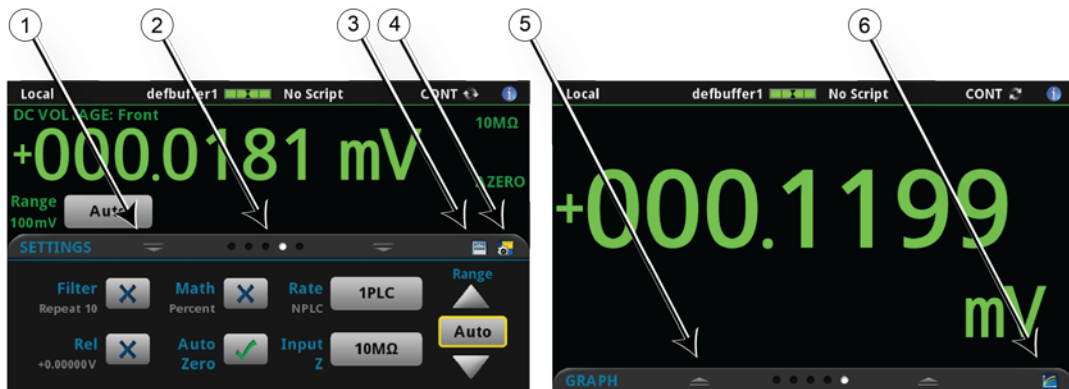

The DAQ6510 touchscreen display has multiple screens that you can access by swiping left or right on the lower half of the display. The options available in the swipe screens are described in the following topics.

Swipe screen heading bar

The heading bar of the swipe screen contains the following options.

Figure 5: DAQ6510 swipe screens, maximized and minimized



#	Screen element	Description
1	Minimize indicator	You can swipe down to minimize the swipe screens.
2	Swipe screen indicator	Each circle represents one swipe screen. As you swipe right or left, a different circle changes color, indicating where you are in the screen sequence. Select a circle to move the swipe screen without swiping.
3	Calculations shortcut 	Select to open the CALCULATION SETTINGS menu. Only available when TERMINALS is set to FRONT.
4	Measure Settings shortcut 	Select to open the MEASURE SETTINGS menu for the selected function. Only available when TERMINALS is set to FRONT.
5	Restore indicator	Indicates that you can swipe up to display the swipe screen.
6	Graph shortcut 	Select to open the Graph screen.
	Channel Settings shortcut 	Not shown. Select to open the CHANNEL SETTINGS screen.
	Scan shortcut 	Not shown. Select to open the SCAN screen.
	Channel control shortcut 	Not shown. Select to open the CHANNEL CONTROL screen.

FUNCTIONS swipe screen

The FUNCTIONS swipe screen highlights the selected measure function and allows you to select a different function.

Figure 6: FUNCTIONS swipe screen



SETTINGS swipe screen

The SETTINGS swipe screen gives you front-panel access to some instrument settings for the selected measure function. It shows you the present settings and allows you to change them. The available settings depend on which measure function is active.

Figure 7: SETTINGS swipe screen

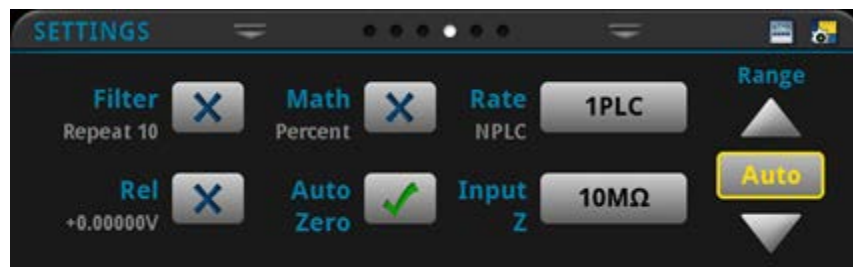

To disable or enable a setting, select the box next to the setting so that it shows an X (disabled) or a check mark (enabled).

STATISTICS swipe screen

The STATISTICS swipe screen contains information about the readings in the active reading buffer. When the reading buffer is configured to fill continuously and overwrite old data with new data, the buffer statistics include the data that was overwritten. To get statistics that do not include data that has been overwritten, define a large buffer size that will accommodate the number of readings you will make. You can use the **Clear Active Buffer** button on this screen to clear the data from the active reading buffer.

Figure 8: STATISTICS swipe screen

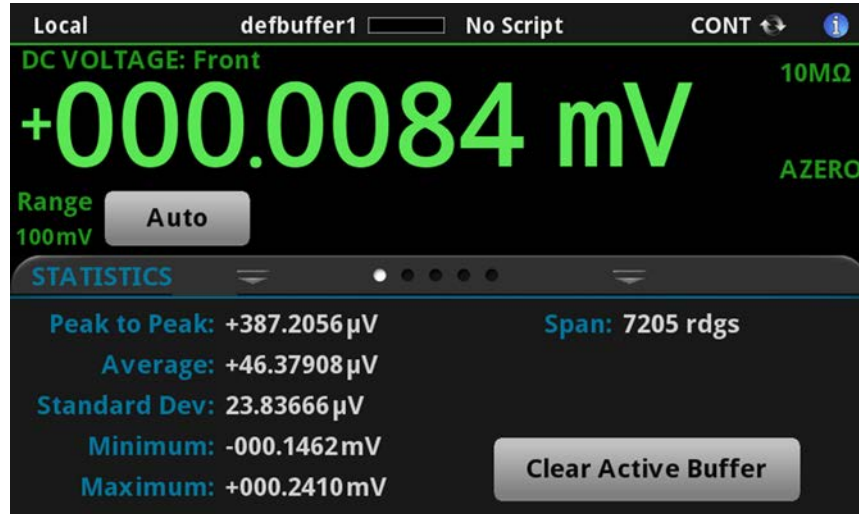

SECONDARY swipe screen

The SECONDARY swipe screen allows you to display the results of two measurements on the front-panel display.

To start displaying secondary measurements, select the Second Function and select Secondary Measure. Secondary measurements are only available in Continuous Measurement Mode and Manual Trigger Mode. This feature is only available from the front panel of the instrument.

Refer to "Display results of two measure functions" in the *Model DAQ6510 Reference Manual*.

Figure 9: SECONDARY swipe screen

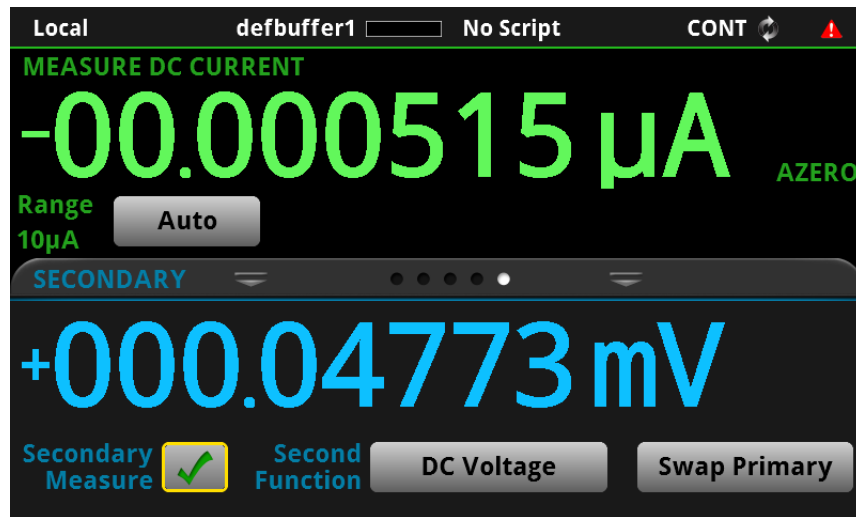

NOTE

Depending on the selected functions, a relay may click when the instrument switches between the measurement types. Leaving secondary measurements on for extended periods may shorten the life of the relays.

USER swipe screen

If you program custom text, it is displayed on the USER swipe screen. For example, you can program the DAQ6510 to show that a test is in process. Refer to "Customizing a message for the USER swipe screen" in the *DAQ6510 Reference Manual*. This swipe screen is only displayed if custom text has been displayed. Refer to "Customizing a message for the USER swipe screen" in the *Model DAQ6510 Reference Manual*.

Figure 10: USER swipe screen



GRAPH swipe screen

The GRAPH swipe screen shows a graphical representation of the readings in the presently selected reading buffer.

Figure 11: GRAPH swipe screen

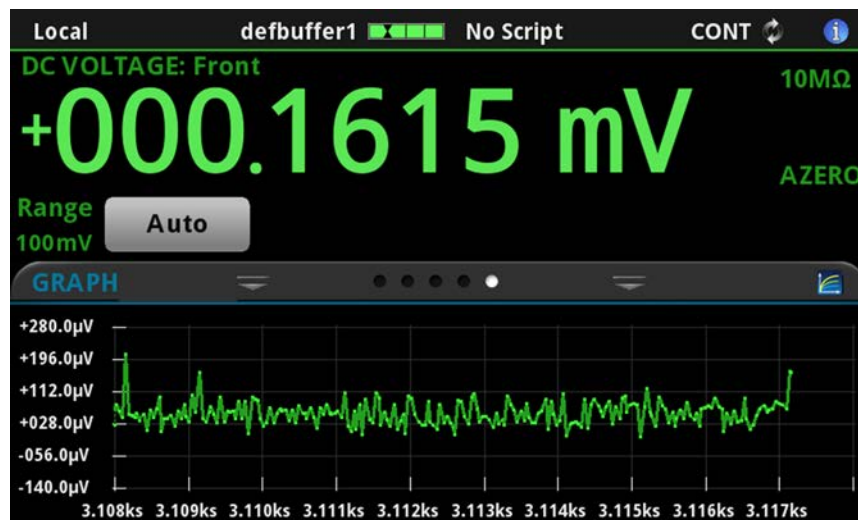

To view the graph in the full screen and to access graph settings, select the graph icon on the right side of the swipe screen header. You can also open the full-function Graph screen by pressing the **MENU** key and selecting **Graph** under Views.

For more information about graphing measurements, see "Graphing" in the *Model DAQ6510 Reference Manual*.

SCAN swipe screen

The SCAN swipe screen gives you front-panel access to build a scan, edit a scan, start a scan, step through a scan, and display scan results. You can also save the scan results to a USB flash drive.

The icon on the right side of the swipe screen heading bar is a shortcut to the Channel Scan menu. You can also use the Channel Scan menu to build or edit a scan.

For more information about viewing a scan preview and editing or running a scan, see "Channel scan menu" in the *Model DAQ6510 Reference Manual*.

NOTE

This screen is only available when the rear terminals are selected.

Figure 12: SCAN swipe screen - initial view



Figure 13: SCAN swipe screen - scan results



The scan swipe screen has the following control options:

Button	Description
Build Scan	Opens the SCAN screen, where you can set up a new scan.
Edit	Opens the SCAN screen, where you can change the setup of a scan.
Save to USB	Saves the data in the scan reading buffer to a CSV file on the USB flash drive.
Start Scan	Runs a scan.
Step Scan	Incrementally steps through a scan, channel by channel.

Menu overview

To access the main menu, press the **MENU** key on the DAQ6510 front panel. The figure below shows the organization of the main menu. The options change depending upon which set of terminals are selected, front or rear.

Figure 14: DAQ6510 main menu, front terminals selected



Figure 15: DAQ6510 main menu, rear terminals selected



The main menu includes submenus that are labeled in green across the top of the display. Selecting an option in a submenu opens an interactive screen.

Channel menu

The Channel menus allow you to set up and control channels and scans from the front panel.



The Channel **Settings** menu allows you to select and configure channels.



The Channel **Control** menu contains options to open and close channels.



The Channel **Scan** menu contains options to set up and run scans. Options include control of groups, which are channels that are sequential and have the same functions applied to them.

Measure Menu

The Measure menus allow you to select, configure, and perform measure operations from the front panel. The menu content depends upon which set of terminals is selected.

With front terminals selected:



The QuickSet menu allows you to change the function and adjust performance.



The Measure **Settings** menu contains settings for the presently selected measure function, which is identified by the function indicator in the upper right corner of the menu. The available settings depend on the front-panel **FUNCTION** key selection.

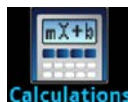

The **Calculations** menu contains settings that specify the way measurement information is processed and returned.



The **Reading Buffers** menu allows you to view the list of existing reading buffers and select one to be the active buffer. You can also create, save, delete, resize, and clear buffers from this screen.

With rear terminals selected:



The **Reading Buffers** menu allows you to view the list of existing reading buffers and select one to be the active buffer. You can also create, save, delete, resize, and clear buffers from this screen.

Views menu

The Views menus allow you to select, configure, and view data that was gathered from measure operations.



The **Graph** menu opens a screen that displays a graph of the measurements in selected reading buffers as traces. It also contains tabs that you use to customize the graph display.

You can also select the trigger mode and initiate the trigger model from this screen.



The **Histogram** menu allows you to graph the distribution of measurement data in the selected reading buffer. It also contains tabs that you use to customize the histogram.



The **Reading Table** menu allows you to view data in the selected reading buffer.

Trigger menu

The Trigger menus allow you to configure the trigger model from the front panel.



The **Templates** menu allows you to choose from one of several preprogrammed trigger models. When you select a template, settings you can specify for that template are shown in the lower part of the screen.



The **Configure** menu allows you to view and modify the structure and parameters of a trigger model. You can also monitor trigger model operation.

Scripts menu

The Scripts menus allow you to configure, run, and manage scripts from the front panel. Scripts are blocks of commands that the instrument can run as a group.



The **Run** menu contains a list of scripts that you can select to run immediately. You can also copy a script to a script that runs each time the instrument power is turned on. You can access scripts that are in the instrument or on a USB flash drive.



The **Manage** menu allows you to copy scripts to and from the instrument and the USB flash drive. You can also delete scripts from the instrument or USB flash drive.



The **Save Setup** menu allows you to save the present settings and configuration lists of the instrument into a configuration script. You can use this script to recall the settings.

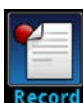

The options in the **Record** menu allow you to record your actions and store them in a macro script. The script can be run and managed like any other script using the options in the Scripts menu or remote commands. Note that only settings are stored; no key presses or front-panel only options are stored.

System menu

The menus under System in the main menu allow you to configure general instrument settings from the DAQ6510 front panel. Among these settings are the event log, communications, backlight, time, and password settings, calibration, and info/manage.



The **Event Log** menu allows you to view and clear event log entries. You can also adjust which events are displayed or logged.



The **Communication** menu opens a set of tabs that contain information about the communications settings. Most of the tabs contain settings that you can change.



The **Settings** menu contains general instrument settings. It includes beeper and key click, backlight brightness and timer, time and date, system access level, password, and reading format settings.



The **Calibration** menu allows you to start or manage auto calibration. Auto calibration removes measurement errors that are caused by the effects of temperature and time on components. You can also review factory adjustment and verification dates.



The **Info/Manage** menu gives you access to version and serial number information and settings for instrument firmware and reset functions.

Using a remote interface

In this section:

Remote communications interfaces	3-1
Supported remote interfaces	3-2
LAN communications	3-2
USB communications.....	3-5
GPIB communications.....	3-9
RS-232.....	3-12
TSP-Link	3-14
Using the web interface.....	3-15
Determining the command set you will use.....	3-18

Remote communications interfaces

You can choose from one of several communication interfaces to send commands to and receive responses from the DAQ6510.

The instrument automatically detects the type of communications interface (LAN, USB, GPIB, RS-232, or TSP-Link) when you connect to the respective port on the rear panel of the instrument. The GPIB, RS-232, and TSP-Link options require an optional accessory card. In most cases, you do not need to configure anything on the instrument. In addition, you do not need to reboot if you change the type of interface that is connected.

You can only use one communications interface to control the DAQ6510 at a time. The USB connection takes precedence over LAN connections. For other communications interfaces, the first interface on which the instrument receives a message takes control of the instrument. If another interface sends a message, that interface can take control of the instrument. You may need to enter a password to change the interface, depending on the access mode.

Supported remote interfaces

The DAQ6510 supports the following remote interfaces:

- **Ethernet:** Built-in local area network (LAN) ethernet communications.
- **USB:** Built-in USB communications port (Type B).
- **GPIB:** IEEE-488 instrumentation general purpose interface bus.
- **RS-232:** Serial communication data standard.
- **TSP-Link:** A high-speed trigger synchronization and communications bus that test system builders can use to connect multiple instruments in a master-and-subordinate configuration.

NOTE

The GPIB, RS-232, and TSP-Link interfaces require an optional communications accessory.

For details about TSP-Link, see "TSP-Link System Expansion Interface" in the *Model DAQ6510 Reference Manual*.

Figure 16: DAQ6510 remote interface connections

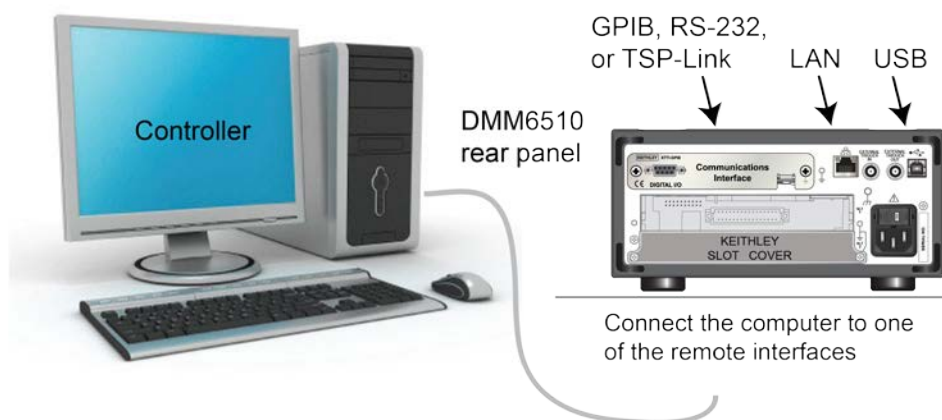

LAN communications

You can communicate with the instrument using a local area network (LAN).

When you connect using a LAN, you can use a web browser to access the internal web page of the instrument and change some of the instrument settings. For more information, see [Using the web interface](#) (on page 3-15).

The DAQ6510 is an LXI version 1.5 Core 2016 compliant instrument that supports TCP/IP and complies with IEEE Std 802.3 (ethernet LAN). There is one LAN port (located on the rear panel of the instrument) that supports full connectivity on a 10 Mbps or 100 Mbps network. The DAQ6510 automatically detects the speed.

The DAQ6510 also supports Multicast DNS (mDNS) and DNS Service Discovery (DNS-SD), which are useful on a LAN with no central administration.

NOTE

Contact your network administrator to confirm your specific network requirements before setting up a LAN connection.

If you have problems setting up the LAN, refer to [LAN troubleshooting suggestions](#) (on page 3-16).

Set up LAN communications on the instrument

This section describes how to set up manual or automatic LAN communications on the instrument.

Check communication settings

Before setting up the LAN configuration, you can check the communication settings on the instrument without making any changes.

To check communication settings on the instrument:

1. Press the **MENU** key.
2. Under System, select **Communication**. The SYSTEM COMMUNICATIONS window opens.
3. Select LAN to see the settings for that interface.
4. Press the **EXIT** key to leave the SYSTEM COMMUNICATION window without making any changes.

Set up automatic LAN configuration

If you are connecting to a LAN that has a DHCP server or if you have a direct connection between the instrument and a host computer, you can use automatic IP address selection.

If you select Auto, the instrument attempts to get an IP address from a DHCP server. If this fails, it reverts to an IP address in the range of 169.254.1.0 through 169.254.254.255.

NOTE

Both the host computer and the instrument should be set to use automatic LAN configuration. Though it is possible to have one set to manual configuration, it is more complicated to set up.

To set up automatic IP address selection using the front panel:

1. Press the **MENU** key.
2. Under System, select **Communication**.
3. Select the **LAN** tab.
4. For TCP/IP Mode, select **Auto**.
5. Select **Apply Settings** to save your settings.

Set up manual LAN configuration

If necessary, you can set the IP address on the instrument manually.

You can also enable or disable the DNS settings and assign a host name to the DNS server.

NOTE

Contact your corporate information technology (IT) department to secure a valid IP address for the instrument when placing the instrument on a corporate network.

The instrument IP address has leading zeros, but the computer IP address cannot.

To set up manual IP address selection on the instrument:

1. Press the **MENU** key.
2. Under System, select **Communication**.
3. Select the **LAN** tab.
4. For TCP/IP Mode, select **Manual**.
5. Enter the IP Address.
6. Enter the Gateway address.
7. Enter the Subnet mask.
8. Select **Apply Settings** to save your settings.

Set up LAN communications on the computer

This section describes how to set up the LAN communications on your computer.

NOTE

Do not change your IP address without consulting your system administrator. If you enter an incorrect IP address, it can prevent your computer from connecting to your corporate network or it may cause interference with another networked computer.

Record all network configurations before modifying any existing network configuration information on the network interface card. Once the network configuration settings are updated, the previous information is lost. This may cause a problem reconnecting the host computer to a corporate network, particularly if DHCP is disabled.

Be sure to return all settings to their original configuration before reconnecting the host computer to a corporate network. Contact your system administrator for more information.

Wait for the LAN status indicator to turn green

Make sure that your DAQ6510 is connected to the network by confirming that your instrument was assigned an IP address.

To verify the LAN connection:

1. Press the **MENU** key.
2. Under System, select **Communication**.
3. Select the **LAN** tab.

A green LAN status indicator on the lower left of the LAN tab confirms that your instrument was assigned an IP address.

Use the LXI Discovery Tool

To find the IP address of the DAQ6510, use the LXI Discovery Tool, a utility that is available from the Resources tab of the [LXI Consortium website](#).

USB communications

To use the rear-panel USB port, you must have the Virtual Instrument Software Architecture (VISA) layer on the host computer. See "How to install the Keithley I/O Layer" in the *Model DAQ6510 Reference Manual* for more information.

VISA contains a USB-class driver for the USB Test and Measurement Class (USBTMC) protocol that, once installed, allows the Microsoft Windows operating system to recognize the instrument.

When you connect a USB device that implements the USBTMC or USBTMC-USB488 protocol to the computer, the VISA driver automatically detects the device. Note that the VISA driver only automatically recognizes USBTMC and USBTMC-USB488 devices. It does not recognize other USB devices, such as printers, scanners, and storage devices.

In this section, "USB instruments" refers to devices that implement the USBTMC or USBTMC-USB488 protocol.

Connect a computer to the DAQ6510 using USB

To connect the DAQ6510 to a computer using a USB connection, use Keithley Instruments Model USB-B-1.

Each DAQ6510 needs its own USB cable to be connected to the computer.

To connect an instrument to a computer using USB:

1. Connect the Type A end of the cable to the computer.
2. Connect the Type B end of the cable to the instrument.
3. Turn on the instrument power. When the computer detects the new USB connection, the Found New Hardware Wizard starts.
4. If the "Can Windows connect to Windows Update to search for software?" dialog box opens, click **No**, and then click **Next**.
5. On the "USB Test and Measurement device" dialog box, click **Next**, and then click **Finish**.

Communicate with the instrument

For the instrument to communicate with the USB device, you must use NI-VISA™. VISA requires a resource string in the following format to connect to the correct USB instrument:

```
USB0::0x05e6::0x6510::[serial number]::INSTR
```

Where:

- 0x05e6: The Keithley vendor ID
- 0x6510: The instrument model number
- [serial number]: The serial number of the instrument (the serial number is also on the rear panel)
- INSTR: Use the USBTMC protocol

To determine these parameters, you can run the Keithley Configuration Panel, which automatically detects all instruments connected to the computer.

If you installed the Keithley I/O Layer, you can access the Keithley Configuration Panel through the Microsoft® Windows® Start menu.

NOTE

If you have a USB connection, you cannot switch to a LAN connection while the USB is connected. USB takes precedence over LAN.

To use the Keithley Configuration Panel to determine the VISA resource string:

1. Click **Start > Keithley Instruments > Keithley Configuration Panel**. The Select Operation dialog box is displayed.

Figure 17: Select Operation dialog box

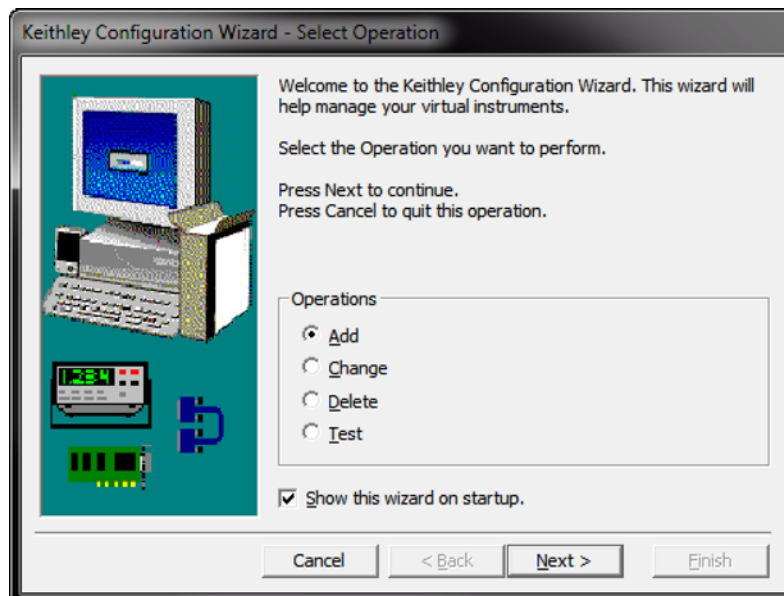

2. Select **Add**.

3. Select **Next**. The Select Communication Bus dialog box is displayed.

Figure 18: Select Communication Bus dialog box

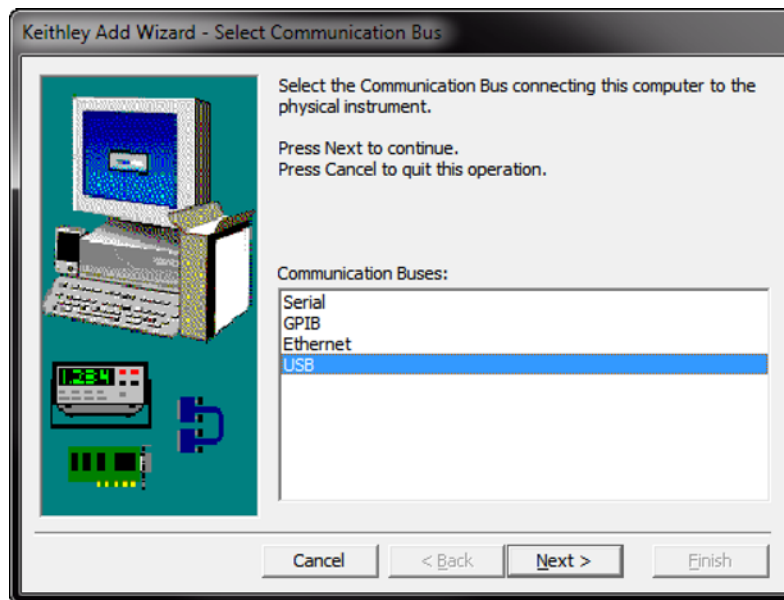

4. Select **USB**.
5. Click **Next**. The Select Instrument Driver dialog box is displayed.

Figure 19: Select Instrument Driver dialog box

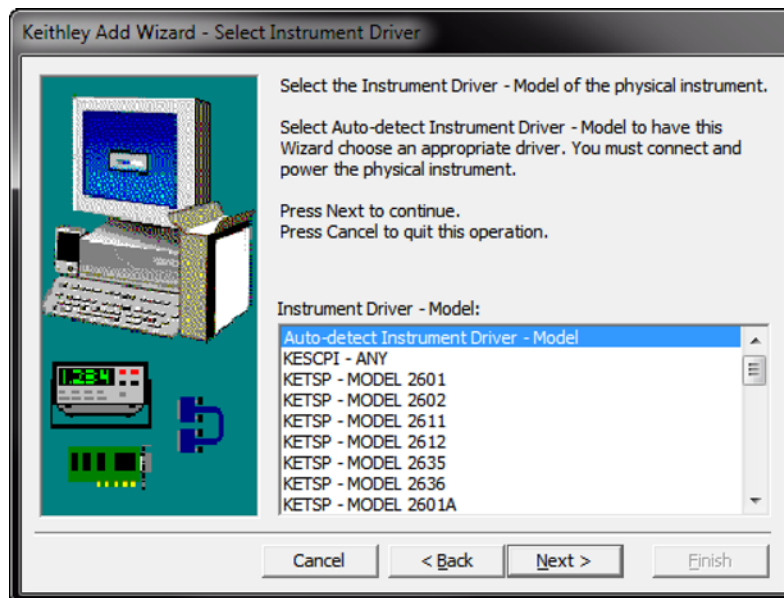

6. Select **Auto-detect Instrument Driver - Model**.
7. Click **Next**. The Configure USB Instrument dialog box is displayed with the detected instrument VISA resource string visible.
8. Click **Next**. The Name Virtual Instrument dialog box is displayed.

Figure 20: Name Virtual Instrument dialog box

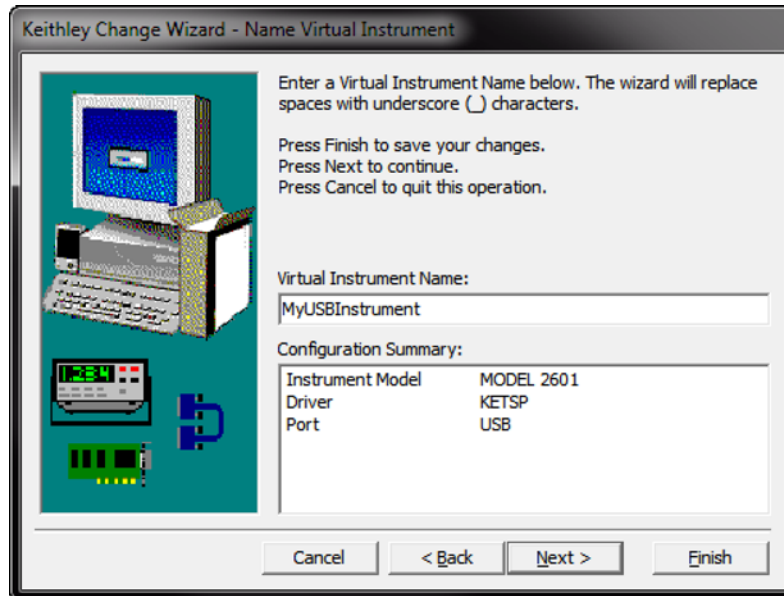

9. In the Virtual Instrument Name box, enter a name that you want to use to refer to the instrument.
10. Select **Finish**.
11. Select **Cancel** to close the Wizard.
12. Save the configuration. From the Keithley Configuration Panel, select **File > Save**.

Verify the instrument through the Keithley Communicator:

1. Click **Start > Keithley Instruments > Keithley Communicator**.
2. Select **File > Open Instrument** to open the instrument you just named.

Figure 21: Keithley Communicator Open an Instrument

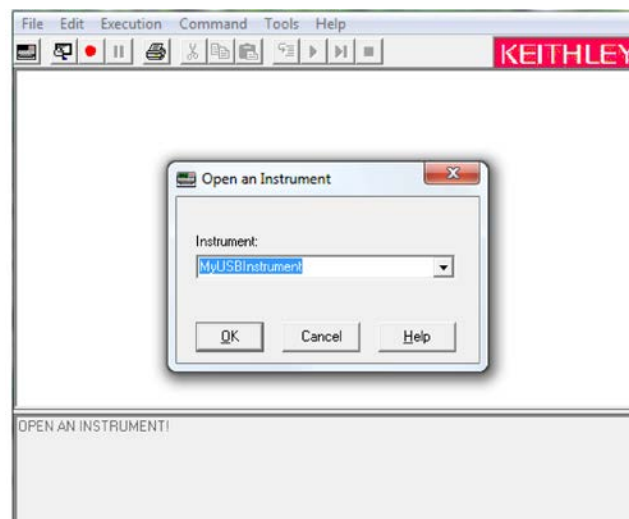

3. Click **OK**.
4. Send a command to the instrument and see if it responds.

NOTE

If you have a full version of NI-VISA on your system, you can run NI-MAX or the VISA Interactive Control utility. See the National Instruments documentation for information.

GPIB communications

The DAQ6510 GPIB interface is IEEE Std 488.1 compliant and supports IEEE Std 488.2 common commands and status model topology.

You can have up to 15 devices connected to a GPIB interface, including the controller. The maximum cable length is the lesser of either:

- The number of devices multiplied by 2 m (6.5 ft)
- 20 m (65.6 ft)

You may see erratic bus operation if you ignore these limits.

To use the GPIB interface your computer will need a GPIB card. Check the documentation for your GPIB controller for installation information and where to acquire drivers.

Install the KTTI-GPIB accessory card

Figure 22: KTTI-GPIB connector view



Unpack and inspect

Make sure to handle the KTTI-GPIB carefully. Always grasp the card by the side edges. Do not touch board surfaces, components, or areas adjacent to electrical contacts. Contamination from foreign materials such as dirt, dust, and body oils can substantially degrade card performance.

To unpack and inspect your instrument:

1. Inspect the box for damage.
2. Open the box.
3. Remove the card and inspect for any obvious signs of physical damage.
4. Report any damage to the shipping agent immediately.

Installation

⚠ WARNING

Slot covers must be installed on unused slots to prevent personal contact with high-voltage circuits. Failure to recognize and observe standard safety precautions could result in personal injury or death due to electric shock.

To install the communications card:

1. Turn the instrument off and disconnect the power line cord and any other cables connected to the rear panel.
2. Position the instrument so that you are facing the rear panel.
3. Remove the slot cover plate from the slot on the back of the instrument. Retain the plate and screws for future use.
4. Align the card with the connector toward the inside edge of the slot and slide the card into the chassis. For the last ¼ inch or so, press in firmly to mate the card to the connector.
5. On each side of the card, there is a spring-loaded mounting screw. Tighten these two screws, either by hand or with a Phillips-head screwdriver, to secure the card in the case. Do not overtighten.
6. Reconnect the power line cable and any other cables to the rear panel.
7. Turn on the instrument.

Connect GPIB cables to your instrument

To connect a DAQ6510 to the GPIB interface, use a cable equipped with standard GPIB connectors, as shown below.

Figure 23: GPIB connector

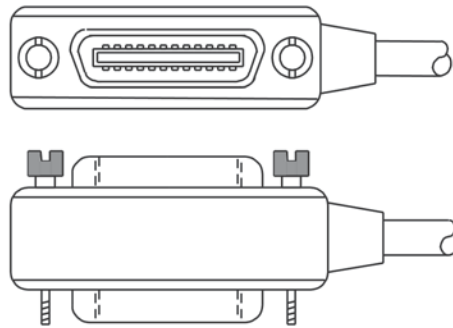

To allow many parallel connections to one instrument, stack the connectors. Each connector has two screws on it to ensure that connections remain secure. The figure below shows a typical connection diagram for a test system with multiple instruments.

CAUTION

To avoid possible mechanical damage, stack no more than three connectors on any one instrument. To minimize interference caused by electromagnetic radiation, use only shielded GPIB cables. Contact Keithley Instruments for shielded cables.

Figure 24: DAQ6510 Instrument GPIB connections

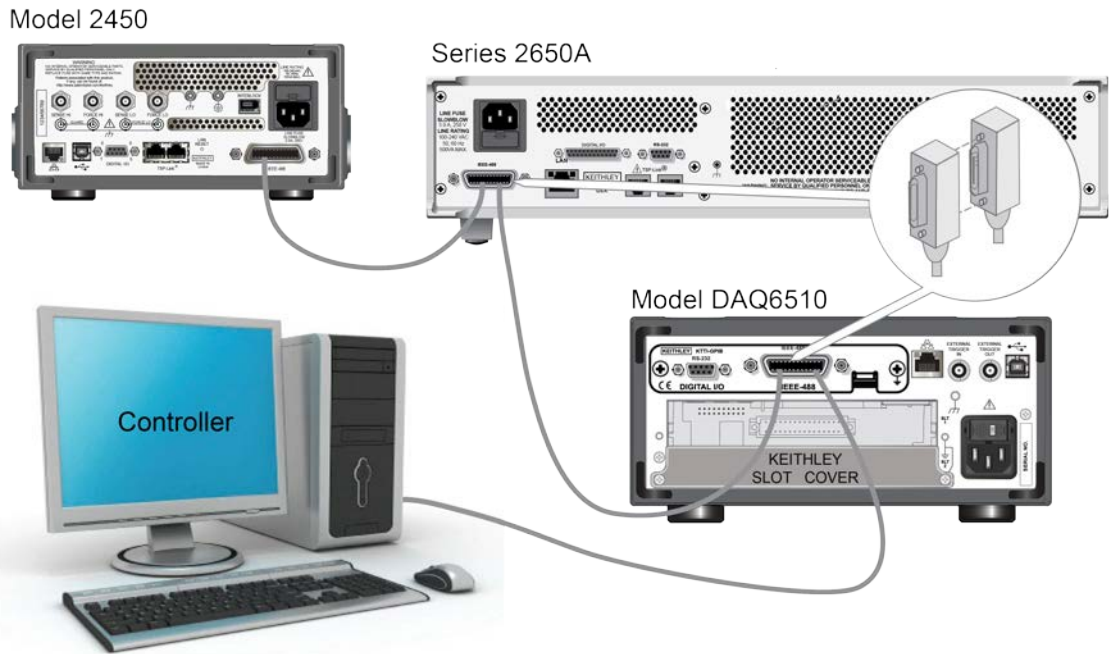

Additional information

Additional information is available in the *KTTI-GPIB Accessory Installation Sheet*.

Set the GPIB address

Set the GPIB address. The default GPIB address is 16. You can set the address from one to 30 if it is unique in the system. This address cannot conflict with an address that is assigned to another instrument or to the GPIB controller.

NOTE

GPIB controllers are usually set 0 to 21. To be safe, do not configure any instrument to have an address of 21.

The instrument saves the address in nonvolatile memory. It does not change when you send a reset command or when you turn the power off and on again.

To set the GPIB address from the front panel:

1. Press the **MENU** key.
2. Select **Communication**.
3. Select the **GPIB** tab.
4. Set the **GPIB address**.
5. Select **OK**.

NOTE

You can also set the GPIB address using remote commands. Set the GPIB address with the SCPI command `:SYSTEM:GPIB:ADDRESS` or the TSP command `gpiB.address`.

RS-232

Install the KTTI-RS232 accessory card

Unpack and inspect

Make sure to handle the KTTI-RS232 carefully. Always grasp the card by the side edges. Do not touch board surfaces, components, or areas adjacent to electrical contacts. Contamination from foreign materials such as dirt, dust, and body oils can substantially degrade card performance.

To unpack and inspect your instrument:

1. Inspect the box for damage.
2. Open the box.
3. Remove the card and inspect for any obvious signs of physical damage.
4. Report any damage to the shipping agent immediately.

Installation

WARNING

Slot covers must be installed on unused slots to prevent personal contact with high-voltage circuits. Failure to recognize and observe standard safety precautions could result in personal injury or death due to electric shock.

To install the communications card:

1. Turn the instrument off and disconnect the power line cord and any other cables connected to the rear panel.
2. Position the instrument so that you are facing the rear panel.
3. Remove the slot cover plate from the slot on the back of the instrument. Retain the plate and screws for future use.
4. Align the card with the connector toward the inside edge of the slot and slide the card into the chassis. For the last ¼ inch or so, press in firmly to mate the card to the connector.
5. On each side of the card, there is a spring-loaded mounting screw. Tighten these two screws, either by hand or with a Phillips-head screwdriver, to secure the card in the case. Do not overtighten.
6. Reconnect the power line cable and any other cables to the rear panel.
7. Turn on the instrument.

Making connections

The RS-232 serial port can be connected to the serial port of a controller using a straight-through RS232 cable terminated with DB-9 connectors. Do not use a null modem cable.

The serial port uses the transmit (TXD), receive (RXD), and signal ground (GND) lines of the RS232 standard. The figure below shows the rear panel connector for the RS232 interface. The table below shows the pinouts for the connector.

Figure 25: KTTI-RS232 panel view



Figure 26: RS-232 panel connector

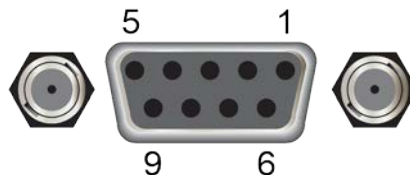

Pin	Description
1	No connection
2	TXD, transmit data
3	RXD, receive data
4	No connection
5	GND, signal ground
6	No connection
7	No connection
8	No connection
9	No connection

Additional information

Additional information is available in the KTTI-RS232 Accessory Installation Sheet.

TSP-Link

Install the KTTI-TSP accessory card

Unpack and inspect

Make sure to handle the KTTI-TSP carefully. Always grasp the card by the side edges. Do not touch board surfaces, components, or areas adjacent to electrical contacts. Contamination from foreign materials such as dirt, dust, and body oils can substantially degrade card performance.

To unpack and inspect your instrument:

1. Inspect the box for damage.
2. Open the box.
3. Remove the card and inspect for any obvious signs of physical damage.
4. Report any damage to the shipping agent immediately.

Installation

WARNING

Slot covers must be installed on unused slots to prevent personal contact with high-voltage circuits. Failure to recognize and observe standard safety precautions could result in personal injury or death due to electric shock.

To install the communications card:

1. Turn the instrument off and disconnect the power line cord and any other cables connected to the rear panel.
2. Position the instrument so that you are facing the rear panel.
3. Remove the slot cover plate from the slot on the back of the instrument. Retain the plate and screws for future use.
4. Align the card with the connector toward the inside edge of the slot and slide the card into the chassis. For the last ¼ inch or so, press in firmly to mate the card to the connector.
5. On each side of the card, there is a spring-loaded mounting screw. Tighten these two screws, either by hand or with a Phillips-head screwdriver, to secure the card in the case. Do not overtighten.
6. Reconnect the power line cable and any other cables to the rear panel.
7. Turn on the instrument.

Making connections

Connect the TSP-Link connector to one of the TSP-Link connectors on the rear panel of the instrument.

The TSP-Link expansion interface uses CAT5 and RJ-45 connectors to connect up to 32 devices.

Figure 27: KTTI-TSP panel view

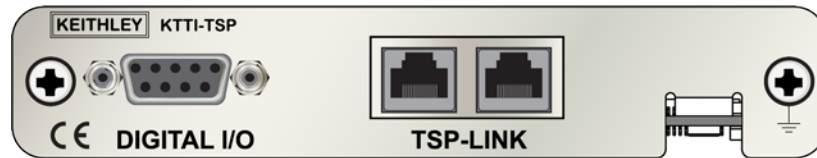

Additional information

Additional information is available in the *KTTI-TSP Accessory Installation Sheet*.

Using the web interface

The DAQ6510 web interface allows you to make settings and control your instrument through a web page. The web page includes:

- Instrument status.
- The instrument model, serial number, firmware revision, and the last LXI message.
- An ID button to help you locate the instrument.
- A virtual front panel and command interface that you can use to control the instrument.
- Download access to a CSV file that contains reading buffer data.
- Administrative options and LXI information.

The instrument web page resides in the firmware of the instrument. Changes you make through the web interface are immediately made in the instrument.

Connect to the instrument web interface

When the LAN and instrument establish a connection, you can open the web page for the instrument.

To access the web interface:

1. Open a web browser on the host computer.
2. Enter the IP address of the instrument in the address box of the web browser. For example, if the instrument IP address is 192.168.1.101, enter 192.168.1.101 in the browser address box.
3. Press **Enter** on the computer keyboard to open the instrument web page.
4. If prompted, enter a user name and password. The default is `admin` for both.

LAN troubleshooting suggestions

If you are unable to connect to the web interface of the instrument, check the following items:

- The network cable is in the LAN port on the rear panel of the instrument, not one of the TSP-Link® ports.
- The network cable is in the correct port on the computer. The LAN port of a laptop may be disabled when the laptop is in a docking station.
- The setup procedure used the configuration information for the correct ethernet card.
- The network card of the computer is enabled.
- The IP address of the instrument is compatible with the IP address on the computer.
- The subnet mask address of the instrument is the same as the subnet mask address of the computer.
- There is a USB cable attached between the instrument and your computer. USB communications take precedence over LAN.

You can also try restarting the computer and the instrument.

To restart the instrument:

1. Turn the instrument's power off, and then on.
2. Wait at least 60 seconds for the network configuration to be completed.

To set up LAN communications

1. Press the **MENU** key.
2. Under System, select **Communication**.
3. Select the **LAN** tab.
4. Verify the settings.

If the above actions do not correct the problem, contact your system administrator.

Web interface Home page

Figure 28: DAQ6510 web-interface home page

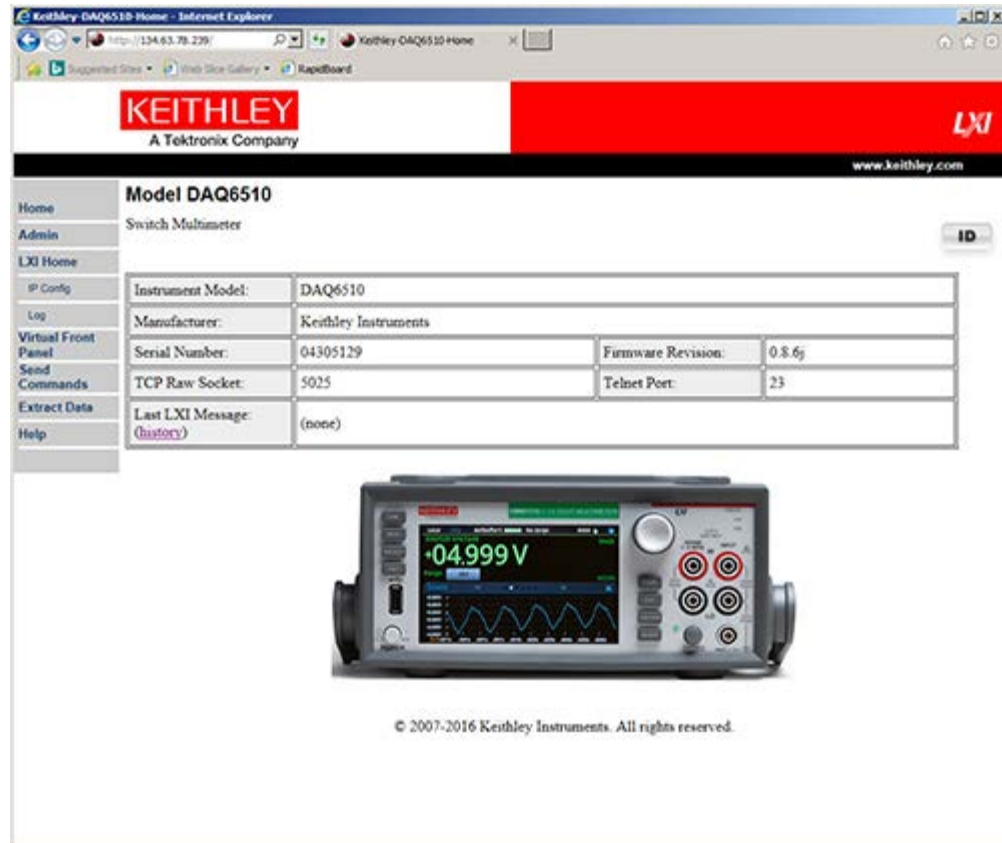

The Home page of the instrument provides information about the instrument. It includes:

- The instrument model number, manufacturer, serial number, and firmware revision number.
- The TCP Raw Socket number and Telnet Port number.
- The last LXI message. The history link opens the LXI Home page.
- The ID button, which allows you to identify the instrument. Refer to [Identify the instrument](#) (on page 3-18).

Identify the instrument

If you have a bank of instruments, you can select the ID button to determine which one you are communicating with.

Before trying to identify the instrument, make sure you have a remote connection to the instrument.

To identify the instrument:

1. On each instrument in the bank, select **MENU**, then **Communication**.
2. Select the **LAN** tab.
3. On the web interface Home or LXI Home page, select the **ID** button. The button turns green and the LXI LAN indicator on the instrument LAN tab blinks.
4. Select the **ID** button again to turn off the ID feature.

Determining the command set you will use

You can change the command set that you use with the DAQ6510. The remote command sets that are available include:

- SCPI: An instrument-specific language built on the SCPI standard.
- TSP: A scripting programming language that contains instrument-specific control commands that can be executed from a stand-alone instrument. You can use TSP to send individual commands or use it to combine commands into scripts.
- SCPI2700: An instrument-specific language that allows you to run code developed for Keithley Instruments Series 2700 instruments.
- SCPI2701: An instrument-specific language that allows you to run code developed for Keithley Instruments Series 2700 instruments.

You cannot combine the command sets.

NOTE

As delivered from Keithley Instruments, the DAQ6510 is set to work with the DAQ6510 SCPI command set.

To set the command set from the front panel:

1. Press the **MENU** key.
2. Under System, select **Settings**.
3. Select **Command Set**.

You are prompted to reboot.

To verify which command set is selected from a remote interface:

Send the command:

```
*LANG?
```

To change to the SCPI command set from a remote interface:

Send the command:

```
*LANG SCPI
```

Reboot the instrument.

To change to the TSP command set from a remote interface:

Send the command:

```
*LANG TSP
```

Reboot the instrument.

Making basic front-panel measurements

In this section:

Introduction	4-1
Equipment required for this example.....	4-1
Device connections	4-2
Basic front-panel measurements.....	4-3

Introduction

This example application makes a 2-wire resistance measurement using the front panel of the instrument.

NOTE

Set the function before making other instrument settings. Many of the settings are related to a specific measure function. The applications in this manual use the order of operations to produce the best results.

Equipment required for this example

Equipment required to perform this test:

- One DAQ6510
- Two insulated banana cables.
- One resistor to test, the example uses a resistor with a 9.75 k Ω rating

Device connections

Connect the DAQ6510 to the resistor in a 2-wire (local sense) configuration. In this configuration, the device is connected between the INPUT HI and INPUT LO terminals.

To make the connections:

1. Power off the DAQ6510.
2. Connect the test leads to the front-panel INPUT HI and INPUT LO terminals, as shown in the following figure.
3. Connect the test leads to the resistor.

Figure 29: DAQ6510 front-panel 2-wire resistance measurement

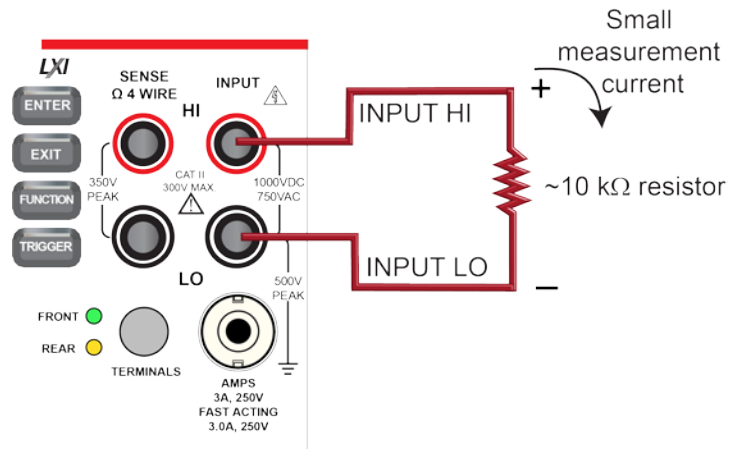

Basic front-panel measurements

The following procedures show you how to make a measurement, access settings for the measurement, and view measurement data in a reading buffer.

You can make measurements continuously or manually. When you make continuous measurements, the instrument makes measurements as quickly as possible. When you make manual measurements, the instrument makes measurements when you press the TRIGGER key.

To make a measurement from the front panel:

1. Press the **POWER** switch on the front panel to turn on the instrument.
2. Make sure the terminals switch is set to FRONT.
3. From the Functions swipe screen, select **2W Ω** . Measurements begin to display on the top half of the Home screen.
4. If measurements are not displayed, press the **TRIGGER** key for a few seconds and select **Continuous** Measurement.

To change the measure settings:

1. Press the **MENU** key.
2. Under Measure, select **Settings**.
3. Select **Display Digits**.
4. Select **3.5 Digits**.
5. Press the **HOME** key. The measurement now shows 3½ digits.

To make a single measurement:

1. Press the front-panel **TRIGGER** key for a few seconds.
2. Select **Manual Trigger Mode**.
3. Press the **TRIGGER** key to initiate a single reading using the selected measure function.

Figure 30: Basic measurement test results



The information that appears in the reading table may vary depending on the buffer you select and whether you are using the front or rear panel to make measurements.

Using the front panel to view the contents of a reading buffer:

1. Press the **MENU** key.
2. Under **Views**, select **Reading Table**. Data for the active reading buffer is displayed.

Figure 31: Reading table

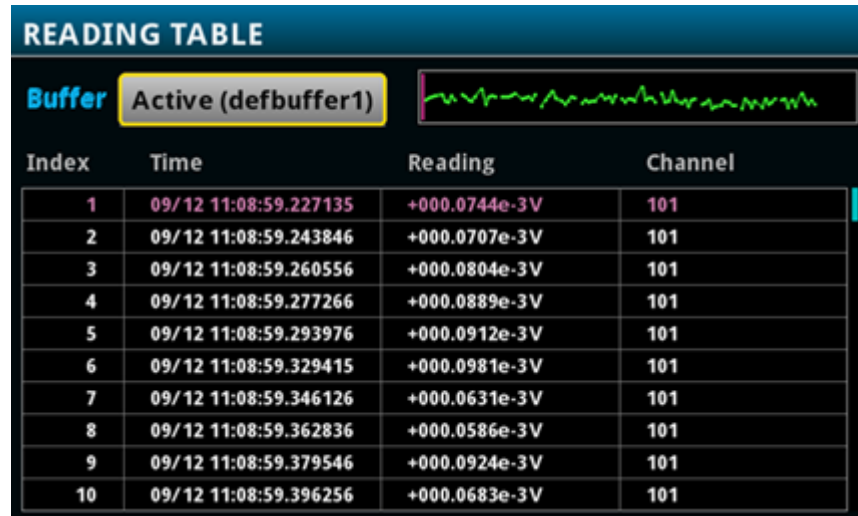

Index	Time	Reading	Channel
1	09/ 12 11:08:59.227135	+000.0744e-3V	101
2	09/ 12 11:08:59.243846	+000.0707e-3V	101
3	09/ 12 11:08:59.260556	+000.0804e-3V	101
4	09/ 12 11:08:59.277266	+000.0889e-3V	101
5	09/ 12 11:08:59.293976	+000.0912e-3V	101
6	09/ 12 11:08:59.329415	+000.0981e-3V	101
7	09/ 12 11:08:59.346126	+000.0631e-3V	101
8	09/ 12 11:08:59.362836	+000.0586e-3V	101
9	09/ 12 11:08:59.379546	+000.0924e-3V	101
10	09/ 12 11:08:59.396256	+000.0683e-3V	101

NOTE

When you are using the FRONT terminals to make measurements, the Channel column of the reading table displays "Front." If you are using the REAR terminals, the Channel column displays "Rear." If you are using a card, the Channel column displays the channel number.

3. To display data for a different reading buffer, select the buffer.
4. To view details for a specific data point, swipe the table up or down and select the data point to view the Reading Details. If there are many data points, select an area on the reading preview graph in the upper right corner of the screen to get closer to the data you want, and then scroll to the data point.
5. Press the **HOME** key to return to the Home screen.

Column	Description
Channel	Channel information.
Index	Index number of the reading.
Reading	Measurement value.
Time	Date and time showing the month, day, hour, minute, second, and fraction of a second.

Scanning temperature using thermocouples

In this section:

Introduction	5-1
Equipment required.....	5-1
Device connections	5-2
Thermocouple temperature scanning.....	5-3

Introduction

This application example demonstrates how to use the DAQ6510 to log thermocouple-based temperature measurement scans, using internal cold-junction compensation (CJC) correction, over a 24-hour period.

This type of test is typically performed when a device under test (DUT) is placed in an environmental chamber and exposed to extreme conditions. The system captures data at different locations on the DUT. The data is then exported from the DAQ6510 to a computer where a thermal profile is generated. This thermal profile provides designers and consumers with a thorough understanding of the thermal operating characteristics of their device or product.

Equipment required

- One DAQ6510
- One Model 7700 20-channel differential multiplexer module
- One computer set up for communication with the instrument
- Ten Type K thermocouples
- One USB flash drive
- One device or component to be tested

Device connections

Connecting thermocouples to the instrument

1. Power off the DAQ6510.
2. Remove the 7700 from the DAQ6510.
3. Remove the top cover from the 7700.

Figure 32: Screw terminal access

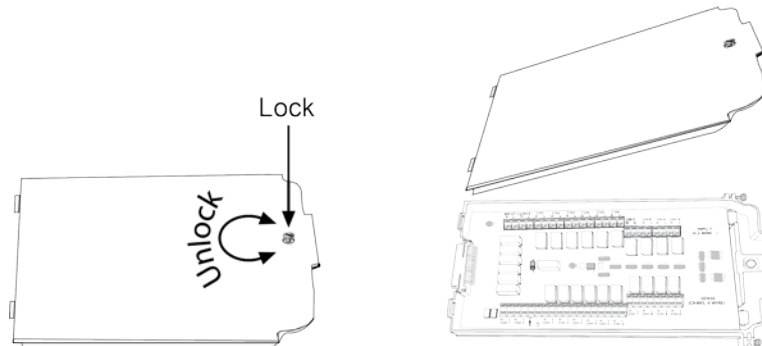

4. Connect ten Type K thermocouples to each channel as shown.

Figure 33: 7700 multiplexer module thermocouple connections

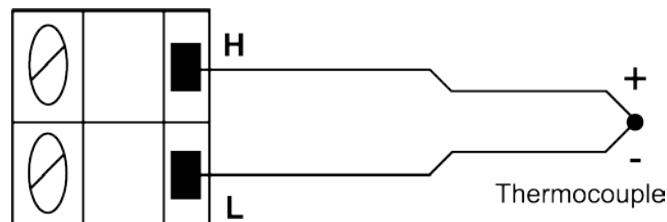

5. Route the cables out through the channels in the 7700 and secure the top cover.
6. Ensure that the DAQ6510 power is turned off.
7. Insert the 7700 into a slot on the rear of the DAQ6510.

Figure 34: DAQ6510 with 7700 multiplexer module

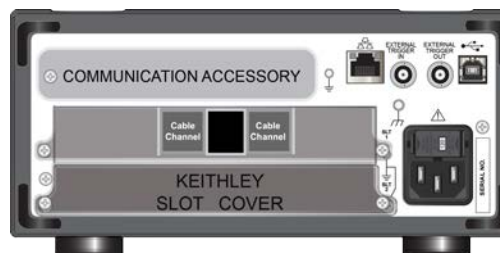

8. Press the **POWER** switch on the front panel to turn on the instrument.
9. Set the TERMINALS switch to rear.
10. Plug the USB flash drive into the port on the front of the instrument.

The remaining connections are the thermocouples to the DUT, which typically use soldering, thermal compound, polyimide tape, or conductive epoxy.

WARNING

To prevent electric shock, test connections must be configured such that the user cannot come in contact with test leads or any device under test (DUT) that is in contact with the conductors. It is good practice to disconnect DUTs from the instrument before powering the instrument. Safe installation requires proper shields, barriers, and grounding to prevent contact with test leads.

There is no internal connection between protective earth (safety ground) and the LO terminals of the DAQ6510. Therefore, hazardous voltages (more than 30 V_{RMS}) can appear on LO terminals. This can occur when the instrument is operating in any mode. To prevent hazardous voltage from appearing on the LO terminals, connect the LO terminal to protective earth (safety ground) if your application allows it. You can connect the LO terminal to the chassis ground terminal on the front panel or the chassis ground screw terminal on the rear panel. Note that the front-panel terminals are isolated from the rear-panel terminals. Therefore, if you are using the front-panel terminals, ground to the front-panel LO terminal. If using the rear-panel terminals, ground to the rear panel LO terminal. Failure to follow these guidelines can result in injury, death, or instrument damage.

Thermocouple temperature scanning

This application demonstrates how to use the DAQ6510 to measure temperature at ten different points on a DUT every minute over a 24-hour period. During this test, all scan data is automatically written to a USB flash drive connected to the port on the instrument.

For this application, you will:

- Configure the instrument for ten channels of Type K thermocouple measurement using internal cold junction correction (CJC).
- Enable detection of open leads and offset compensation for more accurate readings.
- Configure the instrument to scan all channels (1 to 10) once a minute for 24 hours.
- Automatically export the data to a USB flash drive for each completed scan.
- Enable the auto-restart feature to ensure the continuation of progress in the event of power failure.
- Check the status of the scan progress as it is running.
- Pause the scan and move the data to a computer to begin analysis, prior to scan completion.
- Analyze graphical data of the scan in progress.
- Learn how to program the instrument through the front panel user interface.
- Learn how to program the instrument using a remote communications interface with SCPI and TSP code commands.

Using the front panel

To set up the application from the front panel:

1. Press the **POWER** switch on the front panel to turn on the instrument.
2. Press the **MENU** key.
3. Under Channel, select **Scan**.
4. Select the **+** button to add a group of channels (101 to 110), and select **OK**.
5. Select **Temperature** on the Measure Functions screen.
6. Select Thermocouple, select **K**.
7. Scroll down and set the Reference Junction to **Internal**.
8. Select the Scan tab, set the Scan Count to 1440, and select **OK**. (One scan every minute for 24 hours = 24 hours * 60 minutes = 1440).
9. Set the Interval Between Scans to **60 s** and select **OK**.
10. Scroll down on the Scan tab to Export to a USB flash drive. Choose **After Each Scan** from the list of options.
11. Select Filename, enter **scan24hr**, and select **OK** to accept.
12. Select **OK** to accept the remaining File Content settings.
13. Select **Power Loss Restart** and select **On**.
14. You can now start your scan in one of two ways:
 - a. Select the **Start** icon on the SCAN screen.
 - b. Press the **TRIGGER** key and select a measurement state. Choose **Initiate Scan** to start the scan.
15. Select **View Scan Status** to go to the SCAN swipe on the HOME screen.

Using SCPI commands

This sequence of SCPI commands makes a thermocouple-based temperature scan.

You may need to make changes so that this code will run in your programming environment.

Send the following commands for this example application:

Commands	Descriptions
<pre>*RST :FUNction 'TEMPerature',(@101:110) :SENSe:TEMPerature:TRANsducer TCouple, (@101:110) :SENSe:TEMPerature:TCouple:TYPE K, (@101:110) :SENSe:TEMPerature:TCouple:RJUNction: RSElect INTernal, (@101:110) :SENSe:TEMPerature:ODETector ON, (@101:110) :ROUte:SCAN:CREate (@101:110) :ROUte:SCAN:COUnT:SCAN 1440 :ROUte:SCAN:INTerval 60.0 :ROUte:SCAN:EXPort "/usb1/scan24hr.csv", SCAN, ALL :ROUte:SCAN:REStart ON :INIT :DISPlay:SCReen SWIPE_SCAN</pre>	<ul style="list-style-type: none"> ■ Reset the DAQ6510 ■ Set up channel settings for Slot 1 ■ Set up Scan ■ Set the scan count to 24 hrs * 60 min/hr = 1440 ■ Set the time between scans to 60 s ■ Ensure data gets written to a USB drive after each scan ■ Enable scan restart after power failure ■ Trigger to start scan ■ Sends user to the SCAN swipe screen

Using TSP commands

NOTE

The following TSP code is designed to be run from Keithley Instruments Test Script Builder (TSB). TSB is a software tool that is available from tek.com/keithley. You can install and use TSB to write code and develop scripts for TSP-enabled instruments. Information about how to use TSB is in the online help for TSB and in the "Introduction to TSP operation" section of the *Model DAQ6510 Reference Manual*.

To use other programming environments, you may need to make changes to the example TSP code.

By default, the DAQ6510 uses the SCPI command set. You must select the TSP command set before sending TSP commands to the instrument.

To enable TSP commands:

1. Press the **MENU** key.
2. Under System, select **Settings**.
3. Set the Command Set to **TSP**.
4. At the prompt to reboot, select **Yes**.

This sequence of TSP commands makes a series of temperature measurements. After the code executes, the data is displayed in the Instrument Console of Test Script Builder.

Send the following commands for this example application:

```
-- Reset the instrument to the default settings
reset()
-- Set up channel settings for Slot 1
channel.setdmm("101:110", dmm.ATTR_MEAS_FUNCTION, dmm.FUNC_TEMPERATURE)
channel.setdmm("101:110", dmm.ATTR_MEAS_TRANSDUCER, dmm.TRANS_THERMOCOUPLE)
channel.setdmm("101:110", dmm.ATTR_MEAS_THERMOCOUPLE, dmm.THERMOCOUPLE_K)
channel.setdmm("101:110", dmm.ATTR_MEAS_REF_JUNCTION, dmm.REFJUNCT_INTERNAL)
channel.setdmm("101:110", dmm.ATTR_MEAS_OPEN_DETECTOR, dmm.ON)
-- set up Scan
scan.create("101:110")
-- Set the scan count to 24hrs * 60min/hr = 1440
scan.scancount = 1440
-- Set the time between scans to 60s
scan.scaninterval = 6.000e+01
-- Ensure data gets written to a connected USB drive after each scan
scan.export("/usb1/scan24hr.csv", scan.WRITE_AFTER_SCAN, buffer.SAVE_RELATIVE_TIME)
-- Enable scan restart after power failure
scan.restart = scan.ON
-- Trigger to start the scan...
trigger.model.initiate()
-- Ensure that the display shows the SCAN swipe and carousel
display.changescreen(display.SCREEN_SCAN_SWIPE)
```

Test results

The following figures show sample results and final test measurements for this application.

1. The horizontal progress bar is completely green when the connections at the screw terminals and at the DUT are secure. The SCAN swipe screen provides the time remaining (in seconds) and the scan countdown.

Figure 35: DAQ6510 scan start screen



2. If you have data on the USB flash drive and want to review it prior to completion, pause the scan, remove the drive, copy the data file to your PC, return the drive to the DAQ6510, and resume the scan.

Figure 36: Temperature scan results

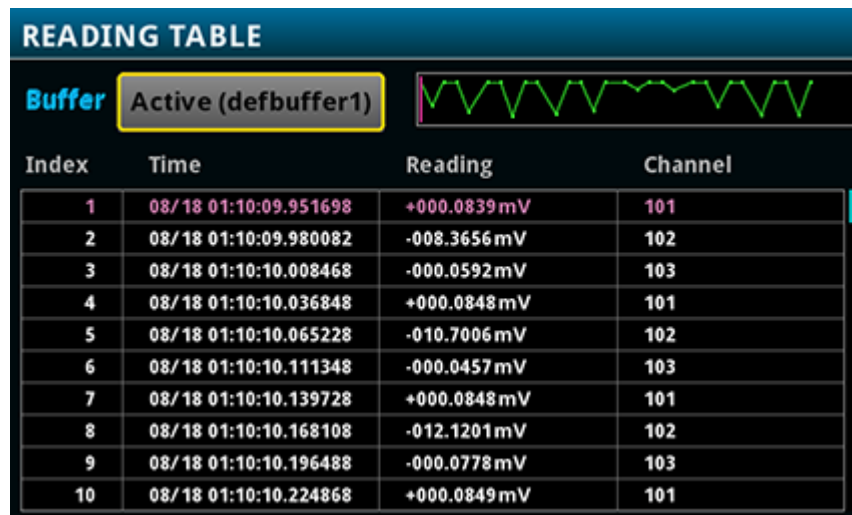

- Once the scan is complete, the SCAN swipe screen provides you with additional options. You can select different tabs that provide graphical data analysis options. The following figure shows a sample graph for this application.

Figure 37: DAQ6510 graph UI four views.png

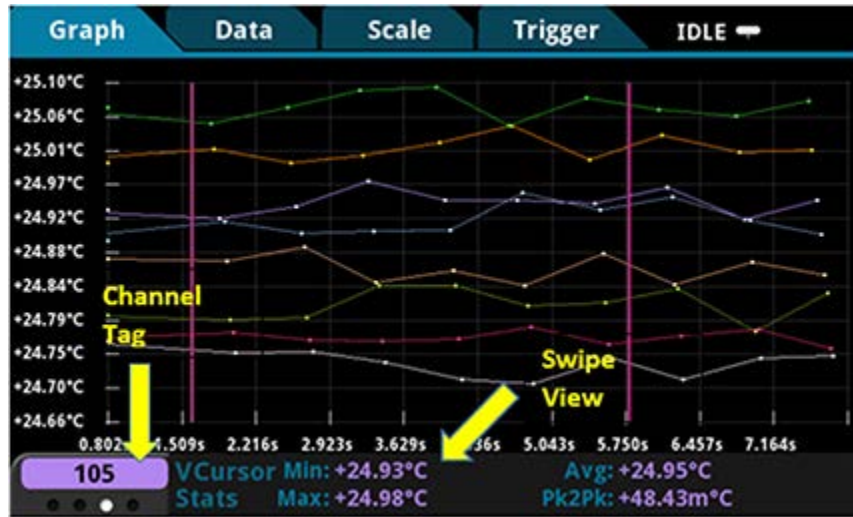

Scanning low-level DCV

In this section:

Introduction	6-1
Equipment required.....	6-1
Device connections	6-2
Scanning low-level DCV.....	6-3

Introduction

This application example demonstrates how to use the DAQ6510 to accurately measure DC voltage in a variety of ranges. To ensure accurate data, the NPLC (Number of Power Line Cycles) and autozero options are used for this test.

The NPLC setting can be used to help reduce the induced noise originating from nearby AC power-conditioning circuits. A desktop power supply or power-transmission lines would generate this type of noise. Increasing NPLC cancels out this noise by integrating all sampled data collected in multiples of AC signal periods ($n * 1/(\text{transmission line frequency})$ seconds). The more AC line cycles used in the measurement, the more accurate the reading. The time required to conduct the scan also increases.

The autozero function removes offset voltages that result from thermal EMFs. Thermal EMFs occur when there is a temperature difference at junctions consisting of different materials. For example, leads, instrument inputs, or card terminals. These EMFs adversely affect DCV measurement accuracy by offsetting the measured voltage.

This example shows how to measure voltage in different ranges. To optimize scanning speed, you should set a fixed range. If speed is not an issue, the measurement range can be set to auto.

Equipment required

- One DAQ6510
- One Model 7700 20-channel differential multiplexer module
- One computer set up for communication with the instrument
- One device or component to be tested

Device connections

This example uses a DAQ6510 with a 7700 multiplexer module. In this example, channels 101 to 106 are connected to six DUTs (device under test) where DC voltage is measured.

Figure 38: DAQ6510 instrument and devices connections for low-level DCV

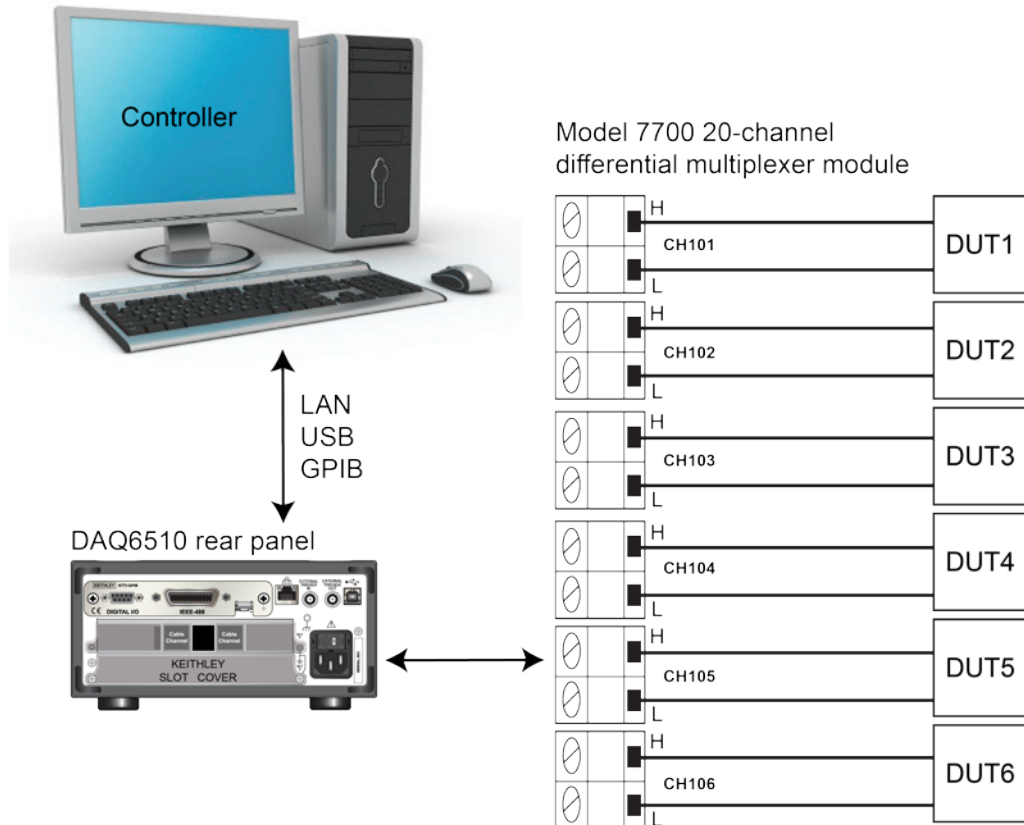

Connecting devices to the instrument

1. Power off the DAQ6510.
2. Remove the 7700 from the DAQ6510.
3. Remove the top cover from the 7700.

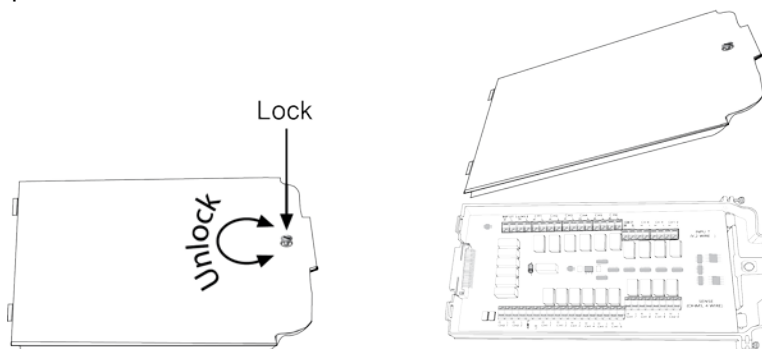

4. Connect six devices.
5. Route the cables out through the cable channels and secure the top cover.
6. Ensure that the DAQ6510 power is turned off.
7. Insert the 7700 into a slot on the rear of the DAQ6510.

Figure 39: DAQ6510 with 7700 multiplexer module

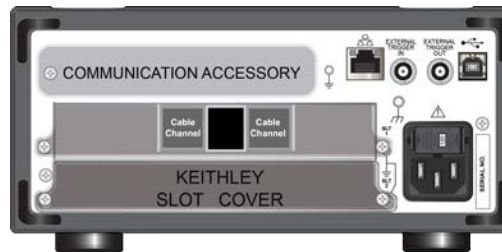

8. Press the **POWER** switch on the front panel to turn on the instrument.
9. Set the **TERMINALS** switch to rear.

The remaining connections are to the DUT and are at your discretion.

⚠ WARNING

To prevent electric shock, test connections must be configured such that the user cannot come in contact with test leads or any device under test (DUT) that is in contact with the conductors. It is good practice to disconnect DUTs from the instrument before powering the instrument. Safe installation requires proper shields, barriers, and grounding to prevent contact with test leads.

There is no internal connection between protective earth (safety ground) and the LO terminals of the DAQ6510. Therefore, hazardous voltages (more than $30 V_{RMS}$) can appear on LO terminals. This can occur when the instrument is operating in any mode. To prevent hazardous voltage from appearing on the LO terminals, connect the LO terminal to protective earth (safety ground) if your application allows it. You can connect the LO terminal to the chassis ground terminal on the front panel or the chassis ground screw terminal on the rear panel. Note that the front-panel terminals are isolated from the rear-panel terminals. Therefore, if you are using the front-panel terminals, ground to the front-panel LO terminal. If using the rear-panel terminals, ground to the rear panel LO terminal. Failure to follow these guidelines can result in injury, death, or instrument damage.

Scanning low-level DCV

This application demonstrates how to use the DAQ6510 to perform DC voltage measurement using multiple channels on the 7700 20-channel differential multiplexer module.

For this application, you will:

- Configure channels 101 to 106 for DC voltage measurement.
- Enable autoranging and autozero on each channel.
- Set NPLC to five on each channel.
- Execute 10 scans on all selected channels.

You can program the unit through the front panel or use the remote communications interface of your choosing (LAN, USB, GPIB, RS-232, or TSP-Link) via the SCPI and TSP code commands.

Using the front panel

To set up the application from the front panel:

1. Press the **POWER** switch on the front panel to turn on the instrument.
2. Select the **REAR** terminals.
3. Press the **MENU** key.
4. Under Channel, select **Scan**.
5. Select the **+** button to add a group of channels, select channels 101 to 106, and select **OK**.
6. Select **DC Voltage**.
7. On the Settings tab, set NPLC to **5**.
8. Set Auto Zero to **On**.
9. On the Scan tab, set Scan Count to **10**.
10. Select **Start** at the bottom of the left pane.

To watch active readings during scan:

1. Press the **HOME** key.
2. Select the arrow to the right of **Watch Channel**.
3. Select the channels of interest and select **OK** to accept.

To save the scanned measurements to a USB flash drive:

1. Select the **MENU** key.
2. Under the **Measure** column, choose **Reading Buffers**.
3. Insert a USB flash drive into the DAQ6510. Select **Save to USB** at the bottom of the pane.
4. Select **OK**.

Using SCPI commands

This sequence of SCPI commands executes a DCV scan on channels 101 to 106.

You may need to make changes so that this code will run in your programming environment. In the table, the SCPI commands have a light gray background. The light green shaded code represents pseudocode that will vary depending on the programming environments you use.

Send the following commands for this example application:

	Commands	Descriptions
Pseudocode	<pre>int scanCount = 10 int channelCount = 6 int bufferSize = scanCount * channelCount int lastIndex string tmpBuff</pre>	<ul style="list-style-type: none"> ■ Create a variable to hold the scan count ■ Create a variable to hold channel count ■ The number of readings ■ The last scan index in the buffer after every two seconds ■ A temporary buffer that store scanned data every two seconds
DAQ6510	<pre>*RST :TRAC:POIN bufferSize, "defbuffer1" :ROUT:SCAN:BUFF "defbuffer1" FUNC 'VOLT:DC', (@101:106) VOLT:DC:RANG:AUTO ON, (@101:106) VOLT:DC:NPLC 5, (@101:106) VOLT:DC:AZER ON, (@101:106) ROUT:SCAN (@101:106) ROUT:SCAN:COUN:SCAN 10 INIT</pre>	<ul style="list-style-type: none"> ■ Put the instrument in a known state ■ Set the buffer size (not necessary when using the default buffer, but added to show command use case) ■ Assign all scanned data to "defbuffer1" ■ Set channels functions to DCV ■ Set the channels ranges to auto ■ Set NPLC to 5 ■ Set autozero function to ON ■ Setup the scan list ■ Setup the number of repeated scans ■ Initiate the scan
Pseudocode	<pre>for i = 1; i <= bufferSize; delay 2000</pre>	<ul style="list-style-type: none"> ■ Delay two seconds to allow readings to accumulate
DAQ6510	<pre>lastIndex = TRACe:ACTual? tmpBuff = "TRACe:DATA? i, lastIndex, "defbuffer1", READ</pre>	<ul style="list-style-type: none"> ■ Query the current buffer index ■ Query the readings available from index i to index lastIndex
Pseudocode	<pre>printBuffer (tmpBuffer) i = lastIndex + 1 end for</pre>	<ul style="list-style-type: none"> ■ Print readings in temporary buffer to console
DAQ6510	<pre>:TRAC:SAVE "/usb1/MyData.csv", "defbuffer1"</pre>	<ul style="list-style-type: none"> ■ Save buffer data from defbuffer1 to USB

Using TSP commands

NOTE

The following TSP code is designed to be run from Keithley Instruments Test Script Builder (TSB). TSB is a software tool that is available from tek.com/keithley. You can install and use TSB to write code and develop scripts for TSP-enabled instruments. Information about how to use TSB is in the online help for TSB and in the "Introduction to TSP operation" section of the *Model DAQ6510 Reference Manual*.

To use other programming environments, you may need to make changes to the example TSP code.

By default, the DAQ6510 uses the SCPI command set. You must select the TSP command set before sending TSP commands to the instrument.

To enable TSP commands:

1. Press the **MENU** key.
2. Under System, select **Settings**.
3. Set the Command Set to **TSP**.
4. At the prompt to reboot, select **Yes**.

This sequence of TSP commands initiates a series of temperature measurements. After the code executes, the data is displayed in the Instrument Console of Test Script Builder.

Send the following commands for this example application:

```
-- Reset the instrument to the default settings
reset()
channelCount = 6
scanCount = 10
bufferSize = channelCount * scanCount
defbuffer1.capacity = bufferSize
scan.buffer = defbuffer1 -- not necessary when using the default buffer, but added
    to show command use case.
-- set up channels
channel.setdmm("101:106", dmm.ATTR_MEAS_FUNCTION, dmm.FUNC_DC_VOLTAGE,
    dmm.ATTR_MEAS_RANGE_AUTO, dmm.ON, dmm.ATTR_MEAS_AUTO_ZERO, dmm.ON,
    dmm.ATTR_MEAS_NPLC, 5)
-- set up Scan
scan.add("101:106")
scan.scancount = scanCount
-- set up trigger model
trigger.model.initiate()
-- print measurement data to console
i = 1
while i <= bufferSize do
    delay(2)
    lastIndex = defbuffer1.n
    printbuffer(i, lastIndex, defbuffer1.readings)
    i = lastIndex + 1
end
-- save buffer data from defbuffer1 to USB
buffer.save(defbuffer1, "/usb1/MyData.csv")
```

Scanning resistors using 4W measurement

In this section:

Introduction	7-1
Equipment required.....	7-2
Device connections	7-3
Scanning resistors using 4-wire measurements.....	7-5

Introduction

This example application demonstrates how to use the DAQ6510 to accurately measure resistance across multiple devices. To obtain the best results, the 4-wire (Kelvin) measurement method and offset compensation are used for this test.

Typical resistance measurements made using the 2-wire method source current through the test leads and the device under test (DUT). The voltage is measured, and the resistance is calculated.

It is difficult to obtain accurate 2-wire resistance measurements when the DUT is lower than 100 Ω . Typical lead resistances lie in the range of 1 m Ω to 10 m Ω . When the 2-wire method is applied to low-resistance measurements, there is a small but significant voltage drop across the resistance of each test lead. The voltage measured by the instrument is not the same as the voltage directly across the DUT.

The 4-wire method is preferred for low-resistance measurements. With this configuration, the test current is sourced through the DUT using one set of test leads, while a second set of SENSE leads measures the voltage across the DUT. The voltage-sensing leads are connected as close to the device under test as possible to avoid including the resistance of the test leads in the measurement.

Thermoelectric voltages (EMFs) can seriously affect low-resistance measurement accuracy. The DAQ6510 can apply the offset-compensated ohms method (OCOMP), which makes one normal resistance measurement and one using the lowest current source setting to eliminate EMFs.

For this example, you will use resistors of different low values across multiple channels of a 7700 multiplexer module and examine how the 4-wire measurement method provides a more accurate reading than the 2-wire method. Fixed measurement ranges are applied in order to optimize scanning speed and OCOMP is applied to correct for any EMF effects.

NOTE

For comprehensive information on 4-wire resistance measurements, thermoelectric EMFs, and offset compensation methods, see the *Low Level Measurements Handbook*, available on tek.com/keithley.

Equipment required

- One DAQ6510
- One Model 7700 20-channel differential multiplexer module
- One computer set up for communication with the instrument
- Six resistors of 100 Ω , 68 Ω , 10 Ω , 2.2 Ω , 0.5 Ω , and 0.2 Ω
- One device or component to be tested

Device connections

This example application uses the DAQ6510 to perform a 4-wire measurement using multiple channels on a 7700 multiplexer module.

For this example you will:

- Configure channels 101, 102, 103, 104, 105, and 106 to measure resistors (in this case, 100 Ω, 68 Ω, 10 Ω, 2.2 Ω, 0.5 Ω, and 0.2 Ω).
- Pair channels 111 to 116 with channels 101 to 106, respectively, to provide the SENSE connections needed for 4-wire measurement.
- Select fixed ranges and apply offset compensation to each channel.
- Execute 100 scans for all selected channels.

Figure 40: Schematic of 4W measurement

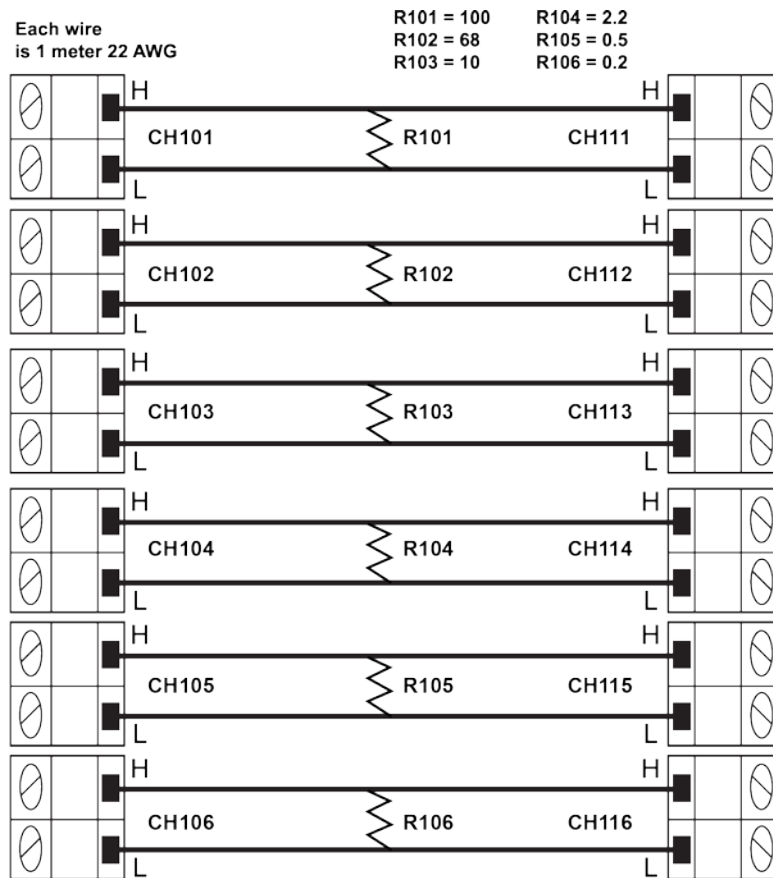

NOTE

To highlight the impact of test lead resistance on low-resistance measurements, and how the correction methods improve readings, the connections to each DUT consist of one meter of 22 AWG wire.

WARNING

To prevent electric shock, test connections must be configured such that the user cannot come in contact with test leads or any device under test (DUT) that is in contact with the conductors. It is good practice to disconnect DUTs from the instrument before powering the instrument. Safe installation requires proper shields, barriers, and grounding to prevent contact with test leads.

There is no internal connection between protective earth (safety ground) and the LO terminals of the DAQ6510. Therefore, hazardous voltages (more than 30 V_{rms}) can appear on LO terminals. This can occur when the instrument is operating in any mode. To prevent hazardous voltage from appearing on the LO terminals, connect the LO terminal to protective earth (safety ground) if your application allows it. You can connect the LO terminal to the chassis ground terminal on the front panel or the chassis ground screw terminal on the rear panel. Note that the front-panel terminals are isolated from the rear-panel terminals. Therefore, if you are using the front-panel terminals, ground to the front-panel LO terminal. If using the rear-panel terminals, ground to the rear panel LO terminal. Failure to follow these guidelines can result in injury, death, or instrument damage.

Scanning resistors using 4-wire measurements

Using the front panel

To setup the application from the front panel:

1. Press the **POWER** switch on the front panel to turn on the instrument.
2. Set the **TERMINALS** switch to REAR.
3. Press the **MENU** key.
4. Under Channel, select **Scan**.
5. Select the **+** button to add groups of channels (101 to 106) and select **OK**.
6. Select **4W Resistance** on the Measure Functions screen.
7. Select **Offset Compensation**, select **On**.
8. In the upper left corner of the screen, select the Menu icon to reveal options, select **Expand Group**. The left side of the pane allows you to modify the range on each channel.
9. Select channel 101 by selecting **4-Wire Res**.
10. Under the Settings tab, select Range and set to **100 W**.
11. Select channel 102 by selecting **4-Wire Res** and set the Range to **100 W**.
12. Select channel 103 by selecting **4-Wire Res** and set the Range to **10 W**.
13. Select channel 104 by selecting **4-Wire Res** and set the Range to **10 W**.
14. Select channel 105 by selecting **4-Wire Res** and set the Range to **1 W**.
15. Select channel 106 by selecting **4-Wire Res** and set the Range to **1 W**.
16. Locate the Scan tab, and set the Scan Count to **100**.
17. Select the **Start** button at the bottom of the left-side pane to start the scan.

You can monitor active readings during the scan or review all scanned data after the scan finishes.

To watch active readings during scan:

1. Press the **HOME** key.
2. Select the button to the right of **Watch Channel**.
3. Select the channels of interest and select **OK** to accept.

To review all the data after the scan finishes:

1. Press the **MENU** key.
2. Under the Views column, choose **Reading Table**.

Using SCPI commands

This sequence of SCPI commands executes a 4-wire resistance scan.

You may need to make changes so that this code will run in your programming environment.

Send the following commands for this example application:

Commands	Descriptions
*RST	<ul style="list-style-type: none"> ▪ Reset the DAQ6510
ROUT:SCAN:COUN:SCAN scanCnt	<ul style="list-style-type: none"> ▪ Set the number of times the scan is repeated
FUNC 'FRES', (@101:106)	<ul style="list-style-type: none"> ▪ Set function to 4-wire measurement
FRES:OCOM ON, (@101:106)	<ul style="list-style-type: none"> ▪ Set offset compensation to "on"
FRES:RANG 100, (@101,102)	<ul style="list-style-type: none"> ▪ Set the fixed range at 100 Ω
FRES:RANG 10, (@103,104)	<ul style="list-style-type: none"> ▪ Set the fixed range at 10 Ω
FRES:RANG 1, (@105,106)	<ul style="list-style-type: none"> ▪ Set the fixed range at 1 Ω
ROUT:SCAN:CRE (@101:106)	<ul style="list-style-type: none"> ▪ Set the scan list
TRAC:CLE	<ul style="list-style-type: none"> ▪ Clear the reading buffer
INIT	<ul style="list-style-type: none"> ▪ Initiate the scan
*WAI	<ul style="list-style-type: none"> ▪ Wait for scan completion

Using TSP commands

NOTE

The following TSP code is designed to be run from Keithley Instruments Test Script Builder (TSB). TSB is a software tool that is available from tek.com/keithley. You can install and use TSB to write code and develop scripts for TSP-enabled instruments. Information about how to use TSB is in the online help for TSB and in the "Introduction to TSP operation" section of the *Model DAQ6510 Reference Manual*.

To use other programming environments, you may need to make changes to the example TSP code.

By default, the DAQ6510 uses the SCPI command set. You must select the TSP command set before sending TSP commands to the instrument.

To enable TSP commands:

1. Press the **MENU** key.
2. Under System, select **Settings**.
3. Set the Command Set to **TSP**.
4. At the prompt to reboot, select **Yes**.

This sequence of TSP commands initiates a series of temperature measurements. After the code executes, the data is displayed in the Instrument Console of Test Script Builder.

After the scan, the data in the buffer is stored on a USB flash drive.

Send the following commands for this example application:

```
-- Reset the instrument to the default settings
reset()
scanCount = 100
-- set up each channels function, range and offset compensation
channel.setdmm("101, 102", dmm.ATTR_MEAS_FUNCTION, dmm.FUNC_4W_RESISTANCE,
  dmm.ATTR_MEAS_RANGE, 100, dmm.ATTR_MEAS_OFFCOMP_ENABLE, dmm.OCOMP_ON)
channel.setdmm("103, 104", dmm.ATTR_MEAS_FUNCTION, dmm.FUNC_4W_RESISTANCE,
  dmm.ATTR_MEAS_RANGE, 10, dmm.ATTR_MEAS_OFFCOMP_ENABLE, dmm.OCOMP_ON)
channel.setdmm("105, 106", dmm.ATTR_MEAS_FUNCTION, dmm.FUNC_4W_RESISTANCE,
  dmm.ATTR_MEAS_RANGE, 1, dmm.ATTR_MEAS_OFFCOMP_ENABLE, dmm.OCOMP_ON)
-- set up Scan
scan.add("101,102,103,104,105,106")
scan.scancount = 100
-- set up trigger model
trigger.model.initiate()
-- wait till scan completes
waitcomplete()
```

Test results

The table below compares the values of scanned DUTs using 4-wire and 2-wire measurement methods with the six resistors listed in the Instrument and Device Connection section.

NOTE

The data provided in each cell of the table is the average of 100 scans.

Nominal value (Ω)	Four-wire measurement with offset compensation (Ω)	Four-wire measurement with NO offset compensation (Ω)	Two-wire measurement (Ω)
100	98.3242	98.3206	98.5831
68	67.9920	68.0080	67.2703
10	10.00998	10.00141	10.28680
2.2	2.20413	2.20588	2.51011
0.5	0.555823	0.559395	0.84131
0.2	0.221831	0.221796	0.53091

Mixed function multi-channel scanning

In this section:

Introduction	8-1
Equipment required.....	8-1
Device connections	8-2
Mixed function multi-channel scanning	8-3

Introduction

This example application demonstrates how to use the DAQ6510 to perform complex multi-channel, mixed function scanning in a production-test environment.

The DAQ6510 can perform more than one function in a multichannel scan, providing a range of data-acquisition options in a single test.

In this production environment the DAQ6510 is:

- Integrated into a test stand.
- Wired to a fixture that is connected to an active device under test (DUT).
- Quickly capturing DC volts and current, temperature, and AC volts and current.

Prior to the start of the scan, you can step through each of the configured channels on the DAQ6510, which allows you to troubleshoot the test configuration. This allows you to view the readings of individually closed channels to ensure that connections to the DUT are secure.

Equipment required

- One DAQ6510
- One Model 7700 20-channel differential multiplexer module
- One computer set up for communication with the instrument
- One device or component to be tested

Device connections

This application example uses a DAQ6510 with a 7700, 20-channel differential multiplexer configured to monitor the following signals:

- Channel 101: AC voltage being supplied to the DUT.
- Channels 102 to 110: DC voltages at several points located on the DUT.
- Channels 111 to 112: Temperature (using Type-K thermocouples) of two voltage regulators within the DUT.
- Channels 113 to 114: Temperature (using Type-K thermocouples) of two loads to which the DUT is supplying power.
- Channel 121: AC current being drawn by the DUT.
- Channel 122: DC current being drawn by the load.

Figure 41: DAQ6510 Model 7700

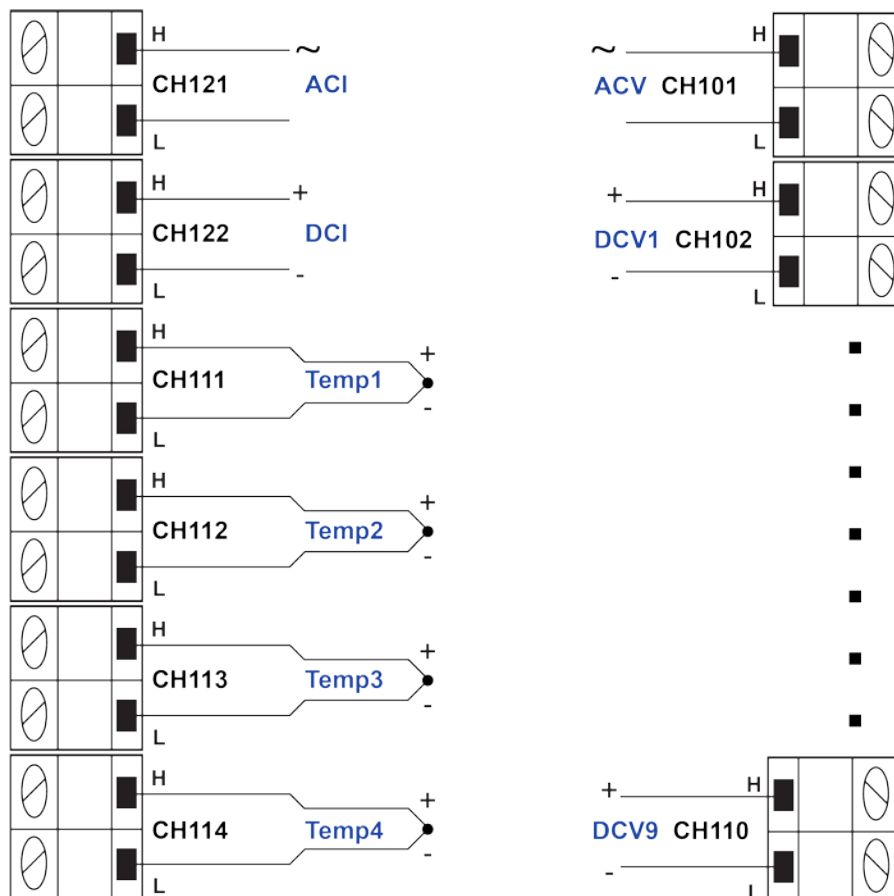

⚠ WARNING

To prevent electric shock, test connections must be configured such that the user cannot come in contact with test leads or any device under test (DUT) that is in contact with the conductors. It is good practice to disconnect DUTs from the instrument before powering the instrument. Safe installation requires proper shields, barriers, and grounding to prevent contact with test leads.

There is no internal connection between protective earth (safety ground) and the LO terminals of the DAQ6510. Therefore, hazardous voltages (more than 30 V_{RMS}) can appear on LO terminals. This can occur when the instrument is operating in any mode. To prevent hazardous voltage from appearing on the LO terminals, connect the LO terminal to protective earth (safety ground) if your application allows it. You can connect the LO terminal to the chassis ground terminal on the front panel or the chassis ground screw terminal on the rear panel. Note that the front-panel terminals are isolated from the rear-panel terminals. Therefore, if you are using the front-panel terminals, ground to the front-panel LO terminal. If using the rear-panel terminals, ground to the rear panel LO terminal. Failure to follow these guidelines can result in injury, death, or instrument damage.

Mixed function multi-channel scanning

This application example uses the DAQ6510 to execute complex multi-channel, mixed function scanning in a production-test environment.

For this application, you will:

- Configure the instrument for:
 - One channel each of ACV, ACI, and DCI.
 - Nine channels of DCV.
 - Four channels of temperature using Type K thermocouples using a simulated reference junction.
- Set labels on certain channels to help better identify what the measurement is monitoring at the DUT.
- Step through the scan to check each individual channel reading prior to scanning.
- Execute 10 scans for each selected channels.
- Use the reading table to view (or print) the scanned measurements.

You can operate the instrument through the front panel or using SCPI or TSP code. For information about setting up remote communications, see [Remote communications interfaces](#) (on page 3-1).

Using the front panel

To set up the application from the front panel:

1. Press the **POWER** switch on the front panel to turn on the instrument.
2. Set the TERMINALS switch to **REAR**.
3. Select **Build Scan** from the Scan swipe screen.
4. Select the **+** button to add channel **101**, select **OK**.
5. Select **AC Voltage** on the Measure Functions screen.
6. Select the Detector Bandwidth option, and set the bandwidth to 30 Hz.
7. Select channel 101, scroll to Label, enter **ACMains**, and select **OK** to continue.
8. Select the **+** button, add channels 102 to 110, select **OK**.
9. Select **DC Voltage**.
10. Select the **+** button, add channels 111 to 114, select **OK**.
11. Select **Temperature**.
12. Scroll to the **Temperature** setting, enter a Simulated junction temperature of **23 °C**, select **OK**.
13. Select **Simulated** for the Reference Junction.
14. In the top left corner of the screen, select **Menu**, select **Expand Groups**.
15. Select channel 111 and enter **Reg12VTemp** for the label. Select **OK**.
16. Select channel 112 and enter **Reg5VTemp** for the label. Select **OK**.
17. Select channel 113 and enter **LoadTemp1** for the label. Select **OK**.
18. Select channel 114 and enter **LoadTemp2** for the label. Select **OK**.
19. Select **Menu** and **Collapse Groups**. The AC Volt, DC Volt, and Temp groups are separated into individual groups.
20. Select the highlighted **+** button to add another group of channels and add channel 121. Select **OK**.
21. Select **AC Current**.
22. Select the **+** button and add channel 122, select **OK**.
23. Select **DC Current**.
24. On the Scan tab, set Scan Count to 10, select **OK**.
25. Press the **HOME** key.
26. Select **Step Scan**. This closes the first channel in the scan and displays the results. Use the left/right arrows adjacent to Watch Channel to scroll through the selected channels, selecting **Step Scan** on each, until all the channels have been validated.
27. Select **Abort Scan**.
28. Press the **TRIGGER** key to the right of the display to initiate the scan.

Using SCPI commands

This sequence of SCPI commands configures the instrument for measuring DC Voltage, Temperature, AC Voltage, DC Current, and AC Current on different channels and then labels some of those channels. Each channel is then scanned 10 times and the readings are returned.

You may need to make changes so that this code will run in your programming environment. In the table, the SCPI commands have a light gray background.

Send the following commands for this example application:

Commands	Descriptions
*RST	<ul style="list-style-type: none"> Put the instrument in a known state
SENS:FUNC 'VOLT:AC', (@101)	<ul style="list-style-type: none"> Set channel 101 for ACV
SENS:VOLT:AC:DET:BAND 30, (@101)	<ul style="list-style-type: none"> Set channel 101, low-end bandwidth to 30Hz
SENS:FUNC 'VOLT:DC', (@102:110)	<ul style="list-style-type: none"> Set channels 102-110 for DCV
SENS:FUNCTION 'TEMPERature', (@111:114)	<ul style="list-style-type: none"> Set channels 111-114 for Temperature measurement using Type K thermocouples with a simulated reference junction set to 23°C
SENS:TEMP:TRAN TC, (@111:114)	
SENS:TEMP:TC:TYPE K, (@111:114)	
SENS:TEMP:TC:RJUN:RSEL SIM, (@111:114)	
SENS:TEMP:TC:RJUN:SIM 23, (@111:114)	
SENS:FUNC 'CURR:AC', (@121)	<ul style="list-style-type: none"> Set channel 121 to measure ACI
SENS:FUNC 'CURR:DC', (@122)	<ul style="list-style-type: none"> Set channel 122 to measure DCI
ROUT:CHAN:LAB "ACSource", (@101)	<ul style="list-style-type: none"> Apply a label to channel 101
ROUT:CHAN:LAB "Reg12VTemp", (@111)	<ul style="list-style-type: none"> Apply a label to channel 111
ROUT:CHAN:LAB "Reg5VTemp", (@112)	<ul style="list-style-type: none"> Apply a label to channel 112
ROUT:CHAN:LAB "LoadTemp1", (@113)	<ul style="list-style-type: none"> Apply a label to channel 113
ROUT:CHAN:LAB "LoadTemp2", (@114)	<ul style="list-style-type: none"> Apply a label to channel 114
ROUTE:SCAN:COUNT:SCAN 10	<ul style="list-style-type: none"> Set the number scans
ROUTE:SCAN:CREATE (@101:114,121,122)	<ul style="list-style-type: none"> Set the channels included in the scan
INIT	<ul style="list-style-type: none"> Initiate the scan
*WAI	<ul style="list-style-type: none"> Wait for scan completion
TRAC:DATA? 1, 160, "defbuffer1", READ, CHAN	<ul style="list-style-type: none"> Query the readings from the instrument

Using TSP commands

NOTE

The following TSP code is designed to be run from Keithley Instruments Test Script Builder (TSB). TSB is a software tool that is available from tek.com/keithley. You can install and use TSB to write code and develop scripts for TSP-enabled instruments. Information about how to use TSB is in the online help for TSB and in the "Introduction to TSP operation" section of the *Model DAQ6510 Reference Manual*.

To use other programming environments, you may need to make changes to the example TSP code.

By default, the DAQ6510 uses the SCPI command set. You must select the TSP command set before sending TSP commands to the instrument.

To enable TSP commands:

1. Press the **MENU** key.
2. Under System, select **Settings**.
3. Set the Command Set to **TSP**.
4. At the prompt to reboot, select **Yes**.

This sequence of TSP commands makes a series of temperature measurements. After the code executes, the data is displayed in the Instrument Console of Test Script Builder.

Send the following commands for this example application:

```
-- Reset the instrument to the default settings
reset()
-- Establish channel settings for the scan card configuration...
channel.setdmm("101", dmm.ATTR_MEAS_FUNCTION, dmm.FUNC_AC_VOLTAGE)
channel.setdmm("101", dmm.ATTR_MEAS_DETECTBW, dmm.DETECTBW_30HZ)
channel.setdmm("102:110", dmm.ATTR_MEAS_FUNCTION, dmm.FUNC_DC_VOLTAGE)
channel.setdmm("111:114", dmm.ATTR_MEAS_FUNCTION, dmm.FUNC_TEMPERATURE)
channel.setdmm("111:114", dmm.ATTR_MEAS_TRANSducer, dmm.TRANS_THERMOCOUPLE)
channel.setdmm("111:114", dmm.ATTR_MEAS_THERMOCOUPLE, dmm.THERMOCOUPLE_K)
channel.setdmm("111:114", dmm.ATTR_MEAS_REF_JUNCTION, dmm.REFJUNCT_SIMULATED)
channel.setdmm("111:114", dmm.ATTR_MEAS_FUNCTION, dmm.FUNC_TEMPERATURE,
  dmm.ATTR_MEAS_SIM_REF_TEMP, 23)
channel.setlabel("101", "ACSource")
channel.setlabel("111", "Reg12VTemp")
channel.setlabel("112", "Reg5VTemp")
channel.setlabel("113", "LoadTemp1")
channel.setlabel("114", "LoadTemp2")
channel.setdmm("121", dmm.ATTR_MEAS_FUNCTION, dmm.FUNC_AC_CURRENT)
channel.setdmm("122", dmm.ATTR_MEAS_FUNCTION, dmm.FUNC_DC_CURRENT)
-- Generate the scan...
scan.create("101:114,121,122")
scan.scancount = 10
-- Clear and size the buffer...
defbuffer1.clear()
defbuffer1.capacity = 10 * 16
-- Start the scan and wait...
trigger.model.initiate()
waitcomplete()
-- Extract the data...
printbuffer(1, defbuffer1.n, defbuffer1, defbuffer1.readings, defbuffer1.channels)
```

Test results

The following procedure shows the results for this application.

1. Press the **Menu** key.
2. Under Views, select **Reading Table**.
3. Scroll the reading table noting both the measurements and labels in the Channel column of the table.

Figure 42: DAQ6510 reading table mixed function multichannel scanning

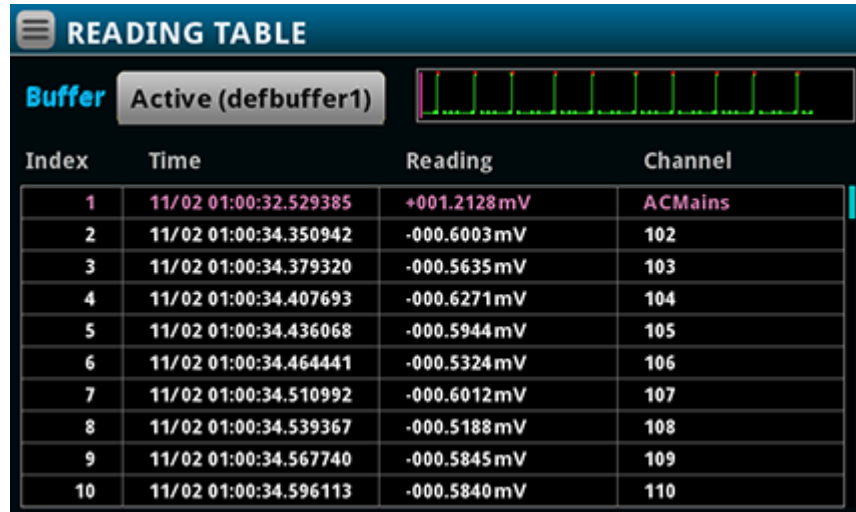

To save the scanned measurements to a USB flash drive:

1. Select the **MENU** key.
2. Under the **Measure** column, choose **Reading Buffers**.
3. Insert a USB flash drive into the DAQ6510, select **Save to USB**.
4. Select the **Change** button adjacent to the Filename label, enter **MixedScan** using the dialog provided.
5. Select **OK**.

Speed scanning for increased test throughput

In this section:

Introduction	9-1
Equipment required.....	9-1
Device connections	9-2
Speed scanning for increased production test throughput	9-3

Introduction

There are three different multiplex modules available for use with the DAQ6510. This application example demonstrates how each of the multiplexer modules can impact productivity by changing test time. The multiplexer modules all share the same basic code base for switching, scanning, and measuring. Any limits on system speed are the result of the relays in the multiplexer that switch the signals from the device under test (DUT) into the instrument.

The Model 7700 20-Channel Differential Multiplexer Module uses electromechanical relays which have low contact resistance and contribute only a minor offset potential ($<1 \Omega$ through the end of life and $< 500 \text{ nV}$, respectively). This results in the most accurate readings of the modules but with a 3 ms relay closure time, the slowest scan time in comparison to other options.

The 7703 multiplexer module uses reed relays which have low contact resistance ($<1 \Omega$ through the end of life), but a higher contact potential ($6 \mu\text{V}$ max) which contributes more signal offset and slightly less precise readings. The benefit of this module is shorter relay close time (less than 1 ms) which makes it approximately three times faster than the 7700.

The 7710 multiplexer module uses solid-state relays which have the highest contact resistance and contact potential of the three options ($<5 \Omega$ and $<1 \mu\text{V}$, respectively) and are therefore the least precise, however the 7710 has the overall speed advantage with a relay close time of less than 0.5 ms, making it twice as fast as the 7703 and at least six times faster than the 7700.

NOTE

For comprehensive information on relay types, topologies, and the benefits or drawbacks of each, go to the Keithley webpage on the tek.com/keithley and search for the Switching Handbook.

Equipment required

- One DAQ6510
- One Model 7700 20-channel differential multiplexer module
- One Model 7710 20-channel differential multiplexer module
- One computer set up for remote communication with the DAQ6510
- One device or component to be tested

Device connections

This example assumes a setup optimized for the greatest speed where the DAQ6510 uses either the 7700 or 7710 20-channel differential multiplexer module multiple to monitor the following signals; the example code is the same for each.

The controlling computer can use either LAN, USB, or GPIB to reach scan and data transfer speeds comparable to those of the original factory setup. The GPIB interface requires an optional communications accessory.

See the following image for the connection example.

Figure 43: DAQ6510 speed scanning instrument and device connection

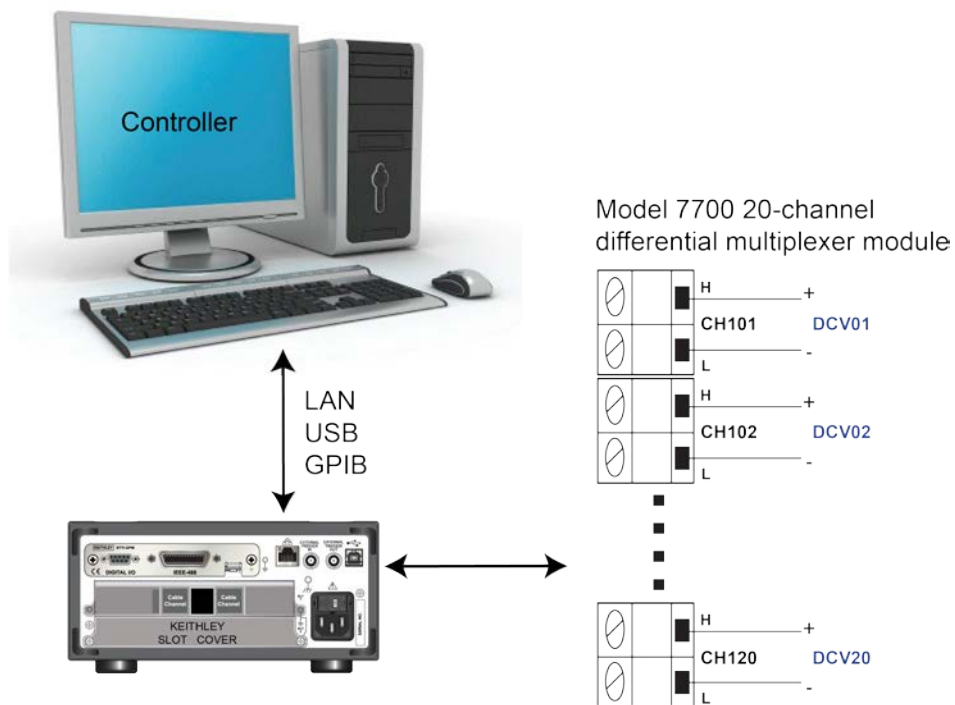

NOTE

The 7700 replaces the 7710 for the second run of the program code for comparison and assumes the same input signals to channels 101 to 120.

⚠ WARNING

To prevent electric shock, test connections must be configured such that the user cannot come in contact with test leads or any device under test (DUT) that is in contact with the conductors. It is good practice to disconnect DUTs from the instrument before powering the instrument. Safe installation requires proper shields, barriers, and grounding to prevent contact with test leads.

There is no internal connection between protective earth (safety ground) and the LO terminals of the DAQ6510. Therefore, hazardous voltages (more than 30 V_{RMS}) can appear on LO terminals. This can occur when the instrument is operating in any mode. To prevent hazardous voltage from appearing on the LO terminals, connect the LO terminal to protective earth (safety ground) if your application allows it. You can connect the LO terminal to the chassis ground terminal on the front panel or the chassis ground screw terminal on the rear panel. Note that the front-panel terminals are isolated from the rear-panel terminals. Therefore, if you are using the front-panel terminals, ground to the front-panel LO terminal. If using the rear-panel terminals, ground to the rear panel LO terminal. Failure to follow these guidelines can result in injury, death, or instrument damage.

Speed scanning for increased production test throughput

This application demonstrates how to configure the DAQ6510 to execute scans at the best scan speed. You will eliminate certain measurement options that add to overall test time. The scan completion times of the 7700 and 7710 20-channel differential multiplexer modules will be compared, and you will see the speed improvement attributed to solid-state relays over electromechanical relays used in some multiplexer modules.

For this application, you will:

- Use the sample code (either SCPI or TSP) to issue commands that:
 - Fix the DCV measurement range for all channels and remove the delay time introduced through autoranging.
 - Eliminate the autozero feature to remove extra correction measurements from being performed.
 - Set the display digits to a low resolution and turn off the front panel to bypass any delays that would come from updates/refreshes.
 - Turn off channel statistics calculation so that the instrument puts its processing power into data acquisition and transmission.
 - Disable line synchronization.
 - Execute a 20-channel scan with a count of 1000 for a total sample count of 20,000 readings.
 - Incrementally extract the most current scan measurements until complete and either save them to a file or print them to the computer display.
- Evaluate the time elapsed.

Using SCPI commands

This sequence of SCPI commands executes a 20-channel scan 1000 times and saves the data to the controlling computer.

You may need to make changes so that this code will run in your programming environment. In the table, the SCPI commands have a light gray background. The light green shaded code represents pseudocode that will vary depending on the programming environments you use.

Send the following SCPI commands for this example application:

	Commands	Descriptions
Pseudocode	<pre>int scanCnt = 1000 int sampleCnt int chanCnt int actualRdgs string rcvBuffer timer1.start()</pre>	<ul style="list-style-type: none"> ■ Create a variable to hold the scan count ■ Create a variable to hold the full sample count (total number of readings) ■ Create a variable to hold the channel count ■ Create a variable to hold the actual reading count ■ Create a string buffer to hold extracted readings ■ Start a timer to help capture elapsed time
DAQ6510	<pre>*RST FORM:DATA ASCII ROUT:SCAN:COUN:SCAN scanCnt FUNC 'VOLT:DC', (@101:120) VOLT:RANG 1, (@101:120) VOLT:AVER:STAT OFF, (@101:120) DISP:VOLT:DIG 4, (@101:120) VOLT:NPLC 0.0005, (@101:120) VOLT:LINE:SYNC OFF, (@101:120) VOLT:AZER:STAT OFF, (@101:120) CALC2:VOLT:LIM1:STAT OFF, (@101:120) CALC2:VOLT:LIM2:STAT OFF, (@101:120) ROUT:SCAN:INT 0 TRAC:CLE DISP:LIGH:STAT OFF</pre>	<ul style="list-style-type: none"> ■ Put the instrument in a known state ■ Format data as an ASCII string ■ Apply the scan count ■ Set function to DCV ■ Set the fixed range at 1 V ■ Disable background statistics ■ Front panel shows only four significant digits ■ Set fastest NPLC possible ■ Turn off line sync ■ Turn off auto zero ■ Turn off limit tests ■ Set trigger interval between scans to 0s ■ Clear the reading buffer ■ Turn the display off

	ROUT:SCAN:CRE (@101:120)	<ul style="list-style-type: none"> Set the scan list
	chanCnt = ROUTE:SCAN:COUNT:STEP?	<ul style="list-style-type: none"> Query the channel count
Pseudocode	sampleCnt = scanCnt * chanCnt	<ul style="list-style-type: none"> Calculate the number of readings taken
DAQ6510	INIT	<ul style="list-style-type: none"> Initiate the scan
Pseudocode	for i = 1, i < sampleCnt	<ul style="list-style-type: none"> Setup a loop from one up to sampleCnt, but leave the incrementing of i for later
	delay 500	<ul style="list-style-type: none"> Delay for 500 ms to allow readings to accumulate
DAQ6510	actualRdgs = TRACe:ACTual?	<ul style="list-style-type: none"> Query the actual readings captured
	rcvBuffer = "TRACe:DATA? i, actualRdgs, "defbuffer1", READ	<ul style="list-style-type: none"> Query the readings available from i to the value of actualRdgs
Pseudocode	WriteReadings("C:\myData.csv" , rcvBuffer)	<ul style="list-style-type: none"> Write the extracted readings to a file, myData.csv, on the local computer
	i = actualRdgs + 1	<ul style="list-style-type: none"> Increment i for the next loop pass
	end for	<ul style="list-style-type: none"> End the for loop
	timer1.stop()	<ul style="list-style-type: none"> Stop the timer
	timer1.stop - timer1.start	<ul style="list-style-type: none"> Calculate the elapsed time
DAQ6510	DISP:LIGH:STAT ON100	<ul style="list-style-type: none"> Turn the display back on

Using TSP commands

NOTE

The following TSP code is designed to be run from Keithley Instruments Test Script Builder (TSB). TSB is a software tool that is available from tek.com/keithley. You can install and use TSB to write code and develop scripts for TSP-enabled instruments. Information about how to use TSB is in the online help for TSB and in the "Introduction to TSP operation" section of the *Model DAQ6510 Reference Manual*.

To use other programming environments, you may need to make changes to the example TSP code.

By default, the DAQ6510 uses the SCPI command set. You must select the TSP command set before sending TSP commands to the instrument.

To enable TSP commands:

1. Press the **MENU** key.
2. Under System, select **Settings**.
3. Set the Command Set to **TSP**.
4. At the prompt to reboot, select **Yes**.

This sequence of TSP commands makes a series of voltage measurements. After the code executes, the data is displayed in the Instrument Console of Test Script Builder.

Send the following commands for this example application:

```
-- Set up variables to be referenced during the scan
scanCnt = 1000
sampleCnt = 0
chanCnt = 0
actualRdgs = 0
rcvBuffer = ""
-- Get the initial timestamp for end-of-run comparison
local x = os.clock()
-- Reset the instrument and clear the buffer
reset()
defbuffer1.clear()
-- Set up reading buffer format and establish scan count
format.data = format.ASCII
scan.scancount = scanCnt
-- Configure the scan channels for the Slot 1 card
channel.setdmm("101:120", dmm.ATTR_MEAS_FUNCTION, dmm.FUNC_DC_VOLTAGE)
channel.setdmm("101:120", dmm.ATTR_MEAS_RANGE, 1)
channel.setdmm("101:120", dmm.ATTR_MEAS_RANGE_AUTO, dmm.OFF)
channel.setdmm("101:120", dmm.ATTR_MEAS_AUTO_ZERO, dmm.OFF)
channel.setdmm("101:120", dmm.ATTR_MEAS_DIGITS, dmm.DIGITS_4_5)
channel.setdmm("101:120", dmm.ATTR_MEAS_NPLC, 0.0005)
channel.setdmm("101:120", dmm.ATTR_MEAS_APERTURE, 8.33333e-06)
channel.setdmm("101:120", dmm.ATTR_MEAS_LINE_SYNC, dmm.OFF)
channel.setdmm("101:120", dmm.ATTR_MEAS_LIMIT_ENABLE_1, dmm.OFF)
channel.setdmm("101:120", dmm.ATTR_MEAS_LIMIT_ENABLE_2, dmm.OFF)
-- Dim the display...
display.lightstate = display.STATE_LCD_OFF
-- Generate the scan...
scan.create("101:120")
scan.scaninterval = 0.0
chanCnt = scan.stepcount
```

```

-- Calculate the overall sample count and use it to size the buffer
sampleCnt = scanCnt * chanCnt
defbuffer1.capacity = sampleCnt
-- Start the scan...
trigger.model.initiate()
-- Loop to capture and print readings
i = 1
while i <= sampleCnt do
  delay(0.5)
  myCnt = defbuffer1.n
  -- NOTE: Can be supplemented or replaced by writing to USB
  printbuffer(i, myCnt, defbuffer1.readings)
  i = myCnt + 1
end
-- Turn the display back on...
display.lightstate = display.STATE_LCD_50
-- Output the elapsed time to the user
print(string.format("Elapsed Time: %2f\n", os.clock() - x))

```

Test results

Factory run times are as follows. The test time for an equivalent setup using the Model 7703 has also been provided so that you can see what is achievable with the reed relays.

Differential Multiplexer Module Setup	Outcome
7710: 20-channels for 1000 scans at 20,000 readings	Approximate test duration: 19.77 s at 1052 rdgs/s
7703: 20-channels for 1000 scans at 20,000 readings	Approximate test duration: 43.12 s at 465 rdgs/s
7700: 20-channels for 1000 scans at 20,000 readings	Approximate test duration: 3 m 38.93 s at 91 rdgs/s

The 7710 multiplexer module provides readings to the DAQ6510 faster and has the speed advantage.

Pre-scan monitor

In this section:

Introduction	10-1
Equipment required.....	10-1
Device connections	10-2
Pre-scan monitor.....	10-3

Introduction

Many products need to be environmentally-stressed during performance testing. This is accomplished by placing the device in a chamber where the temperature can be set and controlled and soaking the DUT at the required set-point conditions. Temperature changes are not instantaneous so there is some wait time between scans. The DAQ6510 can monitor the environment until the target temperature has been reached at which point the instrument automatically begins the scan.

This application example demonstrates how to use a DAQ6510 to initiate a scan based on the temperature of the environment around the device under test (DUT). This example will model a situation where resistance DUTs are measured after the temperature exceeds 30 °C.

Equipment required

- One DAQ6510
- One Model 7700 20-channel differential multiplexer module
- One computer set up for communication with the instrument
- One Type K thermocouple
- Four resistors

Device connections

This application example uses a DAQ6510 with a Model 7700 20-channel differential multiplexer configured to monitor a Type K thermocouple, connected to channel 101, and four DUTs (resistors) connected to channels 102 through 105.

Figure 44: DAQ6510 Device Connections — Pre-scan Monitor

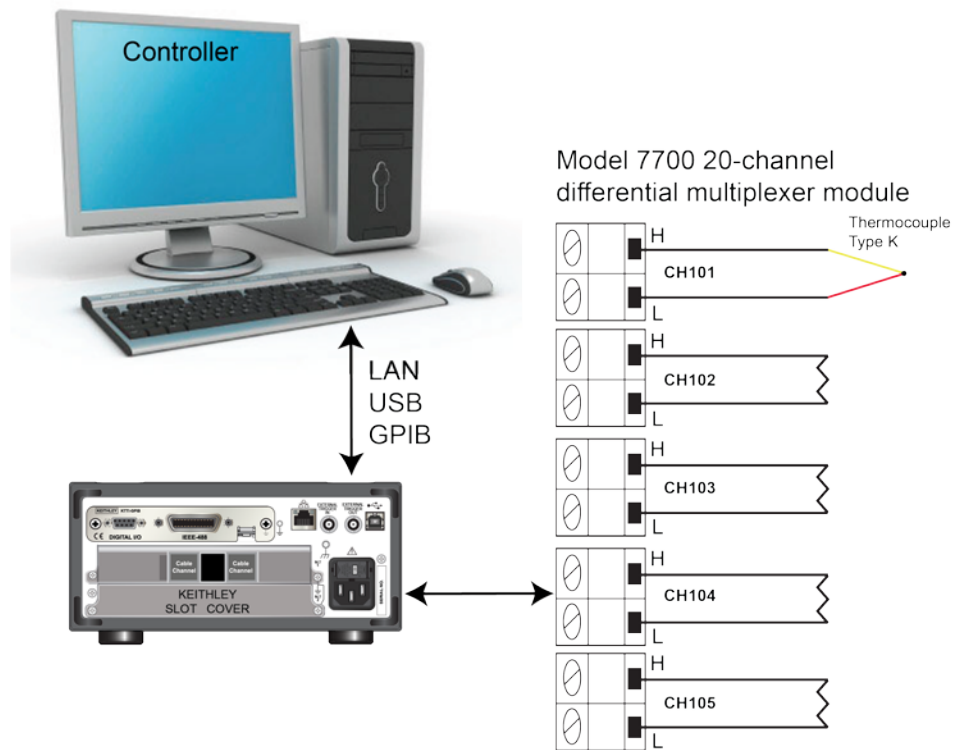

⚠ WARNING

To prevent electric shock, test connections must be configured such that the user cannot come in contact with test leads or any device under test (DUT) that is in contact with the conductors. It is good practice to disconnect DUTs from the instrument before powering the instrument. Safe installation requires proper shields, barriers, and grounding to prevent contact with test leads.

There is no internal connection between protective earth (safety ground) and the LO terminals of the DAQ6510. Therefore, hazardous voltages (more than 30 V_{RMS}) can appear on LO terminals. This can occur when the instrument is operating in any mode. To prevent hazardous voltage from appearing on the LO terminals, connect the LO terminal to protective earth (safety ground) if your application allows it. You can connect the LO terminal to the chassis ground terminal on the front panel or the chassis ground screw terminal on the rear panel. Note that the front-panel terminals are isolated from the rear-panel terminals. Therefore, if you are using the front-panel terminals, ground to the front-panel LO terminal. If using the rear-panel terminals, ground to the rear panel LO terminal. Failure to follow these guidelines can result in injury, death, or instrument damage.

Pre-scan monitor

The DAQ6510 uses Monitor Measurement triggering on channel 101.

For this application, you will:

- Configure the instrument to measure the temperature on channel 101 using a thermocouple. The instrument then scans channels 102 to 105 after the specified temperature has been reached.
- Configure the scan on channels 102 to 105 using the 2-wire resistance function.

Using the front panel

To setup the application from the front panel:

1. Press the **POWER** switch on the front panel to turn on the instrument.
2. Select the **REAR** terminals.
3. Press the **MENU** key.
4. Under Channel, select **Scan**.
5. Select the **+** button to add a group of channels (101 to 105), and select **OK**.
6. Select **2W Resistance** on the Measure Functions screen.
7. In the upper left corner of the screen, select **Expand Group** from the Menu icon.
8. Select channel 101 by selecting the adjacent 2-Wire Res button. Change the function to **Temperature**.
9. Set Reference Junction to **Internal**.
10. In the Scan tab, change the **Scan Count** to **10**.
11. In the Trigger tab, select **Scan Start** and select **Monitor Measurement**.
12. A second panel opens, select **Above High Limit** for Start Condition.
13. Set Channel to 101.
14. Set Higher Limit to 30 °C and select **OK**.
15. Select the **Start** button at the bottom of the left-side pane to start the scan.
16. Select **View Scan Status** to return to the HOME screen.

You will be able to watch the active temperature measurement on channel 101. Once the target temperature has been reached the instrument begins scanning.

Using SCPI commands

This sequence of SCPI commands executes a scan once the the environment reaches a target temperature.

You may need to make changes so that this code will run in your programming environment. In the table, the SCPI commands have a light gray background.

Send the following SCPI commands for this example application:

Commands	Descriptions
*RST	<ul style="list-style-type: none"> Put the instrument in a known state
FUNC "TEMP", (@101)	<ul style="list-style-type: none"> Monitor temperature on channel 101
TEMP:TRAN TC, (@101)	<ul style="list-style-type: none"> Set transducer type to thermocouple
TEMP:TC:TYPE K, (@101)	<ul style="list-style-type: none"> Set thermocouple type to K
TEMP:UNIT CELS, (@101)	<ul style="list-style-type: none"> Set unit to Celsius
TEMP:TC:RJUN:RSEL INT, (@101)	<ul style="list-style-type: none"> Set internal reference
ROUT:SCAN:MON:CHAN (@101)	<ul style="list-style-type: none"> Monitor channel 101
ROUT:SCAN:MON:LIM:UPP 30	<ul style="list-style-type: none"> Set upper limit to 30 Celsius degree
ROUT:SCAN:MON:MODE UPP	<ul style="list-style-type: none"> Set monitor mode to upper
FUNC "RES", (@102:105)	<ul style="list-style-type: none"> Scan resistance on channel 102 through 105
RES:RANG:AUTO ON, (@102:105)	<ul style="list-style-type: none"> Set auto range
ROUT:SCAN:CREATE (@101:105)	<ul style="list-style-type: none"> Scan channel 101 through 105
ROUT:SCAN:COUN:SCAN 10	<ul style="list-style-type: none"> Set scan count to 10
INIT	<ul style="list-style-type: none"> Initiates the monitoring of channel 101 conditions, which will enable the scan when it crosses the temperature threshold

Using TSP commands

NOTE

The following TSP code is designed to be run from Keithley Instruments Test Script Builder (TSB). TSB is a software tool that is available from tek.com/keithley. You can install and use TSB to write code and develop scripts for TSP-enabled instruments. Information about how to use TSB is in the online help for TSB and in the "Introduction to TSP operation" section of the *Model DAQ6510 Reference Manual*.

To use other programming environments, you may need to make changes to the example TSP code.

By default, the DAQ6510 uses the SCPI command set. You must select the TSP command set before sending TSP commands to the instrument.

To enable TSP commands:

1. Press the **MENU** key.
2. Under System, select **Settings**.
3. Set the Command Set to **TSP**.
4. At the prompt to reboot, select **Yes**.

This sequence of TSP commands monitors the temperature measurement on the first channel to ensure the test environment has reached the required temperature to begin scanning. After the code executes, the data is displayed in the Instrument Console of Test Script Builder.

Send the following commands for this example application:

```
-- monitor temperature on channel 101
reset()
channel.setdmm("101", dmm.ATTR_MEAS_FUNCTION, dmm.FUNC_TEMPERATURE,
    dmm.ATTR_MEAS_TRANSDUCER, dmm.TRANS_THERMOCOUPLE, dmm.ATTR_MEAS_THERMOCOUPLE,
    dmm.THERMOCOUPLE_K, dmm.ATTR_MEAS_REF_JUNCTION, dmm.REFJUNCT_INTERNAL)
channel.setdmm("101", dmm.ATTR_MEAS_UNIT, dmm.UNIT_CELSIUS)
-- set limit high on monitor and trigger scan when high limit exceeds
scan.monitor.channel = "101"
scan.monitor.limit.high.value = 30
scan.monitor.mode = scan.MODE_HIGH
-- scan 2-wire resistance on channel 102:105
channel.setdmm("102:105", dmm.ATTR_MEAS_FUNCTION, dmm.FUNC_RESISTANCE,
    dmm.ATTR_MEAS_RANGE_AUTO, dmm.ON)
-- create scan
scan.create("101:105")
scan.scancount = 10
-- initiates the monitoring of channel 101 conditions, which will enable the scan
    when it crosses the temperature threshold.
trigger.model.initiate()
```

Troubleshooting/FAQ

In this section:

About this section.....	11-1
Where can I find updated drivers?	11-1
Is there any software to help me get started	11-2
How do I upgrade the firmware?	11-2
Why can't the DAQ6510 read my USB flash drive?	11-3
How do I change the command set?	11-3
How do I save the present state of the instrument?	11-4
Why did my settings change?	11-5
What is the ethernet port number?	11-5

About this section

This section helps you find answers to the most common questions encountered with the DAQ6510.

Where can I find updated drivers?

For the latest drivers and additional support information, see the Keithley Instruments support website.

To see what drivers are available for your instrument:

1. Go to tek.com/keithley.
2. Enter the model number of your instrument.
3. Select **Software Driver** from the list.

NOTE

If you use the native LabVIEW™ or IVI driver, you must configure the DAQ6510 to use the SCPI command set. For information on changing the command set, refer to [How do I change the command set?](#) (on page 3-18)

Is there any software to help me get started

Yes. Keithley Instruments provides Keithley Instruments KickStart and Keithley Instruments TestScript Builder to help you get started with the DAQ6510.

Keithley Instruments KickStart is a software program that allows you to set up your instrument and run a test without using any programming languages.

Keithley Instruments TestScript Builder (TSB) is a software tool that simplifies building test scripts if you are using the Test Scrip Processor (TSP®) scripting engine.

Both software options are available on tek.com/keithley.

How do I upgrade the firmware?

CAUTION

Do not turn off power or remove the USB flash drive until the upgrade process is complete.

NOTE

The firmware file must be in the root subdirectory of the flash drive and must be the only firmware file in that location. You can upgrade or downgrade the firmware from the front panel or from the virtual front panel.

From the front panel or virtual front panel:

1. Copy the firmware file (.upg file) to a USB flash drive.
2. Verify that the firmware file is in the root subdirectory of the flash drive and that it is the only firmware file in that location.
3. Disconnect any terminals that are attached to the instrument.
4. Turn on instrument power.
5. Insert the flash drive into the USB port on the front panel of the instrument.
6. From the instrument front panel, press the **MENU** key.
7. Under System, select **Info/Manage**.
8. Choose an upgrade option:
 - To upgrade to a newer version of firmware, select **Upgrade to New**.
 - To return to a previous version of firmware, select **Downgrade to Older**.
9. If the instrument is controlled remotely, a message is displayed. Select **Yes** to continue.
10. When the upgrade is complete, reboot the instrument.

A message is displayed while the upgrade is in progress.

Upgrade files are available on tek.com/keithley.

Why can't the DAQ6510 read my USB flash drive?

Verify that the flash drive is formatted with the FAT32 file system. The DAQ6510 only supports FAT and FAT32 drives using MBR (Master Boot Record).

In Microsoft® Windows®, you can check the file system by checking the properties of the USB flash drive.

How do I change the command set?

You can change the command set that you use with the DAQ6510. The remote command sets that are available include:

- SCPI: An instrument-specific language built on the SCPI standard.
- TSP: A scripting programming language that contains instrument-specific control commands that can be executed from a stand-alone instrument. You can use TSP to send individual commands or use it to combine commands into scripts.
- SCPI2700: An instrument-specific language that allows you to run code developed for Keithley Instruments Series 2700 instruments.
- SCPI2701: An instrument-specific language that allows you to run code developed for Keithley Instruments Series 2700 instruments.

You cannot combine the command sets.

NOTE

As delivered from Keithley Instruments, the DAQ6510 is set to work with the DAQ6510 SCPI command set.

To set the command set from the front panel:

1. Press the **MENU** key.
2. Under System, select **Settings**.
3. Select **Command Set**.

You are prompted to reboot.

To verify which command set is selected from a remote interface:

Send the command:

```
*LANG?
```

To change to the SCPI command set from a remote interface:

Send the command:

```
*LANG SCPI
```

Reboot the instrument.

To change to the TSP command set from a remote interface:

Send the command:

```
*LANG TSP
```

Reboot the instrument.

How do I save the present state of the instrument?

You can save the settings in the instrument as a script using the front-panel menus or from a remote interface. After they are saved, you can recall the script or copy it to a USB flash drive.

From the front panel:

1. Configure the DAQ6510 to the settings that you want to save.
2. Press the **MENU** key.
3. Under Scripts, select **Save Setup**. The SAVE SETUP window is displayed.
4. Select **Create**. A keyboard is displayed.
5. Use the keyboard to enter the name of the script.
6. Select the **OK** button on the displayed keyboard. The script is added to internal memory.

Using SCPI commands:

Configure the instrument to the settings that you want to save. To save the setup, send the command:

```
*SAV <n>
```

Where <n> is an integer from 0 to 4.

NOTE

In the front-panel script menus, the setups saved with the *SAV command have the name Setup0x, where x is the value you set for <n>.

Using TSP commands:

Configure the instrument to the settings that you want to save. To save the setup, send the command:

```
createconfigscript("setupName")
```

Where *setupName* is the name of the setup script that is created.

Why did my settings change?

Many of the commands in the DAQ6510 are saved with the measure function that was active when you set them. For example, assume you have the measure function set to current and you set a value for display digits. When you change the measure function to voltage, the display digits value changes to the value that was last set for the voltage measure function. When you return to the current measure function, the display digits value returns to the value you set previously.

What is the ethernet port number?

The port number is 5025.

In this section:

[Additional DAQ6510 information](#) 12-1

Additional DAQ6510 information

This manual has prepared you to start using your new DAQ6510 Data Acquisition / Multimeter System for your application. For more detailed information, refer to the Keithley Instruments *DAQ6510 Reference Manual*.

Also see tek.com/keithley for support and additional information about the instrument. From the website, you can access:

- The Knowledge Center, which contains the following handbooks:
 - *The Low Level Measurements Handbook: Precision DC Current, Voltage, and Resistance Measurements*
 - *Switching Handbook: A Guide to Signal Switching in Automated Test Systems*
- Application notes
- Updated drivers
- Information about related products

Your local Field Applications Engineer can help you with product selection, configuration, and usage. Check the website for contact information.

Index

A

About this section • 11-1
Additional DAQ6510 information • 12-1
Additional information • 3-11, 3-14, 3-15
Adjust the backlight brightness and dimmer • 2-6
Application examples • 1-3

B

backlight brightness • 2-6
Basic front-panel measurements • 4-3

C

Channel menu • 2-17
Check communication settings • 3-3
command
 command set • 3-18
Communicate with the instrument • 3-6
Connect a computer to the DAQ6510 using USB • 3-5
Connect GPIB cables to your instrument • 3-10
Connect the power cord • 2-4
Connect to the instrument web interface • 3-15
Contact information • 1-2

D

Determining the command set you will use • 3-18, 11-1
Device connections • 4-2, 5-2, 6-2, 7-3, 8-2, 9-2, 10-2
display
 touchscreen • 2-5
Documentation set • 1-2

E

Enter information • 2-6
Equipment required • 5-1, 6-1, 7-2, 8-1, 9-1, 10-1
Equipment required for this example • 4-1
extended warranty • 1-2
Extended warranty • 1-2

F

front panel
 interface • 2-1
 using • 2-1
Front-panel overview • 1-3, 2-1

FUNCTIONS swipe screen • 2-9

G

GPIB
 Install • 3-9
GPIB communications • 3-9
GRAPH swipe screen • 2-12

H

How do I change the command set? • 11-3
How do I save the present state of the instrument? • 11-4
How do I upgrade the firmware? • 11-2

I

Identify the instrument • 3-17, 3-18
Install the KTTI-GPIB accessory card • 3-9
Install the KTTI-RS232 accessory card • 3-12
Install the KTTI-TSP accessory card • 3-14
Installation • 3-9, 3-12, 3-14
Instrument power • 2-3
Interactive swipe screens • 2-7
Introduction • 1-1, 1-3, 4-1, 5-1, 6-1, 7-1, 8-1, 9-1, 10-1
Introduction to this manual • 1-1
Is there any software to help me get started • 11-2

L

LAN communications • 3-2
LAN troubleshooting suggestions • 3-3, 3-16

M

Making basic front-panel measurements • 1-3, 4-1
Making connections • 3-13, 3-15
Measure Menu • 2-17
MENU key • 2-16
Menu overview • 2-2, 2-16
Mixed function multi-channel scanning • 8-1, 8-3

N

Next steps • 1-3, 12-1

O

Organization of manual sections • 1-3

P

power
 on • 2-3
POWER switch • 2-1
Pre-scan monitor • 1-3, 10-1, 10-3

R

remote command interface • 3-1
Remote communications interfaces • 3-1, 8-3
Review event messages • 2-7
RS-232 • 3-12

S

SCAN swipe screen • 2-14
Scanning low-level DCV • 6-1, 6-3
Scanning resistors using 4W measurement • 7-1
Scanning resistors using 4-wire measurements • 7-5
Scanning temperature using thermocouples • 1-3, 5-1
SCPI • 3-18
Scripts menu • 2-18
Scroll bars • 2-5
SECONDARY swipe screen • 2-11
Select items on the touchscreen • 2-5
Set the GPIB address • 3-12
Set up automatic LAN configuration • 3-3
Set up LAN communications on the computer • 3-4
Set up LAN communications on the instrument • 3-3
Set up manual LAN configuration • 3-4
SETTINGS swipe screen • 2-9
Speed scanning for increased production test throughput • 9-3
Speed scanning for increased test throughput • 9-1
STATISTICS swipe screen • 2-10
Supported remote interfaces • 3-2
Swipe screen heading bar • 2-7
System menu • 2-19

T

Test results • 5-7, 7-8, 8-7, 9-7
Thermocouple temperature scanning • 5-3
Touchscreen display • 2-2, 2-5
Trigger menu • 2-18
Troubleshooting/FAQ • 1-3, 11-1
TSP • 3-18
TSP-Link • 3-14
Turn the DAQ6510 on or off • 2-4

U

Unpack and inspect • 3-9, 3-12, 3-14
USB communications • 3-5
Use the LXI Discovery Tool • 3-5
USER swipe screen • 2-12

Using a remote interface • 1-3, 3-1
Using SCPI commands • 5-5, 6-4, 7-6, 8-5, 9-4, 10-4
Using the front panel • 5-4, 6-4, 7-5, 8-4, 10-3
Using the web interface • 3-2, 3-15
Using TSP commands • 5-6, 6-6, 7-7, 8-6, 9-6, 10-5

V

Views menu • 2-18

W

Wait for the LAN status indicator to turn green • 3-5
warranty • 1-2
Web interface Home page • 3-17
Welcome • 1-1
What is the ethernet port number? • 11-5
Where can I find updated drivers? • 11-1
Why can't the DAQ6510 read my USB flash drive? • 11-3
Why did my settings change? • 11-5

Specifications are subject to change without notice.
All Keithley trademarks and trade names are the property of Keithley Instruments.
All other trademarks and trade names are the property of their respective companies.

Keithley Instruments
Corporate Headquarters • 28775 Aurora Road • Cleveland, Ohio 44139 • 440-248-0400 • Fax: 440-248-6168 • 1-800-935-5595 • www.tek.com/keithley

