

Multiplexer Models CTS3000 and CTS5000

WIKA data sheet AC 87.01

Applications

- Expansion of channels for the measuring instrument
- Extended measured value registration
- Temperature mapping

Special features

- No loss of accuracy for the measuring instrument
- No loss of channels at the measuring instrument
- Up to four multiplexers can be stacked
- No parasitic thermal voltages due to high-quality materials
- By using of solid-state relays no wear and no clacking



Multiplexer model CTS3000 in desktop case



Multiplexer model CTS5000

Description

The models CTS3000 and CTS5000 multiplexers are components of the modular system of our precision thermometer series.

They are used to switch between several thermometers in order to make the measured value registration easier or even to automate it. This saves time and with that, also money.

Our multiplexers can only be used with one of our model CTR precision thermometers. These feed and communicate completely autonomously with the multiplexers.

The multiplexers are operated reliably by solid-state relays, so that high-precision switching from channel to channel is possible. Due to the use of high-quality materials, no loss of accuracy is to be expected, either.

All settings for the thermometer on a specific channel, such as the measuring range, characteristic curves or measuring current, are made directly on the measuring instrument. In addition, these settings can be comfortably managed from a PC and also via the interface of the measuring instrument.

Specifications

| | CTS3000 | CTS5000 |
|---|---|---|
| Number of channels | 10 | <ul style="list-style-type: none"> ■ 8 ■ 16 |
| Channel indication | LED | LED |
| Probe connection | 4 mm banana jacks and TC mini connectors | 5-pin connector |
| Case type | <ul style="list-style-type: none"> ■ Desktop case ■ Built-in case for 19" racks | Desktop case |
| Connection to measuring instrument | | |
| Max. number per measuring instrument | 4 | 4 |
| Selectable probe types | | |
| Pt100 – 3-wire | ✓ | - |
| Pt100 – 4-wire | ✓ | ✓ |
| Thermistors | ✓ | - |
| Thermocouples | ✓ | - |
| Measuring instrument assignment | | |
| CTR3000 | ✓ | ✓ |
| CTR5000 | - | ✓ |
| Permissible ambient conditions | | |
| Operating temperature | 0 ... 50 °C [32 ... 122 °F] | |
| Relative humidity | 0 ... 60 % r. h. (non-condensing) | |
| Storage temperature | -20 ... +50 °C [-4 ... +122 °F] | |
| Case | | |
| Dimensions (W x H x D) | see technical drawings | 260 x 80 x 270 mm [10.24 x 3.15 x 10.63 in] |
| Weight | 4 kg [8.8 lbs] | 1.85 kg [4.1 lbs] |

Approvals

| Logo | Description | Country |
|---|---|----------------|
|  | EU declaration of conformity for CTS3000 <ul style="list-style-type: none"> ■ EMC directive ■ RoHS directive | European Union |

Approvals and certificates, see website

Dimensions in mm (in)

Model CTS3000

Desktop case

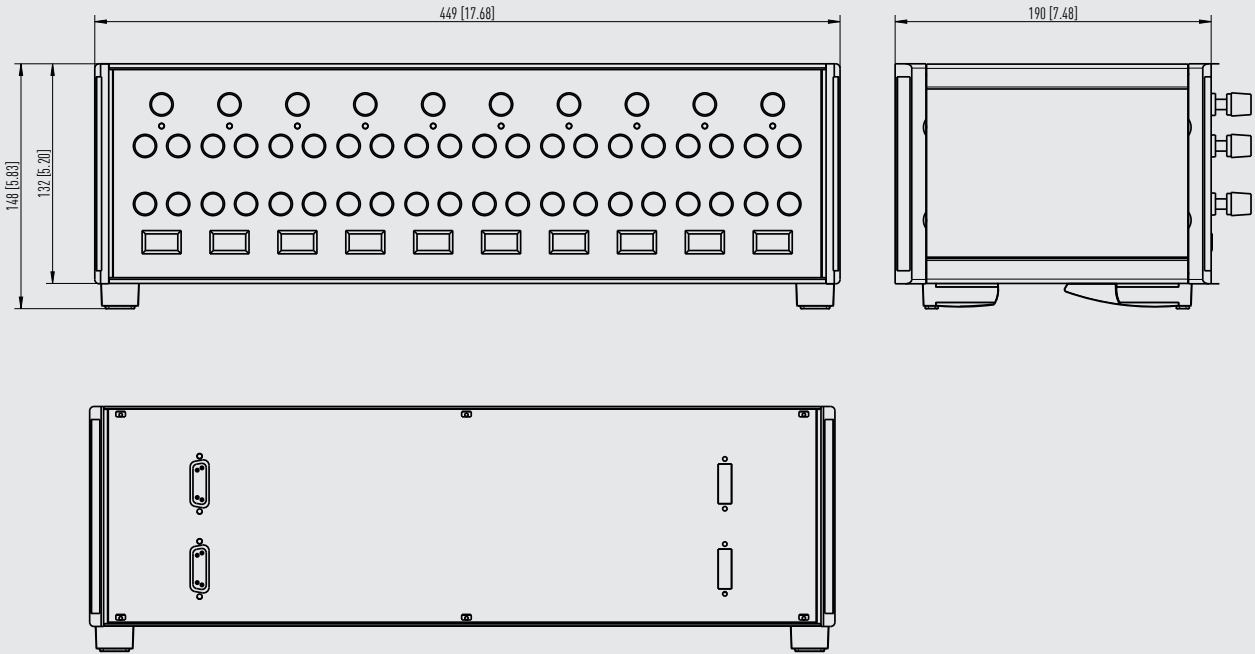

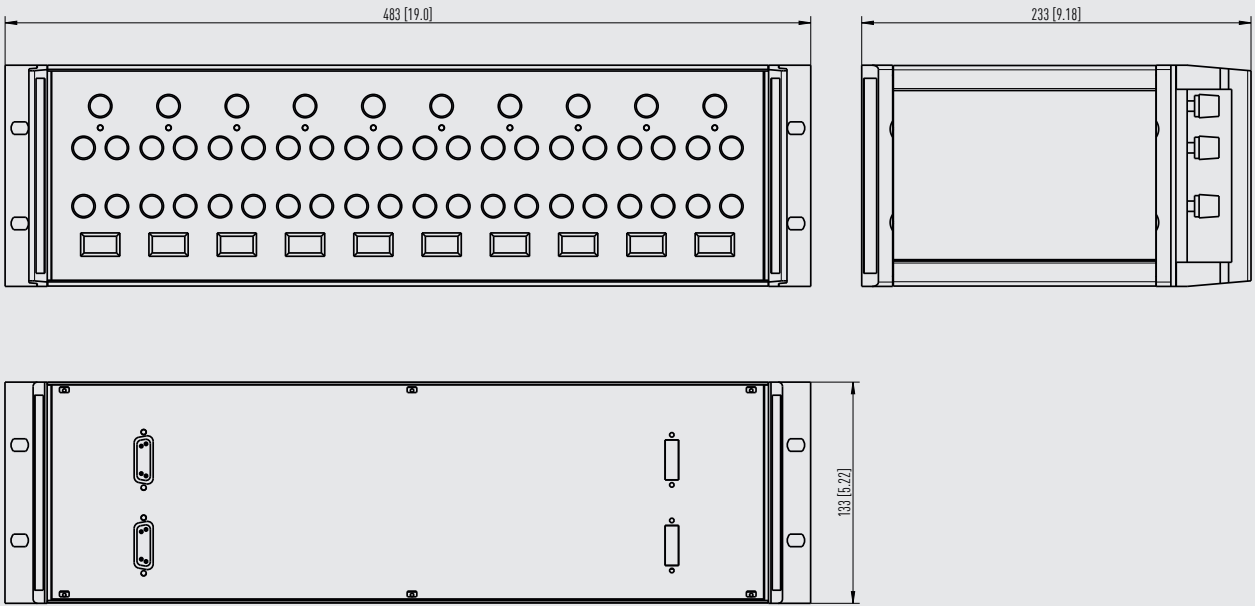

Built-in case for 19" rack

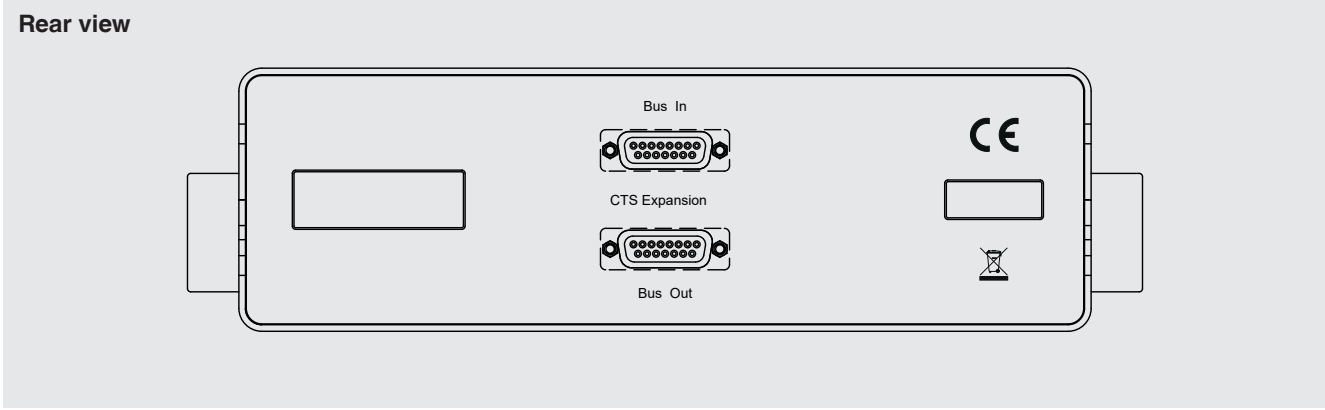
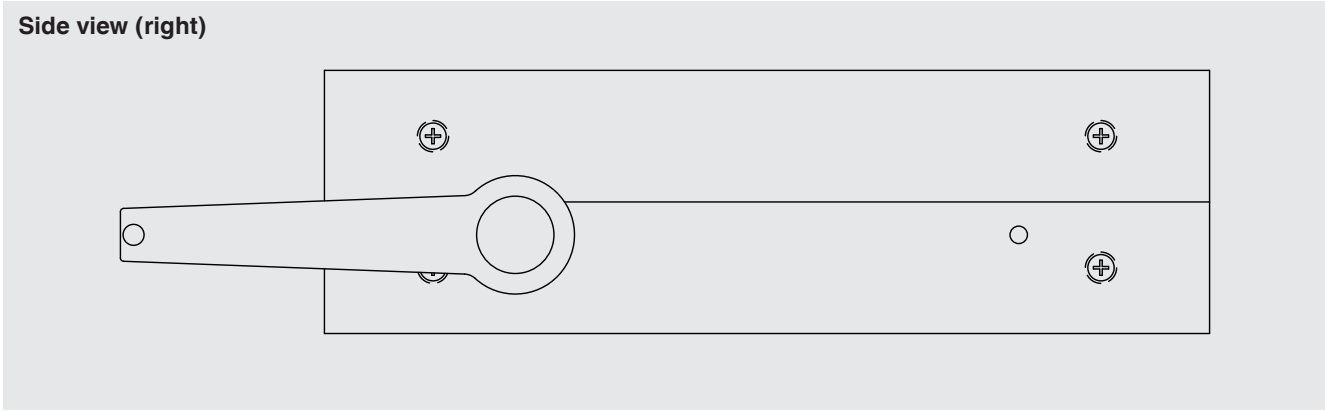
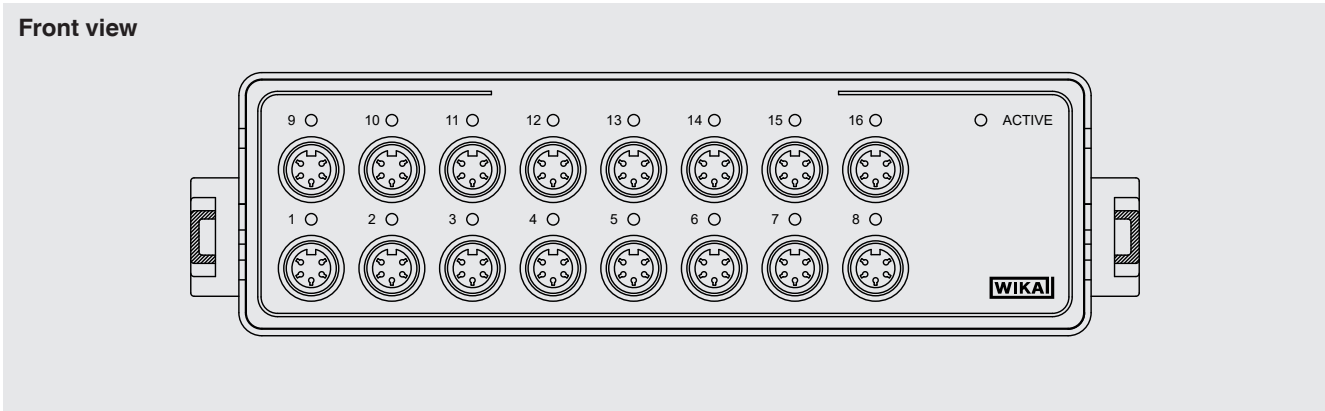



Accessories

| | | Order code |
|---|--|------------|
|  | Temperature probe model CTP5000 Immersion probe | CTP5000 |
|  | Thermocouple model CTP9000 Immersion probe type S With or without cold junction | CTP9000 |

Scope of delivery

- Multiplexer model CTS3000 or multiplexer model CTS5000
- Connection cable to measuring instrument



Multiplexer model CTS3000 in built-in case for 19" rack

Option

CTS3000

- Desktop case
- 19" rack

CTS5000

- 8-channel version
- 16-channel version



**Multiplexer model CTS5000 with CTR5000
Version: 16 channels**

© 03/2019 WIKA Alexander Wiegand SE & Co. KG, all rights reserved.
The specifications given in this document represent the state of engineering at the time of publishing.
We reserve the right to make modifications to the specifications and materials.

