



MCT105

Cable Tracer and Fault Locator

User Guide

This document is copyright of:

Megger Limited, Archcliffe Road, Dover, Kent CT17 9EN. ENGLAND
T +44 (0)1304 502101 F +44 (0)1304 207342 www.megger.com

Megger Ltd reserves the right to alter the specification of its products from time to time without notice. Although every effort is made to ensure the accuracy of the information contained within this document it is not warranted or represented by Megger Ltd. to be a complete and up - to - date description.

For Patent information about this instrument refer to the following web site:
megger.com/patents

This manual supersedes all previous issues of this manual. Please ensure that you are using the most recent issue of this document. Destroy any copies that are of an older issue.

Declaration of Conformity

Hereby, Megger Instruments Limited declares that radio equipment manufactured by Megger Instruments Limited described in this user guide is in compliance with Directive 2014/53/EU. Other equipment manufactured by Megger Instruments Limited described in this user guide is in compliance with Directives 2014/30/EU and 2014/35/EU where they apply.

The full text of Megger Instruments EU declarations of conformity are available at the following internet address:
megger.com/company/about-us/eu-dofc

1. Introduction

1.1 Product description

The Megger MCT105 Cable Tracer and Fault Locator kit consists of a transmitter, receiver and ancillary leads. It is designed to trace and aid fault location in cables, circuits or metallic conductors, such as pipes.

The signal produced by the transmitter is a modulated current, generating an electro-magnetic field around the conductor. This field induces a voltage within the receiving coil. The induced voltage is measured, amplified, decoded and converted to the original signal by the receiver, with the result finally displayed on the screen as a simple signal strength.

1.2 Features

- Tracing cables and conductors in walls
- Identify cable and conductor interruptions (open-circuits) or short-circuit faults
- Cable and conductor tracing in the soil
- Identify fuses and circuit breakers within distribution boards
- Detecting interruptions and short-circuits in floor heating
- Tracing metallic water and heating piping
- Transmitter display indicates signal level, the transmission code, as well as any voltage detected on the output terminals
- Receiver display indicates the signal strength, the transmission code, as well as the presence of mains voltage
- Automatic and manual sensitivity adjustment
- Variable tone audible signal level on the receiver (may be switched off)
- Auto-Power-Off function
- Backlight on both transmitter and receiver displays
- Torch function when working under bad lighting conditions

1.3 Company web site

Occasionally an information bulletin may be issued via the Megger web site. This may concern new accessories, new usage instructions or a software update. Please occasionally check on the Megger web site for anything applicable to your Megger instruments.

www.megger.com

2. Safety Warnings and Standards

2.1 Warnings, cautions and notes







This user guide follows the internationally recognised definition. These instructions must be adhered to at all times.

Description

WARNING : Indicates a potentially dangerous situation which, if ignored, could lead to death, serious injury or health problems.

CAUTION : Indicates a situation which could lead to damage of the equipment or environment

NOTE : Indicates important instructions to be followed to perform the relevant process safely and efficiently.

| Icon | Description |
|---|---|
|  | Warning: High Voltage, risk of electric shock This WARNING symbol indicates a potentially hazardous situation, which if not avoided, could result in death or serious injury, or result in damage to the product. |
|  | Caution: Refer to user guide. The respective accident prevention regulations established by the associations for electrical systems and equipment must be strictly met at all times. |
|  | UK conformity. This equipment complies with current UK legislation |
|  | EU conformity. Equipment complies with current EU directives. Comply with EMC. |
|  | Do not dispose of in the normal waste stream. |
|  | Battery symbol |
| CAT III | IEC Overvoltage Category CAT III equipment is designed to protect against transients in equipment in fixed equipment installations, such as distribution panels, feeders and short branch circuits, and lighting systems in large buildings. |
|  | Double insulated |

2.2 Safety warnings

- Prior to operation, check that the transmitter, receiver and any connection cables are in good condition and not damaged. The meter must not be used if any damage is identified, Contact Megger for repair.
- The Cable Locator may only be used on systems complying with the nominal voltages indicated in the technical data section.
- Prior to use, ensure the instrument is functioning correctly, as described within this manual. Always connect the transmitter line terminal first and then the neutral.
- The “-” earth/neutral terminal of the transmitter must always be connected to the conductor under test before the “+” line terminal.
- If the RCD/RCBO protecting the circuit under test trips on connection of the transmitter, this indicates that a fault current is already present within the circuit.
- If the instrument is subjected to a high electro-magnetic field, this may impede the functionality of the instrument.
- User safety cannot be insured if the instrument:
 - Shows obvious signs of damage
 - Is not functioning correctly. The instrument should be removed from service and the fault investigated
 - Has been stored for too long under unfavourable conditions
 - Has been subjected to excessive heat or mechanical stress during transport or storage

All relevant local statutory regulations must be adhered to when using this instrument

2.2.1 Installation category definitions:

CAT IV - Measurement category IV: Equipment connected between the origin of the low-voltage mains supply and distribution panel.

CAT III -Measurement category III: Equipment connected between the distribution panel and electrical outlets.

CAT II - Measurement category II: Equipment connected between the electrical outlets and user's equipment.

Measurement equipment may be safely connected to circuits at the marked rating or lower. The connection rating is that of the lowest rated component in the measurement circuit.

3. Instrument Overview

3.1 Transmitter layout

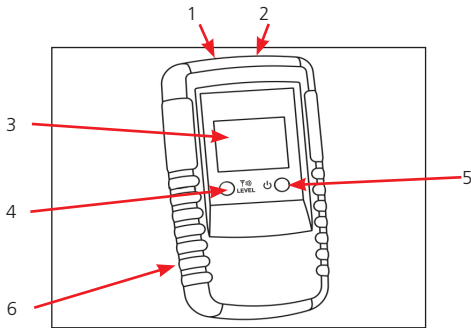

| Item | Description | Item | Description |
|------|-------------------------------|------|-------------------------------|
| 1 | Terminal: "+" (line) | 4 | Sensitivity level / backlight |
| 2 | Terminal: "-" (earth/neutral) | 5 | Power button |
| 3 | LCD | 6 | Battery case |

3.2 Transmitter display

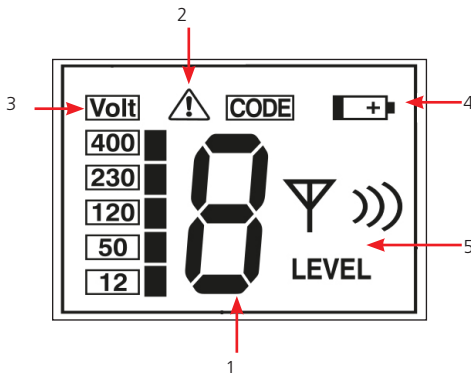

| Item | Description | Item | Description |
|------|---|------|--|
| 1 | Transmitted code (1,2,3,4,5,6,7) | 4 | Low battery indication |
| 2 | External voltage detected | 5 | Transmitted level display (I, II or III) |
| 3 | External voltage level (12 V, 50 V, 120 V, 230 V, 400 V) | | |

Instrument Overview

3.3 Transmitter: Fuse protection

The built-in fuses protect the instrument against overload or incorrect operation. Fuse replacement can only be undertaken by Megger or an approved service center.

If the transmitter signal appears weak, check for fuse failure using the following method:

- Disconnect the transmitter from all connected measurement circuits.
- Switch on the transmitter.
- Set transmission level I.
- Connect a single lead to the red terminal of the transmitter.
- Switch on the receiver. Search for the signal by placing the sensor head on the cable.
- Insert the other end of the cable in the black transmitter terminal and check the received signal increases accordingly. If the signal remains the same, one of the internal fuses will require replacement.

3.4 Receiver layout

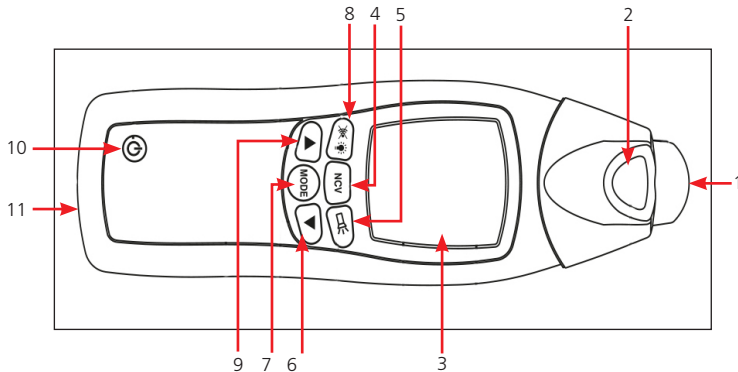

| Item | Description | Item | Description |
|------|---|------|--|
| 1 | Sensor head | 7 | Mode button Select automatic or manual mode |
| 2 | Torch | 8 | Backlight / Beeper ON/OFF button |
| 3 | LCD display | 9 | Upward selection Press to manually increase sensitivity |
| 4 | NCV button (Non-contact voltage detection) to select between cable locator mode and mains voltage detection mode | 10 | Power ON/OFF button |
| 5 | Torch button | 11 | Battery compartment (on rear) |
| 6 | Downward selection Press to manually reduce sensitivity | | |

3.5 Receiver display

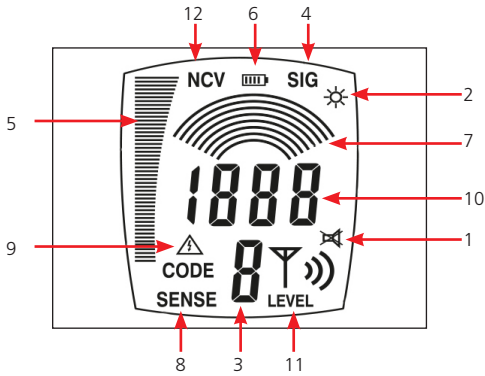

| Item | Description | Item | Description |
|------|--|------|---|
| 1 | Acoustic signal (ON/OFF) | 7 | Manual mode sensitivity indicator: 1 arc - low sensitivity 8 arcs - high sensitivity User selectable using up and down arrow buttons |
| 2 | Torch ON/OFF indication | 8 | The manual mode active indicator |
| 3 | Transmitter signal code | 9 | Mains voltage indicator (NCV mode) |
| 4 | Automatic signal mode active indicator | 10 | Signal intensity digital display |
| 5 | Signal strength bar-graph | 11 | Transmitter signal level (1 to 3) |
| 6 | Battery level | 12 | Non-contact voltage mode active |

4. Operation

4.1 Cable locator mode

4.1.1 Automatic mode

Automatic mode is active when the transmitter is first turned on. "SIG" is shown on the display.

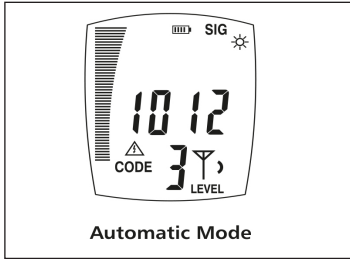

4.1.2 Manual mode

Press the mode button to select manual mode.

When the manual mode is selected the symbol "SENSE" is displayed.

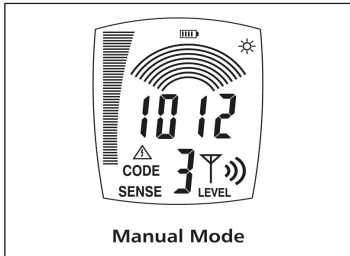

4.1.3 AC Non-Contact Voltage (NCV) detection mode

Press the NCV button to switch between cable locator mode and non-contact voltage detection mode

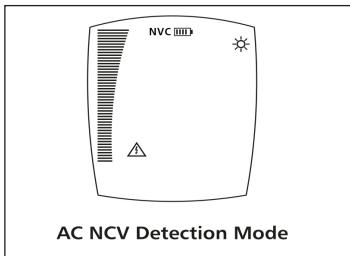

5. Operating Principle

The Cable Locator consists of a transmitter and a receiver. It is a portable instrument that can be used to detect or trace conductors.

The signal generated by the transmitter is made of a modulated current, generating an electro-magnetic field around a conductor. See figure 1. This electro-magnetic field induces a voltage within the receiving coil. The induced voltage is amplified, decoded and converted to the original signal by the receiver and displayed on the screen. The process operates on the principle of a closed current circuit.

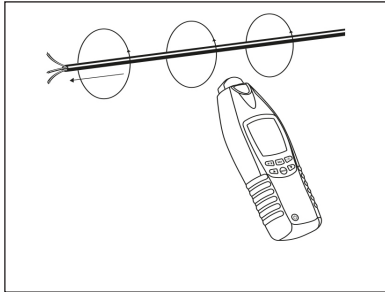

Figure 1:

5.1 Location in complete circuits

5.1.1 Single pole method

Connect the transmitter to only one conductor. In this operational mode, the transmitter signal is generated by the internal battery. Due to the high-frequency signal generated by the transmitter, only one single conductor can be located and traced. The second conductor is the earth. This arrangement causes a high frequency current to flow through the conductor and to be transmitted to earth, similar to a radio and receiver.

5.1.2 Double pole “live” method:

Connect the transmitter to the line and neutral conductors using both leads, ensuring correct polarity. The transmitter power is drawn from the connected voltage supply. Using this method, the modulated current flows through the phase into the transformer and back through neutral.

5.1.3 Double pole “dead” connection

A further option for testing “dead” or isolated systems is to terminate the transmitter to two line or neutral cables and connect these together at the far end to make a complete circuit. In this mode, the transmitted signal is generated by the internal battery. Then, the transmitter is supplied by the built-in battery.

NOTE : The Cable Locator can only detect or locate cables, which are connected correctly.

5.2 Single pole method (In open circuits)

5.2.1 Cable interruptions in walls and floors.

Finding and tracing cables, sockets, junction box, switches, pipes etc.

Operating Principle

The black “common” terminal of the transmitter must be connected to a suitable earth (Figure 2). Tracing is possible up to a depth of 20 cm using this method, depending on the material through which the transmitted signal and the receiver must travel.

5.3 Double pole method (In complete circuits)

Detecting short-circuits or identifying individual conductors, switches or sockets on circuits with or without voltage. Both transmitter connections are required (Figure 2 and 3).

Tracing is possible up to a depth of 50 cm using this method, depending on the material through which the transmitted signal and the receiver must travel.

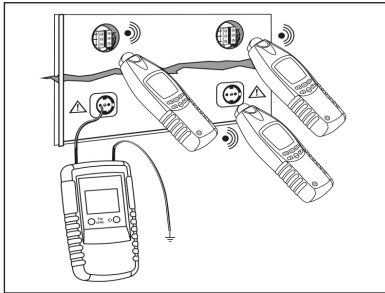

Figure 2:

NOTE : Maximum tracing depth 50 cm

WARNING : Care must be taken when making any connection to live or potentially live circuits. Correct safety procedures must be followed.

NOTE : Switching sensitivity between Level 1 and Level 3 increases the sensitivity by a factor of 5.

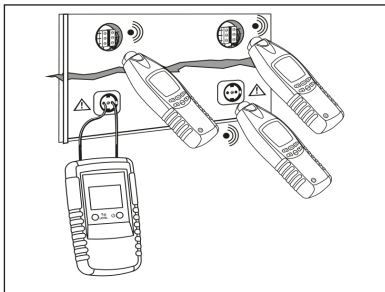

Figure 3:

5.4 Locating and tracing of cables, circuit branches, sockets, switches and junctions in house installations circuits (single-pole method)

When tracing cables or locating switches, sockets, junction boxes etc. the circuit must be isolated (dead). The circuit must be wired correctly and operational before isolation. Connect the transmitter "red" terminal to the line and neutral conductor simultaneously and the "black" terminal to earth (Figure 4). Route tracing and accessory location is now possible.

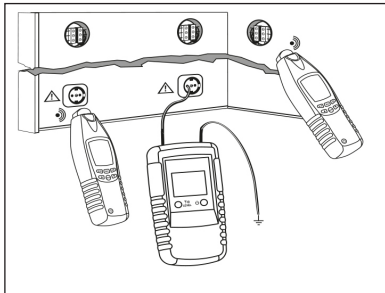

Figure 4:

NOTE : If the supply cable fed with the signal via the transmitter is running in parallel to other conductors (e.g. a cable duct), or if any conductors are crossed, the signal may be induced into these conductors. If this occurs, the fuse for any supplementary conductors should be removed to avoid mis-identification.

NOTE : Switching sensitivity between Level 1 and Level 3 increases the sensitivity by a factor of 5.

Setup: manual mode, minimal sensitivity. Maximum tracing depth 2.0 m

5.5 Locating of cable interruptions in the plastic-sheathed cable (single-pole method)

When locating of line interruptions, the circuit must be dead; All lines which are not required must be connected to the auxiliary ground as shown in figure 8. When pin-pointing cable interruptions, the circuit must be isolated (dead). All cables that are not required should be connected to earth, as shown in Figure 5. Connect the "red" transmitter to the cable to be traced and the "black" lead to one of the cables connected to ground. Route and accessory tracing using the receiver is now possible.

NOTE : All remaining conductors in a plastic sheathed cable must be earthed. This is to avoid inducing the signal into the surrounding conductors.

The tracing depth of sheathed cables and conductors is different due to the individual cores being twisted around each other. To pin-point an interruption, a resistance greater than 100 K Ω must be present. Verification of the resistance can be made using a simple multimeter.

Operating Principle

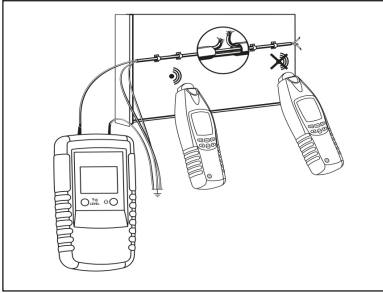

Figure 5:

NOTE : Switching sensitivity between Level 1 and Level 3 increases the sensitivity by a factor of 5.

Maximum tracing depth 2.0 m.

5.6 Locating of line interruptions using two transmitters (single-pole method)

When locating a interruption using a single transmitter from one end of the conductor, precise location may not be possible in the event of field disturbance on a cable. This can be overcome by using a second transmitter (available separately) connected to the other end of the cable. In this scenario, each transmitter is set to a different transmission code (e.g. Code 1 and Code 2).

If the two transmitters are connected as shown in Figure 6, the receiver will indicate "1" to the left of the interruptions; and "2" on the right. As the receiver reaches the interruption, no line code will be displayed due to the overlapping of the two transmitter signals.

5.6.1 Requirements:

- The circuit under test must be isolated (dead).
- All cables not being used must be connected to earth, as shown.
- Both transmitters must be connected exactly as shown.
- The interruption is shown at the point the receiver has no transmitter code visible.

The earthed connections must be connected to a known earth, either on an existing circuit or any earthed metalwork such as a water pipe.

Make sure during interruption locating in multi-wire shielded conductors and cables, that all remaining cables are connected to earth. This is required to avoid inductive disturbance. (Figure 6)

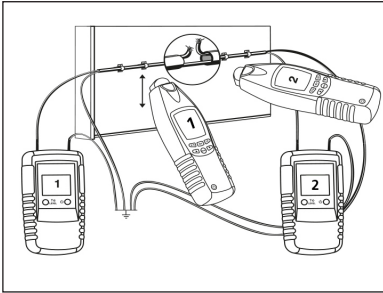

Figure 6:

The tracing depth of sheathed cables and conductors is different due to the individual cores being twisted around each other. To pin-point an interruption, a resistance greater than 100 k Ω must be present. Verification of the resistance can be made using a simple multimeter.

NOTE : Switching sensitivity between Level 1 and Level 3 increases the sensitivity by a factor of 5.

Setup: manual mode, minimal sensitivity. Maximum tracing depth 2.0 m.

5.7 Error detection in electrical under-floor heating (single-pole method)

The connection conditions:

- If a shield mat or shield wiring is located above the heating cables, no earth connection may exist. If required, separate the shield from the earth connection.
- Switching sensitivity between Level 1 and Level 3 increases the sensitivity by a factor of 5.
- A second transmitter is required for this application. (Figure 7)
- Setup: manual mode, minimal sensitivity. Maximum tracing depth 2.0 m.

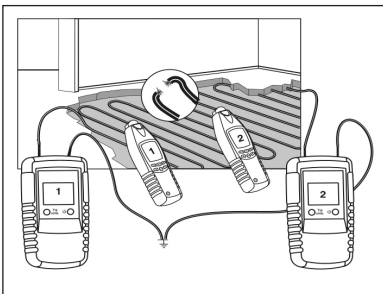

Figure 7:

5.8 Locating of bottlenecks (obstructions) in installation pipes (single-pole method)

When locating of bottlenecks in installation pipes, All circuits in the pipe must be dead, isolated and earthed. Connect transmitter to the metal coil and auxiliary earth as shown in figure 8.

Operating Principle

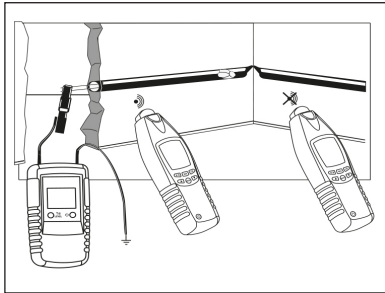

Figure 8:

NOTE : If you only have a non-conducting coil it is recommended you slide a cable up to the obstruction in the pipework.

NOTE : Switching sensitivity between Level 1 and Level 3 increases the sensitivity by a factor of 5.

Setup: manual mode, minimal sensitivity. Maximum tracing depth 2.0 m.

5.9 Fuse Location (double-pole method)

WARNING : Care must be taken when making any connection to live or potentially live circuits. Correct safety procedures must be followed.

Connect the “red” transmitter terminal to the line conductor and the “black” terminal to the neutral conductor of the circuit. Ensure the transmitter is set on level one (single bar).

Precise fuse location within the distribution board will depend upon the condition and routing of the wiring. By setting the transmitter at level one (single bar-graph) the possibility of induced signals in other circuits is reduced. If safe to do so, the board cover can be removed to allow exact cable identification made at the fuse termination (figure 9).

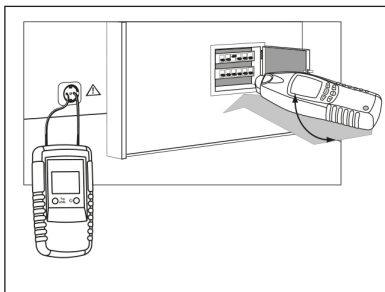

Figure 9:

NOTE : Set transmitter to LEVEL I

NOTE : Switching sensitivity between Level 1 and Level 3 increases the sensitivity by a factor of 5.

Manufacturers of safety cut-outs and breakers have different installation positions of the magnetic sensing coil. If no clear signal can be pin-pointed, it is recommended that the receiver head is rotated by 90° either left or right.

5.10 Locating of short-circuits in conductors (double-pole method)

When locating short-circuits in conductors, any existing circuits within the cable must be voltage-free. Connect the transmitter as shown in Figure 10; and carry out this example as described in the application example.

NOTE : The tracing depth for sheathed cable and conductors are different due to the fact that the individual leads in the sheathed cable are twisted around themselves. Usually, short-circuits can only be correctly detected when the short-circuit resistance is lower than 20 Ohm. The verification of the short-circuit resistance can be carried out with any multimeter.

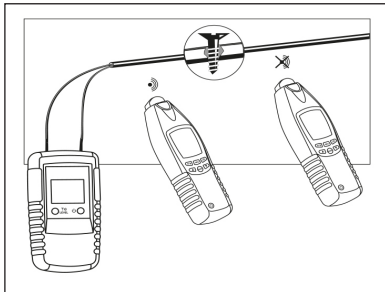

Figure 10:

Should the short-circuit resistance amount to more than 20 Ohm, it may still be possible to detect it using the line interruption method. Different transmitter signals may also provide an accurate location.

NOTE : Switching sensitivity between Level 1 and Level 3 increases the sensitivity by a factor of 5.

Setup: manual mode, minimal sensitivity. Maximum tracing depth 0.5 m

5.11 Tracing installed water and heating pipes (single-pole method)

NOTE : The tracing conditions: The pipe to be located must be separated from the equipotential bonding.

WARNING : For safety reasons the circuit must be switched off and isolated as per local regulations.

Connect the transmitter “red” terminal to the pipe or conductor to be traced. The “black” terminal must be connected to the Main Earth terminal. (Figure 11)

NOTE : Switching sensitivity between Level 1 and Level 3 increases the sensitivity by a factor of 5.

Setup: manual mode, minimal sensitivity. Maximum tracing depth 2.0 m.

Operating Principle

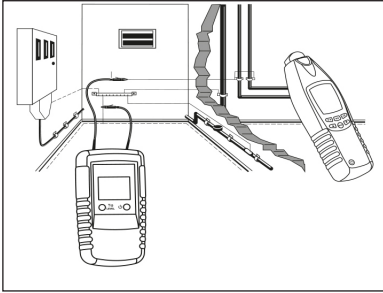

Figure 11:

5.12 Detecting the direction of water and heating pipes already installed (Single-pole method)

When detecting the direction of water and heating pipes already installed, the respective water and heating pipes must be suitably earthed connect the transmitter, as shown in figure 12.

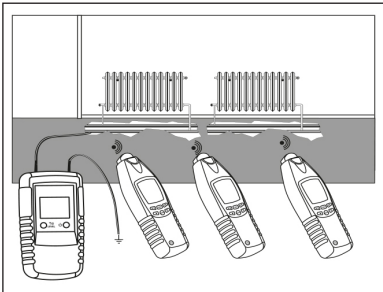

Figure 12:

NOTE : Switching sensitivity between Level 1 and Level 3 increases the sensitivity by a factor of 5.

Setup: manual mode, minimal sensitivity. Maximum tracing depth 2.5 m.

5.13 Locating a complete house wiring (Single-pole method)

This method allows all circuits within an installation to be traced:

1. Turn off and isolate the supply in accordance with local regulations.
2. If applicable, remove the PE - N bridge within the distribution board.
3. Connect the transmitter "red" terminal to the Neutral bar and the "black" terminal to the Main Earthing Terminal (figure 13). This will allow the neutral conductor of all circuits to be traced.

WARNING : For safety reasons the circuit must be switched off and isolated as per local regulations.

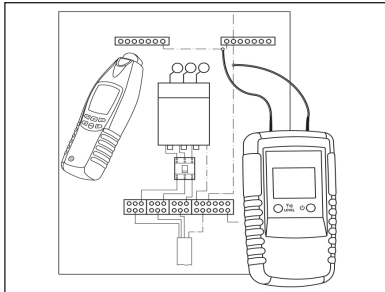

Figure 13:

NOTE : Switching sensitivity between Level 1 and Level 3 increases the sensitivity by a factor of 5.

Setup: manual mode, minimal sensitivity. Maximum tracing depth 2.0 m

5.14 Following lines with higher location depth (Double-pole method)

If the double-pole method is used on multi-core cables, the location depth is limited. This is because the signal injection and return lines are installed close together, causing a distortion of the magnetic field. To overcome this limitation, a second, separate conductor may be used as the return line. Any conductor outside the multi-core cable, or a separate cable reel can be used.

When tracing the conductors, special care must be taken to ensure the distance between injection and return line is larger than the location depth. In practical applications, this amounts to approx. 2.0 m.

- The circuit under test must not be live
- Connect the transmitter as shown in figure 14.
- The distance between injection and return line must be 2.0 m or more.

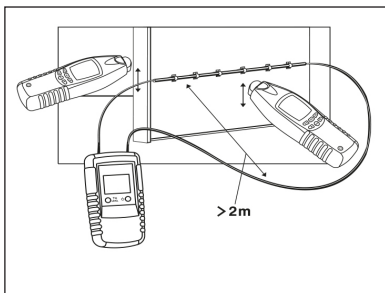

Figure 14:

NOTE : Switching sensitivity between Level 1 and Level 3 increases the sensitivity by a factor of 5.

Setup: manual mode, minimal sensitivity. Maximum tracing depth 2.5 m.

Operating Principle

5.15 Tracing conductors within the soil (single-pole method)

The transmitter should be connected as shown in Figure 15.

WARNING : Ensure the circuit is switched off and isolated (dead).

Ensure the distance between the connection to the conductor and earth is greater than 2.0 m. If the distance is too small it becomes impossible to accurately identify and trace the injected signal.

The maximum tracing depth is 2.0 m. This is reduced depending upon the characteristics of the soil the cable or conductor is buried in.

- Set the receiver to automatic mode.
- Trace the conductor using the signal intensity display. Circle the receiver slowly across the conductor and watch for the display values to change. When the display shows the maximum signal intensity the receiver is directly over the conductor.

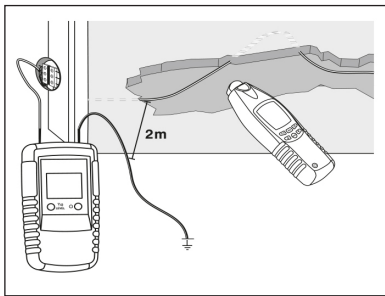

Figure 15:

The signal intensity level will decrease as the distance from the transmitter increases.

5.16 The detection range can be increased by connecting to Live conductors

If the transmitter is attached to the line and neutral, the signal will be reduced as the feed and return cables running side by side cancel each other out (as shown in figure 16).

If the cores are twisted, this can lead to a further reduction in the transmitted signal.

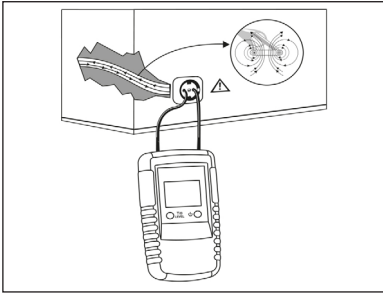

Figure 16:

In order to prevent these effects the connection should be carried out as shown in figure 17. The return path is supplied by a separate cable. The distance in voltage circuits will be up to 2.5 meters.

Make sure there is sufficient distance between the cable under test and the external lead to prevent interference between the two.

WARNING : Care must be taken when making any connection to live or potentially live circuits. Correct safety procedures must be followed.

NOTE : Switching sensitivity between Level 1 and Level 3 increases the sensitivity by a factor of 5.

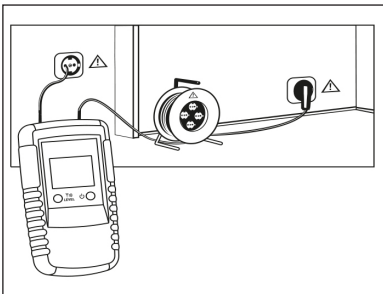

Figure 17:

5.17 Identifying multiple installed conductors (double-pole method)

When identifying multiple installed conductors, each conductor must be isolated and not carrying any voltage. One end of the lead will require shorting together (as shown in Figure 18) If multiple transmitters are available, each transmitter should be set to a unique signal (1 - 7). Connect the transmitters as shown in figure 18.

Operating Principle

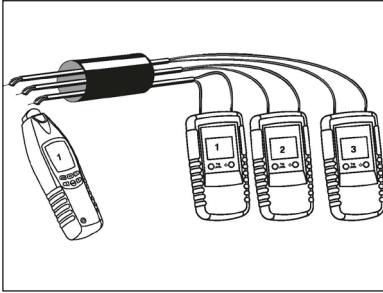

Figure 18:

NOTE : The stripped lead terminals must be twisted together to ensure a good electrical connection, as shown in Figure 18.

If only one transmitter be available, each pair should be identified individually, one at a time.

NOTE : Switching sensitivity between Level 1 and Level 3 increases the sensitivity by a factor of 5.

5.18 Non-contact voltage detection

- No transmitter is required for this application. (Figure 19)
- Select non-contact voltage mode by pressing the NVC button on the receiver, NCV should appear on the display.

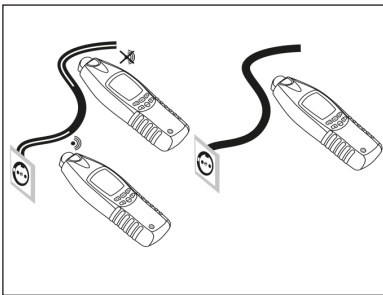

Figure 19:

The display bargraph indicates the signal intensity of a detected voltage. An audible tone is produced that changes in pitch as the proximity to the voltage is reduced.

WARNING : Although different signal intensities may indicate the presence and level of voltage, a dedicated voltage measurement instrument **MUST** be used to prove voltage value if required.

5.19 Setting the transmitter codes

1. Make sure that the transmitter is switched off before setting the codes.
2. Press and hold down the Level button, then press the power button. The current transmitter signal code is displayed, then press Power key to turn on the meter.
3. To select a different transmitter code, press the Level button to cycle through the available transmitter codes (1 - 7).
4. Once the required code is displayed, turn the transmitter off. The selected code will be remembered and used when next turned on.

5.20 Transmitter Flashlight

The flashlight located on the transmitter can be turned on and off by pressing the flashlight button. The flashlight turns off automatically after approximately 60 seconds to conserve battery life.

6. Maintenance

Do not attempt to repair this meter. It contains no user-serviceable parts. Repair or servicing should only be performed by qualified personnel.

Both the transmitter and receiver contain non-rechargeable batteries. On the receiver, the battery level indicator is shown permanently on the display. On the transmitter, the battery level is briefly shown when the unit is first turned on. When the battery symbol indicates the battery is depleted in either unit, the batteries must be replaced to avoid inaccurate or false readings.

6.1 Battery replacement

6.1.1 Receiver batteries

CAUTION : Ensure all test leads are removed and the instrument is switched off before opening the instrument case or battery cover.

1. Ensure receiver or transmitter is switched off and all transmitter leads are removed.
2. Using an appropriate tool, open and remove the battery cover on the rear of the instrument.
3. Remove used batteries
4. Insert new batteries taking care to ensure the polarity is correct
5. Close and secure the battery cover.
6. Check instrument operation and that the battery level indicators are at 100%.

To avoid damage, remove all batteries if the instrument is being stored for an extended length of time, prior to storing or replacing the battery, disconnect the instrument from any connected test leads.

Reverse polarity of batteries may damage the instrument. They may explode or ignite

Only use batteries as described in the specifications. (One 9 V battery , NEDA 1604, IE6F22. Power)

Consider your environment when you dispose of used batteries. In most cases, the batteries can be returned to their point of sale. Comply with the respective valid regulation regarding the return, recycling and disposal of used batteries, appropriate to your region.

If an instrument is not for over an extended time period, the batteries must be removed. Should the instrument be contaminated by leaking battery cells, the instrument must to be returned to Megger for cleaning and inspection.

6.2 Cleaning

Periodically wipe the case with a dry cloth and detergent, do not use abrasives or solvents

7. Specifications

| Specification | Detail |
|----------------------------|--|
| Transmitter: | |
| Output signal | 125 kHz |
| Voltage Range | 12 - 400 V |
| Frequency Range | 0 - 60 Hz |
| Display | LCD display |
| External Voltage Detection | max. 400 V AC/DC |
| Over Voltage Category | CAT III 300 V |
| Pollution Degree | 2 |
| Auto Power Off | approx. 1 hour (after last operation) |
| Power Supply | One 9 V battery, NEDA 1604, IEGF22. Power |
| Consumption | max. 18 mA |
| Fuse | F0.5 A 500 V, 6.3 x 32 mm |
| Operating temperature | 0 - 40 °C, max 80% rel. humidity (not condens.) |
| Storage temperature | -20 - 60 °C, max 80% rel. humidity (not condens.) |
| Altitude | up to 2000 m |
| Dimensions | 130 x 69 x 32 mm |
| Weight | approx. 130 g |
| Receiver: | |
| Tracing depth | The tracing depth depends of medium and application |
| Cable Locator Mode | approx. 0 - 2 m (single-pole application) approx. 0 - 0.5 m (double-pole application) |
| Voltage detection | approx. 0 - 0.4 m |
| Display | LCD with functions- and bar graph |
| Power Supply | One 9 V battery, NEDA 1604, IEGF22. Power |
| Consumption | approx. 23 mA (without backlight or lamp) approx. 35 mA (with backlight) max. 40 mA (Backlight and lamp) |
| Auto Power Off | approx. 5 minute (No any Operation) |
| Operating temperature | 0 - 40 °C, max 80% rel. humidity (not condens.) |
| Storage temperature | 20 - 60 °C, max 80% rel. humidity (not condens.) |
| Altitude | up to 2000 m. |
| Dimensions | 192 x 61 x 37 mm |
| Weight | approx. 180 g |

8. Warranty and repair

This meter is warranted to the original purchaser against defects in material and workmanship for 3 year from the date of purchase.

During this warranty period, the manufacturer will, at its option, replace or repair the defective unit, subject to verification of the defect or malfunction.

This warranty does not cover fuses, disposable batteries, or damage from abuse, neglect, accident, unauthorised repair, alteration, contamination, or abnormal conditions of operation or handling.

Any implied warranties arising out of the sale of this product, including but not limited to implied warranties of merchantability and fitness for a particular purpose, are limited to the above. The manufacturer shall not be liable for loss of use of the instrument or other incidental or consequential damages, expenses, or economic loss, or for any claim or claims for such damage, expense or economic loss. Some states or countries laws vary, so the above limitations or exclusions may not apply to you.

Megger Limited
Archcliffe Road
Dover
Kent
CT17 9EN

Tel: +44 (0) 1304 502 101
Fax: +44 (0) 1304 207 342

www.megger.com

9. Decommissioning

9.1 WEEE Directive

The crossed out wheeled bin symbol placed on Megger products is a reminder not to dispose of the product at the end of its life with general waste.

Megger is registered in the UK as a Producer of Electrical and Electronic Equipment. The Registration No is WEE/ HE0146QT.

For further information about disposal of the product consult your local Megger company or distributor or visit your local Megger website.

9.2 Battery disposal

The crossed out wheeled bin symbol placed on a battery is a reminder not to dispose of batteries with general waste when they reach the end of their usable life.

For disposal of batteries in other parts of the EU contact your local Megger branch or distributor.

Megger is registered in the UK as a producer of batteries (registration No.: BPRN00142).

For further information see www.megger.com

Local Sales office

Megger Limited
Archcliffe Road
Dover
Kent
CT17 9EN
ENGLAND
T. +44 (0)1 304 502101
F. +44 (0)1 304 207342

Manufacturing sites

Megger Limited
Archcliffe Road
Dover
Kent
CT17 9EN
ENGLAND
T. +44 (0)1 304 502101
F. +44 (0)1 304 207342

Megger GmbH
Weststraße 59
52074 Aachen
T. +49 (0) 241 91380 500
E. info@megger.de

Megger Valley Forge
400 Opportunity Way
Phoenixville,
PA 19460
USA
T. +1 610 676 8500
F. +1 610 676 8610

Megger USA - Dallas
4545 West Davis Street
Dallas TX 75237
USA
T. 800 723 2861 (USA only)
T. +1 214 333 3201
F. +1 214 331 7399
E. USsales@megger.com

Megger AB
Rinkebyvägen 19, Box 724,
SE-182 17
DANDERYD
T. +46 08 510 195 00
E. seinfo@megger.com

Megger USA - Fort Collins
4812 McMurry Avenue
Suite 100
Fort Collins CO 80525
USA
T. +1 970 282 1200

This instrument is manufactured in the United Kingdom.

The company reserves the right to change the specification or design without prior notice.

Megger is a registered trademark