

Keysight Technologies

E4982A LCR Meter

1 MHz to 300 MHz/500 MHz/1 GHz/3 GHz

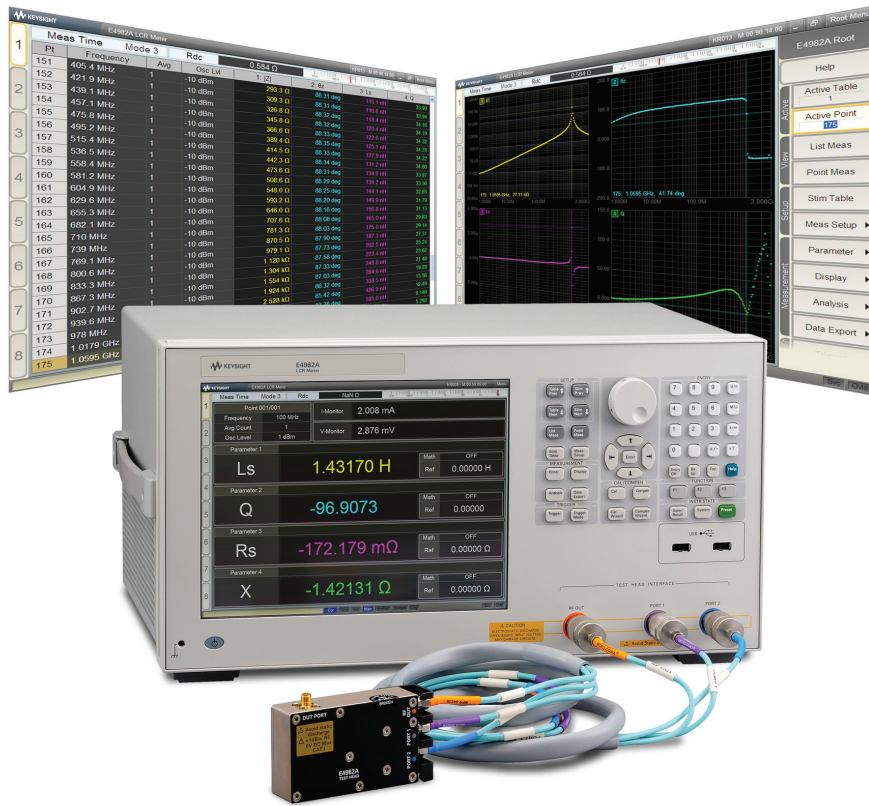

New Standard for High-Speed Component Tests

The Keysight E4982A LCR meter provides the best performance for the passive component manufacturing such as SMD inductors and EMI filters, where impedance testing at high frequencies is required. Not only for the manufacturing, E4982A can also be utilized for R&D, quality assurance with the powerful functions such as list measurements. By offering the unparalleled measurement speed and repeatability with excellent accuracy and impedance range, E4982A is the new standard for high-speed component tests.

- 1 MHz to 300 M, 500 M, 1 G, and 3 GHz
- Test head with 3.5 mm (female) connector
- Extension to an automated component handler without introducing additional errors
- 2 m (option 020) is available
- Frequency upgradeable

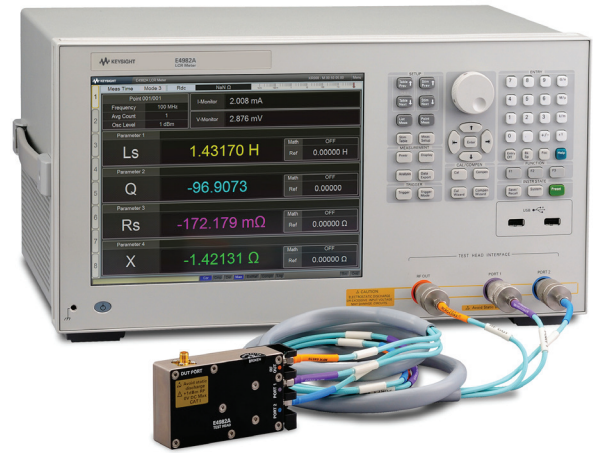

Small test head with 1 m test cable

Key Features

Unparalleled measurement speed & repeatability

- 0.9 ms/point (measurement time mode 1)
- 2.1 ms/point (measurement time mode 2)
- 3.7 ms/point (measurement time mode 3)
- Low variation for repeatability

Excellent accuracy & impedance range

- Basic accuracy: $\pm 0.8\%$ (typical $\pm 0.45\%$)
- Impedance range: 140 m Ω to 4.8 k Ω

Compatible to 4287A LCR meter

- SCPI commands
- Handler interface
- Test head size¹
- 7 mm test fixtures

Powerful functions

- Calibration/compensation with Wizard
- Rdc measurement for contact check
- Multi-function comparator & handler I/F
- Statistical analysis functions
- List measurement function
- User defined function keys/parameters
- Context sensitive embedded help

Modern U/I & connectivity

- 10.4 inch LCD touch screen
- GPIB/LAN/USB control interfaces
- Windows OS

Compact body

- 277 mm depth

Wide variety of accessories

- Various sizes for SMD
- External DC bias adapter

1. The test head of 4287A cannot be used with the E4982A

Modern User Interface & Connectivity in Compact Body

The Keysight E4982A LCR meter is developed on the latest platform, which provides the modern user interface and connectivity in compact body.

- Easy to use with 10.4 inch LCD touch screen and navigation keys in addition to keyboard and mouse
- PC connectivity via GPIB/LAN/USB control interfaces
- Windows OS
- Compact body (277 mm depth)

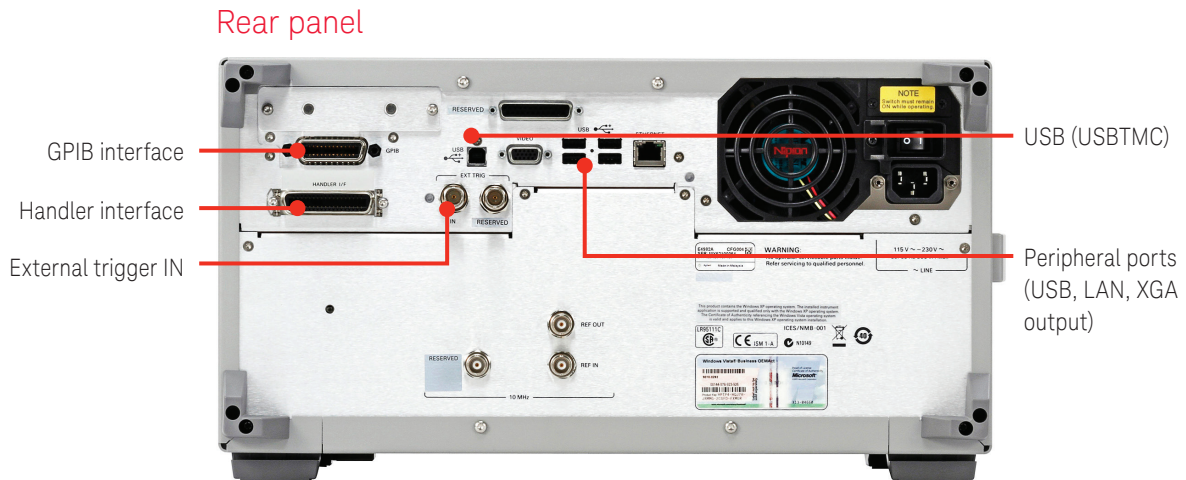
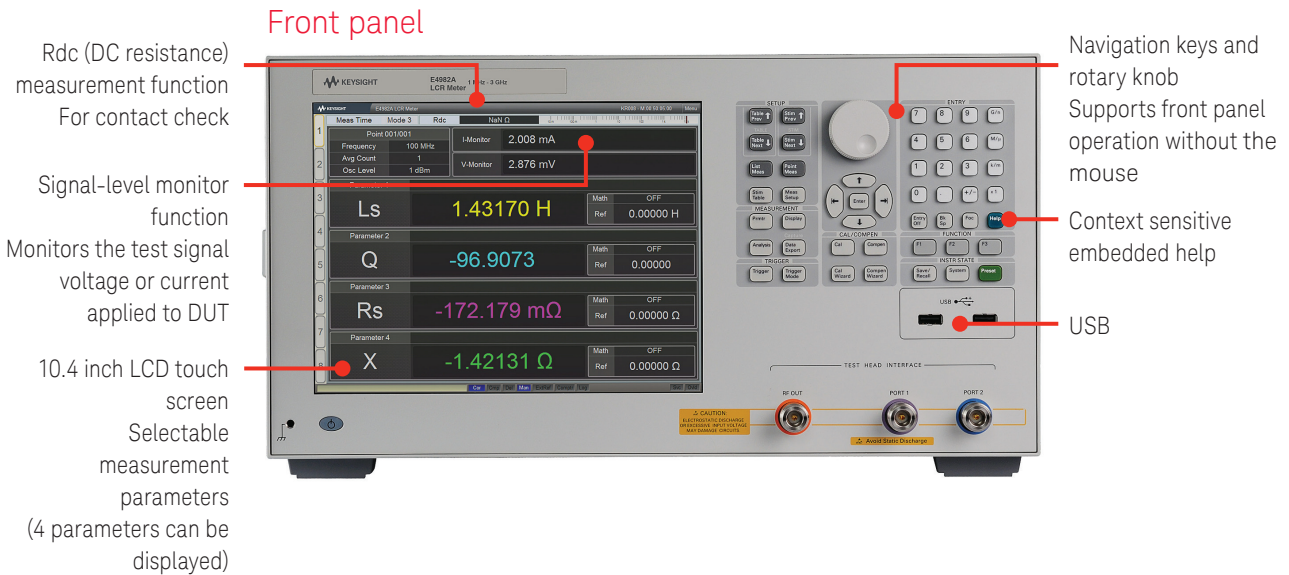
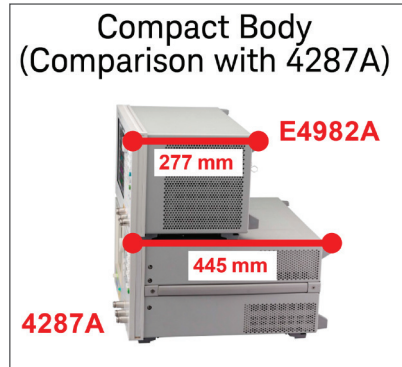

Unparalleled Measurement Speed & Repeatability

Faster measurement speed

The E4982A allows you to make much faster measurements compared to 4287A, which is widely used as the industry standard. This drastically helps improving the manufacturing throughput.

- 1.6 ms/point with mode 1 (< 20.3 MHz)
- 0.9 ms/point with mode 1 (\geq 20.3 MHz)
- 2.1 ms/point with mode 2
- 3.7 ms/point with mode 3 (Index signal)

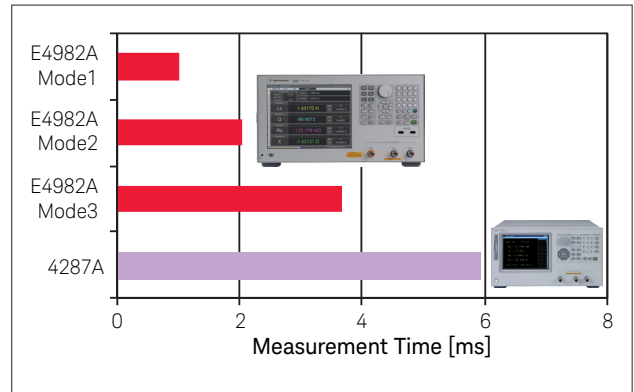

Measurement speed comparison

Lower measurement variation for better repeatability

The advanced techniques in the E4982A analog-circuit also provides even lower measurement variation than 4287A. By taking the lower measurement variation into consideration along with the measurement speed, the practical measurement speed at the equivalent measurement variation versus 4287A can drastically improve the measurement speed. This means that even smaller inductance can be measured while maximizing the manufacturing throughput.

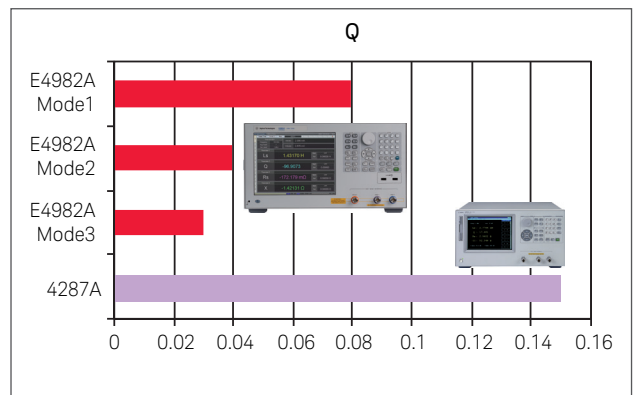
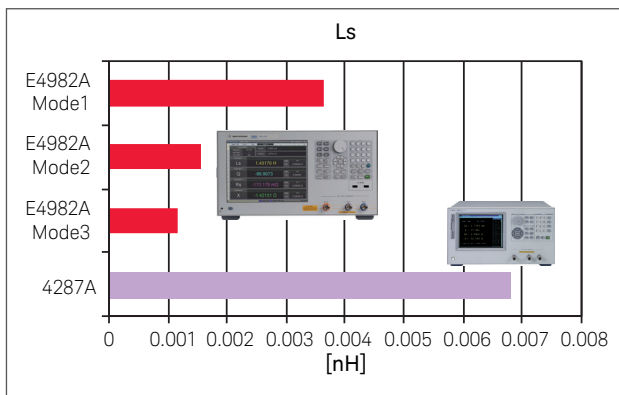

Measurement variation comparison (supplemental information)

DUT: 10 nH (Q = 15)
 Conditions: 100 MHz, 0.5 V, AVG 1,
 3 Sigma with 100 times measurements

Excellent Accuracy & Impedance Range

More accurate measurements over wider impedance range

The E4982A employs the RF-IV measurement method that measures voltage and current at device under test (DUT). The E4982A enables more accurate measurement over wide impedance range than that of network analyzer and also even 4287A, for a very small inductance on the order of a few nH, as an advantage.

	E4982A			4287A
	Mode 1	Mode 2	Mode 3	
Example of meas. accuracy $Z_x = 50 \Omega$ (at 100 MHz) ¹	± 0.85 %	± 0.82 %	± 0.80 %	± 1.02 %
Example of meas. accuracy $Z_x = 6.28 \Omega$ (10 nH) ²	± 1.58 %	± 1.55 %	± 1.52 %	± 1.79 %
Impedance measurement range (meas. accuracy $\leq \pm 10\%$) ³	0.16 Ω ~ 4.3 k Ω	0.14 Ω ~ 4.7 k Ω	0.14 Ω ~ 4.8 k Ω	0.20 Ω ~ 3.0 k Ω

1. Ave = 8, OSC = 1 dBm, calibration is performed (at 23 ± 5 °C)
2. Freq = 100 MHz, Ave = 8, OSC = 1 dBm, calibration is performed (at 23 ± 5 °C)
3. Freq = 1 MHz, Ave = 8, OSC = 1 dBm, calibration is performed (at 23 ± 5 °C)

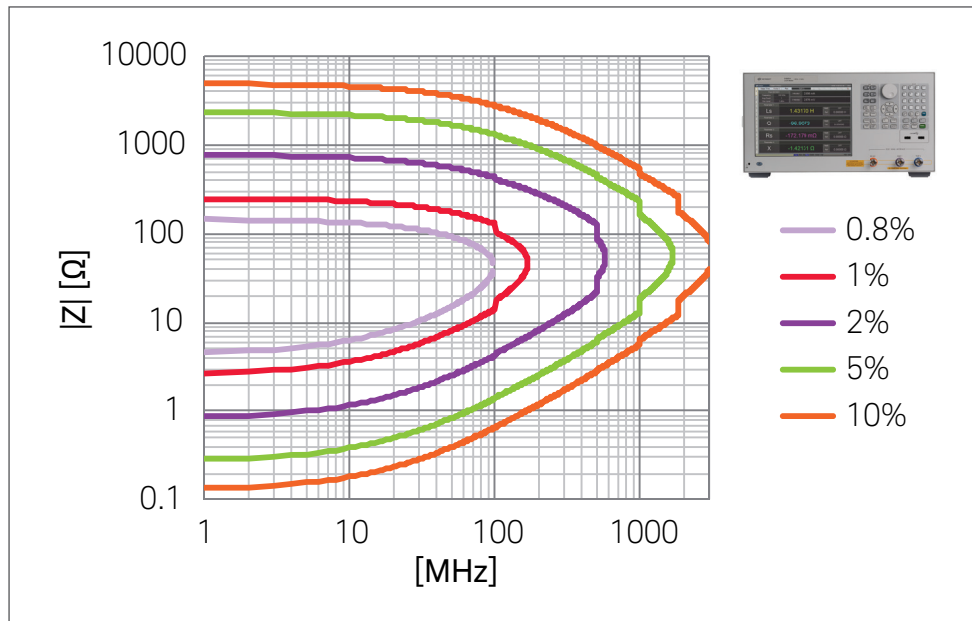

Examples of calculated impedance measurement accuracy
Meas. speed mode 3, osc. level 1 dBm, AVG ≥ 8 , temp (at 23 ± 5 °C)

Maximizing Throughput & Quality in Manufacturing

Accurate automated testing by calibration with different reference values

It is very important to eliminate complicated error elements caused by the use of test fixtures and cables that extend the test head of the E4982A. This is especially true for measurements that use an automated component handler. Accurate measurements, which correlate well with results obtained from manual testing, can be achieved at the measurement plane of a test fixture by performing open/short/load calibration with a “working” load standard.

Since different calibration standard reference values can be independently set at each list measurement frequency, multi-frequency measurements can be made accurately with this reliable calibration function.

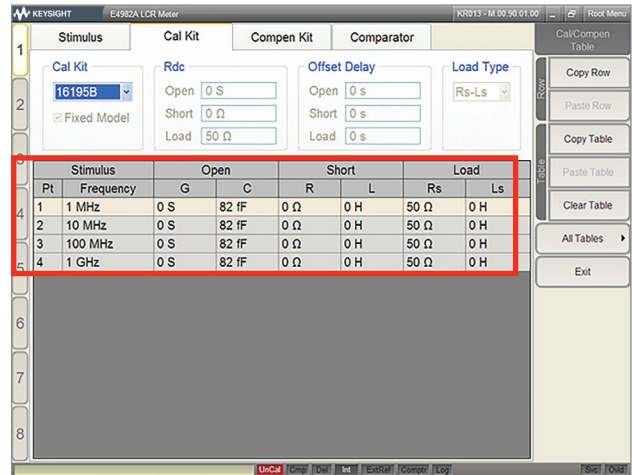

Calibration standard data setup display
Different calibration reference values can independently be set at each list measurement frequency

Contact check using the Rdc measurement function

Contact failure between a DUT and the measurement plane of an automatic component handler is a factor for bin sorting error in production line testing. Contact check using the built-in DC resistance measurement improves the accuracy and efficiency of bin sorting.

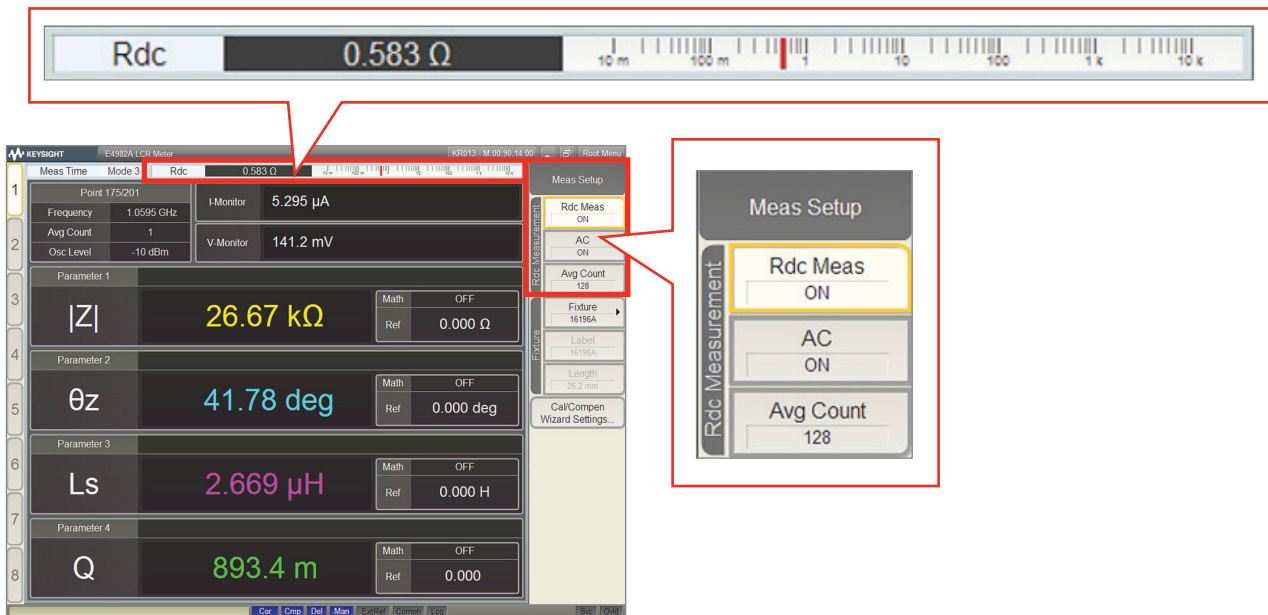

Rdc measurement

Interfacing with an automated component handler

The measurement plane can be extended from the front panel of the instrument to the measurement stage with the 1 m test cable and the small size test head. It is possible to extend the test cable an additional meter with a 1 m extension cable (option 020). Note that the measurement accuracy is specified at the test head. In addition, connection to an external computer or an automated component handler can be accomplished via the GPIB/LAN/USB interface and the opto-isolated handler interface. The LAN interface enables network communication, and greatly empowers massive data transfer to a remote computer.

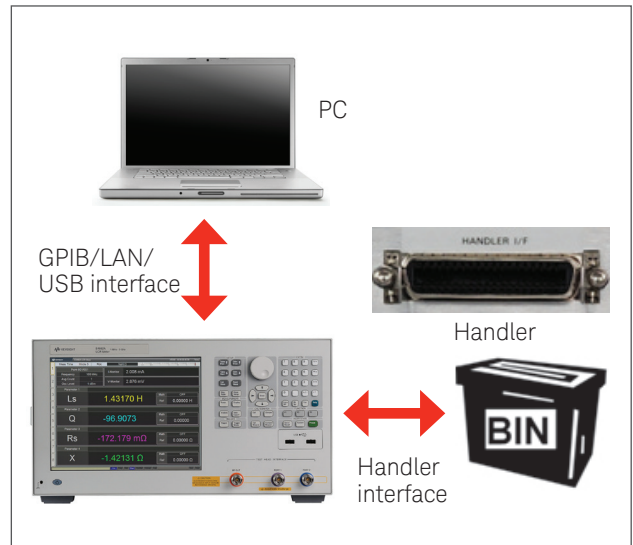

Multi-function comparator

The comparator setup display is formatted as a table. Each row represents a bin number, and each column represents the sorting conditions for each bin. When all sorting conditions set for a bin are satisfied, the judgment result is sorted to the bin. There are thirteen bins, with four limit values for each bin. Conditions such as frequency and measurement parameters can be set independently in each column, enabling the E4982A to meet various sorting needs, including different parameters at different measurement frequencies.

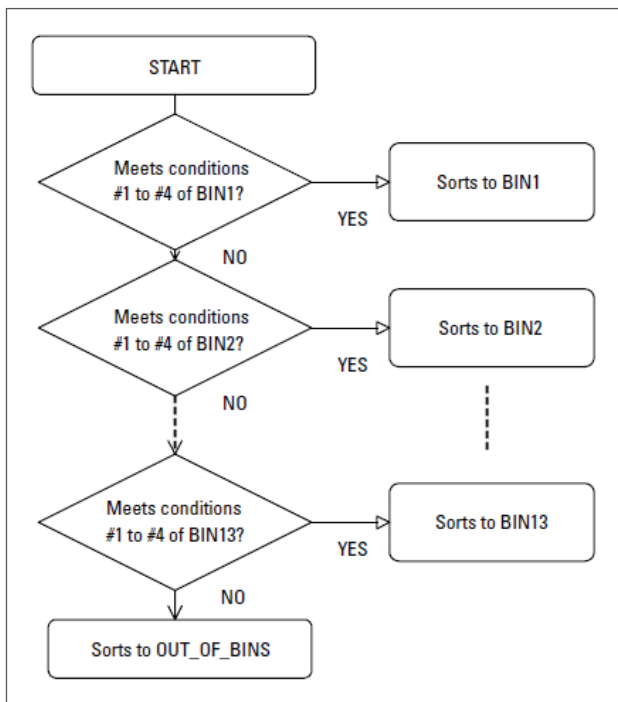

Bin-sort sequence

Stimulus	Cal Kit	Compen Kit	Comparator			
Rdc Limit	Stimulus	Condition 1	Condition 2	Condition 3	Condition 4	
Upper 10 kΩ	6	1	1	1	1	
Lower 0 Ω	Parameter	Ls [H]	θz [deg]	Rs [Ω]	X [Ω]	
Good Bins ~ Bin 10	Mode	%	Abs	Abs	Abs	
	Reference	50 H	0 deg	0 Ω	0 Ω	
Bin 1	Good Bin	Upper Limit +1 %	0 deg	0 Ω	0 Ω	
	ON	Lower Limit -1 %	0 deg	0 Ω	0 Ω	
	In/Out	In	All	All	All	
Bin 2	Good Bin	Upper Limit +0 %	0 deg	0 Ω	0 Ω	
	OFF	Lower Limit +0 %	0 deg	0 Ω	0 Ω	
	In/Out	All	All	All	All	
Bin 3	Good Bin	Upper Limit +0 %	0 deg	0 Ω	0 Ω	
	OFF	Lower Limit +0 %	0 deg	0 Ω	0 Ω	
	In/Out	All	All	All	All	
Bin 4	Good Bin	Upper Limit +0 %	0 deg	0 Ω	0 Ω	
	OFF	Lower Limit +0 %	0 deg	0 Ω	0 Ω	
	In/Out	All	All	All	All	
Bin 5	Good Bin	Upper Limit +0 %	0 deg	0 Ω	0 Ω	
	OFF	Lower Limit +0 %	0 deg	0 Ω	0 Ω	
	In/Out	All	All	All	All	
Bin 6	Good Bin	Upper Limit +0 %	0 deg	0 Ω	0 Ω	
	OFF	Lower Limit +0 %	0 deg	0 Ω	0 Ω	
	In/Out	All	All	All	All	
Bin 7	Good Bin	Upper Limit +0 %	0 deg	0 Ω	0 Ω	
	OFF	Lower Limit +0 %	0 deg	0 Ω	0 Ω	
	In/Out	All	All	All	All	
Bin 8	Good Bin	Upper Limit +0 %	0 deg	0 Ω	0 Ω	
	OFF	Lower Limit +0 %	0 deg	0 Ω	0 Ω	
	In/Out	All	All	All	All	

Comparator setup display

Statistical analysis functions

The E4982A is equipped with functions to statistically analyze data. These functions improve the efficiency of the data acquisition required in quality control.

The statistical analysis function calculates the following statistical parameters for as many as 1,000,000,000 measurement points. Original measurement results for the statistical analysis function can be obtained via GPIB/LAN/USB interface.

- mean, maximum, minimum, standard deviation, 3σ /mean

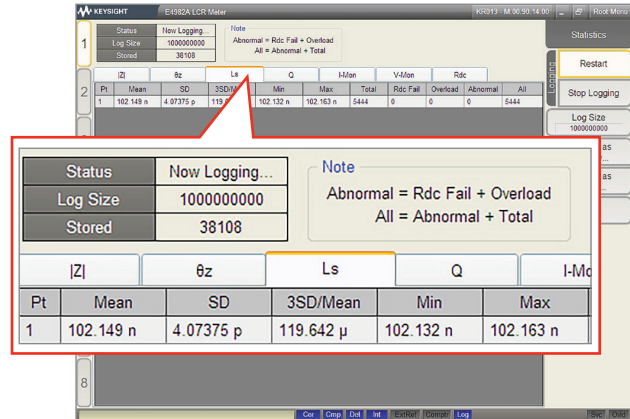
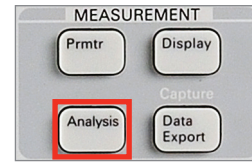

Statistical analysis

Data storage and transfer

The E4982A built-in data storage includes a solid state drive and USB ports. These powerful storage devices permit to save and recall your measurement setup parameters (instrument state) and measurement data. In addition, measurement setup parameters and data can be transferred between the E4982A and an external computer via GPIB/LAN/USB interface.

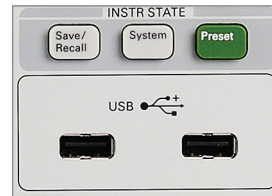

Front panel



Rear panel

Undo recall/preset functions

The undo recall/preset functions are to return to the setting prior to the recall action or preset action respectively. These are to improve the productivity mainly in the manufacturing environment where the file recall and preset are frequently used.

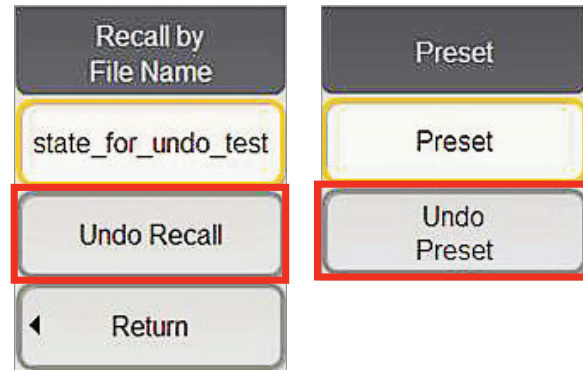

Undo recall

Undo preset

Compatible to 4287A LCR Meter for Drop-in Replacement

The E4982A supports the functionalities of the industry-standard 4287A LCR meter while exceeding the performance such as measurement speed, accuracy, impedance range and so on. The E4982A's SCPI commands are also compatible with the 4287A, which helps the users to make the smooth transition from 4287A to E4982A while leveraging the investment and expertise in the software. Refer to the migration guide available on the Keysight web site for more details on compatibility between the E4982A and 4287A,



Key specifications and functions

	E4982A	4287A
Frequency	1 MHz to 300 M, 500 M, 1 G, and 3 GHz (option, upgradable)	1 MHz to 3 GHz
List meas. function	201 points x 8 table	32 points x 8 table
Test signal level	4.47 mV to 0.502 V/0.0894 mA to 10 mA	4.47 mV to 0.502 V/0.0894 mA to 10 mA@ < 1 GHz 4.47 mV to 0.447 V/0.0894 mA to 8.94 mA@ > 1 GHz
Meas. Time (INDEX)	0.9 ms (Mode1), 2.1 ms (Mode2), 3.7 ms (Mode3) (typ)	5.9 ms (typ)
Basic accuracy	± 0.8 % (typical ± 0.45%)	± 1 %
Z meas. range	0.14 Ω to 4.8 kΩ (Mode3, 1 MHz, acc ≤ ± 10 %)	0.2 Ω to 3 kΩ (1MHz, acc ≤ ± 10 %)
Calibration and compensation	Open/short/load/low-loss cap., fixture electrical length comp., Open/short comp.	←
Rdc meas. function	For contact check (on/off selectable)	←
Comparator	13 bin	←
Data storage	SSD (built-in), USB port	HDD (built-in), 1.44 MB FDD
Interface	GPIB, LAN, Handler I/F, USB(USBTMC) I/F	GPIB, LAN, Handler I/F
Test Head	1 m or 2 m (option), Right angle, 3.5 mm (female) 90 (W) x 24 (D) x 55 (H) mm	←
Size (mm)	425 (W) x 235 (H) x 277 (D)	425 (W) x 235 (H) x 445 (D)
Weight	13 kg	16 kg

For R&D & Quality Assurance

Accurate impedance measurement up to 3 GHz

Characterization of components at operating frequencies in excess of 2 GHz is becoming common due to the development and evaluation of RF SMD inductors used in wireless communication equipment. The E4982A employs the RF I-V measurement method. The E4982A enables accurate measurement over an impedance range much wider than network analyzers (reflection coefficient method) while the upper frequency is limited for the auto-balancing bridge instruments.

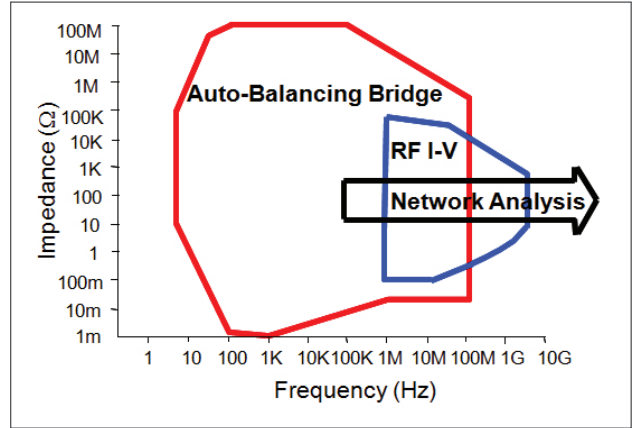

Impedance measurement technique comparison (10% accuracy range)

Improved accuracy for high Q (low loss) measurements

For manual measurements, a low-loss capacitor as a phase calibration standard, in addition to open/short/load calibration, improves the accuracy of Q measurements as shown. In addition to calibration, electrical length compensation for a fixture with open/short compensation fully corrects the measurement error which is caused by the use of a test fixture. These functions realize high absolute measurement accuracy at the measurement plane, which in turn empowers accurate measurement of working standards.



Open/short/load



Low-loss (air) capacitor (phase = -90 °)

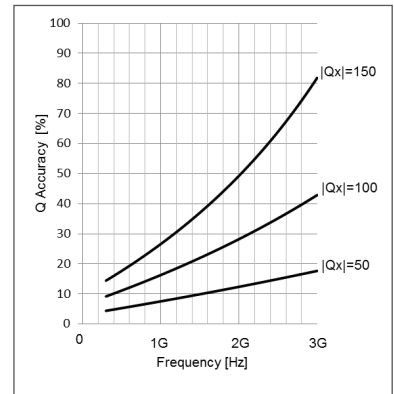

Q accuracy @ 7-mm port (typical)

Calibration/compensation wizard functions

The E4982A offers you the sophisticated calibration/compensation methods with wizard functions. The calibration/compensation wizard functions eliminate errors of troublesome calibration/compensation procedures, and it allows you to easily make the E4982A ready to measure accurately.

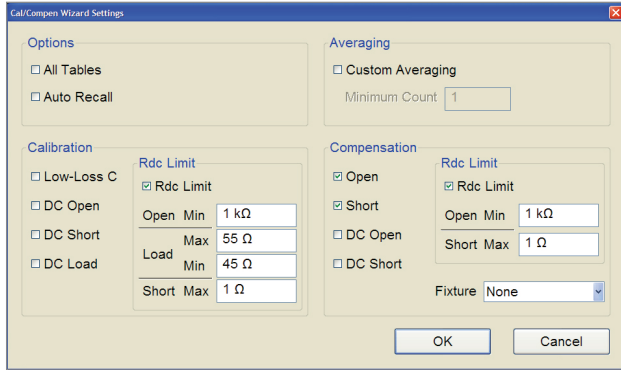

Calibration/compensation settings

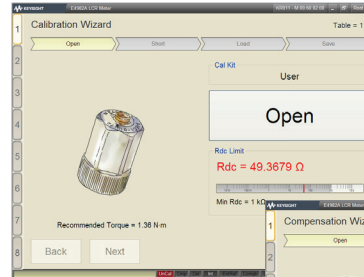

Calibration wizard



Compensation wizard

Frequency characteristics by using list measurement function

In the area of research and development, the frequency characteristics of the device is important for the circuit design. The E4982A's list measurement function enable impedance measurements up to 201 multiple frequency points per table. The maximum of 1608 points is available (= 201 points max./table x 8 tables max.). The measurement results can be displayed by list or plot as list type.



Table	Point	Frequency	Avg	Osc. Lvl	1: Z	2: θz	3: Ls	4: Q
1	151	405.4 MHz	1	-10 dBm	293.3 Ω	88.31 deg	115.1 nH	33.99
1	152	421.9 MHz	1	-10 dBm	309.3 Ω	88.31 deg	116.6 nH	33.94
1	153	439.1 MHz	1	-10 dBm	326.8 Ω	88.32 deg	118.4 nH	34.16
1	154	457.1 MHz	1	-10 dBm	345.8 Ω	88.32 deg	120.4 nH	34.19
1	155	475.8 MHz	1	-10 dBm	366.6 Ω	88.33 deg	122.6 nH	34.32
1	156	495.2 MHz	1	-10 dBm	389.4 Ω	88.35 deg	125.1 nH	34.78
1	157	515.4 MHz	1	-10 dBm	414.5 Ω	88.33 deg	127.9 nH	34.22
1	158	536.5 MHz	1	-10 dBm	442.3 Ω	88.34 deg	131.2 nH	34.60
1	159	558.4 MHz	1	-10 dBm	473.6 Ω	88.31 deg	134.9 nH	33.97
1	160	581.2 MHz	1	-10 dBm	508.6 Ω	88.29 deg	139.2 nH	33.56
1	161	604.9 MHz	1	-10 dBm	548.0 Ω	88.25 deg	144.1 nH	32.65
1	162	629.6 MHz	1	-10 dBm	593.2 Ω	88.20 deg	149.9 nH	31.79
1	163	655.3 MHz	1	-10 dBm	646.0 Ω	88.16 deg	156.8 nH	31.13
1	164	682.1 MHz	1	-10 dBm	707.6 Ω	88.08 deg	165.0 nH	29.83
1	165	710 MHz	1	-10 dBm	781.3 Ω	88.03 deg	175.0 nH	29.14
1	166	739 MHz	1	-10 dBm	870.5 Ω	87.90 deg	187.3 nH	27.31
1	167	769.1 MHz	1	-10 dBm	979.1 Ω	87.73 deg	202.5 nH	25.24
1	168	800.6 MHz	1	-10 dBm	1.120 kΩ	87.58 deg	222.4 nH	23.62
1	169	833.3 MHz	1	-10 dBm	1.304 kΩ	87.33 deg	248.8 nH	21.48
1	170	867.3 MHz	1	-10 dBm	1.554 kΩ	87.03 deg	284.8 nH	19.28
1	171	902.7 MHz	1	-10 dBm	1.924 kΩ	86.32 deg	338.5 nH	15.56
1	172	939.6 MHz	1	-10 dBm	2.528 kΩ	85.42 deg	426.9 nH	12.49
1	173	978 MHz	1	-10 dBm	3.678 kΩ	83.76 deg	595.0 nH	9.146
1	174	1.0179 GHz	1	-10 dBm	6.619 kΩ	79.30 deg	1.017 μH	5.292
1	175	1.0595 GHz	1	-10 dBm	27.11 kΩ	41.74 deg	2.711 μH	692.1 nH

List measurement (list)

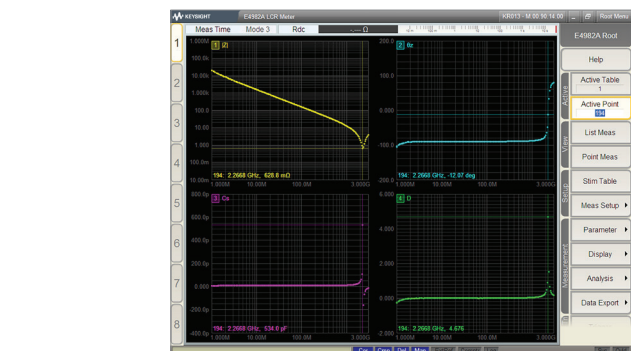
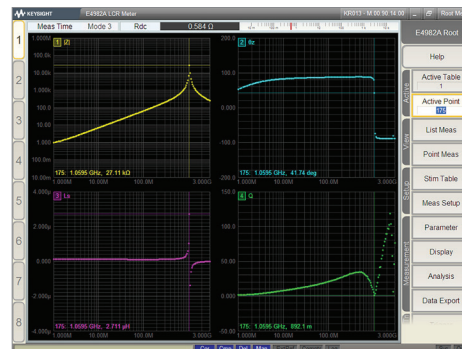

List measurements (plot)

User defined function keys

The three function keys on the front panel offer quicker, one button access to soft keys which are frequently used. The default settings are F1 – Capture Image, F2 – File Utility and F3 – Toggle Beeper Warning. One of the ten specified soft keys (Capture Image, File Utility, Toggle Beeper Warning, Save State File, Save AutoRec.sta, Recall AutoRec.sta, On-Screen Keyboard, Toggle Window Normal/Max, Toggle Window Min/Max, Telnet localhost) can be set to each function key.

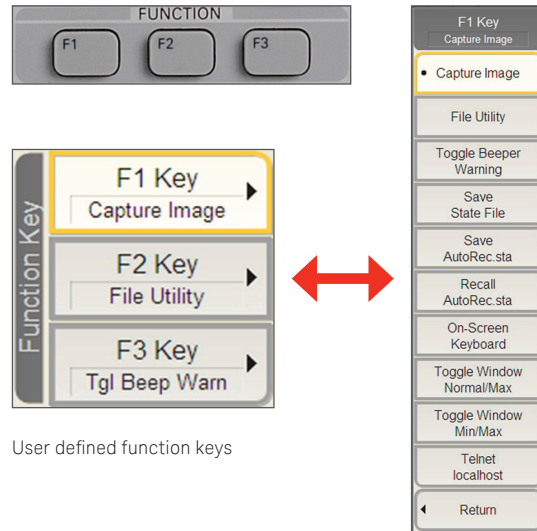

User defined function keys

User defined parameters

The user defined parameter allows you to create the user custom parameter. You can define the parameter other than the pre-defined parameter. In addition, the user defined parameter can be used with the BIN sorting function and can be compared with the limit.

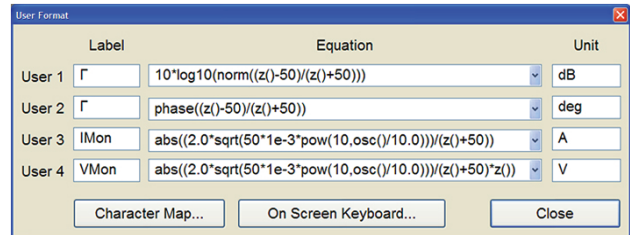

User format dialog box

Context sensitive embedded help

In addition to the modern user interface and connectivity, the E4982A also provides the context sensitive embedded help, which increases the efficiency of operations in R&D, QA, and manufacturing.

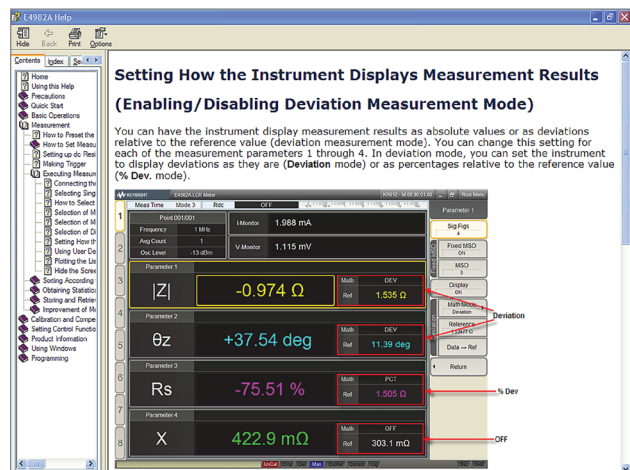

Context sensitive embedded help

PC connectivity & Web-enabled analyzer

Standard GPIB/LAN/USB control interfaces provide a variety of paths for controlling the instrument. Using the LAN interface, the E4982A can conveniently be controlled by a computer with Web browser. The Web server and browser web control executed by the VNC server allow the users to control the E4982A efficiently.

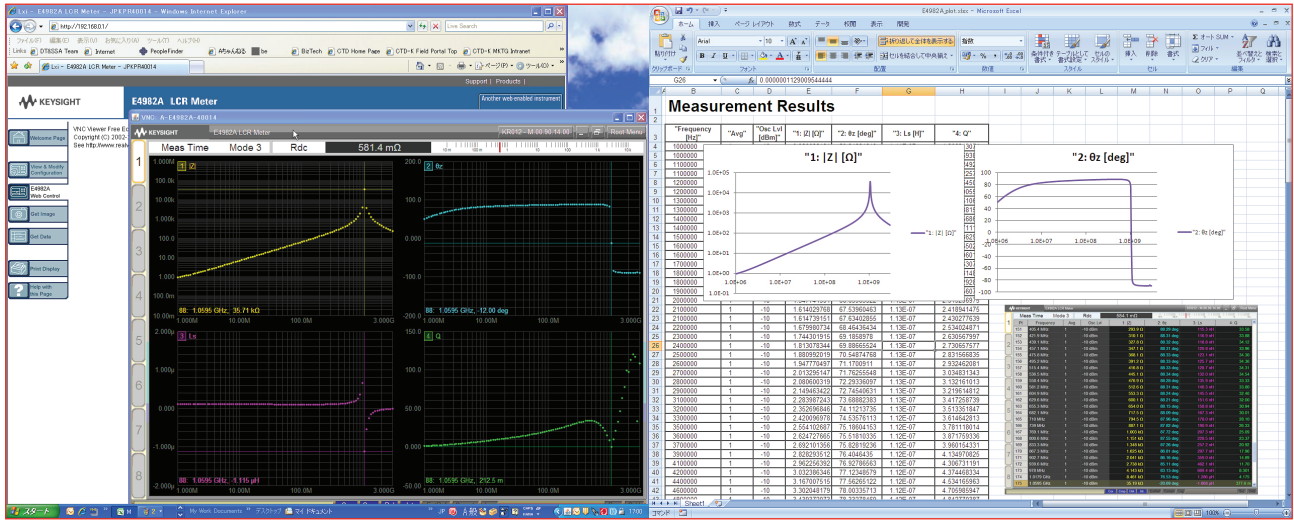

Web server/control + Excel usage example

Wide variety of accessories

When electronic components are evaluated, the test accessories should be suitable for their shape and size for accurate impedance measurement. Keysight offers various kinds of 7-mm test fixtures, which are compatible with the E4982A. You can select the appropriate one for your device's size, shape, and application. The 16196A/B/C/D and 16197A test fixtures make RF impedance measurements up to 3 GHz. When the 16200B is used with the E4982A, a 7-mm test fixture, and an external dc bias source, dc bias current can be applied to devices such as the EMI filter (up to 1 GHz).



Solution example with 16196A



16200B external DC bias adapter

Wide Variety of Accessories

16196A/B/C/D SMD test fixture

- Frequency range: DC to 3 GHz
- Operating temperature range: -55 to +85 °C
- Accommodated SMD size:
 - 16196A: 1608 (mm)/0603 (inch)
 - 16196B: 1005 (mm)/0402 (inch)
 - 16196C: 0603 (mm)/0201 (inch)
 - 16196D: 0402 (mm)/01005 (inch)

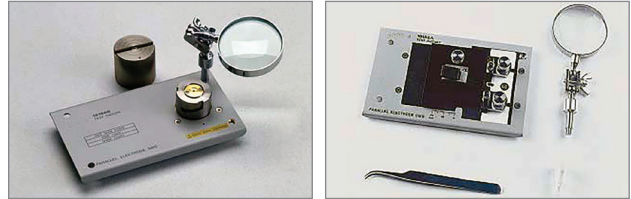

16196A/B/C, 16196D has a different cap shape 16192A

16192A SMD test fixture

- Frequency range: DC to 2 GHz
- Operating temperature range: -55 to +85 °C
- Accommodated SMD size: See Figure

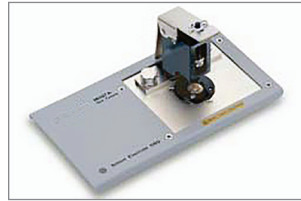

16197A

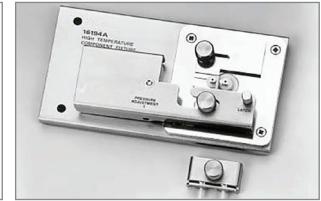

16194A

16197A SMD test fixture

- Frequency range: DC to 3 GHz
- Operating temperature range: -55 to +85 °C
- Accommodated SMD size:
 - 3225 (mm)/1210 (inch)
 - 3216 (mm)/1206 (inch)
 - 2012 (mm)/0805 (inch)
 - 1608 (mm)/0603 (inch)
 - 1005 (mm)/0402 (inch)
 - 0603 (mm)/0201 (inch) (option)

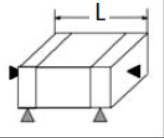
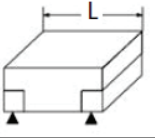
16192A	16197A
L = 1.0 - 20.0 mm	L = 1.0 - 3.2 mm
	

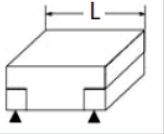
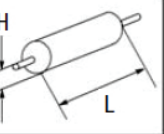
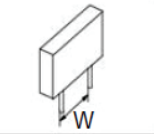
16194A		
L = 2.0 - 15.0 mm	L = < 15 mm L = < 4.5 mm	L = 8.0 - 21.0 mm
		

Accommodated SMD size

16194A High temperature component test fixture

- Frequency range: DC to 2 GHz
- Operating temperature range: -55 to +200 °C
- Accommodated SMD size: See Figure

16200B External DC bias adapter

- Frequency range: 1 MHz to 1 GHz
- External DC bias: 5 A max., 40 V
(at the BNC connector from the external dc bias source)
- Operating temperature range: 0 to +55 °C



16200B

Ordering Information

E4982A LCR Meter furnished accessories

- Test head with 1 m test cable
- N (m)-SMA (f) Adapter
- Wrench for 3.5/SMA connector
- Power cord
- Installation guide
- CD-ROM IO libraries

E4982A options

- E4982A-030 1 MHz to 300 MHz
- E4982A-050 1 MHz to 500 MHz
- E4982A-100 1 MHz to 1 GHz
- E4982A-300 1 MHz to 3 GHz
- E4982A-004 Add working standard set
- E4982A-019 Standard Data Storage¹
- E4982A-020 Add test fixture extension cable set (1 m)
- E4982A-700 16195B calibration kit
- E4982A-710 Test fixture stand
- E4982A-720 3.5 mm to 7 mm coaxial adapter
- E4982A-810 Add keyboard
- E4982A-820 Add mouse
- E4982A-1A7 ISO 17025 compliant calibration
- E4982A-A6J ANSI Z540 compliant calibration

Upgrade options

- E4982AU E4982A upgrade
- E4982AU-004 Add opt 004 Working Standard Set
- E4982AU-020 Add Test Fixture Extension Cable Set
- E4982AU-050 Upgrade from 300 MHz to 500 MHz
- E4982AU-100 Upgrade from 300 MHz to 1 GHz
- E4982AU-101 Upgrade from 500 MHz to 1 GHz
- E4982AU-300 Upgrade from 300 MHz to 3 GHz
- E4982AU-301 Upgrade from 500 MHz to 3 GHz
- E4982AU-302 Upgrade from 1 GHz to 3 GHz
- E4982AU-040 Upgrade OS, from Windows XP to 7, for E4982A

Cabinet options

- E4982A-1CM Rack flange kit
- E4982A-1CN Front handle kit
- E4982A-1CP Handle/rack mount kit

Accessories²

16196A	Parallel electrode SMD test fixture
Option 16196A-710	Add magnifying lens and tweezers
Option 16196A-ABA	U.S. – English localization
Option 16196A-ABJ	Japan – Japanese localization
16196B	Parallel electrode SMD test fixture
Option 16196B-710	Add magnifying lens and tweezers
Option 16196B-ABA	U.S. – English localization
Option 16196B-ABJ	Japan – Japanese localization
16196C	Parallel electrode SMD test fixture
Option 16196C-710	Add magnifying lens and tweezers
Option 16196C-ABA	U.S. – English localization
Option 16196C-ABJ	Japan – Japanese localization
16196D	Parallel electrode SMD test fixture
Option 16196D-710	Add magnifying lens and tweezers
Option 16196D-ABA	U.S. – English localization
Option 16196D-ABJ	Japan – Japanese localization
16197A	Bottom electrode SMD test fixture
Option 16197A-001	Add 0201 (inch)/0603 (mm) device guide set
Option 16197A-ABA	U.S. – English localization
Option 16197A-ABJ	Japan – Japanese localization
16192A	Parallel electrode SMD test fixture
Option 16192A-010	EIA/EIAJ industry sized short bar set
Option 16192A-701	Short bars set (1 × 1 × 2.4, 1.6 × 2.4 × 2, 3.2 × 2.4 × 2.4, 4.5 × 2.4 × 2.4) mm
Option 16192A-710	Add magnifying lens and tweezers
16194A	High temperature component test fixture
Option 16194A-010	EIA/EIAJ industry sized short bar set
Option 16192A-701	Short bars set (1 × 1 × 2.4, 1.6 × 2.4 × 2, 3.2 × 2.4 × 2.4, 4.5 × 2.4 × 2.4) mm
16200B	External DC bias adapter
16190B	Performance test kit, 7-mm

1. Option 019 is the only data storage option for the E4982A. Must choose this option when ordering the E4982A.

2. For more details, refer to LCR Meters, Impedance Analyzers and test Fixtures Selection Guide (5952-1430E)

www.keysight.com/find/e4982a



This information is subject to change without notice.
© Keysight Technologies, 2012 - 2017
Published in USA, December 5, 2017
5990-9911EN
www.keysight.com