

MANUAL CHANGES

Agilent 4285A Precision LCR Meter

Operation Manual

MANUAL IDENTIFICATION

Model Number: 4285A Date Printed: March 2000 Part Number: 04285-90010

This supplement contains information for correcting manual errors and for adapting the manual to newer instruments that contains improvements or modifications not documented in the existing manual.

To use this supplement

1. Make all ERRATA corrections
2. Make all appropriate serial-number-related changes listed below

SERIAL PREFIX OR NUMBER CHANGES	MAKE MANUAL
All	1

◆ New Item

SERIAL PREFIX OR NUMBER CHANGES	MAKE MANUAL

ERRATA

CHANGES 1

CHANGE 1 contains the information needed to adapt the 4285A's manual.

Changed the company name from YOKOGAWA-HEWLETT-PACKARD, LTD., or its abbreviation YHP to Agilent Technologies Japan, Ltd.

NOTE

Manual change supplement are revised as often as necessary to keep manuals as current and accurate as possible. Agilent Technologies recommends that you periodically request the latest edition of this supplement. Free copies are available from all Agilent Technologies offices. When requesting copies, quote the manual identification information from your supplement, or the model number and print date from the title page of the manual.



The pink sheet titled “CAUTION ON OPERATION”

Change the page title as follows.



CAUTION ON OPERATION

3.HANDLER INTERFACE BOARD (OPTION 201)

Add the following information.

Fuse: Non Time Delay 0.5A 125V

If you need this fuse,contact your nearest Agilent Technologies Sales and Service Office.

MODEL 4284A PRECISION LCR METER OPTION 201 HANDLER INTERFACE OPERATION NOTE

Page 2-16 Warning

Change the procedure 1 and warning as follows:

1. Disconnect the 4284A's power cord and allow 1 minute for the internal supply filter capacitors to discharge.

WARNING

Dangerous energy/voltage exists when the 4284A is in operation,and for a time after it is powered down. Allow 1 minute for the internal capacitors to discharge.

Page 2-16

Add the following CAUTION after the procedure 7.

CAUTION

The interface board contains electronic components that can be damaged by static electricity through electrostatic discharge(ESD).To prevent ESD damage,maintain frequent contact with any bare sheet metal surface on the chassis. A grounding wrist strap (or similar device) is useful for this purpose. Handle the board carefully at all times. Avoid touching electronic components or circuit paths.

MODEL 4284A PRECISION LCR METER OPTION 202 HANDLER INTERFACE OPERATION NOTE

Page 3-4 Warning

Change the procedure 1 and warning as follows:

1. Disconnect the 4284A's power cord and allow 1 minute for the internal supply filter capacitors to discharge.

WARNING

Dangerous energy/voltage exists when the 4284A is in operation,and for a time after it is powered down. Allow 1 minute for the internal capacitors to discharge.

Page 3-4

Add the following CAUTION after the procedure 6.

CAUTION

The interface board contains electronic components that can be damaged by static electricity through electrostatic discharge(ESD).To prevent ESD damage,maintain frequent contact with any bare sheet metal surface on the chassis. A grounding wrist strap (or similar device) is useful for this purpose. Handle the board carefully at all times. Avoid touching electronic components or circuit paths.

MODEL 4284A PRECISION LCR METER OPTION 301 SCANNER INTERFACE OPERATION NOTE

Page 2-11 Warning

Change the procedure 1 and warning as follows:

Disconnect the power cable from the 4284A and allow 1 minute for the internal capacitors to discharge.

WARNING

Dangerous energy/voltage exists when the 4284A is in operation,and for a time after it is powered down. Allow 1 minute for the internal capacitors to discharge.

Agilent 4285A Precision LCR Meter

Operation Manual

MANUAL IDENTIFICATION

Model Number: 4285A Date Printed: March 2000 Part Number: 04285-90010

This supplement contains information for correcting manual errors and for adapting the manual to newer instruments that contains improvements or modifications not documented in the existing manual.

To use this supplement

1. Make all ERRATA corrections
2. Make all appropriate serial-number-related changes listed below

SERIAL PREFIX OR NUMBER CHANGES	MAKE MANUAL
3041J00276	1

◆ New Item

SERIAL PREFIX OR NUMBER CHANGES	MAKE MANUAL

ERRATA

CHANGES 1

When used with the 42851A Precision Q Adapter, make the following changes:

Two system messages are added.

"Warning, Cannot find resonance" (when the tuning capacitor cannot resonate with the DUT)

"Waiting for trigger" (when the 4285A is not triggered)

On the Q CORRECTION page, the SHORT correction function is always set to ON.

On the Q CORRECTION page, the Q-MODE field is added to select between EFFECTIVE Q mode and CIRCUIT Q mode.

NOTE

Manual change supplement are revised as often as necessary to keep manuals as current and accurate as possible. Agilent Technologies recommends that you periodically request the latest edition of this supplement. Free copies are available from all Agilent Technologies offices. When requesting copies, quote the manual identification information from your supplement, or the model number and print date from the title page of the manual.

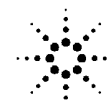

CAUTIONS ON OPERATION

1. UNKNOWN (MEASUREMENT) TERMINALS

Do **NOT** apply DC voltage or current to the UNKNOWN terminals. Doing so will damage the 4285A. Before you measure a capacitor, be sure the capacitor is fully discharged.

2. MEMORY CARD

Use Agilent Technologies-specified memory cards containing 4285A-specific data only. If other memory cards are used, the 4285A may be damaged. Non 4285A-specific data contained on a memory card is not guaranteed, and data may be lost.

To insert a memory card into the **MEMORY** card slot, hold the memory card with the label facing upward and with the contacts at the slot opening. Insert the card into the slot until it "clicks" in place.

To remove a memory card from the 4285A, press the UNLOCK button and remove the card.

Do **NOT** remove a memory card while **LOADing** or **STORing** data. Doing so may damage the memory card and any data stored in the memory card may be lost.

Store memory cards in their furnished card cases when not in use. The card case protects memory cards from contamination and electrostatic discharge.

Also, store memory cards under the following environmental conditions.

Storage Temperature Range: -30 to +70

Storage Humidity Range: 30%. to 85%. (@ +50)

Do **NOT** shock or stress memory cards.

When storing or moving your 4285A, be sure the memory card slot is empty (no memory card inserted).

Do **NOT** touch the connector contact surface of a memory card and do **NOT** use chemical liquids to clean the contacts.

3. HANDLER INTERFACE BOARD (OPTION 201)

If the +5V **internal voltage** (pin 16, 17 or 18 of the handler interface connector) **is not output**, a fuse on the handler interface board (A32F1) has blown and must be replaced. Two replacement fuses are furnished with the 4285A option 201. Additional fuses are available from Agilent Technologies. Order PN 2110-0046.

Fuse: Mpm Time Delay 0.5A 12.5V

If you need this fuse, contact your nearest Agilent Technologies Sales and Service Office.

To replace A32F1 , perform the following procedure.

1. To remove the handler interface board (A32), perform **procedure I through 7 on page 10-26**.
2. Remove A32F1 (indicated in Figure A) from socket and carefully insert the new fuse.
3. Replace the handler interface board, top shield plate, rear feet, and top cover.

If the handler interface continues not to output +5V after A32F1 has been replaced, contact the nearest Agilent Technologies office.

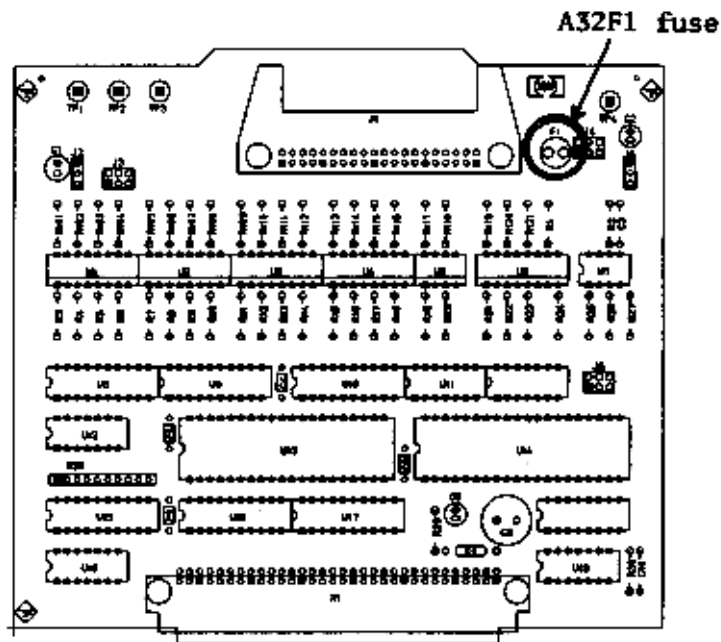

Figure A. Handler Interface Board



Agilent Technologies
Innovating the HP Way

DECLARATION OF CONFORMITY

According to ISO/IEC Guide 22 and CEN/CENELEC EN 45014

Manufacturer's Name: Agilent Technologies Japan, Ltd.
Manufacturer's Address: Component Test PGU-Kobe
1-3-2, Murotani, Nishi-ku, Kobe-shi,
Hyogo, 651-2241 Japan

Declares, that the product

Product Name: Precision LCR Meter
Model Number: 4285A
Product Options: All options and customized products based on the above

Is in conformity with:

EMC European Council Directive 89/336/EEC and carries the CE-marking accordingly
EMC Standards required by the Australia Radio Communications Act
IEC 61326-1:1997+A1 / EN 61326-1:1997+A1
CISPR 11:1990 / EN 55011:1991 / AS/NZS 2064.1- Group 1 Class A ^[1]
IEC 61000-4-2:1995 / EN 61000-4-2:1995 (4 kV CD, 8 kV AD)
IEC 61000-4-3:1995 / EN 61000-4-3:1996 (3 V/m 80% AM 27 - 1000 MHz)
IEC 61000-4-4:1995 / EN 61000-4-4:1995 (1 kV power line, 0.5 kV Signal line)
IEC 61000-4-5:1995 / EN 61000-4-5:1995 (0.5 kV line-line, 1 kV line-earth)
IEC 61000-4-6:1996 / EN 61000-4-6:1996 (3 V 80% AM, power line)
IEC 61000-4-11:1994 / EN 61000-4-11:1994 (100% 1cycle)

Safety European Council Directive 73/23/EEC and carries the CE-marking accordingly
IEC 61010-1:1990+A1+A2 / EN 61010-1:1993+A2

Additional Information:

LEDs in this product are Class 1 in accordance with EN 60825-1:1994.

^[1] The product was tested in a typical configuration.

Dec. 15, 1999

Date

Name Yukihiro Ota / Quality Engineering Manager

For further information, please contact your local Agilent Technologies sales office, agent or distributor.

Safety Summary

When you notice any of the unusual conditions listed below, immediately terminate operation and disconnect the power cable.

Contact your local Agilent Technologies sales representative or authorized service company for repair of the instrument. If you continue to operate without repairing the instrument, there is a potential fire or shock hazard for the operator.

- Instrument operates abnormally.
- Instrument emits abnormal noise, smell, smoke or a spark-like light during the operation.
- Instrument generates high temperature or electrical shock during operation.
- Power cable, plug, or receptacle on instrument is damaged.
- Foreign substance or liquid has fallen into the instrument.

Herstellerbescheinigung

GERÄUSCHEMISSION

LpA < 70 dB
am Arbeitsplatz
normaler Betrieb
nach DIN 45635 T. 19

Manufacturer's Declaration

ACOUSTIC NOISE EMISSION

LpA < 70 dB
operator position
normal operation
per ISO 7779

Agilent 4285A PRECISION LCR METER OPERATION MANUAL

SERIAL NUMBERS

This manual applies directly to instruments with serial number prefix 3009J. For additional important information about serial numbers, read “Serial Number” in Chapter 1 of this Operation Manual.



**Agilent Part No. 04285-90010
Printed in JAPAN January 2001**

Sixth Edition

Notice

The information contained in this document is subject to change without notice.

This document contains proprietary information which is protected by copyright. All rights are reserved. No part of this document may be photocopied, reproduced, or translated to another language without the prior written consent of the Agilent Technologies.

Agilent Technologies Japan, Ltd.
Component Test PGU-Kobe
1-3-2, Murotani, Nishi-ku, Kobe-shi,
Hyogo, 651-2241 Japan

Manual Printing History

The manual printing date and part number indicate its current edition. The printing date changes when a new edition is printed. (Minor corrections and updates which are incorporated at reprint do not cause the date to change.) The manual part number changes when extensive technical changes are incorporated.

June 1990 First Edition
June 1992 Second Edition
December 1996 Third Edition
September 1997 Fourth Edition (part number: 04285-90010)
March 2000 Fifth Edition (part number: 04285-90010)
January 2001 Sixth Edition (part number: 04285-90010)

Safety Summary

The following general safety precautions must be observed during all phases of operation, service, and repair of this instrument. Failure to comply with these precautions or with specific *WARNINGS* elsewhere in this manual may impair the protection provided by the equipment. In addition it violates safety standards of design, manufacture, and intended use of the instrument.

The Agilent Technologies assumes no liability for the customer's failure to comply with these requirements.

Note



4285A complies with INSTALLATION CATEGORY II and POLLUTION DEGREE 2 in IEC1010-1. 4285A is INDOOR USE product.

Note



LEDs in this product are Class 1 in accordance with IEC825-1.
CLASS 1 LED PRODUCT

Ground The Instrument

To avoid electric shock hazard, the instrument chassis and cabinet must be connected to a safety earth ground by the supplied power cable with earth blade.

DO NOT Operate In An Explosive Atmosphere

Do not operate the instrument in the presence of flammable gasses or fumes. Operation of any electrical instrument in such an environment constitutes a definite safety hazard.

Keep Away From Live Circuits

Operating personnel must not remove instrument covers. Component replacement and internal adjustments must be made by qualified maintenance personnel. Do not replace components with the power cable connected. Under certain conditions, dangerous voltages may exist even with the power cable removed. To avoid injuries, always disconnect power and discharge circuits before touching them.

DO NOT Service Or Adjust Alone

Do not attempt internal service or adjustment unless another person, capable of rendering first aid and resuscitation, is present.

DO NOT Substitute Parts Or Modify Instrument

Because of the danger of introducing additional hazards, do not install substitute parts or perform unauthorized modifications to the instrument. Return the instrument to a Agilent Technologies Sales and Service Office for service and repair to ensure that safety features are maintained.

Dangerous Procedure Warnings

Warnings , such as the example below, precede potentially dangerous procedures throughout this manual. Instructions contained in the warnings must be followed.

Warning



Dangerous voltages, capable of causing death, are present in this instrument. Use extreme caution when handling, testing, and adjusting this instrument.

Safety Symbols

General definitions of safety symbols used on equipment or in manuals are listed below.



Instruction manual symbol: the product is marked with this symbol when it is necessary for the user to refer to the instruction manual.



Alternating current.



Direct current.



On (Supply).



Off (Supply).



In position of push-button switch.



Out position of push-button switch.



Frame (or chassis) terminal. A connection to the frame (chassis) of the equipment which normally include all exposed metal structures.

Warning



This **Warning** sign denotes a hazard. It calls attention to a procedure, practice, condition or the like, which, if not correctly performed or adhered to, could result in injury or death to personnel.

Caution



This **Caution** sign denotes a hazard. It calls attention to a procedure, practice, condition or the like, which, if not correctly performed or adhered to, could result in damage to or destruction of part or all of the product.

Note



Note denotes important information. It calls attention to a procedure, practice, condition or the like, which is essential to highlight.



Affixed to product containing static sensitive devices use anti-static handling procedures to prevent electrostatic discharge damage to component.

4285A Precision LCR Meter Documentation Map

The documentation for the 4285A has been separated into several manuals. Following is a brief description of each manual and its purpose.

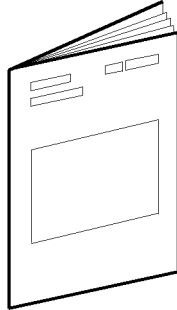

The *4285A Getting Started Guide* walks you through system setup and initial power-up, shows how to make basic measurements and explains commonly used features.

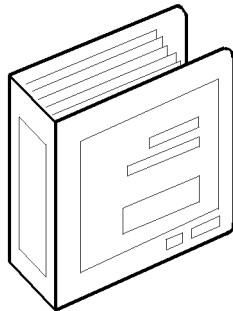

The *4285A OPERATION MANUAL* (Agilent Part Number 04285-90010) provides general information, specifications, GPIB programming information, and in depth reference information.

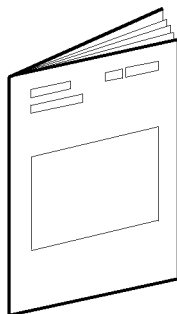

The *4285A MAINTENANCE MANUAL* (Agilent Part Number 04285-90030) explains how to verify conformance to published specifications.

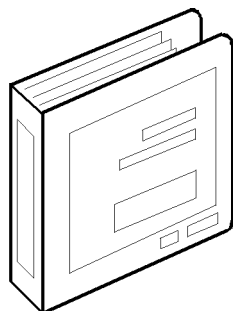

The *4285A SERVICE MANUAL* (Agilent Part Number 04285-90031) explains how to adjust, troubleshoot, and repair the instrument. (Furnished Option 915 only.)

How To Use This Manual

This is the Operation Manual for the 4285A Precision LCR Meter. This manual contains specifications, supplemental performance characteristics, installation, configuration, operation, and remote control commands in nine chapters. Use this manual for the function reference.

Chapter 1 General Information

Chapter 1 provides the specifications, supplemental performance characteristics, and other general information on the 4285A.

Chapter 2 Installation

Chapter 2 provides unpacking, initial inspection, rack mount/handle kit installation, and preparation information necessary for you to know and do before applying AC power.

Chapter 3 Product Overview

Chapter 3 provides information including a product overview.

Chapter 4 DISPLAY FORMAT

Chapter 4 provides detailed information for the display format and measurement function, corresponding to the **DISPLAY FORMAT** menukey.

Chapter 5 MEAS SETUP

Chapter 5 provides detailed information for the measurement condition setup, corresponding to the **MEAS SETUP** menukey.

Chapter 6 CATALOG/SYSTEM CONFIGURATION

Chapter 6 provides detailed information for the internal/external memory and system configuration catalog of the 4285A, corresponding to the **CATALOG/SYSTEM** menukey.

Chapter 7 Measurement Basics

Chapter 7 provides the basic measurement procedure with the general impedance theory and measurement techniques.

Chapter 8 Remote Control

Chapter 8 provides information to control the 4285A using the GPIB interface.

Chapter 9 Command Reference

Chapter 9 provides detailed information for each of the 4285A GPIB commands.

Appendix A Manual Changes

Appendix A contains Manual Changes and provides information for using this manual with an 4285As manufactured before the printing date of the manual.

Appendix B Error and Warning Messages

Appendix B lists the 4285A's error and warning messages with brief descriptions and solutions.

Appendix C Initial Settings and System Memory

Appendix C lists the 4285A's initial settings and functions whose status is stored in internal system memory.

Appendix D Write Protection

Appendix D provides the procedure for write protecting all of the stored data in the 4285A's memory card and internal EEPROM memory.

Typeface Conventions

Bold

Boldface type is used when a term is defined. For example: **icons** are symbols.

Italics

Italic type is used for emphasis and for titles of manuals and other publications.

Italic type is also used for keyboard entries when a name or a variable must be typed in place of the words in italics. For example: copy *filename* means to type the word copy, to type a space, and then to type the name of a file such as file1.

Computer

Computer font is used for on-screen prompts and messages.

HARDKEYS

Labeled keys on the instrument front panel are enclosed in □.

SOFTKEYS

Softkeys located to the right of the Liquid Crystal Display (LCD) are enclosed in ▢.

Certification

Agilent Technologies certifies that this product met its published specifications at the time of shipment from the factory. Agilent Technologies further certifies that its calibration measurements are traceable to the United States National Institute of Standards and Technology (NIST), to the extent allowed by the Institute's calibration facility, or to the calibration facilities of other International Standards Organization members.

Warranty

This Agilent Technologies instrument product is warranted against defects in material and workmanship for a period of one year from the date of shipment, except that in the case of certain components listed in “Components not Covered by Warranty” in Chapter 1 of this manual, the warranty shall be for the specified period. During the warranty period, Agilent Technologies will, at its option, either repair or replace products which prove to be defective.

For warranty service or repair, this product must be returned to a service facility designated by Agilent Technologies. Buyer shall prepay shipping charges to Agilent Technologies and Agilent Technologies shall pay shipping charges to return the product to Buyer. However, Buyer shall pay all shipping charges, duties, and taxes for products returned to Agilent Technologies from another country.

Agilent Technologies warrants that its software and firmware designated by Agilent Technologies for use with an instrument will execute its programming instruction when properly installed on that instrument. Agilent Technologies does not warrant that the operation of the instrument, or software, or firmware will be uninterrupted or error free.

Limitation of Warranty

The foregoing warranty shall not apply to defects resulting from improper or inadequate maintenance by Buyer, Buyer-supplied software or interfacing, unauthorized modification or misuse, operation outside of the environmental specifications for the product, or improper site preparation or maintenance.

No other warranty is expressed or implied. Agilent Technologies specifically disclaims the implied warranties of merchantability and fitness for a particular purpose.

Exclusive Remedies

The remedies provided herein are buyer’s sole and exclusive remedies. Agilent Technologies shall not be liable for any direct, indirect, special, incidental, or consequential damages, whether based on contract, tort, or any other legal theory.

Assistance

Product maintenance agreements and other customer assistance agreements are available for Agilent Technologies products.







For any assistance, contact your nearest Agilent Technologies Sales and Service Office. Addresses are provided at the back of this manual.

Contents

1. General Information

Introduction	1-1
Components not Covered by Warranty	1-1
Serial Number	1-1
Specifications	1-3
Measurement Functions	1-3
Measurement Parameters	1-3
Combinations of Measurement Parameters	1-3
Mathematical Functions	1-3
Equivalent Measurement Circuit	1-3
Ranging	1-3
Trigger	1-3
Delay Time	1-3
Measurement Terminals	1-4
Test Cable Length	1-4
Integration Time	1-4
Averaging	1-4
Test Signal	1-4
Frequency	1-4
Frequency Accuracy	1-4
Signal Modes	1-4
Normal	1-4
Constant	1-4
Signal Level	1-4
Output Impedance	1-5
Test Signal Level Monitor	1-5
Display Range	1-6
Measurement Accuracy	1-6
Z , Y , L, C, R, X, G, and B Accuracy	1-9
D Accuracy	1-9
Q Accuracy	1-9
θ Accuracy	1-9
G Accuracy	1-10
R_p Accuracy	1-10
R_s Accuracy	1-10
Basic Accuracy Equations	1-10
N Accuracy Factors	1-12
Cable Length Factor	1-15
Temperature Factor	1-15
Measurement Accuracy Calculation Example	1-15
Example of L_s -Q Accuracy Calculation	1-15
Determine inductance measurement accuracy A_e	1-15
Determine Q measurement accuracy Q_e	1-17
Correction Functions	1-17
Zero Open	1-17
Zero Short	1-17

Load	1-17
List Sweep	1-17
Comparator Function	1-18
Sorting Modes	1-18
Sequential mode	1-18
Tolerance Mode	1-18
Bin Count	1-18
List Sweep Comparator	1-18
Other Functions	1-18
Store/Load	1-18
GPIB	1-18
GPIB Interface Functions	1-18
Self Test	1-18
Option 001 (Internal DC Bias)	1-18
DC Bias Level	1-18
DC Bias Monitor Terminal	1-19
Other Options	1-19
Furnished Accessories	1-20
Accessories Available	1-20
Test Fixture / Test Leads	1-20
DC Bias Source	1-20
Memory Card	1-20
GPIB Interconnection Cables	1-20
Handler Interface Connector for Mating with Option 201	1-21
Scanner Interface Connector for Mating with Option 301	1-21
Power Requirements	1-21
Line Voltage	1-21
Line Frequency	1-21
Power Consumption	1-21
Operating Environment	1-21
Temperature	1-21
Humidity	1-21
Altitude	1-21
Dimensions	1-21
Weight	1-21
Display	1-21
Capable of Displaying	1-21
Number of Display Digits	1-21
Supplemental Performance Characteristics	1-22
Stability	1-22
Temperature Coefficient	1-22
Settling Time	1-22
Frequency (f_m)	1-22
Test Signal Level	1-22
Measurement Range	1-22
Input Protection	1-22
Measurement Time	1-23
Display Time	1-23
GPIB Data Output Time	1-23
Option 001 (Internal DC Bias)	1-23
DC Bias Settling Time	1-23

2. Installation	
Incoming Inspection	2-1
Power Requirements	2-3
Power Cable	2-3
Line Voltage and Fuse Selection	2-5
Line Voltage Selection	2-5
 Fuse Selection	2-5
Operation Environment	2-6
Electromagnetic Compatibility	2-6
Ventilation Requirements	2-7
Instruction for Cleaning	2-7
Rack/Handle Installation	2-7
Option 907 Handle Kit	2-7
Handle Installation	2-7
Option 908 Rack Flange Kit	2-7
Rack Mounting	2-7
Option 909 Rack Flange & Handle Kit	2-8
Handle and Rack Mounting	2-8
3. Overview	
Introduction	3-1
Product Introduction	3-1
Front Panel Description	3-2
① LINE On/Off	3-2
② LCD Panel	3-2
③ SOFTKEYS	3-2
④ MENU Keys	3-2
⑤ CURSOR Keys	3-3
⑥ ENTRY Keys	3-3
⑦ GPIB Status Indicator	3-3
⑧  Key	3-3
⑨  Key	3-3
Ⓐ MEMORY Card Slot and UNLOCK Button	3-3
Ⓑ  Key	3-3
Ⓒ CONTRAST Control Knob	3-3
Ⓓ  UNKNOWN Terminals	3-4
Ⓔ FRAME Terminal	3-4
Rear Panel Description	3-5
① GPIB Interface Connector	3-5
② Interface Connectors	3-5
③ INT DC BIAS MONITOR Connector	3-5
④ EXT TRIGGER Connector	3-5
⑤ ~LINE Input Receptacle	3-6
⑥  ~LINE Fuse Holder	3-6
⑦ ~LINE VOLTAGE SELECTOR	3-6
Display	3-7
Display Area Definition	3-7
Display Page Format Field	3-7
System Menu Field	3-7
Comment Field	3-7
Softkey Area	3-8
Measurement Data/Conditions Area	3-8

Input Line Area	3-8
System Message Area	3-8
MENU Keys and Display Page	3-8
DISPLAY FORMAT	3-9
MEAS SETUP	3-9
CATALOG/SYSTEM	3-10
Summary of Pages	3-11
MEAS DISPLAY (under DISPLAY FORMAT)	3-11
BIN No. DISPLAY (under DISPLAY FORMAT)	3-11
BIN COUNT DISPLAY (under DISPLAY FORMAT)	3-11
LIST SWEEP DISPLAY (under DISPLAY FORMAT)	3-11
MEAS SETUP (under MEAS SETUP)	3-11
CORRECTION (under MEAS SETUP)	3-11
LIMIT TABLE SETUP (under MEAS SETUP)	3-11
LIST SWEEP SETUP (under MEAS SETUP)	3-12
CATALOG (under CATALOG/SYSTEM)	3-12
SYSTEM CONFIG (under CATALOG/SYSTEM)	3-12
CABLE CORRECTION (under CATALOG/SYSTEM)	3-12
SELF TEST (under CATALOG/SYSTEM)	3-12
Basic Operation	3-16

4. **DISPLAY FORMAT Menu**

Introduction	4-1
MEAS DISPLAY Page	4-1
SYS MENU Field	4-4
LOAD /STORE Softkeys	4-4
Storing the Control Settings	4-5
Loading the Control Settings	4-5
D.P. FIX A /D.P.FIX B Softkeys	4-6
Setting the Fixed Decimal Point Function	4-6
PRINT DISP /PRINT DATA Softkeys	4-6
Dumping the LCD Screen to the Printer	4-8
Printing out the Measurement	4-8
KEY LOCK Softkey	4-9
Locking Out the Front Panel	4-9
BIN No. DISPLAY Page	4-10
COMP Field	4-12
Setting the Comparator Function to ON or OFF	4-12
SYS MENU Field	4-13
Loading or Storing the Control Settings	4-13
Printing the Measurement Result	4-13
Locking Out the Front Panel	4-14
BIN COUNT DISPLAY Page	4-15
SYS MENU Field	4-16
COUNT ON /COUNT OFF Softkeys	4-16
Setting the Bin Counter ON or OFF	4-16
Loading or Storing the Control Settings	4-17
Printing the Measurement Result	4-17
Locking Out the Front Panel	4-18
LIST SWEEP DISPLAY Page	4-19
MODE Field	4-21
Setting the List Sweep Measurement Mode	4-21
SYS MENU Field	4-21
Storing the Control Settings	4-22

Loading the Control Settings	4-22
Printing the Measurement Result	4-22
Locking Out the Front Panel	4-24

5. MEAS SETUP Menu

Introduction	5-1
MEAS SETUP Page	5-1
FUNC Field	5-4
Choosing the Measurement Function	5-4
RANGE Field	5-5
AUTO Softkey	5-6
HOLD Softkey	5-6
INCR ↑ Softkey	5-6
DECR ↓ Softkey	5-6
Setting the Measurement Range	5-6
FREQ Field	5-7
INCR ↑ Softkey	5-7
INCR ΔHz Softkey	5-7
DECR ΔHz Softkey	5-7
DECR ↓ Softkey	5-7
kHz / MHz Softkeys	5-7
ΔkHz / ΔMHz Softkeys	5-8
Setting the Test Frequency	5-8
LEVEL Field	5-9
INCR ↑ / DECR ↓ Softkeys	5-9
mV, V, μA, and mA Softkeys	5-9
Setting the Oscillator Level	5-9
BIAS Field	5-10
INCR ↑ and DECR ↓ Softkeys	5-11
mV, V, μA, mA, and A Softkeys	5-11
Setting the DC Bias	5-11
INTEG Field	5-12
SHORT Softkey	5-12
MED Softkey	5-12
LONG Softkey	5-12
Setting the Integration Time	5-12
Comment Field	5-13
COM-MENT Softkey	5-13
[→] Softkey	5-13
CLEAR LINE Softkey	5-13
ABORT& EXIT Softkey	5-13
END INPUT Softkey	5-13
Entering Comments	5-14
TRIG Field	5-14
INT Softkey	5-14
MAN Softkey	5-14
EXT Softkey	5-14
Setting the Trigger Mode	5-15

ALC Field	5-16
Setting the Automatic Level Control Function	5-19
MON Field	5-19
V BIAS Softkey	5-19
I BIAS Softkey	5-19
Setting the DC Bias Monitor Mode	5-19
AVG Field	5-20
INCR ↑ and DECR ↓ Softkeys	5-20
Setting the Averaging Rate	5-20
DELAY Field	5-20
msec and sec Softkeys	5-20
Setting the Delay Time	5-20
Vm/Im Fields	5-21
Setting the Test Signal Level Monitor Function	5-21
DEV A/B Fields	5-21
Δ ABS Softkey	5-21
Δ % Softkey	5-22
OFF Softkey	5-22
REF A/B Fields	5-22
MEA-SURE Softkey	5-22
Performing the Deviation Measurement	5-22
SYS MENU Field	5-23
LOAD /STORE Softkeys	5-23
CLEAR SETUP Softkey	5-23
Resetting the Control Settings on the MEAS SETUP	
Page	5-24
PRINT DISP Softkey	5-24
Dumping the MEAS SETUP Page	5-24
SYSTEM RESET Softkey	5-25
Resetting the 4285A	5-25
CORRECTION Page	5-26
OPEN Field	5-29
ON Softkey	5-30
OFF Softkey	5-30
MEAS OPEN Softkey	5-30
ABORT Softkey	5-31
Performing the OPEN Correction	5-31
SHORT Field	5-32
ON Softkey	5-32
OFF Softkey	5-32
MEAS SHORT Softkey	5-33
ABORT Softkey	5-33
Performing the SHORT Correction	5-33
FREQ1-7 Fields	5-34
ON Softkey	5-34
OFF Softkey	5-34
MEAS OPEN Softkey	5-34
MEAS SHORT Softkey	5-34
MEAS LOAD Softkey	5-35

REF A/B Fields	5-35
Performing the Spot OPEN/SHORT Correction	5-35
Performing the LOAD Correction	5-36
FUNC Field	5-38
Setting the Measurement Function of the Standard's DUT	5-38
MODE Field	5-40
SINGLE Softkey	5-40
MULTI Softkey	5-40
Setting the Correction Mode	5-40
CABLE Field	5-41
0 m Softkey	5-41
1 m Softkey	5-41
2 m Softkey	5-42
Selecting the Cable Length	5-42
SYS MENU Field	5-42
PRINT DISP Softkey	5-42
Printing the CORRECTION Page Setup	5-42
LIMIT TABLE SETUP Page	5-44
FUNC Field	5-46
SWAP PARAM Softkey	5-46
Swapping the Primary and Secondary Parameters	5-47
MODE Field	5-47
% TOL Softkey	5-50
ABS TOL Softkey	5-50
SEQ Softkey	5-50
Setting the Comparator Limit Mode	5-50
NOM Field	5-51
Setting the Nominal Value	5-51
COMP Field	5-51
ON Softkey	5-51
OFF Softkey	5-51
Turning the Comparator Function to ON or OFF	5-51
LOW/HIGH Fields	5-52
CLEAR LINE Softkey	5-52
Entering the LOW/HIGH Limits	5-52
2nd LOW/HIGH Fields	5-54
AUX Field	5-55
Setting the AUX BIN to ON or OFF	5-56
SYS MENU Field	5-56
Loading or Storing the Control Settings	5-56
CANCEL Softkey	5-57
CLEAR TABLE Softkey	5-57
Clearing the Limit Table	5-57
Printing the LIMIT TABLE SETUP Page	5-57
LIST SWEEP SETUP Page	5-59
MODE Field	5-61
Setting the List Sweep Measurement Mode	5-62
List Sweep Parameter Field	5-62
Setting the List Sweep Parameter	5-62
Sweep Points and Limit Fields	5-63
Setting the Sweep Points and Limits	5-64

SYS MENU Field	5-65
LOAD/STORE Softkey	5-65
Clear Table Function	5-66
Printing the LIST SWEEP SETUP Page	5-66

6. CATALOG/SYSTEM Menu

Introduction	6-1
CATALOG Page	6-1
Media Monitor Area	6-3
Record Number Monitor Area	6-3
Record Status Monitor Area	6-3
Comment Monitor Area	6-3
SYS MENU Field	6-3
CAT INT/CAT CARD Softkey	6-4
Specifying the Media Type	6-4
Loading or Storing the Instrument Control Setting	6-4
Printing the CATALOG Page	6-4
PURGE Softkey	6-5
CANCEL Softkey	6-5
Purging the Unused Record	6-5
SYSTEM CONFIG Page	6-6
BEEPER Field	6-9
Turning the Beeper ON or OFF	6-9
GPIB ADDRESS Field	6-9
Setting the GPIB Address	6-9
TALK ONLY Field	6-9
Setting the Talk-Only Mode	6-9
CONFIG Field	6-10
I BIAS Softkey	6-10
Q ADAPTER Softkey	6-10
OFF Softkey	6-10
Configuring the High DC Current Bias System	6-10
Configuring the Precision Q Measurement System	6-11
Back to the Normal LCR Measurement Mode	6-11
HANDLER I/F (#201)/(#202) Field	6-11
Setting the Handler Interface to ON or OFF	6-11
SCANNER I/F (#301) Field	6-12
Setting the Scanner Interface to ON or OFF	6-12
SYS MENU Field	6-12
Printing the SYSTEM CONFIG Page	6-12
CABLE CORRECTION Page	6-14
CABLE CORRECTION MENU Field	6-14
Choosing the 1 m Cable Correction Menu	6-14
Choosing the 2 m Cable Correction Menu	6-14
REF. 0m Softkey	6-15
OPEN Softkey	6-15
SHORT Softkey	6-15
LOAD Softkey	6-15
SAVE Softkey	6-16
ABORT Softkey	6-16
Performing the Cable Correction Data Measurement	6-16

SELF TEST Page	6-19
TEST MENU Field	6-20
Memory Card R/W Test	6-20
Performing the Memory Card R/W Test	6-21
LED Display Test	6-21
Performing the LED Display Test	6-21
LCD Display Test	6-22
Performing the LCD Display Test	6-22
Handler I/F Test	6-22
Scanner I/F EEPROM R/W Test	6-22
Performing the Scanner I/F EEPROM R/W Test	6-22
Scanner I/F I/O Test	6-23
Accessory Control I/F Test	6-23
Q-Adapter Buffer Test	6-23

7. Measurement Basics

Introduction	7-1
Basic Measurement Procedure	7-1
Impedance Parameters	7-1
Parallel/Series Circuit Mode	7-4
Selecting Circuit Mode of Capacitance	7-5
Small Capacitance	7-5
Large Capacitance	7-5
Selecting Circuit Mode of Inductance	7-5
Large Inductance	7-5
Small Inductance	7-6
Test Signal Level	7-7
Oscillator Level Setting	7-7
Signal Level Setting Selection Example for Inductance Measurements	7-7
Four-Terminal Pair Configuration	7-8
Measurement Contacts	7-9
Capacitance to Ground	7-9
Contact Resistance	7-11
Measurement Cable Termination	7-12
Extending Test Leads	7-14
Guarding for Low Capacitance Measurements	7-14
Shielding	7-15
Correction Functions	7-16
Performing OPEN Correction	7-19
Performing SHORT Correction	7-19
Performing LOAD Correction	7-20
Preparing the Standard	7-20
Reference Values for the LOAD Standard	7-20
Using the Pre-Measured Device for the LOAD	7-21
Parasitic Components Related to DUT Connection	7-21
Characteristics Example	7-22

8. Remote Control	
Introduction	8-1
General Purpose Interface Bus (GPIB)	8-1
GPIB Connection	8-1
GPIB Capability	8-3
GPIB Addressing	8-4
GPIB Bus Capability	8-4
ABORT I/O (IFC)	8-4
CLEAR LOCKOUT/SET LOCAL	8-4
DEVICE CLEAR (SDC or DCL)	8-4
LOCAL (GTL)	8-4
LOCAL LOCKOUT (LLO)	8-4
REMOTE	8-5
SPOLL	8-5
SERVICE REQUEST	8-5
TRIGGER (GET)	8-5
Test and Measurement Systems Language (TMSL)	8-6
Data Transfer	8-7
ASCII Format	8-7
Binary Format	8-9
Floating Point Format	8-10
Trigger System	8-12
Data Buffer Memory	8-16
Status Byte	8-20
Enabling the Status Byte	8-22
Operation Status Register Group	8-23
Standard Operation Status Condition Register	8-24
Standard Operation Status Event Register	8-25
Standard Operation Status Event Enable Register	8-26
Standard Event Status Register	8-27
Enabling the Event Status Register	8-30
Sample Programs	8-31
Control Settings	8-31
MEAS SETUP page	8-32
CORRECTION page	8-33
LIMIT TABLE SETUP page	8-34
LIST SWEEP SETUP page	8-35
Data Transfer Examples	8-36
ASCII Format	8-36
BINARY Format	8-38
9. Command Reference	
Introduction	9-1
Notation Conventions and Definitions	9-1
Command Structure	9-2
Command Abbreviations	9-4
Header and Parameters	9-5
NR1	9-5
NR2	9-6
NR3	9-6
Terminators	9-7
Program Message Terminators	9-7
Response Message Terminators	9-8
Command Reference	9-9
DISPlay Subsystem	9-10

:PAGE	9-11
:LINE	9-12
FREQuency Subsystem	9-13
VOLTage Subsystem	9-14
CURRent Subsystem	9-15
AMPLitude Subsystem	9-16
OUTPut Subsystem	9-17
:Bias MONitor:VOLTage	9-18
:Bias MONitor:CURRent	9-19
BIAS Subsystem	9-20
:STATe	9-21
:VOLTage	9-22
:CURRent	9-23
FUNCTion Subsystem	9-24
:IMPedance[:TYPE]	9-25
:IMPedance:RANGe	9-26
:IMPedance:RANGe:AUTO	9-27
:Source MONitor:VAC	9-28
:Source MONitor:IAC	9-29
:DEV<n>:MODE	9-30
:DEV<n>:REFerence	9-31
:DEV<n>:REFerence:FILL	9-32
LIST Subsystem	9-33
:FREQuency	9-34
:VOLTage	9-35
:CURRent	9-36
:BIAS:VOLTage	9-37
:BIAS:CURRent	9-38
:MODE	9-39
:BAND<n>	9-40
APERture Subsystem	9-41
TRIGger Subsystem	9-42
:IMMediate	9-43
:SOURce	9-44
:DELay	9-45
INITiate Subsystem	9-45
[:IMMediate]	9-46
:CONTinuous	9-47
FETCh? Subsystem	9-47
[:IMP]?	9-48
:Source MONitor:VAC?	9-49
:Source MONitor:IAC?	9-50
ABORt Subsystem	9-51
FORMat Subsystem	9-52
MEMory Subsystem	9-52
:DIM	9-53
:FILL	9-54
:CLEar	9-55
:READ?	9-56
CORRection Subsystem	9-56
:LENGth	9-58
:METHod	9-59
:OPEN	9-60
:OPEN:STATe	9-61
:SHORT	9-62

:SHORT:STATe	9-63
:LOAD:STATe	9-64
:LOAD:TYPE	9-65
:SPOT<n>:STATe	9-66
:SPOT<n>:FREQuency	9-67
:SPOT<n>:OPEN	9-68
:SPOT<n>:SHORT	9-69
:SPOT<n>:LOAD	9-70
:SPOT<n>:LOAD:STANdard	9-71
:USE	9-72
:USE:DATA?	9-73
:COLLect[:ACQuire]	9-74
:COLLect:SAVE	9-75
COMParator Subsystem	9-75
[:STATe]	9-77
:MODE	9-78
:TOLerance:NOMinal	9-79
:TOLerance:BIN<n>	9-80
:SEQuence:BIN	9-81
:Secondary LIMit	9-82
:Auxiliary BIN	9-83
:SWAP	9-84
:BIN:CLEAr	9-85
:BIN:COUNt[:STATe]	9-86
:BIN:COUNt:DATA?	9-87
:BIN:COUNt:CLEAr	9-88
Mass MEMory Subsystem	9-88
:LOAD:STATe	9-89
:STORe:STATe	9-90
SYSTem:ERRor?	9-91
STATus Subsystem	9-92
:OPERation[:EVENT]?	9-93
:OPERation:CONDition?	9-94
:OPERation:ENABle	9-95
Common Commands	9-96
*CLS	9-97
*ESE	9-98
*ESR?	9-99
*SRE	9-100
*STB?	9-101
*IDN?	9-102
*OPC	9-103
*WAI	9-104
*RST	9-105
*TST?	9-106
*TRG	9-107
*LRN?	9-108
*OPT?	9-110

A. Manual Changes	
Introduction	A-1
Manual Changes	A-1
CHANGE1	A-2
B. Error and Warning Messages	
Introduction	B-1
Error Messages	B-1
Operation Errors	B-1
GPIB Errors	B-1
Sample Program to Detect the Error	B-1
Operation Errors	B-3
GPIB Errors	B-12
Warning Messages	B-14
C. Initial Settings and System Memory	
Introduction	C-1
D. Write Protection	
Introduction	D-1
Write Protection Procedure	D-1
Index	

Figures

1-1. Serial Number Plate	1-1
1-2. Effective Measurement Range (Oscillator Level ≤ 1 V _{rms})	1-7
1-3. Effective Measurement Range (Oscillator Level > 1 V _{rms})	1-8
1-4. Accuracy Equations, K _i Factor, and K _{osc} Factor (Test Signal Level ≤ 1 V _{rms})	1-13
1-5. Accuracy Equations and K _i Factor (Test Signal Level $>$ 1 V _{rms})	1-14
1-6. Temperature Factor K _t	1-15
1-7. Sum of the DC Bias Settling Time and DUT (Capacitor) Charge Time	1-24
2-1. Power Cable Supplied	2-4
2-2. Line Voltage Selector	2-5
2-3. Rack Mount Kits Installation	2-8
3-1. Front Panel Overview	3-2
3-2. Rear Panel Overview	3-5
3-3. Display Area Definition	3-7
3-4. MENU keys	3-9
3-5. Display Pages (1/3)	3-13
3-6. CURSOR Keys and Field Operation Example	3-16
3-7. Softkey Selection Example	3-16
4-1. Available Fields on the MEAS DISPLAY Page	4-2
4-2. Available Softkeys on the MEAS DISPLAY Page	4-3
4-3. MEAS DISPLAY Page Printout Example	4-7
4-4. Available Fields on the BIN No. DISPLAY Page	4-11
4-5. Available Softkeys on the BIN No. DISPLAY Page	4-12
4-6. BIN No. DISPLAY Page Printout Example	4-14
4-7. Available Fields on the BIN COUNT DISPLAY Page	4-15
4-8. Available Softkeys on the BIN COUNT DISPLAY Page	4-16
4-9. BIN COUNT DISPLAY Page Printout Example	4-18
4-10. Available Fields on the LIST SWEEP DISPLAY Page	4-20
4-11. Available Softkeys on the LIST SWEEP DISPLAY Page	4-20
4-12. List Sweep Modes	4-21
4-13. LIST SWEEP DISPLAY Page Printout Example	4-23
5-1. Available Fields on the MEAS SETUP Page	5-2
5-2. Available Softkeys on the MEAS SETUP Page	5-3
5-3. Measurement Function Display Order	5-5
5-4. Effective Measuring Range for Each Measurement Range	5-5
5-5. DC BIAS Current	5-11
5-6. COMMENT INPUT Page Layout	5-13
5-7. Required External Trigger Pulse Specification	5-15
5-8. Feedback Circuit	5-17
5-9. Available Operating Area For the ALC Function	5-18
5-10. MEAS SETUP Page After Clearing the Setup	5-24

5-11.	MEAS SETUP Page Printout Example	5-25
5-12.	Available Fields on the CORRECTION Page	5-27
5-13.	Available Softkeys on the CORRECTION Page	5-28
5-14.	Stray Admittance Model	5-29
5-15.	OPEN/SHORT Correction Using The Interpolation Method	5-30
5-16.	Residual Impedance Model	5-32
5-17.	Spot OPEN/SHORT/LOAD Correction	5-34
5-18.	Display Order of the Measurement Function	5-39
5-19.	CORRECTION Page Print Example	5-43
5-20.	Available Fields on the LIMIT TABLE SETUP Page	5-45
5-21.	Available Softkeys on the LIMIT TABLE SETUP Page	5-46
5-22.	Swap Parameter Function	5-47
5-23.	Tolerance Mode and Sequential Mode	5-48
5-24.	Tolerance Limit with Overlaps and Gaps	5-49
5-25.	Limit Table Using the Sequential Mode	5-53
5-26.	LIMIT TABLE SETUP Page Example	5-58
5-27.	Available Fields on the LIST SWEEP SETUP Page	5-60
5-28.	Available Softkeys on the LIST SWEEP SETUP Page	5-61
5-29.	SEQ mode and STEP mode	5-62
5-30.	List Sweep Settings	5-63
5-31.	LIST SWEEP SETUP Page Example	5-66
6-1.	Available Fields on the CATALOG Page	6-2
6-2.	Available Softkeys on the CATALOG Page	6-2
6-3.	CATALOG Page Example	6-5
6-4.	Available Fields on the SYSTEM CONFIG Page	6-7
6-5.	Available Softkeys on the SYSTEM CONFIG Page	6-8
6-6.	SYSTEM CONFIG Page Example	6-13
6-7.	Cable Correction Page	6-16
6-8.	OPEN Termination (Alternative)	6-17
6-9.	SHORT Termination (Alternative)	6-18
6-10.	Available Fields on the SELF TEST Page	6-19
6-11.	Available Softkeys on the SELF TEST Page	6-20
7-1.	Definition of Impedance	7-2
7-2.	Vector Representation of Admittance	7-4
7-3.	Capacitance Circuit Mode Selection	7-5
7-4.	Inductance Circuit Mode Selection	7-6
7-5.	Four-Terminal Pair Measurement Principle	7-8
7-6.	Measurement Contacts	7-9
7-7.	Model of Capacitance to Ground	7-10
7-8.	Reducing Capacitance to Ground	7-11
7-9.	Contact Configuration	7-12
7-10.	Termination Method	7-13
7-11.	Termination Method (informal method)	7-13
7-12.	Measurement Contacts for Test Leads Extension	7-14
7-13.	Example of DUT Guard Plate Connection	7-14
7-14.	Guard Shield	7-15
7-15.	Sample Shorting Plate	7-19
7-16.	Shorting Plate Connection	7-20
7-17.	Parasitic Impedance Model (Using the 16047A/C/D or 16034E)	7-22
7-18.	Typical Characteristics of Components	7-23
8-1.	GPIB Connector Signal/Pin Configuration	8-2
8-2.	Typical GPIB System Interconnection	8-3
8-3.	Functional Layers Diagram	8-6

8-4. ASCII Format 1	8-7
8-5. ASCII Format 2 (List Sweep)	8-8
8-6. BINARY Format 1	8-9
8-7. Binary Data Format For List Sweep Measurement	8-11
8-8. Trigger State Diagram	8-12
8-9. INITiate Subsystem Commands and Trigger System	8-12
8-10. Trigger System and Trigger Commands	8-13
8-11. TRIGger:IMMediate Command Sample Program	8-14
8-12. *TRG or GET Command Sample Program	8-14
8-13. Triggering System and Data Transfer	8-15
8-14. Buffered Data Transfer Sample Program and Description	8-16
8-15. ASCII Format (Buffer Memory)	8-18
8-16. BINARY Format (Buffer Memory)	8-18
8-17. Status Byte Register	8-20
8-18. Operation Status Register Structure	8-23
8-19. Standard Event Status Register	8-28
8-20. MEAS SETUP Page	8-32
8-21. CORRECTION page	8-33
8-22. LIMIT TABLE SETUP page	8-34
8-23. LIST SWEEP SETUP	8-35
8-24. Sample Program (Comparator) Using ASCII Format	8-36
8-25. Sample Program (Buffer Memory) Using ASCII Format	8-37
8-26. Sample Program (List Sweep) Using ASCII Format	8-37
8-27. Sample Program (Comparator) Using BINARY Format	8-38
8-28. Sample Program (Buffer Memory) Using BINARY Format	8-39
8-29. Sample Program (List Sweep) Using BINARY Format	8-39
9-1. Command Tree Example	9-2
9-2. Command Header and Parameters	9-5
9-3. DISPlay Subsystem Command Tree	9-10
9-4. OUTPut Subsystem Command Tree	9-17
9-5. BIAS Subsystem Command Tree	9-20
9-6. FUNCtion Subsystem Command Tree	9-24
9-7. LIST Subsystem Command Tree	9-33
9-8. TRIGger Subsystem Command Tree	9-42
9-9. INITiate Subsystem Command Tree	9-45
9-10. FETCh? Subsystem Command Tree	9-47
9-11. MEMory Subsystem Command Tree	9-52
9-12. CORREction Subsystem Command Tree	9-57
9-13. COMParator Subsystem Command Tree	9-76
9-14. Mass MEMory Subsystem Command Tree	9-88
9-15. STATus Subsystem Command Tree	9-92
D-1. A7 Digital Board Location	D-2
D-2. Write Protection Switch	D-3

Tables

1-1. A_n Equations	1-11
1-2. N Accuracy Factors	1-12
2-1. 4285A Contents	2-2
2-2. Line Voltage Selection	2-5
2-3. Fuse Selection	2-5
2-4. Rack Mount Kits	2-7
5-1. Measurement Function	5-4
5-2. Oscillator Level and Resolution	5-9
5-3. DC Bias and Resolution (Option 001)	5-10
5-4. ALC Function Setting Range	5-16
5-5. Preset Correction Frequency Points	5-29
7-1. Parallel/Series Circuit Model	7-4
7-2. Correction Functions	7-16
8-1. GPIB Interconnect Cables	8-2
8-2. GPIB Interface Capability	8-3
8-3. Data Format and Data Transfer Time	8-19
8-4. Status Byte Assignments	8-21
8-5. Standard Operation Status Condition Register Assignments	8-24
8-6. Standard Operation Status Event Register Assignments	8-25
8-7. Standard Event Status Register Assignments	8-29
9-1. Multiplier Mnemonics	9-6
9-2. Suffix Units and Available Commands	9-7
A-1. Manual Changes by Serial Number	A-1
A-2. Manual Changes by Firmware's Version	A-1

General Information

Introduction

This chapter describes specifications, supplemental performance characteristics, and other general information about the 4285A.

Components not Covered by Warranty

The memory card is not covered under the 4285A's warranty. If the memory card becomes defective even within the warranty period of the 4285A, the memory card must be paid for by the user.

Serial Number

Agilent Technologies uses a two-section, nine character serial number which is stamped on the serial number plate (Figure 1-1) attached to the instrument's rear panel. The first four digits and a letter are the serial number prefix, and the last five digits are the suffix. The letter placed between the two sections identifies the country where the instrument was manufactured. The prefix is the same for all identical instruments; it changes only when a change is made to the instrument. The suffix, however, is assigned sequentially and is different for each instrument. The contents of this manual apply to instruments with the serial number prefix(es) listed under the serial numbers on the title page.



Figure 1-1. Serial Number Plate

An instrument manufactured after the printing of this manual may have a serial number prefix that is not listed on the title page. This unlisted serial number prefix indicates the instrument is different from those described in this manual. The manual for this new instrument may be accompanied by a yellow Manual Change supplement or have a different manual part number. This sheet contains “change information” that explains how to adapt the manual to the newer instrument.

In addition to change information, the supplement may contain information for correcting errors (Errata) in the manual. To keep this manual as current and accurate as possible, Agilent Technologies recommends that you periodically request the latest Manual Changes supplement. The supplement for this manual is identified by this manual's printing date and its part number, both of which appear on the manual's title page. Complimentary copies of the supplement are available from Agilent Technologies. If the serial prefix or number of an instrument is lower than that on the title page of this manual, see Appendix A. For information concerning a serial number prefix that is not listed on the title page or in the Manual Change supplement, contact the nearest Agilent Technologies office.

Specifications

The complete 4285A specifications are listed below. These specifications are the performance standards or limits against which the instrument is tested. When shipped from the factory, the 4285A meets the specifications listed in this section. The specification test procedures are covered in *4285A Maintenance Manual* (Agilent Part Number 04285-90030).

Measurement Functions

Measurement Parameters

|Z| : Absolute value of impedance
|Y| : Absolute value of admittance
L : Inductance
C : Capacitance
R : Resistance
G : Conductance
D : Dissipation factor
Q : Quality factor
R_s : Equivalent series resistance
R_p : Parallel resistance
X : Reactance
B : Suceptance
 θ : Phase angle

Combinations of Measurement Parameters

Z , Y	L, C	R	G
$\theta(\text{deg}), \theta(\text{rad})$	D, Q, R _s , R _p , G	X	B

Mathematical Functions

The deviation and the percent of deviation of measurement values from a programmable reference value.

Equivalent Measurement Circuit

Parallel and Series

Ranging

Auto and Manual (Hold/Up/Down)

Trigger

Internal, External, BUS (GPIB), and Manual.

Delay Time

Programmable delay from the trigger command to the start of the measurement, 0 to 60.000 s in 1 ms steps.

Measurement Terminals

Four-terminal pair

Test Cable Length

0 m, 1 m, and 2 m selectable

Integration Time

Short, Medium, and Long selectable (Refer to “Supplemental Performance Characteristics” for the measurement time.)

Averaging

1 to 256, programmable

Test Signal

Frequency

75 kHz to 30 MHz, 100 Hz resolution.

Frequency Accuracy

±0.01%

Signal Modes

Normal. Program selected voltage or current at the measurement terminals when they are opened or shorted, respectively.

Constant. Maintains selected voltage or current at the device under test (DUT) independent of changes in the device’s impedance.

Signal Level

The following test signal level accuracy is specified for an ambient temperature range of 23°C±5°C and the test cable length is 0 m.

	Mode	Range	Setting Accuracy
Voltage	Normal	5 mV _{rms} to 2 V _{rms}	±{(8 + 0.4f _m)% + 1 mV _{rms} }
	Constant ¹	10 mV _{rms} to 1 V _{rms}	±{(6 + 0.2f _m)% + 1 mV _{rms} }
Current	Normal	200 μA _{rms} to 20 mA _{rms}	±{(8 + 1f _m)% + 40 μA _{rms} }
	Constant ¹	100 μA _{rms} to 20 mA _{rms}	±{(6 + 0.2f _m)% + 40 μA _{rms} }

¹: When the ALC function is set to ON.

For the temperature range of 0°C to 55°C, multiply the temperature induced setting error listed in Figure 1-6 to the test signal setting accuracy. When test cable length is 1 m or 2 m, add the following error due to test cable length.

$$0.2 \times f_m \times L \quad [\%]$$

Where,

f_m : Test frequency [MHz],

L : Test cable length [m].

Output Impedance

The following output impedance is specified for the test cable length is 0 m :

$$(25 + 0.5f_m)\Omega \pm \left(10 + \frac{2}{3}f_m\right) \%$$

Where,

f_m : Test frequency [MHz]

Test Signal Level Monitor

The following test signal level monitor accuracy is specified for an ambient temperature range of $23^\circ\text{C} \pm 5^\circ\text{C}$ and the test cable length is 0 m.

Mode	Range	Monitor Accuracy
Voltage	0.01 mV _{rms} - 2.000V _{rms}	$\pm \left\{ S_{mon} \frac{4+0.2f_m}{100} + S_{set}/500 \right\}$ [V]
Current	0.001 μA_{rms} - 20.00 mA _{rms}	

For the temperature range of 0°C to 55°C , multiply the temperature induced setting error listed in Figure 1-6. When test cable length is 1 m or 2 m, add the following error due to test cable length.

$$S_{mon} \times 0.2 \times f_m \times L \quad [\text{V}]$$

Where,

f_m : Test frequency [MHz],

L : Test cable length [m].

S_{mon} : Readout value of test signal level

S_{set} : Setting value of test signal level

For example,

Test frequency : 1 MHz

Test signal level : 1 V_{rms}

Monitor readout value : 500 mV_{rms}

Cable length : 1 m

Ambient temperature : 25°C

Then, Voltage level monitor accuracy V_{ma} is

$$\begin{aligned} \Delta V_{ma} &= 0.5 \times \frac{4 + 0.2 \times 1}{100} + \frac{1 \times 0.2}{100} + 0.5 \times \frac{0.2}{100} \times 1 \times 1 \\ &= 0.024 \quad [\text{V}] \end{aligned}$$

$$\begin{aligned} V_{ma} &= \frac{0.024}{0.5} \\ &\approx 4.8 \quad [\%] \end{aligned}$$

Display Range

Parameter	Range
Z , R, X	0.00001 Ω to 99.9999 M Ω
Y , G, B	0.00001 μ S to 99.9999 S
C	0.00001 pF to 999.999 μ F
L	0.001 nH to 99.9999 H
D	0.000001 to 9.99999
Q	0.01 to 99999.9
θ	-180.000 $^{\circ}$ to 180.000 $^{\circ}$
Δ	-999.999% to 999.999%

Measurement Accuracy

The measurement accuracy includes stability, temperature coefficient, linearity, repeatability and calibration interpolation error. The measurement accuracy is specified when all of the following conditions are satisfied:

- Warm-up time : \geq 30 minutes
- Test cable length : 0 m, 1 m (16048A), or 2 m (16048D)
For the 1 m or 2 m cable length operation (with 16048A/D), CABLE CORRECTION has been performed.
- OPEN and SHORT corrections have been performed.
- The optimum measurement range is selected by matching the DUT's impedance to the effective measuring range shown in Figure 1-2 and Figure 1-3. (For example, if the DUT's impedance is 3 k Ω and oscillator level is less than or equal 1V, the optimum range is the 500 Ω range.)
- Measurement accuracy is specified at the following reference planes.
 - Test frequency \leq 1MHz
At the UNKNOWN terminals on the 4285A front panel or at the end of the standard test leads (16048A/D).
 - Test frequency \geq 1.001MHz
At the 1-port terminal of the 16085B Terminal Adapter which should be connected to the UNKNOWN terminals of the 4285A or to the end of the standard test leads (16048A/D).

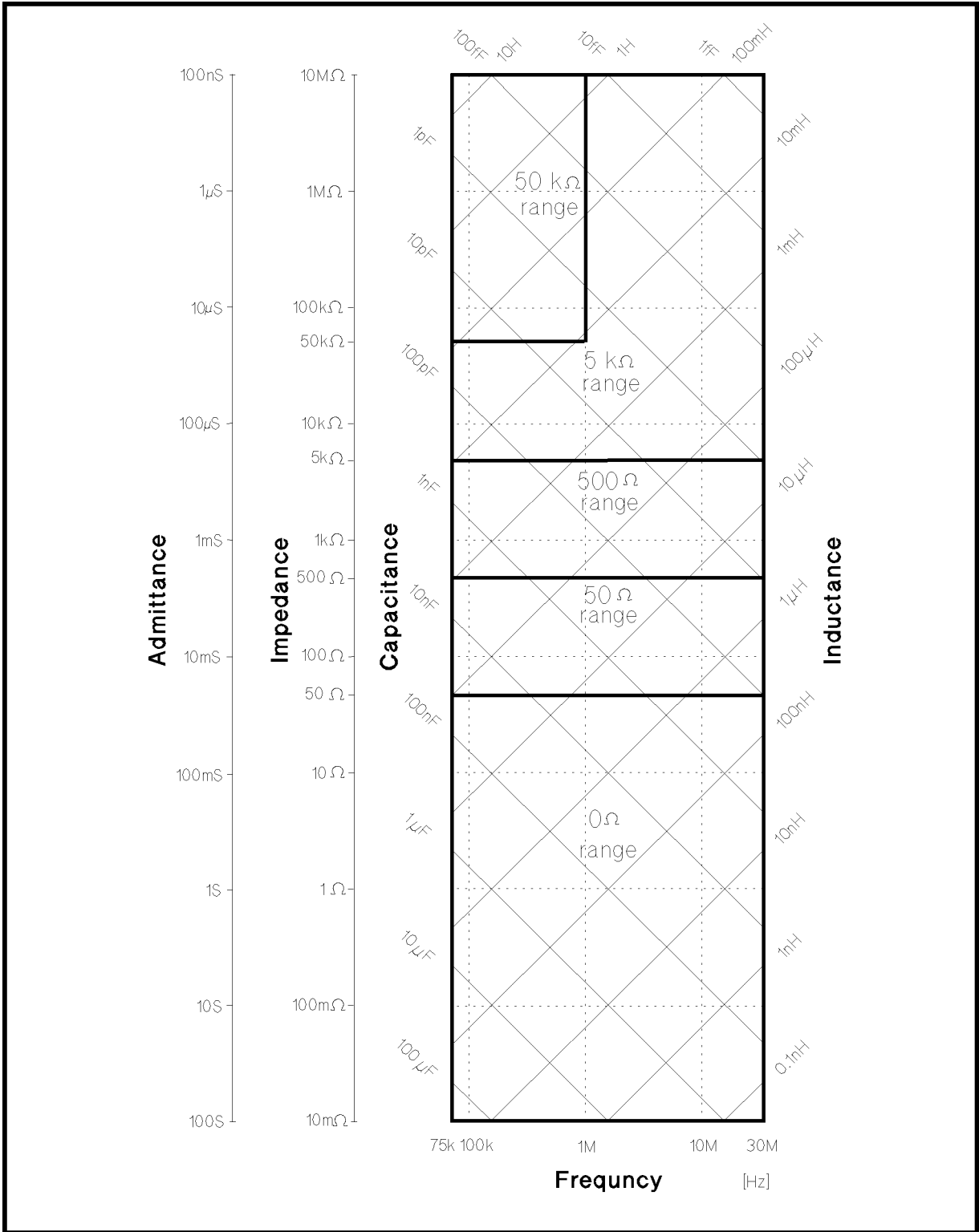

L2001002

Figure 1-2.
Effective Measurement Range
(Oscillator Level $\leq 1 V_{rms}$)

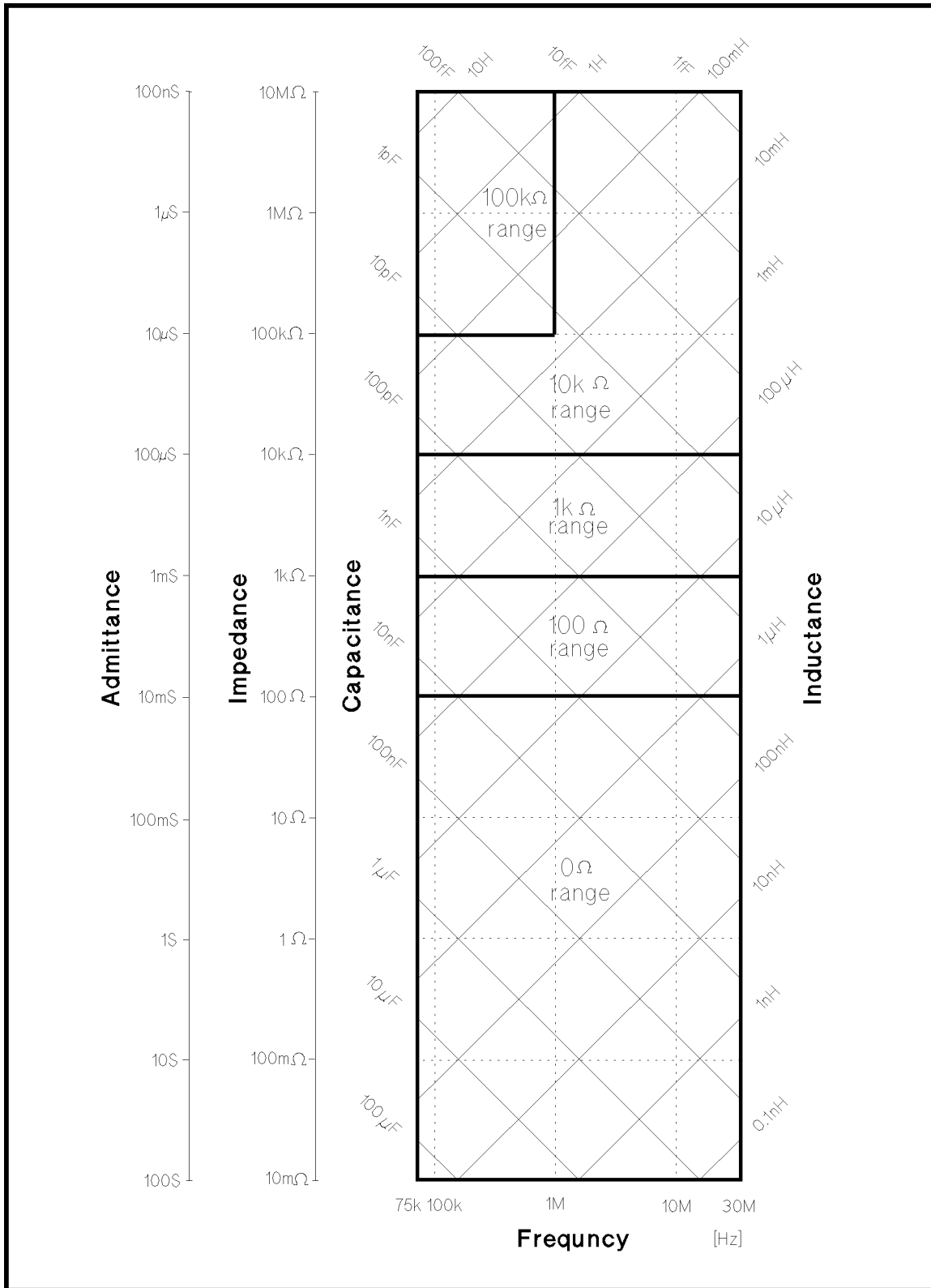

L2001007

Figure 1-3.
Effective Measurement Range
(Oscillator Level > 1 V_{rms})

|Z|, |Y|, L, C, R, X, G, and B Accuracy

|Z|, |Y|, L, C, R, X, G, and B accuracy A_e is given as

$$A_e = \pm(A_n + A_c) \times K_t \quad [\%]$$

Where,

A_n : Basic accuracy equation given from the A_1 to A_{16} shown in Table 1-1. The applicable frequency range and impedance range of equations, A_1 to A_{16} , are shown in Figure 1-4 or Figure 1-5. (Refer to “Basic Accuracy Equations”.)

A_c : Cable Length Factor (Refer to “Cable Length Factor”.)

K_t : Temperature Factor (Refer to “Temperature Factor”.)

L, C, X, and B accuracies apply when D_x (measured D value) ≤ 0.1 .

When $D_x > 0.1$, multiply A_e by $\sqrt{1 + D_x^2}$ for L, C, X, and B accuracies.

R and G accuracies apply when Q_x (measured Q value) ≤ 0.1 .

When $Q_x > 0.1$, multiply A_e by $\sqrt{1 + Q_x^2}$ for R and G accuracies. G accuracy given by the equation above applies to the G-B combination only.

D Accuracy

D accuracy D_e is given as,

$$D_e = \pm \frac{A_e}{100}$$

Where,

A_e : |Z|, |Y|, L, C, R, X, G, and B accuracy

D accuracy applies when D_x (measured D value) ≤ 0.1 .

When $D_x > 0.1$, multiply D_e by $(1 + D_x)$.

Q Accuracy

Q accuracy Q_e is given as,

$$Q_e = \pm \frac{Q_x^2 \times D_e}{1 \mp Q_x \times D_e}$$

Where,

Q_x : Measured Q value,

D_e : D accuracy.

Q accuracy applies when $Q_x \times D_e < 1$.

θ Accuracy

θ accuracy θ_e is given as,

$$\theta_e = \pm \frac{180 \times A_e}{\pi \times 100} \quad [deg]$$

Where,

A_e : |Z|, |Y|, L, C, R, X, G, and B accuracy

G Accuracy

G accuracy G_e is given as,

$$G_e = \pm B_x \times D_e \quad [S]$$

$$\left(B_x = 2\pi f C_x = \frac{1}{2\pi f L_x} \right)$$

Where,

B_x : Measured B value [S],
 C_x : Measured C value [F],
 L_x : Measured L value [H],
 D_e : D accuracy,
 f : Test frequency [Hz].

G accuracy applies when D_x (measured D value) ≤ 0.1 .

G accuracy given by the equation above applies to the C_p-G and L_p-G combinations only.

R_p Accuracy

R_p accuracy R_{pe} is given as,

$$R_{pe} = \pm \frac{R_{px} \times D_e}{D_x \mp D_e} \quad [\Omega]$$

Where,

R_{px} : Measured R_p value [Ω],
 D_x : Measured D value,
 D_e : D accuracy.

R_p accuracy applies when D_x (measured D value) ≤ 0.1 .

R_s Accuracy

R_s accuracy R_{se} is given as,

$$R_{se} = \pm X_x \times D_e \quad [\Omega]$$

$$\left(X_x = 2\pi f L_x = \frac{1}{2\pi f C_x} \right)$$

Where,

X_x : Measured X value [Ω],
 C_x : Measured C value [F],
 L_x : Measured L value [H],
 D_e : D accuracy,
 f : Test frequency [Hz].

R_s accuracy applies when D_x (measured D value) ≤ 0.1 .

Basic Accuracy Equations

The basic accuracy A_n is calculated from the following procedure.

1. Determine A_n equation from Figure 1-4 or Figure 1-5. In both charts, boundary line belongs to the better accuracy area.

When the oscillator level $\leq 1V_{\text{rms}}$, determine A_n to be applied, value of K_i and value of K_{osc} from the Figure 1-4. If the determined $K_{osc} \leq 1$, then round up K_{osc} to 1.

When the oscillator level $> 1V_{\text{rms}}$, determine A_n to be applied and value of K_i from the Figure 1-5.

- Calculate A_n from the formula to be applied. The n accuracy factor included in the A_n equation is shown in Table 1-2. Use K_i and K_{osc} factors determined in previous step.

Table 1-1. A_n Equations

$A_1 = N_1 \% + \left(\frac{f_m}{30}\right)^2 \cdot 3\% + \frac{50}{ Z_m } [0.02\% + \left(\frac{f_m}{30}\right) \cdot 0.1\%] \cdot K_i \cdot K_{osc}$
$A_2 = N_1 \% + \left(\frac{f_m}{30}\right)^2 \cdot 3\% + \frac{ Z_m }{50} [0.02\% + \left(\frac{f_m}{30}\right) \cdot 0.05\%] \cdot K_i \cdot K_{osc}$
$A_3 = N_1 \% + \left(\frac{f_m}{5}\right)^2 \cdot 0.1\% + \frac{ Z_m }{500} [0.02\% + \left(\frac{f_m}{30}\right) \cdot 0.05\%] \cdot K_i \cdot K_{osc}$
$A_4 = 0.3\% + \left(\frac{f_m}{30}\right)^2 \cdot 3\% + \frac{ Z_m }{500} [0.05\% + \left(\frac{f_m}{30}\right) \cdot 0.1\%] \cdot K_i \cdot K_{osc}$
$A_5 = 0.18\% + \frac{ Z_m }{5k} \cdot 0.02\% \cdot K_i \cdot K_{osc}$
$A_6 = 0.18\% + \left(\frac{f_m}{30}\right)^2 \cdot 3\% + \frac{ Z_m }{5k} [0.02\% + \left(\frac{f_m}{10}\right) \cdot 0.03\%] \cdot K_i \cdot K_{osc}$
$A_7 = 0.5\% + \left(\frac{f_m}{30}\right)^2 \cdot 3\% + \frac{ Z_m }{5k} \cdot \left(\frac{f_m}{30}\right) \cdot 0.2\% \cdot K_i \cdot K_{osc}$
$A_8 = 0.18\% + \frac{ Z_m }{50k} \cdot 0.03\% \cdot K_i \cdot K_{osc}$
$A_9 = N_2 \% + \left(\frac{f_m}{30}\right)^2 \cdot 3\% + \frac{100}{ Z_m } [0.02\% + \left(\frac{f_m}{30}\right) \cdot 0.1\%] \cdot K_i$
$A_{10} = N_2 \% + \left(\frac{f_m}{30}\right)^2 \cdot 3\% + \frac{ Z_m }{100} [0.02\% + \left(\frac{f_m}{30}\right) \cdot 0.05\%] \cdot K_i$
$A_{11} = 0.18\% + \left(\frac{f_m}{5}\right)^2 \cdot 0.1\% + \frac{ Z_m }{1k} [0.02\% + \left(\frac{f_m}{30}\right) \cdot 0.05\%] \cdot K_i$
$A_{12} = 0.3\% + \left(\frac{f_m}{30}\right)^2 \cdot 3\% + \frac{ Z_m }{1k} [0.05\% + \left(\frac{f_m}{30}\right) \cdot 0.1\%] \cdot K_i$
$A_{13} = 0.18\% + \frac{ Z_m }{10k} \cdot 0.02\% \cdot K_i$
$A_{14} = 0.18\% + \left(\frac{f_m}{30}\right)^2 \cdot 3\% + \frac{ Z_m }{10k} [0.02\% + \left(\frac{f_m}{10}\right) \cdot 0.03\%] \cdot K_i$
$A_{15} = 0.5\% + \left(\frac{f_m}{30}\right)^2 \cdot 3\% + \frac{ Z_m }{10k} \cdot \left(\frac{f_m}{30}\right) \cdot 0.2\% \cdot K_i$
$A_{16} = 0.18\% + \frac{ Z_m }{100k} \cdot 0.03\% \cdot K_i$
$ Z_m $: Absolute value of measured impedance in [Ω]
f_m : Test frequency in [MHz]

N Accuracy Factors

N_1 and N_2 in the A_n equations have the following values:

Table 1-2. N Accuracy Factors

Frequency(f)	N_1	N_2
$75 \text{ kHz} \leq f \leq 200 \text{ kHz}$	0.15	0.15
$200 \text{ kHz} < f \leq 3 \text{ MHz}$	0.08	0.15
$3 \text{ MHz} < f \leq 5 \text{ MHz}$	0.15	0.38
$5 \text{ MHz} < f \leq 30 \text{ MHz}$	0.30	0.38

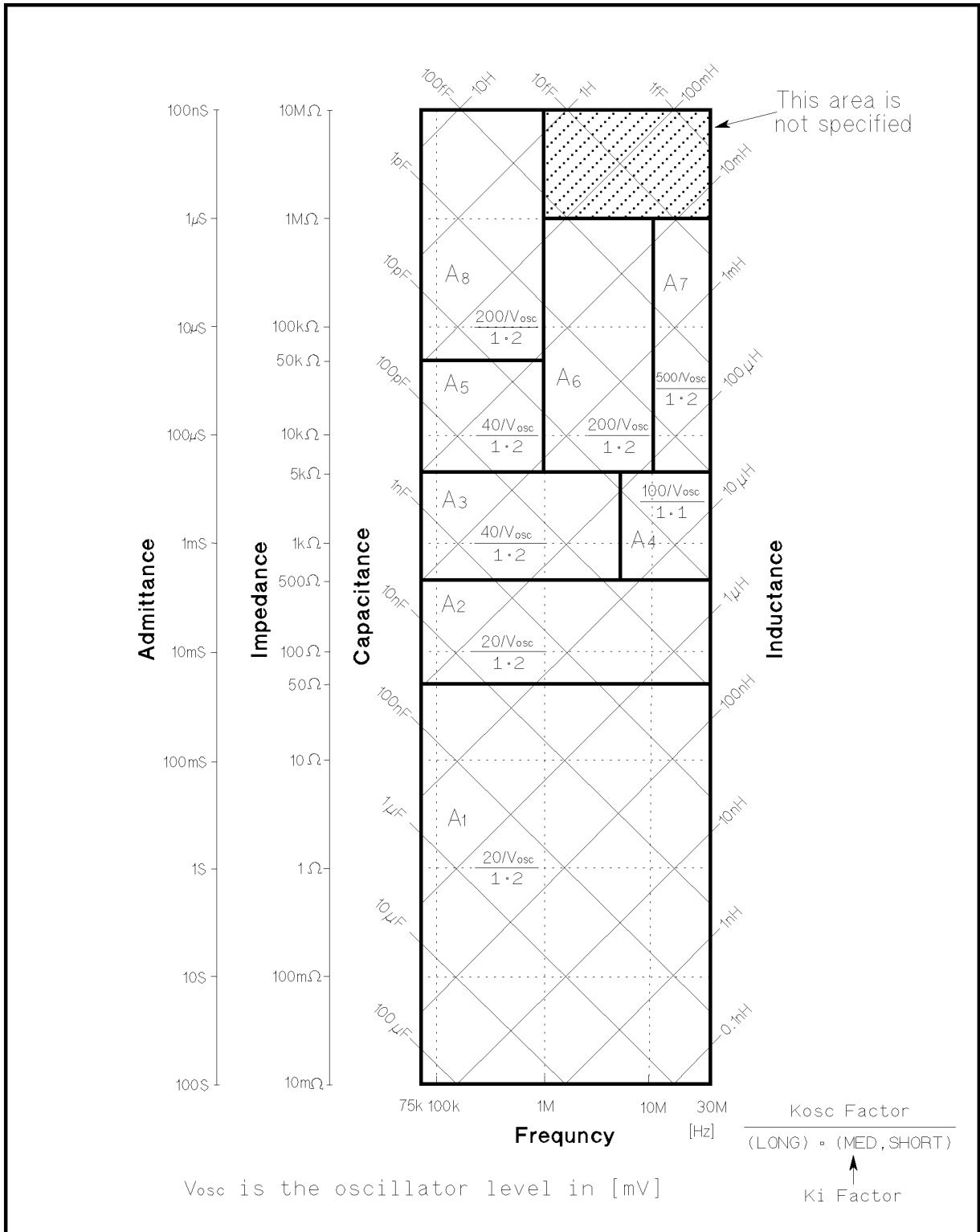

L2001003

Figure 1-4.
Accuracy Equations, K_i Factor, and K_{osc} Factor
(Test Signal Level $\leq 1 V_{\text{RMS}}$)

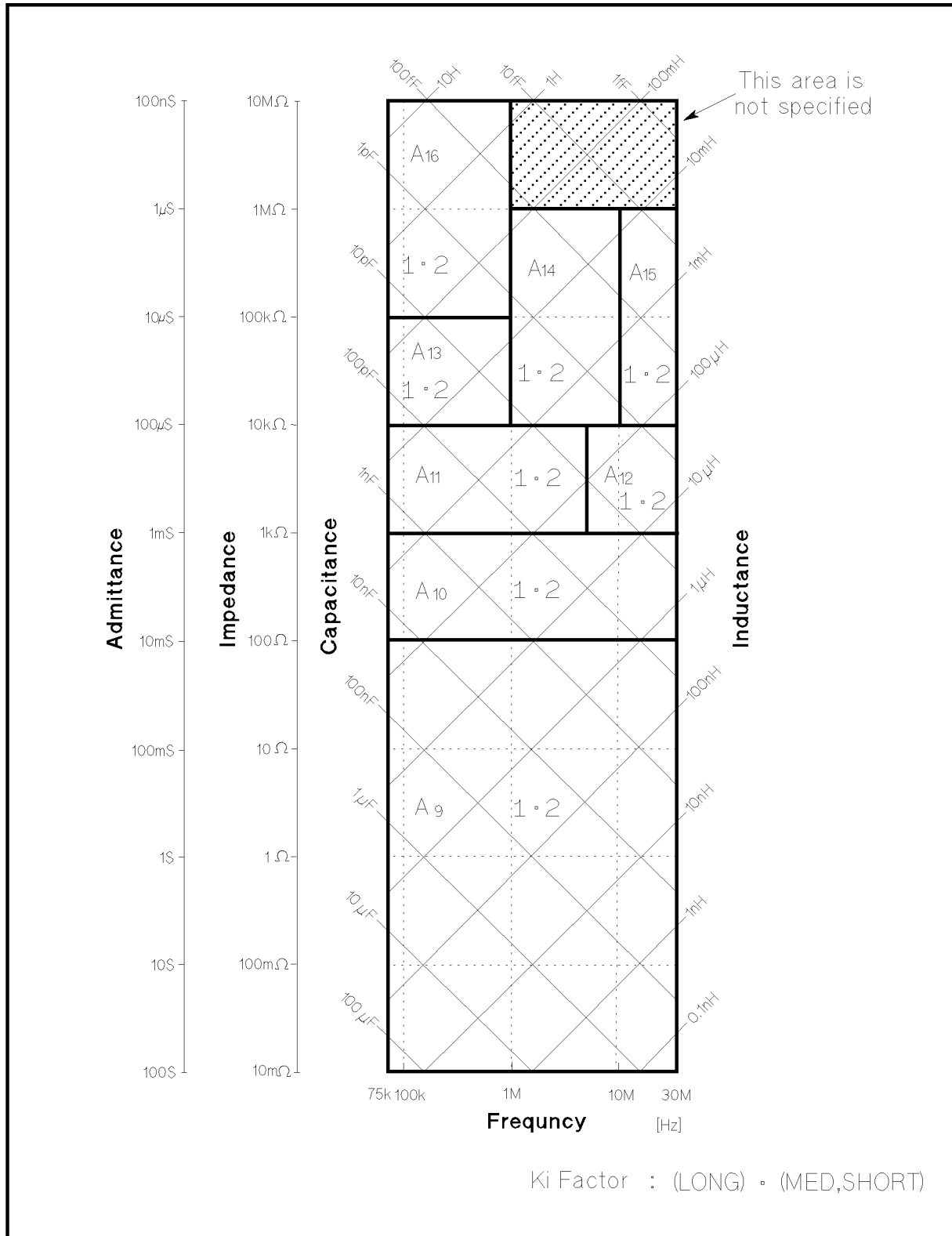

L2001004

Figure 1-5.
Accuracy Equations and K_i Factor
(Test Signal Level > 1 V_{rms})

Cable Length Factor

Add the following cable length factor A_c to the measurement accuracy, when the cable length is set to 1 m (for 16048A) or 2 m (for 16048D) in *CABLE* field, after performing the cable correction and the OPEN/SHORT correction. When the cable length is 0 m, A_c is 0 percent.

$$A_c = \frac{f_m}{15} + A_{co} \quad [\%]$$

A_{co} is the additional error when the impedance range is above 5 k Ω .

$$A_{co} = \frac{|Z_m| \cdot f_m \cdot K_l}{1000} \quad [\%]$$

where,

- f_m : Test frequency in [MHz]
- Z_m : Absolute value of measured impedance in [k Ω]
- K_l : Test cable length in [m]

Temperature Factor

Multiply the sum of the basic accuracy and the cable length factor by the following temperature induced error K_t , when the temperature range of 0°C to 55°C. The boundary belongs to the smaller multiplier.

Temperature (°C)	0	8	18	28	38	48	55
K_t	\	x3	x2	x1	x2	x3	x4

Figure 1-6. Temperature Factor K_t

Measurement Accuracy Calculation Example

Example of L_s -Q Accuracy Calculation

Measurement Conditions

- Measured inductance L_x of DUT: 220 nH
- Measured Q Value of DUT: 30
- Test Signal Level : 1 V_{rms}
- Test Frequency f_m : 25.2 MHz
- Integration Time : LONG
- Cable Length : 0 m
- Operating Temperature : 28 °C

Determine inductance measurement accuracy A_e .

1. From the “|Z|, |Y|, L, C, R, X, G, and B Accuracy”, measurement accuracy A_e is determined as below.

$$A_e = \pm(A_n + A_c) \times K_t$$

2. First of all, to determine the measurement accuracy A_e , calculate the impedance value from the DUT's inductance value. So the measurement impedance Z_m is :

$$Z_m = 2\pi f_m L_x$$

$$\approx 35 \quad [\Omega]$$

Where,

f_m : Test frequency [Hz]

L_x : Measured inductance value of the DUT [H]

3. Choose an accuracy chart from Figure 1-4 and Figure 1-5. The oscillator level is 1 V_{rms}, then Figure 1-4 is chosen for this measurement.
4. Find the frequency point of f_m (25.2 MHz) along the X axis in Figure 1-4. Both axis are in log format. Interpolation may be required.
5. Find the impedance point of Z_m (35 Ω) along the Y axis in Figure 1-4 determined in step 2. Both axis are in log format. Interpolation may be required.
6. Mark the intersection of above two steps and determine the basic accuracy equation A_n , integration factor K_i , and oscillator level factor K_{osc} .

From

Test frequency f_m : 25.2 MHz

DUT's impedance Z_m : 35 Ω

Integration time : LONG

Test signal level : 1 V_{rms}

Then, $A_n = A_I$, $K_i = 1$, and $K_{osc} = 1$ (Rounded from 0.02).

7. From the Table 1-1, actual accuracy equation to be applied is determined as A_I .

Then,

$$A_1 = N_1\% + \left(\frac{f}{30}\right)^2 \cdot 3\% + \frac{50}{|Z_m|} \left[0.02\% + \left(\frac{f}{30}\right) \cdot 0.1\%\right] \cdot K_i \cdot K_{osc}$$

8. Determine N_I from Table 1-2.

From frequency=25.2 MHz,

then, $N_I = 0.3$.

9. Then,

$$A_n = 0.3\% + \left(\frac{25.2}{30}\right)^2 \cdot 3\% + \frac{50}{|35|} \left[0.02\% + \left(\frac{25.2}{30}\right) \cdot 0.1\%\right] \cdot 1 \cdot 1$$

$$\approx 2.6 \quad [\%]$$

10. Cable length is 0 m, then $A_c = 0$.

11. Operating temperature is 28°C, then $K_t = 1$ from the Figure 1-6.

12. Therefore, inductance measurement accuracy A_e is :

$$\begin{aligned}
A_e &= \pm (A_n + A_c) \times K_t \\
&= \pm (2.6 + 0) \times 1 \\
&= \pm 2.6 \quad [\%]
\end{aligned}$$

Determine Q measurement accuracy Q_e .

1. From the “Q Accuracy”, Q measurement accuracy Q_e is determined as below.

$$Q_e = \pm \frac{Q_x^2 \times D_e}{1 \mp Q_x \times D_e}$$

2. Determine D accuracy D_e for calculating Q_e . From the previous step “Determine inductance measurement accuracy A_e ”, A_e is 2.6 [%], then :

$$\begin{aligned}
D_e &= \pm \frac{A_e}{100} \\
&= \pm 0.026
\end{aligned}$$

3. Therefore Q_e is :

$$\begin{aligned}
Q_e &= \pm \frac{Q_x^2 \times D_e}{1 \mp Q_x \times D_e} \\
&= \pm \frac{30^2 \times 0.026}{1 \mp 30 \times 0.026} \\
&\approx +106 / -13
\end{aligned}$$

Correction Functions

Zero Open

Eliminates measurement errors due to parasitic stray admittance (C, G) of the test fixture.

Zero Short

Eliminates measurement errors due to parasitic residual impedances (L, R) of the test fixture.

Load

Improves the measurement accuracy by using a device which value is accurately known (a working standard) as a reference.

List Sweep

A maximum of 10 frequencies or test signal levels can be programmed. Single or sequential test can be performed. When Option 001 is installed, DC bias voltages can also be programmed.

Comparator Function

Ten-bin sorting for the primary measurement parameter, and IN/ OUT decision output for the secondary measurement parameter.

Sorting Modes

Sequential mode. Sorting into unnested bins with absolute upper and lower limits.

Tolerance Mode. Sorting into nested bins with absolute or percent limits.

Bin Count

0 to 999999

List Sweep Comparator

HIGH/IN/LOW decision output for each point in the list sweep table.

Other Functions

Store/Load

Ten instrument control settings, including comparator limits and list sweep programs, can be stored and loaded into and from the internal non-volatile memory. Ten additional settings can also be stored and loaded from each Memory Card.

GPIB

All control settings, measured values, comparator limits, list sweep program can be controlled or monitored. ASCII and 64-bit binary data format. GPIB buffer memory can store measured values for a maximum of 128 measurements and output packed data over the GPIB bus. Complies with IEEE-488.1 and 488.2. The programming language is TMSL (Test and Measurement Systems Language).

GPIB Interface Functions

SH1, AH1, T5, L4, SR1, RL1, DC1, DT1, C0, E1

Self Test

Softkey controllable. Provides a means to confirm proper operation.

Option 001 (Internal DC Bias)

Adds the variable DC bias voltage function.

DC Bias Level

The following DC bias level accuracy is specified for an ambient temperature range of $23^{\circ}\text{C}\pm 5^{\circ}\text{C}$. Multiply the temperature induced setting error K_t listed in Figure 1-6 for the temperature range of 0°C to 55°C .

Voltage Range	Resolution	Setting Accuracy
$\pm(0.000 \text{ to } 4.000) \text{ V}$	1 mV	$\pm(0.1\% \text{ of setting} + 1 \text{ mV})$
$\pm(4.002 \text{ to } 8.000) \text{ V}$	2 mV	$\pm(0.1\% \text{ of setting} + 2 \text{ mV})$
$\pm(8.005 \text{ to } 20.000) \text{ V}$	5 mV	$\pm(0.1\% \text{ of setting} + 5 \text{ mV})$
$\pm(20.01 \text{ to } 40.00) \text{ V}$	10 mV	$\pm(0.1\% \text{ of setting} + 10 \text{ mV})$

A maximum DC bias current of 100 mA can be applied to the DUT.

DC Bias Monitor Terminal

DC bias voltage or current can be monitored at the rear panel BNC connector.

The following monitor accuracies are applied when the digital volt meter whose input impedance is $\geq 10 \text{ M}\Omega$ is used.

■ DC Bias Voltage Monitor

DC bias voltage across the DUT $\times 1$

Output Impedance : 11 k Ω

Monitor Accuracy : $\pm(0.2\% \text{ of reading} + 2 + 0.8 \times I_{\text{dut}}) \text{ mV}$

Where,

I_{dut} is current flowing through the DUT in [mA].

■ DC Bias Current Monitor

DC bias current through the DUT $\times 10 \text{ }\Omega$ (1 V at 100 mA)

Output Impedance : 10 k Ω

Monitor Accuracy : $\pm(1\% \text{ of reading} + 0.3) \text{ mA}$

Other Options

Option 002	Accessory Control Interface Allows the 4285A to control the 42841A Bias Current Source or the 42851A Precision Q Adapter. The voltage ratio measurement accuracy, when the 4285A is used with the 42851A Precision Q Adapter, is described in the 42851A's Operation Manual.
Option 004	Memory Card
Option 008	Add Operation Manual (Japanese)
Option 009	Delete Operation Manual
Option 109	Delete GPIB Interface
Option 201	Handler Interface
Option 202	Handler Interface
Option 301	Scanner Interface
Option 907	Front Handle Kit
Option 908	Rack Mount Kit
Option 909	Rack Flange and Handle Kit
Option 910	Extra Operation Manual
Option 915	Add Service Manual
Option W30	Three Year Customer Return Repair Coverage
Option W32	Three Year Customer Return Calibration Coverage

Furnished Accessories

Operation Manual	Agilent Part Number 04285-90000
Maintenance Manual	Agilent Part Number 04285-90030
Memory Card	Agilent Part Number 04278-89001
Power Cord	Depends on the country where the 4285A is being used. Refer to "Power Cable" in Chapter 2 in Page 2-7.
100 Ω Resistor Box	Agilent Part Number 04285-61001
BNC Female-Female Adapter	Agilent Part Number 1250-0080, (4 ea).
Fuse	Only for Option 201, Agilent Part Number 2110-0046, (2 ea).

Accessories Available

Test Fixture / Test Leads

16034E	Test Fixture for SMD or Chip type DUT, $f \leq 40$ MHz
16047A	Test Fixture for Axial or Radial DUT, $f \leq 13$ MHz
16047C	Test Fixture for Axial or Radial DUT, $f \leq 40$ MHz
16047D	Test Fixture for Axial or Radial DUT, $f \leq 40$ MHz
16048A	Test Leads Length 1 m (BNC connector)
16048D	Test Leads Length 2 m (BNC connector)
16065A	External Voltage Bias Fixture
16334A	Tweezer-type Test Fixture for SMD or Chip type DUT, $f \leq 15$ MHz
16451B	Dielectric Test Fixture
42842C	Bias Current Test Fixture
Agilent Part Number 42851-61100	SMD Test Fixture (42842C Option 001)

DC Bias Source

42841A	Bias Current Source
--------	---------------------

Memory Card

Agilent Part Number 04278-89001	Memory Card, 1 ea.
16470A	Memory Card Set, 10 ea.

GPIB Interconnection Cables

10833A	GPIB Cable, 1m
10833B	GPIB Cable, 2m
10833C	GPIB Cable, 4m

10833D GPIB Cable, 0.5m

Handler Interface Connector for Mating with Option 201

Agilent Part Number 1251-0084
AMPHENOL 36-pin Connector

Scanner Interface Connector for Mating with Option 301

Agilent Part Number 1251-0142
AMPHENOL 14-pin Connector

Power Requirements

Line Voltage

90 to 132 Vac, 198 to 252 Vac

Line Frequency

47 to 66 Hz

Power Consumption

200 VA max.

Operating Environment

Temperature

0°C to 55°C

Humidity

≤ 95% R.H. at 40°C

Altitude

0m to 2000m

Dimensions

426(W) by 177(H) by 498(D) (mm)

Weight

Approximately 16 kg (35.3 lb., standard)

Display

LCD dot-matrix display.

Capable of Displaying

Measured values
Control settings
Comparator limits and decisions
List sweep tables
Self test message and annunciations

Number of Display Digits

6-digits, maximum display count 999999

Supplemental Performance Characteristics

The 4285A supplemental performance characteristics are listed below. These supplemental performance characteristics are not specifications but are typical characteristics included as supplemental information for the operator.

Stability

When the following conditions are satisfied,

Integration time : LONG
 Operating temperature : Constant operating temperature of 23°C ±5°C

Parameter	≤ 1 MHz	30 MHz
Z , Y , L, C, R	< 0.01%/day	< 0.05%/day
D	< 0.0001/day	< 0.0005/day

Temperature Coefficient

When the following conditions are satisfied,

Integration time : LONG
 Test signal voltage : ≥20 mV_{rms}
 Operating temperature : 23°C ±5°C

Parameter	≤ 1 MHz	30 MHz
Z , Y , L, C, R	< 0.004%/°C	< 0.05%/°C
D	< 0.00004/°C	< 0.0005/°C

Settling Time

Frequency (f_m)

- < 50 msec.

Test Signal Level

- < 100 msec.

Measurement Range

- < 50 msec./range shift

Input Protection

Internal circuit protection, when a charged capacitor is connected to the UNKNOWN terminals.

The maximum capacitor voltage is:

$$V_{max} = \sqrt{\frac{1}{C}} \quad [V]$$

Where,

V_{max} : ≤ 200 V,
 C : Capacitance value in Farads.

Measurement Time

Typical measurement times from the trigger to the output of EOM at the Handler Interface. (EOM: End of Measurement)

Integration Time	Measurement Time
SHORT	30 ms
MEDIUM	65 ms
LONG	200 ms

In the following condition. An additional measurement time, approx. 300 ms, is added to the measurement time.

Test signal voltage : 0.51 V - 2 V_{rms}
Measurement range : 0 Ω Range
Test signal current: ≥ 22 mA

Display Time

Display time for each display format is given as

MEAS DISPLAY page approx. 8 ms
BIN No. DISPLAY page approx. 5 ms
BIN COUNT DISPLAY page approx. 0.5 ms

GPIB Data Output Time

Internal GPIB data processing time from EOM output to measurement data output on GPIB lines (excluding display time).

- Approx. 10 ms

Option 001 (Internal DC Bias)

Maximum DC bias current when the normal measurement can be performed is 100 mA.

DC Bias Settling Time

When DC bias is set to ON, add 5 ms to the measurement time. This settling time does not include the DUT charge time.

Sum of DC bias settling time plus DUT (capacitor) charge time is shown in the following figure.

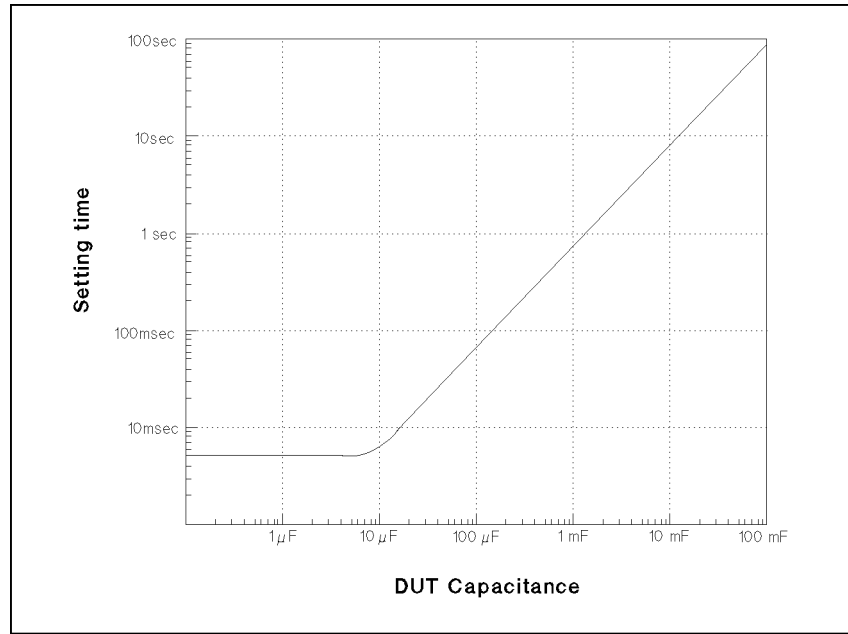

Figure 1-7.
Sum of the DC Bias Settling Time and DUT (Capacitor) Charge Time

This ISM device complies with Canadian ICES-001.
 Cet appareil ISM est conforme à la norme NMB-001 du Canada.

Installation

This chapter provides the information necessary for performing an incoming inspection and setting up the 4285A. The main topics in this chapter are:

- Incoming Inspection
- Power requirements
- Line Voltage and Fuse Selection
- Operation Environment
- Electromagnetic Compatibility
- Ventilation Requirements
- Instruction for Cleaning
- Rack/Handle Installation

Incoming Inspection

Warning



To avoid hazardous electrical shock, do not turn on the 4285A when there are signs of shipping damage to any portion of the outer enclosure (for example, covers, panel, or display)

Inspect the shipping container for damage. If the shipping container or cushioning material is damaged, it should be kept until the contents of the shipment have been checked for completeness and the 4285A has been checked mechanically and electrically. The contents of the shipment should be as listed in Table 2-1. If the contents are incomplete, if there is mechanical damage or defect, or if the analyzer does not pass the power-on selftests, notify the nearest Agilent Technologies office. If the shipping container is damaged, or the cushioning material shows signs of unusual stress, notify the carrier as well as the Agilent Technologies office. Keep the shipping materials for the carrier's inspection.

Table 2-1. 4285A Contents

Description	Qty.	Agilent Part Number
4285A		
Power cable ¹	1	—
100Ω Resister Box	1	04285-61001
BNC Female-Female Adapter	4	1250-0080
Operation Manual	1	04285-90010
Maintenance Manual	1	04285-90030
Option 004 Memory Card		
Memory Card	1	04278-89001
Option 201 Fuse		
Fuse	2	2110-0046
Option 907 Handle Kit		
Handle kit	1	5061-9690
Option 908 Rack Flange Kit		
Rack Flange Kit	1	5061-9678
Option 909 Rack Flange & Handle Kit		
Rack Flange and Handle Kit	1	5061-9684

¹ Power Cable depends on where the instrument is used, see “Power Cable”.

Power Requirements

The 4285A requires the following power source:

Voltage : 90 to 132 Vac, 198 to 252 Vac

Frequency : 47 to 66 Hz

Power : 200 VA maximum

Power Cable

In accordance with international safety standards, this instrument is equipped with a three-wire power cable. When connected to an appropriate ac power outlet, this cable grounds the instrument frame.

The type of power cable shipped with each instrument depends on the country of destination. Refer to Figure 2-1 for the part numbers of the power cables available.

Warning



For protection from electrical shock, the power cable ground must not be defeated.

The power plug must be plugged into an outlet that provides a protective earth ground connection.

<p>OPTION 900</p> <p>United Kingdom</p>  <p>Plug : BS 1363A, 250V Cable : 8120-1351</p>	<p>OPTION 901</p> <p>Australia / New Zealand</p>  <p>Plug : NZSS 198/AS C112, 250V Cable : 8120-1369</p>
<p>OPTION 902</p> <p>European Continent</p>  <p>Plug : CEE-VII, 250V Cable : 8120-1689</p>	<p>OPTION 903</p> <p>U.S. / Canada</p>  <p>Plug : NEMA 5-15P, 125V, 15A Cable : 8120-1378</p>
<p>OPTION 904</p> <p>U.S. / Canada</p>  <p>Plug : NEMA 6-15P, 250V, 15A Cable : 8120-0698</p>	<p>OPTION 905*</p> <p>Any country</p>  <p>Plug : CEE 22-VI, 250V Cable : 8123-1396</p>
<p>OPTION 906</p> <p>Switzerland</p>  <p>Plug : SEV 1011.1959-24507 Type 12, 250V Cable : 8120-2104</p>	<p>OPTION 912</p> <p>Denmark</p>  <p>Plug : DHCR 107, 220V Cable : 8120-2956</p>
<p>OPTION 917</p> <p>India / Republic of S.Africa</p>  <p>Plug : SABS 164, 250V Cable : 8120-4211</p>	<p>OPTION 918</p> <p>Japan</p>  <p>Plug : JIS C 8303, 125V, 15A Cable : 8120-4753</p>
<p>NOTE: Each option number includes a 'family' of cords and connectors of various materials and plug body configurations (straight, 90° etc.).</p> <p>* Plug option 905 is frequently used for interconnecting system components and peripherals.</p>	

Figure 2-1. Power Cable Supplied

Line Voltage and Fuse Selection

Figure 2-2 illustrates the line voltage selection switch and fuseholder on the instrument's rear panel.

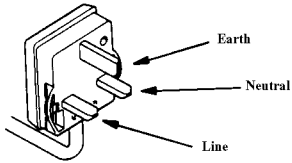
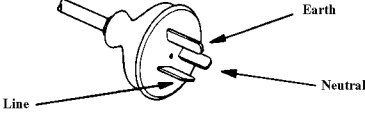
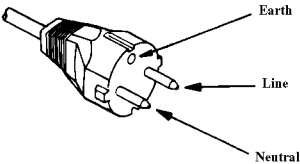
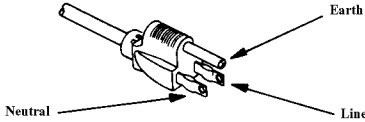
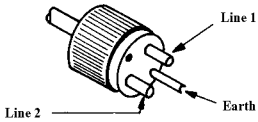
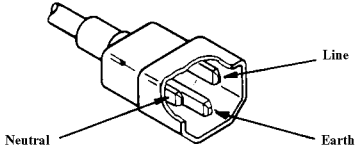
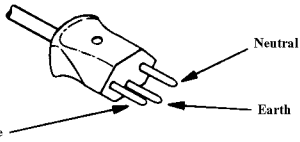
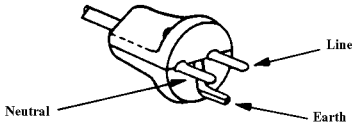
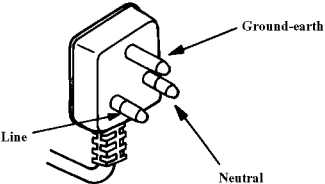
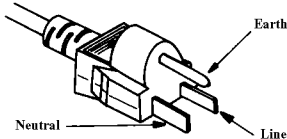
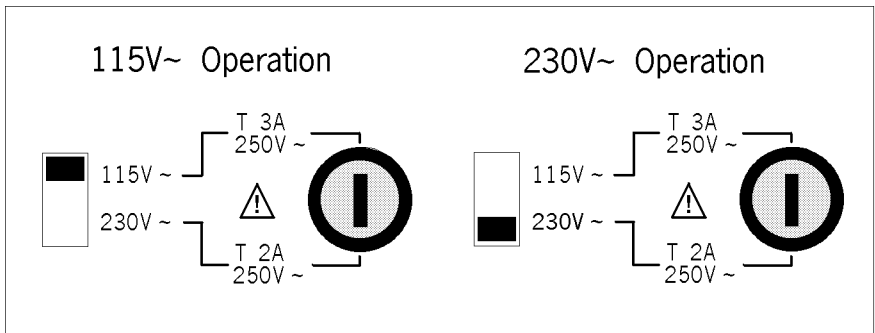

Figure 2-2. Line Voltage Selector

Caution



Before connecting the instrument to the power source, make sure that the correct fuse has been installed and the Line Voltage Selection Switch is correctly set.

Line Voltage Selection

Select the proper voltage selector according to the Table 2-2.

Table 2-2. Line Voltage Selection

Voltage Selector	Line Voltage
115 V~	90-132 V, 47-66 Hz
230 V~	198-252 V, 47-66 Hz



Fuse Selection

Select proper fuse according to the Table 2-3. Current ratings for the fuse are printed under the fuseholder on the rear panel, and are listed, along with the fuse's Agilent part number, in Table 2-3.

Table 2-3. Fuse Selection

Operating Voltage	Fuse Rating/Type	Fuse Part Number
115 V~	3A 250Vac UL/CSA type Time Delay	2110-0381
230 V~	2A 250Vac UL/CSA type Time Delay	2110-0303

If you need this fuse, contact your nearest Agilent Technologies Sales and Service Office.

To remove the fuse, turn the fuse holder counterclockwise until the fuse pops out.

Caution

Use the proper fuse for the line voltage selected. Use only fuses with the required current rating and of the specified type as replacements. DO NOT use a mended fuse or short-circuit the fuse-holder in order to by-pass a blown fuse. Find out what caused the fuse to blow!

**Operation
Environment**

The 4285A must be operated under within the following environment conditions, and sufficient space must be kept behind the 4285A to avoid obstructing the air flow of the cooling fans.

Temperature: 0°C to 55°C

Humidity: less than 95% RH at 40°C

Note

The 4285A must be protected from temperature extremes which could cause condensation within the instrument.

**Electromagnetic
Compatibility**

This product has been designed and tested to the requirements of the Electromagnetic Compatibility (EMC) Directive 89/336/EEC. To use a properly shielded cable or shielded coaxial cable (such as those recommended in the General Information and the Performance Test) to connect each of the ports to their respective controllers, peripherals, equipments or devices may ensure to meet the requirements.

Ventilation Requirements

To ensure adequate ventilation, make sure that there is adequate clearance around the 4285A.

Instruction for Cleaning

To prevent electrical shock, disconnect the 4285A power cable from the receptacle before cleaning. Use a dry cloth or a cloth slightly dipped in water to clean the casing. Do not attempt to clean the 4285A internally.

Rack/Handle Installation

The 4285A can be rack mounted and used as a component in a measurement system. Figure 2-3 shows how to rack mount the 4285A.

Table 2-4. Rack Mount Kits

Option	Description	Kit Part Number
907	Handle Kit	Agilent Part Number 5061-9690
908	Rack Flange Kit	Agilent Part Number 5061-9678
909	Rack Flange & Handle Kit	Agilent Part Number 5061-9684

Option 907 Handle Kit

Option 907 is a Handle kit containing a pair of handles and the necessary hardware to attach them to the instrument.

Handle Installation

1. Remove the adhesive-backed trim strips 1 from the left and right front sides of the 4285A.
2. Attach the front handles 3 to the sides using the screws provided.
3. Attach the trim strips 4 to the handles.

Option 908 Rack Flange Kit

Option 908 is a rack mount kit containing a pair of flanges and the necessary hardware to mount them to the instrument in an equipment rack with 482.6 mm (19 inches) horizontal spacing.

Rack Mounting

1. Remove the adhesive-backed trim strips 1 from the left and right front sides of the 4285A.
2. Attach the rack mount flange 2 to the left and right front sides of the 4285A using the screws provided.
3. Remove all four feet (lift bar on the inner side of the foot, and slide the foot toward the bar).

Option 909 Rack Flange & Handle Kit

Option 909 is a rack mount kit containing a pair of flanges and the necessary hardware to mount them to an instrument which has handles attached, in an equipment rack with 482.6 mm (19 inches) spacing.

Handle and Rack Mounting

1. Remove the adhesive-backed trim strips 1 from the left and right front sides of the 4285A.
2. Attach the front handle 3 and the rack mount flange 5 together on the left and right front sides of the 4285A using the screws provided.
3. Remove all four feet (lift bar on the inner side of the foot, and slide the foot toward the bar).

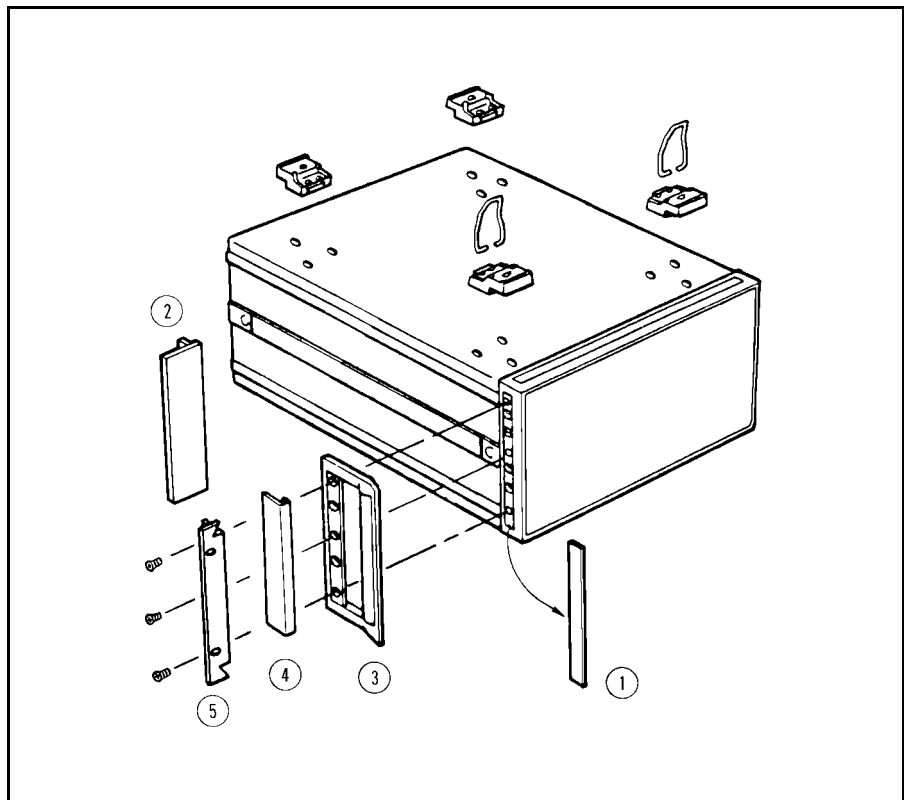

Figure 2-3. Rack Mount Kits Installation

Overview

Introduction

This chapter provides the information you will need to know before operating the Agilent Technologies Model 4285A Precision LCR Meter. Before using the 4285A, read through this chapter so you can quickly and efficiently learn the 4285A's operation.

Product Introduction

The 4285A is a general purpose LCR meter for incoming inspection of components, quality control, and laboratory use. The 4285A is used for evaluating LCR components, materials, and semiconductor devices over a wide range of frequencies (75 kHz to 30 MHz) and test signal levels (5 mV to 2 V_{rms}, 200 μ A to 20 mA_{rms}).

The 4285A measures L-Q and C-D with a basic accuracy of $\pm 0.1\%$ (L, C), ± 0.001 (D) with six digit resolution (the dissipation factor resolution is 0.000001). With its built-in comparator, the 4285A can output comparison/decision results for sorting components into a maximum of ten bins. By using the handler interface and scanner interface options, the 4285A can easily be combined with a component handler, scanner, and system controller to fully automate component testing, sorting, and quality control data acquisition and processing.

The 4285A's list sweep function permits entry of up to ten frequencies, test signal levels, or bias level points to be automatically measured.

The GPIB interface is a standard interface on the 4285A and can be used to build an automatic test system to completely characterize new components and materials, and to fully automate production line testing.

The 4285A with an Option 002 accessory control interface, an 42841A bias current source, and an 42842C bias current test fixture can apply a 0 to 10A DC current bias to the device under test (DUT). So, high current biased impedance measurement of coils and transformers can be performed easily, quickly, and safely.

The 4285A with Option 002 accessory control interface and the 42851A Q adapter realize stable high Q measurement using the resonant measurement method and an automated tuning operation.

Front Panel Description

Figure 3-1 shows the brief description of each key on the 4285A's front panel.

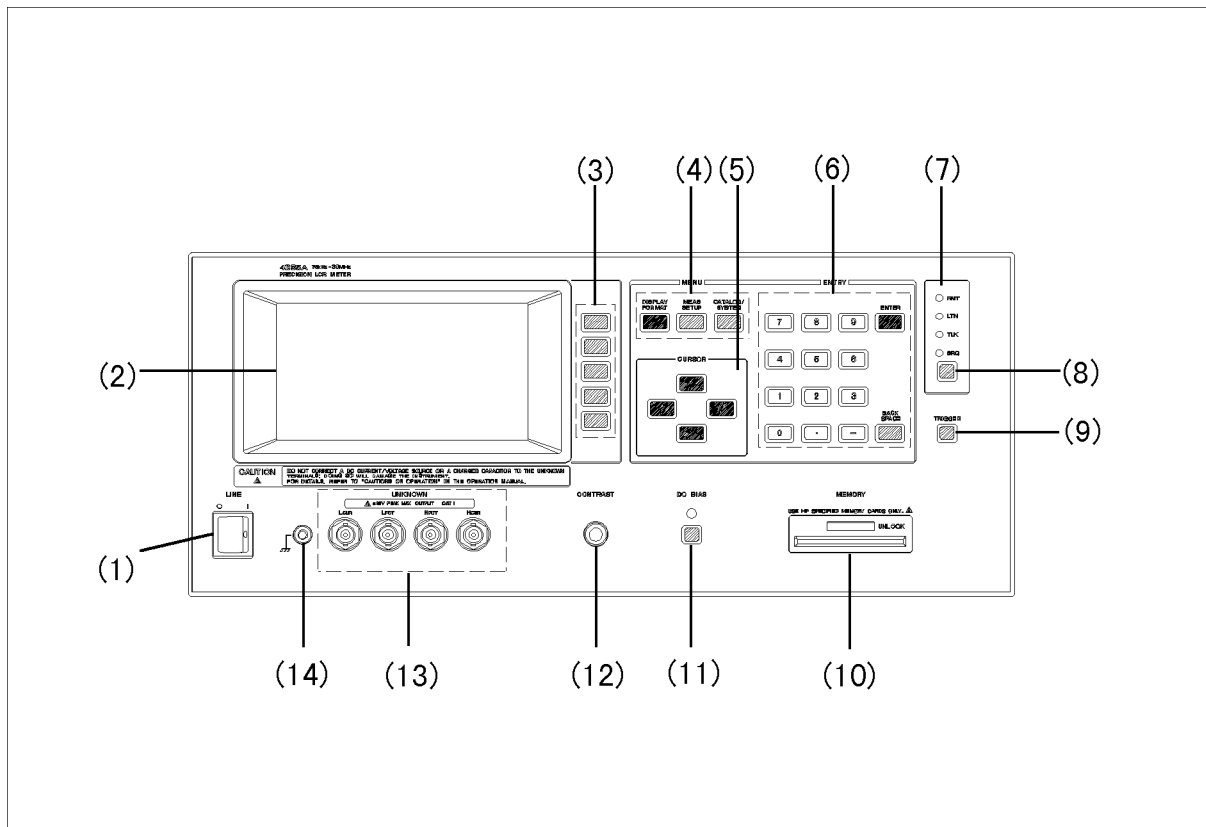

L2003001

Figure 3-1. Front Panel Overview

① LINE On/Off

Power on/off switch. In the ON position all operating voltages are applied to the instrument. In the OFF position NO operating voltages are applied to the instrument.

② LCD Panel

The Liquid Crystal Display (LCD) displays measurement results, test conditions, softkey labels, and other information.

③ SOFTKEYS

Five softkeys are used to select control and parameter functions. Each softkey has a softkey label along its left side.

④ MENU Keys

Menu selection keys. There are three menu keys, **DISPLAY FORMAT**, **MEAS SETUP**, and **CATALOG/SYSTEM**. The menu keys are used to access the corresponding selection of instrument functions.

⑤ **CURSOR Keys**

The CURSOR arrow keys are used to move the field select cursor from field to field on the LCD display page. When the cursor is moved to a field the field changes to an inverse video image of the original field. The cursor can only be moved to a field, it can't be moved into a monitor area.

⑥ **ENTRY Keys**

The ENTRY keys are used to enter numeric data into the 4285A. The ENTRY keys are composed of the digits **0** to **9**, a period **.**, a minus sign **-**, **ENTER**, and **BACK SPACE** keys. **ENTER** terminates numeric input data and enters the displayed value on the Input line (second line from the bottom of the LCD screen). **BACK SPACE** deletes one last character of the input value.

⑦ **GPIB Status Indicator**

The GPIB status indicators consist of the RMT (remote), TLK (talk), LTN (listen), and SRQ (service request) indicators. These indicators are used to show the 4285's GPIB status when it is interfaced to a controller via GPIB.

⑧ **LCL Key**

The Local (LCL) key returns the 4285A to local (front-panel) operation from the remote (computer controlled) operation state unless a Local Lockout command has been invoked from the computer. **LCL** is the only front-panel key activated while the 4285A is in the REMOTE state.

⑨ **TRIGGER Key**

This key is used to manually trigger the 4285A when it is set to the Manual Trigger mode.

Ⓐ **MEMORY Card Slot and UNLOCK Button**

The MEMORY card slot is where you insert the memory cards. The UNLOCK button is used to eject a memory card.

Ⓑ **DC BIAS Key**

DC BIAS is used to enable or to disable the DC bias output. **DC BIAS** is a toggle type switch, and the DC BIAS ON/OFF LED indicator is located above **DC BIAS**. There are two ways to apply the DC bias to the DUT. One is Option 001 DC bias option and the other is the 42841A Bias Current Source combined with the 42842C Bias Current Test Fixture. Either one can be selected in the *CONFIG* field. **DC BIAS** simply the DC bias output turns ON or OFF, and the DC bias value must be set in the *BIAS* field.

Ⓒ **CONTRAST Control Knob**

This knob is used to adjust the LCD's CONTRAST.

①  **UNKNOWN Terminals**

These are the *UNKNOWN* terminals used to connect a four-terminal pair test fixture or test leads for measuring the DUT. Available four terminal-pair test fixtures or test leads are refer to the Accessories Selection Guide For Impedance Measurements (Catalog number 5963-6834E).

INSTALLATION CATEGORY I

② **FRAME Terminal**

This Terminal is tied to the instrument's chassis and can be used for measurements that require guarding.

Rear Panel Description

Figure 3-2 gives a brief description of the 4285A's rear panel.

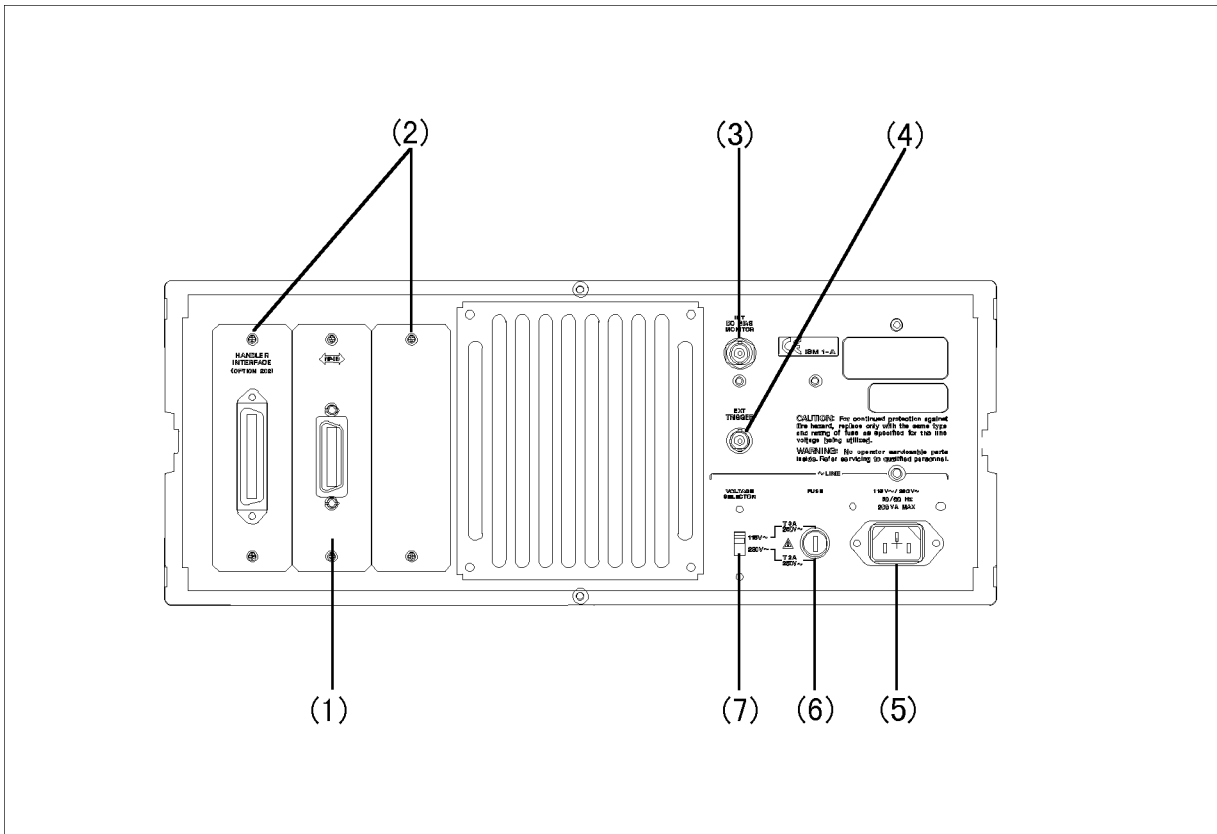

Figure 3-2. Rear Panel Overview

① GPIB Interface Connector

The GPIB interface connector allows interfacing with a controller and other GPIB instruments.

② Interface Connectors

When interface options are installed, the interface connectors will be installed as shown in Figure 3-2. When the 4285A is not equipped with an interface option, blank covers are installed.

③ INT DC BIAS MONITOR Connector

This BNC connector is used for monitoring the DC bias voltage or current applied to the DUT. The monitor function can be switched to either voltage (**V BIAS**) or current (**I BIAS**) on the *MON* field in the *MEAS SETUP* page. This connector is installed only when Option 001 is installed.

④ EXT TRIGGER Connector

The 4285A is triggered by inputting a TTL active low to high going edge trigger pulse.

⑤ **~LINE Input Receptacle**

AC power cord receptacle.

⑥  **~LINE Fuse Holder**

Fuse holder for the 4285A's line fuse. Refer to Figure 2-3 to determine the correct line fuse rating.

⑦ **~LINE VOLTAGE SELECTOR**

The switch used to match the 4285A to the AC operating voltage being used. Refer to "Line Voltage Selection" in Chapter 2 to determine the correct operating voltage.

Display

The following paragraphs define the display areas and fields, and describes the LCD's display pages.

Display Area Definition

The 4285A uses a 40 character 16 line Liquid Crystal Display (LCD), and the display area on the LCD is divided into the blocks as shown in Figure 3-3.

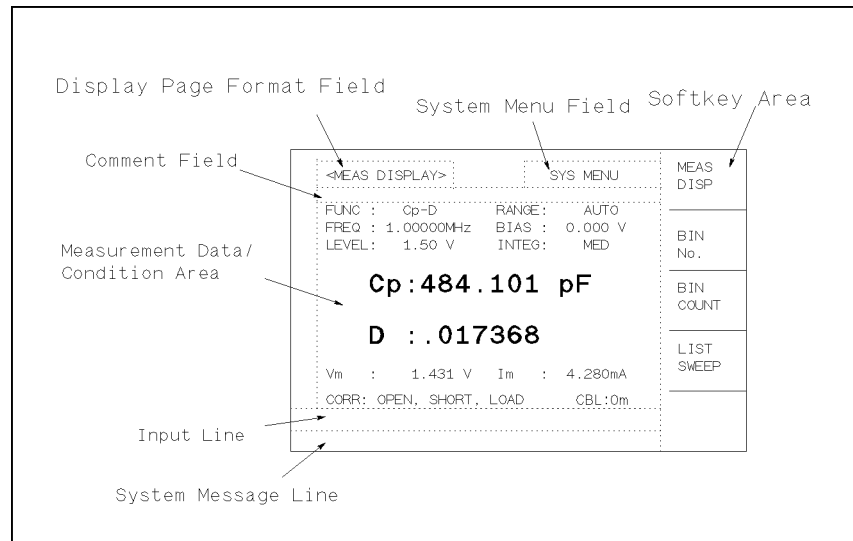

Figure 3-3. Display Area Definition

Display Page Format Field

This area identifies the current page displayed. The currently selected page name is displayed in this area enclosed in angle brackets.

System Menu Field

The system menu field is always displayed on the upper right corner of all pages (except for the *SELF TEST* page and the *CABLE CORRECTION* page). When the CURSOR is on the *SYS MENU* field, functions which are not displayed on the display pages (for example, STORE/LOAD, print, key lock, fixing decimal point, bin count, system reset, and clear page setup functions) are available.

Comment Field

The comment field is used to display comment messages. Alpha-numeric comment can be entered by moving the CURSOR to the *comment* field and pressing **COM-MENT** on the *MEAS SETUP* page. Up to 30 characters can be entered on the comment line. This comment line is stored to the internal non-volatile memory or external memory card with the instrument control settings when **STORE** is pressed in the *SYS MENU* field. The comment line area is displayed on the following pages.

- *MEAS DISPLAY*
- *BIN No. DISPLAY*
- *LIST SWEEP DISPLAY*

- *MEAS SETUP*
- *LIST SWEEP SETUP*
- *SYSTEM CONFIG*

The comment can be entered via GPIB using the `DISPlay:LINE` command.

Softkey Area

The last six character positions of each line are reserved for softkey labels. The softkeys displayed correspond to the field at the cursor's position on the LCD.

Measurement Data/Conditions Area

This area is where measurement results and measurement conditions are displayed.

Note



Under certain conditions one of the following messages may be displayed instead of the measurement result.

- | | |
|-------------|--|
| “UNBAL”: | This message is displayed when the impedance of the device exceeds the range of the analog measurement circuit's capability. |
| “ADC ERR”: | This message is displayed when the A/D converter in the measurement circuit is not functioning. |
| “-----”: | The “overflow” message is displayed when the analog measurement circuit can measure the device, but the data format used will not hold the calculated results. |
| “INFINITY”: | This message is displayed when an attempt is made to divide by zero during parameter calculation. For example, if you set the Δ % measurement function without setting the reference value, this message will be displayed. |

Input Line Area

This area is the input line where numeric input data entered using the front panel keys is displayed.

System Message Area

This area is where system messages, comments, and error messages are displayed.

MENU Keys and Display Page

The 4285A has three MENU keys which are used to define the LCD display pages.

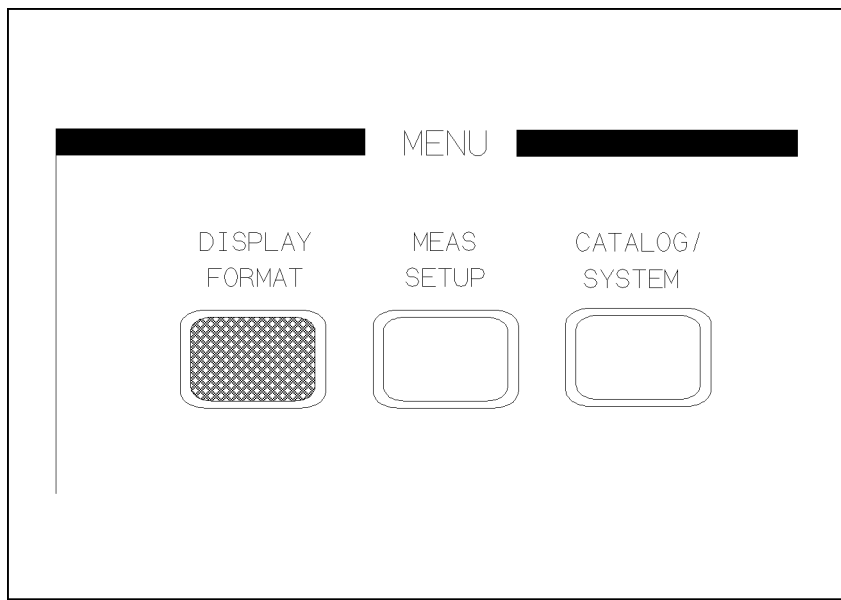

Figure 3-4. MENU keys

Each MENU key has four display pages as follows.

DISPLAY FORMAT

This MENU key has the following four pages.

- *MEAS DISPLAY*
- *BIN No. DISPLAY*
- *BIN COUNT DISPLAY*
- *LIST SWEEP DISPLAY*

These display pages are used for displaying measurement and sorting results. Some controls for each display page can be set from the display page. Only from the above display pages can the 4285A measure a DUT. When **DISPLAY FORMAT** is pressed, the *MEAS DISPLAY* page will be displayed on the LCD screen, and the softkeys used to select the other three pages will be displayed. The CURSOR will be positioned at the *MEAS DISPLAY* field. The power-on default display page is the *MEAS DISPLAY* page. For more information under **DISPLAY FORMAT**, refer to Chapter 4.

MEAS SETUP

This MENU key has the following four pages.

- *MEAS SETUP*
- *CORRECTION*
- *LIMIT TABLE SETUP*
- *LIST SWEEP SETUP*

These display pages are used for setting measurement conditions (including the correction function), or setting bin sorting limits. When one of these display pages are being displayed, the 4285A stops the measurement and bin sorting judgments. (The 4285A measures the DUT and performs the bin judgments only from the display pages under **DISPLAY FORMAT**.) When **MEAS SETUP** is pressed, the *MEAS SETUP* page is displayed and the softkeys to select the other three

pages are displayed. The cursor will be positioned at the *MEAS SETUP* field. For more information about **MEAS SETUP**, refer to “MEAS SETUP Page” in Chapter 5.

CATALOG/SYSTEM

This MENU key has the following four pages.

- *CATALOG*
- *SYSTEM CONFIGURATION*
- *CABLE CORRECTION*
- *SELF TEST*

These display pages are used to control functions which are not related to the main measurement controls. When **CATALOG/SYSTEM** is pressed, the *CATALOG* page will be displayed, and the softkeys to select the other two pages are displayed. The cursor will be positioned at the *CATALOG* field. For more information about **CATALOG/SYSTEM**, refer to Chapter 6.

A summary for each display page will be given starting from the next paragraph.

Summary of Pages

Figure 3-5 shows all display pages. A summary of each page is described below.

MEAS DISPLAY (under DISPLAY FORMAT)

This display page provides the measurement result information, and some control settings are entered from this page. The 4285A measures the DUT from this page, and displays the measurement results in large size characters.

BIN No. DISPLAY (under DISPLAY FORMAT)

This display page provides the bin sorting result information, the measurement results, and comparator function on/off settings. The 4285A measures the DUT from this page. The bin number is displayed in large characters, and the measurement results are displayed in normal size characters.

BIN COUNT DISPLAY (under DISPLAY FORMAT)

This display page provides the limit table's conditions, and the comparator's bin counter results. The 4285A can measure the DUT from this page, but the measurement results will not be displayed.

LIST SWEEP DISPLAY (under DISPLAY FORMAT)

This display page provides the list sweep measurement results, and selection of the sweep mode (step/sequence). The 4285A measures the DUT according to the list sweep conditions in the *LIST SWEEP SETUP* page. An asterisk (*) shows the current measuring point in the list sweep points. The list sweep point cannot be set from this page. You must use the *LIST SWEEP SETUP* (in MEAS SETUP) page to set the list sweep points.

MEAS SETUP (under MEAS SETUP)

This display page provides all of the measurement control settings. The 4285A halts the measurement in this page. Some control settings can be changed in the display page under the *DISPLAY FORMAT* menu.

CORRECTION (under MEAS SETUP)

This display page provides the correction function. The correction function should be used to measure the DUT accurately. OPEN/SHORT correction, OPEN/SHORT/LOAD correction, selection of test cable length, and MULTI channel correction are available in this page.

LIMIT TABLE SETUP (under MEAS SETUP)

This display page provides the limit table settings for bin sorting. The 4285A doesn't perform measurement from this page. To see the comparison results, either the *BIN No. DISPLAY* page (under DISPLAY FORMAT menu) or the *BIN COUNT DISPLAY* page (under DISPLAY FORMAT menu) should be used.

LIST SWEEP SETUP (under [MEAS SETUP](#))

This display page provides the control settings for the List Sweep measurement function. The 4285A doesn't measure the DUT from this page. To measure the DUT using the list sweep function, the *LIST SWEEP DISPLAY* page (under [DISPLAY FORMAT](#)) should be used.

CATALOG (under [CATALOG/SYSTEM](#))

This display page provides a list of the stored setups in the internal memory or the memory card.

SYSTEM CONFIG (under [CATALOG/SYSTEM](#))

This display page enables operation of either the GPIB interface or the 4285A's optional interfaces. Also, installed options are listed on this page.

CABLE CORRECTION (under [CATALOG/SYSTEM](#))

This display page provides the cable correction data measurement procedure to adopt the 4285A to your 16048A/D test leads.

Note



It is not recommended to use extension cables other than the 16048A and 16048D. Using other types or different length of cables may increase the measurement error.

The measurement error due to an individual test leads is proportional to the square of the test frequency. Accordingly, even small test leads differences can't be ignored at high frequencies, such as 30 MHz.

If you never performed the CABLE CORRECTION (the first time you extended the test leads) or in case of changing the test leads, perform the cable correction in this page to adopt the 4285A to the individual 16048A/D test leads. Once this cable correction is performed, the measured cable correction data is stored in non-volatile memory and is not lost when the 4285A is turned OFF.

SELF TEST (under [CATALOG/SYSTEM](#))

This display page provides the 4285A's service functions.

DISPLAY FORMAT MENU

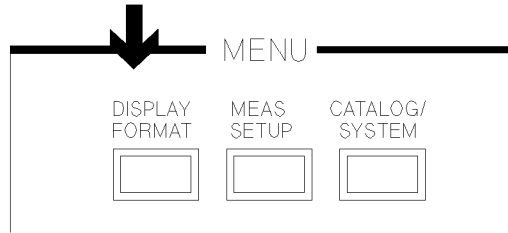

MEAS DISPLAY page

<MEAS DISPLAY>		SYS MENU	MEAS DISP
FUNC : Cp-D	RANGE: AUTO		
FREQ : 1.00000MHz	BIAS : 0.000 V		
LEVEL: 1.500 V	INTEG: MED		
Cp:484.101 pF			
D : .017368			
Vm : 1.431 V	Im : 4.280mA		
CORR: OPEN, SHORT, LOAD		CBL: 0m	
		BIN No.	
		BIN COUNT	
		LIST SWEEP	

BIN No. DISPLAY page

<BIN No.DISPLAY>		SYS MENU	MEAS DISP
FUNC : Cp-D	RANGE: AUTO		
FREQ : 1.00000MHz	BIAS : 1.5000 V		
LEVEL: 1.00 V	INTEG: MED		
	COMP : ON		
BIN 1			
Cp : 123.456 pF	D : 0.12345		
CORR: OPEN, SHORT, LOAD		CBL: 0m	
		BIN No.	
		BIN COUNT	
		LIST SWEEP	

BIN COUNT DISPLAY page

<BIN COUNT DISPLAY>		SYS MENU	MEAS DISP
FUNC : Cp-D	NOM : 100.000 pF		
BIN	Low[%]	HIGH[%]	COUNT
1	- 0.010	+ 0.010	0
2	- 0.020	+ 0.020	0
3	- 0.030	+ 0.030	0
4	- 0.040	+ 0.040	5
5	- 0.050	+ 0.050	9999
6	- 0.060	+ 0.060	80
7	- 0.070	+ 0.070	5
8	- 0.080	+ 0.080	0
9	- 0.090	+ 0.090	0
2nd	+ .000000	+ .000005 []	
REJ CNT	AUX: 999999	OUT: 999999	
		BIN No.	
		BIN COUNT	
		LIST SWEEP	

LIST SWEEP DISPLAY page

<LIST SWEEP DISPLAY>		SYS MENU	MEAS DISP
MODE : SEQ			
FREQ(Hz)	Cp[F]	D[]	CMP
1.00000M	123.453p	0.00001	L
2.00000M	123.455p	0.00002	L
3.00000M	123.456p	0.00003	
4.00000M	123.457p	0.00004	
5.00000M	123.458p	0.00005	H
6.00000M	123.459p	0.00006	
7.00000M	123.550p	0.00007	
8.00000M	123.551p	0.00008	H
9.00000M	123.552p	0.00009	H
10.0000M	123.553p	0.00010	H
			BIN No.
			BIN COUNT
			LIST SWEEP

L2003005

Figure 3-5. Display Pages (1/3)

MEAS SETUP MENU

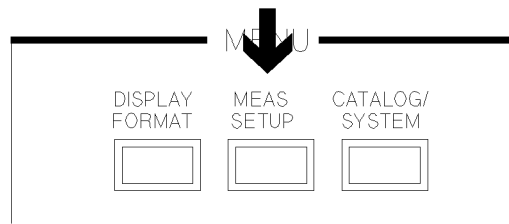

MEAS SETUP page

<MEAS SETUP>		SYS MENU	MEAS SETUP
FUNC : Cp-D	RANGE : AUTO		
FREQ : 1.00000MHz	BIAS : 1.5000 V		
LEVEL : * 1.00 V	INTEG : MED		CORRECTION
TRIG : INT	AVG : 4		LIMIT TABLE
ALC : ON	Vm : ON		LIST SETUP
MON : VBIAS	Im : ON		
	DELAY : 0 ns		
DEV A : ΔABS	REF A : 123.456 pF		
B : ΔABS	B : 0.00005		

CORRECTION Page

<CORRECTION>		SYS MENU	MEAS SETUP
OPEN : ON	CABLE : 1 m		
SHORT : ON	MODE : MULTI		
LOAD : ON	CH No. : 10		CORRECTION
	FUNC : Cp-D		
FREQ1 : 1.00000MHz			LIMIT TABLE
REF A : 100.000pF	B : 0.00010		
MEA A : 100.001pF	B : 0.00011		
FREQ2 : 10.0000MHz			LIST SETUP
REF A : 100.020pF	B : 0.00012		
MEA A : 100.021pF	B : 0.00013		
FREQ3 : 30.0000MHz			
REF A : 100.040pF	B : 0.00014		
MEA A : 100.041pF	B : 0.00015		

LIMIT TABLE SETUP page

<LIMIT TABLE SETUP>		SYS MENU	MEAS SETUP
FUNC : Cp-D	NOM : 100.000 pF		
MODE : %	AUX : OFF	COMP : ON	
BIN	LOW	HIGH	CORRECTION
1	- 0.010 %	+ 0.010 %	
2	- 0.020 %	+ 0.020 %	
3	- 0.030 %	+ 0.030 %	LIMIT TABLE
4	- 0.040 %	+ 0.040 %	
5	- 0.050 %	+ 0.050 %	
6	- 0.060 %	+ 0.060 %	LIST SETUP
7	- 0.070 %	+ 0.070 %	
8	- 0.080 %	+ 0.080 %	
9	- 0.090 %	+ 0.090 %	
2nd	+ .000000	+ .000005	

LIST SWEEP SETUP page

<LIST SWEEP SETUP>		SYS MENU	MEAS SETUP
MODE : SEQ			
FREQ (Hz)	LMT	LOW	HIGH
1.00000M	A	123.456p	124.567p
2.00000M	A	123.456p	124.567p
3.00000M	A	123.456p	124.567p
4.00000M	A	123.456p	124.567p
5.00000M	A	123.456p	124.567p
6.00000M	A	123.456p	124.567p
7.00000M	A	123.456p	124.567p
8.00000M	A	123.456p	124.567p
9.00000M	A	123.456p	124.567p
10.0000M	A	123.456p	124.567p

L2003006

Figure 3-5. Display Pages (2/3)

CATALOG/SYSTEM MENU

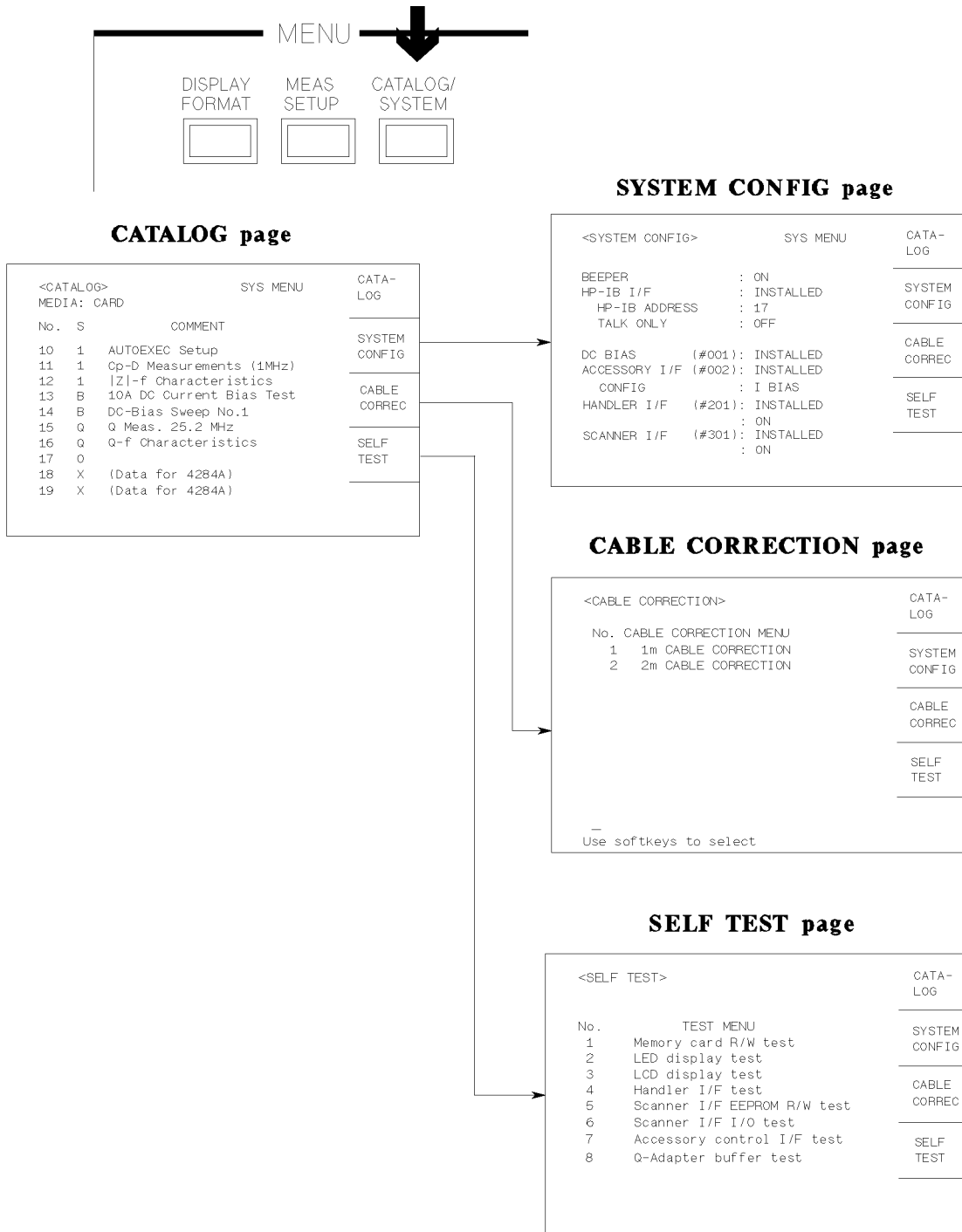

L2003007

Figure 3-5. Display Pages (3/3)

Basic Operation

The 4285A's basic operation is described in the following paragraphs.

1. Display the desired display page using the MENU keys and the softkeys. (Refer to Figure 3-5.)
2. Move the CURSOR to the field to be used using the CURSOR keys. The cursor will be an inverse video marker, and the field is an area at which you can set the CURSOR. (Refer to Figure 3-6.)

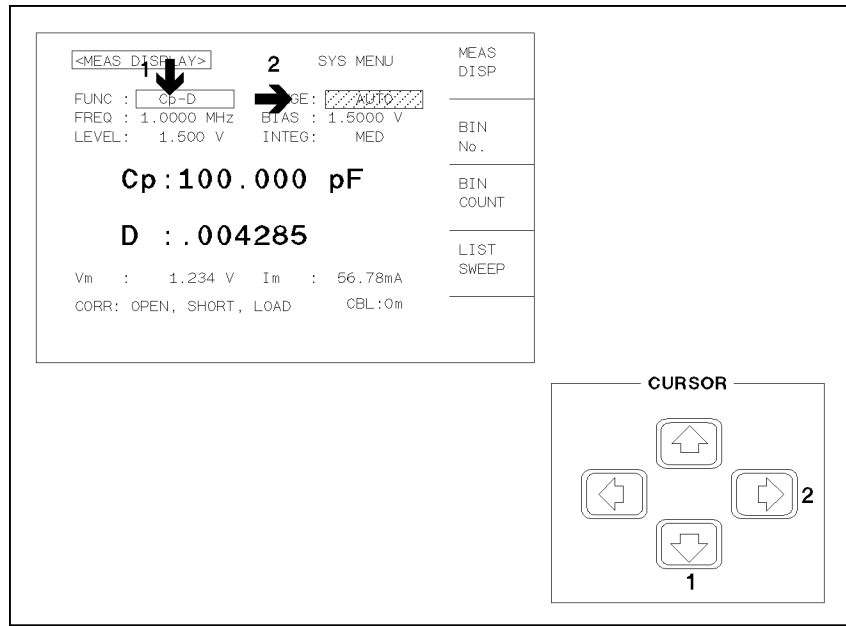

Figure 3-6. CURSOR Keys and Field Operation Example

3. The softkeys corresponding to the field pointed to by the CURSOR will be displayed. Select and press a softkey. (Refer to Figure 3-7.)

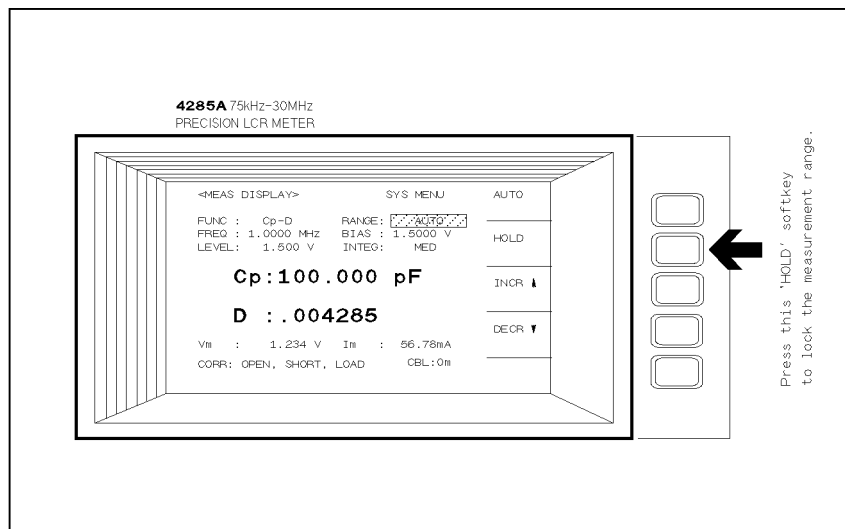

Figure 3-7. Softkey Selection Example

Note

The numeric entry keys and **ENTER** are used to enter numeric data. When one of the numeric entry keys is pressed, the softkeys will change to the available unit softkeys. You can use these unit softkeys instead of **ENTER**. When **ENTER** is used, the numeric data is entered with Hz, V, or A as the default unit depending on the cursor field selected, for example, the test frequency's unit will be Hz, etc.

DISPLAY FORMAT Menu

Introduction

This chapter provides a functional description for the normal LCR measurement function of each page under **DISPLAY FORMAT**. This information includes front panel operation and softkey operation for correct setup.

The following four display pages are available under **DISPLAY FORMAT**.

- *MEAS DISPLAY*
- *BIN No. DISPLAY*
- *BIN COUNT DISPLAY*
- *LIST SWEEP DISPLAY*

This chapter describes the functions on each page.

MEAS DISPLAY Page

When you press **DISPLAY FORMAT**, the *MEAS DISPLAY* page will be displayed. On the *MEAS DISPLAY* page, the measurement results are displayed in large characters, and the following measurement controls can be set. (The field in parenthesis is used to set the control function.)

- LOAD/STORE (*SYS MENU*)
- Decimal Point Fix (*SYS MENU*)
- Printout (*SYS MENU*)
- Key Lock Operation (*SYS MENU*)
- Selection of Displayed Impedance Parameters (*FUNC*)
- Measurement Range (*RANGE*)
- Test Frequency (*FREQ*)
- DC Bias (*BIAS*)
- Oscillator Level (*LEVEL*)
- Integration Time (*INTEG*)

The above fields except for the System Menu (*SYS MENU*) is the same as the fields on the *MEAS SETUP* page. These fields are not described in this chapter, the other fields on the *MEAS DISPLAY* page are described in the following paragraphs.

The *MEAS DISPLAY* page also provides the following information in monitor areas on the displayed page.

- Oscillator Level Voltage/Current Monitor value (V_m, I_m)
- OPEN, SHORT, LOAD on/off setting (*CORR*)
- Channel Number (*CH*) when the multi-channel correction mode is set.
- Cable Length Setting (*CBL*)

These conditions can be set from the *MEAS SETUP* page or *CORRECTION* page. (For oscillator level voltage/current monitor

value, refer to “MEAS SETUP Page” in Chapter 5 and for OPEN, SHORT, LOAD correction setting and channel number, refer to “CORRECTION Page” in Chapter 5.)

The available fields and the softkeys which correspond to the fields on this page are shown in Figure 4-1 and Figure 4-2 respectively.

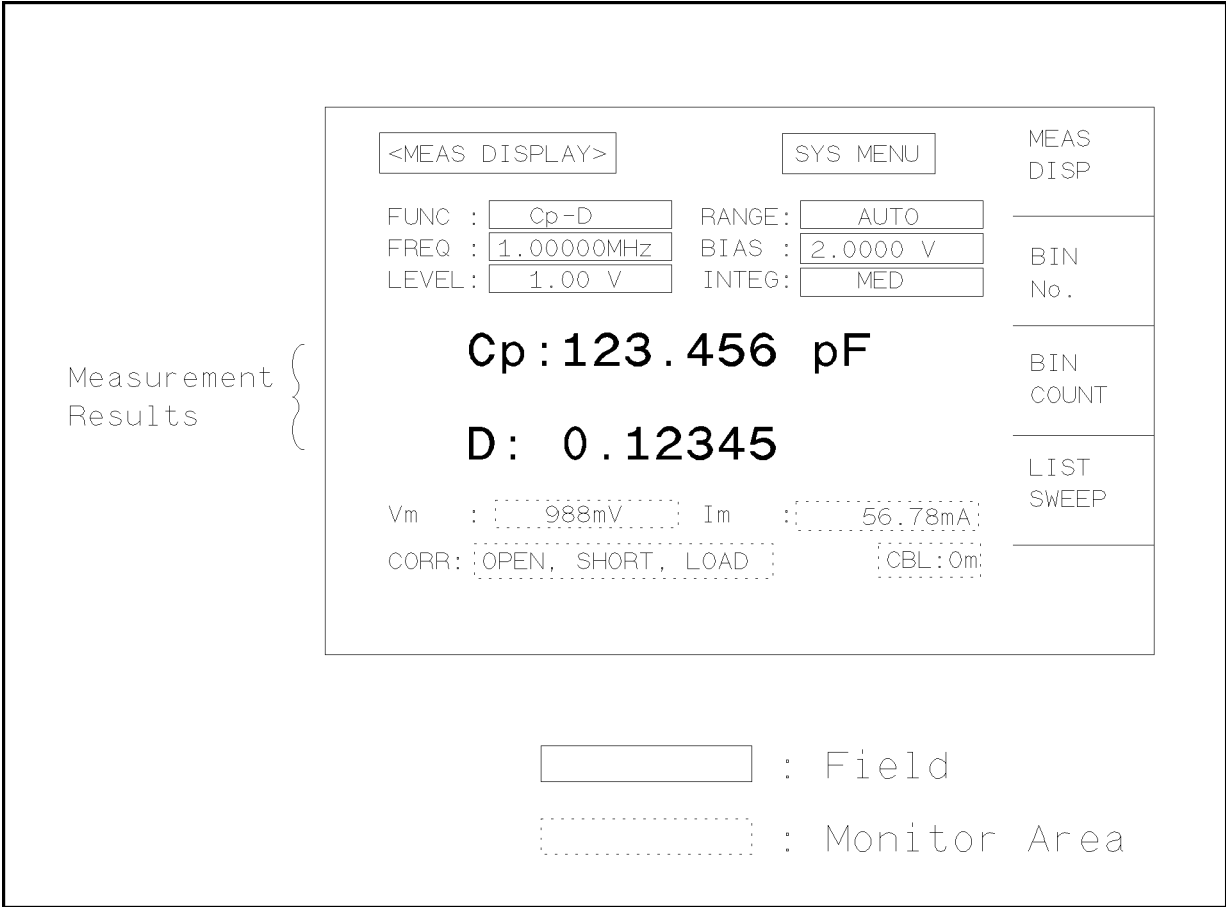

L2094001

Figure 4-1. Available Fields on the MEAS DISPLAY Page

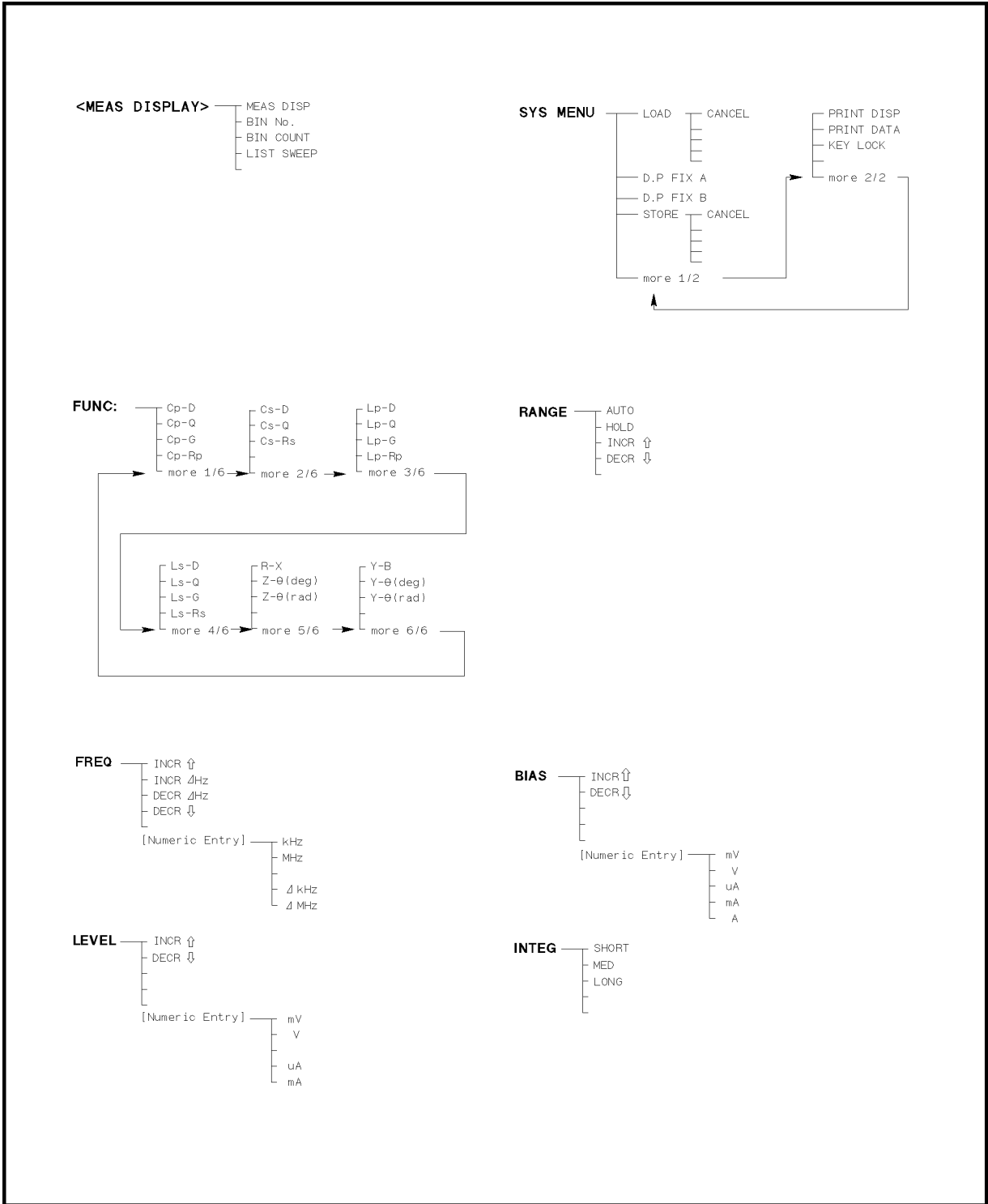

L2004002

Figure 4-2. Available Softkeys on the MEAS DISPLAY Page

SYS MENU Field The system menu allows you to perform the following functions.

- Load/Store
- Set decimal fixed point
- Printout
- Key lock

This paragraph describes each function.

LOAD/STORE Softkeys

The 4285A can store and load the instrument setups to and from its non-volatile memories: the internal memory and an external memory card. A combination of instrument control settings is stored in the memory as one record, and 10 records each are available for the internal or external memory. The following data will be stored in the memory for the record fields of each record.

- Control settings on *MEAS SETUP* page.
 - Displayed Impedance Parameter
 - Test Frequency
 - Measurement Range
 - Oscillator Level
 - DC Bias
 - Integration Time
 - Averaging Rate
 - Delay Time
 - Trigger Mode
 - ALC ON/OFF Selection
 - DC Bias Monitor Mode
 - V Monitor ON/OFF Selection
 - I Monitor ON/OFF Selection
 - Deviation Measurement A/B (Δ ABS/ Δ %/OFF) Selection
 - Deviation Measurement A/B Reference Value
- Control settings on the *LIMIT TABLE* page.
 - Swap Parameter
 - Nominal Value
 - Limit Mode for the Primary Parameter
 - Auxiliary Bin ON/OFF Selection
 - Comparator Function ON/OFF Selection
 - Low/High Limit values for Each Bin and for the secondary parameter
- Control setting on the *BIN COUNT DISPLAY* page.
 - Bin Count Function ON/OFF Selection
- Control settings on the *LIST SWEEP SETUP* page.
 - Sweep Mode
 - Sweep parameter
 - All Sweep Points
 - All Low/High Limit values including the limit mode (A or B)
- Comment Line
- Display page format

Note

DC BIAS ON/OFF condition of the front panel switch setting cannot be stored in non-volatile memory. When the instrument control settings are loaded from internal memory or external memory card, **DC-BIAS** is automatically turned off.

When the 4285A is turned on with the memory card inserted, the 4285A's Auto Load function will load the control settings stored in record number 10. If there are no control settings stored in record number 10 or the stored configuration mode is different from the current configuration mode, the power-on default settings will be used.

Note

The following items are not stored by the LOAD/STORE function. They are stored in the different area of internal memory when the function concerned has changed.

- Control settings on the *CORRECTION* page.
 - OPEN, SHORT, LOAD correction ON/OFF selection
 - OPEN, SHORT correction data for all test frequencies.
 - OPEN, SHORT, LOAD correction data for **FREQ1** to **FREQ7**. (OPEN correction data at each frequency, SHORT correction data at each frequency, and LOAD correction reference data and measurement data at each frequency.)
 - Control settings on the *SYSTEM CONFIG* page.
 - Beeper ON/OFF
 - GPIB address
 - Talk Only ON/OFF
 - Configuration mode
 - Handler I/F ON/OFF
 - Scanner I/F ON/OFF
-

Storing the Control Settings

Perform the following steps to store the control settings to memory.

1. Move the **CURSOR** to the *SYS MENU* field.
2. If you want to store the data to the memory card, insert a memory card in the memory card slot until it locks into place.
3. Press **STORE**. The message Enter record number to STORE will be displayed on the system message line.
4. Enter a record number using the numeric entry keys and **ENTER** to store the current control settings. Use 0 to 9 for internal memory, and 10 to 19 for a memory card.

Loading the Control Settings

Perform the following steps to load the control settings from the internal non-volatile memory or from an external memory card.

1. Move the **CURSOR** to the *SYS MENU* field.
2. If you want to load the data from the memory card, insert the memory card into the **MEMORY** card slot.

3. Press **LOAD**. The message Enter record number to LOAD will be displayed on the system message line.
4. Enter the record number you want to load using the numeric entry keys and **ENTER**.

D.P. FIX A /D.P. FIX B Softkeys

The 4285A displays the measurement data using a six digit floating point display format. These softkeys display the measurement data using a fixed point display format. These softkeys can be used to change the number of displayed digits.

Setting the Fixed Decimal Point Function

Perform the following steps to use the fixed decimal point function.

1. Move the **CURSOR** to the *SYS MENU* field.
2. Press **D.P. FIX A** to fix the decimal point for the primary parameter's data. The **▲** mark will be displayed at the decimal fixed point. Each time **D.P. FIX A** is pressed, the displayed value shifts by one digit to the right and the least significant digit is turned off. The displayed value is rounded off.
3. **D.P. FIX B** works for the secondary parameters' data and works the same as **D.P. FIX A**

Note



In the following cases the fixed decimal point function is automatically disabled.

- When the measurement function is changed.
 - When a deviation measurement (which is set on the *MEAS SETUP* page) is performed, or the deviation measurement function (Δ ABS, Δ %, and OFF) is changed.
-

PRINT DISP /PRINT DATA Softkeys

The 4285A's printer function is used to make a hardcopy of the displayed information (except for the softkey labels) or the measurement results without the need of an external controller. The 4285A must be set to the GPIB talk only mode, and the printer must be set to the GPIB listen only mode. There are two print modes: the PRINT DISPLAY mode and the PRINT DATA mode.

- PRINT DISPLAY mode

The print display mode is used to print out all information on the displayed page by sending ASCII character strings to the printer. An example is shown below.

```

<MEAS DISPLAY>          SYS MENU
FUNC : Cp-D             RANGE:  AUTO
FREQ : 1.0000MHz       BIAS :  0.000 V
LEVEL:  1.00 V        INTEG:  MED

      Cp :  4 1 8 . 3 9 6 p F

      D  :  . 0 3 2 6 7 5

Vm : 998.0mV           Im :  2.628mA
CORR: OPEN, SHORT     CBL: 0m

```

Figure 4-3. MEAS DISPLAY Page Printout Example

Note



The following characters are not recognized by the printer, so the character in brackets to the right of the character will be printed instead.

- Ω → [] (space)
- θ → [0] (zero)
- Δ → [d]
- μ → [u]
- ▶ → [>]

■ PRINT DATA mode

The print data mode is used to print out the measurement results using the following format. This format is the same as the ASCII format used for data transfer via GPIB. For details, refer to “ASCII Format” in Chapter 8.

<DATA A>,<DATA B>,<STATUS>,<BIN No.><CR><LF>

Where,

- <DATA A> The measurement results of the primary parameter (|Z|, |Y|, C, L, R, G).
12 ASCII characters (SN.NNNNNESNN)
- <DATA B> The measurement results of the secondary parameter (θ , D, Q, G, R_s , X, B). 12 ASCII characters (SN.NNNNNESNN)
- <STATUS> 0 : Normal measurement.
1 : Analog bridge is unbalanced.
2 : A/D converter doesn't work.
3 : Signal source is overloaded.
4 : ALC unable to regulate.
- <BIN No.> 0 : OUT OF BINS
1 : BIN 1
2 : BIN 2

3 : BIN 3
:
8 : BIN 8
9 : BIN 9
10: AUX BIN

Note



BIN number data is valid only when the comparator function is set to ON. When the comparator function is set to OFF, the BIN number data isn't output as shown below.

<DATA A>,<DATA B>,<STATUS><CR><LF>

In the talk only mode, the 4285A waits for the completion of the handshake before starting the next measurement. So the measurement cycle of the 4285A depends on the printer's speed.

When the <STATUS> is 1 or 2 the measurement data is 9.9E37. When the <STATUS> is 0, 3, or 4 the actual measurement data are output.

Dumping the LCD Screen to the Printer

Use the PRINT DISP mode and perform the following steps to print out all of information on the display page except for the softkey labels.

1. Connect the 4285A to the printer using an GPIB cable.
2. Set the printer to the listen only mode.
3. On the *SYSTEM CONFIG* page, set the talk only mode to ON.
4. Press the *DISPLAY FORMAT* to display the *MEAS DISPLAY* page.
5. Move the CURSOR to the *SYS MENU* field.
6. Press `more 1/2`.
7. Press `PRINT DISP`.

Printing out the Measurement

Use the PRINT DATA mode and perform the following steps to print out the measurement results on the printer.

1. Connect the 4285A to the printer using an GPIB cable.
2. Set the printer to the listen only mode.
3. On the *SYSTEM CONFIG* page, set the talk only mode to ON.
4. Press `DISPLAY FORMAT` to display the *MEAS DISPLAY* page.
5. Move the CURSOR to the *SYS MENU*.
6. Press `more 1/2`.
7. Press `PRINT DATA`. The marker will appear at the side of `PRINT DATA`. The measurement results are sent to the printer on subsequent measurements.

KEY LOCK Softkey

The 4285A has keyboard lock-out capability that disables all front panel operation except for the power LINE switch, CONTRAST knob, TRIGGER, and KEYLCK. This is useful when you don't want the control settings changed.

Locking Out the Front Panel

Perform the following steps to disable all front panel operation on the *MEAS DISPLAY* page.

1. Move the CURSOR to the *SYS MENU* field.
2. Press more 1/2.
3. Press KEY LOCK (which is a toggled softkey). The icon of the key will be displayed on the left side of KEY LOCK, and the Keys locked message will be displayed on the system message line.
4. Press KEY LOCK again, when you want to re-enable all front panel keys again.

BIN No. DISPLAY Page

When you press **DISPLAY FORMAT** and **BIN No.**, the *BIN No. DISPLAY* page will be displayed. The bin sorting results are displayed in large characters and the measurement results are displayed in normal size characters on the data area. The following measurement controls can be set from the *BIN No. DISPLAY* page. (The field in parenthesis is used when this control is set.)

- Comparator Function ON/OFF Selection (*COMP*)
- LOAD/STORE (*SYS MENU*)
- Printout (*SYS MENU*)
- Key Lock (*SYS MENU*)

The *BIN No. DISPLAY* page also provides the following information in the monitor areas (a monitor area looks like a field, but it is not).

- Selection of Displayed Impedance Parameter (*FUNC*)
- Measurement Range (*RANGE*)
- Test Frequency (*FREQ*)
- Oscillator Level (*LEVEL*)
- DC Bias (*BIAS*)
- Integration Time (*INTEG*)
- OPEN, SHORT, LOAD on/off setting (*CORR*)
- Cable Length Setting

These conditions can be set from the *MEAS SETUP* page, and most of these conditions can be set from the *MEAS DISPLAY* page.

The available fields and the softkeys which correspond to the fields on this page are shown in Figure 4-4 and Figure 4-5.

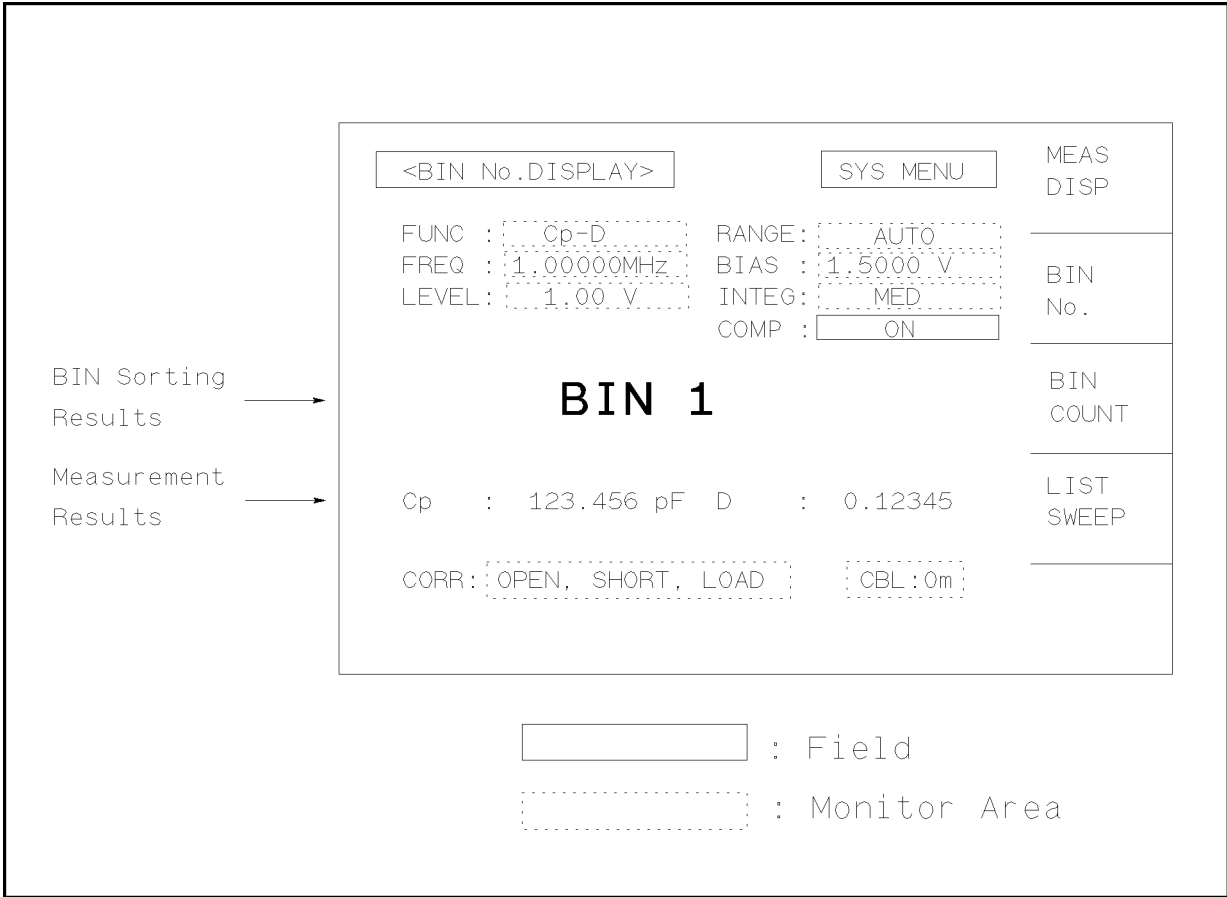
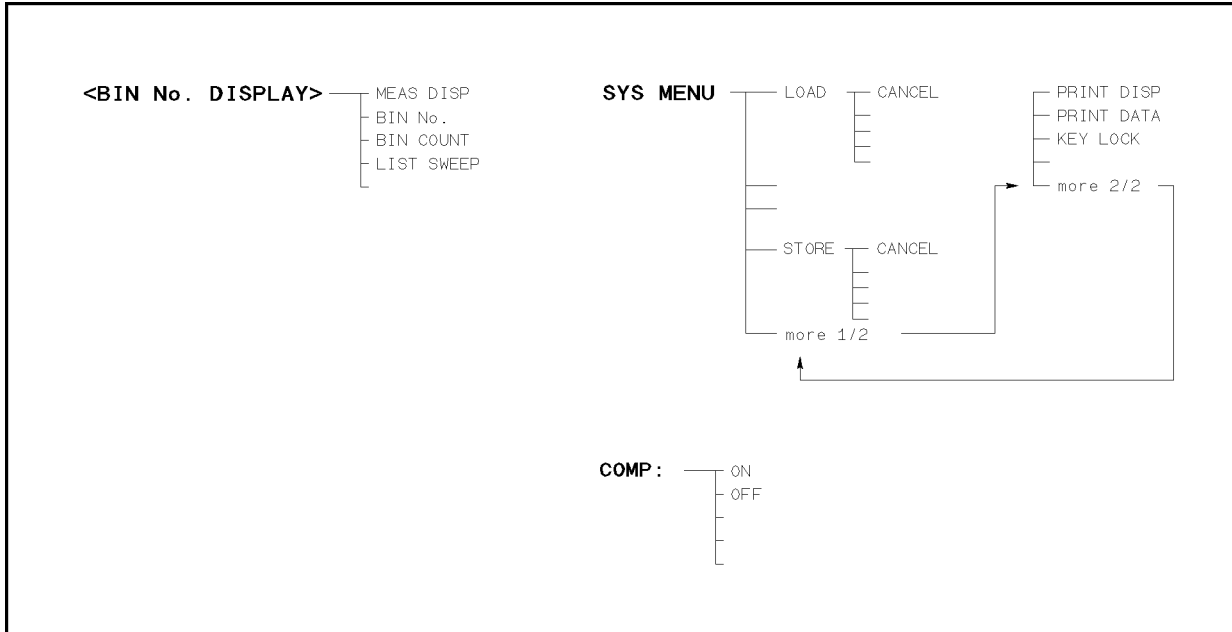

Figure 4-4. Available Fields on the BIN No. DISPLAY Page



L2004005

Figure 4-5. Available Softkeys on the BIN No. DISPLAY Page

COMP Field

The *COMP* field allows you to only set the comparator function to ON or OFF. The 4285A's built-in comparator can sort devices into a maximum of ten bins (BIN 1 to BIN 9 and the OUT OF BINS bin) using a maximum of nine pairs of primary limits. Also the secondary parameter can be sorted using one pair of secondary parameter limits. A device whose primary parameter is within limits, but whose secondary parameter measurement result is not within limits can be sorted into an AUXiliary BIN. The comparator function is especially useful when the 4285A is used with a component handler (with handler interface option). These limit settings for bin sorting are set only on the *LIMIT TABLE* page under **MEAS SETUP** (refer to the "LIMIT TABLE SETUP Page" in Chapter 5).

Setting the Comparator Function to ON or OFF

Perform the following steps to set the comparator function to ON or OFF.

1. Move the CURSOR to the *COMP* field. The following softkeys will be displayed.
 - ON
 - OFF
2. Press either softkey to turn the comparator function ON or OFF.

SYS MENU Field

The system menu on this page allows you to use the following functions.

- LOAD/STORE
- Printout
- Keylock

These functions are the same as the functions on the system menu on the *MEAS DISPLAY* page (The description of each function is given in “SYS MENU Field” on page 4-4.) The procedure for each function is given in the following paragraphs.

Loading or Storing the Control Settings

Perform the following steps to store the control settings to the internal non-volatile memory or the external memory card or load the control settings from the internal non-volatile memory or the external memory card.

1. On the *BIN No. DISPLAY* page move the CURSOR to the *SYS MENU* field using the CURSOR arrow keys.
2. If you want to store the data to the memory card, insert a memory card in the memory card slot until it locks into place.
3. Press **STORE** when you want to use the STORE function. The message Enter record number to STORE will be displayed on the system message line.

Press **LOAD** when you want to use the LOAD function. Then the Enter record number to LOAD will be displayed on the system message line.

4. Use the numeric entry keys and **ENTER** to enter the record number at which the current control settings will be STORED to or LOADED from.

Printing the Measurement Result

Perform the following steps to print out the displayed page or the measurement data using the PRINT DISP mode or PRINT DATA mode.

1. Connect the 4285A to the printer using an GPIB cable.
2. Set the printer to the listen only mode.
3. On the *SYSTEM CONFIG* page set the talk only mode to ON.
4. Press **DISPLAY FORMAT** and **BIN No.** to display the *BIN No. DISPLAY* page.
5. Move the CURSOR to the *SYS MENU* field.
6. Press **more 1/2**.
7. Press **PRINT DISP** when you want to print out the displayed page. The displayed page is printed out as shown in Figure 4-6.

Press **PRINT DATA** when you want to print out the measurement data. The marker will appear beside **PRINT DATA**. The measurement results are printed out on subsequent measurements.

```
<BIN No. DISPLAY>          SYS MENU
FUNC : Cp-D          RANGE:  AUTO
FREQ : 1.0000MHz     BIAS :  0.000 V
LEVEL:  1.00 V      INTEG:  MED
                                COMP :  ON

          B I N  2

          Cp: 418.430pF  D : .032646
CORR: OPEN, SHORT          CBL: 0m
```

Figure 4-6. BIN No. DISPLAY Page Printout Example

Locking Out the Front Panel

Perform the following steps from the *BIN No. DISPLAY* page to disable all front panel operation.

1. Move the CURSOR to the *SYS MENU* field.
2. Press `more 1/2`.
3. Press `KEY LOCK` (which is a toggled softkey). The key mark will be displayed on the left side of `KEY LOCK`, and the Keys locked message will be displayed on the system message line.
4. Press `KEY LOCK` again to enable all front panel keys.

BIN COUNT DISPLAY Page

When you press **DISPLAY FORMAT** and **BIN COUNT**, the *BIN COUNT DISPLAY* page will be displayed. On the *BIN COUNT DISPLAY* page, the comparator's count results are displayed.

- BIN Counter (*SYS MENU*)
- LOAD/STORE (*SYS MENU*)
- Printout (*SYS MENU*)
- Keylock (*SYS MENU*)

This page also provides the following information in the monitor areas (monitor areas look like fields, but they are not). These conditions can be set from the *LIMIT TABLE SETUP* page. (For more details on the following controls, refer to "MEAS SETUP Page" in Chapter 5.)

- Nominal Value (*NOM*)
- Measurement Function (*FUNC*)
- Bin Sorting Low/High Limits (*LOW, HIGH*)

The available fields and the softkeys which corresponded to each field on this page are shown in Figure 4-7 and Figure 4-8.

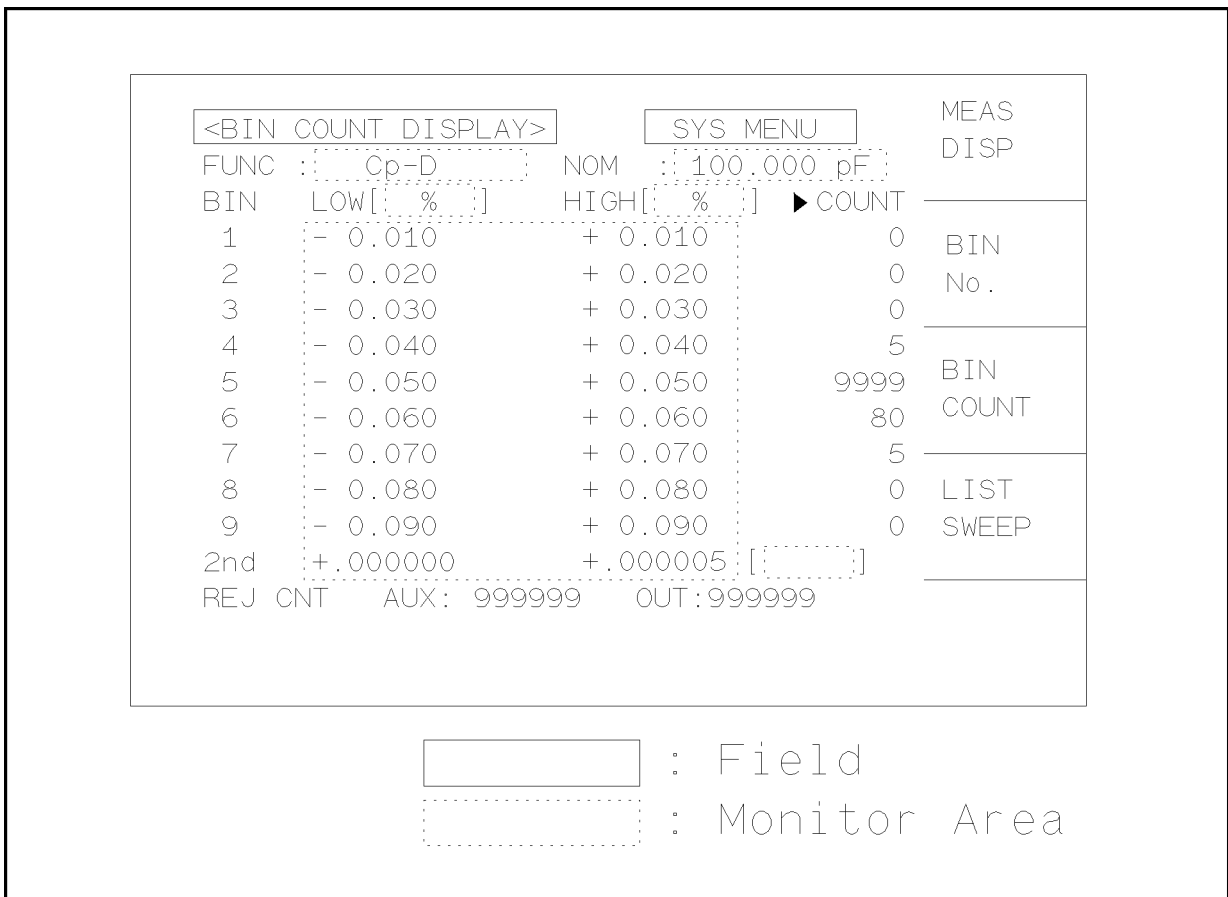

Figure 4-7. Available Fields on the BIN COUNT DISPLAY Page

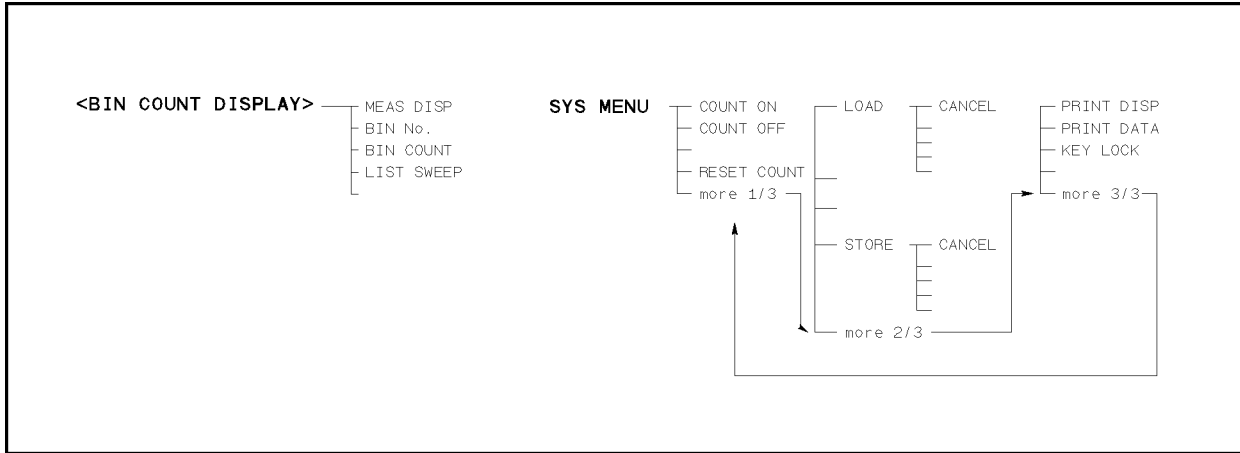

Figure 4-8. Available Softkeys on the BIN COUNT DISPLAY Page

SYS MENU Field The system menu on this page allows you to perform the following functions.

- Bin Counter ON/OFF Selection
- LOAD/STORE
- Printer
- Keylock

These functions, except for the bin counter function, are the same as the functions displayed on the system menu of the *MEAS DISPLAY* page. (The description of each function is given in “SYS MENU Field” on page 4-4.)

COUNT ON /COUNT OFF Softkeys

The 4285A has bin counting capability. When the comparator function is used, the number of components sorted into each BIN is counted. The maximum count is 999999, the overflow message “----” will be displayed when this value is exceeded. In this case, the BIN counter will still be operating, and you can get the count data only via GPIB.

Setting the Bin Counter ON or OFF

Perform the following steps to set the counter function to ON or OFF.

1. Set the COMPArator to ON either on the *BIN No. DISPLAY* page or on the *LIMIT TABLE SETUP* page.
2. On the *BIN COUNT DISPLAY* page, move the CURSOR to *SYS MENU* field.
3. Press **COUNT ON** to set the counter function to ON.
4. Press **COUNT OFF** when you don’t use the counter function. The number of count stops and the count value is retained. Counting starts from the retained count value when **COUNT ON** pressed again.
5. When **RESET COUNT** is pressed, all counts are reset to zero. The message *Resetting count. Are you sure?* will be displayed on

the system message line, and softkey labels are changed to **YES** and **NO**. Press **YES**.

Loading or Storing the Control Settings

Perform the following steps to store the current control settings to the internal non-volatile memory or the external memory card, and to load the control settings from the internal non-volatile memory or the external memory card.

1. Move the **CURSOR** to the **SYS MENU** field on the **BIN COUNT DISPLAY** page.
2. Insert a memory card into the **MEMORY** card slot, if you are going to store or load the settings to or from a memory card.
3. Press **more 1/3**.
4. Press **STORE** when you want to use the **STORE** function. The message **Enter record number to STORE** will be displayed on the system message line. Press **LOAD** when you want to use the **LOAD** function. Then the **Enter record number to LOAD** will be displayed on the system message line.
5. Use the numeric entry keys and the **(ENTER)** key to enter the record number at which the current control settings will be **STORED** to or **LOADED** from.

Printing the Measurement Result

Use the **PRINT DISP** or **PRINT DATA** mode and perform the following steps to print out the display page or the measurement data.

1. Connect the 4285A to the printer using an GPIB cable.
2. Set the printer to the listen only mode.
3. Set the talk only mode to **ON** on the **SYSTEM CONFIG** page.
4. Press **(DISPLAY FORMAT)** and **BIN COUNT** to display the **BIN COUNT DISPLAY** page.
5. Move the **CURSOR** to the **SYS MENU** field.
6. Press **more 1/3** and then **more 2/3**.
7. Press **PRINT DISP** when you want to print out the displayed page. Figure 3-10 shows a sample print out of the display page.

Press **PRINT DATA** when you want to print out the measurement results. The marker will appear beside **PRINT DATA**. The measurement results are printed out on subsequent measurements.

```

<BIN COUNT DISPLAY>      SYS MENU
FUNC : Cp-D      NOM : 0.00000pF
BIN  LOW [ F ]  HIGH[ F ]  COUNT
  1  +400.000p  +410.000p    0
  2           +420.000p   829
  3           +430.000p   204
  4           +440.000p    0
  5           +450.000p    0
  6           +460.000p    0
  7           +470.000p    0
  8           +480.000p    0
  9           +490.000p    0
2nd -.010000  +.100000 [   ]
REJ CNT  AUX: 8      OUT: 49

```

Figure 4-9. BIN COUNT DISPLAY Page Printout Example

Locking Out the Front Panel

Perform the following steps to disable all front panel operations on the *BIN COUNT DISPLAY* page.

1. Move the CURSOR to the *SYS MENU* field.
2. Press **more 1/3**, and **more 2/3**.
3. Press **KEY LOCK** (a toggled softkey). The key mark will be displayed on the left side of **KEY LOCK**, and the message Keys locked will be displayed on the system message line.
4. Press **KEY LOCK** again, if you want to enable the front panel keys.

LIST SWEEP DISPLAY Page

The 4285A's LIST SWEEP function permits entry of up to ten frequencies, signal levels, or dc bias levels, with the measurement limits. The list of values can be entered on the *LIST SWEEP SETUP* page under **MEAS SETUP**. When you press **DISPLAY FORMAT** and **LIST SWEEP**, the *LIST SWEEP DISPLAY* page will be displayed. On the *LIST SWEEP DISPLAY* page, the 4285A automatically sweeps on the specified points and the measurement results are compared with the limit values. During a sweep, an asterisk mark (*) will appear on the left side of the current point being measured. The following measurement controls can be set from this page. (Each field in parenthesis is used when that control is set.) Sweep points can't be set in this page, they are set only in *LIST SWEEP SETUP* page.

- Sweep Mode of the List sweep Measurement (*MODE*)
- LOAD/STORE (*SYS MENU*)
- Printout (*SYS MENU*)
- Keylock (*SYS MENU*)

This page also provides the following information in the monitor areas (monitor areas look like fields, but they are not). These conditions can be set from the *LIST SWEEP SETUP* page. (For more details on the following controls, refer to "LIST SWEEP SETUP Page" in Chapter 5.

- Sweep parameter
- Sweep points
- Primary parameter
- Secondary parameter

The available fields and the softkeys which corresponded to each field on this page are shown in Figure 4-10 and Figure 4-11.

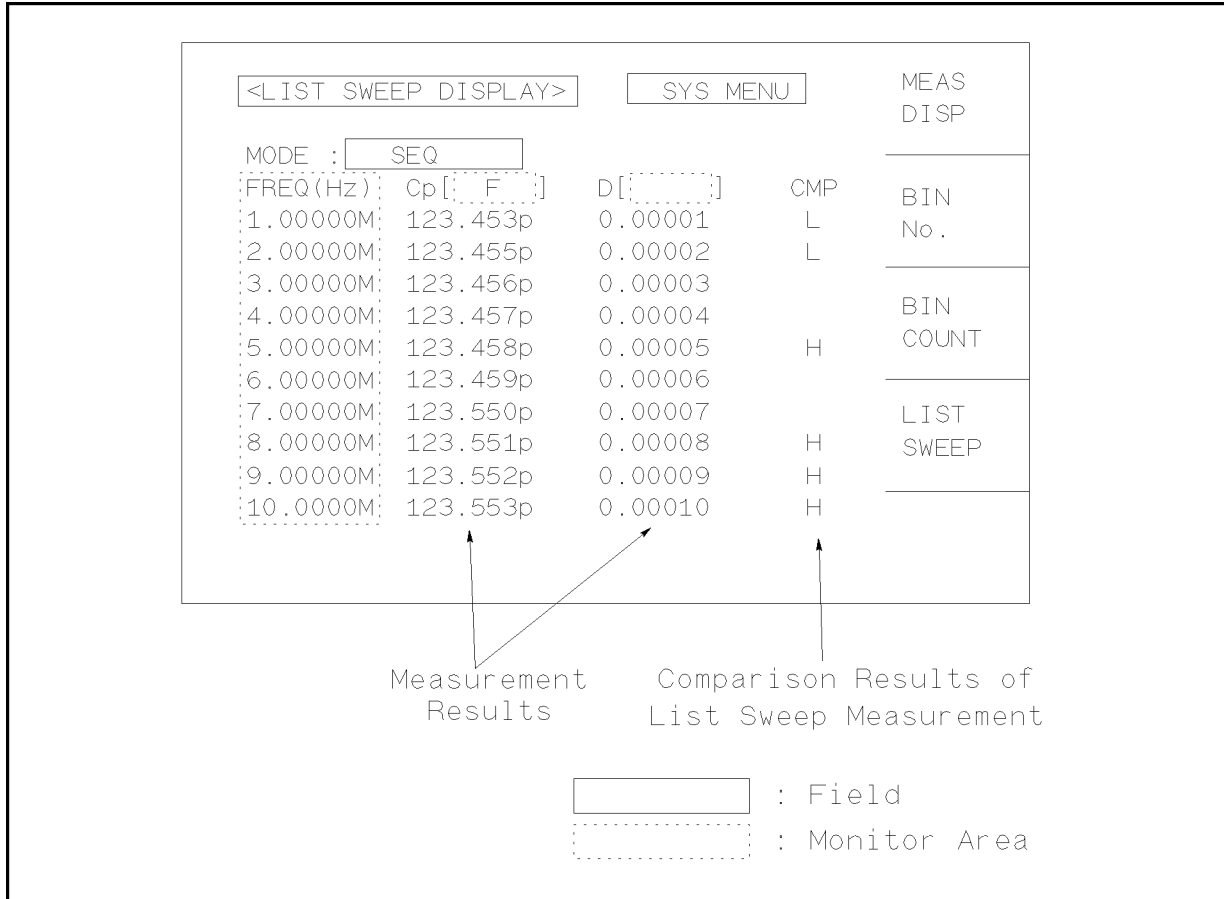

Figure 4-10. Available Fields on the LIST SWEEP DISPLAY Page

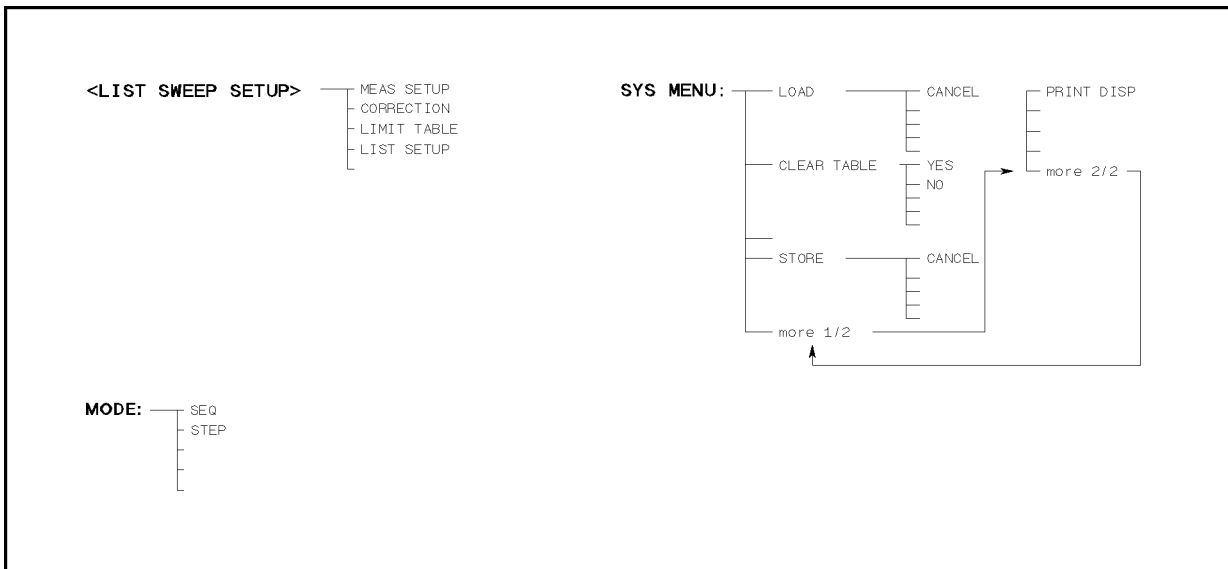

Figure 4-11. Available Softkeys on the LIST SWEEP DISPLAY Page

MODE Field

There are two measurement modes for list sweep measurements: sequential (SEQ) mode and step (STEP) mode. In the case of SEQ mode, when the 4285A is triggered once, all sweep points are automatically swept. In the case of the STEP mode, each time the 4285A is triggered the sweep point is increment by one step.

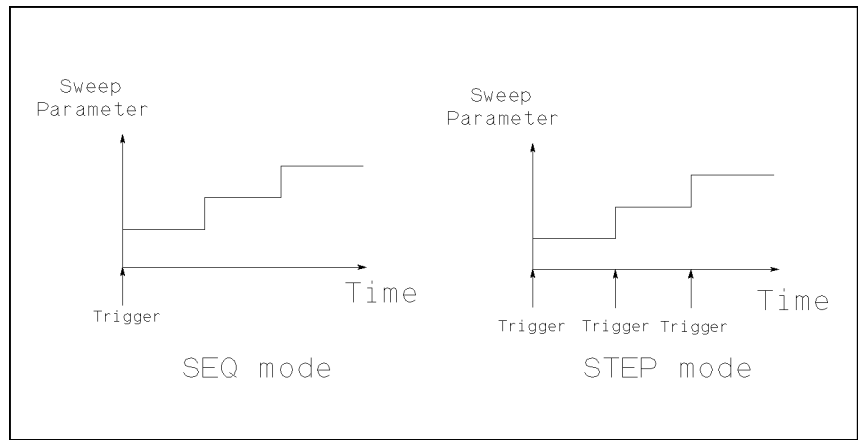

Figure 4-12. List Sweep Modes

Note



When two or more sweep points are the same and adjacent, the 4285A measures the device once, and then the measurement result is compared to limits set for each sweep point.

Setting the List Sweep Measurement Mode

Perform the following steps to set the list sweep measurement mode to the SEQ or STEP modes.

1. Move the CURSOR to the *MODE* field. The following softkeys will be displayed.
 - SEQ
 - STEP
2. Use the softkeys to select and set the list sweep measurement mode (SEQ or STEP mode).

SYS MENU Field

The system menu on this page allows you to perform the following functions.

- LOAD/STORE
- Printout
- Keylock

These functions are the same as the functions of the system menu on the *MEAS DISPLAY* page. A description of each function is mentioned on “System Menu”, in page 4-4.

Storing the Control Settings

Perform the following steps to store the control settings to memory.

1. Move the CURSOR to the *SYS MENU* field.
2. If you want to store the data to the memory card, insert a memory card to the MEMORY card slot until it locks into place.
3. Press **STORE**. The message Enter record number to STORE will be displayed on the system message line.
4. Enter a record number using the numeric entry keys and **(ENTER)** to store the current control settings. Use record number 0 to 9 for internal memory, and 10 to 19 for an external memory card.

Loading the Control Settings

Perform the following steps to load the control settings from the internal non-volatile memory or from an external memory card.

1. Move the CURSOR to the *SYS MENU* field.
2. If you want to load the data from the memory card, insert the memory card into the MEMORY card slot.
3. Press **LOAD**. The message Enter record number to LOAD will be displayed on the system message line.
4. Enter the record number using the numeric entry keys and **(ENTER)**.

Printing the Measurement Result

Perform the following steps to printout the display page or to list sweep measurement results using the PRINT DISP mode or PRINT DATA mode.

1. Connect the 4285A to the printer using an GPIB cable.
2. Set the printer to the listen only mode.
3. On the *SYSTEM CONFIG* page, set the talk only mode to ON.
4. Press **(DISPLAY FORMAT)**, and press **LIST SWEEP** to display the *LIST SWEEP DISPLAY* page.
5. Move the CURSOR to the *SYS MENU* field.
6. Press **more 1/2**.
7. Press **PRINT DISP** to printout the display page. The displayed page will be printed out as shown in Figure 4-13.

<LIST SWEEP DISPLAY>		SYS MENU	
MODE : SEQ			
FREQ[Hz]	Cp[F]	D[]	CMP
1.0000M	418.392p	.032713	
2.0000M	412.219p	.039522	L
3.0000M	407.616p	.044487	
4.0000M	403.314p	.050398	
5.0000M	399.117p	.053955	
6.0000M	395.370p	.056156	
7.0000M	391.415p	.058472	
8.0000M	387.752p	.059876	
9.0000M	384.167p	.061341	H
10.0000M	380.539p	.062622	H

Figure 4-13. LIST SWEEP DISPLAY Page Printout Example

Press **PRINT DATA** to print out the measurement results. A marker will appear beside **PRINT DATA**. The measurement results will be printed out on subsequent measurements according to the following data format (This format is the same as the ASCII format of the data transfer via GPIB. For more details, refer to “ASCII Format” in Chapter 8.)

Note



When the sequential sweep mode is used, the following format is repeated at each sweep point.

<DATA A>,<DATA B>,<STATUS>,<IN/OUT><CR><LF>

Where,

<DATA A> The measurement results of the primary parameter (|Z|, |Y|, C, L, R, G).
12 ASCII characters (SN.NNNNNESNN)

<DATA B> Measurement results of the secondary parameter (θ , D, Q, G, R_s, X, B).
12 ASCII characters (SN.NNNNNESNN)

<STATUS> 0 : Normal Measurement.
1 : Analog Bridge is unbalanced.
2 : A/D converter doesn't work.
3 : Signal source overload.
4 : ALC unable to regulate.

<IN/OUT> -1 : LOW
0 : IN
1 : HIGH

Note



When the <STATUS> is 1 or 2, 9.9E37 is output as the measurement data. When the <STATUS> is 0, 3, or 4, the actual measurement results are output.

Locking Out the Front Panel

Perform the following steps from the *LIST SWEEP DISPLAY* page to disable all front panel operation.

1. Move the CURSOR to the *SYS MENU* field.
2. Press **more 1/2**.
3. Press **KEY LOCK** (a toggled softkey). The icon of a key will be displayed on the left side of **KEY LOCK**, and the Keys locked message will be displayed on the system message line.
4. Press **KEY LOCK** again, when you want to enable all front panel keys.

MEAS SETUP Menu

Introduction

This chapter provides functional descriptions for the normal LCR measurement of each page under **MEAS SETUP**. This information includes the required front panel and softkey operations for correct setup.

The following four display pages are available under **MEAS SETUP**.

- *MEAS SETUP*
- *CORRECTION*
- *LIMIT TABLE SETUP*
- *LIST SWEEP SETUP*

This chapter describes the function of each field on each page in the order listed above.

MEAS SETUP Page

When you press **MEAS SETUP**, the *MEAS SETUP* page will be displayed. On this *MEAS SETUP* page, the following measurement control functions can be set. (The field in parenthesis is used to set the control function.)

- LOAD/STORE (*SYS MENU*)
- Clear Setup (*SYS MENU*)
- System Reset (*SYS MENU*)
- Printout (*SYS MENU*)
- Comment Line (*comment line*)
- Measurement Function (*FUNC*)
- Measurement Range (*RANGE*)
- Test Frequency (*FREQ*)
- Oscillator Level (*LEVEL*)
- DC Bias (*BIAS*)
- Integration Time (*INTEG*)
- Trigger Mode (*TRIG*)
- Automatic Level Control (*ALC*)
- Bias Monitor Mode (*MON*)
- Averaging Rate (*AVG*)
- Voltage Level Monitor ON/OFF (*Vm*)
- Current Level Monitor ON/OFF (*Im*)
- Trigger Delay Time (*DELAY*)
- Deviation Measurement Mode for Primary Parameter (*DEV A*)
- Deviation Measurement Mode for Secondary Parameter (*B*)
- Reference Value for the Deviation Measurement A (*REF A*)
- Reference Value for the Deviation Measurement B (*B*)

The available fields and the softkeys which corresponded to each field on this page are shown in Figure 5-1 and Figure 5-2 respectively.

<input type="text" value="<MEAS SETUP>"/>		<input type="text" value="SYS MENU"/>	MEAS SETUP
<input type="text" value="comment line"/>			
FUNC :	<input type="text" value="Cp-D"/>	RANGE :	<input type="text" value="AUTO"/>
FREQ :	<input type="text" value="1.00000MHz"/>	BIAS :	<input type="text" value="1.5000 V"/>
LEVEL :	<input type="text" value="* 1.00 V"/>	INTEG :	<input type="text" value="MED"/>
TRIG :	<input type="text" value="INT"/>	AVG :	<input type="text" value="4"/>
ALC :	<input type="text" value="ON"/>	Vm :	<input type="text" value="ON"/>
MON :	<input type="text" value="V BIAS"/>	Im :	<input type="text" value="ON"/>
		DELAY :	<input type="text" value="0 ms"/>
DEV A :	<input type="text" value="Δ ABS"/>	REF A :	<input type="text" value="123.456 pF"/>
B :	<input type="text" value="Δ ABS"/>	B :	<input type="text" value="0.00005"/>
			LIST SETUP

: Field

L2009001

Figure 5-1. Available Fields on the MEAS SETUP Page

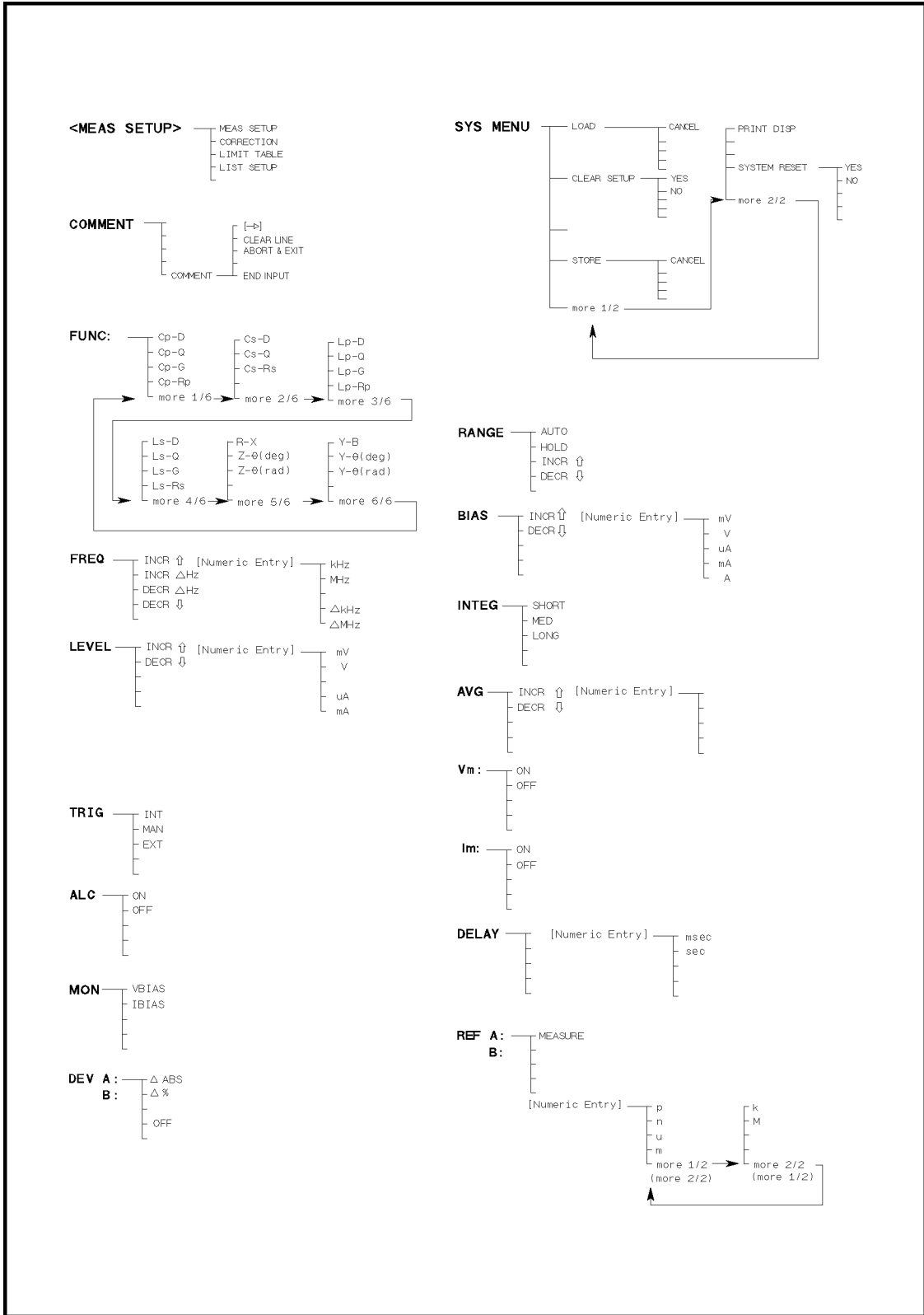

L2005002

Figure 5-2. Available Softkeys on the MEAS SETUP Page

FUNC Field The 4285A simultaneously measures the two complex impedance components (parameters) during a measurement cycle, and calculates the following impedance parameters. These parameters combinations are chosen in the *FUNC* field.

■ Primary Parameters

- |Z| (absolute value of impedance)
- |Y| (absolute value of admittance)
- L (inductance)
- C (capacitance)
- R (resistance)
- G (conductance)

■ Secondary Parameters

- D (dissipation factor)
- Q (quality factor)
- R_s (ESR (equivalent series resistance))
- R_p (equivalent parallel resistance)
- X (reactance)
- B (susceptance)
- θ (phase angle)

The primary and secondary parameters combinations, including the equivalent parallel and series combinations, are listed in Table 5-1.

Table 5-1. Measurement Function

Primary Parameter	Serial Mode	Parallel Mode
Z	Z-θ (rad) Z-θ (deg)	
Y		Y-θ (rad) Y-θ (deg)
C	C _s -D C _s -Q C _s -R _s	C _p -D C _p -Q C _p -G C _p -R _p
L	L _s -D L _s -Q L _s -R _s	L _p -D L _p -Q L _p -G L _p -R _p
R	R-X	
G		G-B

Choosing the Measurement Function

Perform the following steps to set the measurement function.

1. Move the CURSOR to the *FUNC* field using the CURSOR keys.
2. Press **more X/6** until the desired softkey labels are displayed. Figure 5-3 shows the display order of the measurement functions.

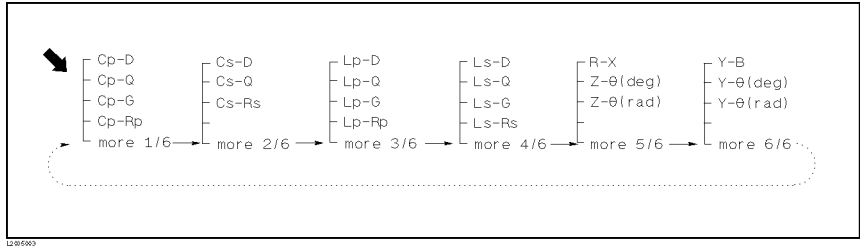

Figure 5-3. Measurement Function Display Order

3. Press the appropriate softkey.

RANGE Field

The 4285A has ten internal measurement ranges: 0Ω (Oscillator Level ≤ 1V), 0Ω (Oscillator Level > 1V), 50Ω, 100Ω, 500Ω, 1 kΩ, 5 kΩ, 10 kΩ, 50 kΩ, and 100 kΩ. When the measurement range is set to AUTO, the 4285A automatically selects the appropriate range according to the DUT's impedance, test frequency, and oscillator level.

Figure 5-4 shows the display range and effective measuring range for each measurement range while in the impedance mode (|Z|, R, X). For example, when the oscillator level is less than or equal to 1V_{rms}, 1 kΩ impedance DUT can be measured using the 0 Ω, 50 Ω, and 500 Ω ranges. But the 4285A's measurement accuracy is specified only for the 500 Ω range, and in the AUTO range, the 4285A automatically selects the 500 Ω range. If this DUT is measured using the 5 kΩ range or higher, UNBAL will be displayed.

As shown in Figure 5-4, the 4285A will display “-----” when an impedance of greater than 100 MΩ is measured. In the impedance mode (|Z|, R, X), the 4285A does not display a value greater than 100 MΩ although it can actually measure a value greater than 100 MΩ. In this case, change the FUNCTION to the admittance mode (|Y|, G, B).

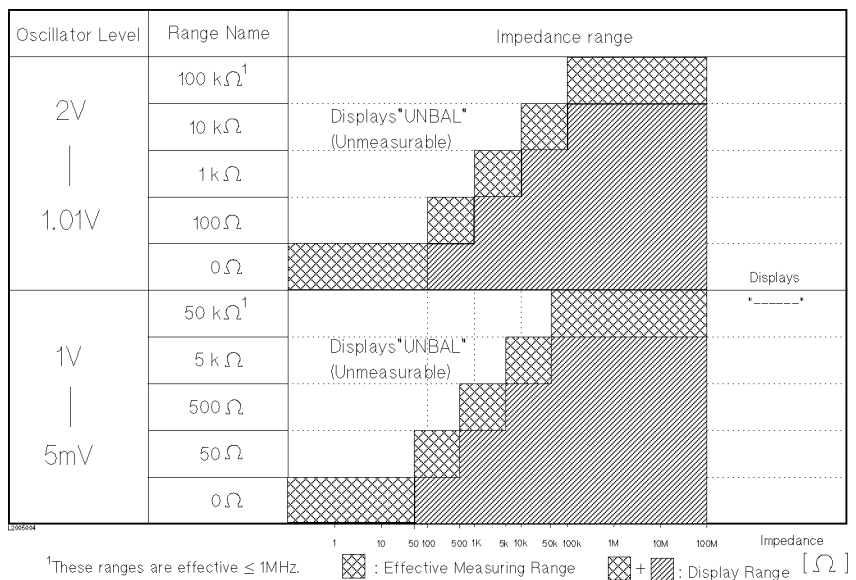

Figure 5-4. Effective Measuring Range for Each Measurement Range

When the measurement range is set to AUTO, the 4285A requires additional time to select the appropriate range. To reduce the ranging time, (for example when the 4285A is used with the component handler), it is recommended to fix the measurement range to an effective measuring range for the DUT. To do this, measure the DUT using AUTO range, and then move the CURSOR to the *RANGE* field and press **HOLD**. To change the range manually, press **INCR** ↑ or **DECR** ↓.

Note



Set the oscillator level and test frequency first !

The available measurement ranges change depending on the test frequency and oscillator level. If you set the measurement range first and then set the test frequency or oscillator level, the measurement range may be automatically changed.

AUTO Softkey

This softkey sets the measurement range to AUTO mode.

HOLD Softkey

This softkey fixes the measurement range. When the measurement range is set to the HOLD mode, the impedance range is fixed at the current range setting, and the impedance range name is displayed in the *RANGE* field.

INCR ↑ Softkey

This softkey increments the current measurement range to the next higher range. The measurement range is set to the HOLD mode.

DECR ↓ Softkey

This softkey decrements the current measurement range to the next lower range. The measurement range is set to the HOLD mode.

Setting the Measurement Range

Perform the following procedure to set the measurement range.

1. Move the CURSOR to the *RANGE* field using the CURSOR keys. The following softkeys will be displayed.
 - **AUTO**
 - **HOLD**
 - **INCR** ↑
 - **DECR** ↓
2. Press the appropriate softkeys to set the measurement mode and range.

FREQ Field

The measurement frequency of the 4285A can be set from 75 kHz to 30 MHz with 100 Hz resolution. To set the measurement frequency, enter the numeric value or use the **INCR** \uparrow /**DECR** \downarrow . When a numeric value below the test frequency resolution is entered, the setting value is rounded to the nearest available frequency point.

INCR \uparrow **Softkey**

This softkey increments the current test frequency to the next sequentially higher frequency point. There are 10 frequency points between successive decade values. The sequential frequency points which can be set using this softkey are the following 28 points.

75 kHz	100 kHz	1 MHz	10 MHz
80 kHz	120 kHz	1.2 MHz	12 MHz
	150 kHz	1.5 MHz	15 MHz
	200 kHz	2 MHz	20 MHz
	250 kHz	2.5 MHz	25 MHz
	300 kHz	3 MHz	30 MHz
	400 kHz	4 MHz	
	500 kHz	5 MHz	
	600 kHz	6 MHz	
	800 kHz	8 MHz	

INCR Δ Hz **Softkey**

This softkey increments the current test frequency by the specified step value. The default step is 100 Hz and this step can be changed with **Δ kHz** and **Δ MHz**. When the step value is entered from the entry keys, **Δ kHz** and **Δ MHz** will be displayed automatically.

DECR Δ Hz **Softkey**

This softkey decrements the current test frequency by the specified step value. The default step is 100 Hz and this step can be changed with **Δ kHz** and **Δ MHz**. When the step value is entered from the entry keys, **Δ kHz** and **Δ MHz** will be displayed automatically.

DECR \downarrow **Softkey**

This softkey decreases the test frequency to the next sequentially lower frequency point. There are ten frequency points between successive decade values. The frequency points set using this softkey are the same as set using **INCR** \uparrow .

kHz / **MHz** **Softkeys**

These softkeys are not normally displayed, they are displayed when a numeric key is pressed. These softkeys are used to input the frequency unit.

Δ kHz/ Δ MHz Softkeys

These softkeys are not normally displayed, they are displayed when a numeric key is pressed. These softkeys set the frequency step to INCR Δ Hz and DECR Δ Hz. The default and minimum step value is 100 Hz.

Setting the Test Frequency

There are two ways to set the test frequency. One is to use the softkeys, and the other is to use the numeric entry keys. Perform the following steps to set the test frequency.

1. Move the CURSOR to the *FREQ* field. The following softkeys will be displayed.
 - INCR \uparrow
 - INCR Δ Hz
 - DECR Δ Hz
 - DECR \downarrow
2. Select and set the test frequency using either the softkeys or the numeric entry keys. When the test frequency is entered using the numeric entry keys, kHz and MHz will be displayed. These softkeys can be used to enter the unit and to terminate the numeric data entry instead of using **ENTER**. When **ENTER** is used, the numeric data is entered with the default unit Hz.

LEVEL Field

In the *LEVEL* field, the internal oscillator level of the 4285A can be set as an rms (root mean square) value. You can set either the oscillator's voltage level or current level. The internal oscillator output impedance and tolerance calculation for the test cable length 0 m are :

$$(25 + 0.5f_m)\Omega \pm \left(10 + \frac{2}{3}f_m\right) \%$$

Where,

f_m : Test frequency [MHz]

Note



The 4285A oscillator voltage (or current) setting is obtained when the UNKNOWN terminals are opened (or shorted).

The oscillator voltage level can be set from 5 mV_{rms} to 2 V_{rms}, and the oscillator current level can be set from 200 μA_{rms} to 20 mA_{rms} with a resolution as listed in Table 5-2.

Table 5-2. Oscillator Level and Resolution

Mode	Oscillator Level	Resolution
Voltage	5 mV _{rms} to 200 mV _{rms} 210 mV _{rms} to 2 V _{rms}	1 mV _{rms} 10 mV _{rms}
Current	200 μA _{rms} to 2 mA _{rms} 2.1 mA _{rms} to 20 mA _{rms}	20 μA _{rms} 200 μA _{rms}

The 4285A can measure a device using a constant voltage or current level by using its automatic level control (ALC) function. The ALC function (*ALC* field) can be set to ON from the **MEAS SETUP** page. When a constant voltage or current level measurement is performed, an asterisk mark (*) is indicated at the left side of the oscillator level value. For details of the ALC function, refer to “ALC Field” described later.

INCR ↑ / DECR ↓ Softkeys

These softkeys increment and decrement the current oscillator level by the specified step listed in Table 5-2, Resolution.

mV , V , μA , and mA Softkeys

These softkeys are not normally displayed, they are displayed when a numeric key is pressed. These softkeys are used to input the oscillator level unit.

Setting the Oscillator Level

There are two ways to set the oscillator level. One is to use the softkeys, and the other is to use the use the numeric entry keys. Perform the following steps to set the oscillator level.

1. Move the CURSOR to the *LEVEL* field. The following softkeys will be displayed.

- INCR ↑
- DECR ↓

2. Select and set the oscillator level using either the softkeys or the numeric entry keys. When the oscillator level is entered using the numeric entry keys, the softkey labels will change to the available units labels (mV, V, μ A, and mA), and you can use these softkeys to enter the units and data instead of using **ENTER**. When **ENTER** is used, the numeric data is entered with V or A as the default unit.

Note 

To change the oscillator level from voltage to current or current to voltage, use the numeric entry keys and units' softkeys.

BIAS Field

The 4285A provides the two following methods of applying a DC bias to a DUT.

- Option 001 DC bias
- Option 002 Accessory Control Interface, 42841A Bias Current Source, and 42842C Bias Current Test Fixture

For operation combining an 42841A with an 42842C, refer to the *42841A Operation Manual* (Agilent Part Number 42841-90000) and the *42842A/B/C, 42843A Operation and Service Manual* (Agilent Part Number 42842-90001).

When Option 001 is installed, the DC bias voltage can be set from 1 mV to ± 40 V, or the DC bias current can be set from 10 μ A to ± 100 mA with a resolution as listed in Table 5-3.

Note 

Both Options 001 and 002 can't be operated at the same time. To use Option 001, set the *CONFIG* field to **OFF** in the *SYSTEM CONFIG* page. To use Option 002, set the *CONFIG* field to **I BIAS**. For details, refer to "CONFIG Field" in Chapter 6.

Table 5-3. DC Bias and Resolution (Option 001)

Mode	DC Bias Level	Resolution
Voltage	\pm (0 V to 4 V)	1 mV
	\pm (4.002 V to 8 V)	2 mV
	\pm (8.005 V to 20 V)	5 mV
	\pm (20.01 V to 40 V)	10 mV
Current	\pm (0 A to 40 mA)	10 μ A
	\pm (40.02 mA to 80 mA)	20 μ A
	\pm (80.05 mA to 100 mA)	50 μ A

Note 

The 4285A DC bias voltage (or current) setting is obtained when the UNKNOWN terminals are opened (or shorted). When a DUT has DC resistance, the DC bias current setting value is different from the actual DC bias current flowing through the DUT. (Refer to Figure 5-5.)

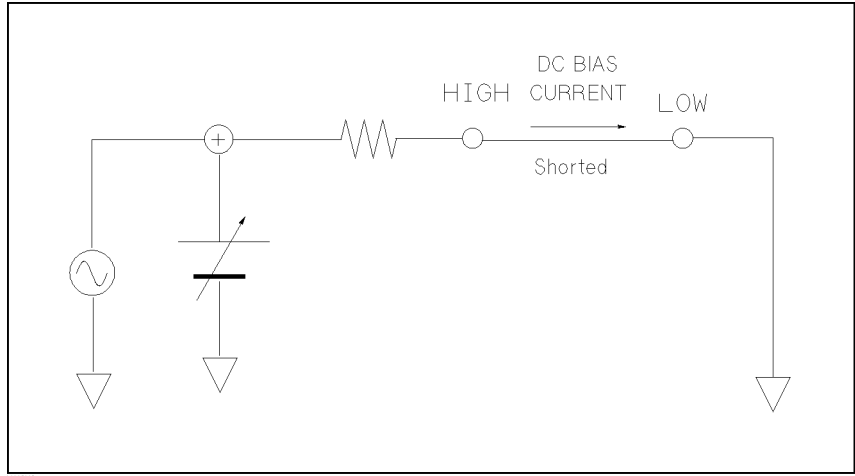

Figure 5-5. DC BIAS Current

When current flows through the DUT, the DC voltage across the DUT is different from the specified voltage. To monitor the actual voltage or current being applied to the DUT, connect a digital voltmeter to the INT DC BIAS MONITOR terminal on the rear panel. For details, refer to “MON Field”.

Note



DC BIAS is used to enable the DC bias output and it is a toggle type switch. The DC bias will be output after setting **DC BIAS** on the front panel to ON.

When **DC BIAS** is set to OFF, even though the DC bias value is set in the *BIAS* field, no DC bias is output.

INCR ↑ and DECR ↓ Softkeys

These softkeys increment and decrement the current DC bias level by the specified step in Table 5-3, Resolution.

mV , V , μA , mA , and A Softkeys

These softkeys are not normally displayed, they are displayed when a numeric key is pressed. These softkeys are used to input the DC bias level unit.

Setting the DC Bias

There are two ways to set the DC bias value, one is to use the softkeys, and the other is to use the numeric entry keys. Perform the following steps to set the DC bias.

1. Move the CURSOR to the *BIAS* field. The following softkeys will be displayed.
 - INCR ↑
 - DECR ↓

2. Select and set the DC bias to your desired bias using either the softkeys or the numeric entry keys. When the DC bias is entered using the numeric entry keys, the softkey labels will change to the available units (**mV**, **V**, **μA**, **mA**, and **A**), and you can use these softkeys instead of using **ENTER**. When **ENTER** is used, the numeric data is entered with V or A as the default unit.

Note



To change the DC bias level from a voltage to current or current to voltage setting, use the numeric entry keys and units' softkeys.

3. Press **DC BIAS** to enable the DC bias output.

INTEG Field

The 4285A's measurement time is determined by the following.

- Integration time (A/D conversion)
- Averaging rate (number of measurements averaged)
- Delay time (time delay between the trigger and the start of the measurement)
- Measurement result display time

The 4285A uses an multi-slope type A/D converter to convert the analog signal to digital data. The *INTEG* field is used to select the integration time of the A/D converter. SHORT, MEDIUM, or LONG integration times can be selected. The best measurement accuracy can be obtained when the INTEG is set to LONG. For the measurement time of each integration time setting, refer to "Supplemental Performance Characteristics" in Chapter 1.

SHORT Softkey

This softkey selects the SHORT integration time.

MED Softkey

This softkey selects the MEDIUM integration time.

LONG Softkey

This softkey selects the LONG integration time.

Setting the Integration Time

Perform the following steps to set the integration time.

1. Move the CURSOR to the *INTEG* field. The following softkeys will be displayed.
 - **SHORT**
 - **MED**
 - **LONG**
2. Press the appropriate softkey to select integration time.

Comment Field

Descriptive alpha-numeric string data, up to 30 ASCII characters, can be entered as a comment. The *comment* field is located on the second line of the LCD screen and there is no default setting. This comment is stored to the internal non-volatile memory or to the external memory card along with the current 4285A control settings. Also this comment line is loaded from the internal non-volatile memory or from the external memory card with the control settings.

COM-MENT Softkey

When this softkey is pressed, the *COMMENT INPUT* page as shown in Figure 5-6 is displayed. A description of the softkeys on this page follows.

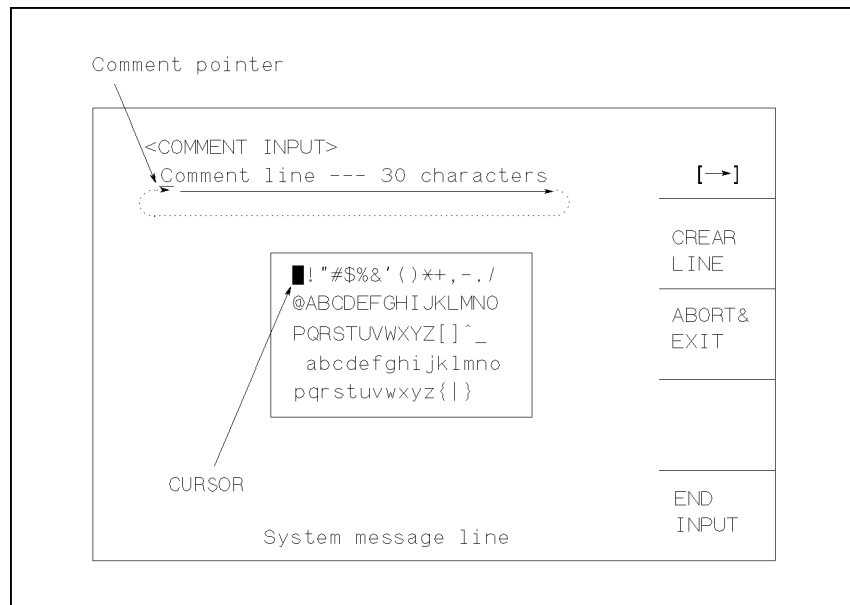

Figure 5-6. COMMENT INPUT Page Layout

[←] Softkey

This softkey moves the comment pointer to the right one character.

CLEAR LINE Softkey

This softkey clears the current comment string.

ABORT& EXIT Softkey

This softkey abandons the current comment editing data and returns the display to the *MEAS SETUP* page. The comment previously stored before editing still remains.

END INPUT Softkey

This softkey terminates the comment input and returns the display to the *MEAS SETUP* page. The previously displayed comment data is replaced by the newly entered data.

Entering Comments

Perform the following steps to enter a comment.

1. Move the CURSOR to the *comment* field. The following softkeys will be displayed.
 - COM-MENT
2. Press COM-MENT to enter the *COMMENT INPUT* page. The following softkeys will be displayed.
 - [→]
 - CLEAR LINE
 - ABORT& EXIT
 - END INPUT
3. Move the CURSOR, using the CURSOR keys on the letter to be selected.
4. Press **ENTER** to select the letter. Numeric entry keys also can be used for the 0 - 9, - (minus), and . (period).
5. Press either END INPUT or ABORT& EXIT to terminate the *COMMENT INPUT* page.

TRIG Field

The 4285A has four trigger modes: INTernal, EXTernal, MANual, and BUS. Except for BUS trigger mode these trigger modes can be set in the *TRIG* field. The BUS trigger mode is used when the 4285A is controlled via GPIB.

INT Softkey

When the trigger mode is set to INTernal trigger mode, the 4285A continuously repeats measurements on any display page under **DISPLAY FORMAT**.

MAN Softkey

When the trigger mode is set to MANual trigger mode and display page set to any page under **DISPLAY FORMAT**, the 4285A performs a single measurement every time when **TRIGGER** on the front panel is pressed.

EXT Softkey

When the trigger mode is set to EXTernal and to the pages under **DISPLAY FORMAT**, the 4285A performs a single measurement every time a low-to-high transition TTL level signal is applied to the *EXT TRIGGER* connector on the rear panel. External triggering can also be achieved by momentarily connecting the center conductor of the *EXT TRIGGER* connector to chassis ground (center conductor circuit contains a pull-up resistor). Figure 5-7 shows the specifications required for the TTL pulse.

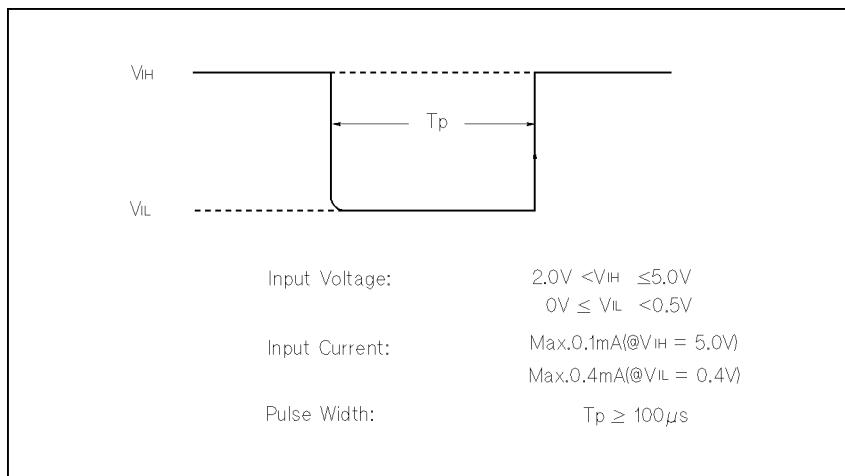

Figure 5-7. Required External Trigger Pulse Specification

Note



The 4285A ignores trigger request while a measurement is in progress. Trigger the 4285A after the measurement is completed.

Select the EXT trigger mode when the 4285A is triggered from an Option 201, 202, or Option 301 interface.

When the trigger mode is set to BUS trigger mode, the 4285A performs a single measurement every time the TRIGGER TMSL command, TRIGGER (GET) bus command, or *TRG common command is sent to the 4285A via GPIB. The BUS trigger mode cannot be set on the front panel. Send the TRIGGER:SOURce BUS command via GPIB to set the trigger mode to the BUS trigger mode. For detail, refer to “Trigger System” in Chapter 8.

Setting the Trigger Mode

Perform the following steps to set trigger modes except for the BUS trigger mode.

1. Move the CURSOR to the TRIG field. The following softkeys will be displayed.
 - INT
 - MAN
 - EXT
2. Set the trigger mode using the softkeys.

ALC Field The automatic level control (ALC) function regulates oscillator voltage and current so that the actual test signal level (voltage across the DUT, or current through the DUT) is equal to the desired value. By using this function, the test signal voltage or current at the DUT can be held constant. This capability is activated or deactivated in the *ALC* field.

When the ALC function is used, the oscillator level setting range is limited as shown in Table 5-4.

Table 5-4. ALC Function Setting Range

Mode	Range	Resolution
Voltage	10 mV _{rms} to 1 V _{rms}	1 mV _{rms} (\leq 200 mV _{rms})
		10 mV _{rms} ($>$ 200 mV _{rms})
Current	100 μ A _{rms} to 20 mA _{rms}	20 μ A _{rms} (\leq 2 mA _{rms})
		200 μ A _{rms} ($>$ 2 mA _{rms})

Note  When the entered value is out of the range given in Table 5-4, the *ALC* function is automatically turned OFF and the entered value is a valid normal oscillator level setting. And when the ALC function is turned on while the LEVEL setting is out of the ALC's available range, the LEVEL setting is changed to be within the ALC's available range.

Note  ALC is achieved by feedback using the level monitor function as shown in Figure 5-8. The feedback operation performs a level measurement/oscillator level adjustment 2 to 6 times per measurement. (The time required (n in the following formula) depends on the device being tested. The more non-linear the device is, the more time required, n will be longer.) When the ALC function can't regulate the level using 6th output level measurement/adjustment cycles (when a device has non-linear characteristics, the ALC function may stop before the 6 output level measurement/adjustment cycle), the ALC function stops, beeps, displays a warning message *ALC unable to regulate*, and sets the oscillator level to equal your setting value, open-loop, the output level will be the same as when ALC is set to OFF. The required time for operating the ALC function is calculated from the following formula.

(measurement time (SHORT) + approximately 115 ms) \times n

Where, $2 \leq n \leq 6$

Note  The ALC function may not work properly, if cable correction was not performed correctly and the *CABLE* field setting is 1m or 2m.

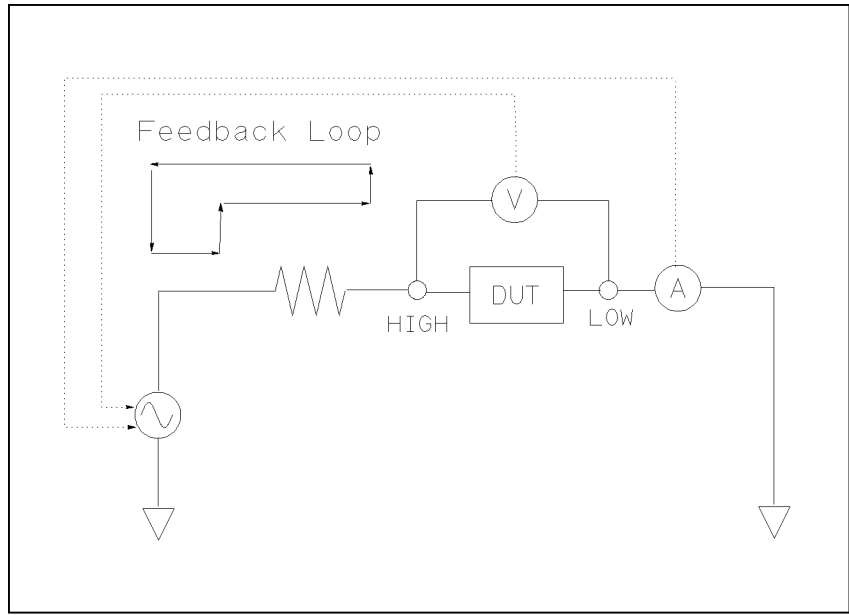
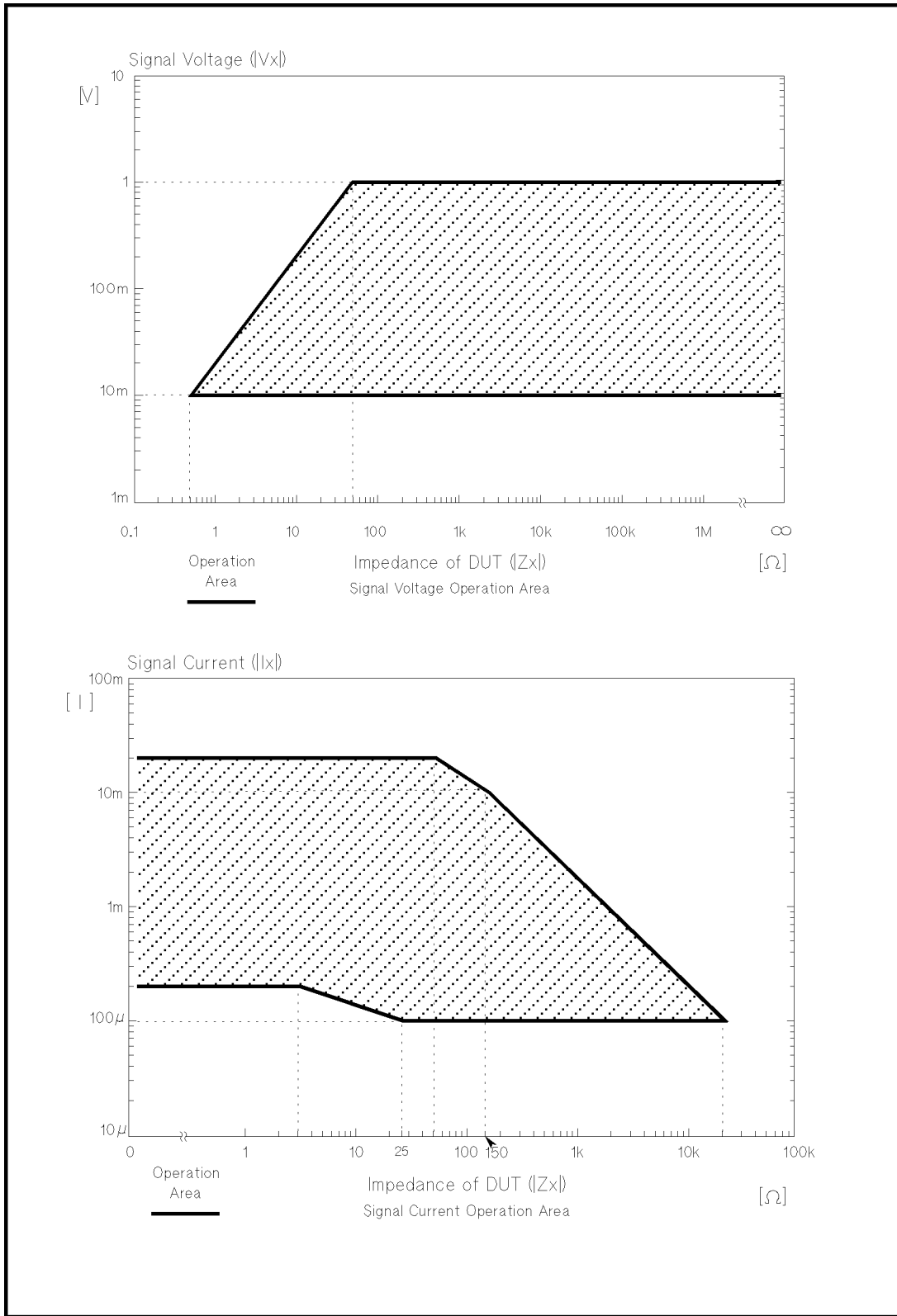

Figure 5-8. Feedback Circuit

The operation range of the ALC function is shown in Figure 5-9. The ALC function can regulate the specified voltage or current when the DUT's impedance value is within the range shown in Figure 5-9. The uncertainty of the limitation of the operating range is $\pm 30\%$. If the DUT's impedance is out of the range, ALC may not be able to regulate the voltage or current, and the test signal level applied to the DUT may be different from specified value.



L2005010

Figure 5-9. Available Operating Area For the ALC Function

Setting the Automatic Level Control Function

Perform the following steps to turn the ALC function ON or OFF.

1. Move the CURSOR to the *ALC* field. The following softkeys will be displayed.
 - **ON**
 - **OFF**
2. Press **ON** to set the ALC function to ON. Press **OFF** to set the ALC function OFF.

MON Field

When Option 001 is installed, the actual DC voltage or current applied to the DUT can be monitored from the INT DC BIAS MONITOR BNC connector on the rear panel. Either DC bias voltage or current monitor function can be selected on the *MON* field.

Note



MON field displays “---” when the *CONFIG* field is set to **I BIAS**.

The monitor accuracies are given as follows and are applied when the input impedance of the digital voltmeter $\geq 10 \text{ M}\Omega$.

■ DC Bias Voltage Monitor

Output Voltage : DC bias voltage across the DUT $\times 1$ [V]
Output Impedance : 11 k Ω
Monitor Accuracy : $\pm(0.2\% + 2 \text{ mV})$

■ DC Bias Current Monitor

Output Voltage: DC bias current through the DUT $\times 10 \text{ }\Omega$
[V] (1 V at 100 mA)
Output Impedance : 10 k Ω
Monitor Accuracy : $\pm(1\% + 0.3 \text{ mA})$

V BIAS Softkey

This softkey sets the INT DC BIAS MONITOR to the voltage bias monitor mode.

I BIAS Softkey

This softkey sets the INT DC BIAS MONITOR to the current bias monitor mode.

Setting the DC Bias Monitor Mode

To monitor the actual bias current or voltage applied to the DUT, connect the digital voltmeter to the *DC BIAS MONITOR* BNC connector on the rear panel. And perform the following steps to set the DC bias monitor mode.

1. Move the CURSOR to the *MON* field. The following softkeys will be displayed.

- V BIAS
- I BIAS

2. Press V BIAS or I BIAS to set the DC bias monitor mode.

AVG Field

The 4285A's averaging function arithmetically averages the results of two or more A/D conversions results. The averaging rate can be set in the *AVG* field. Any number of averages can be set from 1 to 256.

The A/D conversion time can be set in the *INTEG* field. For the actual measurement time, refer to "Measurement Time" in Chapter 1)

INCR ↑ and DECR ↓ Softkeys

These softkeys increment and decrement the averaging rate in steps of 1, 2, 4, 8, 16, 32, 64, 128, and 256.

Setting the Averaging Rate

Perform the following steps to set the averaging rate.

1. Move the CURSOR to the *AVG* field. The following softkeys will be displayed.

- INCR ↑
- DECR ↓

2. Use the softkeys to set the averaging rate, or enter the averaging rate using the numeric entry keys, and press **ENTER**.

DELAY Field

The 4285A's delay time function allows you to set a trigger delay time which the 4285A delays the start of the measurement after it is triggered. The trigger delay time of the 4285A can be set from 0 s to 60 s in 1 ms steps. This function is useful when a component handler is used with the 4285A. The 4285A can wait to start the measurement until mechanical contact with the DUT becomes stable. When the list sweep measurement is performed, the 4285A will delay the start of the measurement at each sweep point using the trigger delay time.

msec and sec Softkeys

These softkeys are not normally displayed, they are displayed when the numeric key is pressed. These softkeys are used to input the delay time unit.

Setting the Delay Time

Perform the following steps to set the delay time.

1. Move the CURSOR to the *DELAY* field.

2. Enter the delay time using the numeric entry keys. When one of the numeric entry keys is pressed, the following unit softkeys will be displayed, these can be used instead of **ENTER**.

- msec

- **sec**

V_m/I_m Fields

The test signal level monitor function allows you to monitor the actual voltage applied across the DUT or the actual current flowing through the DUT. This function can be activated or deactivated on the *V_m* and *I_m* field. Voltage and current monitor values are displayed on the *V_m* and *I_m* monitor area on the *MEAS DISPLAY* page respectively.

Setting the Test Signal Level Monitor Function

Perform the following steps to set the test signal level monitor function to ON or OFF.

1. Move the CURSOR to the *V_m* field. The following softkeys will be displayed.
 - **ON**
 - **OFF**
2. Press **ON** to set the test signal voltage monitor function to ON. Press **OFF** to set the test signal voltage monitor function to off.
3. Move the CURSOR to the *I_m* field. The following softkeys will be displayed.
 - **ON**
 - **OFF**
4. Press **ON** to set the test signal current monitor function to ON. Press **OFF** to set the test signal current monitor function to OFF.

DEV A/B Fields

The deviation measurement function allows you to display the deviation value instead of the actual measurement value. The deviation measurement can be made for both primary (data A) and secondary (data B) parameters. It is activated or deactivated in the *DEV A* and (*DEV*)*B* field respectively. The deviation value is calculated by taking the difference between the actual measurement value and a previously stored reference value (*REF A/B* fields). This function is useful for evaluating temperature, frequency, DC bias, and other characteristics of a DUT.

There are two types of deviation measurements. One is to represent the deviation by an absolute value and the other is by percentage. These deviation measurements can be made for both primary and secondary parameter measurements.

Δ ABS Softkey

The difference between the measured value of the DUT and a previously stored reference value are displayed by absolute value. The formula used to calculate the deviation is as follows.

$$\Delta \text{ABS} = X - Y$$

Where, X: The measured value of the DUT

Y: The stored reference value

Δ % Softkey

The difference between the measured value of the DUT and a previously stored reference value are displayed as a percentage of the reference value. The formula used to calculate the percent deviation is as follows.

$$\Delta\% = (X - Y) / Y \times 100 [\%]$$

Where, X: The measured value of the DUT
Y: The stored reference value

OFF Softkey

This softkey turns the deviation measurement off.

REF A/B Fields

These fields are used to set reference value of the deviation measurement. The reference value can be set either by entering a numeric value using the ENTRY keys or by measuring reference DUT. When you perform the reference measurement in *REF A* or *(REF) B* fields, other reference values is also updated.

MEA-SURE Softkey

This softkey is used to measure the connected reference device, and the measurement results are entered as a reference value for REF A and REF B.

Performing the Deviation Measurement

Perform the following steps to execute the deviation measurement.

1. Move the CURSOR to *REF A* field to enter the reference value for the primary parameter. The following softkey will be displayed.
 - **MEA-SURE**
2. Enter the reference value for the primary parameter using the numeric entry keys or press **MEA-SURE** after connecting the reference DUT.
3. Move the CURSOR to the *(REF) B* field to enter the reference value for the secondary parameter using **MEA-SURE** or the numeric entry keys. If the reference values for A and B are entered using **MEA-SURE** in step 2, skip this step.
 - **MEA-SURE**
4. Move the CURSOR to the *DEV A* field. The following softkeys will be displayed.
 - **Δ ABS**
 - **Δ %**
 - **OFF**

5. Select and press a softkey to select the deviation mode for the primary parameter.
6. Move the CURSOR to the *(DEV) B* field. The following softkeys will be displayed.
 - Δ ABS
 - Δ %
 - OFF
7. Press the appropriate softkey to set the deviation mode for the secondary parameter.

SYS MENU Field

The system menu on this page allows you to perform the following control functions.

- Load/Store
- Clear Setup
- Printer
- System Reset

These functions, except for the clear setup function and system reset function, are the same as the functions on the system menu on the *MEAS DISPLAY* page. (The description of each function is given in “SYS MENU Field” in Chapter 4 on page 4-4.) So, in the case of the CLEAR SETUP function and the SYSTEM RESET function, the description and setting procedure are given, while in the case of the other functions, only the procedure is given.

LOAD/STORE Softkeys

Perform the following steps on the *MEAS SETUP* page to store the control settings to the internal non-volatile memory or an external memory card, or to load the control settings from the internal non-volatile memory or an external memory card.

1. Move the CURSOR to the *SYS MENU* field on the *MEAS SETUP* page.
2. If you want to load (store) the data from (to) the memory card, insert a memory card in the memory card slot until it locks into place.
3. Use the numeric entry keys and **ENTER** to enter the record number at which the current control settings will be stored to or loaded from.

CLEAR SETUP Softkey

This softkey allows you to return all of the control settings on the *MEAS SETUP* page to the power-on default settings. The control settings on the other pages are not affected. Figure 5-10 shows the *MEAS SETUP* page after performing the clear setup function.

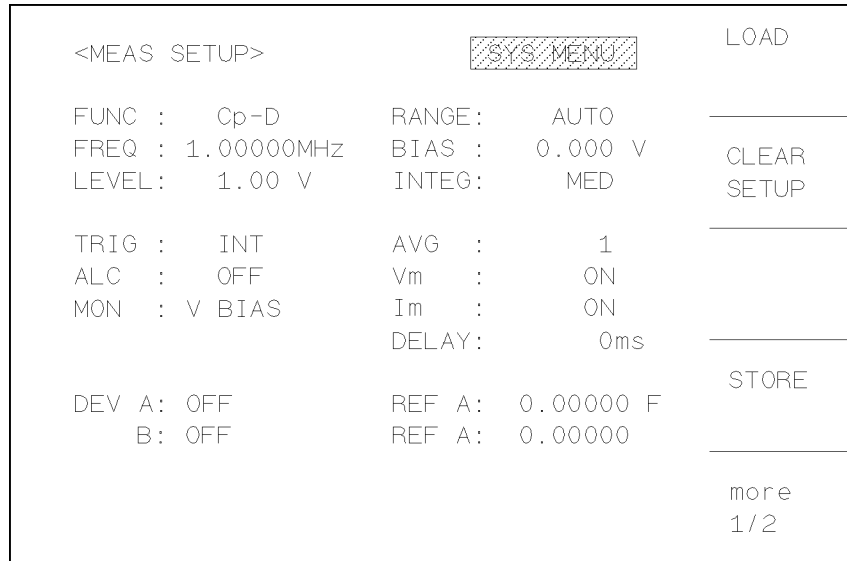

Figure 5-10. MEAS SETUP Page After Clearing the Setup
Resetting the Control Settings on the MEAS SETUP Page

Perform the following steps to reset control settings on the *MEAS SETUP* page to the power-on default settings.

1. Move the CURSOR to the *SYS MENU* field.
2. Press **CLEAR SETUP**. The message *Clearing setup. Are you sure?* will be displayed, and the following softkeys will be displayed.
 - **YES**
 - **NO**
3. Press **YES** to confirm for clearing setup operation.

PRINT DISP Softkey

This softkey is used to print out the instrument control settings on the measurement setup page.

Dumping the MEAS SETUP Page

Perform the following steps to print out the measurement setup page .

1. Connect a printer to the 4285A using an GPIB cable.
2. Set the printer to the Listen-Only mode.
3. On the *SYSTEM CONFIG* page, set the Talk-Only mode to ON .
4. Press **MEAS SETUP** to display the *MEAS SETUP* page.
5. Move the CURSOR to the *SYS MENU* field.
6. Press **more 1/2**.
7. Press **PRINT DISP**. The display page will be printed out by the printer as shown below.

```

<MEAS SETUP>                SYS MENU
FUNC : Cp-D                RANGE: AUTO
FREQ : 10.0000MHz          BIAS : 0.000 V
LEVEL: 1.00 V             INTEG: MED

TRIG : INT                AVG : 1
ALC : OFF                Vm : ON
MON : V BIAS             Im : ON
                        DELAY: 0ms

DEV A: OFF                REF A: 0.00000 F
B: OFF                    B: 0.00000

```

Figure 5-11. MEAS SETUP Page Printout Example

SYSTEM RESET Softkey

This softkey resets all of the 4285A instrument control settings to the power-on default values. For details refer to Appendix C.

Resetting the 4285A

Perform the following steps to execute the SYSTEM RESET function. For details, refer to Appendix C.

1. Move the CURSOR to the *SYS MENU* field on the *MEAS SETUP* page.
2. Press **more 1/2**.
3. Press **SYSTEM RESET**. The message *Resetting system. Are you sure?* will be displayed, and the following softkeys will be displayed.
 - **YES**
 - **NO**
4. Press **YES** to reset the 4285A.

CORRECTION Page

When you press **MEAS SETUP**, and **CORRECTION**, the *CORRECTION* page will be displayed. On this *CORRECTION* page, the OPEN, SHORT, LOAD correction for correcting the stray admittance, the residual impedance, and other error corrections can be performed, and the cable length can be selected. The correction function uses two correction methods. In one method the open and short correction can be performed at all of the frequency points using the interpolation method, and in the other method the open, short, and load correction can be performed at seven frequency points you specify.

The following operations can be performed from this page. (The field in parenthesis is used to set the control function.)

- Printout (*SYS MENU*)
- OPEN Correction (*OPEN*)
- SHORT Correction (*SHORT*)
- LOAD Correction (*LOAD*)
- Cable Length Selection (*CABLE*)
- Multi/Single Correction Mode Selection (*MODE*)
- Measurement Parameter Selection for LOAD Correction (*FUNC*)
- OPEN, SHORT, LOAD Correction for individual 7 frequency points (*FREQ1, FREQ2, . . . , FREQ7*)
- Reference Values for Primary and Secondary Parameters at each of the 7 frequencies for LOAD Correction (*REF A, (REF)B*)

These operations are described in the following paragraphs.

This page also provides the following monitor information (the monitor area looks like a field, but it is not).

- Actual Measurement Values for LOAD Correction
- Channel Number in the MULTI Correction Mode

The actual measurement values for LOAD Correction can be measured from the *FREQ1, FREQ2, . . . , FREQ7* fields on this page, and the channel number can be set via the scanner interface connector or by GPIB.

The available fields and the softkeys which correspond to each field on this page are shown in Figure 5-12 and Figure 5-13.

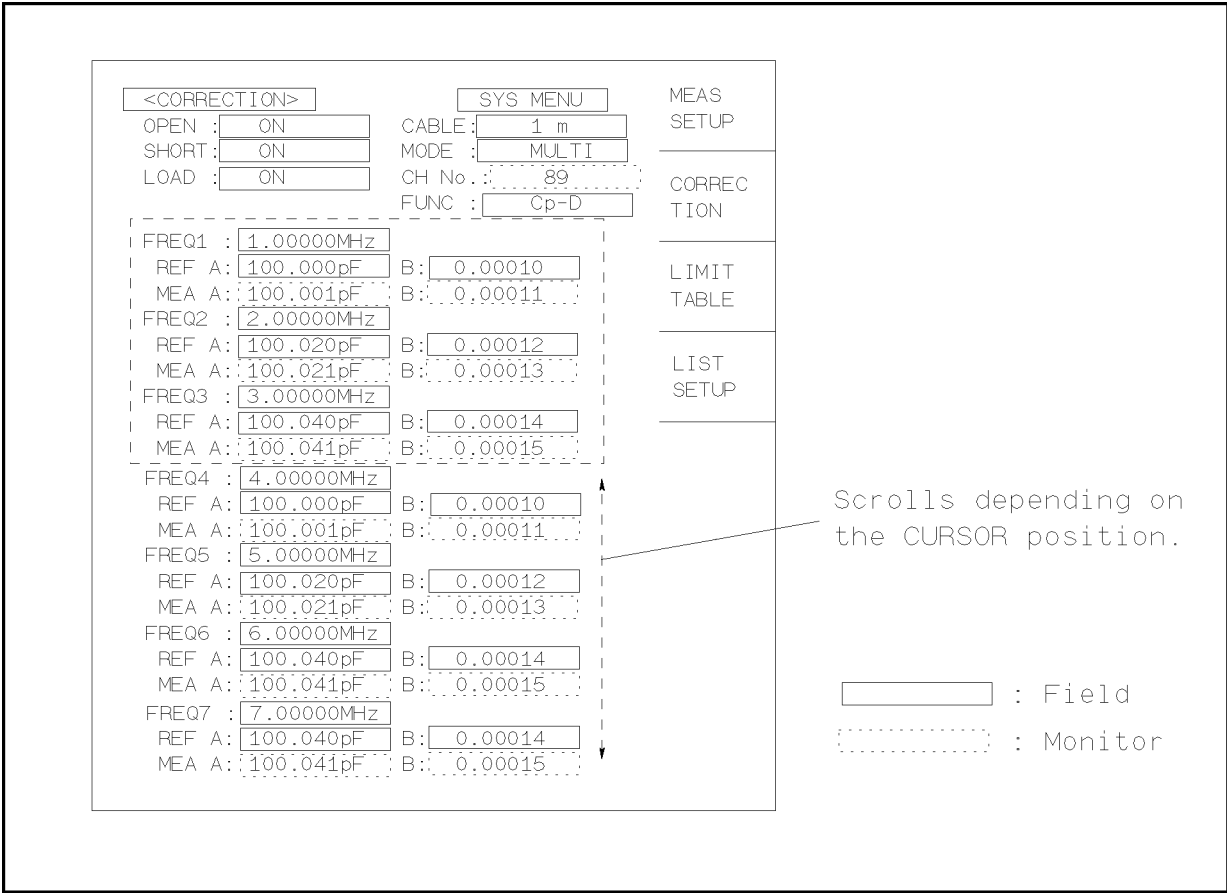
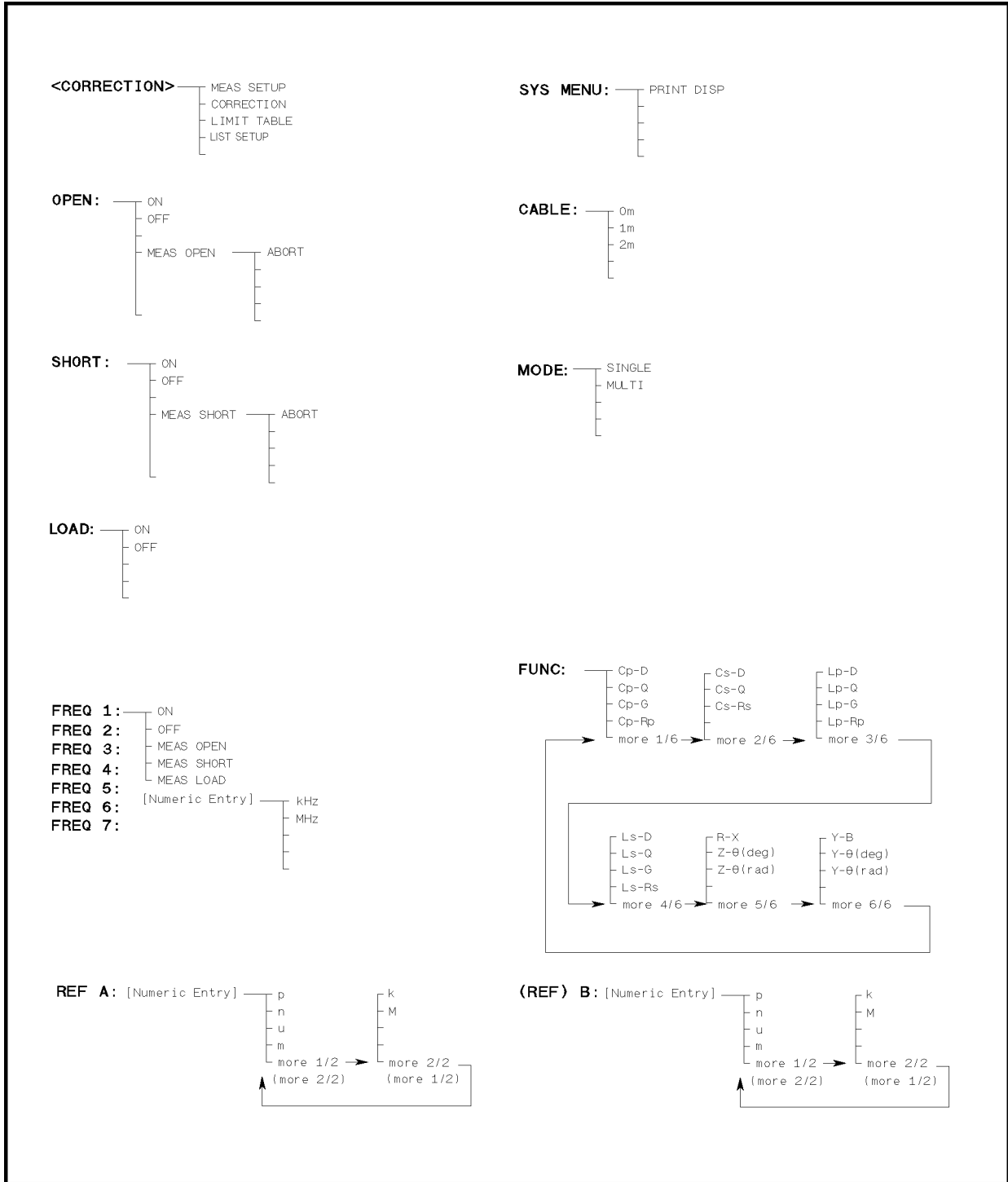

Figure 5-12. Available Fields on the CORRECTION Page



L2005013

Figure 5-13. Available Softkeys on the CORRECTION Page

OPEN Field

The 4285A's OPEN correction capability mathematically cancels out the error due to the stray admittance (G, B) existing between the measurement reference plane (depending on the cable length) and the measuring contact in parallel with the device under test (DUT) as shown in Figure 5-14.

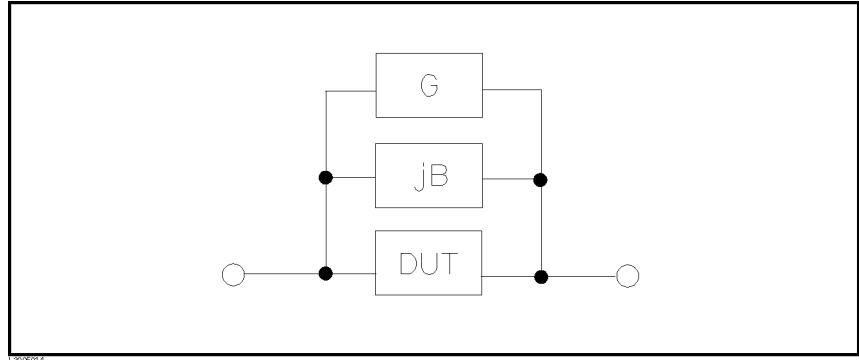

Figure 5-14. Stray Admittance Model

The 4285A provides two types of OPEN correction method, interpolation and spot correction modes.

■ Interpolation correction mode

The OPEN correction data are taken at preset frequency points shown in Table 5-5, and are independent of the test frequency you set. OPEN correction data for each measurement point over the specified frequency points is calculated using the interpolation method (Refer to Figure 5-15).

Table 5-5. Preset Correction Frequency Points

75 kHz	300 kHz	3 MHz	10 MHz	20 MHz
79.6 kHz	350 kHz	3.5 MHz	10.0001 MHz	21 MHz
90 kHz	450 kHz	4 MHz	11 MHz	22 MHz
100 kHz	600 kHz	4.5 MHz	12 MHz	23 MHz
115 kHz	796 kHz	5 MHz	13 MHz	24 MHz
130 kHz	1 MHz	5.0001 MHz	14 MHz	25.2 MHz
160 kHz	1.0001 MHz	6 MHz	15 MHz	26 MHz
200 kHz	1.5 MHz	7 MHz	16 MHz	27 MHz
252 kHz	2.001 MHz	7.96 MHz	17 MHz	28 MHz
	2.52 MHz	9 MHz	18 MHz	29 MHz
			19 MHz	30 MHz

While the OPEN correction data measurement is being performed, the measurement conditions will be changed to the following:

Averaging rate : 4
DC bias : OFF
Integration time : LONG
Measurement range : AUTO

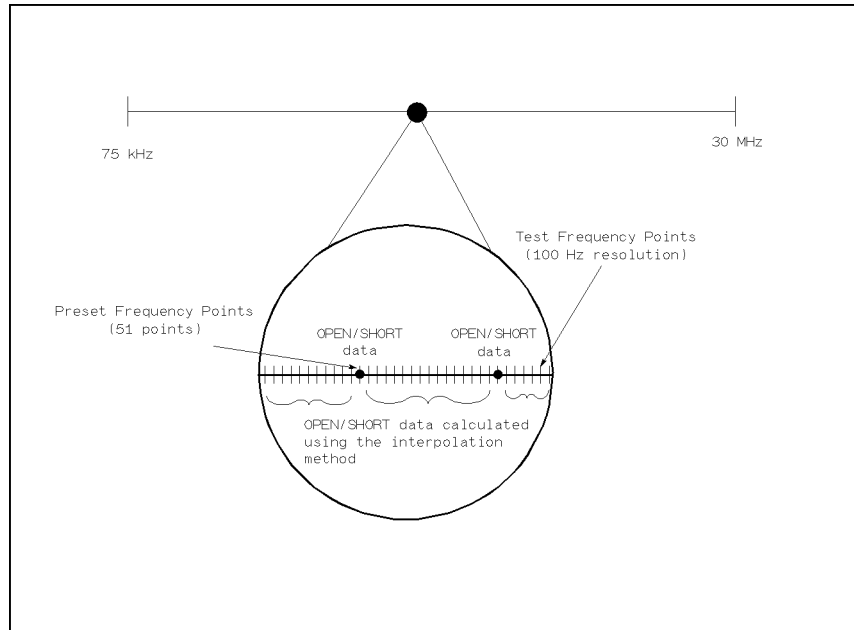

Figure 5-15.
OPEN/SHORT Correction Using The Interpolation Method

■ Spot correction mode

The OPEN correction data taken at the spot frequency points you specify allows you to set up to seven frequency points in the *FREQ1*, *FREQ2*, . . . , *FREQ7* fields. To take the OPEN correction data at the frequency points you specify, **MEAS OPEN** displayed when the CURSOR is moved to the *FREQ1*, *FREQ2*, . . . , *FREQ7* field, is used.

ON Softkey

This softkey enables OPEN correction.

OFF Softkey

This softkey disables OPEN correction.

MEAS OPEN Softkey

This softkey performs OPEN correction data measurements at the preset frequencies. The OPEN correction data measurement will take approximately 45 seconds. The message **OPEN measurement in progress** will be displayed on the system message line while the OPEN correction data measurement is being performed. A number displayed in the most right position of the system message line shows the number of remaining frequency points to be measured for the OPEN correction data.

ABORT Softkey

This softkey is displayed while the OPEN correction data measurement is being performed and is used to stop the OPEN correction data measurement. The previous OPEN correction data is retained.

Performing the OPEN Correction

There are two procedures: OPEN correction using the interpolation method, and OPEN correction at the spot frequency points you specify. Perform the following steps to execute an OPEN correction at all frequency points using the interpolation method. When you want to execute the OPEN correction at the spot frequency point, refer to the spot OPEN/SHORT correction (“Performing the Spot OPEN/SHORT Correction”).

1. Move the CURSOR to the *OPEN* field. The following softkeys will be displayed.
 - **ON**
 - **OFF**
 - **MEAS OPEN**
2. Connect your test fixture to the UNKNOWN terminals without connecting a DUT.
3. Press **MEAS OPEN**. The 4285A will measure the OPEN admittance (conductance and susceptance) at the preset frequency points. During the OPEN correction measurement, the following softkey will be displayed.
 - **ABORT**
4. Press **ON** to perform the OPEN correction calculations on subsequent measurements using the OPEN interpolation correction data.

Note



When the *FREQ1*, *FREQ2*, . . . , *FREQ7* fields are set to ON, and the test frequency is equal to *FREQ1/2/ . . . /7*, spot OPEN correction data at *FREQ1/2/ . . . /7* is preferably used.

5. Press **OFF** not to perform the OPEN correction calculations on subsequent measurements.

SHORT Field

The 4285A's SHORT correction capability mathematically cancels out the error due to the residual impedance (resistance and reactance) existing between the measurement reference plane (depending on the cable length) and the measuring contact in series with the DUT as shown in Figure 5-16.

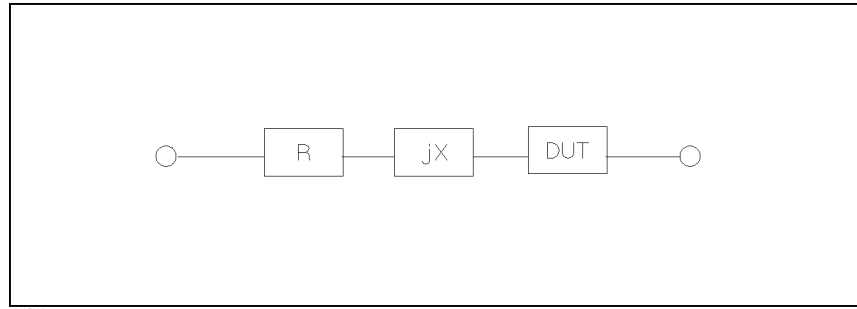

Figure 5-16. Residual Impedance Model

The 4285A uses the following two types of SHORT correction data.

■ Interpolation correction mode

The SHORT correction data are taken at the preset frequency points listed in Table 5-5, and are independent of the test frequency you set. SHORT correction data for each measurement point over the specified frequency points is calculated using the interpolation method (Refer to Figure 5-15). While the SHORT correction data measurement is being performed, the measurement conditions will be changed to the following:

Averaging rate :	4
DC bias :	OFF
Integration time :	LONG
Measurement range :	AUTO

■ Spot correction mode

The SHORT correction data taken at the spot frequency points you specified allows you to set up to seven frequency points in the *FREQ1*, *FREQ2*, . . . , *FREQ7* fields. To take the spot SHORT correction data at the frequency points you specify, **MEAS SHORT** displayed when the CURSOR is moved to the *FREQ1*, *FREQ2*, . . . , *FREQ7* field, is used.

ON Softkey

This softkey enables SHORT correction.

OFF Softkey

This softkey disables SHORT correction.

MEAS SHORT Softkey

This softkey performs SHORT correction data measurements at the preset frequencies. The SHORT correction data measurement will take approximately 50 seconds. And the message **SHORT measurement in progress** will be displayed on the system message line while the SHORT correction data measurement is being performed. A number displayed in the most right position of the system message line shows the remaining number of frequency points to be measured for the SHORT correction data.

Note



Perform the SHORT correction data measurements after setting the test signal level less than or equal $0.5V_{\text{rms}}$. Or, the message **Working Current Limit** will be displayed and the correction data measurement will take additional time.

ABORT Softkey

This softkey is displayed while the SHORT correction data measurement is being performed and is used to stop the short correction data measurement. The previous SHORT correction data is retained.

Performing the SHORT Correction

There are two procedures: SHORT correction at all frequency points, and SHORT correction at user specified frequency points.

Perform the following steps to execute the SHORT correction for all frequency points. When you want to execute the short correction at the user specified frequency points, refer to the “Performing the Spot OPEN/SHORT Correction”.

1. Move the CURSOR to the *SHORT* field. The following softkeys will be displayed.
 - **ON**
 - **OFF**
 - **MEAS SHORT**
2. Connect the test fixture to the UNKNOWN terminals, and short the measurement contacts together.
3. Press **MEAS SHORT**. The 4285A will measure the short impedance (inductance and resistance) at the preset frequency points. During the SHORT correction measurement, the following softkey will be displayed.
 - **ABORT**
4. Press **ON** to perform SHORT correction calculations on subsequent measurements when the *FREQ1*, *FREQ2*, . . . , *FREQ7* fields are set to OFF.

When the *FREQ1*, *FREQ2*, . . . , *FREQ7* fields are set to ON, and the test frequency is equal to *FREQ1/2/ . . . /7*, the SHORT correction data at *FREQ1/2/ . . . /7* is used.

- Press **OFF** to halt SHORT correction calculations on subsequent measurements.

FREQ1–7 Fields

The 4285A's LOAD correction function allows you to correct residual errors after the OPEN/SHORT correction by using the transmission coefficient. The transmission coefficient can be derived from the relationship between a standard's (pre-measured) reference value and the actual measurement value at the frequency points you specify (up to seven frequency points). The 4285A performs the OPEN/SHORT/LOAD corrections at the frequency points you specify (Refer to Figure 5-17). The seven frequency points can be set in the *FREQ1*, *FREQ2*, . . . , *FREQ7* fields.

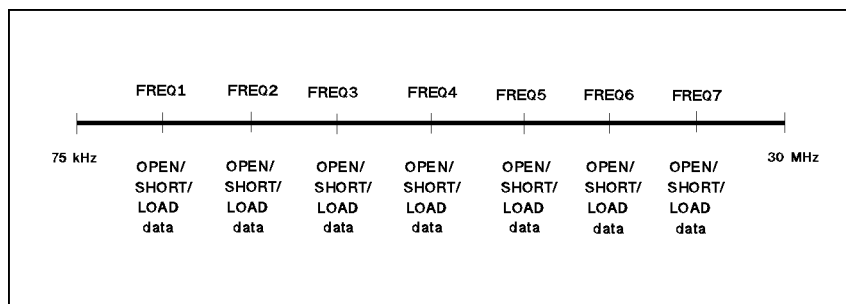

Figure 5-17. Spot OPEN/SHORT/LOAD Correction

ON Softkey

This softkey enables spot OPEN/SHORT/LOAD correction at each specified correction frequency.

OFF Softkey

This softkey disables spot OPEN/SHORT/LOAD correction at each specified correction frequency.

MEAS OPEN Softkey

This softkey performs spot OPEN correction data measurement at the specified spot frequency. The measurement result will be displayed on the system message line. While an OPEN correction data measurement is being performed, the measurement conditions will be changed to the following:

Averaging rate : ≥ 4
 DC bias : OFF
 Integration time : LONG
 Measurement range : AUTO

MEAS SHORT Softkey

This softkey performs spot SHORT correction data measurement at the specified spot frequency. The measurement result will be displayed on the system message line. While the SHORT correction data measurement is being performed, the measurement condition will be changed to the following.

Averaging rate : ≥ 4
DC bias : OFF
Integration time : LONG
Measurement range : AUTO

MEAS LOAD Softkey

This softkey performs LOAD correction data measurement at the specified spot frequency. The measurement result will be displayed on the system message line. While the SHORT correction data measurement is being performed, the measurement condition will be changed to the following:

Averaging rate : ≥ 4
Integration time : LONG

Caution



DO NOT apply a DC bias to the furnished 100 Ω Resistor Box (Agilent Part Number 04285-61001) while making a LOAD correction measurement. Doing so may damage the 100 Ω Resistor Box.

REF A/B Fields

The standard's reference values can be entered in the *REF A*, and (*REF*)*B* fields. *REF A* field is used to set the reference value for the primary parameter, and the (*REF*)*B* field is used to set the reference value for the secondary parameter. Before entering the standard's reference values, the measurement function for the standard must be set on the *FUNC* field in the *CORRECTION* page. The standard's value can be measured using **MEAS LOAD**, displayed on the *FREQ1*, *FREQ2*, . . . , *FREQ7* fields.

Performing the Spot OPEN/SHORT Correction

Perform the following steps to perform the OPEN/SHORT/LOAD correction at the frequency points you specify.

1. Move the CURSOR to the *FREQ1*, *FREQ2*, . . . , *FREQ7* field to specify the frequency for the OPEN/SHORT/LOAD correction. The following softkeys will be displayed.
 - ON
 - OFF
 - MEAS OPEN
 - MEAS SHORT
 - MEAS LOAD
2. Press **ON** to show the previous frequency for the OPEN/SHORT/LOAD correction.
3. Enter the frequency using the numeric entry keys. When pressing one of the numeric entry keys, the softkey labels are changed to the available units (**kHz** and **MHz**), so you can use these softkeys to enter the unit and terminate the entry without hitting **ENTER**. (When **ENTER** is used, the numeric data is entered in Hz.)
4. Connect the test fixture to the UNKNOWN terminals.

—*OPEN correction*—

5. Leave the connection contacts open.
6. Press **MEAS OPEN**. The 4285A performs an OPEN correction measurement at the frequency points you specified. After which, the OPEN correction measurement data are displayed on the system message line.
7. Move the CURSOR to the *OPEN* field.
8. Press **ON** to perform the OPEN correction calculations for subsequent measurements at the specified frequency points.

—*SHORT correction*—

9. Move the CURSOR to the *FREQ1*, *FREQ2*, . . . , *FREQ7* field which you specified.
10. Short the connection contacts together.
11. Press **MEAS SHORT**. The 4285A will perform a SHORT correction measurement, and display the SHORT correction data on the system message line.
12. Move the CURSOR to the *SHORT* field.
13. Press **ON** to perform the SHORT correction calculations for subsequent measurements at the specified frequency points.

Performing the LOAD Correction

1. Prepare the working standard for measurement.
2. Move the CURSOR to the *FUNC* field.
3. Set the measurement function for your standard. (Refer to the next paragraph (Measurement function for the standard.))
4. Move the CURSOR to the *REF A* field of your specified frequency.
5. Enter the pre-measured value of your standard's primary parameter using the numeric entry keys and the unit softkeys.
6. Move the CURSOR to the (*REF*)*B* field, on the right side of your set *REF A* field.
7. Enter your standard's pre-measured secondary parameter value using the numeric entry keys and the unit softkeys.
8. Move the CURSOR to the *FREQ1*, *FREQ2*, . . . , *FREQ7* field which you specified.
9. Connect the standard DUT to the measurement contacts.
10. Press **MEAS LOAD**. The 4285A will perform a LOAD correction measurement, and display the LOAD correction data on the system message line.
11. Move the CURSOR to the *LOAD* field.
12. Press **ON** to enable the LOAD correction calculations for subsequent measurements at the specified frequency points.

Note



The relationship between the *CORRECTION* page and OPEN/SHORT/LOAD correction function are as follows.

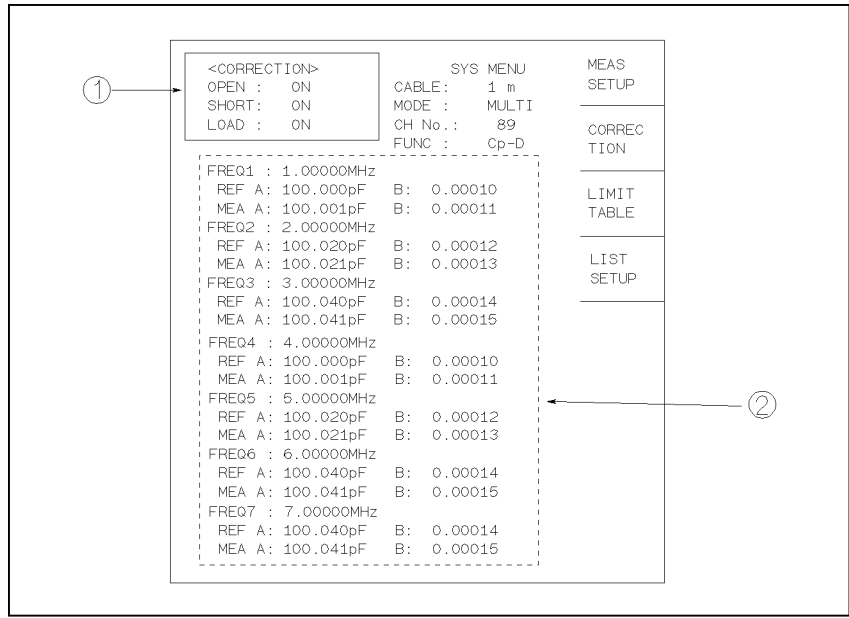

① This area is used as follows.

- To perform the OPEN/SHORT/LOAD correction calculations using either the OPEN/SHORT interpolation correction data or the OPEN/SHORT/LOAD correction data at the spot frequency you specify. This correction data selection depends on the test frequency.
- To obtain the OPEN/SHORT interpolation correction data.

② This area is used as follows.

- To obtain the OPEN/SHORT/LOAD correction data at the spot frequencies you specify (FREQ1, FREQ2, . . . , FREQ7).
- To make the OPEN/SHORT/LOAD correction data at the spot frequencies you specify (FREQ1, FREQ2, . . . , FREQ7) valid or invalid.

The correction data used depends on the test frequency as follows.

Correction Mode	Test Frequency \neq FREQ1-7		Test Frequency = FREQ1-7	
	FREQ1-7 OFF	FREQ1-7 ON	FREQ1-7 OFF	FREQ1-7 ON
OPEN: ON	INTPOL	INTPOL	INTPOL	SPOT
SHORT: ON	INTPOL	INTPOL	INTPOL	SPOT
LOAD: ON	×	×	×	SPOT

Where,

- SPOT: The correction data for the frequency points you specified is used.
- INTPOL: Interpolation correction data is used.
- ×: Correction isn't performed even if the correction function is set to ON in the *OPEN*, *SHORT*, or *LOAD* fields.

When the specified frequency is equal to another spot frequency, the correction data is used in the following manner.

- Test Frequency = $FREQ1 = FREQ2$
Correction data: Data at $FREQ1$
 - Test Frequency = $FREQ2 = FREQ3 = \dots = FREQ7$
Correction data: Data at $FREQ2$
 - Test Frequency = $FREQ1 = FREQ2 = \dots = FREQ7$
Correction data: Data at $FREQ1$
-

FUNC Field

To perform the *LOAD* correction, the reference (pre-measured) value of the standard DUT must be entered. The measurement function for the standard DUT and measured reference value (*MEAS A/B* monitor value) is set in the *FUNC* field. In the *FUNC* field, the following measurement functions are available for the reference value.

C_p -D	L_p -D	R-X
C_p -Q	L_p -Q	Z- θ (deg)
C_p -G	L_p -G	Z- θ (rad)
C_p - R_p	L_p - R_p	G-B
C_s -D	L_s -D	Y- θ (deg)
C_s -Q	L_s -Q	Y- θ (rad)
C_s - R_s	L_s - R_s	

The *LOAD* correction corrects the errors using the transmission coefficient derived from the relationship between the standard's reference value and the actual raw measurement value. The *LOAD* function is used only for calculating the transmission coefficient.

Setting the Measurement Function of the Standard's DUT

Perform the following steps to set the measurement function for the standard DUT.

1. Move the *CURSOR* to the *FUNC* field using the *CURSOR* keys.
2. Press **more X/6** until the softkey labels are changed to the function you are looking for. Figure 5-18 shows the display order of the measurement function.

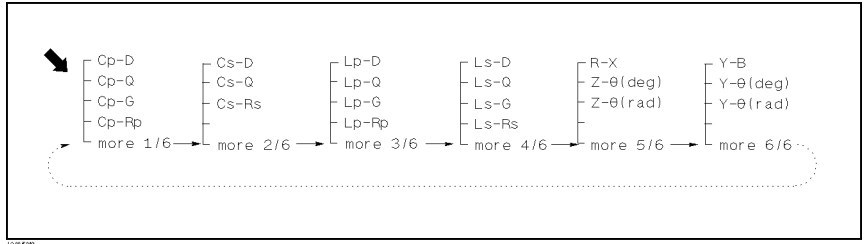

Figure 5-18. Display Order of the Measurement Function

3. Press the appropriate softkey.

MODE Field There are two correction modes. The *MODE* field switches between these correction modes. When the 4285A is not equipped with Option 301, only SINGLE mode is available. When Option 301 (Scanner Interface) is installed and turned on in the *SYSTEM CONFIG* page, two correction modes, MULTI correction and SINGLE correction modes, are available.

SINGLE Softkey

Set the correction mode to SINGLE. In this mode, two correction methods, interpolated (preset 51 frequency points) OPEN/SHORT correction and spot OPEN/SHORT/LOAD correction (up-to 7 frequency points), can be used.

MULTI Softkey

Set the correction mode to MULTI. In this mode, only spot OPEN/SHORT/LOAD correction (up to 7 points) can be used and 90 sets (90 channel) of spot OPEN/SHORT/LOAD correction data, displayed on *MEA A/B* monitor area on each spot frequency, are switched.

When the 4285A is combined with a scanner, this multi-channel error correction capability reduces the measurement error due to the difference of scanner channel path by performing spot OPEN/SHORT/LOAD correction for each channel.

Note



When the MULTI correction mode is selected, an OPEN/SHORT correction using the interpolation method cannot be performed. (Only the OPEN/SHORT/LOAD correction at the seven frequencies you specify can be performed.)

Note



Depending on the correction mode, (SINGLE or MULTI), correction data for *FREQ1*, *FREQ2*, . . . , *FREQ7* are stored in different memory areas.

The *MODE* field allows you to select the SINGLE or MULTI correction mode. For more information about the MULTI correction mode, refer to Section 3, *Option 301. Scanner Interface Operation Manual*.

In the case of the MULTI correction mode, the channel number for selecting the correction data is displayed on the *CH No.* monitor area.

Note



SCANNER I/F (#301) field under the *SYSTEM CONFIG* page must be set to ON for setting the correction mode to MULTI, even if the interface connector on the rear panel is not used. For example, in the case of controlling a scanner and the 4285A via GPIB, you must set this field ON to use the multi-channel correction.

Setting the Correction Mode

1. Press **CATALOG/SYSTEM** and **SYSTEM CONFIG** to display the *SYSTEM CONFIG* page.
2. Move the CURSOR to the *SCANNER I/F (#301)* field.

3. Press **ON** to enable the scanner interface function.
4. Press **MEAS SETUP** and **CORRECTION** to return to the *CORRECTION* page.
5. Move the **CURSOR** to the *MODE* field. The following softkeys will be displayed.
 - **SINGLE**
 - **MULTI**
6. Press **MULTI** to select the **MULTI** correction mode. If you want to set the **SINGLE** correction mode, press **SINGLE**.

CABLE Field

The 4285A can have three reference planes—at the *UNKNOWN* terminals (0m), at the end of the 16048A test leads (1m), and at the end of the 16048D test leads (2m). These reference planes are selectable in the *CABLE* field. Measurement accuracy of the 4285A is specified at these planes. In the high current DC biased measurement mode (**I BIAS**), *CABLE* field is fixed to **1 m** and no other reference planes can't be selected.

To achieve the four-terminal pair configuration, four outer conductors of the H_{POT} , H_{CUR} , L_{POT} , and L_{CUR} test leads must be shorted at the end of the test leads (DUT side). For details of the measurement cables termination, refer to “Measurement Cable Termination” in Chapter 7.

Note



When you use the 16048A or 16048D with the 4285A, cable correction described in “Performing the Cable Correction Data Measurement” in Chapter 6 must be performed. Otherwise, the measurement error at the high frequencies increases.

Note



It is not recommended to use the extension cable other than the 16048A and 16048D. Using other types or different length of cables may increase the measurement error.

0 m Softkey

This softkey selects the 0 m cable length. The reference plane is from the front of the instrument. The 0 m cable length is used for direct attachment test fixtures, such as the 16034E or the 16047A/C/D.

1 m Softkey

This softkey selects the 1 m cable length for use with the 16048A test leads. The reference plane is placed at the end of the 16048A test leads. Also, the 1 m cable length is used for the fixtures with cable, for example the 16334A or the 16451B.

2 m Softkey

This softkey selects the 2 m cable length for use with the 16048D test leads. The reference plane is placed at the end of the 16048D test leads.

Selecting the Cable Length

Perform the following steps to select the cable length.

1. Move the CURSOR to the *CABLE* field. The following softkeys will be displayed.

- 0 m
- 1 m
- 2 m

2. Select and press a softkey to select the cable length.

SYS MENU Field

The system menu on this page allows you to perform the following control functions.

■ Printer

This function is the same as the functions on the system menu on the *MEAS DISPLAY* page. (A description of this function is given on “SYS MENU Field” in Chapter 4 on page 4-4.) So only the procedure is given in the following paragraphs.

PRINT DISP Softkey

This softkey is used to print the current correction page setup.

Printing the CORRECTION Page Setup

Perform the following steps to print out the information of the *CORRECTION* page using the PRINT DISP mode.

1. Connect the 4285A to the printer using an GPIB cable.
2. Set the printer to the Listen-Only mode.
3. Set the Talk-Only mode to ON from the *SYSTEM CONFIG* page.
4. Press **MEAS SETUP**, and **CORRECTION** to display the *CORRECTION* page.
5. Move the CURSOR to the *SYS MENU* field.
6. Press **PRINT DISP** to print out the display page. LCD screen freezes for a moment and the displayed page is printed out to the printer as shown in Figure 5-19.

```

<CORRECTION>                SYS MENU
OPEN : ON                    CABLE : 0 m
SHORT: ON                     MODE  : SINGLE
LOAD : OFF                    CH No.: ---
                                FUNC  : Cp-D

FREQ1 : 1.0000MHz
REF A: 418.000pF             B: .020000
MEA A: 418.799pF            B: .033345
FREQ2 : 10.0000MHz
REF A: 9.90000pF            B: .000310
MEA A: 9.85929pF           B: .000324
FREQ3 : OFF
REF A: -----              B: -----
MEA A: -----              B: -----
FREQ4 : OFF
REF A: -----              B: -----
MEA A: -----              B: -----
FREQ5 : OFF
REF A: -----              B: -----
MEA A: -----              B: -----
FREQ6 : OFF
REF A: -----              B: -----
MEA A: -----              B: -----
FREQ7 : OFF
REF A: -----              B: -----
MEA A: -----              B: -----

```

Figure 5-19. CORRECTION Page Print Example

LIMIT TABLE SETUP Page

This page will be displayed by pressing **(MEAS SETUP)** and **LIMIT TABLE**. This page allows you to set the 4285A's built-in comparator function. The built-in comparator can sort devices into a maximum of ten bins (BIN 1 to BIN 9 and one OUT OF BINS bin) using a maximum of nine pairs of primary limits and one pair of secondary parameter limits. Also, the DUTs whose primary parameter is within limits, but whose secondary parameter measurement result not within limits, can be sorted into an AUXiliary BIN. This comparator function is especially useful when using the 4285A with a component handler (when the handler interface option is installed and turned on in the *SYSTEM CONFIG* page). The limit settings for bin sorting are only one set on this *LIMIT TABLE SETUP* page.

- LOAD/STORE (*SYS MENU*)
- Printout (*SYS MENU*)
- Clear Table (*SYS MENU*)
- Swap parameter function (*FUNC*)
- Comparator function's limit mode (*MODE*)
- Nominal value for tolerance mode (*NOMINAL*)
- Auxiliary bin ON/OFF (*AUX*)
- Comparator function ON/OFF (*COMP*)
- Low limit value of each bin (*LOW*)
- High limit value of each bin (*HIGH*)

The function of each field is described in the following paragraphs. The available fields and the softkeys which correspond to the fields on this page are shown in Figure 5-20 and Figure 5-21.

<input type="text" value="<LIMIT TABLE SETUP>"/>		<input type="text" value="SYS MENU"/>	MEAS SETUP
FUNC :	<input type="text" value="Cp-D"/>	NOM :	<input type="text" value="100.000 pF"/>
MODE :	<input type="text" value="%"/>	AUX:	<input type="text" value="OFF"/>
		COMP:	<input type="text" value="ON"/>
BIN	LOW	HIGH	CORREC TION
1	<input type="text" value="- 0.010 %"/>	<input type="text" value="+ 0.010 %"/>	LIMIT TABLE
2	<input type="text" value="- 0.020 %"/>	<input type="text" value="+ 0.020 %"/>	
3	<input type="text" value="- 0.030 %"/>	<input type="text" value="+ 0.030 %"/>	LIST SETUP
4	<input type="text" value="- 0.040 %"/>	<input type="text" value="+ 0.040 %"/>	
5	<input type="text" value="- 0.050 %"/>	<input type="text" value="+ 0.050 %"/>	
6	<input type="text" value="- 0.060 %"/>	<input type="text" value="+ 0.060 %"/>	
7	<input type="text" value="- 0.070 %"/>	<input type="text" value="+ 0.070 %"/>	
8	<input type="text" value="- 0.080 %"/>	<input type="text" value="+ 0.080 %"/>	
9	<input type="text" value="- 0.090 %"/>	<input type="text" value="+ 0.090 %"/>	
2nd	<input type="text" value="+.000000"/>	<input type="text" value="+ .000005"/>	

: Field

L2005020

Figure 5-20. Available Fields on the LIMIT TABLE SETUP Page

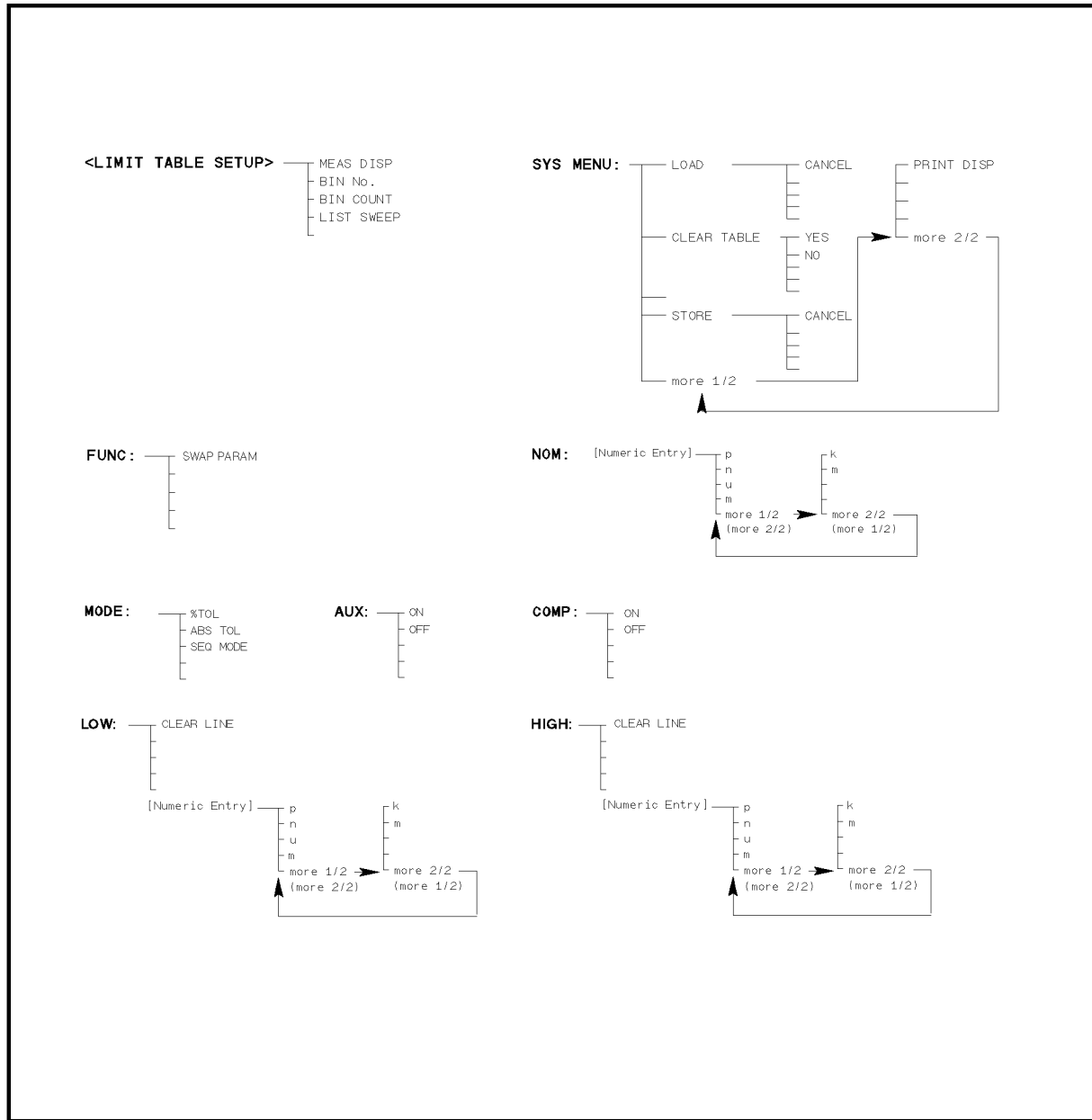

L2005021

Figure 5-21. Available Softkeys on the LIMIT TABLE SETUP Page

FUNC Field This field shows the currently selected primary and secondary parameters. The parameter combinations displayed in this field can be changed in the *FUNC* field on the *MEAS DISPLAY* page or the *MEAS SETUP* page.

SWAP PARAM Softkey

This softkey swaps the primary parameter and the secondary parameters. For example, when the measurement function is C_p -D, the swap parameter function sets the measurement function to D- C_p . (Refer to Figure 5-22.) In the D- C_p mode, comparison limits for D

can be set to a maximum of nine pairs of comparison limits, and the comparison limits for C_p can be set to one pair.

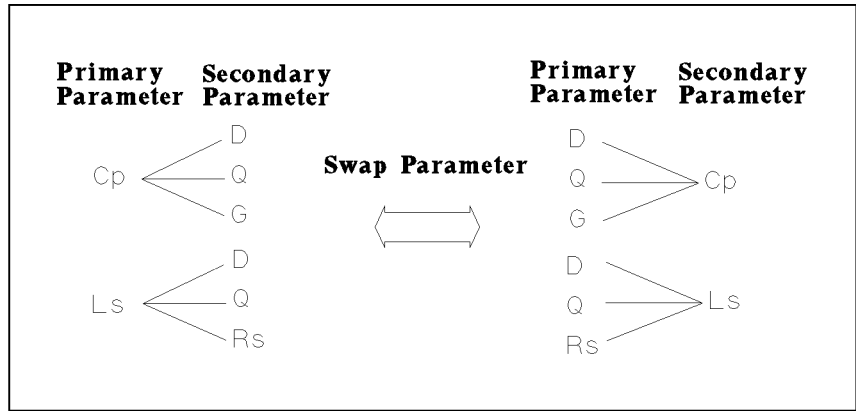

Figure 5-22. Swap Parameter Function

Swapping the Primary and Secondary Parameters

Perform the following steps to swap the primary and secondary parameters.

1. Move the CURSOR to the *FUNC* field. The following softkey will be displayed.
 - **SWAP PARAM**
2. Press **SWAP PARAM** to swap the primary and secondary parameter combinations of the measurement function.
3. Press **SWAP PARAM** again to return the measurement function to the previous combination.

MODE Field

The 4285A uses two methods for specifying primary parameter limits, as shown in Figure 5-23.

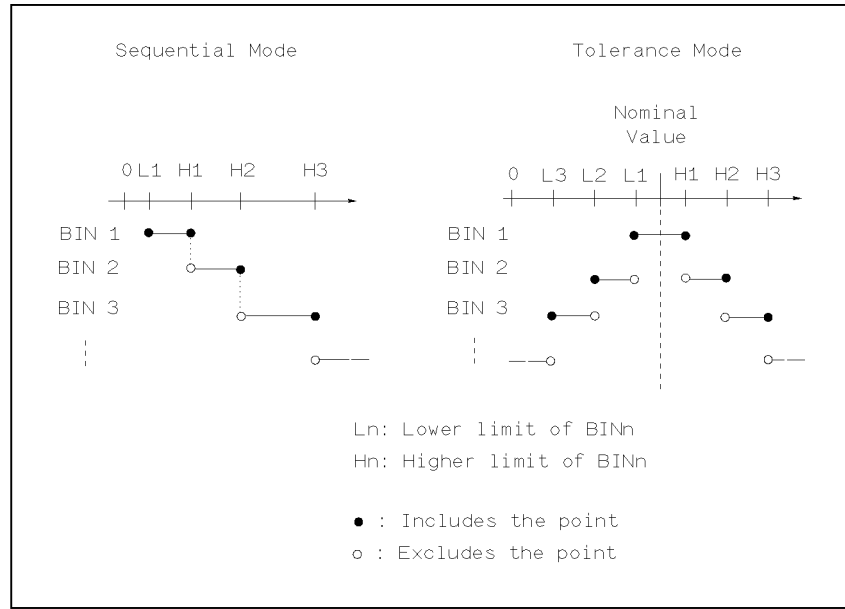

Figure 5-23. Tolerance Mode and Sequential Mode

■ Tolerance Mode

The tolerance mode specifies comparison limits by the deviation from a specified nominal value. The nominal value is specified in *NOM* field. Generally, in this mode, symmetrical nested limits are used as shown in Figure 5-23. The HIGH limit value must be higher than the LOW limit value. If not, the warning message *Warning, Improper high/low limits*, (this isn't an error, only a warning), will be displayed, and the 4285A will not sort the DUTs into the specified BINs. And the lower numbered bins must be narrower than the higher numbered ones. If BIN 1 has the widest limits, all of the DUTs will be sorted into BIN 1, and neither the error message nor the warning message will be displayed.

In the tolerance mode, unsymmetrical unnested limits are also possible. If it is necessary to define bins with overlaps or gaps between limits, set the unsymmetrical unnested limit values as shown in Figure 5-24.

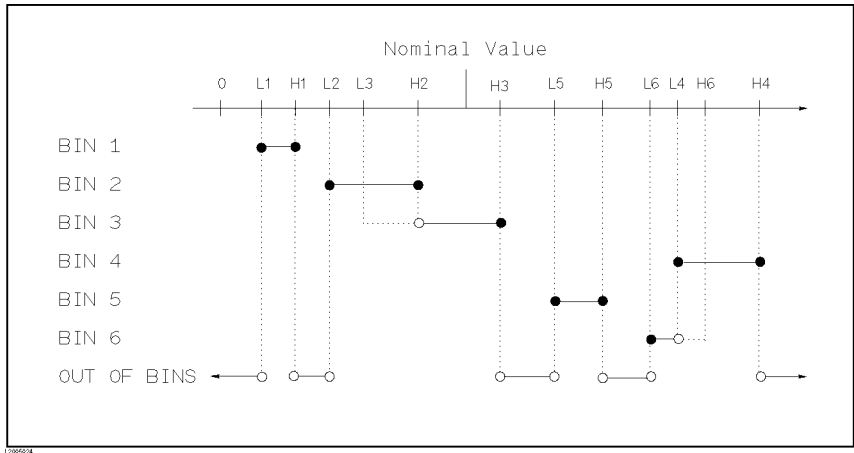

Figure 5-24. Tolerance Limit with Overlaps and Gaps

There are two methods to specify tolerance mode limits, the ratio in percent and by absolute parameter value.

■ Sequential Mode

The sequential mode specifies comparison limits as the absolute measurement value. The limits must be set in order from the smallest value to the largest value. If not, the warning message *Warning, Improper high/low limits*, (this isn't an error, only a warning), will be displayed, and the 4285A will not sort the DUTs into the specified BINS.

The limit values for sequential mode sorting can be set without setting the lower/higher limits of BIN1. For example,

- BIN 1: Low Limit (L1) only
- BIN 2: High Limit (H2)
- BIN 3: High Limit (H3)

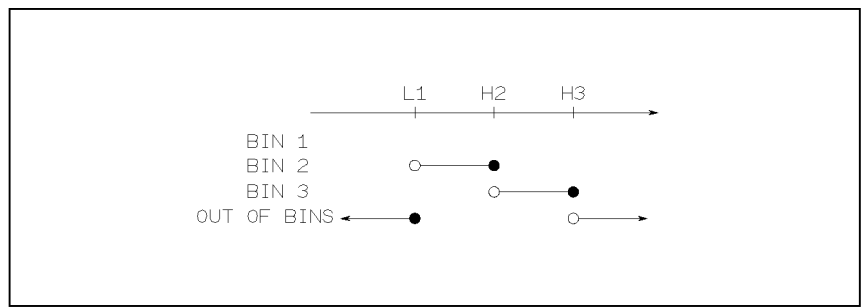

- BIN 1: High Limit (H1) only
- BIN 2: High Limit (H2)
- BIN 3: High Limit (H3)

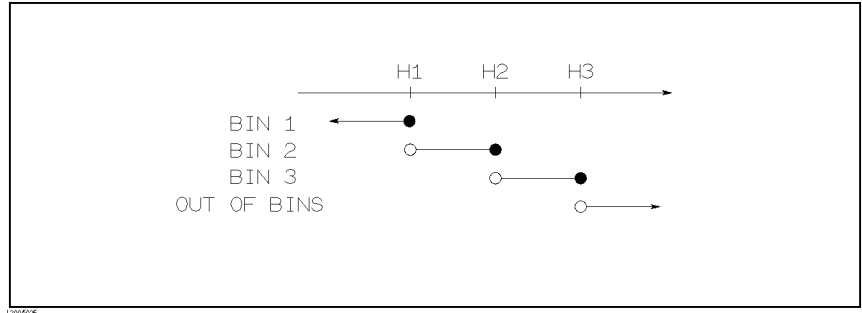

- BIN 2: High Limit (H2)
- BIN 3: High Limit (H3)

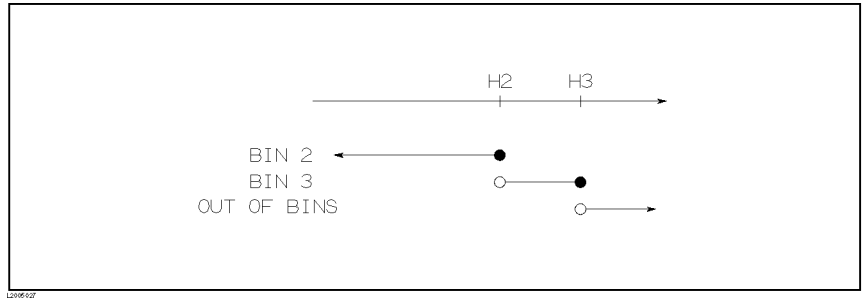

% TOL Softkey

This softkey sets the limit mode to the tolerance mode (ratio in percent).

ABS TOL Softkey

This softkey sets the limit mode to the tolerance mode (parameter value).

SEQ Softkey

This softkey sets the limit mode to sequential.

Setting the Comparator Limit Mode

Perform the following steps to set the limit mode for the comparator.

1. Move the CURSOR to the *MODE* field. The following softkeys will be displayed.

- % TOL
- ABS TOL
- SEQ

2. Select the appropriate limit mode using the softkeys.

NOM Field When the tolerance mode is used as the limit mode for the primary parameter, a nominal value must be specified. The nominal value can be set within the range of the following measurement range of the primary parameter.

Primary Parameter and Display Range

Parameter	Range
Z , R, X	0.00001 Ω to 99.9999 M Ω
Y , G, B	0.00001 μ S to 99.9999 S
C	0.00001 pF to 999.999 μ F
L	0.001 nH to 99.9999 H
D	0.000001 to 9.99999
Q	0.01 to 99999.9
θ	-180° to 180°

When the limit mode for the primary parameter is sequential mode, nominal value can be set, but this has no meaning in the sequential mode.

Setting the Nominal Value

Perform the following steps to set the nominal value.

1. Move the CURSOR to the *NOM* field.
2. Enter the nominal value using the numeric entry keys. When the numeric data is entered, the suffix softkeys (**p**, **n**, **μ** , **m**, **k**, and **M**) can be used instead of **ENTER**.

COMP Field The 4285A's built-in comparator can sort DUTs into a maximum of ten bins (BIN 1 to BIN 9 and the OUT OF BINS bin) using a maximum of nine pairs of primary parameter limits and one pair of secondary parameter limits. Also, a DUT whose primary parameter is within limits, but whose secondary parameter measurement result is not within limits can be sorted into the AUXiliary BIN. The comparator function is especially useful when using the 4285A with a component handler (handler interface option is installed).

ON Softkey

This softkey turns the built-in comparator function on. Comparison takes approximately 1 ms.

OFF Softkey

This softkey turns the built-in comparator function OFF.

Turning the Comparator Function to ON or OFF

Perform the following steps to set the comparator function to ON or OFF.

1. Move the CURSOR to the *COMP* field. The following softkeys will be displayed.

- ON
- OFF

2. Press appropriate softkey to set the comparator function to ON or OFF.

LOW/HIGH Fields

The 4285A's built-in comparator can sort DUTs into a maximum of ten bins (BIN 1 to BIN 9, and OUT OF BINS) using a maximum of nine pairs of primary parameter limits and one pair of secondary parameter limits. These primary parameter low/high limits can be set in the *BIN 1* to *BIN 9 LOW/HIGH* fields.

CLEAR LINE Softkey

This softkey clears a pair of LOW/HIGH limit fields where the CURSOR resides.

Entering the LOW/HIGH Limits

Perform the following steps to enter the bin sorting limits.

1. Set the measurement function for the comparator function in the *DISPLAY FORMAT* or *MEAS SETUP* pages.
2. Press **MEAS SETUP** and **LIMIT TABLE** to display the *LIMIT TABLE SETUP* page.
3. Move the CURSOR to the *SYS MENU* field, and press **CLEAR TABLE** and **YES** to perform the clear table function.
4. Move the CURSOR to the *MODE* field, and select the limit mode for the primary parameter.
5. When you choose the tolerance mode in the *MODE* field in the step 3, move the CURSOR to the *NOM* field, and set the nominal value.
6. Move the CURSOR to the *BIN 1 LOW* field. When you use the tolerance mode, perform step 6 . When you use the sequential mode, perform step 7.
7. —*In the Tolerance Mode*—
 - a. Enter the limit value of the BIN 1 at *BIN 1 LOW* field using the numeric entry keys. When one of the numeric entry keys is pressed, the suffix softkeys (**p**, **n**, **μ**, **m**, **k**, and **M**) will be displayed, and you can use these softkeys to enter the unit and to terminate the entry instead of using **ENTER**. When the limit value of BIN 1 is entered in the *BIN 1 LOW* field, the BIN 1 low limit becomes – (absolute input value), and the BIN 1 high limit becomes + (absolute input value).
 - b. The CURSOR will be automatically moved to the *BIN 2 LOW* field. Repeat step (a.) until the limits of the BIN 9 are entered. After that, the CURSOR will be moved to the *2nd LOW* field.
 - c. Enter the low limit value of the secondary parameter. After that, the CURSOR will move automatically to the *2nd HIGH* field.

- d. Enter the high limit value of the secondary parameter. Then the entry example using the tolerance mode is shown in Figure 5-20.
8. —*In the Sequential Mode*—
- Enter the low limit of the BIN 1 using the numeric entry keys. When the one of the numeric entry keys is pressed, the suffix softkeys (p, n, μ , m, k, and M) will be displayed, so you can use these softkeys to enter the unit and terminate the entry instead of using **ENTER**.
 - The CURSOR will be automatically moved to the *BIN 1 HIGH* field after entering the low limit of the BIN 1. Enter the high limit of the BIN 1.
 - The CURSOR will be automatically moved to the *BIN 2 HIGH* field. Because the BIN 2 low limit value is as same as the BIN 1 high limit value. Enter the high limit of the BIN 2.
 - Repeat step c until the BIN 9 limits are entered. After entering the BIN 9 high limit, the CURSOR will move automatically to the *2nd LOW* field. Enter the low limit value of the secondary parameter.
 - The CURSOR will be automatically moved to the *2nd HIGH* field. Enter the high limit value of the secondary parameter. The entry example using the sequential mode is shown below.

<LIMIT TABLE SETUP>		SYS MENU	MEAS SETUP
FUNC :	Cp-D	NOM : 100.000 pF	
MODE :	SEQ AUX: ON	COMP: ON	
BIN	LOW	HIGH	CORREC TION
1	+100.000pF	+110.000pF	
2		+120.000pF	
3		+130.000pF	LIMIT TABLE
4		+140.000pF	
5		+150.000pF	
6		+160.000pF	LIST SETUP
7		+170.000pF	
8		+180.000pF	
9		+190.000pF	
2nd	+ 0.000	+ 0.005	

Figure 5-25. Limit Table Using the Sequential Mode

2nd LOW/HIGH Fields

The 4285A's built-in comparator allows sorting DUTs by the secondary parameter into three bins; low, in, and high. These 2nd LOW/HIGH limits can be set in the *2nd LOW/HIGH* fields

- When the secondary parameter limits are not specified on the *LIMIT TABLE SETUP* page.

The DUTs will be sorted according to the primary parameter comparison results as shown below.

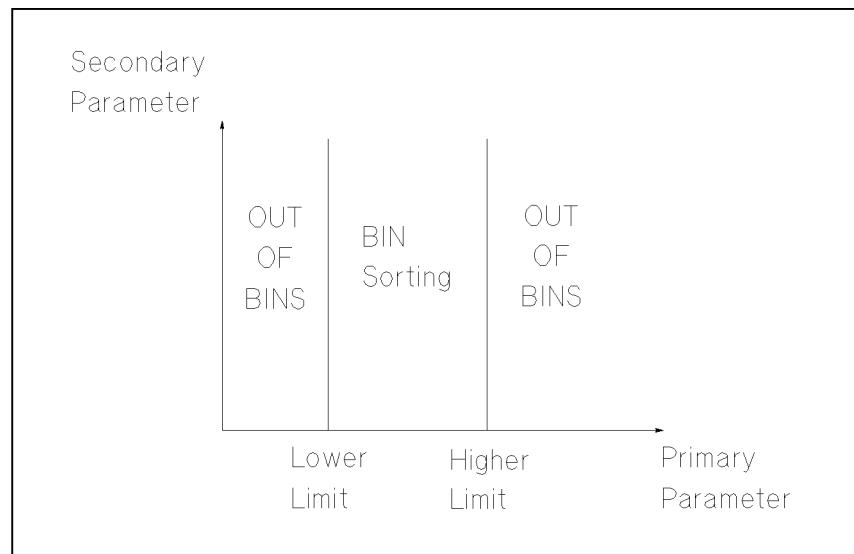

- When the secondary parameter limits are specified.

DUTs with secondary limits are sorted by the primary parameter result. DUTs not within the secondary parameter limits are sorted OUT OF BINS even if the device's primary parameter is within limits.

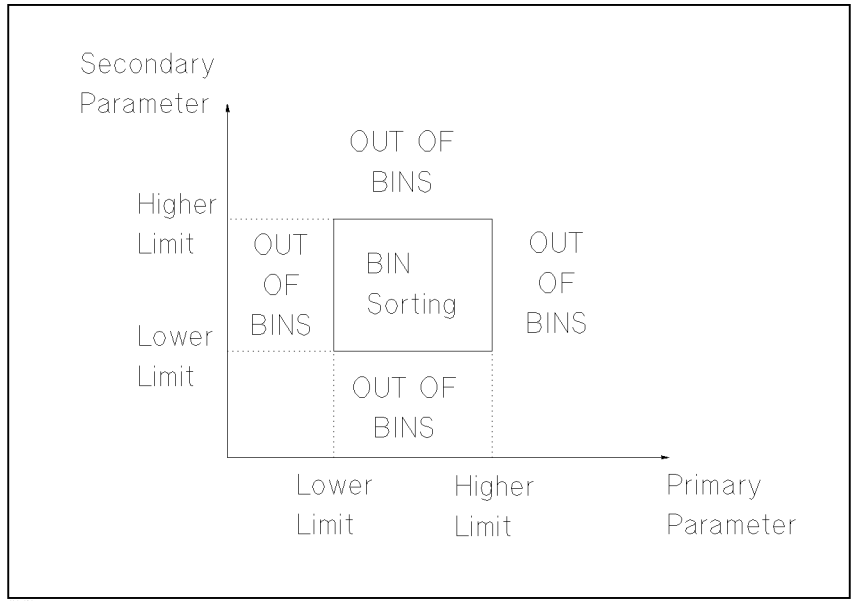

AUX Field The 4285A's sorts DUTs which fail the secondary parameter separately from the OUT OF BINS DUTs, they are sorted into the AUX BIN. The AUX field allows you to set the AUXiliary bin to ON or OFF. The AUXiliary bin is available only when 2nd LOW/HIGH limits are specified.

- When the secondary parameter limits are set and AUX BIN are set to ON.

The DUTs whose primary parameter is not within limits are sorted OUT OF BINS. DUTs whose primary parameter is within limits, but whose secondary parameter is out of limits are sorted into the AUX BIN.

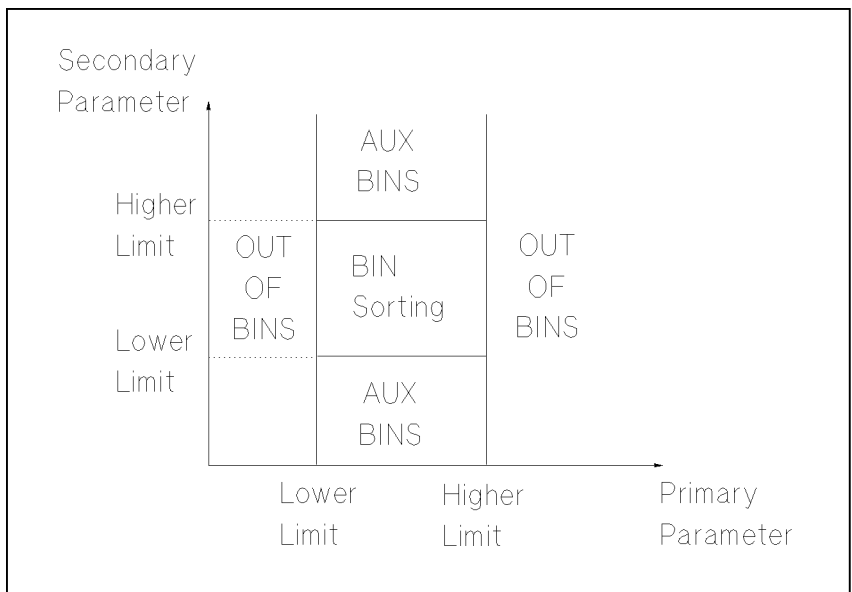

Note



When only the lower limit of the secondary parameter is set and the AUX BIN are set to ON, the DUTs whose primary parameter is within limits, but whose secondary parameter is equal to or below the lower limit are sorted into the AUX BIN. Also when only the higher limit of the secondary parameter is set and the AUX BIN are set to ON, the DUTs whose primary parameter is within limits, but whose secondary parameter is equal to or above the higher limit are sorted into the AUX BIN. (See below.)

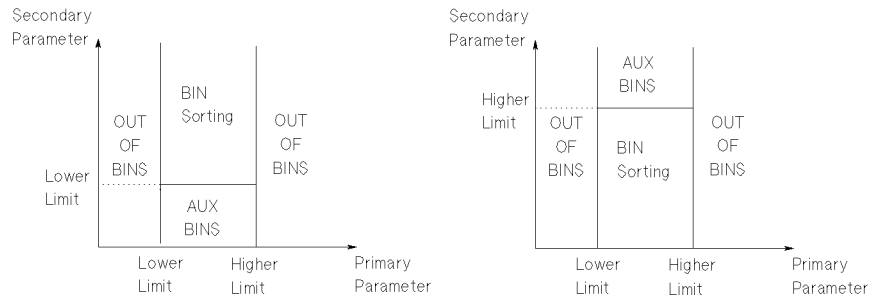

Setting the AUX BIN to ON or OFF

Perform the following steps to set the AUX BIN to ON or OFF.

1. Move the CURSOR to the *AUX* field. The following softkeys will be displayed.
 - ON
 - OFF
2. Press either softkey to set AUX BIN to ON or OFF.

SYS MENU Field

The system menu on this page allows you to perform the following control functions.

- Load/Store
- Clear table
- Printer

These functions, except for the clear table function, are the same as the functions on the system menu on the *MEAS DISPLAY* page. (A description of each function is given in “SYS MENU Field” in Chapter 4 on page 4-4.) So, in the case of the clear table function, the description and procedure are given, and in the case of the other functions, only the procedure is given.

Loading or Storing the Control Settings

Perform the following steps on the *LIMIT TABLE SETUP* page to LOAD/STORE the control settings to the internal non-volatile memory or to the external memory card.

1. Set all controls.

2. Move the CURSOR to the *SYS MENU* field on the *LIMIT TABLE SETUP* page.
3. Insert the memory card to the MEMORY card slot, if you are using the memory card.
4. Press **STORE** when you want to use the STORE function. The message Enter record number to STORE will be displayed on the system message line.

Press **LOAD** when you want to use the LOAD function. The message Enter record number to LOAD will be displayed on the system message line.
5. Enter the record number using the numeric entry keys and press **ENTER** to STORE the current control settings, or LOAD the control settings.

CANCEL Softkey

This softkey cancels the current LOAD/STORE operation.

CLEAR TABLE Softkey

This function allows you to clear the all limit values. So, when you change the limit mode, use this function.

Clearing the Limit Table

Perform the following steps to clear all of bin sorting limits on the *LIMIT TABLE SETUP* page.

1. Move the CURSOR to the *SYS MENU* field.
2. Press **CLEAR TABLE**. The message Clearing table, Are you sure? will be displayed on the system message line, and the following softkeys will be displayed.
 - **YES**
 - **NO**
3. Press **YES** to confirm the limit table clear operation.

Printing the LIMIT TABLE SETUP Page

Perform the following steps to print out the display page using the PRINT DISP mode.

1. Connect the 4285A to the printer using an GPIB cable.
2. Set the printer to the Listen-Only mode.
3. Set the Talk-Only mode to ON on the *SYSTEM CONFIG* page.
4. Press **MEAS SETUP** and **LIMIT TABLE** to display the *LIMIT TABLE SETUP* page.
5. Move the CURSOR to the *SYS MENU* field.
6. Press **more 1/2**.

7. Press **PRINT DISP**. The display page is printed out by the printer as shown in Figure 5-26.

<LIMIT TABLE SETUP>		SYS MENU
FUNC: Cp-D		NOM: 0.00000pF
MODE: SEQ		AUX: ON COMP: ON
BIN	LOW	HIGH
1	+400.000pF	+410.000pF
2		+420.000pF
3		+430.000pF
4		+440.000pF
5		+450.000pF
6		+460.000pF
7		+470.000pF
8		+480.000pF
9		+490.000pF
2nd	-.010000	+.100000

Figure 5-26. LIMIT TABLE SETUP Page Example

LIST SWEEP SETUP Page

The LIST SWEEP function of the 4285A allows you to program up to ten sweep points and to automate the measurement process. When you press *MEAS SETUP* and *LIST SETUP*, the *LIST SWEEP SETUP* page will be displayed. The following five parameters can be swept by the LIST SWEEP.

- Test frequency
- Oscillator level voltage
- Oscillator level current
- DC bias voltage (When Option 001 is installed.)
- DC bias current (When Option 002 is installed, and the 42841A and the 42842C are combined.)

On the *LIST SWEEP SETUP* page, the following control settings of the list sweep measurement can be set. (Each field in parenthesis is used when that control is set.)

- LOAD/STORE (*SYS MENU*)
- Printout (*SYS MENU*)
- Clear Table (*SYS MENU*)
- Sweep Mode (*MODE*)
- Sweep Parameter Selection (*FREQ [Hz]*, *LEVEL [V]*, *LEVEL [A]*, *BIAS [V]*, or *BIAS [A]*)
- Sweep Point Settings (*sweep points*)
- Limit Parameter Selection (*LMT*)
- Low/High Limit Values (*LOW*, *HIGH*)

These functions are described in the following paragraphs.

The available fields and softkeys which corresponded to the fields on this page are shown in Figure 4-10 and Figure 4-11.

<LIST SWEEP SETUP>
SYS MENU
MEAS
SETUP

MODE :

FREQ(Hz)	LMT	LOW	HIGH	
1.00000M	A	123.456p	124.567p	CORRECTION
2.00000M	A	123.456p	124.567p	
3.00000M	A	123.456p	124.567p	LIMIT TABLE
4.00000M	A	123.456p	124.567p	
5.00000M	A	123.456p	124.567p	LIST SETUP
6.00000M	A	123.456p	124.567p	
7.00000M	A	123.456p	124.567p	
8.00000M	A	123.456p	124.567p	
9.00000M	A	123.456p	124.567p	
10.0000M	A	123.456p	124.567p	

: Field

L2004033

Figure 5-27. Available Fields on the LIST SWEEP SETUP Page

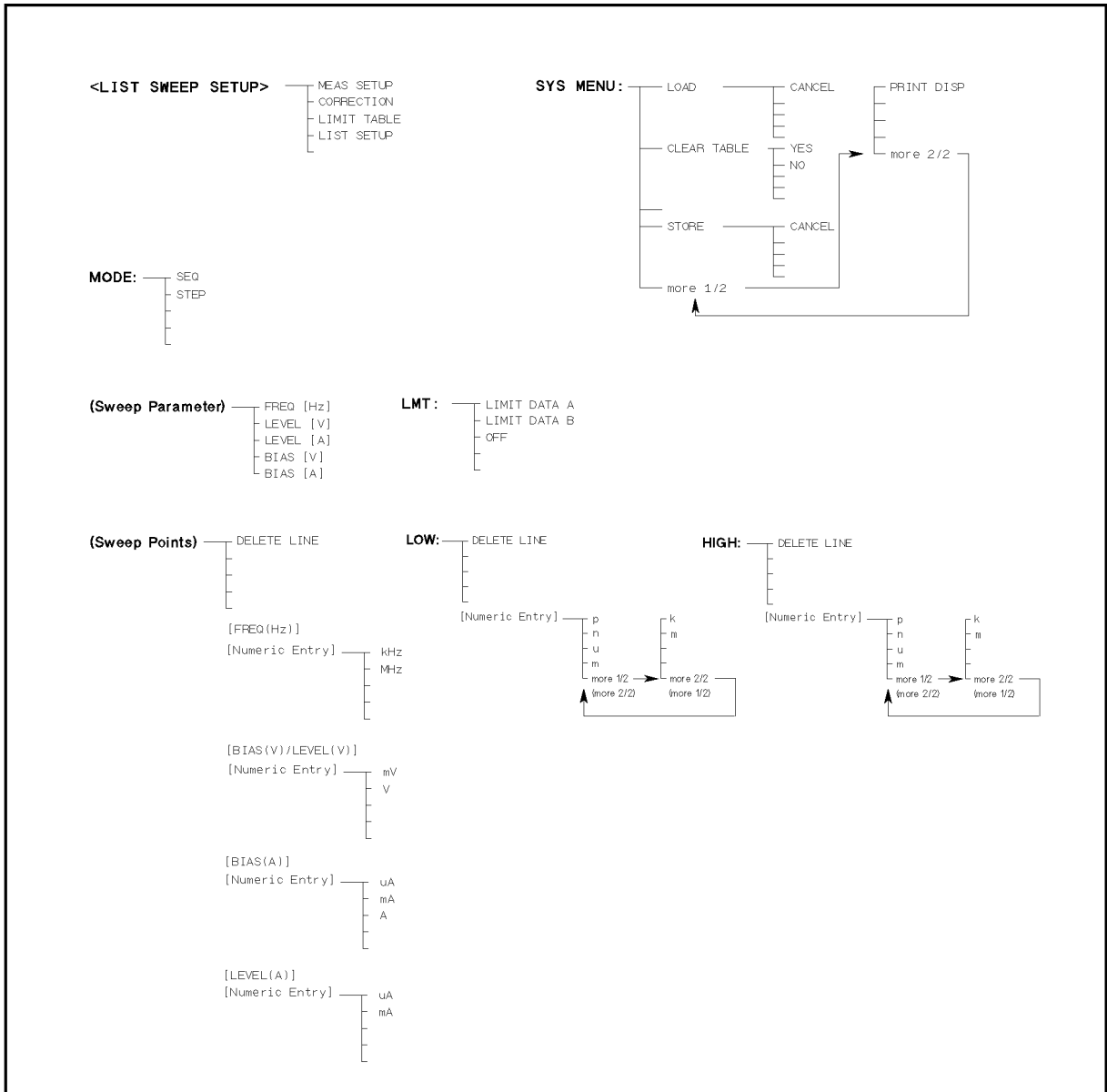

L2005034

Figure 5-28. Available Softkeys on the LIST SWEEP SETUP Page

MODE Field There are two sweep modes for list sweep measurements: sequential (SEQ) mode and step (STEP) mode. In the case of the sequential mode, when the 4285A is triggered once, the DUT is automatically measured at all sweep points. In the case of the step mode, the sweep point is incremented each time the 4285A is triggered.

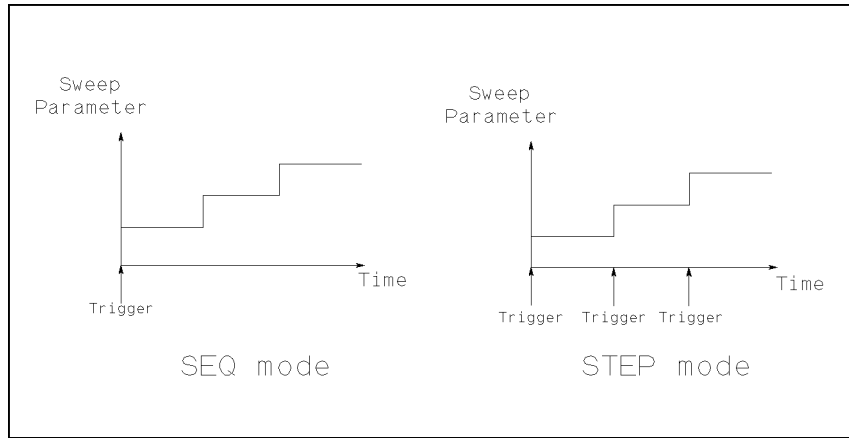

Figure 5-29. SEQ mode and STEP mode

Note



When two or more sweep points are the same, and are adjacent, the 4285A measures the DUT once, and then the measurement result is compared to limits set for each sweep point.

Setting the List Sweep Measurement Mode

Perform the following steps to set the list sweep measurement mode to the sequential mode, or to the step mode.

1. Move the CURSOR to the *MODE* field. The following softkeys will be displayed.
 - SEQ
 - STEP
2. Choose appropriate softkey to set the list sweep measurement mode.

List Sweep Parameter Field

The sweep point parameter for the list sweep measurement can be set to the test frequency, oscillator level, and DC bias. This field allows you to set the parameter of the list sweep measurement.

Setting the List Sweep Parameter

Perform the following steps to set the list sweep parameter.

1. Move the CURSOR to the *FREQ*[Hz] (*LEVEL* [V], *LEVEL* [A], *BIAS* [V], or *BIAS* [A]) field. The following softkeys will be displayed.
 - FREQ [Hz]
 - LEVEL [V]
 - LEVEL [A]
 - BIAS [V]
 - BIAS [A]
2. Choose appropriate softkey to set the list sweep measurement sweep parameter.

Sweep Points and Limit Fields

The list sweep function permits entry of up to 10 points and measurement limits. Figure 5-30 shows the available fields for setting the sweep points, the limit parameter, and the high/low limit values.

LIST SWEEP SETUP page

<LIST SWEEP SETUP>		SYS MENU	MEAS SETUP
MODE : SEQ			
FREQ (Hz)	LMT	LOW	HIGH
(1)	(2)	(3)	(4)
(5)			
(6)			
(7)			
(8)			
(9)			
(10)			

CORRECTION
 LIMIT TABLE
 LIST SETUP

: Field

Figure 5-30. List Sweep Settings

Note



When only the low limits of the sweep points are set, DUTs' whose selected parameter's data are equal, or are above the low limits are sorted as IN. When only the high limits of the sweep points are set, DUTs' whose selected parameter's data are equal, or are below the high limits are sorted as IN.

Note



When the *LMT* field is set to A or B, if the low/high limit values aren't entered, the comparison results are always IN.

Note



The comparison results are always LOW under the following conditions (which are equal to the condition at <STATUS> ≠ 0 in the data format.)

- Analog Bridge is unbalanced.
- A/D converter isn't working.
- Signal source is overloaded.
- ALC is unable to regulate.

Note



Do NOT enter a value which is lower than the LOW limit into the HIGH limit. If you do, the warning message *Warning, Improper high/low limits* will be displayed (this isn't an error, only a warning). The comparison results are as follows.

- Measurement results < LOW limit Result: LOW

- Measurement results \geq LOW limit Result: HIGH
-

Setting the Sweep Points and Limits

Perform the following steps to set the sweep points and measurement limits.

1. Move the CURSOR to the *SWEEP PARAMETER* field and use a softkey to select the sweep parameter.
2. Move the CURSOR to the *SWEEP POINT* field.
3. Enter the sweep point using the numeric entry keys. When the one of the numeric entry keys is pressed, the unit softkeys are available, so you can use these softkeys to enter the unit and terminate the entry instead of using **ENTER**.
4. The CURSOR will move automatically to the *LMT* field after you enter a sweep point. The following softkeys will be displayed.
 - **LIMIT DATA A**

This softkey is used to set the limit parameter to the primary parameter of the measurement function. When this softkey is pressed, the CURSOR will automatically move to the *LOW* field.
 - **LIMIT DATA B**

This softkey is used to set the limit parameter to the secondary parameter of the measurement function. When this softkey is pressed, the CURSOR will move automatically to the *LOW* field.
 - **OFF**

This softkey is used to set the list sweep measurement's limit function to OFF for the sweep point. When this softkey is pressed, the CURSOR will move automatically to the next sweep point field.
5. Press the appropriate softkey to set the limit parameter.
6. The CURSOR will move automatically to the *LOW* field. (If you pressed **OFF** in the previous step, the CURSOR will move automatically to the next *sweep point* field.) Enter the low limit value.
7. The CURSOR will move automatically to the *HIGH* field. Enter the high limit value using the numeric entry keys. After entering the high limit value, the CURSOR will move automatically to the next sweep point field. Repeat steps 3 through 7 until the all sweep points are filled out.

SYS MENU Field

The system menu on this page allows you to perform the following control functions.

- Load/Store
- Clear Table
- Printer

These functions, except for the clear table function, are the same as the functions in the system menu on the *MEAS DISPLAY* page. (A description of each function is given in “SYS MENU Field” in Chapter 4 on page 4-4.) So in the case of the clear table function, the description and procedure are given, and in the case of the other functions, only the procedure is given.

LOAD/STORE Softkey

Perform the following steps on the *LIST SWEEP SETUP* page to LOAD/STORE the control settings from/to internal non-volatile memory or an external memory card.

1. Set all controls.
2. Move the CURSOR to the *SYS MENU* field on the *LIST SWEEP SETUP* page.
3. If you are using a memory card, insert the memory card to the MEMORY card slot.
4. Press **STORE** when you want to use the store function. The message *Enter record number to STORE* will be displayed on the system message line.

Press **LOAD** when you want to use the load function. The message *Enter record number to LOAD* will be displayed on the system message line.

5. Enter the record number using the numeric entry keys and **ENTER** to LOAD/STORE the current control settings.

Clear Table Function

This function allows you to clear all of the list sweep points and limits. When you change from the current sweep parameter to another sweep parameter, use this function.

Perform the following steps to set only all of the operations on the *LIST SWEEP SETUP* page to the power-on default settings.

1. Move the CURSOR to the *SYS MENU* field.
2. Press **CLEAR TABLE**. Then the message Clearing table, Are you sure? will be displayed, and the following softkeys will be displayed.
 - **YES**
 - **NO**
3. Press **YES** to confirm the clear the list sweep points and limits.

Printing the LIST SWEEP SETUP Page

Perform the following steps to print out the display page using the page dump function.

1. Connect the 4285A to the printer using an GPIB cable.
2. Set the printer to the Listen-Only mode.
3. Set the Talk-Only mode to ON on the *SYSTEM CONFIG* page.
4. Press **MEAS SETUP** and **LIST SETUP** to display the *LIST SWEEP SETUP* page.
5. Move the CURSOR to the *SYS MENU* field.
6. Press **more 1/2**.
7. Press **PRINT DISP**. The display page is printed out by the printer as shown in Figure 5-31.

<LIST SWEEP SETUP>		SYS MENU	
MODE : SEQ			
FREQ[Hz]	LMT	LOW	HIGH
1.0000M	A	400.000p	430.000p
2.0000M	B	40.0000m	60.0000m
3.0000M	B	40.0000m	60.0000m
4.0000M	B	40.0000m	60.0000m
5.0000M	B	40.0000m	60.0000m
6.0000M	B	40.0000m	60.0000m
7.0000M	B	40.0000m	60.0000m
8.0000M	B	40.0000m	60.0000m
9.0000M	B	40.0000m	60.0000m
10.0000M	B	40.0000m	60.0000m

Figure 5-31. LIST SWEEP SETUP Page Example

CATALOG/SYSTEM Menu

Introduction

This chapter provides information on the function of each of the four pages under **CATALOG/SYSTEM**.

- *CATALOG*
- *SYSTEM CONFIG*
- *CABLE CORRECTION*
- *SELF TEST*

This chapter describes the functions of each field on each page in the order listed above.

CATALOG Page

When you press **CATALOG/SYSTEM**, the *CATALOG* page will be displayed. The *CATALOG* page shows the stored instrument control settings. The following control functions can be set from this page. (The field in parenthesis is used to set the control function.)

- *LOAD/STORE (SYS MENU)*
- *Specify media (SYS MENU)*
- *Printout (SYS MENU)*
- *Purge record (SYS MENU)*

The available fields and the softkeys which correspond to each field on this page are shown in Figure 6-1 and Figure 6-2.

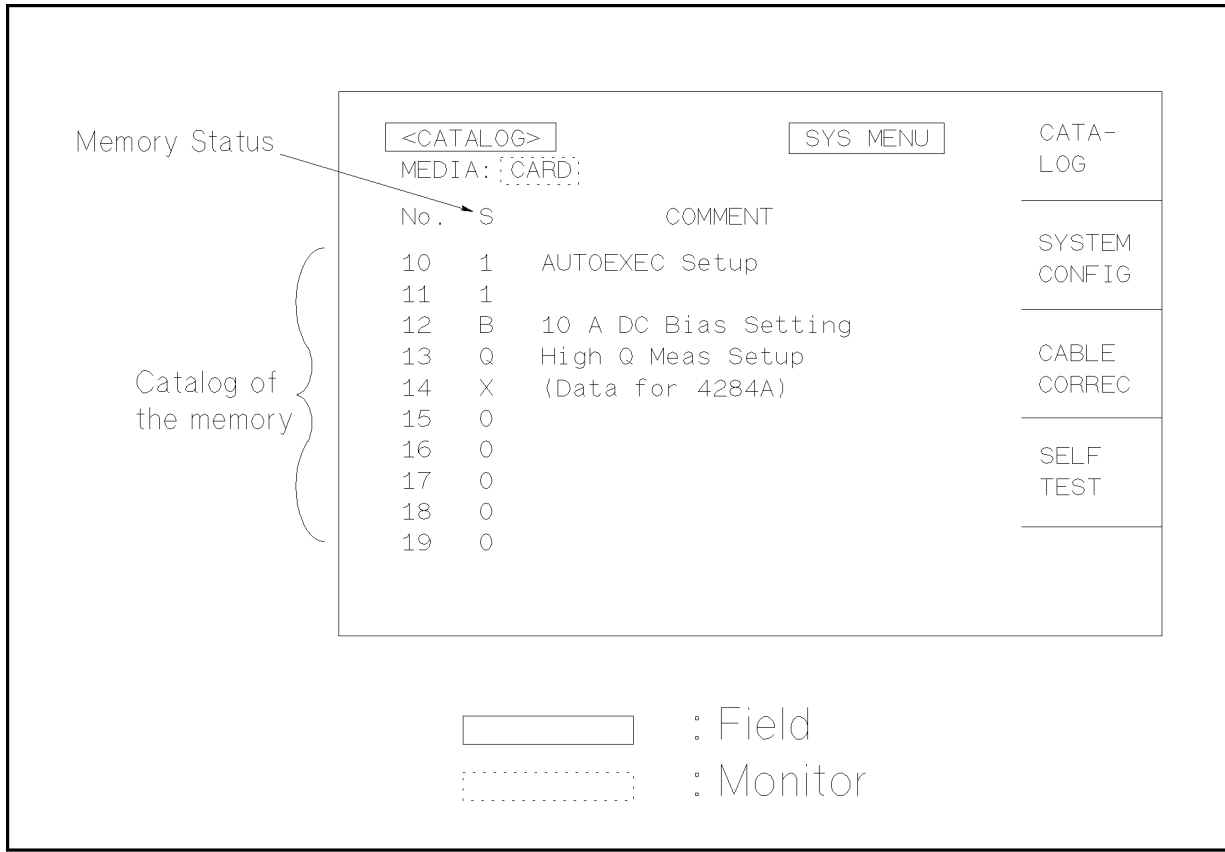

Figure 6-1. Available Fields on the CATALOG Page

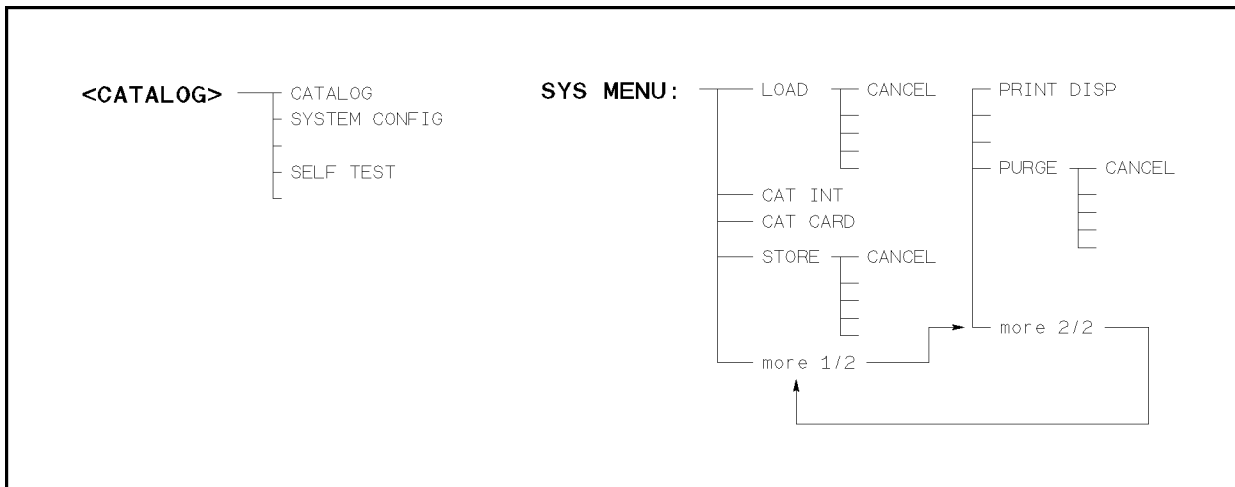

Figure 6-2. Available Softkeys on the CATALOG Page

In this page, the following information can be monitored.

- Media type
- Record number

- Record status
- Comment

Media Monitor Area

The 4285A supports two types of memory for storing the instrument control setting, internal memory (EEPROM) and an external memory card. Both memory media stores up to 10 records (instrument control settings). Current media type displayed on the LCD screen is displayed in the *MEDIA* monitor area. Media type can be changed by `CAT INT` and `CAT CARD` under the *SYS MENU* field.

Record Number Monitor Area

Instrument control settings stored in the memory are identified by record number. This number is displayed in the *No.* monitor area. Internal memory uses record numbers 0 to 9, and external memory card uses record numbers 10 to 19.

Record Status Monitor Area

The Control setting stored in a record can be identified by a one-digit alphanumeric character, called record status. The record status is displayed in the *S* monitor area. One of following five types is displayed.

- 0 No valid setting is stored in this record.
- 1 Normal LCR measurement mode setting is stored in this record.
- B High current bias mode setting is stored in this record. Option 002 accessory control interface, 42841A bias current source, and 42842C bias current test fixtures are required.
- Q Q adapter mode setting is stored in this record. Option 002 accessory control interface and 42851A Q adapter are required.
- X 4284A setting is stored in this record. (Data for 4284A) will be displayed in the *COMMENT* monitor area.

Comment Monitor Area

The comment data of the stored control setting is displayed in this area. The first 26 characters of the comment can be monitored.

SYS MENU Field

The system menu on this page allows you to perform the following functions.

- Load/Store
- Media
- Printer
- Purge

The load/store function is the same as the functions displayed on the system menu of the *MEAS DISPLAY* page. The printer function performs the same function of `PRINT DISP` of the system menu on the *MEAS DISPLAY* page. (The description of each function is given in “SYS MENU Field” in Chapter 4 on page 4-4.) So, in the case of the *MEDIA* and the *PURGE* functions, the description and setting procedures are described in the following paragraphs, only the procedure is described for the other functions.

CAT INT /CAT CARD Softkey

On the *CATALOG* page, the record list of the 4285A's internal memory (EEPROM) or the external memory card are displayed, with memory status (records stored or no record in the memory) and the comments (displayed on the comment line) for each settings.

CAT INT displays the stored instrument control settings in the internal memory (EEPROM).

CAT CARD displays the stored instrument control settings in the external memory card.

Specifying the Media Type

Perform following steps to change the media memory type.

1. Move the **CURSOR** to the *SYS MENU* field using the **CURSOR** keys. The following softkeys will be displayed in the softkey label area.

- **CAT INT**
- **CAT CARD**

2. Press either softkey to select the records to be displayed.

Loading or Storing the Instrument Control Setting

Perform the following steps to store the current control settings to the internal non-volatile memory or to the external memory card, or to load the control settings from the internal non-volatile memory or from the external memory card.

1. Set all instrument control setting.
2. Move the **CURSOR** to the *SYS MENU* field on the *CATALOG* page.
3. If you are going to store or load the settings to or from a memory card, insert a memory card into the *MEMORY* card slot.

4. Press **STORE** when you want to use the *STORE* function. The message *Enter record number to STORE* will be displayed on the system message line.

Press **LOAD** when you want to use the *LOAD* function. The message *Enter record number to LOAD* will be displayed on the system message line.

5. Use the numeric entry keys and **(ENTER)** to enter the record number at which the current control settings will be stored to or loaded from.

Printing the CATALOG Page

Perform the following steps to print out the catalog page.

1. Connect the 4285A to the printer using an GPIB cable.
2. Set the printer to the Listen-Only mode.
3. Set the Talk-Only mode to ON from the *SYSTEM CONFIG* page.

4. Press the *CATALOG/SYSTEM* menu key to display the *CATALOG* page.
5. Move the CURSOR to the *SYS MENU* field.
6. Press **more 1/2**.
7. Press **PRINT DISP**. The catalog page will be printed out to the printer as shown below.

<CATALOG>		SYS MENU
MEDIA : CARD		
No.	S	COMMENT
10	1	AUTOEXEC Test
11	1	{Z}-f Characteristics
12	B	10A DC Current Bias
13	1	DC-Bias Test No.1
14	Q	
15	Q	Q_Meas 25.2MHz
16	0	
17	0	
18	X	(Data for 4284A)
19	X	(Data for 4284A)

Figure 6-3. CATALOG Page Example

PURGE Softkey

This softkey erases the specified instrument control setting. The record status of the specified record changes to 0.

CANCEL Softkey

This softkey cancels the PURGE operation.

Purging the Unused Record

Perform the following steps to purge the control settings from the internal non-volatile memory or from the external memory card.

1. Move the CURSOR to the *SYS MENU* field on the *CATALOG* page.
2. Insert the memory card into the MEMORY card slot, if you are going to purge the settings from a memory card.
3. Press **more 1/2** and **PURGE**. The message Enter record number to PURGE will be displayed on the system message line.
4. Use the numeric entry keys and **(ENTER)** to enter the record number at which the control settings will be PURGED.

SYSTEM CONFIG Page

When you press **CATALOG/SYSTEM** and **SYSTEM CONFIG**, the *SYSTEM CONFIG* page will be displayed. On this page, the status of the GPIB interface and the options are displayed, and the following control functions can be set from this page. (The field in parenthesis is used to set the control function.)

- Printout (*SYS MENU*)
- Beeper function ON/OFF (*BEEPER*)
- GPIB address (*GPIB ADDRESS*)
- GPIB Talk-Only mode ON/OFF (*TALK ONLY*)
- Accessory control interface (Option 002) configuration (*CONFIG*)
- Handler interface (Option 201 or 202) ON/OFF (*HANDLER I/F*)
- Scanner interface (Option 301) ON/OFF (*SCANNER I/F*)

Each control function is described in the following paragraphs. This page also provides the following information in monitor fields. These conditions is set depending on the status of the options installed in the instrument.

- GPIB interface installed/not installed (*GPIB I/F*)
- DC bias (Option 001) installed /not installed (*DC BIAS (#001)*)
- Accessory control interface (Option 002) installed /not installed (*ACCESSORY I/F (#002)*)
- Handler Interface (Option 201 or 202) installed /not installed (*HANDLER I/F (#201 or #202)*)
- Scanner Interface (Option 301) installed /not installed (*SCANNER I/F (#301)*)

The available fields and the softkeys which correspond to each field on this page are shown in Figure 6-4 and Figure 6-5.

<input type="text" value=" <SYSTEM CONFIG >"/>		<input type="text" value=" SYS MENU"/>	CATA- LOG
BEEPER	: <input type="text" value=" ON"/>		
HP-IB I/F	: <input type="text" value=" INSTALLED"/>		SYSTEM CONFIG
HP-IB ADDRESS	: <input type="text" value=" 17"/>		
TALK ONLY	: <input type="text" value=" OFF"/>		
DC BIAS	(#001): <input type="text" value=" INSTALLED"/>		CABLE CORREC
ACCESSORY I/F	(#002): <input type="text" value=" INSTALLED"/>		
CONFIG	: <input type="text" value=" Q ADAPTER"/>		SELF TEST
HANDLER I/F	(#201): <input type="text" value=" INSTALLED"/>		
	: <input type="text" value=" ON"/>		
SCANNER I/F	(#301): <input type="text" value=" INSTALLED"/>		
	: <input type="text" value=" ON"/>		

: Field
 : Monitor

L2006004

Figure 6-4. Available Fields on the SYSTEM CONFIG Page

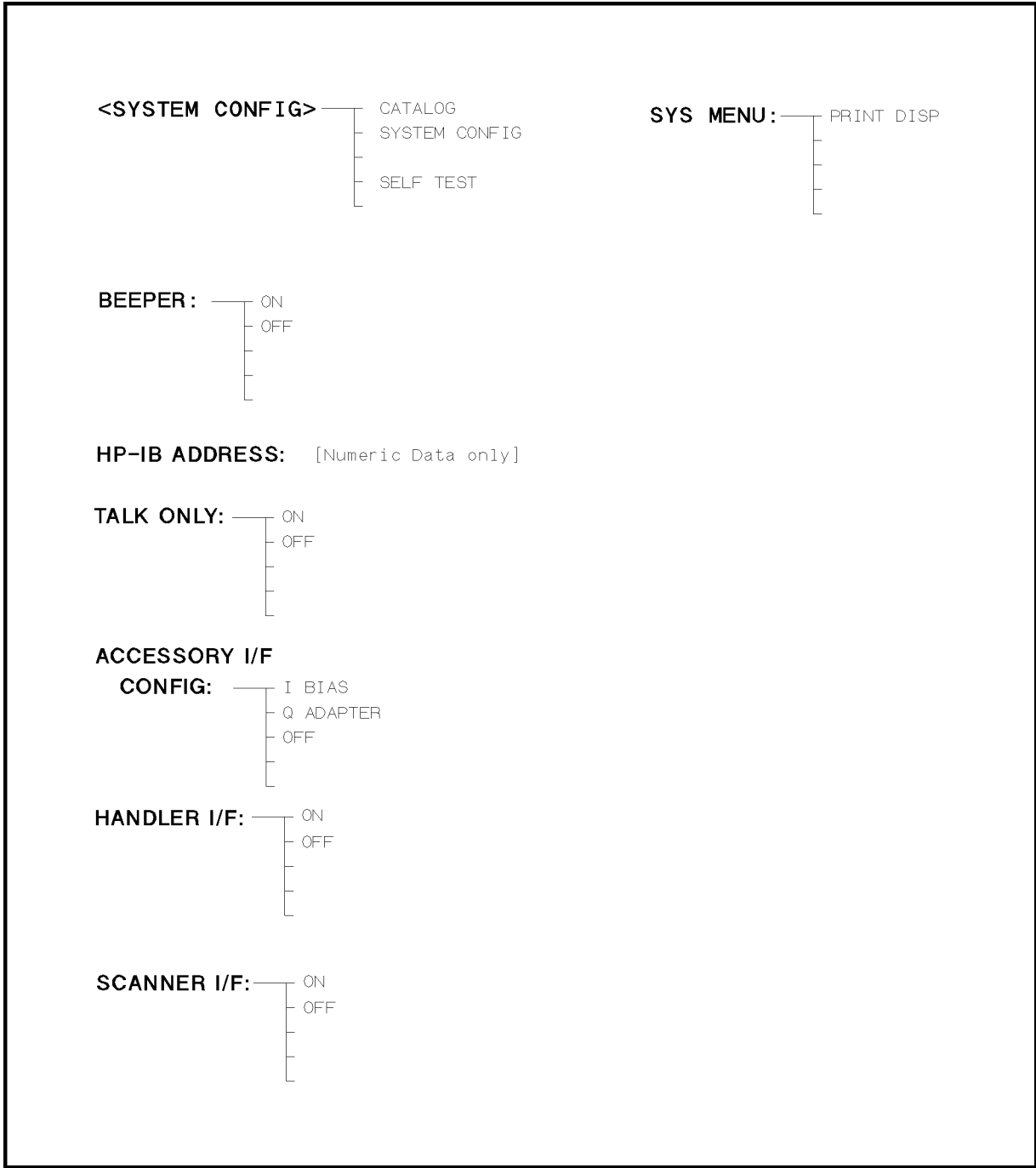

L2006004

Figure 6-5. Available Softkeys on the SYSTEM CONFIG Page

BEEPER Field

The 4285A emits a beep if any of the following conditions occur. The beeper can be turned ON or OFF in the *BEEPER* field.

- ADCERR is displayed.
- An error has occurred.
- A warning message is displayed.
- Correction data measurement at 51 preset frequencies is completed.
- Comparison judgment result is out of bin.
- Failed sweep comparison judgment.
- Key lock ON/OFF mode is switched.

Turning the Beeper ON or OFF

Perform the following steps to set the beeper function to ON or OFF.

1. Move the CURSOR to the *BEEPER* field on the *SYSTEM CONFIG* page. The following softkeys will be displayed in the softkey label area.

-
-

2. Use softkeys to set the beeper function to the ON or OFF.

GPIB ADDRESS Field

All 4285As except for those with Option 109 Delete GPIB Interface are remotely controlled via the GPIB. The 4285A can be linked to other instruments and computers to form an automated measurement system. When the GPIB interface is installed, the *GPIB ADDRESS* field changes the GPIB address of the 4285A. Allowable GPIB address values of the 4285A are 0 to 30 address. Decimal 31 is not accessible. The factory set default address is 17.

Setting the GPIB Address

Perform the following steps to set the GPIB address.

1. Move the CURSOR to the *GPIB ADDRESS* field on the *SYSTEM CONFIG* page.
2. Enter the GPIB address using the numeric entry keys, and press .

TALK ONLY Field

The 4285A can directly print out the display and measurement data to an GPIB printer without connecting a controller (computer). To do so, the 4285A must be a Talk-Only device. The 4285A can be a Talk-Only device or addressable device by setting ON or OFF in the *TALK ONLY* field. When the Talk-Only mode is set to ON, TLK (talk) GPIB status indicator on the front panel is lit.

Setting the Talk-Only Mode

Perform the following steps to set the 4285A to the Talk-Only mode (ON) or to the addressable mode.

1. Move the CURSOR to the *TALK ONLY* field on the *SYSTEM CONFIG* page. The following softkeys will be displayed in the softkey label area.

- ON
- OFF

2. Use the softkeys to set the Talk-Only mode to ON (Talk-Only), or to OFF (addressable).

CONFIG Field

When the 4285A is equipped with an Option 002 Accessory Control Interface and the accessories are connected to the 50-pin Amphenol connector on the rear panel, this field is used to specify the accessory to be controlled.

The status of the accessory control interface is monitored on this *SYSTEM CONFIG* page (*ACCESSORY I/F (#002)*).

I BIAS Softkey

This softkey enables the controls of the 42841A via the accessory control interface on the rear panel (50-pin amphenol connector) and the following control settings are set.

- Option 001 DC bias is disabled.
- Cable length (*CABLE* field) is fixed to 1 m.
- Disable the DC bias output.

Q ADAPTER Softkey

This softkey enables the controls of the 42851A via the accessory control interface on the rear panel (50-pin amphenol connector) and the following control settings are set.

- DC bias, Option 001 and Option 002 with the 42841A, are disabled.

OFF Softkey

This softkey disables the controls of the accessory control interface on the rear panel (50-pin amphenol connector) and the following control settings are set.

- DC current bias when combined with the 42841A is disabled.
- DC bias is turned off.

Configuring the High DC Current Bias System

To control the 42841A from the 4285A via Option 002 accessory control interface, perform the following steps.

1. Move the CURSOR to the *CONFIG* field on the *SYSTEM CONFIG* page. The following softkeys will be displayed in the softkey label area.
 - I BIAS
 - Q ADAPTER
 - OFF
2. Press I BIAS to perform the high current biased impedance measurement.

3. Further information for operating the 4285A when combined with the 42841A, refer to *42841A Operation Manual* (Agilent Part Number 42841-90000).

Configuring the Precision Q Measurement System

To control the 42851A from the 4285A via Option 002 accessory control interface, perform the following steps.

1. Move the CURSOR to the *CONFIG* field on the *SYSTEM CONFIG* page. The following softkeys will be displayed in the softkey label area.
 - I BIAS
 - Q ADAPTER
 - OFF
2. Press Q ADAPTER to perform the precision Q measurement using the resonant method.
3. Further information for operating the 4285A when combined with the 42851A, refer to *42851A Operation Manual* (Agilent Part Number 42851-90000).

Back to the Normal LCR Measurement Mode

To perform a normal LCR measurement without controlling the device connected to the Option 002 Accessory Control Interface, perform the following steps.

1. The following softkeys will be displayed in the softkey label area.
 - I BIAS
 - Q ADAPTER
 - OFF
2. Press OFF to perform a normal LCR measurement by the auto balancing bridge method.

HANDLER I/F (#201)/(#202) Field

When the 4285A is equipped with an Option 201 or 202 Handler Interface, the 36-pin Amphenol connector on the rear panel is used to interface between the 4285A and the handler to pass control input/output signals and the comparator function bin judgment results. For details refer to *Option 201 Handler Interface OPERATION NOTE* or *Option 202 Handler Interface OPERATION NOTE*.

The status of the handler interface installed/not installed is monitored on the *SYSTEM CONFIG* page (*HANDLER I/F (#201 or #202)*).

Setting the Handler Interface to ON or OFF

When the handler interface is set to ON, the handler interface signals through the interface connector are enabled. Perform the following steps to set the handler interface signal input/output to ON or OFF.

1. Move the CURSOR to the *HANDLER I/F (#201)* field (or the *HANDLER I/F (#202)* field) on the *SYSTEM CONFIG* page. The following softkeys will be displayed in the softkey label area.
 - ON

- OFF

2. Use the softkeys to set the handler interface function to ON or OFF.

SCANNER I/F (#301) Field

When the 4285A is equipped with the Option 301 Scanner Interface, the multi channel correction function can be used. The 14-pin Amphenol connector on the rear panel is used to interface between the 4285A and the scanner to pass control output signals and channel selection signals for multi channel correction. Maximum of 90 channels of multi-channel correction can be performed. For details refer to *Option 301 Scanner Interface OPERATION NOTE*.

The status of the scanner interface installed/not installed is monitored on the *SYSTEM CONFIG* page (*SCANNER I/F (#301)*).

Setting the Scanner Interface to ON or OFF

When the scanner interface is set to ON, the scanner interface signals through the interface connector are enabled. Perform the following steps to set the handler interface to ON or OFF.

Note



To set the correction mode to MULTI, this procedure must be performed, even if the multi channel correction function is used without the interface connector on the rear panel, for example in the case of controlling a scanner and the 4285A via GPIB.

1. Move the CURSOR to the *SCANNER I/F (#301)* field on the *SYSTEM CONFIG* page. The following softkeys will be displayed in the softkey label area.

- ON
- OFF

2. Use the softkeys to set the scanner interface function to ON or OFF.

SYS MENU Field

The system menu on this page allows you to perform the following functions.

- Printer

The printer function is the same as the function of **PRINT DISP** of the system menu on the *MEAS DISPLAY* page. (The description of the function is given in “SYS MENU Field” in Chapter 4 on page 4-4.) So only the setting procedures for this function are described in the following paragraphs.

Printing the SYSTEM CONFIG Page

Perform the following steps to print out the *SYSTEM CONFIG* page using the PRINT DISP mode.

1. Connect the 4285A to the printer using an GPIB cable.
2. Set the printer to the Listen-Only mode.
3. Set the Talk-Only mode to ON from the *SYSTEM CONFIG* page.

4. Move the CURSOR to the *SYS MENU* field.
5. Press PRINT DISP to print out the displayed page. The displayed page is printed out as shown in Figure 6-6.

```
<SYSTEM CONFIG>          SYS MENU

BEEPER                    : ON
HP-IB I/F                 : INSTALLED
  HP-IB ADDRESS           : 17
  TALK ONLY                : ON

DC BIAS      (#001): INSTALLED
ACCESSORY I/F(#002): INSTALLED
  CONFIG      : OFF
HANDLER I/F  (#201): NOT INSTALLED
  : OFF
SCANNER I/F  (#301): INSTALLED
  : ON
```

Figure 6-6. SYSTEM CONFIG Page Example

CABLE CORRECTION Page

When you press **CATALOG SYSTEM** and **CABLE CORREC**, the *CABLE CORRECTION* page will be displayed. In this page, error correction for the 1m cable (16048A) and 2m cable (16048D) can be performed. When the 4285A configured for the high current DC biased measurement mode combining with the 42841A and the 42842C, (set to **I BIAS** mode on the *CONFIG* field), error correction for the 1m cable only is allowed.

Note



Measurement error due to an individual test lead is proportional to the square of the test frequency. Accordingly, the difference of each test leads can't be ignored at high frequencies, such as 30 MHz. When the 4285A is shipped from the factory, it contains default correction data for both 1m and 2m cables. However, it may not be directly usable with your 16048A or 16048D. Cable correction must be performed if you need to measure the DUT accurately at high frequencies, or when you change the test cables.

While the cable correction data measurement is being performed, the measurement conditions will be changed to the following:

Averaging rate :	4
DC bias :	OFF
Integration time :	LONG
Measurement range :	FIXED (50 Ω range: LOAD correction data measurement.)
Oscillator Level :	1 V_{rms} , LOAD correction data measurement.
ALC Mode :	OFF

Note



If the cable correction was not performed correctly, the ALC function may not work properly.

CABLE CORRECTION MENU Field

The following two cable correction pages are included in this page. Both pages are almost the same except for the cable length to be applied.

- 1 m Cable Correction for 16048A (*No.1*)
- 2 m Cable Correction for 16048D (*No.2*)

Choosing the 1 m Cable Correction Menu

1. Move the CURSOR to *CABLE CORRECTION MENU* field on the *CABLE CORRECTION* page.
2. Press **1** and **ENTER**, to select the *1 m CABLE CORRECTION* page.

Choosing the 2 m Cable Correction Menu

1. Move the CURSOR to *CABLE CORRECTION MENU* field on the *CABLE CORRECTION* page.
2. Press **2** and **ENTER**, to select the *2 m CABLE CORRECTION* page.

REF. Om Softkey

This softkey performs reference data measurement at the preset frequencies. The reference data measurement will take approximately 40 s, and the message REF measurement in progress will be displayed on the system message line while the reference data measurement is being performed. The number displayed in the right most position on the system message line shows the number of remaining frequency points to be measured for reference data. When the reference data measurement is completed, the 4285A beeps, displays REF measurement complete, and displays the * at the left of REF. Om softkey label.

OPEN Softkey

This softkey performs OPEN correction data measurement at the preset frequencies. The OPEN correction data measurement will take approximately 40 s, and the message OPEN measurement in progress will be displayed in the system message line while the OPEN correction data measurement is being performed. The number displayed on the right most position on the system message line shows the number of remaining frequency points to be measured for reference data. When the OPEN correction data measurement is completed, the 4285A beeps, displays OPEN measurement completed, and displays an * at the left of OPEN softkey label.

SHORT Softkey

This softkey performs SHORT correction data measurement at the preset frequencies. The SHORT correction data measurement will take approximately 40 s, and the message SHORT measurement in progress will be displayed in the system message line while the SHORT correction data measurement is being performed. The number displayed in the right most position on the system message line shows the number of remaining frequency points to be measured for reference data. When the SHORT correction data measurement is completed, the 4285A beeps, displays SHORT measurement completed, and displays an * at the left of SHORT softkey label.

LOAD Softkey

This softkey performs LOAD correction data measurement at the preset frequencies. The LOAD correction data measurement will take approximately 40 s, and the message LOAD measurement in progress will be displayed in the system message line while the LOAD correction data measurement is being performed. The number displayed in the right most position on the system message line shows the number of remaining frequency points to be measured for reference data. When the LOAD correction data measurement is completed, the 4285A beeps, displays LOAD measurement completed, and displays an * at the left of LOAD softkey label.

SAVE Softkey

This softkey calculates cable correction coefficient from the REF, OPEN, SHORT, and LOAD value, and stores the calculation result to the internal system EEPROM. The SAVE operation will take approximately 20 s, and the message Saving cable correction data ... will be displayed in the system message line while the SAVE operation is being performed. The number displayed in the right most position on the system message line shows the number of remaining frequency points to be measured for reference data. When the cable correction data store is completed, the 4285A beeps, displays 1 (2) m cable correction completed, and returns to the *CABLE CORRECTION* page. When any of the REF, OPEN, SHORT, and LOAD correction measurements will not be performed and you press SAVE, the 4285A beeps and displays XXX measurement incomplete.

ABORT Softkey

This softkey is displayed while the cable correction data measurement, REF. 0m, OPEN, SHORT, or LOAD, is being performed. Press this softkey to stop the cable correction data measurement. When the cable correction data measurement is aborted, the previous cable correction data is retained.

Performing the Cable Correction Data Measurement

1. Press **CATALOG/SYSTEM** and **CABLE CORREC**. The *CABLE CORRECTION* page will be displayed.
2. Move the CURSOR to the *CABLE CORRECTION MENU* field.
3. Press **1** or **2** and **ENTER** to select either the 1 m or 2 m *CABLE CORRECTION* menu. The following instruction screen and softkeys will be displayed.

<CABLE CORRECTION>	1m cable	REF. 0m
1 Connect 100 Ω resistor to UNKNOWN terminals		OPEN
2 Press REF 0m key		
3 Disconnect 100 Ω and connect 1m test cable		SHORT
4 Connect OPEN to test cable		
5 Press OPEN key		
6 Connect SHORT in place of OPEN		LOAD
7 Press SHORT key		
8 Connect 100 Ω in place of SHORT		
9 Press LOAD key		
10 Press SAVE key		SAVE
—		
Use softkeys to select		

Figure 6-7. Cable Correction Page

4. Connect the 42102A 100Ω Resistor to the 4285A UNKNOWN terminals. If you don't have an 42100A, use the furnished 100Ω Resistor Box (Agilent Part Number 04285-61001).
5. Press **REF. Om.** REF measurement will be displayed in the system message line. Wait until the 4285A beeps and displays the REF measurement complete. An * will be displayed left side of **REF. Om.**
6. Connect the 16048A/D test leads to the UNKNOWN terminals of the 4285A.
7. Connect the 42090A OPEN Termination and the 16048A/D test leads with the furnished BNC female-female adapter (Agilent Part Number 1250-0080).

If you don't have the 42090A OPEN Termination, configure an OPEN as shown in Figure 6-8 using the furnished BNC f-f adapter.

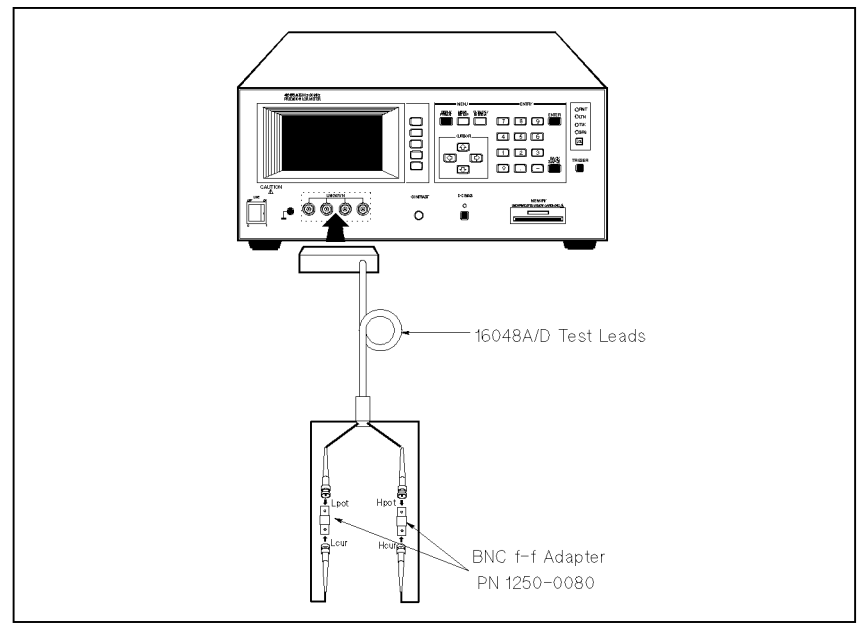

Figure 6-8. OPEN Termination (Alternative)

8. Press **OPEN.** OPEN measurement in progress will be displayed in the system message line. Wait until the 4285A beeps and displays the OPEN measurement completed. An * will be displayed left side of **OPEN.**
9. Connect the 42091A SHORT Termination and the 16048A/D test leads using the furnished BNC f-f adapter.

If you don't have the 42091A SHORT Termination, configure a SHORT as shown in Figure 6-9 using two tee BNC m-f-f adapters and the furnished BNC f-f adapter.

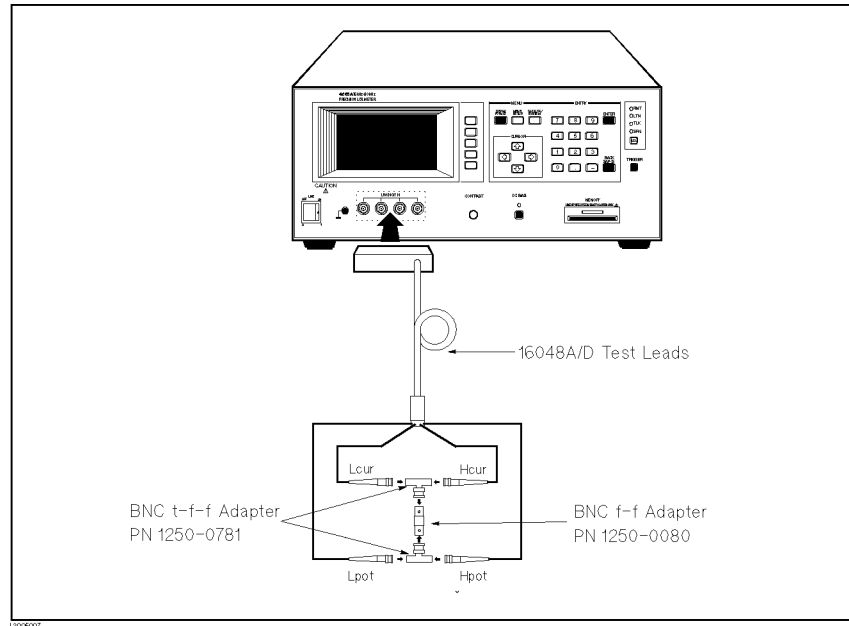

Figure 6-9. SHORT Termination (Alternative)

10. Press **SHORT**. **SHORT** measurement in progress will be displayed on the system message line. Wait until the 4285A beeps and displays the **SHORT** measurement completed. An * will be displayed left side of **SHORT**.
11. Connect the 42102A 100 Ω Resistor (or the furnished 100 Ω Resistor Box) and the 16048A/D test leads using the furnished BNC f-f adapter.
12. Press **LOAD**. **LOAD** measurement in progress will be displayed on the system message line. Wait until the 4285A beeps and displays the **LOAD** measurement completed. An * will be displayed left side of **LOAD**.
13. Press **SAVE**. Saving cable correction data ... will be displayed in the system message line. Wait until the 4285A beeps and displays the *CABLE CORRECTION* page.

Note



When changing the 16048A/D test leads, the above cable correction measurement procedure must be re-performed.

SELF TEST Page

When you press **CATALOG/SYSTEM** and **SELF TEST**, the *SELF TEST* page will be displayed. This *SELF TEST* page is for service use only. You can check the 4285A's digital functions using the self test functions listed on this page.

There are two fields on this page. (The field in parenthesis is used to set the control function.)

■ Self Test Menu (*TEST MENU*)

The available fields and the softkeys which correspond to the fields on this page are shown in Figure 6-10 and Figure 6-11.

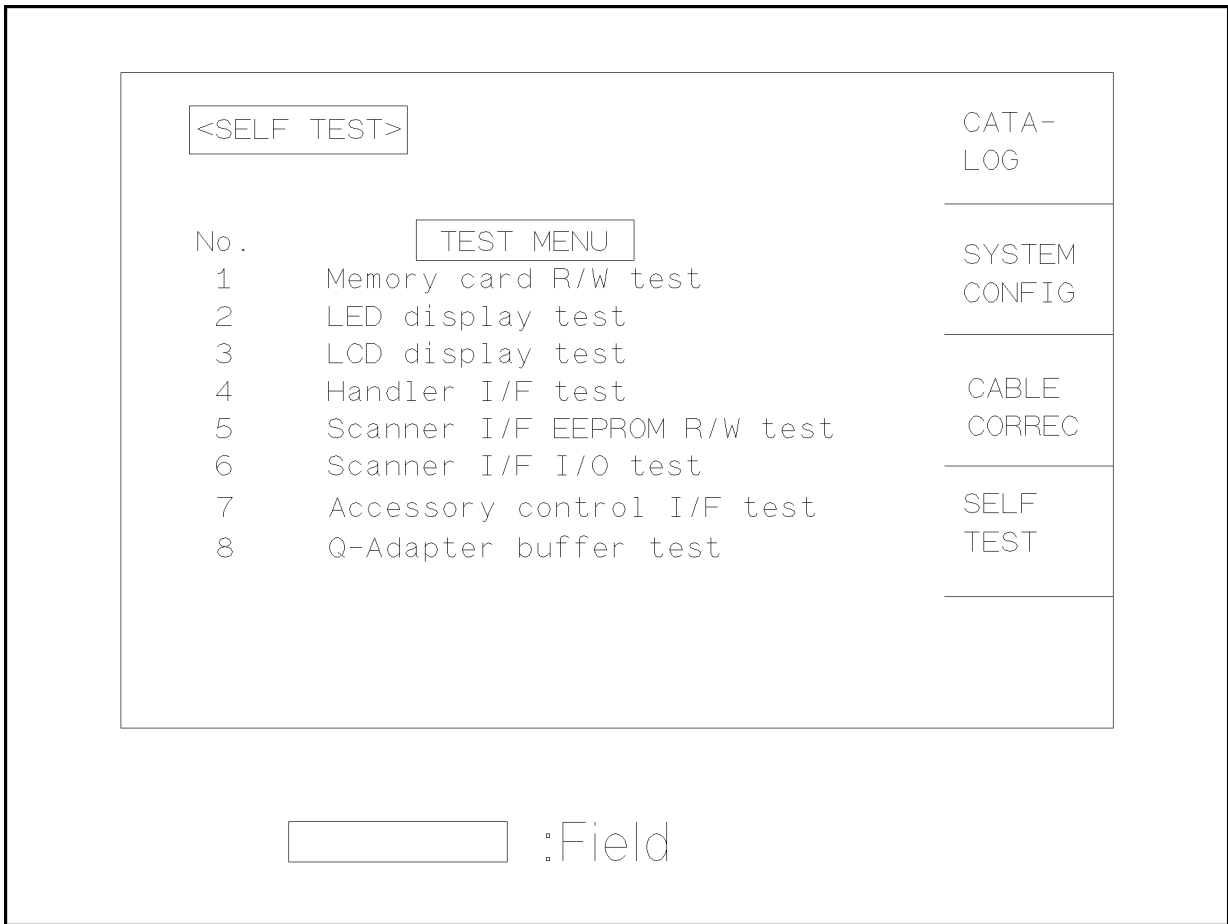
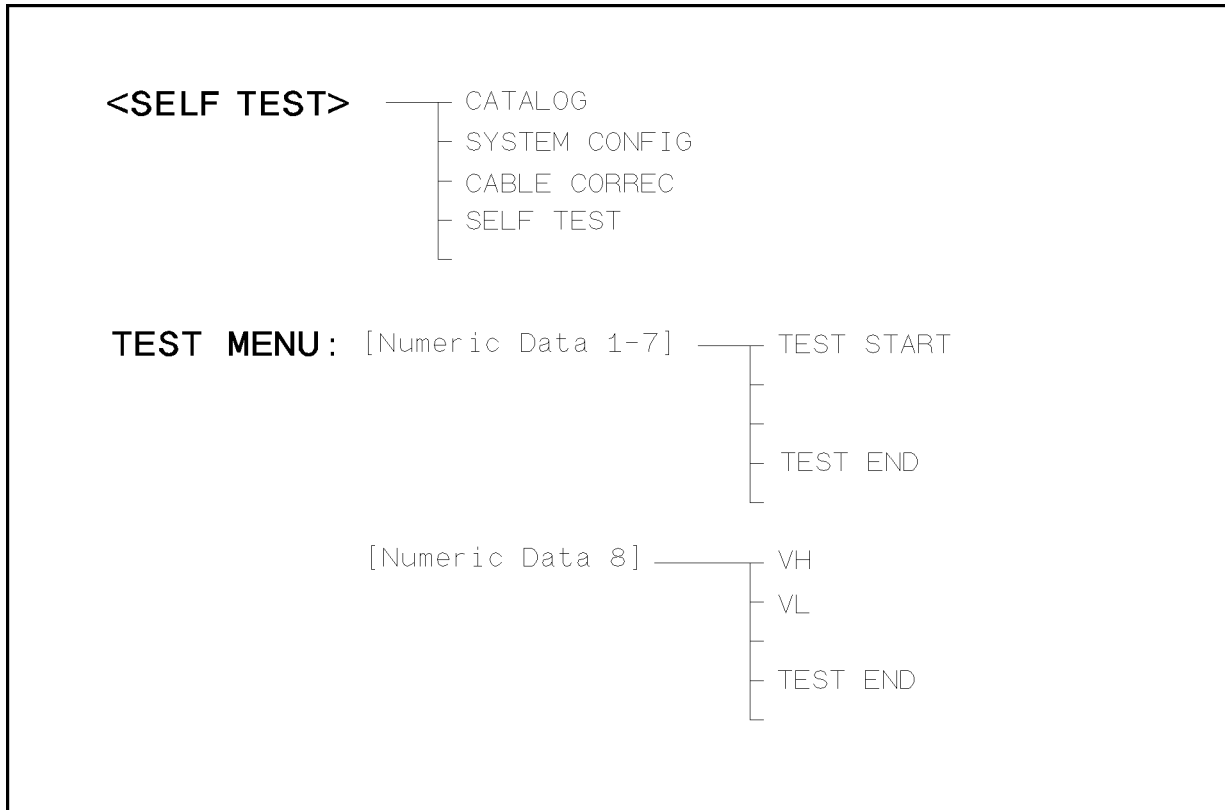

Figure 6-10. Available Fields on the SELF TEST Page



L2006009

Figure 6-11. Available Softkeys on the SELF TEST Page

TEST MENU Field

The following self tests are included in this page. Each test is described in the following paragraphs. (The number in parenthesis is the test number used when the self test preceding the number in parenthesis is selected.)

- Memory Card Read/Write Test (No.1)
- LED Display Test (No.2)
- LCD Display Test (No.3)
- Handler Interface Test (No.4)
- Scanner Interface EEPROM Read/Write Test (No.5)
- Scanner Interface Input/Output Test (No.6)
- Accessory Control Interface Input/Output Test (No.7)
- Q-Adapter Buffer Test (No.8)

Memory Card R/W Test

This test is used to check the read and write functions of the memory card. When this test is started, a bit pattern is written to the lower address of the memory card, then pattern is read back and checked. This write pattern check is repeated from the low to high memory addresses.

Note



When this test is performed, data stored on the memory card is retained.

Performing the Memory Card R/W Test

Perform the following steps to perform the memory card R/W test.

1. Move the CURSOR to the *TEST MENU* field on the *SELF TEST* page.
2. Press **1** and **ENTER**, to select test number 1. The **▶MEMORY CARD R/W TEST** screen will be displayed, and the following information indicating the address of the memory card is displayed.

START ADRS (HEX)= : Start address as a hexadecimal expression

END ADRS (HEX)= : End address as a hexadecimal expression

TEST ADRS (HEX)= : Current testing address as a hexadecimal expression

3. Insert a memory card into the MEMORY card slot on the front panel.

Caution



While this test is in progress, DO NOT remove the memory card, and DO NOT turn the 4285A OFF. If you do the data stored on the memory card may be lost.

4. Press **TEST START** to start the test, and to abort the test, press **TEST END**.

If the test failed, the test is aborted and *TEST ADRS (HEX)=* on the display shows the address at which the test failed. Retry the test from step 1.

If the test passed, *Test completed.* will be displayed on the system message line.

5. Press **TEST END** to exit from the **▶MEMORY CARD R/W TEST** display.

LED Display Test

This test checks the five LEDs on the front panel. When this test is started, five LED indicators, *RMT*, *LTN*, *TLK*, *SRQ* and *DC BIAS*, will be toggled ON and OFF once per second.

Performing the LED Display Test

Use the following steps to perform the LED display test.

1. Move the CURSOR to the *TEST MENU* field on the *SELF TEST* page.
2. Press **2** and **ENTER** to select test number 2. The **▶LED DISPLAY TEST** screen will be displayed.
3. Press **TEST START** to start the test. The five LED indicators, *RMT*, *LTN*, *TLK*, *SRQ* and *DC BIAS*, will be toggled ON and OFF once per second.
4. Press **TEST END** to stop the test and to exit from the **▶LED DISPLAY TEST** screen.

LCD Display Test

This test checks the front panel LCD. When this test is started, all LCD characters used are displayed and toggled between the normal and inverse modes once per second.

Performing the LCD Display Test

Perform the following steps to perform the LCD display test.

1. Move the CURSOR to the *TEST MENU* field on the *SELF TEST* page.
2. Press **3** and **ENTER**, to set the test number to 3. The **▶LCD DISPLAY TEST** screen and all LCD characters will be displayed.
3. Press **TEST START** to start the test. The display will toggle between the normal and inverse modes once per second.
4. Press **TEST END** to stop the test and to exit from the **▶LCD DISPLAY TEST** screen.

Handler I/F Test

This test checks the output signals of the Option 201 or 202 Handler Interface. When this test is started, each of the handler output signals is sequentially asserted for one second, until all output signals have been asserted, then the sequence is repeated until **TEST END** is pressed. This test uses the Handler Simulator (Agilent Part Number 04278-65001) is described in *4285A Maintenance Manual* (Agilent Part Number 04285-90030).

Scanner I/F EEPROM R/W Test

This test checks the read and write functions of EEPROM for the Option 301 Scanner Interface. When this test is started, a bit pattern is written to the lower address of the EEPROM, then the write pattern is checked by reading back the bit pattern. This write pattern check is repeated from low to high EEPROM addresses.

Performing the Scanner I/F EEPROM R/W Test

Perform the following steps to perform the scanner interface EEPROM R/W test.

1. Move the CURSOR to the *TEST MENU* field on the *SELF TEST* page.
2. Press **5** key and **ENTER**, to set the test number to 5. The **▶SCANNER I/F EEPROM R/W TEST** screen will be displayed, and the following messages indicating the address of the scanner interface EEPROM are displayed.

START ADRS (HEX)= : Start address as a hexadecimal expression

END ADRS (HEX)= : End address as a hexadecimal expression

TEST ADRS (HEX)= : Current testing address as a hexadecimal expression

Note

The Data stored in the EEPROM is retained when this test is performed.

3. Press **TEST START** to start the test.

Note

To abort the test, press **TEST END**.

If the test failed, the test is aborted and *TEST ADRS (HEX)* = on the display will show the address at which the test failed. Restart from step 1.

If the test passed, the message *Test completed.* will be displayed on the system message line.

4. Press **TEST END** to exit from the **►SCANNER I/F EEPROM R/W TEST** screen.

Scanner I/F I/O Test

This test checks the input/output signals of the Option 301 Scanner Interface. When the test is started, two scanner output signals (/INDEX and /EOM) are alternately asserted, and the input signals (CH No. and /CH_VALID) are read when only the status of these signals is switched. This sequence is repeated until **TEST END** is pressed. This test uses the Scanner Simulator (Agilent Part Number 04278-65301) described in *4285A Maintenance Manual* (Agilent Part Number 04285-90030).

Accessory Control I/F Test

This test checks the input/output signals of the Option 002 Accessory Control Interface. When the test is started, the /CS_0 and /CS_1 output signals are alternately asserted, and ADDRESS and DO0 to DO7 output signals are changed in ascending order. Input signals DI0 to DI15 are read when only the status of these signals is switched. This sequence is repeated until **TEST END** is pressed. This test uses the Bias Current Interface Simulator (Agilent Part Number 42841-65001) described in *4285A Maintenance Manual* (Agilent Part Number 04285-90030).

Q-Adapter Buffer Test

This test switches the signal path of the 42851A Precision Q Adapter by controlling the multiplexer in the 42851A. For details, refer to *42851A Maintenance Manual* (Agilent Part Number 42851-90030).

Measurement Basics

Introduction

This chapter provides basic measurement procedures, basic L, C, and R measurement theory, and measurement hints for achieving maximum performance with the 4285A.

Basic Measurement Procedure

Basic measurement procedure using the 4285A and topics to be discussed are listed below. Refer to the corresponding paragraph for each step.

1. Setup the 4285A measurement conditions.
 - Impedance Parameters
 - Parallel/Series Circuit Mode
 - Signal Level
2. Connecting a test fixture to the 4285A.
 - Four-Terminal Pair Configuration
 - Measurement Contacts
3. Setup the correction function.
 - Correction Functions
4. Connecting a DUT to the test fixture
 - Parasitic components Related to DUT Connection
5. Perform measurement
 - Characteristics

Impedance Parameters

All circuit components, resistors, capacitors or inductors, have parasitic components lurking in the shadows waiting for the unwary, for example unwanted resistance in capacitors, unwanted capacitance in inductors, and unwanted inductance in resistors. Thus, simple components should be modeled as complex impedances, for in fact that is what they are!

Figure 7-1, (A) shows the complex impedance definitions and (B) shows the vector representation of complex impedance. Impedance, \hat{Z} is the total opposition that a circuit or device offers to the flow of alternating current at a given frequency. \hat{Z} contains a real and an imaginary part, and it is expressed in rectangular form as Resistance and Reactance, or in polar form as magnitude of Impedance and Phase as follows.

$$\dot{Z} = R + jX = |Z| \angle \theta$$

$$|Z| = \sqrt{R^2 + X^2}$$

$$\theta = \arctan\left(\frac{|X|}{R}\right)$$

$$R = R_s$$

Where,

\dot{Z} : Complex Impedance [Ω]

R : Resistance [Ω]

X : Reactance [Ω]

|Z| : Magnitude of Impedance [Ω]

θ : Phase of Impedance [deg or rad]

R_s : Series Resistance [Ω]

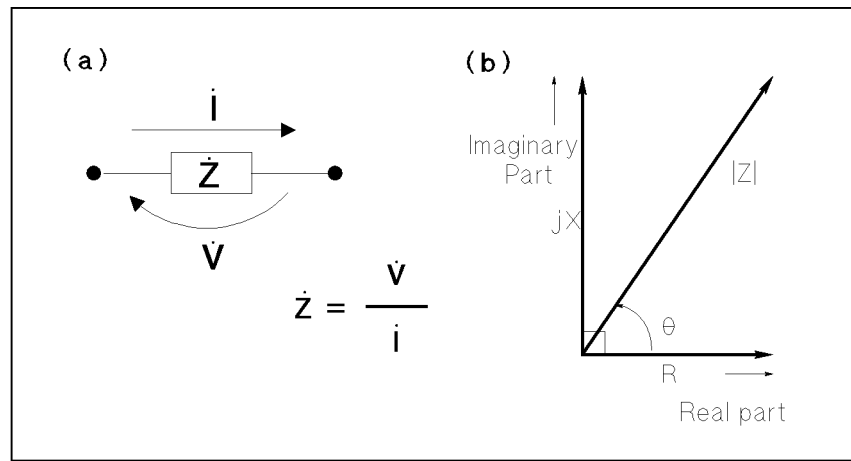

Figure 7-1. Definition of Impedance

The following parameters can be used to represent the reactance.

$$X = 2\pi fL$$

Where,

f : Frequency [Hz]

L : Inductance [H]

In addition to these parameters, the Quality Factor (Q) and Dissipation Factor (D) are used to describe the quality of components.

$$Q = \frac{1}{D} = \frac{|X|}{R}$$

Where,

Q : Quality Factor

D : Dissipation Factor

In some case, the reciprocal of impedance (Admittance), \dot{Y} is used. Figure 7-2 shows the vector representation of admittance. As \dot{Z} (Complex Impedance), \dot{Y} is composed of a real and an imaginary part, and is expressed in rectangular form as Conductance and Suceptance, or in polar form as magnitude of Admittance and Phase. The following are expressions for Admittance.

$$\dot{Y} = \frac{1}{\dot{Z}}$$

$$\dot{Y} = G + jB = |Y| \angle \phi$$

$$|Y| = \sqrt{G^2 + B^2} = \frac{1}{|Z|}$$

$$\phi = \arctan\left(\frac{|B|}{G}\right) = -\theta$$

$$B = 2\pi fC$$

$$Q = \frac{1}{D} = \frac{|B|}{G}$$

$$G = \frac{1}{R_p}$$

Where,

\dot{Y} : Complex Admittance [S]

G : Conductance [S] (real)

B : Suceptance [S] (imaginary)

|Y| : Magnitude of Admittance [S]

ϕ : Phase of Admittance [deg or rad]

C : Capacitance [F]

R_p : Parallel Resistance [Ω]

Note



The |Y|- θ measurement function of the 4285A can obtain the |Y| and ϕ parameters given in the above equations.

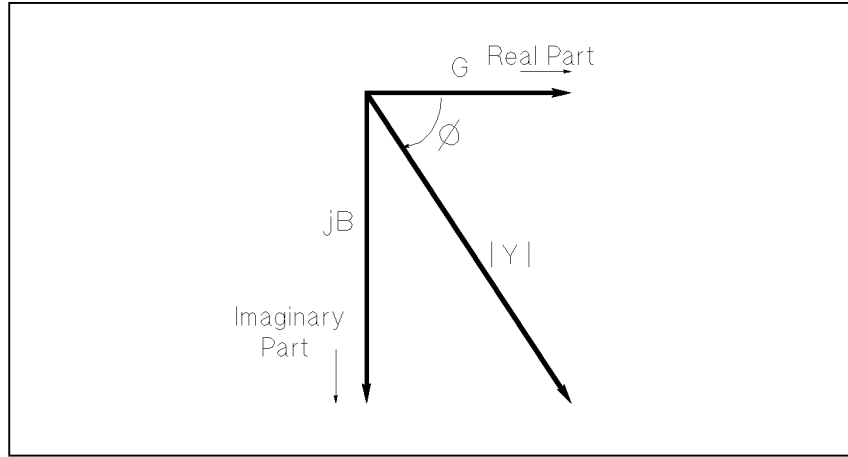

Figure 7-2. Vector Representation of Admittance

Parallel/Series Circuit Mode

To measure L, C, or R, there are two equivalent circuit models, the parallel and series modes as shown in Table 6-1, and the 4285A can select the mode by setting the FUNC (C_p , C_s , L_p or L_s) on the *MEAS SETUP* page. To determine which circuit model is best, consider the relative impedance magnitude of the reactance and R_s and R_p .

Table 7-1. Parallel/Series Circuit Model

Circuit Model	Measurement Function	Definition of D, Q and G
C_p Model	C_p -D C_p -Q C_p -G C_p - R_p	$D = \frac{1}{2\pi f C_p R_p} = \frac{1}{Q}$ $G = \frac{1}{R_p}$
C_s Model	C_s -D C_s -Q C_s - R_s	$D = 2\pi f C_s R_s = \frac{1}{Q}$
L_p Model	L_p -D L_p -Q L_p -G L_p - R_p	$Q = \frac{R_p}{2\pi f L_p} = \frac{1}{D}$ $G = \frac{1}{R_p}$
L_s Model	L_s -D L_s -Q L_s - R_s	$Q = \frac{2\pi f L_s}{R_s} = \frac{1}{D}$

Selecting Circuit Mode of Capacitance

The following description gives some practical guide lines for selecting the capacitance measurement circuit mode.

Small Capacitance

Small capacitance yields a large reactance, which implies that the effect of the parallel resistance (R_p) has relatively more significance than that of the series resistance (R_s). The low value of resistance represented by R_s has negligible significance compared with the capacitive reactance, so the parallel circuit mode (C_p -D or C_p -G) should be used, modeled by (a) in Figure 7-3.

Large Capacitance

When the converse is true and the measurement involves a large value of capacitance (low impedance), R_s has relatively more significance than R_p , so the series circuit mode (C_s -D or C_s -Q) should be used, modeled by (b) in Figure 7-3.

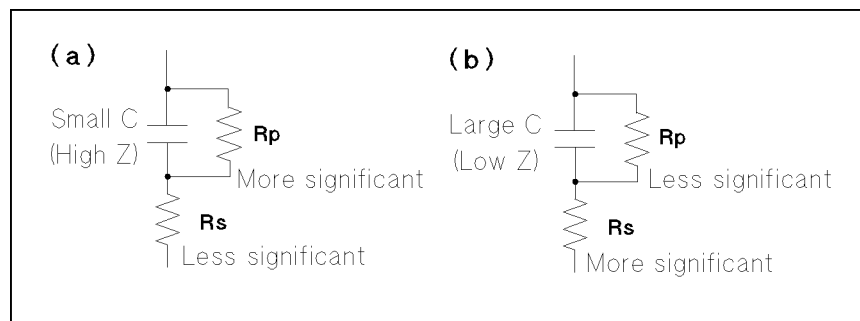

Figure 7-3. Capacitance Circuit Mode Selection

The following is a rule of thumb for selecting the circuit model according to the impedance of the capacitor.

- Above approx. 10 k Ω : use parallel circuit model
- Below approx. 10 Ω : use series circuit model
- Between above values : follow the manufacturer's recommendation

For example, to measure a 20 nF capacitor at 1 MHz (impedance will be approximately 8 Ω), the C_s -D or C_s -Q function is suitable.

Selecting Circuit Mode of Inductance

The following description gives some practical guide lines for selecting the inductance measurement mode, (which circuit mode to use.).

Large Inductance

The reactance at a given frequency is relatively large (compared with that of a small inductance), so the parallel resistance becomes more significant than the series component. So, a measurement in the parallel equivalent circuit mode (L_p -D, L_p -Q or L_p -G) is more suitable, modeled by (a) in Figure 7-4.

Small Inductance

Conversely, for low values of inductance the reactance becomes relatively small (compared with that of a large inductance) so the series resistance component is more significant. So, the series equivalent circuit mode (L_s -D or L_s -Q) is the appropriate, modeled by (b) in Figure 7-4.

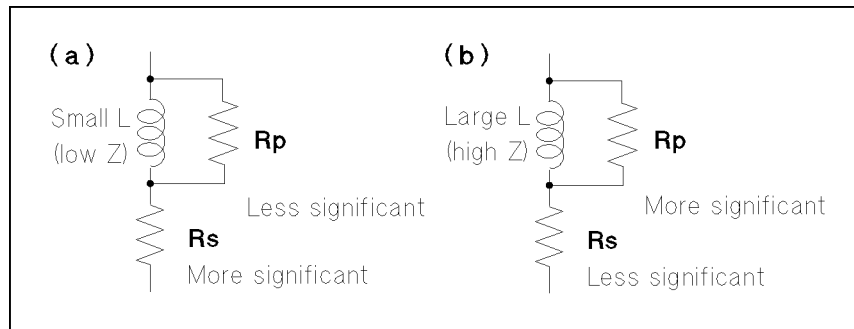

Figure 7-4. Inductance Circuit Mode Selection

The following is a rule of thumb for selecting the circuit model according to the impedance of the inductor.

- Below approx. 10Ω : use series circuit model
- Above approx. $10 \text{ k}\Omega$: use parallel circuit model
- Between above values : follow the manufacturer's recommendation

For example, to measure a $1 \mu\text{H}$ inductor at the 1 MHz (impedance may be approximately 6.3Ω), L_s -D or L_s -Q function is suitable.

Test Signal Level

Most components have impedance characteristics that are dependent on the applied test signal level. So, the oscillator level setting should be set appropriate for the DUT.

Oscillator Level Setting

The 4285A's oscillator level can be set to the appropriate voltage or current value, and by using the automatic level control (ALC) function, the actual signal level applied to the DUT can be regulated to be the same as the setting value. So the signal level setting mode can be selected in the following four ways.

- Oscillator level set as voltage and ALC set to OFF:

The open terminal voltage is set to the entered voltage value in the *LEVEL* field.

- Oscillator level set as current and ALC set to OFF:

The short terminal current is set to the entered current value in the *LEVEL* field.

- Oscillator level set as voltage and ALC set to ON:

The signal level across the DUT is set to the entered voltage value in the *LEVEL* field.

- Oscillator level set as current and ALC set to ON:

The signal level across the DUT is set to the entered current value in the *LEVEL* field.

For details of the ALC function, refer to "ALC Field" in Chapter 5.

Note



By using the level monitor function (*V_m* and *I_m* monitor area on the *MEAS DISPLAY* page), the actual signal level across the DUT can be monitored.

Signal Level Setting Selection Example for Inductance Measurements

An inductor's inductance value may differ widely depending on the current through the inductor, due to the permeability of its core material. Inductance measurements under constant current signal levels allows you to extract the frequency characteristics of the inductor isolated from its signal level characteristics.

To make constant current level measurements, set appropriate oscillator level in current value, and set ALC to ON. The signal current level through the inductor will be constant.

Four-Terminal Pair Configuration

Generally, any mutual inductance, interference of the measurement signals, and unwanted residual factors in the connection method related to ordinary termination methods will have significant effects on the measurements, especially at high frequency. The 4285A employs the four-terminal pair measurement configuration which permits easy, stable, and accurate measurements and avoids the measurement limitations inherent to such factors.

Figure 7-5 shows the four-terminal pair measurement principle. The *UNKNOWN* terminals consists of four coaxial connectors.

- H_{CUR} : High current
- H_{POT} : High potential
- L_{POT} : Low potential
- L_{CUR} : Low current

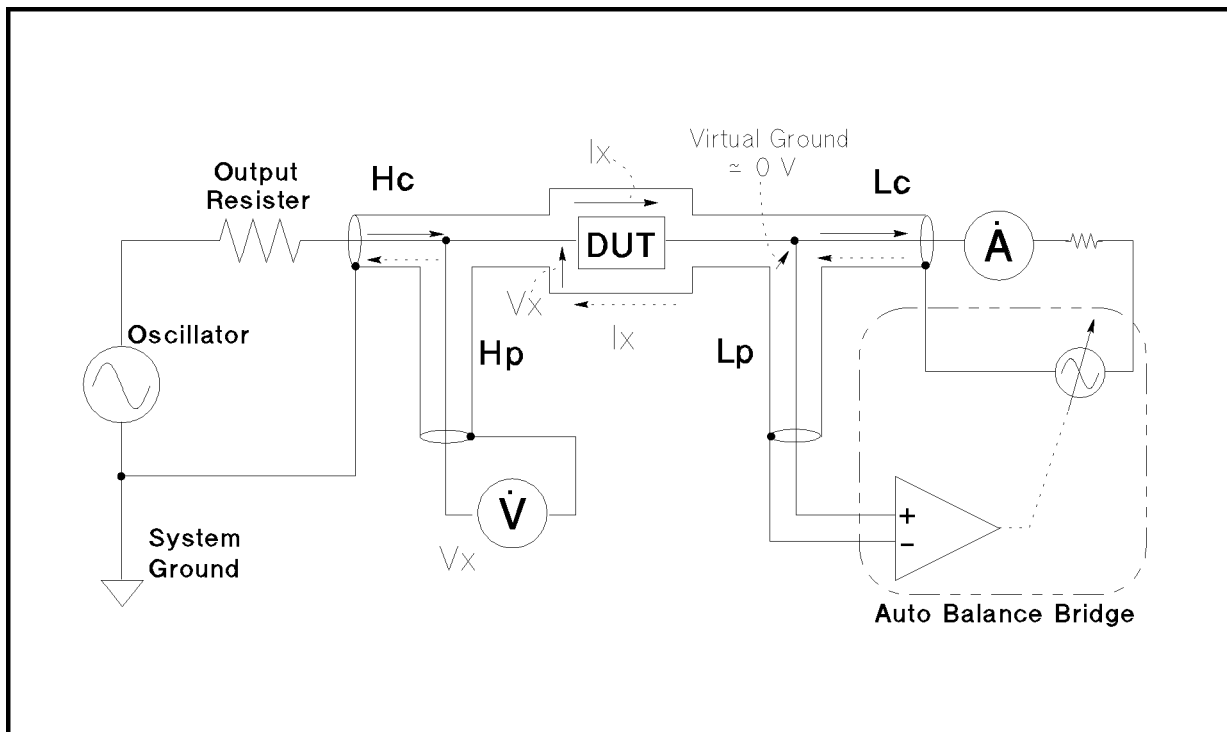

Figure 7-5. Four-Terminal Pair Measurement Principle

The four-terminal pair measurement method has the advantage in both low and high impedance measurements. The outer shield conductors work as the return path for the measurement signal current (they are not grounded). The same current flows through both the center conductors and outer shield conductors (in opposite directions), so no external magnetic fields are generated around the conductors (the magnetic fields produced by the inner and outer currents completely cancel each other). Because the measurement signal current does not develop an inductive magnetic field, test leads do not contribute additional errors due to self or mutual inductance between the individual leads.

Measurement Contacts

This paragraph gives general notes and techniques for using the four-terminal pair configuration efficiently.

To realize accurate measurements using the four-terminal pair measurement technique, the following is required to make measurement contacts (the number labels in the following description corresponds to the numbers in Figure 7-6).

1. The signal path between the 4285A and DUT should be as short as possible.
2. To construct the four-terminal pair measurement circuit configuration, the outer shields of H_{CUR} and H_{POT} , L_{CUR} and L_{POT} terminals must be respectively connected together at a point as near as possible to the point at which the DUT will be connected.

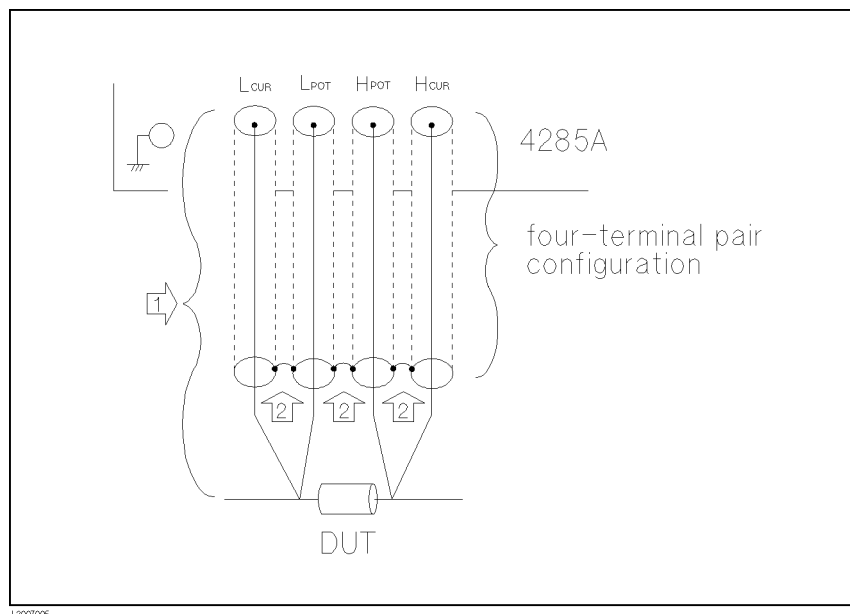

Figure 7-6. Measurement Contacts

The following paragraphs will give you some techniques for using the four-terminal pair configuration effectively and efficiently.

Capacitance to Ground

To measure capacitors of 10 pF or less, the stray capacitance (when the conductors are grounded, this is capacitance to ground), between the measurement contacts and the conductors near the capacitor will influence the measurement, as shown in Figure 7-7.

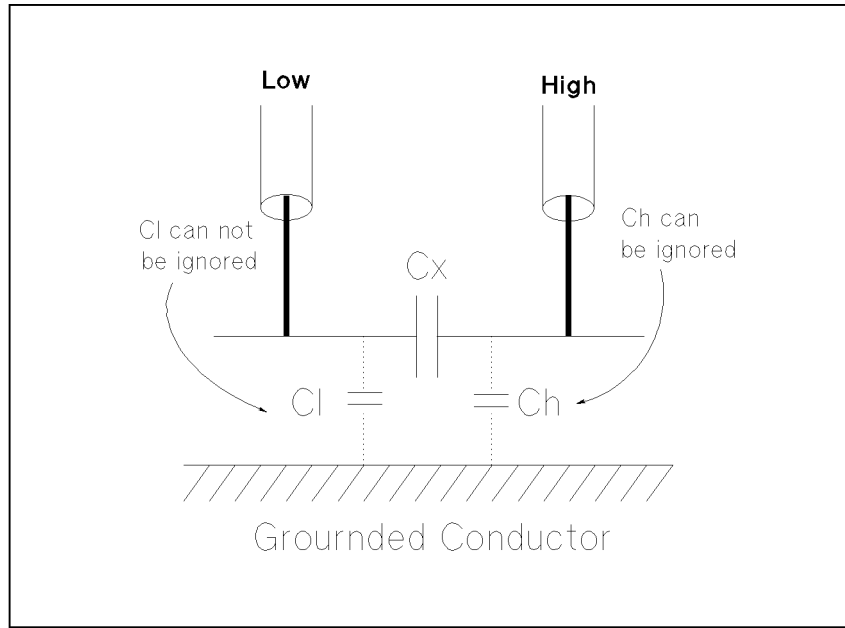
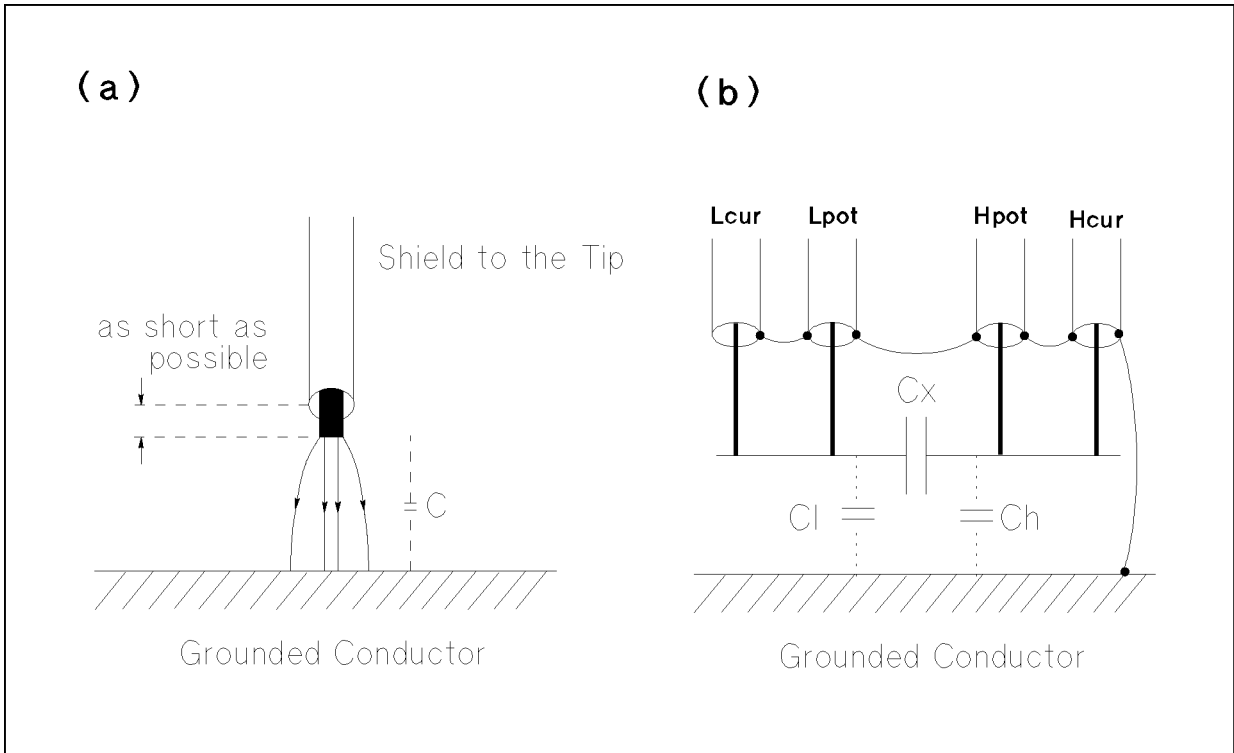

Figure 7-7. Model of Capacitance to Ground

To minimize the stray capacitance of the test leads, the center conductor of the test leads should be kept as short as possible, as shown in Figure 7-8, (A). If four-terminal pair connections are close to the point where contact is made with the DUT, interconnect the shields of the measurement terminals to the conductor to reduce the influence of the stray capacitance to ground, as shown in Figure 7-8, (B).



L2007008

Figure 7-8. Reducing Capacitance to Ground

Contact Resistance

Contact resistance between the contacting terminals and the DUT causes measurement error when measuring large values of capacitance, especially in D (dissipation factor) measurements.

When measuring large capacitance values, the four-terminal measurement contacts have the advantage of less measurement error as compared to the two terminal method. Select a test fixture which can hold the DUT tight to stabilize the connection and to give the lowest contact resistance.

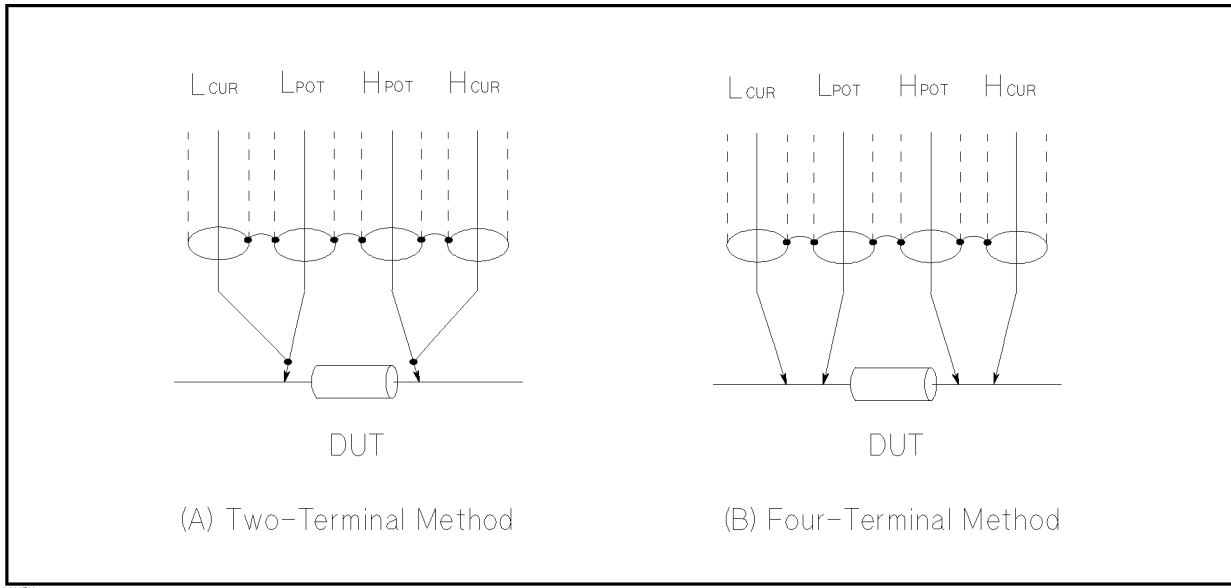

Figure 7-9. Contact Configuration

Measurement Cable Termination

When the test cable is extended by 1 m or 2 m, measurement error will increase obviously above 5 MHz. This is because the 4285A internally switches the circuitry at 5 MHz and the length of the four-terminal pair cable affects the measured value.

To minimize the error, it is recommended to use one of the following test fixtures connected to the end of the 16048A/D Test Leads using the furnished BNC f-f adapters.

- 16034E
- 16047C
- 16047D

If a test fixture cannot be used, connect the additional cables or adapters as described below. This is to simulate the electrical length of the test fixture.

- When using the isolated connecting plate

Extend the H_p' and the L_c' test leads 6-7cm including BNC connector length. Initially, make a little bit longer test leads and adjust the length by minimizing the measurement data gap at 5 MHz. The effects of the H_c' and L_p' test leads are negligible. Use an insulating material for the connector plate.

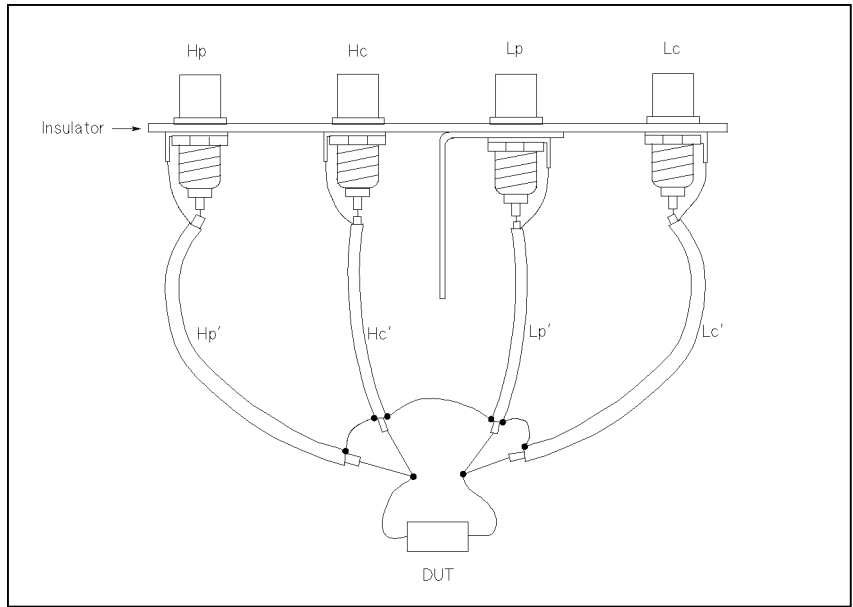

Figure 7-10. Termination Method

■ When using BNC Adapters (informal method)

Extend the H_p' and the L_c' test leads 6-7cm by connecting the BNC connectors as shown below. Do not extend further than the top of the BNC tee m-f-f adapter.

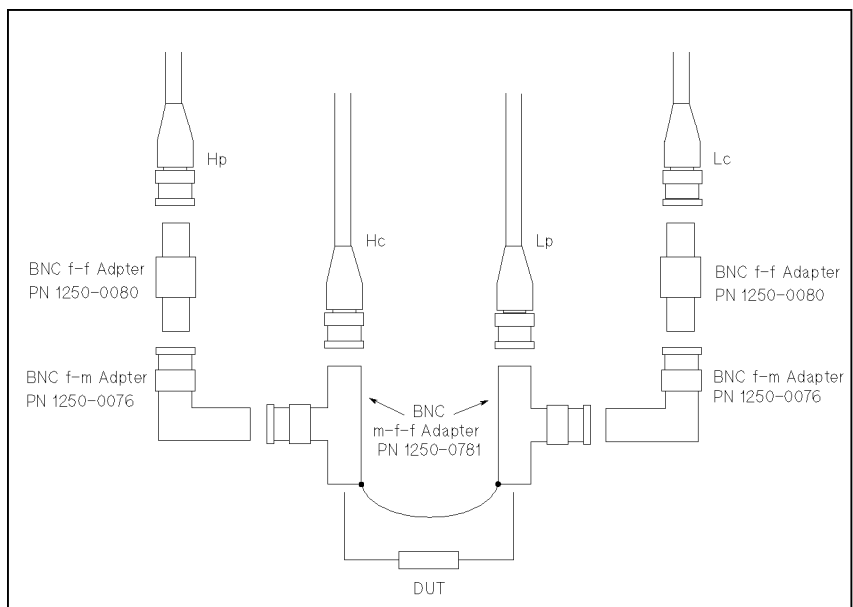

Figure 7-11. Termination Method (informal method)

Note



Apply this method for the short term usage. This method is not suitable for permanent usage.

Extending Test Leads

If measurement contact cannot be made using the four-terminal pair configuration, use the connection methods shown in Figure 7-12.

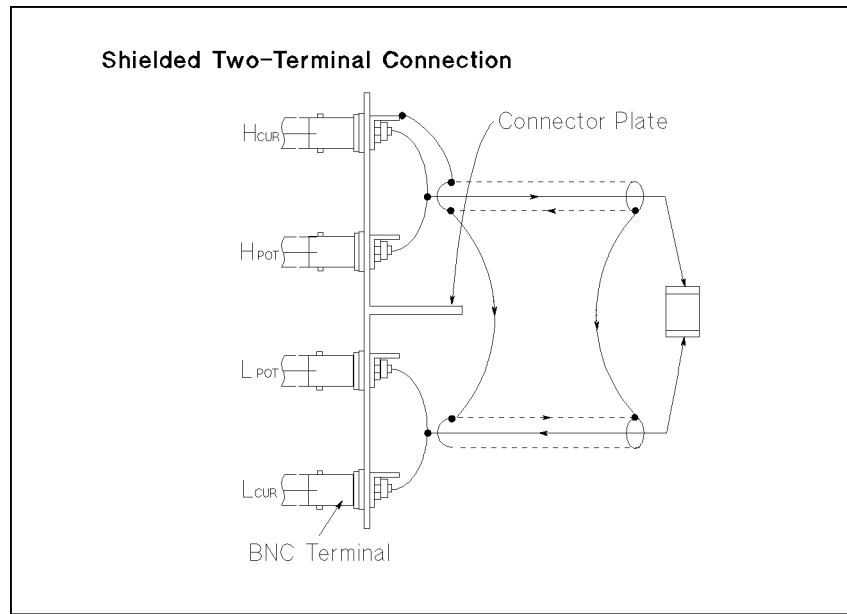

Figure 7-12. Measurement Contacts for Test Leads Extension

Guarding for Low Capacitance Measurements

Use a guard plate to minimize measurement errors caused by stray capacitance when measuring low capacitance values, such as low capacitance chip capacitors. Figure 7-13 shows an example of measurement contacts using a guard plate in the four-terminal pair measurement configuration.

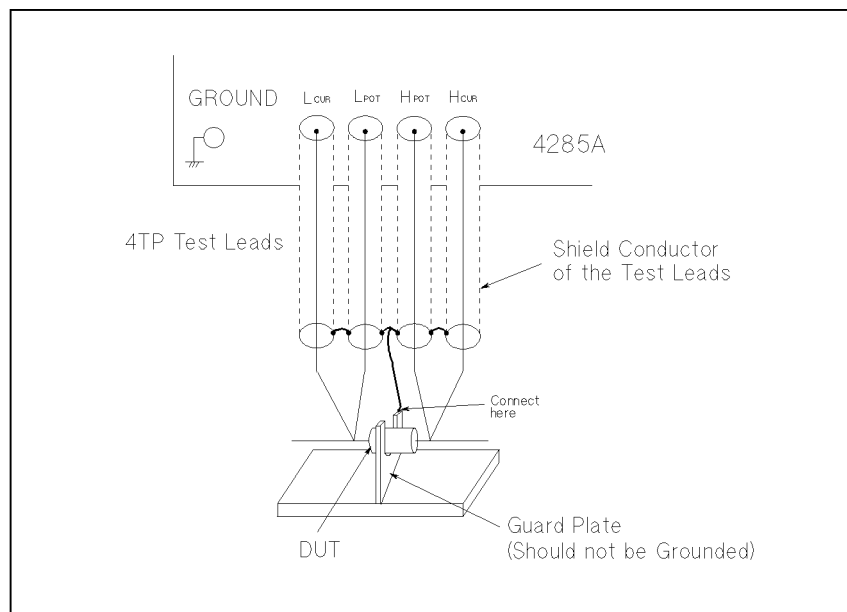

Figure 7-13. Example of DUT Guard Plate Connection

Shielding Shielding minimizes the effects of electrical noise picked up by the test leads. So, provide a shield plate and connect it to the outer shield conductors of the four-terminal pair test leads as shown in Figure 7-14.

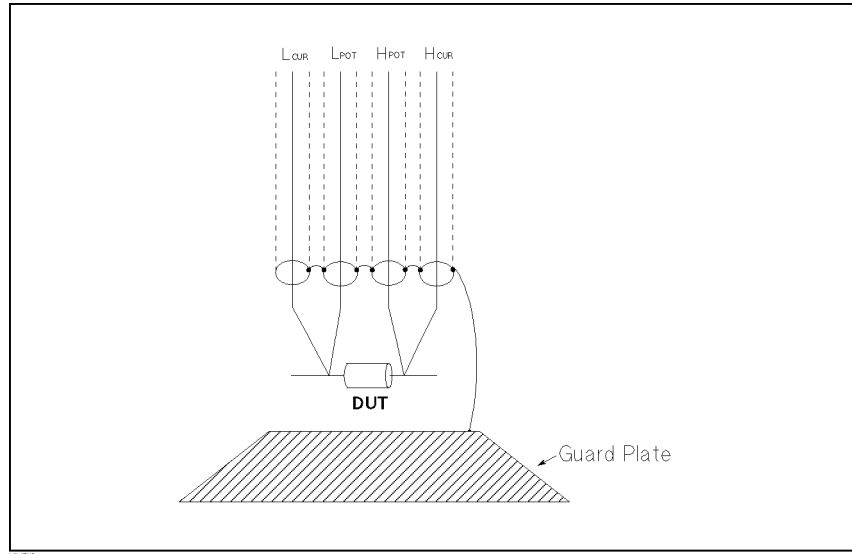

Figure 7-14. Guard Shield

Correction Functions

The 4285A has powerful correction functions, Cable Length correction, and OPEN, SHORT, and LOAD corrections. These correction functions are used to correct additional error due to the test fixture and the test leads. Table 7-2 lists the Correction functions with a brief description.

Table 7-2. Correction Functions

Correction Selection	Description	Typical Usage
Cable Length Correction	Correct phase shift error due to the 1 or 2 m test Leads.	<ul style="list-style-type: none"> • Measurements using the 16048A/D
OPEN Correction	Correct for stray admittance due to the test fixture.	<ul style="list-style-type: none"> • High impedance measurements
SHORT Correction	Correct for residual impedance due to test fixture.	<ul style="list-style-type: none"> • Low impedance measurements
OPEN/SHORT Correction	Correct the stray admittance and residual impedance due to the test fixture.	<ul style="list-style-type: none"> • Precise measurements
OPEN/SHORT/LOAD Correction	Correct any error due to the test fixture and test leads by using the standard.	<ul style="list-style-type: none"> • Measurements to be referenced to a standard • Measurements using a test fixture that has complicated impedance characteristics <p>For example, the 4285A combined with the scanner.</p>

- Simple measurements using an supplied direct connecting test fixture

In this case, LOAD correction is not required, OPEN/SHORT correction is enough to correct the residual errors.

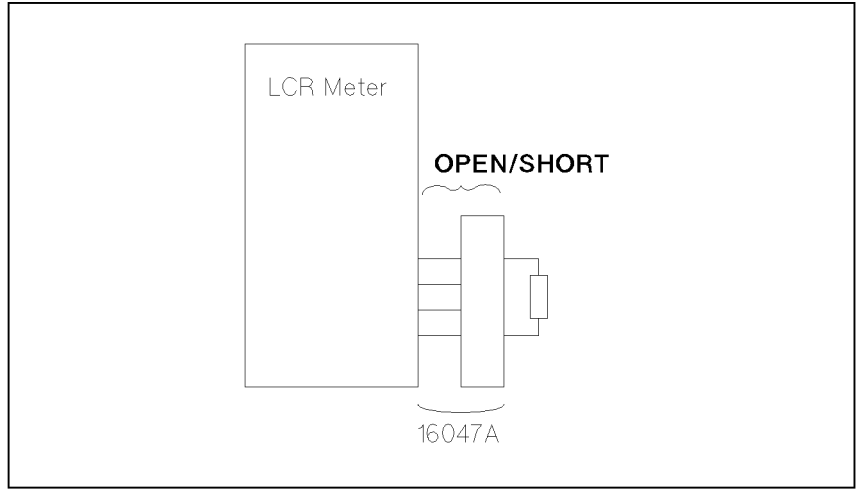

- Measurements using Agilent test leads and a test fixture.

In this case, CABLE LENGTH and OPEN/SHORT correction is used. Of course CABLE CORRECTION must be performed completely described in “Performing the Cable Correction Data Measurement” in Chapter 6.

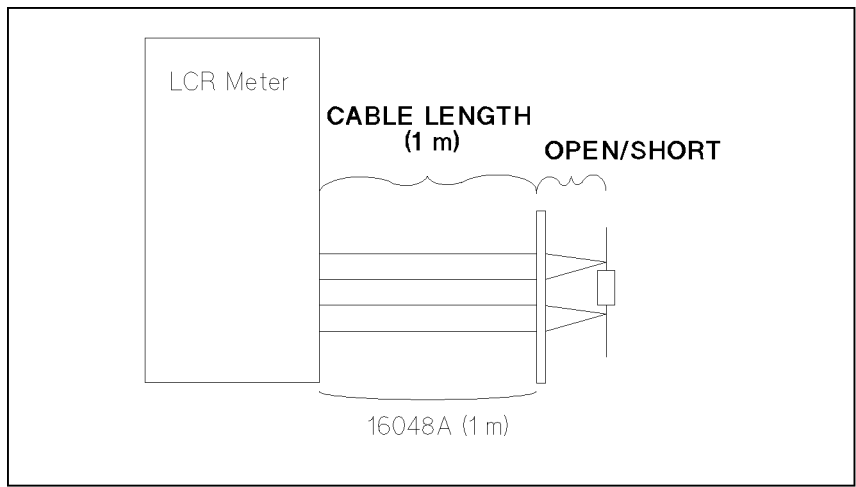

- Precise measurements to be referenced to a working standard.

Use the working standard as the LOAD reference DUT and perform the OPEN/SHORT/LOAD correction.

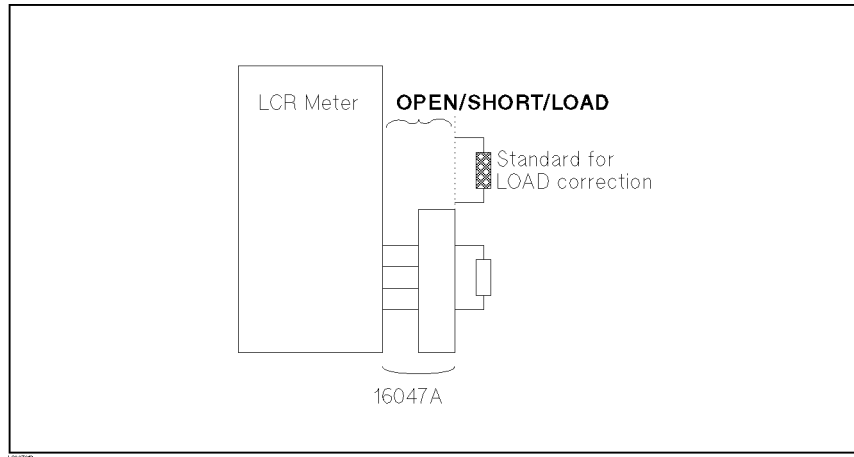

- Measurements using a test fixture that has complicated impedance characteristics.

In this case, use the OPEN/SHORT/LOAD correction. When you combine a scanner, the 4285A with Option 301 scanner interface provides powerful error correction functions for up to seven sets of OPEN/SHORT/LOAD correction data for ninety-channels.

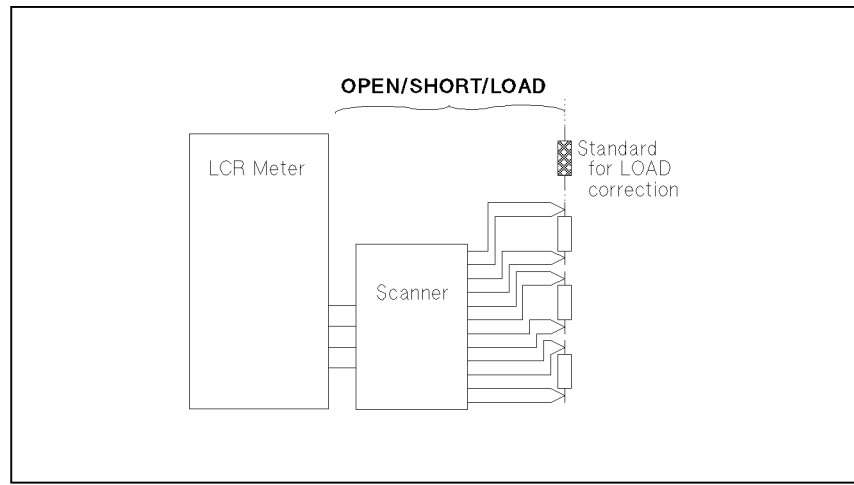

Performing OPEN Correction

To perform an OPEN correction data measurement, set up an OPEN condition, nothing is connected to the test fixture. When the OPEN measurement is being performed, don't touch or move your hands near the test fixture.

Performing SHORT Correction

To perform a SHORT correction data measurement, set up a SHORT condition, using a shorting bar to short between high terminal and low terminal of the *UNKNOWN* terminals.

Figure 7-15 shows a sample shorting bar (Agilent Part Number 5000-4226) for the 16047A/C/D test fixtures.

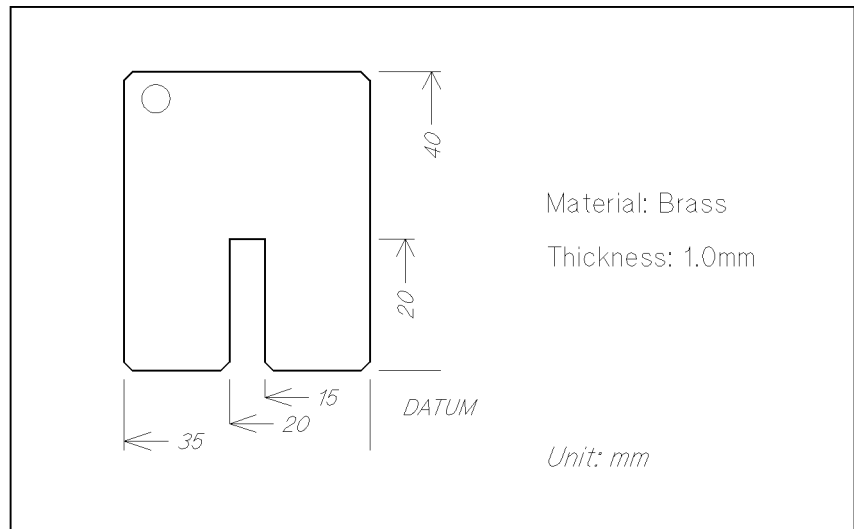

Figure 7-15. Sample Shorting Plate

The shorting bar should have very low residual impedance, so a high conductivity metal plate that is not easily corroded, is recommended for the shorting plate. (It must be clean.)

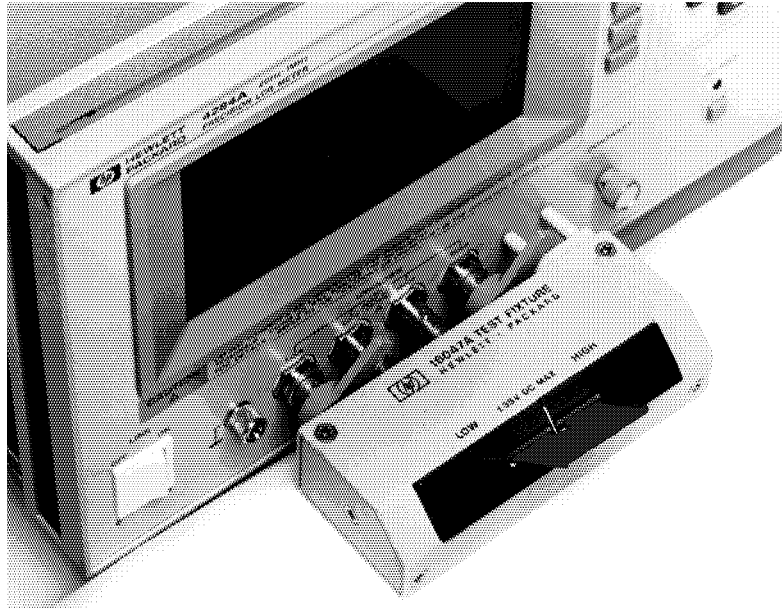

Figure 7-16. Shorting Plate Connection

Performing LOAD Correction

To perform a LOAD correction data measurement, connect the LOAD standard to the measurement contacts.

Preparing the Standard

It is necessary to prepare the working standard, such as a standard resistor and standard capacitor. It is recommended that you select a standard whose impedance is as close as possible to DUT's impedance. The following are recommendations for selecting standards.

- For capacitance measurements:
 - A standard capacitor whose capacitance is nearly equal to the DUT capacitance.
- For resistance measurements:
 - A standard resistor whose resistance is nearly equal to DUT's resistance.
- For inductance measurements:
 - A standard inductor whose inductance is nearly equal to DUT's inductance.

Reference Values for the LOAD Standard

Enter the specified reference values of the standard as the *REF A* and *REF B* values using the appropriate function on the *CORRECTION* page. For example, When using a standard capacitor which has a specified parallel capacitance and D values, enter the specified parallel capacitance value as the *REF A* value and the specified D value as the *REF B* value with C_p -D function.

Note



If the REF A and REF B values are entered with the C_p -D function, measurements with other functions (such as the $|Z|$ - θ function) can be performed.

Using the Pre-Measured Device for the LOAD

Even if your standard has no specified reference values, you can perform a LOAD correction using a device such as a general purpose capacitor or resistor. The pre-measured values of a device are used for the *REF A* and *REF B* values. Follow the procedure shown in below to use a device for the LOAD standard.

1. Prepare a device, whose impedance is as close as possible to the DUT's impedance, for the LOAD standard.
2. If the device has BNC connectors constructed in the four-terminal pair configuration, measure the device directly, do not use a test fixture (connect it directly to the 4285A).

If the device does not have four-terminal pair measurement terminals, measure the device using a direct coupling test fixture (such as the 16047A/C/D).

3. On the *CORRECTION* page, enter the measured values obtained in step 2 as the *REF A* and *REF B* values with the function used in step 2.

Parasitic Components Related to DUT Connection

You should consider that some parasitic components remain in measurement path even after performing corrections, as follows.

Figure 7-17 shows parasitic impedance model after corrections performed using the 16047A/C/D test fixture. In this case, to minimize the influence of parasitic components on the measurement values, insert the DUT completely into the test fixture (keep the leads of the DUT as short as possible).

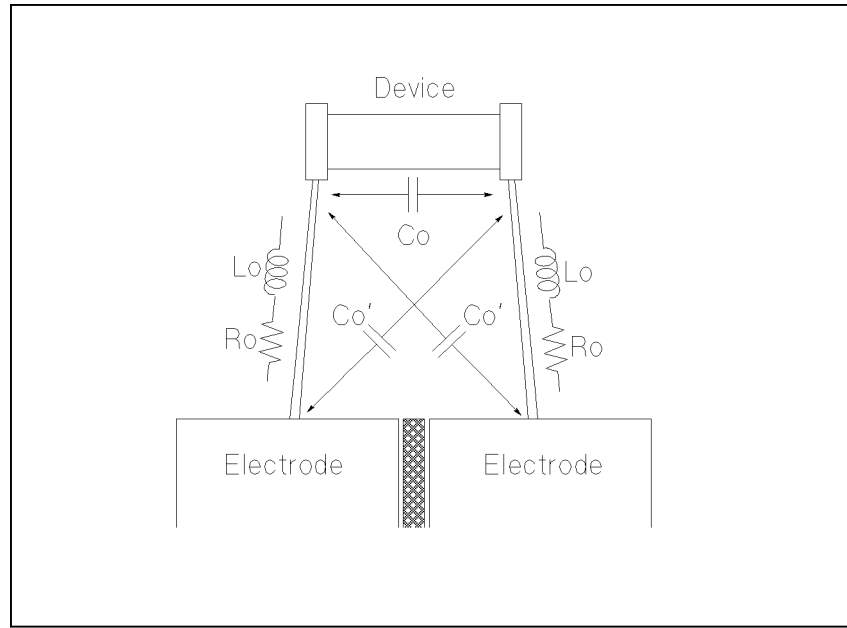

Figure 7-17.
Parasitic Impedance Model (Using the 16047A/C/D or 16034E)

- L_o : Residual inductance in DUT lead
- R_o : Lead resistance in DUT lead
- C_o : Stray capacitance

Characteristics Example

Figure 7-18 shows typical characteristics of various components.

As can be seen in the figure, a component may have different effective parameter values dependent upon its operating conditions. The measured values most useful in actual applications are obtained from precise measurement under the actual operating conditions.

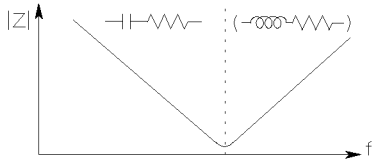
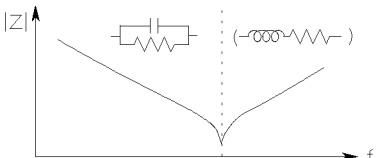
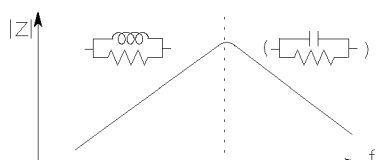
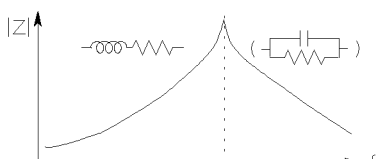
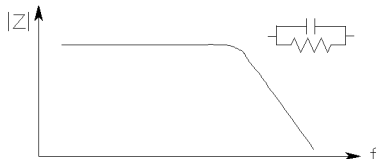
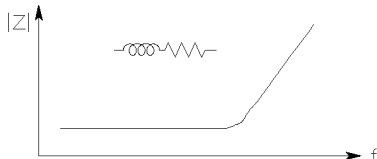
DUT	Characteristics Example	Measurement Functions
Large C		Cs-Rs, Cs-D, Cs-Q, R-X, $ Z -\theta$
Small C		Cp-D, Cp-G, G-B, $ Y -\theta$
Large L		Lp-Rp, Lp-D, Lp-Q, G-B, $ Y -\theta$
Small L		Ls-Rs, Ls-D, Ls-Q, R-X, $ Z -\theta$
Large R		Cp-Rp, G-B, $ Y -\theta$
Small R		Ls-Rs, R-X, $ Z -\theta$

L2007017

Figure 7-18. Typical Characteristics of Components

Remote Control

Introduction

This chapter provides the following information to remotely control the 4285A via the General Purpose Interface Bus (GP-IB).

- Reference information for programming the 4285A
- Introduction to the Test and Measurement System Language (TMSL)
- Tutorial information for the TMSL programmer

General Purpose Interface Bus (GPIB)

GPIB is Agilent Technologies's implementation of IEEE standard 488.1-1987. And IEEE standard 488.1-1987 is identical to the original IEEE standard 488-1978.

GPIB Connection

When configuring an GPIB system, the following restrictions must be adhered to.

- The total length of cable in one bus system must be less than or equal to two meters times the number of devices connected on the bus (the GPIB controller counts as one device) and the total length of cable must not exceed 20 meters.
- A maximum of 15 devices can be connected on one bus system.
- There are no restrictions on how the cables are connected together. However, it is recommended that no more than four piggyback connectors be stacked together on any one device. The resulting structure could exert enough force on the connector mounting to damage it.

For example, a system containing six devices can be connected together with cables that have a total length of less than or equal to 12 meters (six devices \times 2m/device = 12 meters). The individual length of cable may be distributed in any manner desired as long as the total length does not exceed the allowed maximum. If more than ten devices are to be connected together, cables shorter than two meters must be used between some of the devices to keep the total cable length less than 20 meters.

Figure 8-1 shows an GPIB interface connector. The 4285A uses all of the available GPIB lines; therefore, damage to any connector pin will adversely affect its GPIB operation.

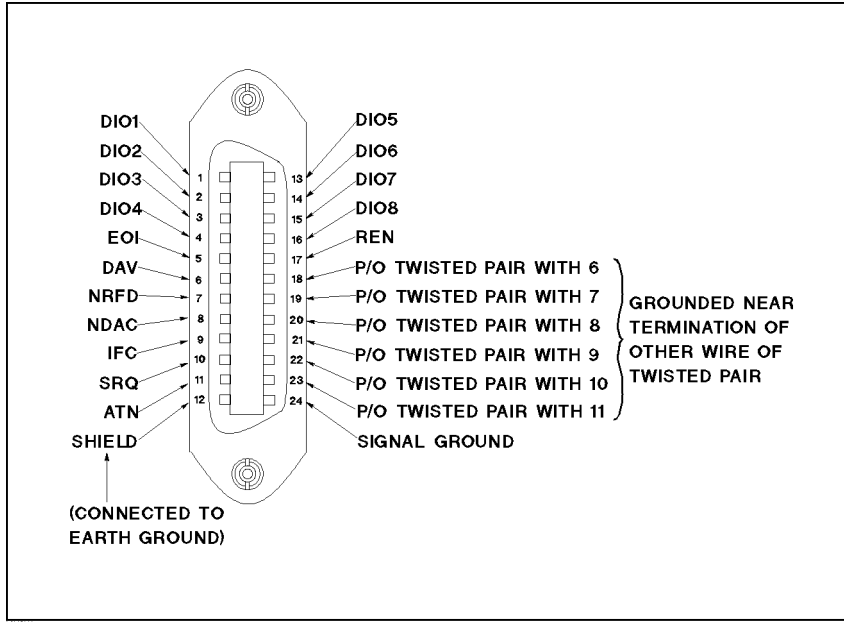

Figure 8-1. GPIB Connector Signal/Pin Configuration

Table 8-1. GPIB Interconnect Cables

Agilent Part Number	Length
10833A	1 m (3.3 ft)
10833B	2 m (6.6 ft)
10833C	4 m (13.2 ft)
10833D	0.5 m (1.6 ft)

Typical GPIB system interconnection is shown in Figure 8-2. The GPIB connector is firmly fastened using two bolts to keep it from working loose during use.

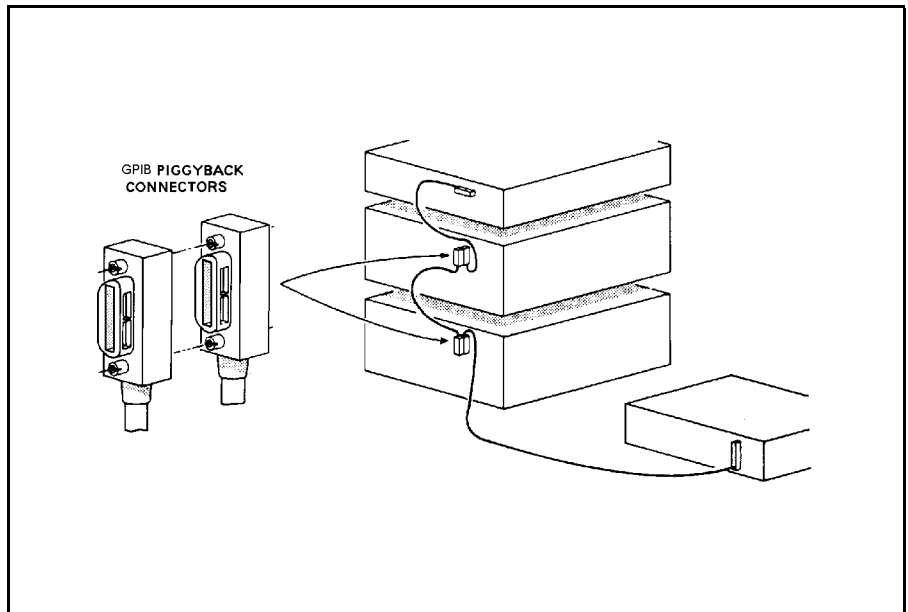

Figure 8-2. Typical GPIB System Interconnection

GPIB Capability

Table 8-2 lists the 4285A's GPIB capabilities and functions. These functions provide the means for an instrument to receive, process, and transmit, commands, data, and status over the GPIB bus.

Table 8-2. GPIB Interface Capability

Code	Function
SH1	Complete Source Handshake capability
AH1	Complete Acceptor Handshake capability
T5	Basic Talker; serial poll; unaddressed if MLA; Talk-Only
L4	Basic Listener; unaddressed if MTA; no Listen Only
SR1	Service Request capability
RL1	Remote/Local capability
DC1	Device Clear capability
DT1	Device Trigger capability
C0	No Controller capability
E1	Drivers are open-collector

GPIB Addressing

The 4285A's GPIB address is stored in non-volatile memory and can be set to any address from 0 to 30 by front panel key entry in the *SYSTEM CONFIG* page. When the 4285A is shipped from the factory the default GPIB address is 17.

GPIB Bus Capability

The 4285A will respond to the following bus commands which are given as HP 9000 series 200/300 BASIC statements.

ABORT I/O (IFC)

ABORT I/O (IFC control line TRUE) halts all bus activity and deselects the 4285A.

For example:

```
ABORT 7
```

CLEAR LOCKOUT/SET LOCAL

CLEAR LOCKOUT/SET LOCAL (REN control line false) releases devices on the bus from the lockout mode and returns them to local (front panel) control. The difference between CLEAR LOCKOUT/SET LOCAL, and LOCAL is in the addressing method used.

For example:

```
LOCAL 7
```

DEVICE CLEAR (SDC or DCL)

This command can be used with an address to clear a particular device (SDC : selected device clear) or used without an address (DCL : clears all devices). The 4285A will initialize the following items only when it receives this command. Then the:

- Input buffer is cleared
- Output data buffer is cleared
- Bit 4 (MAV bit) of the status byte is set to "0"

For example:

```
CLEAR 7
```

LOCAL (GTL)

LOCAL returns control of a listening device to front panel control.

For example:

```
LOCAL 717
```

LOCAL LOCKOUT (LLO)

LOCAL LOCKOUT disables the LOCAL operation (4285A : Pressing (LCL)) of all devices on the bus. After this command is sent you will be unable to operate the 4285A from the front panel. Execute the LOCAL command to undo LOCAL LOCKOUT.

For example:

```
LOCAL LOCKOUT 7
```

REMOTE

REMOTE sets the 4285A to the remote mode. When this command is sent, front panel with the exception of (LCL) will be disabled.

For example:

```
REMOTE 717
```

SPOLL

SPOLL is the serial polling command. SPOLL is used to place the status byte of the addressed instrument on the bus. The eight bits of the status byte can be masked off and read to determine the 4285A's operating state.

For example:

```
Var=SPOLL(717)
```

SERVICE REQUEST

The 4285A can send an SRQ (Service Request) control signal when it requires the controller to perform a task. An SRQ can be thought of as an interrupt which informs the controller that information is ready to be transmitted, or that an error condition exists in the instrument. When the 4285A sends an SRQ it also sets Bit 6 of the status byte. Bit 6 is the RQS (Request Service) bit, sometimes referred to as the *status bit* in connection with polling. When the 4285A is serially polled, it clears the RQS bit and the SRQ line, one of the five management control lines of the system interface. Any bit in the status byte can initiate an SRQ. The status byte may be masked by the user to determine which bits caused the 4285A to set the SRQ line. For more information on the status byte, refer to "Status Byte".

TRIGGER (GET)

Enables the 4285A to the TRIGGER bus command. This command may be sent to a selected device or to all devices addressed as listeners on the GPIB bus. The 4285A must first be addressed as a listener, second the trigger mode is set to the BUS trigger mode before the trigger message is sent.

For example:

```
SEND 7;UNL MTA LISTEN 17  
TRIGGER 7
```

Test and Measurement Systems Language (TMSL)

Test and Measurement Systems Language (TMSL) is the new universal command set adopted by Agilent Technologies for test and measurement instrumentation by extending IEEE 488.2-1987. This language uses standard GPIB hardware and will be used in many future Agilent Technologies Products. TMSL uses easy to learn, self explanatory commands, and is flexible for both beginners and expert programmers. Detailed TMSL command descriptions are given in Chapter 9.

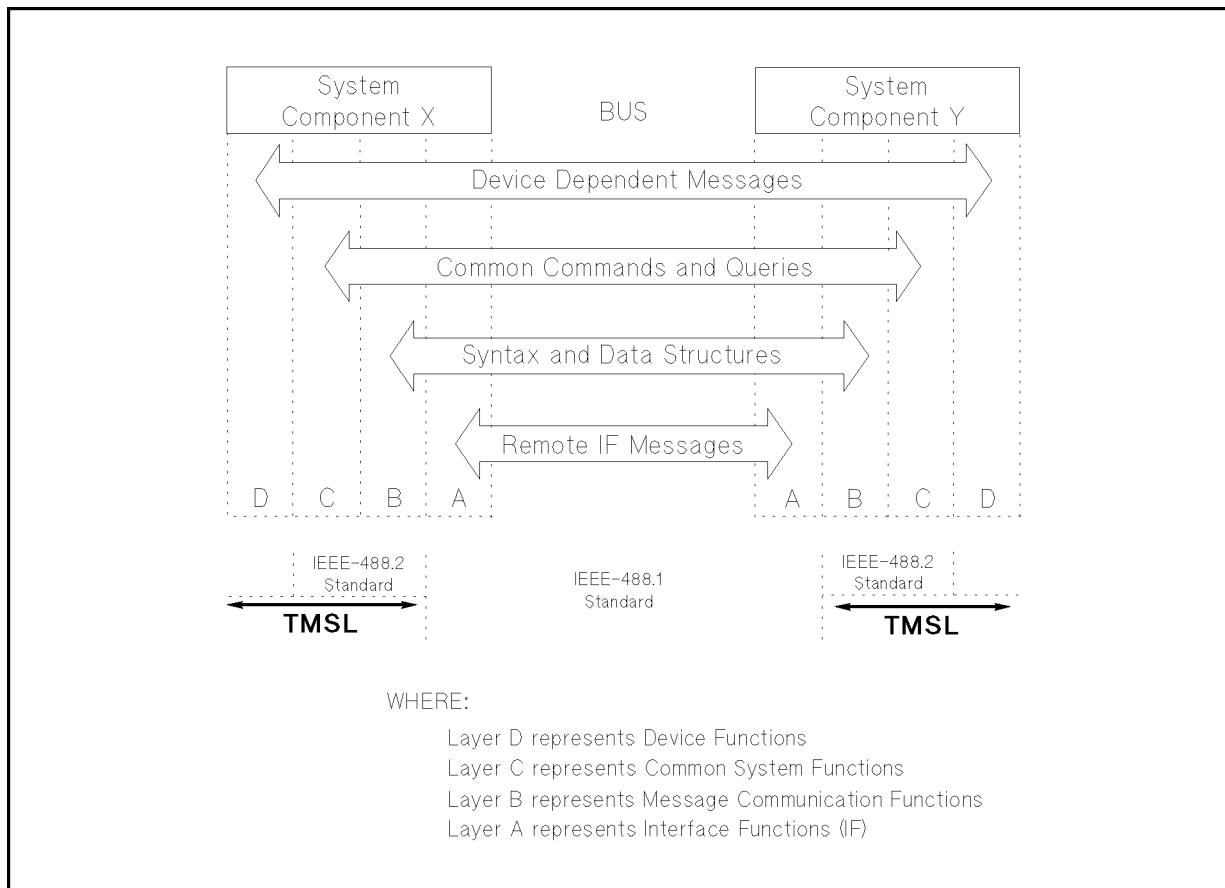

Figure 8-3. Functional Layers Diagram

Data Transfer

The 4285A offers two data formats for GPIB data transfer to the controller, ASCII and BINARY. The data transfer rates for these data formats are different.

ASCII Format

The ASCII data format is the default output format. When the `FORMat:DATA ASCii` command is executed, the 4285A transfers data in the ASCII format. The ASCII data output format on the MEAS DISPLAY, BIN No. DISPLAY, or *BIN COUNT DISPLAY* page is described in Figure 8-4.

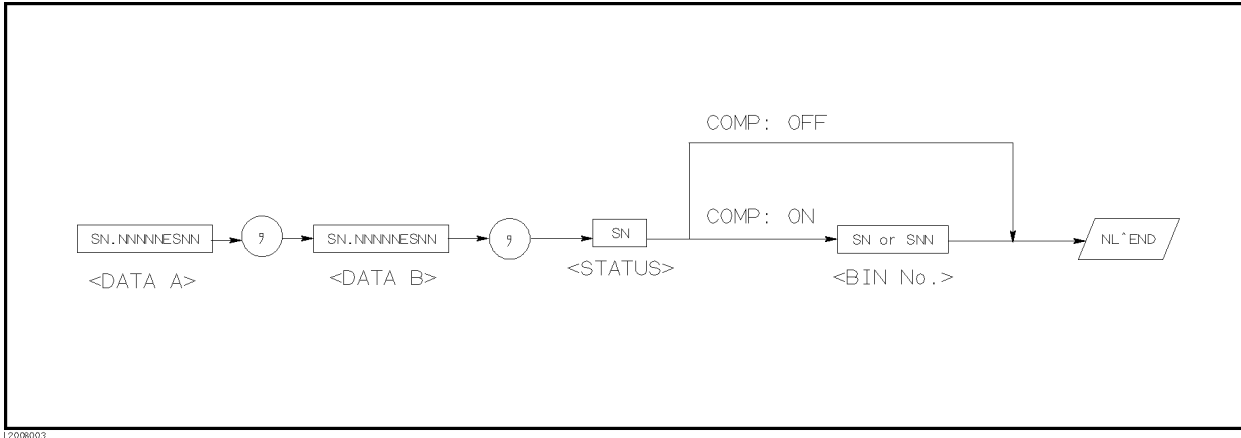

Figure 8-4. ASCII Format 1

The `<DATA A>`, `<DATA B>`, `<STATUS>`, and `<BIN No.>` formats are as follows.

- `<DATA A>` and `<DATA B>` format:

The data output formats for `<DATA A>` (primary parameter's measurement data), and `<DATA B>` (secondary parameter's measurement data) uses the 12 ASCII character fixed length format as follows.

SN.NNNNNESNN
(S: +/-, N: 0 to 9, E: Exponent Sign)

- `<STATUS>` Format:

The `<STATUS>` data shows the measurement status when getting the measurement data as follows.

Status	Description
-1	No data (in the data buffer memory)
0	Normal measurement data.
+1	Analog bridge is unbalanced.
+2	A/D converter is not working.
+3	Signal source overloaded.
+4	ALC unable to regulate.

The data output formats for <STATUS> uses the 2 ASCII character fixed length format as follows.

SN (S: +/-, N: 0 to 4)

Note



When the <STATUS> is -1, 1, or 2, the measurement data is 9.9E37. When the <STATUS> is 0, 3, or 4, the actual measurement data is output.

■ <BIN No.> Format:

The <BIN No.> data shows the bin sorting results as follows.

Data	Sorting Results
0	OUT_OF_BINS
+1	BIN 1
+2	BIN 2
+3	BIN 3
+4	BIN 4
+5	BIN 5
+6	BIN 6
+7	BIN 7
+8	BIN 8
+9	BIN 9
+10	AUX_BIN

The <BIN No.> data is output with the measurement data only when the comparator function is set to ON.

The data output formats for <BIN No.> uses a 2 or 3 ASCII character data length format as follows.

SN or SNN (S: +/-, N: 0 to 9)

The ASCII data output format on the *LIST SWEEP DISPLAY* page is described in Figure 8-5. The data loop is repeated for the number of the sweep points.

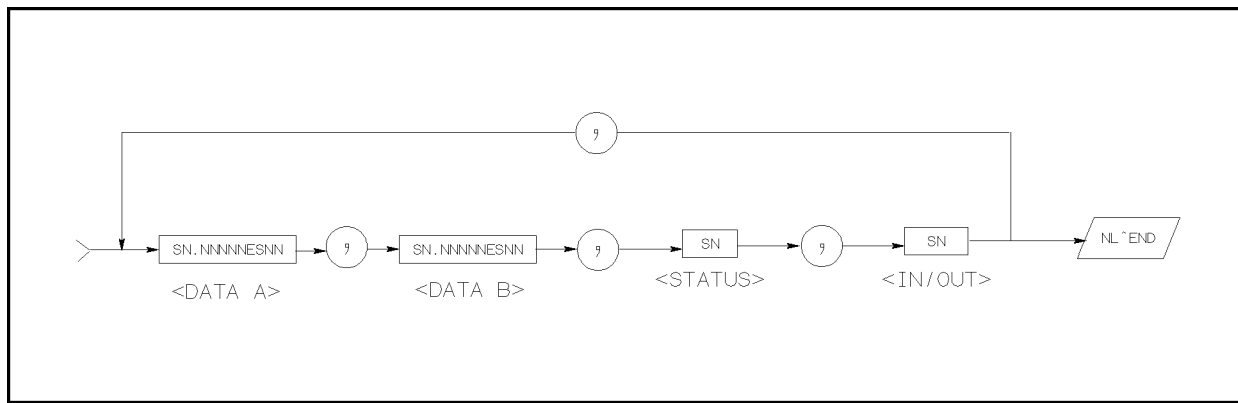

Figure 8-5. ASCII Format 2 (List Sweep)

The <DATA A>, <DATA B>, <STATUS> formats are the same as the formats on the MEAS DISPLAY, BIN No. DISPLAY, or *BIN COUNT DISPLAY* page. So the only the <IN/OUT> format will be described.

■ <IN/OUT> format:

The <IN/OUT> data shows the result of the list sweep's comparator function.

Data	Result
-1	LOW
0	IN
+1	HIGH

When the comparator function of the list sweep measurement isn't used, the <IN/OUT> data output result is 0 (zero).

The data output formats for <IN/OUT> use the 2 ASCII character fixed length format as follows.

SN (S: +/-, N: 0 to 1)

Binary Format

When the `FORMat:DATA REAL,64` command is executed the 4285A transfers data in the BINARY format. The BINARY format is the 64-bit floating point binary format specified in IEEE Standard 754-1985. This is the same data format used by the HP Technical computers, such as the HP 9000 series 200/300 computers. The BINARY data output format on the MEAS DISPLAY, BIN No. DISPLAY, or *BIN COUNT DISPLAY* page is shown in Figure 8-6.

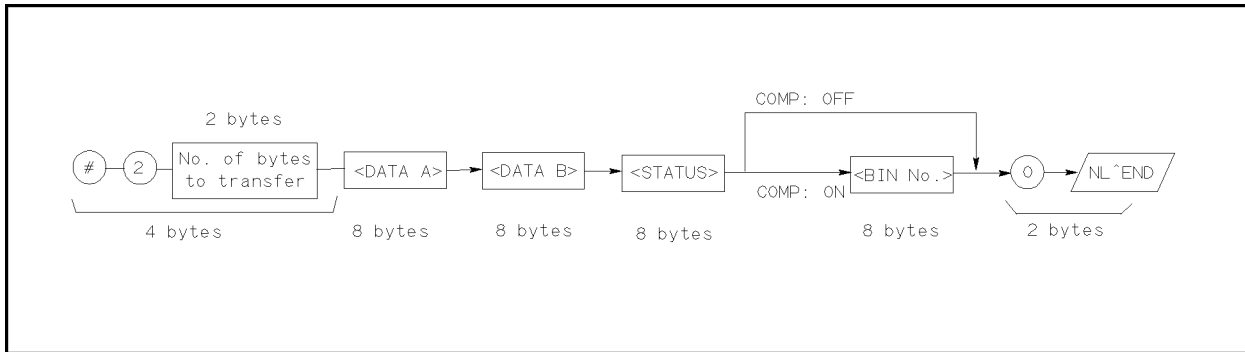

Figure 8-6. BINARY Format 1

This data field is initiated by a unique code, the number sign (#). A second byte, (2), designates the number of the bytes for the “No. of the bytes transfer”. “No. of the bytes transfer” designates the data byte length. The last byte is zero (0), and has no meaning. The response message terminator is, the EOI line is asserted while the New Line (Line Feed) character (10 decimal) is being sent on the bus.

Floating Point Format

Each data format of the <DATA A>, <DATA B>, <STATUS>, and <BIN No.> are common formats (8 bytes, IEEE 754 floating point format) as follows. The meaning of each data is the same as the meaning of each data in the ASCII format.

IEEE 754 Floating Point Format

Bit No.	7	6	5	4	3	2	1	0
First byte sent	S	E _{msb}	E	E	E	E	E	E
Second byte sent	E	E	E	E _{lsb}	F _{msb}	F	F	F
Third - seventh byte sent	F	F	F	F	F	F	F	F
⋮	⋮	⋮	⋮	⋮	⋮	⋮	⋮	⋮
Last byte sent	F	F	F	F	F	F	F	F _{lsb}

Where,

- E_{msb} : is the most significant bit of the exponent.
- E_{lsb} : is the least significant bit of the exponent.
- F_{msb} : is the most significant bit of the fractional part.
- F_{lsb} : is the least significant bit of the fractional part.
- S : is the sign bit.
- E : is an exponent bit.
- F : is a fraction bit.

The real number RN represented in floating point format are provided using the following formula. (EXP: Exponent part of number, f: Fractional part of number)

- When $0 < e < 1111111111$ (2047)

$$RN = (-1)^S \times 2^{(EXP-1023)} \times (1 + f/2^{52})$$

- When $e = 0$

$$RN = (-1)^S \times 2^{-1022} \times (f/2^{52})$$

- When $e = 0, f = 0,$

$$RN = 0$$

For example,

$$S = 1$$

$$EXP = 0111111111 \text{ (1023 decimal)}$$

$$f = 1000\ 00000000\ 00000000\ 00000000\ 00000000\ 00000000\ 00000000\ 00000000\ (2^{51})$$

$$RN = (-1)^1 \times 2^{(1023-1023)} \times \left(1 + \frac{2^{51}}{2^{52}}\right)$$

$$= -1 \times 1 \times 1.5$$

$$= -1.5$$

When the list sweep measurement is performed, the binary data format is as follows. <DATA A>, <DATA B>, <STATUS>, and <IN/OUT> are repeated as many times as there are sweep points. Each data format is the same as the 8-byte data format described in the “Floating Point Format”. The meaning of each data is the same as each data in the ASCII format.

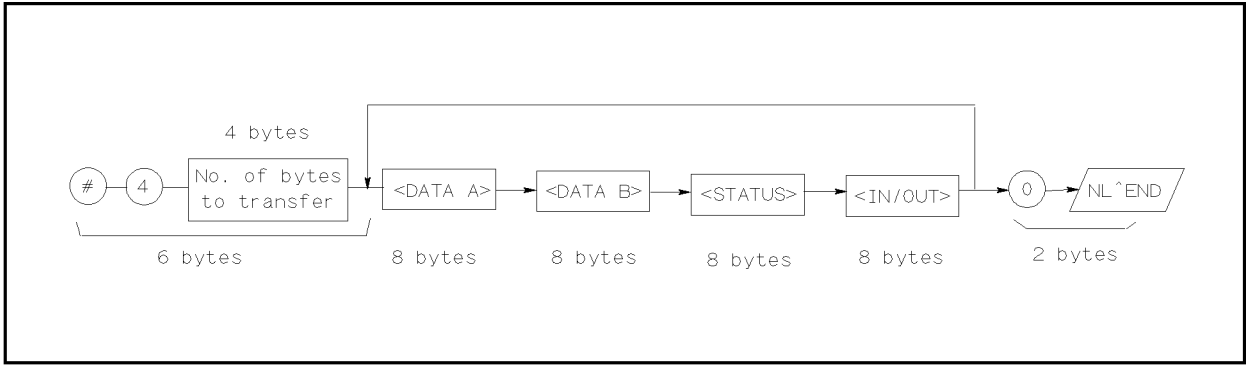

Figure 8-7. Binary Data Format For List Sweep Measurement

Trigger System Figure 8-8 shows the 4285A trigger state diagram when in REMOTE.

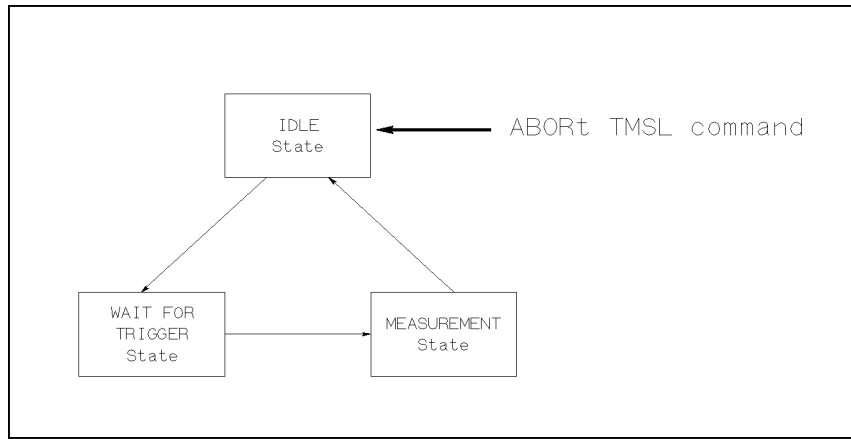

Figure 8-8. Trigger State Diagram

Each GPIB trigger state is described in the following paragraphs.

■ IDLE state

During the IDLE state, the measurement data can be read by a controller via GPIB using the FETCh? query. To change the IDLE state to the WAIT FOR TRIGGER state, the INITiate subsystem command must be used as shown in Figure 8-9.

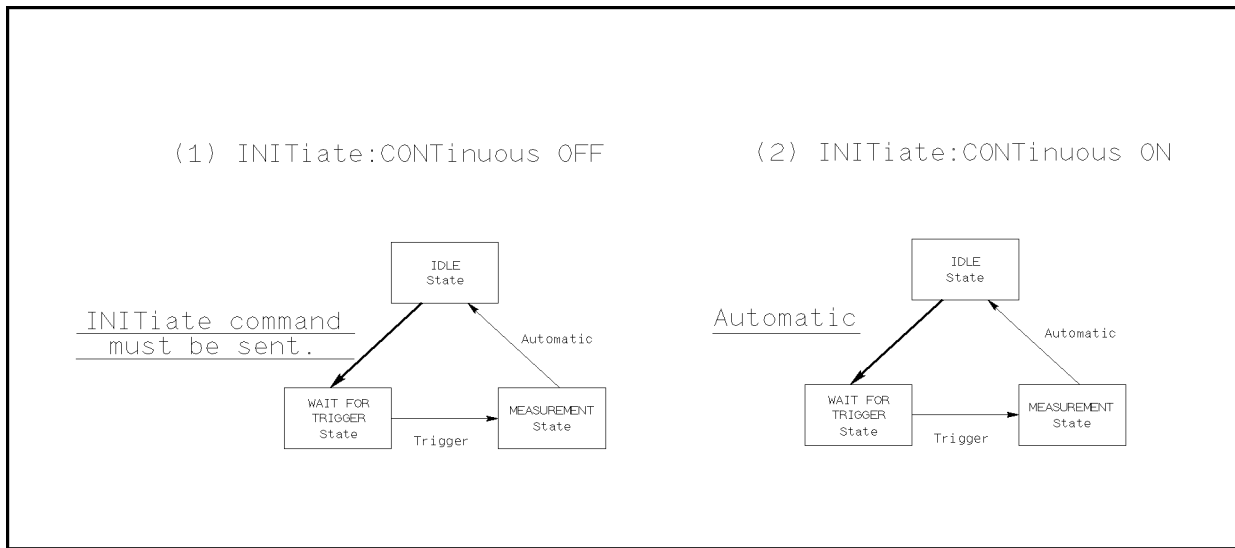

Figure 8-9. INITiate Subsystem Commands and Trigger System

There are the following two conditions for the INITiate subsystem commands.

1. INITiate:CONTInuous OFF condition

In this condition, the INITiate:IMMediate command must be sent via GPIB to change the IDLE state to the WAIT FOR

TRIGGER state after reading the measurement data by a controller.

2. INITiate:CONTInuous ON condition

In this condition, the IDLE state is automatically changed to the WAIT FOR TRIGGER state without using the INITiate:IMMediate command after reading the measurement data by a controller.

Note



When the ABORt command is sent under any state, the 4285A state is forced to the IDLE state. In this condition there are no data stored in the 4285A. If the FETCh? query is sent in this case, an error (error message -230: "Data corrupt or stale") will occur.

■ WAITING FOR TRIGGER state

In this state, the 4285A can accept a trigger command while in the remote condition. When the trigger command is sent to the 4285A, the state is automatically changed to the MEASUREMENT state.

There are three kinds of the trigger commands: *TRG common command, Group Execution Trigger (GET) bus command, and TRIGger:IMMediate TMSL command. These commands are divided into two types in this trigger system. (Refer to Figure 8-10.)

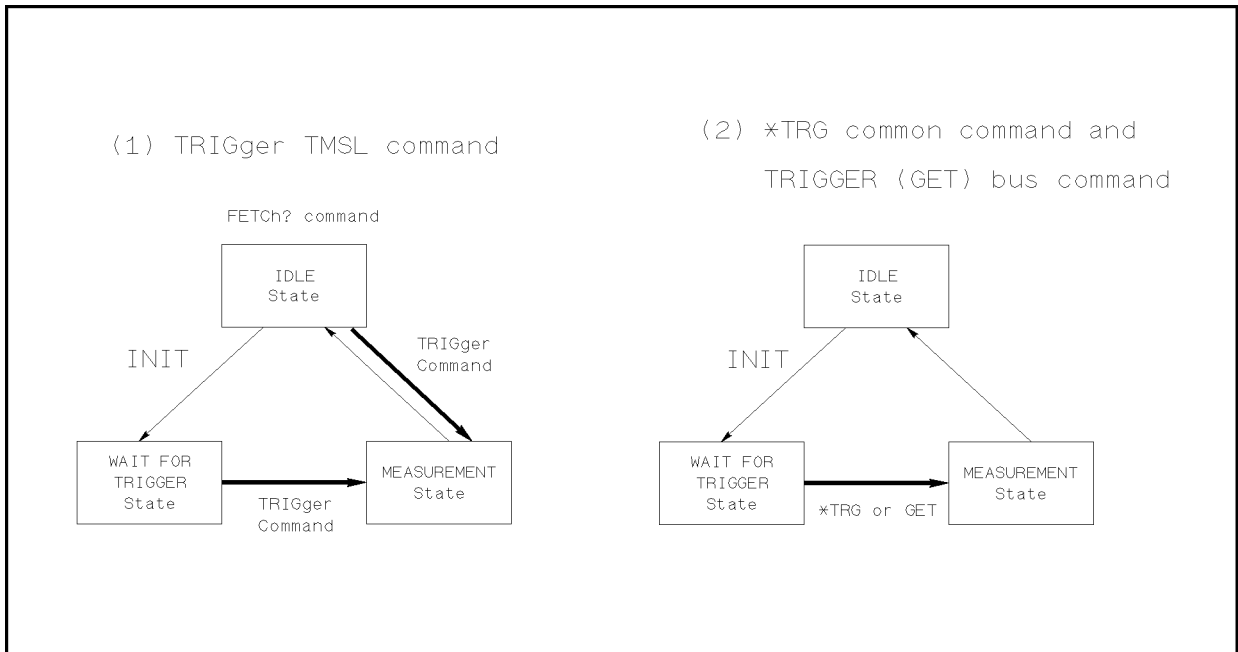

Figure 8-10. Trigger System and Trigger Commands

1. TRIGger:IMMediate TMSL command

Either the WAIT FOR TRIGGER state or the IDLE state, the 4285A is triggered by sending the TRIGger:IMMediate command. When the measurement results can be read by a

controller under the IDLE state, the FETCh? command must be used.

2. *TRG common command or Group Execution Trigger (GET) bus command

In the WAIT FOR TRIGGER state, the 4285A is triggered by sending the *TRG common command or GET bus command, and the measurement results in one trigger sequence can be read without sending the FETCh? command under the IDLE state. Thus,

“*TRG” = “TRIGger:IMMediate;:FETCh?”

Figure 8-11 and Figure 8-12 shows the difference between the TRIGger:IMMediate command and *TRG or GET command by using the sample programs.

```
10    ASSIGN @Meter TO 717
20    REMOTE @Meter
30    OUTPUT @Meter;"*RST;*CLS"
40    OUTPUT @Meter;"TRIG:SOUR BUS"
50    OUTPUT @Meter;"ABORT;:INIT"
60    OUTPUT @Meter;"TRIGGER:IMMEDIATE"
70    OUTPUT @Meter;"FETCh?"
80    ENTER @Meter;A,B,C
90    PRINT A,B,C
100   END
```

Figure 8-11. TRIGger:IMMediate Command Sample Program

```
10    ASSIGN @Meter TO 717
20    REMOTE @Meter
30    OUTPUT @Meter;"*RST;*CLS"
40    OUTPUT @Meter;"TRIG:SOUR BUS"
50    OUTPUT @Meter;"ABORT;:INIT"
60    OUTPUT @Meter;"*TRG"
70    ENTER @Meter;A,B,C
80    PRINT A,B,C
90    END
```

Figure 8-12. *TRG or GET Command Sample Program

Note



When the 4285A is set to the EXT TRIG mode, and is triggered via the EXT TRIGGER connector or an optional interface under the remote condition, this trigger signal has the same effect as the TRIGger:IMMediate TMSL command.

■ MEASUREMENT state

In this state, DUT measurement is being performed. After the DUT measurement is completed, trigger state automatically changes to the IDLE state.

Note



The 4285A can only measure a DUT on one page of the *MEAS DISPLAY, BIN No. DISPLAY, BIN COUNT DISPLAY, and LIST SWEEP DISPLAY* pages under the DISPLAY FORMAT even if the 4285A is in remote.

A typical flowchart of data transfer using the trigger system is shown below.

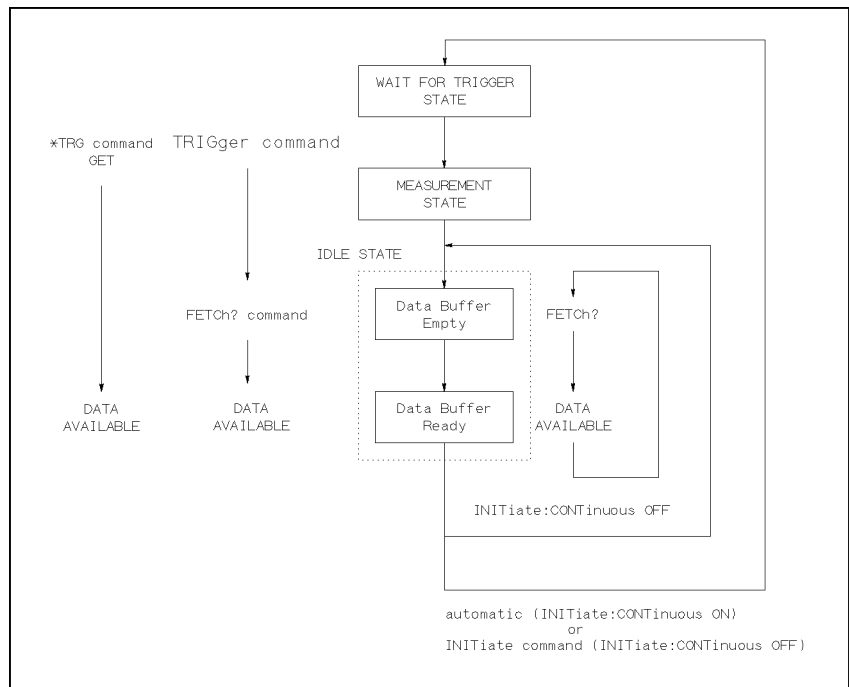

Figure 8-13. Triggering System and Data Transfer

Data Buffer Memory

The 4285A has data buffer memory capability. The data buffer memory can hold up to 128 sets of measurement results, and all buffered measurement results are transferred at once to the controller using the `MEMory:READ? DBUF` command as shown in Figure 8-14. So the overall data transmission time will be greatly reduced.

```

10    OPTION BASE 1
20    DIM D(5,4)
30    ASSIGN @Meter TO 717
40    REMOTE @Meter
50    OUTPUT @Meter;"*RST;*CLS"
60    OUTPUT @Meter;"FORM ASCII"
70    OUTPUT @Meter;"TRIG:SOUR BUS"
80    OUTPUT @Meter;"DISP:PAGE MEAS"
90    OUTPUT @Meter;"MEM:DIM DBUF,5"
100   OUTPUT @Meter;"MEM:FILL DBUF"
110   FOR I=1 TO 5
120     OUTPUT @Meter;"TRIGGER:IMMEDIATE"
130   NEXT I
140   OUTPUT @Meter;"MEM:READ? DBUF"
150   ENTER @Meter;D(*)
160   PRINT D(*)
170   OUTPUT @Meter;"MEM:CLE DBUF"
180   END

```

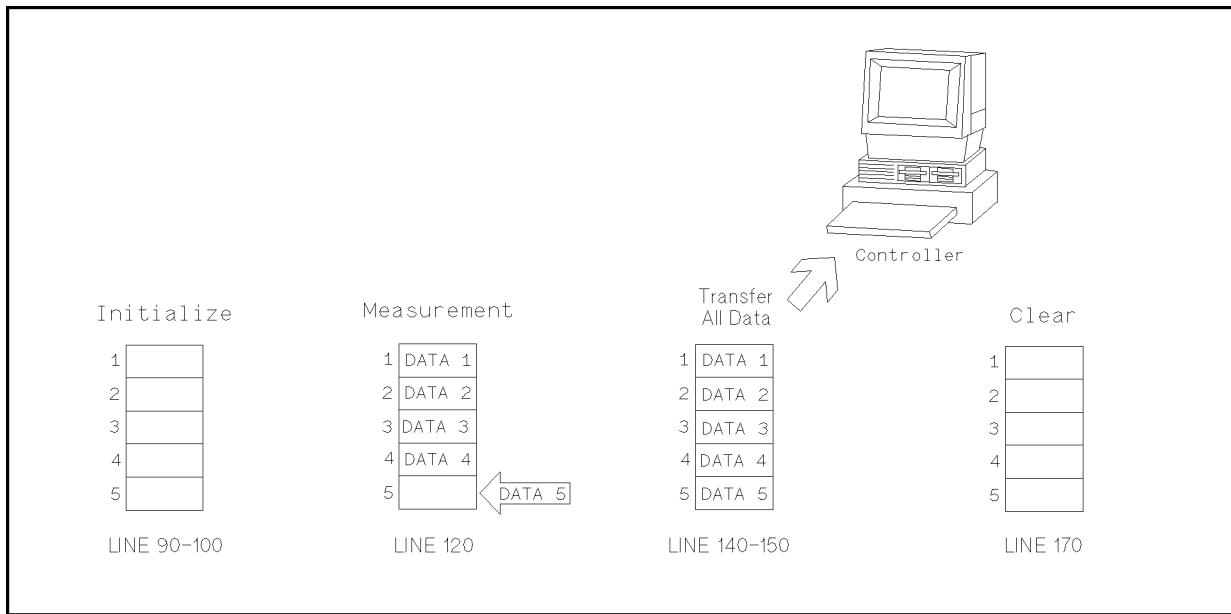

L2008011

Figure 8-14. Buffered Data Transfer Sample Program and Description

Note



When the data buffer memory is used, use the following rules.

- The measurement data after sending the `MEMory:FILL DBUF` command to use the data buffer memory capabilities are stored into the data buffer memory in the order measured.
- When triggering the 4285A using the `TRIGger:IMMediate` command, the measurement results are entered only into the data buffer memory. So you don't have to clear the output buffer. When triggering using the `*TRG` or `Group Execution Trigger (GET)` command, the measurement results are entered into both the data buffer memory and the output buffer. So the output buffer must be cleared every time the 4285A's controller reads the measurement results. If you don't, error (-410, "Query INTERRUPTED") will occur.
- When the number of sets of measurement data exceeds the capacity of the buffer memory, all of the overflowed measurement data are lost, error 90: "Data Memory Overflow" occurs, and bit 3 of the standard event status register is set to 1. If you enter new data into the data buffer memory, the data buffer memory should first be cleared using the `MEMory:CLEAr DBUF` command.
- When the number of sets of measurement data is less than the capacity of the buffer memory, the following data, instead of the actual measurement data, are input to the unused portion of the data buffer memory.

<DATA A>:	9.9E37
<DATA B>:	9.9E37
<STATUS>:	-1
<BIN No.> or <IN/OUT>:	0

- When the data buffer memory capabilities are used during a list sweep measurement, the measurement result of one sweep point is stored as one set of measurement data. So when two or more sweep points are the same, and are adjacent, the 4285A measures the device once, but the number of data sets stored is equal to the number of sweep points.
- When the limit function of the list sweep measurement is set to OFF at a sweep point, <IN/OUT> is 0. Also when the comparator function is set to OFF, the <BIN No.> is 0.

There are two formats returned by `MEMory:READ? DBUF` query, ASCII and BINARY. Each format is described below. (The sample programs using the data buffer memory (returned format: ASCII and BINARY) are shown later in this chapter.)

■ ASCII Format

When the ASCII format is selected as a data format, the returned format is as follows. The <DATA A>, <DATA B>, <STATUS>, <BIN No.>, or <IN/OUT> data format and meaning are the same as the ASCII data format described in "ASCII Format".

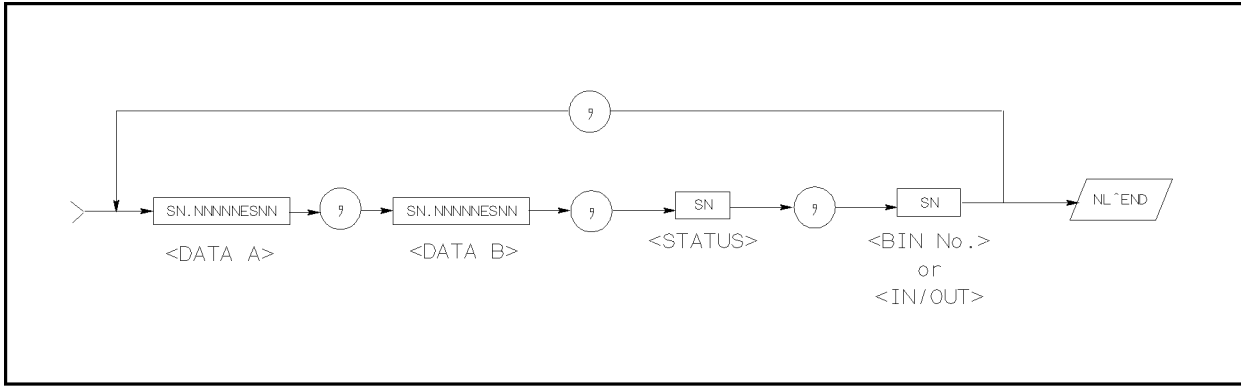

Figure 8-15. ASCII Format (Buffer Memory)

■ **BINARY Format**

When the BINARY format is selected as the data format, the returned format is as follows. The <DATA A>, <DATA B>, <STATUS>, <BIN No.>, or <IN/OUT> data format and meaning are the same as the BINARY data format described in “Binary Format”.

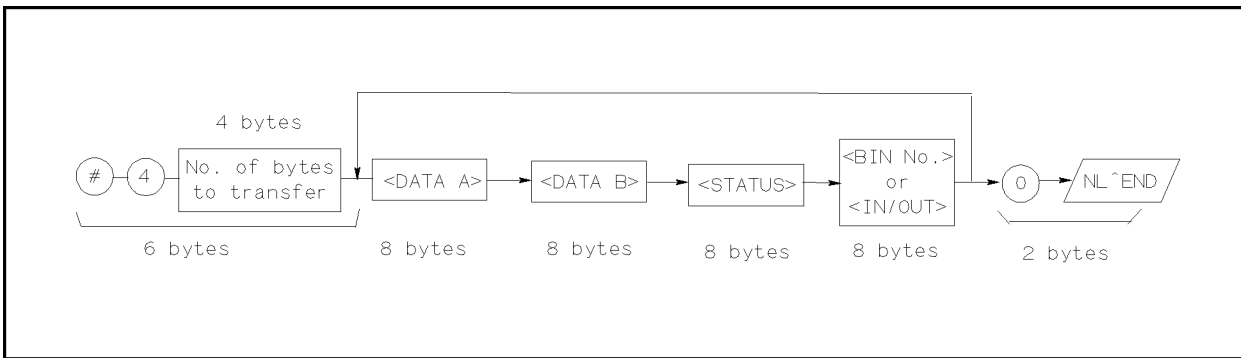

Figure 8-16. BINARY Format (Buffer Memory)

Each data format has a different data transfer rate. Table 8-3 shows the typical time required from sending the `FETCH?` command or the `MEM:READ? DBUF` command to enter the data using the `ENTER` command with an HP 9000 series 300 computer.

Table 8-3. Data Format and Data Transfer Time

Format	Data Type	Time
ASCII	Data without BIN No.	10 ms
	Data with BIN No.	11 ms
	List Sweep Data (10 points)	75 ms
	Data Buffer Memory (128 sets of data)	960 ms
BINARY	Data without BIN No.	8 ms
	Data with BIN No.	8.8 ms
	List Sweep Data (10 points)	34 ms
	Data Buffer Memory (128 sets of data)	406 ms

Status Byte

The status byte register contains an 8-bit word that the 4285A places on the GPIB bus when it is serially polled.

The value of each bit indicates the status of an internal 4285A function, and two bits of the status byte are used as the summary bits of the registers (Refer to Figure 8-17). Bits are set to “1” and reset to “0”.

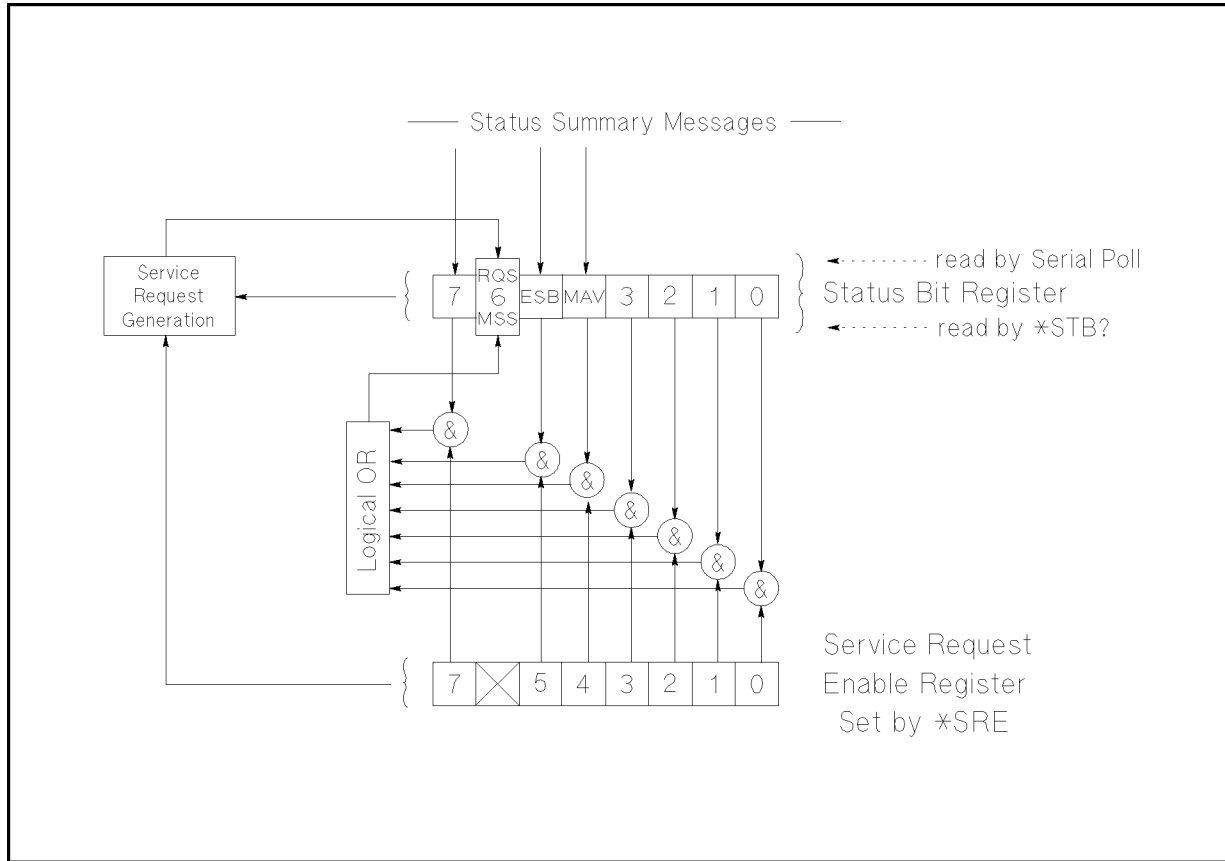

Figure 8-17. Status Byte Register

The individual bit assignments of the status byte and its bit weights are given in Table 8-4. When you read the status byte using GPIB serial polling, the value is the sum of the total bit weights of all the high bits at the time you read the byte. After serial polling the status byte, only bit 6 (RQS) is cleared.

Table 8-4. Status Byte Assignments

Bit No.	Bit Weight	Description
7	128	<p>Operation Status Event Register Summary Bit</p> <p>This bit is set to “1” when one or more enabled bits of the operation status event register (discussed later in this chapter) has been set to “1”. This bit is cleared when all bits of the operation status register are set to 0. (This bit isn’t cleared by serial-polling.)</p>
6	64	<p>Bit 6 serves two functions RQS/MSS depending on how it is read.</p> <ul style="list-style-type: none"> • RQS (Request Service) Bit <p>If bit 6 is read in the serial polling process, it is treated as the RQS bit and is reset during the serial polling process.</p> <ul style="list-style-type: none"> • MSS (Master Summary) Bit <p>If bit 6 is read using the *STB? (status byte) query, it is treated as the MSS bit, and its value is not changed by the executing the *STB? query.</p> <p>To understand this operation think of the RQS and MSS bits as two inputs to a multiplexer (MUX) and the output of the MUX being bit 6 of the status byte register.</p> <p>During the serial polling operation the MUX path selected is from the service request generation circuit to bit 6, so bit 6 represents the RQS bit.</p> <p>During execution of the *STB? query the MUX path selected is from the master summary bit generation circuit to bit 6, so bit 6 represents the MSS bit.</p> <p>To clear the MSS bit, all bits of the original registers corresponding to the enabled summary bit in the status byte and the output buffer of the 4285A must be cleared. When you read the status byte including the MSS bit instead of the RQS bit, the *STB? query must be used. *STB? query clears neither the MSS bit nor the RQS bit.</p>
5	32	<p>Standard Event Status Register Summary Bit</p> <p>This bit is set to “1” when any enabled bits of the standard event status register (discussed later in this section) has been set to “1”. This bit is cleared when all bits of the standard event status register are set to 0. (This bit isn’t cleared by serial-polling.)</p>
4	16	<p>MAV (Message Available) Bit</p> <p>This bit is set to “1” whenever the 4285A has data available to output. This bit is cleared when the available data is read. (This bit isn’t cleared by serial-polling.)</p>
3	8	always 0 (zero)
2	4	always 0 (zero)
1	2	always 0 (zero)
0	1	always 0 (zero)

Enabling the Status Byte

A service request (SRQ) will be generated when any enable bit in the status byte register is set to “1”. So to enable/disable any bits of the status byte register, you can set bits in the service request enable register. These bits correspond to bits in the status byte. When a bit is set in the service request enable register it enables that bit in the status byte to request service. To set bits in the service request enable register, the *SRE command is used. The syntax of the *SRE command is :

*SRE<*n*>

Where, <*n*> : decimal number (0 to 255)

For example,

If <*n*> is equal to 34 (00100010 in binary), bit 1 and bit 5 are enabled, as follows.

Bit No. of Status Byte	MSB	LSB						
	7	6	5	4	3	2	1	0
Bit Pattern for *SRE command	0	0	1	0	0	0	1	0

In this case, when either bit 1 or bit 5 of the status byte is set to “1”, a service request is generated.

The default setting is *SRE 0 (all bits of the status byte are disabled).

Bit 6 (RQS) is non-maskable, and bits 0 to 3 are always 0 (zero). Thus, it is meaningless to mask these bits. (The *SRE command’s bit pattern for masking bit 6 is ignored, and the *SRE command’s bit pattern for masking bits 0 to 3 are accepted, but is meaningless.)

Operation Status Register Group

The operation status register group provides operation status reporting by summarizing multiple events into a summary message (bit 7) of the status byte. The structure of the operation status register group is shown in Figure 8-18. The operation status register group consists of the standard operation status condition register, the standard operation status event register, and the standard operation status event enable register.

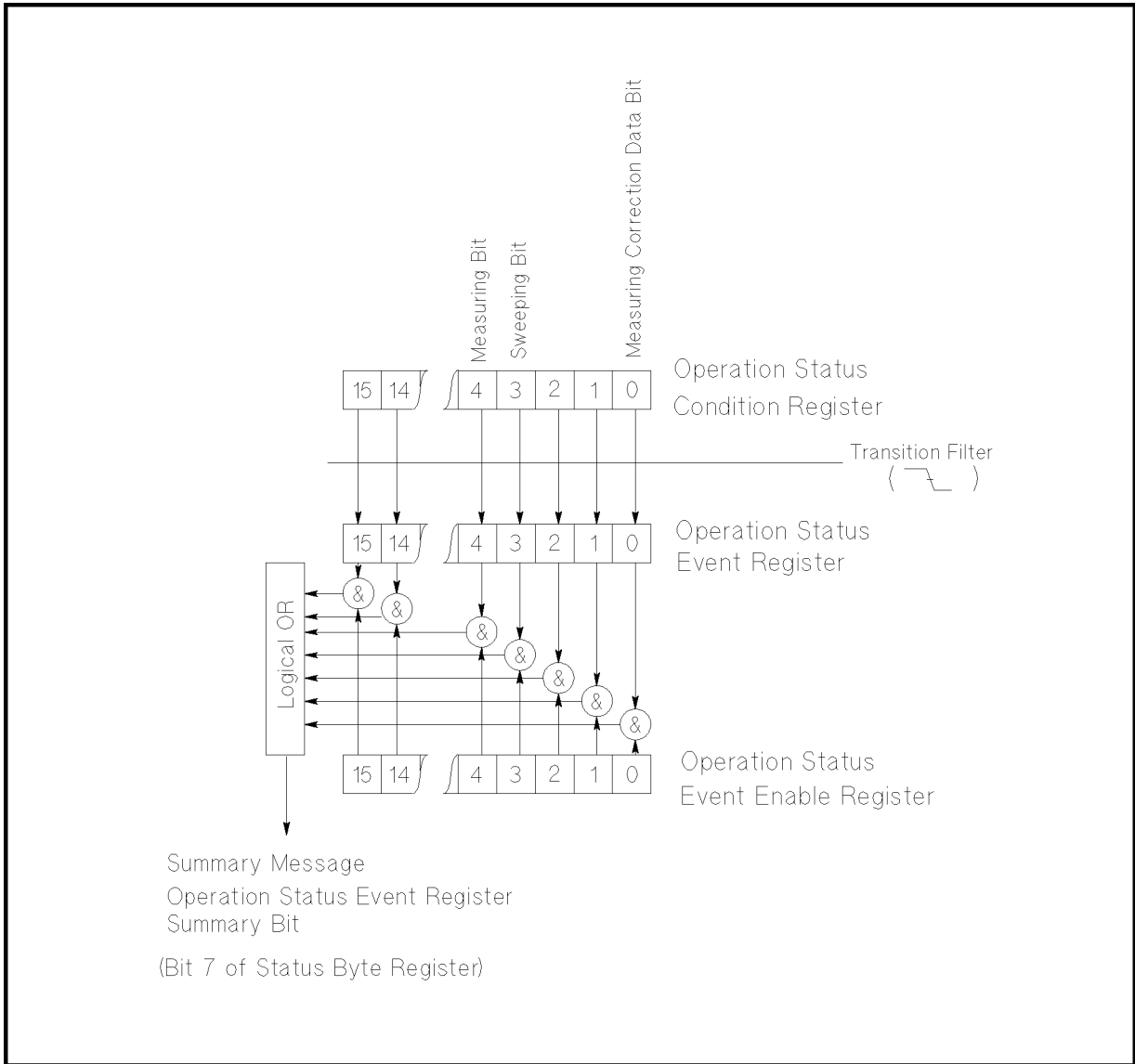

Figure 8-18. Operation Status Register Structure

Standard Operation Status Condition Register

The standard operation status condition register consists of 16-bits, and reflects these states in its condition bits. So each time the 4285A's condition is changed, its condition bit is changed from "0" to "1", or from "1" to "0". Each bit of the standard operation status condition register is shown below.

Table 8-5.
Standard Operation Status Condition Register
Assignments

Bit No.	Bit Weight	Description
15 - 5		always 0 (zero)
4	16	Measuring Bit 0 : Measurement not in progress 1 : Measurement in progress
3	8	Sweeping Bit 0 : List sweep measurement not in progress 1 : List sweep measurement in progress
2	4	always 0 (zero)
1	2	always 0 (zero)
0	1	Measuring Correction Data Bit 0 : Correction data measurement not in progress 1 : Correction data measurement in progress

When you read the contents of the standard operation status condition register using the `STATUS:OPERation:CONDition?` query, the standard operation status condition register isn't cleared. To clear the standard operation status condition register, the device's condition state should only be changed by setting all bits to 0.

Standard Operation Status Event Register

The standard operation status event register consists of 16-bit registers, and each event bit in the event register corresponds to a condition bit in the standard operation status condition register. Each event bit is set to “1” when its corresponding bit in the condition register makes a “1” to “0” transition only, a negative transition filter is used.

Table 8-6.
Standard Operation Status Event Register
Assignments

Bit No.	Bit Weight	Description
15 – 5		always 0 (zero)
4	16	Measurement Complete Bit This bit is set to “1” when a single point measurement is completed.
3	8	List Sweep Measurement Complete Bit This bit is set to “1” when a last sweep point measurement of the list sweep measurement is completed.
2	4	always 0 (zero)
1	2	always 0 (zero)
0	1	Correction Data Measurement Complete Bit This bit is set to “1” when the OPEN, SHORT, or LOAD correction data measurement is completed.

When you read the contents of the operation status event register using the `STATUS:OPERation:EVENT?` query, the operation status event register is cleared, and bit 7 of the status byte is set to “0”.

Standard Operation Status Event Enable Register

A operation status summary bit (bit 7 of the status byte) will be set when any enable bit in the operation status event register is set to “1”. To enable/disable any bits of the operation status event register, the standard operation event enable register is used. The standard operation event enable register is the same length as the standard operation event register. When a bit is set in the operation status event register it enables the corresponding bit in the operation event register to request service. To set any bit in the operation status event register, The STATUS:OPERation:ENABLE command is used. The syntax of the STATUS:OPERation:ENABLE command is:

STATUS:OPERation:ENABLE<*n*>

Where, <*n*> : decimal number (0 to 65535)

For example,

If <*n*> is equal to 8 (0000000000001000 in binary), bit 3 is enabled, as follows.

Bit No. of Event Register	MSB															LSB
	15	14	13	12	11	10	9	8	7	6	5	4	3	2	1	0
Event Enable Register	0	0	0	0	0	0	0	0	0	0	0	0	1	0	0	0

In this case, when either bit 3 of the operation status event register is set to “1”, the operation status summary bit (bit 7 of the status byte) is set to “1”.

The default setting is STATUS:OPERation:ENABLE 0 (all bits of the operation status event register are disabled).

Bit 1, bit 2, and bits 5 to 15 are always 0 (zero). Thus, it is meaningless to mask these bits.

Standard Event Status Register

The standard event status register contains the 16-bits of the operation status report which is defined in IEEE 488.2-1987 as shown in Figure 8-19. If one or more enable bits of the standard event status register is set to "1", bit 5 (standard event status register summary bit) of the status byte is set to "1". Each bit of the standard event status register is shown on the next page.

When each error bit (bit 2, bit 3, bit 4, and bit 5) of the standard event status register is set to "1", an error message with the following error numbers is input to the error queue. For details, refer to Appendix B.

Bit No.	Error No.
5 (Command Error)	-100 to -178
4 (Execution Error)	-211 to -230
3 (Device Specific Error)	10 to 101, -310, -311
2 (Query Error)	-400 to -440

When you read the contents of the standard event status register using the *ESR? command, the standard event status register is cleared, and bit 5 of the status byte is set to "0".

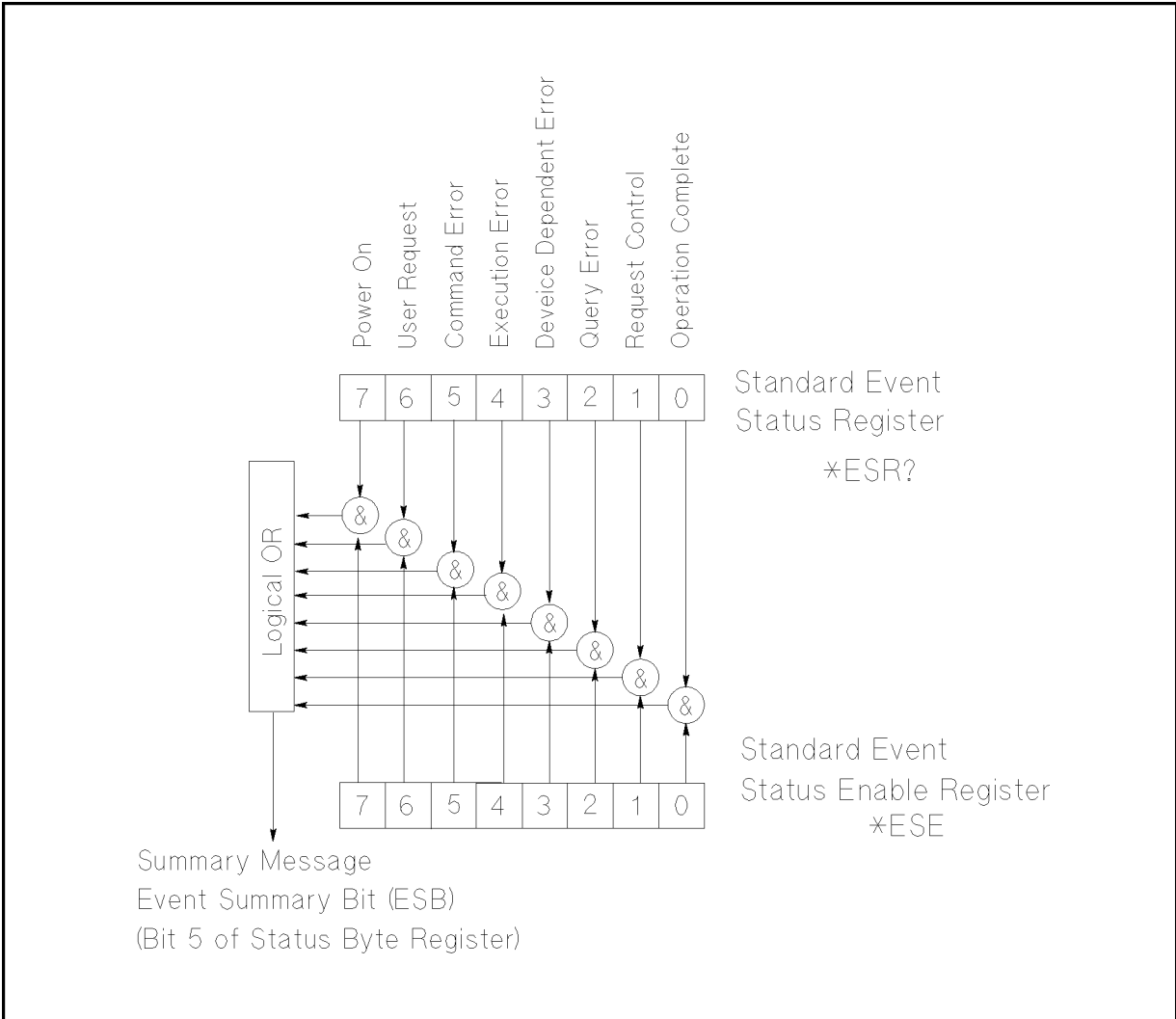

L2008016

Figure 8-19. Standard Event Status Register

Table 8-7. Standard Event Status Register Assignments

Bit No.	Bit Weight	Description
7	128	<p>Power On (PON) Bit</p> <p>This bit is set to “1” when the 4285A’s power supply has been turned OFF and then ON since the last time this register was read.</p>
6	64	<p>User Request (URQ) Bit</p> <p>always 0 (zero)</p>
5	32	<p>Command Error (CME) Bit</p> <p>This bit is set to “1” if the following the command errors occur.</p> <p>An IEEE 488.2 syntax error occurred.</p> <p>The device received a Group Execute Trigger (GET) inside a program message.</p>
4	16	<p>Execution Error (EXE) Bit</p> <p>This bit is set to “1” when a parameter following a header of a GPIB command was evaluated by the 4285A as being outside of its legal input range or is otherwise inconsistent with the 4285A’s capabilities.</p>
3	8	<p>Device Specific Error (DDE) Bit</p> <p>This bit is set to “1” when a device dependent error (except for the command error, query error, and execution error) has occurred.</p>
2	4	<p>Query Error (QYE) Bit</p> <p>This bit is set to “1” when reading data from the output buffer and no data was present, or when the data was lost.</p>
1	2	<p>Request Control (RQC) Bit</p> <p>always 0 (zero)</p>
0	1	<p>Operation Complete (OPC) Bit</p> <p>This bit is set to “1” when the 4285A has completed all selected pending operations before sending the *OPC command.</p>

Enabling the Event Status Register

An event status register summary bit (bit 6 of the status byte) will be set to “1” when any enable bit in the standard event status register is set to “1”. To enable/disable any bits of the standard event status register, you can set the bits in the standard event status enable register. These bits correspond to bits in the standard event status enable register. When a bit is set in the standard event status enable register it enables the corresponding bit in the standard event status register and sets bit 6 of the status byte (event status register summary bit) to “1”. To set any bit in the standard event status enable register, the *ESE command is used. The syntax of the *ESE command is:

*ESE<*n*>

Where, <*n*> : decimal number (0 to 255)

For example,

If <*n*> is equal to 34 (00100010), bit 1 and bit 5 are enabled, as follows.

Bit No. of Event Status Register	MSB	7	6	5	4	3	2	1	LSB	0
Bit Pattern for *ESE command	0	0	1	0	0	0	1	0		

When either bit 1 or 5 of the standard event status register is set to “1”, the event status register summary bit (bit 6 of the status byte) is set to “1”.

The default setting is *ESE 0 (all bits of the standard event status byte are disabled).

Bits 1 and 6 of the event status register are always 0 (zero). Thus masking these bits has no meaning.

Sample Programs

This paragraph provides some sample programs for control set and data transfer.

Control Settings

The 4285A has four control setting pages under the **MEAS SETUP** as follows.

- *MEAS SETUP*
- *CORRECTION*
- *LIMIT TABLE SETUP*
- *LIST SWEEP SETUP*

So, the control settings on each page should be set. The sample programs are shown in the order of the preceding list starting on the next page.

Note



In case of the front panel operation, the available control settings depends on the display page. But in the case of GPIB operation, all of control settings can be set without concern to the page being displayed.

Note



When the 4285A measures a DUT, one of the following pages under the **DISPLAY FORMAT** must be used even if the 4285A is in the remote condition.

- *MEAS DISPLAY*
 - *BIN No. DISPLAY*
 - *BIN COUNT DISPLAY*
 - *LIST SWEEP DISPLAY*
-

MEAS SETUP page

This sample program sets all of the setting controls on the *MEAS SETUP* page.

```
10  ASSIGN @Meter TO 717
20  REMOTE @Meter
30  OUTPUT @Meter;"DISP:PAGE MSET"
40  OUTPUT @Meter;"DISP:LINE ""Control Example""
50  OUTPUT @Meter;"FUNC:IMP ZTD"
60  OUTPUT @Meter;"FREQ 1MHZ"
70  OUTPUT @Meter;"VOLT 1V"
80  OUTPUT @Meter;"TRIG:SOUR BUS"
90  OUTPUT @Meter;"AMPL:ALC ON"
100 OUTPUT @Meter;"FUNC:IMP:RANG 5000HM"
110 OUTPUT @Meter;"BIAS:VOLT 5"
120 OUTPUT @Meter;"APER LONG,4"
130 OUTPUT @Meter;"FUNC:SMON:VAC ON"
140 OUTPUT @Meter;"FUNC:SMON:IAC ON"
150 OUTPUT @Meter;"TRIG:DEL 1"
160 OUTPUT @Meter;"FUNC:DEV1:MODE ABS"
170 OUTPUT @Meter;"FUNC:DEV2:MODE ABS"
180 OUTPUT @Meter;"FUNC:DEV1:REF 1000"
190 OUTPUT @Meter;"FUNC:DEV2:REF 1"
200  END
```

Figure 8-20. MEAS SETUP Page

CORRECTION page

This sample program sets the setting controls on the *CORRECTION* page after the correction data have already been stored.

```
10  ASSIGN @Meter TO 717
20  REMOTE @Meter
30  OUTPUT @Meter;"DISP:PAGE CSET"
40  OUTPUT @Meter;"CORR:OPEN STAT ON"
50  OUTPUT @Meter;"CORR:SHOR:STAT ON"
60  OUTPUT @Meter;"CORR:LOAD:STAT ON"
70  OUTPUT @Meter;"CORR:LENG 1"
80  OUTPUT @Meter;"CORR:METH MULT"
90  OUTPUT @Meter;"CORR:USE 10"
100 OUTPUT @Meter;"CORR:LOAD:TYPE CPD"
110 OUTPUT @Meter;"SPOT1:STAT ON"
120 OUTPUT @Meter;"SPOT2:STAT ON"
130 OUTPUT @Meter;"SPOT3:STAT ON"
140 OUTPUT @Meter;"SPOT4:STAT ON"
150 OUTPUT @Meter;"SPOT5:STAT ON"
160 OUTPUT @Meter;"SPOT6:STAT ON"
170 OUTPUT @Meter;"SPOT7:STAT ON"
180  END
```

Figure 8-21. CORRECTION page

LIMIT TABLE SETUP page

This sample program sets all of the setting controls on the *LIMIT TABLE SETUP* page.

```
10    ASSIGN @Meter TO 717
20    REMOTE @Meter
30    OUTPUT @Meter;"DISP:PAGE LTAB"
40    OUTPUT @Meter;"FUNC:IMP CPD"
50    OUTPUT @Meter;"COMP:TOL:NOM 10E-12"
60    OUTPUT @Meter;"COMP ON"
70    OUTPUT @Meter;"COMP:ABIN ON"
80    OUTPUT @Meter;"COMP:MODE PTOL"
90    OUTPUT @Meter;"COMP:TOL:BIN1 -1,1"
100   OUTPUT @Meter;"COMP:TOL:BIN2 -2,2"
110   OUTPUT @Meter;"COMP:TOL:BIN3 -3,3"
120   OUTPUT @Meter;"COMP:TOL:BIN4 -4,4"
130   OUTPUT @Meter;"COMP:TOL:BIN5 -5,5"
140   OUTPUT @Meter;"COMP:TOL:BIN6 -6,6"
150   OUTPUT @Meter;"COMP:TOL:BIN7 -7,7"
160   OUTPUT @Meter;"COMP:TOL:BIN8 -8,8"
170   OUTPUT @Meter;"COMP:TOL:BIN9 -9,9"
180   OUTPUT @Meter;"COMP:SLIM 0,0.00005"
190   END
```

Figure 8-22. LIMIT TABLE SETUP page

LIST SWEEP SETUP page

This sample program sets all of the setting controls on the *LIST SWEEP SETUP* page.

```
10  ASSIGN @Meter TO 717
20  REMOTE @Meter
30  OUTPUT @Meter;"DISP:PAGE LSET"
40  OUTPUT @Meter;"LIST:MODE SEQ"
50  OUTPUT @Meter;"LIST:FREQ 1MHZ,2MHZ,3MHZ,4MHZ,5MHZ,6MHZ,7MHZ,8MHZ,9MHZ,10MHZ"
60  OUTPUT @Meter;"LIST:BAND1 A,100,200"
70  OUTPUT @Meter;"LIST:BAND2 A,100,200"
80  OUTPUT @Meter;"LIST:BAND3 A,100,200"
90  OUTPUT @Meter;"LIST:BAND4 A,100,200"
100 OUTPUT @Meter;"LIST:BAND5 A,100,200"
110 OUTPUT @Meter;"LIST:BAND6 A,100,200"
120 OUTPUT @Meter;"LIST:BAND7 A,100,200"
130 OUTPUT @Meter;"LIST:BAND8 A,100,200"
140 OUTPUT @Meter;"LIST:BAND9 A,100,200"
150 OUTPUT @Meter;"LIST:BAND9 A,100,200"
160 OUTPUT @Meter;"LIST:BAND10 A,100,200"
170  END
```

Figure 8-23. LIST SWEEP SETUP

Data Transfer Examples

The 4285A has two data transfer formats, ASCII and BINARY. This paragraph includes sample programs for each.

ASCII Format

The sample programs using the ASCII data format are in the following three patterns.

- Measurement data transfer when the comparator function of the limit table is set to ON. (Figure 8-24)
- Measurement data transfer using the buffer memory function when the comparator function of the limit table is set to ON. (Figure 8-25)
- Measurement data transfer when the list sweep measurement is performed. (Figure 8-26)

```
10  ASSIGN @Meter TO 717
20  REMOTE @Meter
30  OUTPUT @Meter;"*RST;*CLS"          !\
40  OUTPUT @Meter;"FORM ASCII"        ! Setup
50  OUTPUT @Meter;"TRIG:SOUR BUS"     ! Measurement
60  OUTPUT @Meter;"COMP ON"           ! Condition
70  OUTPUT @Meter;"INIT:CONT ON"      !/
80  FOR I=0 TO 9
90      TRIGGER @Meter                 ! Perform measurement
100     ENTER @Meter;A,B,C,D           ! Transfer data to controller
110     PRINT A,B,C,D                  ! Print measurement result
120 NEXT I
130 END
```

Figure 8-24. Sample Program (Comparator) Using ASCII Format

```

10  DIM D(127,3)
20  ASSIGN @Meter TO 717
30  REMOTE @Meter
40  OUTPUT @Meter;"*RST;*CLS"          !\
50  OUTPUT @Meter;"FORM ASCII"        ! Setup
60  OUTPUT @Meter;"MEM:DIM DBUF,128"  ! Measurement
70  OUTPUT @Meter;"TRIG:SOUR BUS"     ! Condition
80  OUTPUT @Meter;"COMP ON"          !/
90  OUTPUT @Meter;"MEM:FILL DBUF"     ! Enable the buffer memory
100 FOR I=0 TO 127                    !\
110   OUTPUT @Meter;"TRIGGER"        ! Perform measurement 128 times
120 NEXT I                             !/
130 OUTPUT @Meter;"MEM:READ? DBUF"    !\
140 ENTER @Meter;D(*)                 !/Transfer the measurement result
150 PRINT D(*)                        ! Display the measurement result
160 OUTPUT @Meter;"MEM:CLE DBUF"     ! Disable the buffer memory
170  END

```

Figure 8-25. Sample Program (Buffer Memory) Using ASCII Format

```

10  DIM D(6,3)
20  ASSIGN @Meter TO 717
30  REMOTE @Meter
40  OUTPUT @Meter;"*RST;*CLS"          !\
50  OUTPUT @Meter;"FORM ASCII"        ! |
60  OUTPUT @Meter;"TRIG:SOUR BUS"     ! |
70  OUTPUT @Meter;"LIST:MODE SEQ"     ! |
80  OUTPUT @Meter;"LIST:FREQ 1MHZ,2MHZ,3MHZ,4MHZ,5MHZ,6MHZ,7MHZ"
90  OUTPUT @Meter;"LIST:BAND1 A,100,200"! Setup
100 OUTPUT @Meter;"LIST:BAND2 A,100,200"! Measurement
110 OUTPUT @Meter;"LIST:BAND3 A,100,200"! Condition
120 OUTPUT @Meter;"LIST:BAND4 A,100,200"! |
130 OUTPUT @Meter;"LIST:BAND5 A,100,200"! |
140 OUTPUT @Meter;"LIST:BAND6 A,100,200"! |
150 OUTPUT @Meter;"LIST:BAND7 A,100,200"! |
160 OUTPUT @Meter;"DISP:PAGE LIST"    ! |
170 OUTPUT @Meter;"INIT:CONT ON"     !/
180 TRIGGER @Meter                    ! Perform measurement
190 ENTER @Meter;D(*)                 ! Transfer measurement data
200 PRINT D(*)                        ! Display measurement data
210  END

```

Figure 8-26. Sample Program (List Sweep) Using ASCII Format

BINARY Format

The sample programs using the BINARY data format are in the following three patterns. (The contents of the sample programs are same as the contents of the ASCII format's sample programs.)

- Measurement data transfer when the comparator function of the limit table is set to ON. (Figure 8-27)
- Measurement data transfer using the buffer memory function when the comparator function of the limit table is set to ON. (Figure 8-28)
- Measurement data transfer when the list sweep measurement is performed. (Figure 8-29)

```
10  INTEGER Header_1,Header_2,Term
20  ASSIGN @Meter TO 717;FORMAT ON
30  ASSIGN @Binary TO 717;FORMAT OFF
40  REMOTE @Meter
50  OUTPUT @Meter;"*RST;*CLS"           !\
60  OUTPUT @Meter;"FORM REAL,64"       ! Setup
70  OUTPUT @Meter;"TRIG:SOUR BUS"      ! Measurement
80  OUTPUT @Meter;"COMP ON"           ! Condition
90  OUTPUT @Meter;"INIT:CONT ON"      !/
100 FOR I=0 TO 9
110   TRIGGER @Meter                   ! Perform measurment
120   ENTER @Binary;Header_1,Header_2,A,B,C,D,Term! Transfer data
130   PRINT A,B,C,D                   ! Display measurement result
140 NEXT I
150 END
```

Figure 8-27. Sample Program (Comparator) Using BINARY Format

```

10  INTEGER Header_1,Header_2,Header_3,Term
20  DIM D(127,3)
30  ASSIGN @Meter TO 717;FORMAT ON
40  ASSIGN @Binary TO 717;FORMAT OFF
50  REMOTE @Meter
60  OUTPUT @Meter;"*RST;*CLS"           !\
70  OUTPUT @Meter;"FORM REAL,64"       ! Setup
80  OUTPUT @Meter;"MEM:DIM DBUF,128"    ! Measurement
90  OUTPUT @Meter;"TRIG:SOUR BUS"      ! Condition
100 OUTPUT @Meter;"COMP ON"            !/
110 OUTPUT @Meter;"MEM:FILL DBUF"      ! Enable the buffer memory
120 FOR I=0 TO 127
130   OUTPUT @Meter;"TRIGGER"          ! Perform the measurement 128 times
140 NEXT I
150 OUTPUT @Meter;"MEM:READ? DBUF"     ! Transfer data
160 ENTER @Binary;Header_1,Header_2,Header_3,D(*),Term
170 PRINT D(*)                          ! Display the measurement result
180 OUTPUT @Meter;"MEM:CLE DBUF"       ! Disable the buffer memory
190 END

```

Figure 8-28. Sample Program (Buffer Memory) Using BINARY Format

```

20  DIM D(6,3)
30  ASSIGN @Meter TO 717;FORMAT ON
40  ASSIGN @Binary TO 717;FORMAT OFF
50  REMOTE @Meter
60  OUTPUT @Meter;"*RST;*CLS"           !\
70  OUTPUT @Meter;"FORM REAL,64"       ! |
80  OUTPUT @Meter;"TRIG:SOUR BUS"      ! |
100 OUTPUT @Meter;"LIST:MODE SEQ"      ! |
110 OUTPUT @Meter;"LIST:FREQ 1MHZ,2MHZ,3MHZ,4MHZ,5MHZ,6MHZ,7MHZ"
120 OUTPUT @Meter;"LIST:BAND1 A,100,200"! Setup
130 OUTPUT @Meter;"LIST:BAND2 A,100,200"! List
140 OUTPUT @Meter;"LIST:BAND3 A,100,200"! Sweep
150 OUTPUT @Meter;"LIST:BAND4 A,100,200"! Table
160 OUTPUT @Meter;"LIST:BAND5 A,100,200"!|
170 OUTPUT @Meter;"LIST:BAND6 A,100,200"!|
180 OUTPUT @Meter;"LIST:BAND7 A,100,200"!|
190 OUTPUT @Meter;"DISP:PAGE LIST"     ! |
200 OUTPUT @Meter;"INIT:CONT ON"       !/
210 TRIGGER @Meter                      ! Perform measurement
220 ENTER @Binary;Header_1,Header_2,Header_3,D(*),Term! Transfer measurement data
230 PRINT D(*)                          ! Display measurement data
240 END

```

Figure 8-29. Sample Program (List Sweep) Using BINARY Format

Command Reference

Introduction

This chapter provides descriptions of all Test and Measurement Systems Language (TMSL) command sets, listed in functional subsystem order. Use this chapter as a reference. Each command description contains the following paragraphs:

Field	A field name corresponding to a TMSL command.
Command Syntax	The way you must type in the command, including all of the required and optional parameters.
Query Syntax	The way you must type in the query, including all of the required and optional parameters.
Query Response	4285A's response data format.
Example	A case serving as a typical model for the more common uses of the command.

Notation Conventions and Definitions

The following conventions and definitions are used in this chapter to describe GPIB operation.

- < > Angular brackets enclose words or characters that are used to symbolize a program code parameter or an GPIB command.
- [] Square brackets indicates that the enclosed items are optional. The square brackets with the asterisk (for example, [*<value>* *]) means the enclosed item (*<value>*) repeats until the maximum counted number.
- { } When several items are enclosed by braces, one and only one of these elements may be selected.

The following definitions are used:

- <NLEND> Terminators (the EOI line is asserted by New Line or ASCII Line Feed character (decimal 10))
- White space Single ASCII character (0–9, 11–32 decimal)
For example, Carriage Return (13 decimal) or Space (32 decimal)

Command Structure

The 4285A commands are divided into two types: GPIB common commands and TMSL commands. The GPIB common commands are defined in IEEE std. 488.2-1987, and these commands are common for all devices. The TMSL commands are used to control all of the 4285A's functions. The TMSL commands are tree structured three levels deep. (The highest level commands are called the subsystem commands in this manual.) So the lower level commands are legal only when the subsystem commands have been selected. A colon (:) is used to separate the higher level commands and the lower level commands. See Figure 9-1 for a sample.

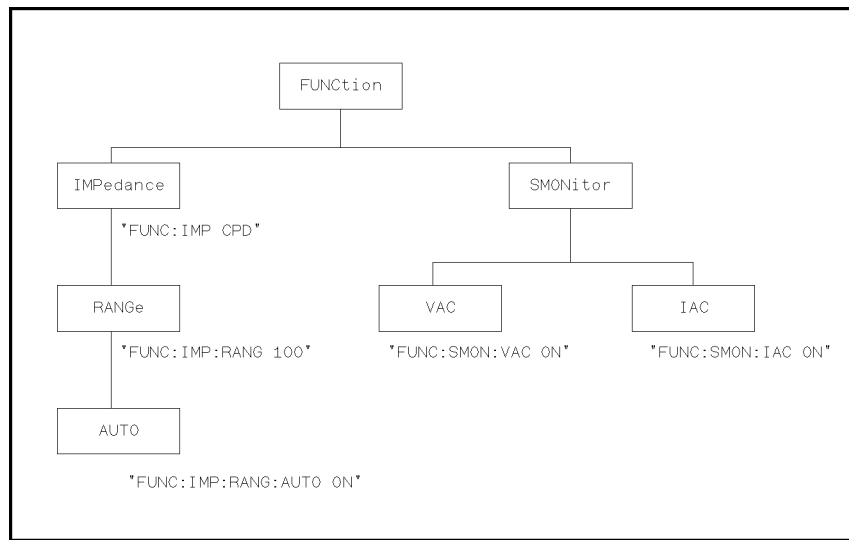

Figure 9-1. Command Tree Example

The basic rules of the command tree are as follows.

- Letter case (upper and lower) is ignored.

For example,
FUNC:IMP CPD = func:imp CpD = FuNc:IMp cPd

- Spaces (␣ used to indicate a space) must not be placed before and/or after the colon (:).

For example,
(wrong) FUNC␣:␣IMP CPD → (right) FUNC:IMP CPD

- The command can be completely spelled out or in abbreviated. (The rules for command abbreviation are described later in this section)

For example,
FUNCTION:IMPEDANCE CPD = FUNC:IMP CPD

- The command header should be followed by a question mark (?) to generate a query for that command.

For example,
FUNC:IMP?

The semicolon (;) can be used as a separator to execute multiple commands on a single line. The multiple command rules are as follows.

- Commands at the same level and in the same subsystem command group can be separated by a semicolon (;) on a multiple command line.

For example,
FUNC:SMON:VAC ON; IAC ON

- To restart commands from the highest level, a semicolon (;) must be used as the separator, and then a leading colon (:), which shows that the restarted command is a command at the top of the command tree, must follow.

For example,
FUNC:IMP CPD; :FUNC:SMON:VAC ON

- The GPIB common commands can restart only after a semicolon on a multiple command line.

For example,
FUNC:IMP CPD; *SRE 32

- The GPIB common commands keeps the previous commands level in a multiple command line.

For example,
FUNC:IMP CPD; *SRE 32; SMON:VAC ON; IAC ON

Command Abbreviations

Every command and character parameter has at least two forms, a short form and a long form. In some cases they will be the same. The short form is obtained using the following rules.

- If the long form has four characters or less, the long form and short form are the same.
- If the long form has more than 4 characters,
 - If the 4th character is a vowel, the short form is the first 3 characters of the long form.
 - If the 4th character is not a vowel, the short form is the first 4 characters.

For example:

BIAS abbreviates to BIAS.
TRIGger abbreviates to TRIG.
LEVel abbreviates to LEV.
FREQuency abbreviates to FREQ.

- If the long form mnemonic is defined as a phrase rather than a single word, then the long form mnemonic is the first character of the first word(s) followed by the entire last word. The above rules, when the long form mnemonic is a single word, are then applied to the resulting long form mnemonic to obtain the short form.

For example:

Percent TOLerance abbreviates to PTOL. (The long form is PTOLERANCE.)

Note



The 4285A accepts the three forms of the same TMSL commands: all upper case, all lower case, and mixed upper and lower case.

Header and Parameters

The GPIB control commands consists of a command header and parameters. (See the following.)

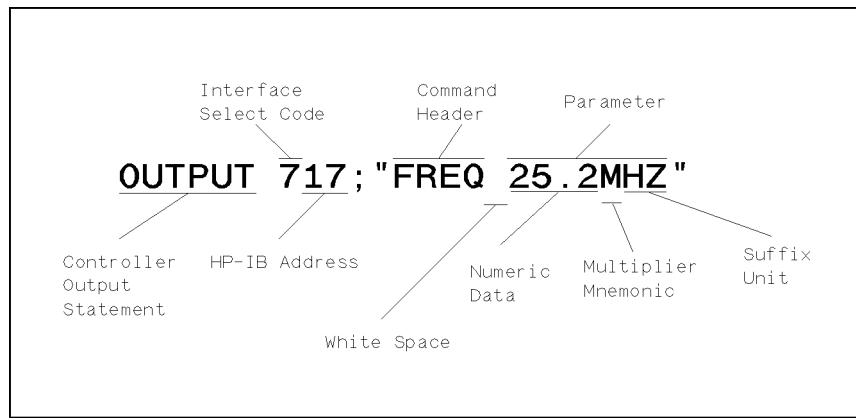

Figure 9-2. Command Header and Parameters

Headers can be of the long form or the short form. The long form allows easier understanding of the program code and the short form allows more efficient use of the computer. Parameters may be of two types as follows.

- **Character Data and String Data**

Character data consists of ASCII characters. The abbreviation rules are the same as the rules for command headers. String data consists of ASCII characters enclosed by double quotes (" ").

- **Numeric Data**

Integer (NR1), fixed point (NR2), or floating point (NR3). These three numeric data types are defined in IEEE 488.2-1988. (Refer to the syntax diagrams on the next page.) The available range for numeric data is $\pm 9.9E37$.

NR1

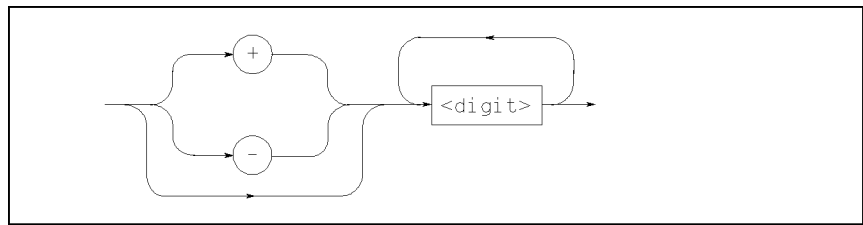

For example, 123
 + 123
 -12345

NR2

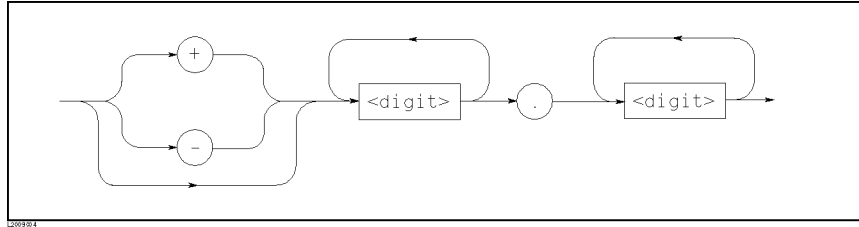

For example, 12.3
 +1.234
 -123.4

NR3

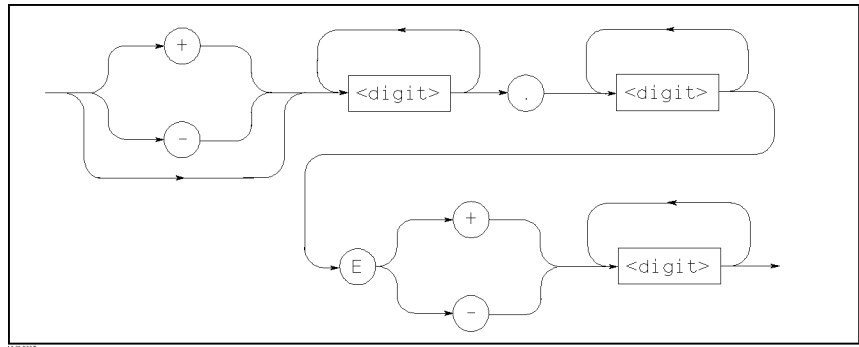

For example, 1.23E+5
 123.4E-56

When numeric data is used as a parameter, the suffix multiplier mnemonics and suffix units (The suffix multiplier must be used with the suffix unit.) can be used for some commands as follows.

Table 9-1. Multiplier Mnemonics

Definition	Mnemonic
1E18 (EXA)	EX
1E15 (PETA)	PE
1E12 (TERA)	T
1E9 (GIGA)	G
1E6 (MEGA)	MA ¹
1E3 (KILO)	K
1E-3 (MILLI)	M
1E-6 (MICRO)	U
1E-9 (NANO)	N
1E-12 (PICO)	P
1E-15 (FEMTO)	F
1E-18 (ATTO)	A

¹: M or MA is available only when the suffix unit is HZ.

Table 9-2. Suffix Units and Available Commands

Suffix Unit	Available Command
HZ	FREQuency LIST:FREQuency CORRection:SPOT<n>:FREQuency
V	VOLTage BIAS:VOLTage LIST:VOLTage LIST:BIAS:VOLTage
A	CURRent BIAS:CURRent LIST:CURRent LIST:BIAS:CURRent
OHM	FUNcTION:IMPedance:RANGe
M	CORRection:LENGth
S	TRIGger:DELay

The header separator is placed between the header and its parameter. This is one white space which is defined as a single ASCII character in the range 0 through 9 or 11 through 32 decimal. This includes the ASCII space (32 decimal) code.

Terminators

There are two kinds of the terminators: program message terminators and response message terminators.

Program Message Terminators

The 4285A responds to the input data message when it is in the remote mode (REN control line true) and is addressed to listen. The input data message contain a string of GPIB commands and terminators. The GPIB commands are executed after the terminators are received. The terminators defined as follows.

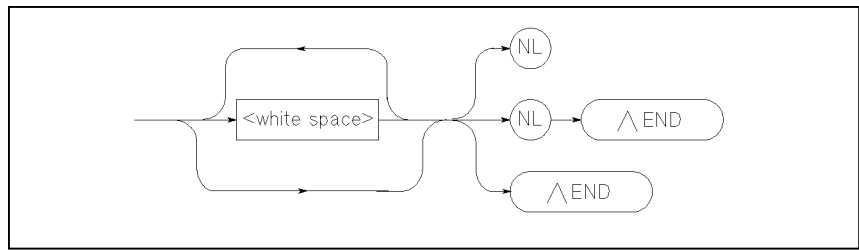

White Space Single ASCII character (0 to 9, 11 to 32 decimal)
For example, Carriage Return (13 decimal) or Space (32 decimal)

NL New Line (Line Feed (10 decimal))
^END EOI is asserted with the last byte is sent.

Response Message Terminators

The 4285A can send an output data message when it is in the local or remote modes, when it is addressed to talk, or in the talk-only mode. The data message contains the message returned by the query command and the terminators. Terminators defined as follows.

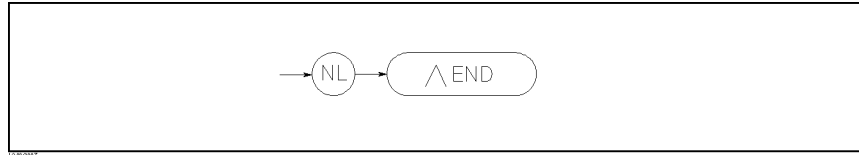

The EOI line is asserted while the New Line or Line Feed character (10 decimal) is being sent on the bus.

Command Reference

All commands in this reference are fully explained and listed in the following functional command order.

4285A Subsystem Commands

- DISPlay
- FREQuency
- VOLTage
- CURRent
- AMPLitude
- TRIGger
- OUTPut
- BIAS
- FUNCTion
- LIST
- APERTure
- INITiate
- FETCh?
- ABORt
- FORMat
- MEMMory
- CORRection
- COMPARator
- Mass MEMORY
- SYSTem
- STATus

GPIB Common Commands

- *CLS
- *ESE
- *ESR?
- *SRE
- *STB
- *IDN?
- *OPC?
- *WAI?
- *RST
- *TST?
- *TRG
- *LRN?
- *OPT?

The explanation of each subsystem command is patterned as follows.

1. Subsystem command name
2. Command Tree (Subsystem command only)
3. Compound Command Name
4. Command Description
5. Command Syntax
6. Example Using The Above Command Syntax
7. Query Syntax
8. Query Response
9. Example Using The Above Query Syntax

DISPlay Subsystem

The DISPlay subsystem command group sets the display page, and enters ASCII characters on the comment line. Figure 9-3 shows the command tree of the DISPlay subsystem command group.

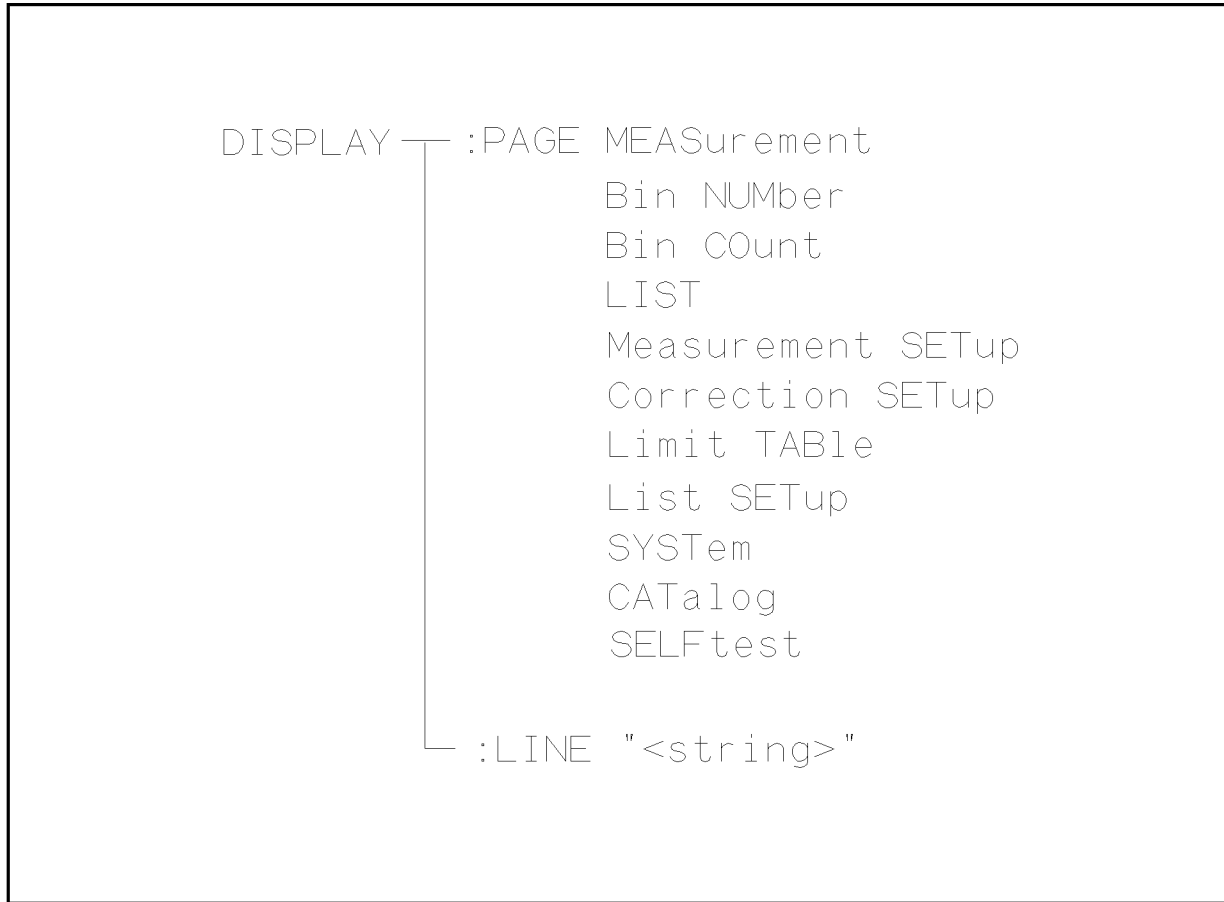

L209006

Figure 9-3. DISPlay Subsystem Command Tree

:PAGE

The :PAGE command sets the display page. The :PAGE? query returns the abbreviated page name currently displayed on the LCD screen.

Command Syntax

DISPlay:PAGE <page name>

Where, <page name> is:

MEASurement	Sets display page to <i>MEAS DISPLAY</i>
BNUmber	Sets display page to <i>BIN No.DISPLAY</i>
BCOunt	Sets display page to <i>BIN COUNT DISPLAY</i>
LIST	Sets display page to <i>LIST SWEEP DISPLAY</i>
MSETup	Sets display page to <i>MEAS SETUP</i>
CSETup	Sets display page to <i>CORRECTION</i>
LTABle	Sets display page to <i>LIMIT TABLE SETUP</i>
LSETup	Sets display page to <i>LIST SWEEP SETUP</i>
CATalog	Sets display page to <i>CATALOG</i>
SYSTem	Sets display page to <i>SYSTEM CONFIG</i>
SELF	Sets display page to <i>SELF TEST</i>

Example

OUTPUT 717;"DISP:PAGE BCO" ! Set display page to the BIN COUNT DISPLAY

Query Syntax

DISPlay:PAGE?

Query Response

Returned data format is :

<page name><NL^END>

Example

```
10 OUTPUT 717;"DISP:PAGE?"
20 ENTER 717;A$
30 PRINT A$
40 END
```

:LINE

The :LINE command enters an arbitrary comment line of up to 30 ASCII characters in the comment field. The :LINE? query returns the comment line characters.

Command Syntax

DISPlay:LINE "<string>"

Where,

<string> is ASCII character string (maximum of 30 characters)

Example

OUTPUT 717;"DISP:LINE ""This is a comment.""

Query Syntax

DISPlay:LINE?

Query Response

Returned data format is :

<string><NL^END>

Example

```
10 OUTPUT 717;"DISP:LINE?"
20 ENTER 717;A$
30 PRINT A$
40 END
```

FREQUENCY Subsystem

The FREQUENCY command sets the oscillator frequency. The FREQUENCY? query returns the current test frequency setting.

Command Syntax

$$\text{FREQUENCY}[:\text{CW}] \left\{ \begin{array}{l} \langle \text{value} \rangle \\ \text{MIN} \\ \text{MAX} \end{array} \right\}$$

Where,

$\langle \text{value} \rangle$ is the NR1, NR2, or NR3 format
 MIN Sets to the minimum value (+7.50000E+04)
 MAX Sets to the maximum value (+3.00000E+07)

Note



A suffix multiplier and a suffix unit, HZ (hertz), can be used with this command. Either MAHZ and MHZ can be used as the suffix multiplier for MHz (1E6 Hz).

Example

```
OUTPUT 717;"FREQ 1MHZ" ! Set to 1 MHz
OUTPUT 717;"FREQ MIN" ! Set to 75 kHz
OUTPUT 717;"FREQ MAX" ! Set to 30 MHz
```

Query Syntax

$$\text{FREQUENCY}[:\text{CW}]? \left[\begin{array}{l} \text{MIN} \\ \text{MAX} \end{array} \right]$$

Query Response

Returned Format is :

$\langle \text{NR3} \rangle \langle \text{NL} \rangle \langle \text{END} \rangle$

Example

```
10 OUTPUT 717;"FREQ? MIN"
20 ENTER 717;A
30 PRINT A
40 END
```

VOLTage Subsystem

The VOLTage command sets the oscillator's output voltage level. The VOLTage? query returns the current oscillator voltage level.

Command Syntax

$$\text{VOLTage} [: \text{LEVel}] \left\{ \begin{array}{l} \langle \text{value} \rangle \\ \text{MIN} \\ \text{MAX} \end{array} \right\}$$

Where,

$\langle \text{value} \rangle$ is the NR1, NR2, or NR3 format
MIN Sets to the minimum oscillator voltage level (+5.00000E-03)
MAX Sets to the maximum oscillator voltage level (+2.00000E+00)

Note



A suffix multiplier and a suffix unit, V (volt), can be used with this command. If this query is received when the oscillator level set to a current level, error -230 Data corrupt or stale will occur.

Example

```
OUTPUT 717;"VOLT 100 MV" ! Set to 100 mV
OUTPUT 717;"VOLT MIN"    ! Set to 5 mV
OUTPUT 717;"VOLT MAX"    ! Set to 2 V
```

Query Syntax

$$\text{VOLTage} [: \text{LEVel}] ? \left[\begin{array}{l} \text{MIN} \\ \text{MAX} \end{array} \right]$$

Query Response

Returned format is :

$\langle \text{NR3} \rangle \langle \text{NL} \wedge \text{END} \rangle$

Example

```
10 OUTPUT 717;"VOLT? MIN"
20 ENTER 717;A
30 PRINT A
40 END
```

CURRent Subsystem

The CURRent command sets the oscillator's output current level. The CURRent? query returns the current oscillator current level.

Command Syntax

$$\text{CURRent} [:LEVe1] \left\{ \begin{array}{l} \langle value \rangle \\ \text{MIN} \\ \text{MAX} \end{array} \right\}$$

Where,

$\langle value \rangle$ is the NR2 or NR3 format

MIN Sets or returns the minimum oscillator current level
(+2.00000E-04)

MAX Sets or returns the maximum oscillator current level
(+2.00000E-02)

In case of ALC ON, the maximum oscillator current level
(+1.00000E-02)

Note



A suffix multiplier and a suffix unit, A (ampere), can be used with this command. If this query is received when the oscillator level set to a current level, error -230 Data corrupt or stale will occur.

Example

```
OUTPUT 717;"CURR 10MA" ! Set to 10 mA
```

```
OUTPUT 717;"CURR MAX" ! Set to 20 mA
```

Query Syntax

$$\text{CURRent} [:LEVe1] ? \left[\begin{array}{l} \text{MIN} \\ \text{MAX} \end{array} \right]$$

Query Response

Returned format is :

```
<NR3><NL^END>
```

Example

```
10 OUTPUT 717;"CURR? MIN"
```

```
20 ENTER 717;A
```

```
30 PRINT A
```

```
40 END
```

AMPLitude Subsystem

The AMPLitude command sets the Automatic Level Control (ALC) to ON or OFF. The AMPLitude? query returns the current ALC ON/OFF state.

Command Syntax

$$\text{AMPLitude:ALC} \left\{ \begin{array}{l} \text{ON} \\ \text{OFF} \\ 1 \\ 0 \end{array} \right\}$$

Where,

1 (decimal 49) When the function is ON
0 (decimal 48) When the function is OFF

Example

```
OUTPUT 717;"AMPL:AUTO ON"
```

Query Syntax

```
AMPLitude:ALC?
```

Query Response

Returned format is :

```
<NR1><NL^END>
```

Example

```
10 OUTPUT 717;"AMPL:ALC?"  
20 ENTER 717;A  
30 PRINT A  
40 END
```

OUTPut Subsystem

The OUTPut subsystem command sets the DC bias monitor function. Figure 9-4 shows the command tree of the OUTPut subsystem group.

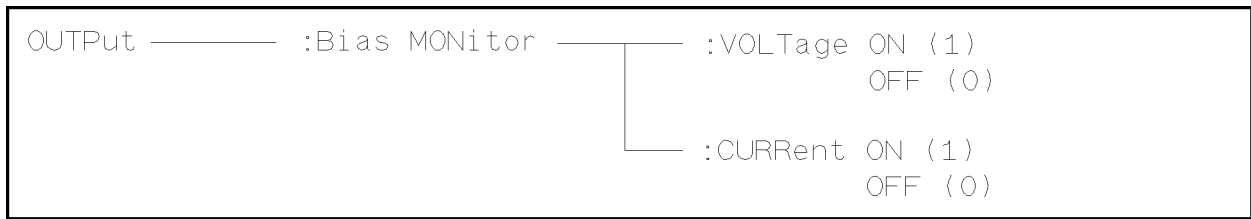

L2009009

Figure 9-4. OUTPut Subsystem Command Tree

:Bias MONitor:VOLTage

The :Bias MONitor:VOLTage command sets the internal DC bias (Option 001) monitor function to the voltage monitor mode. The :Bias MONitor:VOLTage? query returns the voltage monitor mode is set or not.

Command Syntax

$$\text{OUTPut:BMONitor:VOLTage} \left\{ \begin{array}{l} \text{ON} \\ \text{OFF} \\ 1 \\ 0 \end{array} \right\}$$

Where,

1 (decimal 49) When the function is ON
0 (decimal 48) When the function is OFF

Example

```
OUTPUT 717;"OUTP:BMON:VOLT ON"
```

```
OUTPUT 717;"OUTP:BMON:VOLT 0"
```

Query Syntax

```
OUTPut:BMONitor:VOLTage?
```

Query Response

Returned format is :

```
<NR1><NL^END>
```

Example

```
10 OUTPUT 717;"OUTP:BMON:VOLT?"  
20 ENTER 717:A  
30 PRINT A  
40 END
```

**:Bias
MONitor:CURRent**

The :BMONitor:CURRent command sets the internal DC bias (Option 001) monitor function to the current monitor mode. The :BMONitor:CURRent? query returns the current monitor mode is set or not.

Command Syntax

$$\text{OUTPut:BMONitor:CURRent} \left\{ \begin{array}{l} \text{ON} \\ \text{OFF} \\ 1 \\ 0 \end{array} \right\}$$

Where,

1 (decimal 49) When the function is ON
0 (decimal 48) When the function is OFF

Example

OUTPUT 717;"OUTP:BMON:CURR ON"

OUTPUT 717;"OUTP:BMON:CURR 0"

Query Syntax

OUTPut:BMONitor:CURRent?

Query Response

Returned format is :

<NR1><NL^END>

Example

10 OUTPUT 717;"OUTP:BMON:CURR?"
20 ENTER 717:A
30 PRINT A
40 END

BIAS Subsystem

The BIAS subsystem command group sets the DC BIAS switch to ON or OFF, and sets the DC bias voltage value or the DC bias current value. This subsystem command group is available only when the Option 001 DC bias is installed. Figure 9-5 shows the command tree of the BIAS subsystem command group.

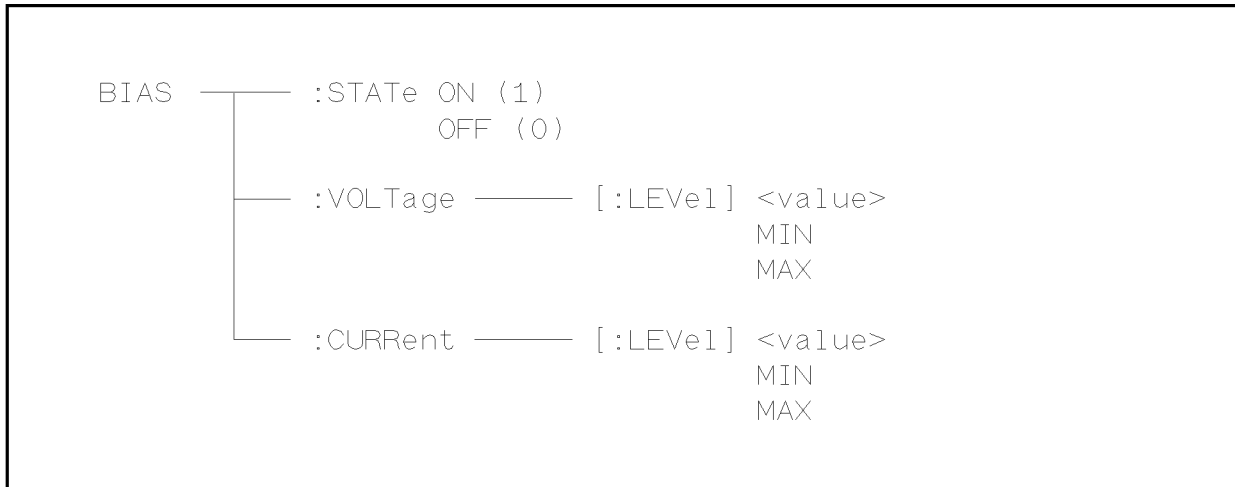

Figure 9-5. BIAS Subsystem Command Tree

:STATe

The :STATe command turns the DC BIAS switch to ON or OFF. Setting BIAS:VOLTage or BIAS:CURRent do not implicitly turn this ON. The :STATe? query returns the current DC BIAS switch ON/OFF state. *RST default value is OFF. And when Instrument control settings are loaded from the internal memory or memory card, this switch is set to OFF.

Command Syntax

$$\text{BIAS:STATe} \left\{ \begin{array}{l} \text{ON} \\ \text{OFF} \\ 1 \\ 0 \end{array} \right\}$$

Where,

1 (decimal 49) When the switch is ON
0 (decimal 48) When the switch is OFF

Example

```
OUTPUT 717;"BIAS:STAT 1"
```

Query Syntax

```
BIAS:STATe?
```

Query Response

Returned format is :

```
<NR1><NL^END>
```

Example

```
10 OUTPUT 717;"BIAS:STAT?"
20 ENTER 717;A
30 PRINT A
40 END
```

:VOLTage

The :VOLTage command sets the DC bias voltage. Setting BIAS:VOLTage does not implicitly turn the DC bias ON. The :VOLTage? query returns the current dc bias voltage setting value. This command is effective when the Option 001 DC Bias is installed.

Command Syntax

$$\text{BIAS:VOLTage} [:LEVe1] \left\{ \begin{array}{l} \langle \text{value} \rangle \\ \text{MIN} \\ \text{MAX} \end{array} \right\}$$

Where,

$\langle \text{value} \rangle$ is the NR1, NR2, or NR3 format
MIN Sets to the minimum DC bias voltage level
(+0.00000E+00)
MAX Sets to the maximum DC bias voltage level
(+4.00000E+01)

Example

```
OUTPUT 717;"BIAS:VOLT 1.5V"
```

Query Syntax

$$\text{BIAS:VOLTage} [:LEVe1] ? \left[\begin{array}{l} \text{MIN} \\ \text{MAX} \end{array} \right]$$

Query Response

Returned format is :

```
<NR3><NL^END>
```

Example

```
10 OUTPUT 717;"BIAS:VOLT? MAX"  
20 ENTER 717;A  
30 PRINT A  
40 END
```

Note



A suffix multiplier and a suffix unit, V (volt), can be used with this command. If this query is received when the DC bias level is set to a current level, error -230 Data corrupt or stale will occur.

:CURRent

The :CURRent command sets the DC bias current. Setting BIAS:CURRent does not implicitly turn the DC bias ON. The :CURRent? query returns the current DC bias current setting value. This command is effective when the Option 001 DC Bias is installed or the 42841A and the 42842C are combined.

Command Syntax

$$\text{BIAS:CURRent} [:LEVel] \left\{ \begin{array}{l} <value> \\ \text{MIN} \\ \text{MAX} \end{array} \right\}$$

Where,

<value> NR1, NR2, or NR3 format
 MIN Sets or returns the minimum DC bias current level (+0.00000E+00)
 MAX Sets or returns the maximum DC bias current level (+1.00000E-01)

Note

A suffix multiplier and a suffix unit, A (ampere), can be used with this command. If this query is received when the DC bias level is set to a current level, error -230 Data corrupt or stale will occur.

Example

```
OUTPUT 717;"BIAS:CURR 10MA"
```

Query Syntax

$$\text{BIAS:CURRent} [:LEVel] ? \left[\begin{array}{l} \text{MIN} \\ \text{MAX} \end{array} \right]$$
Query Response

Returned format is :

```
<NR3><NL^END>
```

Example

```
10 OUTPUT 717;"BIAS:CURR?"
20 ENTER 717;A
30 PRINT A
40 END
```

FUNCTION Subsystem

The FUNCTION subsystem command group sets the measurement function, the measurement range, monitor ON/OFF control, and the deviation measurement control. Figure 9-6 shows the command tree of the FUNCTION subsystem command group.

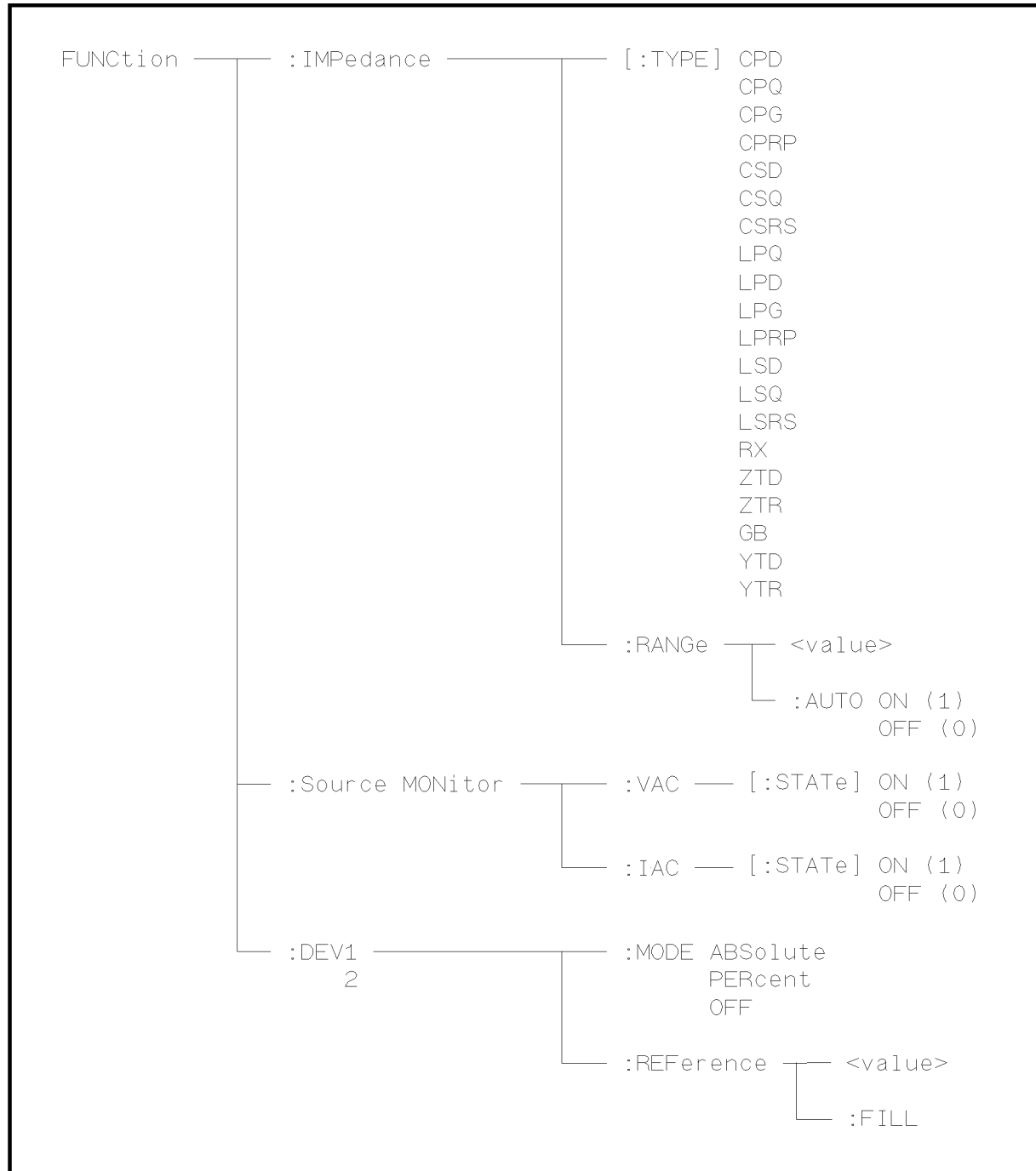

L2009011

Figure 9-6. FUNCTION Subsystem Command Tree

:IMPedance[:TYPE]

The :IMPedance command sets the measurement function. The :IMPedance? query returns the current measurement function.

Command Syntax

FUNCtion:IMPedance[:TYPE]<*function*>

Where, <*function*> is:

CPD	Sets function to C _p -D	LPRP	Sets function to L _p -R _p
CPQ	Sets function to C _p -Q	LSD	Sets function to L _s -D
CPG	Sets function to C _p -G	LSQ	Sets function to L _s -Q
CPRP	Sets function to C _p -R _p	LSRS	Sets function to L _s -R _s
CSD	Sets function to C _s -D	RX	Sets function to R-X
CSQ	Sets function to C _s -Q	ZTD	Sets function to Z- θ (deg)
CSRS	Sets function to C _s -R _s	ZTR	Sets function to Z- θ (rad)
LPQ	Sets function to L _p -Q	GB	Sets function to G-B
LPD	Sets function to L _p -D	YTD	Sets function to Y- θ (deg)
LPG	Sets function to L _p -G	YTR	Sets function to Y- θ (rad)

Example

OUTPUT 717;"FUNC:IMP GB" ! Set to the G-B function

Query Syntax

FUNCtion:IMPedance[:TYPE]?

Query Response

Returned format is :

<*function*><NL^END>

Example

```
10 OUTPUT 717;"FUNC:IMP?"
20 ENTER 717;A$
30 PRINT A$
40 END
```

:IMPedance:RANGe

The :IMPedance:RANGe command sets the measurement range. Any value can be used as the setting value. The 4285A selects an appropriate measurement range for the setting value. The :IMPedance:RANGe? query returns the current measurement range even if the measurement range is set to AUTO.

Command Syntax

FUNCtion:IMPedance:RANGe <value>

Where, <value> is the impedance value of DUT in the NR1, NR2, or NR3 format

Note



A suffix multiplier and a suffix unit, OHM, can be used with this command. If this command is received while auto range is ON, the auto range function is automatically set to OFF and the range will be held at the range dictated by the received command.

Example

```
OUTPUT 717;"FUNC:IMP:RANG 5KOHM"
```

Query Syntax

FUNCtion:IMPedance:RANGe?

Query Response

Returned format is :

<value><NL^END>

Where, <value> is

Impedance Range					Applicable Oscillator Level
0	50	500	5,000	50,000 ¹	5 mV - 1 V _{rms}
0	100	1,000	10,000	100,000 ¹	1.01 V - 2 V _{rms}

Returned format is NR3.

¹ These ranges are effective \leq 1 MHz.

Example

```
10 OUTPUT 717;"FUNC:IMP:RANG?"  
20 ENTER 717;A  
30 PRINT A  
40 END
```

:IMPedance:RANGe:AUTO

The :IMPedance:RANGe:AUTO command sets the auto range to ON or OFF. The :IMPedance:RANGe:AUTO? query returns the current auto range ON/OFF condition.

Command Syntax

$$\text{FUNcTion:IMPedance:RANGe:AUTO} \left\{ \begin{array}{l} \text{ON} \\ \text{OFF} \\ 1 \\ 0 \end{array} \right\}$$

Where,

1 (decimal 49) When the function is ON

0 (decimal 48) When the function is OFF

Example

```
OUTPUT 717;"FUNC:IMP:RANG:AUTO ON"
```

```
OUTPUT 717;"FUNC:IMP:RANG:AUTO 1"
```

Query Syntax

```
FUNcTion:IMPedance:RANGe:AUTO?
```

Query Response

Returned format is :

```
<NR1><NL^END>
```

Example

```
10 OUTPUT 717;"FUNC:IMP:RANG:AUTO?"
20 ENTER 717;A
30 PRINT A
40 END
```

:Source MONitor:VAC

The :Source MONitor:VAC command sets the voltage level monitor to ON or OFF. The :Source MONitor:VAC? query returns the voltage level monitor ON/OFF condition.

Command Syntax

$$\text{FUNction:SMONitor:VAC[:STATe]} \left\{ \begin{array}{l} \text{ON} \\ \text{OFF} \\ 1 \\ 0 \end{array} \right\}$$

Where,

1 (decimal 49) When the switch is ON
0 (decimal 48) When the switch is OFF

Example

```
OUTPUT 717;"FUNC:SMON:VAC ON"
```

```
OUTPUT 717;"FUNC:SMON:VAC 1"
```

Query Syntax

```
FUNction:SMONitor:VAC[:STATe]?
```

Query Response

Returned format is :

```
<NR1><NL^END>
```

Example

```
10 OUTPUT 717;"FUNC:SMON:VAC?"  
20 ENTER 717;A  
30 PRINT A  
40 END
```

**:Source
MONitor:IAC**

The :Source MONitor:IAC command sets the current level monitor to ON or OFF. The :Source MONitor:IAC? query returns the current ON/OFF condition of the current level monitor.

Command Syntax

$$\text{FUNction:SMONitor:IAC[:STATe]} \left\{ \begin{array}{l} \text{ON} \\ \text{OFF} \\ 1 \\ 0 \end{array} \right\}$$

Where,

1 (decimal 49) When the switch is ON
0 (decimal 48) When the switch is OFF

Example

OUTPUT 717;"FUNC:SMON:IAC 1"

Query Syntax

FUNction:SMONitor:IAC[:STATe]?

Query Response

Returned format is :

<NR1><NL^END>

Example

10 OUTPUT 717;"FUNC:SMON:IAC?"
20 ENTER 717;A
30 PRINT A
40 END

:DEV<n>:MODE

The :DEV<n>:MODE command sets the deviation measurement mode. The :DEV<n>:MODE? query returns the current setting of the deviation measurement mode.

Command Syntax

$$\text{FUNction:DEV<n>:MODE} \left\{ \begin{array}{l} \text{ABSolute} \\ \text{PERCent} \\ \text{OFF} \end{array} \right\}$$

Where,

ABSolute Δ ABSolute deviation mode
PERCent Δ % deviation mode
OFF Turn the deviation measurement mode OFF

<n> is :

- 1 (decimal 49) Deviation mode setting for primary parameter
- 2 (decimal 50) Deviation mode setting for secondary parameter

Example

```
OUTPUT 717;"FUNC:DEV1:MODE ABS"
```

```
OUTPUT 717;"FUNC:DEV2:MODE OFF"
```

Query Syntax

```
FUNction:DEV<n>:MODE?
```

Query Response

Returned format is :

$$\left\{ \begin{array}{l} \text{ABS} \\ \text{PERC} \\ \text{OFF} \end{array} \right\} \langle \text{NL}^{\wedge} \text{END} \rangle$$

Example

```
10 OUTPUT 717;"FUNC:DEV1:MODE?"  
20 ENTER 717;A$  
30 PRINT A$  
40 END
```

:DEV<n>:REFeRence The :DEV<n>:REFeRence command sets the reference value for deviation measurement. The :DEV<n>:REFeRence? query returns the current reference values.

Command Syntax FUNCtion:DEV<n>:REFeRence<value>

Where,

<value> is the NR1, NR2, or NR3 format

<n> is :

- 1 (decimal 49) Reference value setting for primary parameter
- 2 (decimal 50) Reference value setting for secondary parameter

Example OUTPUT 717;"FUNC:DEV1:REF 10"

 OUTPUT 717;"FUNC:DEV2:REF 2E-3"

Query Syntax FUNCtion:DEV<n>:REFeRence?

Query Response Returned format is :

 <NR3><NL^END>

Example 10 OUTPUT 717;"FUNC:DEV1:REF?"
 20 ENTER 717;A
 30 PRINT A
 40 END

:DEV<n>:REFerence:FILL

The :DEV<n>:REFerence:FILL command executes a single measurement and enters two measured values (the primary and secondary parameters) into each of the reference values for the deviation measurement.

Command Syntax FUNction:DEV<n>:REFerence:FILL

Where, <n> is

1 or 2 (Both reference values are measured simultaneously.)

Example OUTPUT 717;"FUNC:DEV1:REF:FILL"

LIST Subsystem

The LIST subsystem command group sets the List Sweep measurement function, including the sweep point settings, the sweep mode and limit values for the limit function. Figure 9-7 shows the command tree of the LIST subsystem command group.

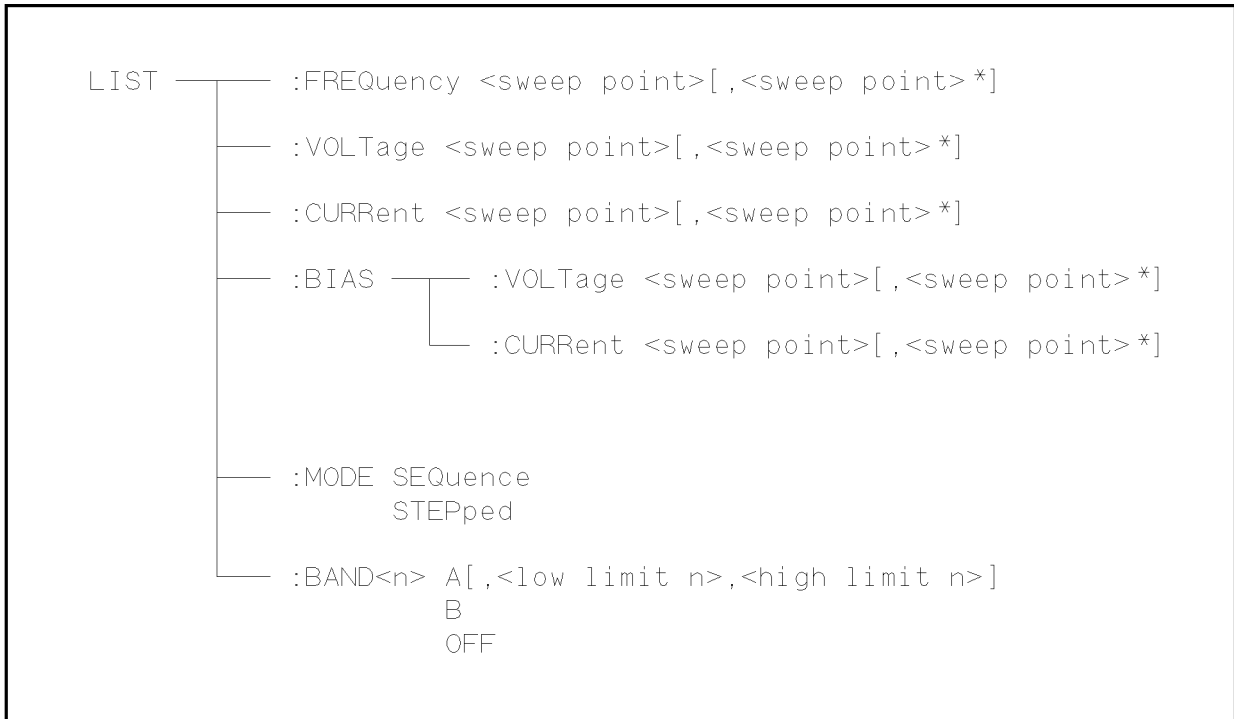

Figure 9-7. LIST Subsystem Command Tree

:FREQUENCY

The :FREQUENCY command clears the previous List Sweep point table, and sets the frequency sweep points. The :FREQUENCY? query returns the current settings of the frequency sweep points.

Command Syntax

```
LIST:FREQUENCY <value> [ ,<value>* ]
```

*Repeat Max. 10 sweep points

Where,

<value> is the NR1, NR2, or NR3 format

Example

```
OUTPUT 717;"LIST:FREQ 1E6,2E6,3E6,4E6"  
! Set 1 MHz to point 1, ..., 4 MHz to point 4
```

Note



A suffix multiplier and a suffix unit, HZ (hertz), can be used with this command. Either MAHZ and MHZ can be used as the suffix multiplier for MHz (1E6 Hz).

Query Syntax

```
LIST:FREQUENCY?
```

Query Response

Returned format is :

```
<NR3> [ ,<NR3>* ] <NL^END>
```

Example

```
10 DIM A$[100]  
20 OUTPUT 717;"LIST:FREQ?"  
30 ENTER 717;A$  
40 PRINT A$  
50 END
```

Note



If this query is received when the List Sweep parameter is set to anything other than frequency, error -230 Data corrupt or stale will occur.

:VOLTage

The :VOLTage command clears the previous list sweep point table, and sets the oscillator voltage level sweep points. The :VOLTage? query returns the current settings of the voltage sweep points.

Command Syntax

```
LIST:VOLTage <value> [ ,<value>* ]
```

*Max. 10 sweep points

Where,

<value> is the NR1, NR2, or NR3 format

Example

```
OUTPUT 717;"LIST:VOLT 1E-2,2E-2,3E-2,4E-2"
! Set 10 mV to point 1, .... 40 mV to point 4
```

Note

A suffix multiplier and a suffix unit, V (voltage), can be used with this command.

Query Syntax

```
LIST:VOLTage?
```

Query Response

Returned format is :

```
<NR3> [ ,<NR3>* ] <NL^END>
```

Example

```
10 DIM A$[100]
20 OUTPUT 717;"LIST:VOLT?"
30 ENTER 717;A$
40 PRINT A$
50 END
```

Note

If this query is received when the List Sweep parameter is set to anything other than voltage, error -230 Data corrupt or stale will occur.

:CURRent

The :CURRent command clears the previous list sweep point table, and sets the oscillator current level sweep points. The :CURRent? query returns the current settings of current sweep points.

Command Syntax

```
LIST:CURRent <value> [ ,<value>* ]
```

*Max. 10 sweep points

Where,

<value> is the NR1, NR2, or NR3 format

Example

```
OUTPUT 717;"LIST:CURR 1E-3,2E-3,3E-3,4E-3"  
! Set 1 mA to point 1, ... 4 mA to point 4
```

Note



A suffix multiplier and a suffix unit, A (ampere), can be used with this command.

Query Syntax

```
LIST:CURRent?
```

Query Response

Returned format is :

```
<NR3> [ ,<NR3>* ]<NL^END>
```

Example

```
10 DIM A$[100]  
20 OUTPUT 717;"LIST:CURR?"  
30 ENTER 717;A$  
40 PRINT A$  
50 END
```

Note



If this query is received when the List Sweep parameter is set to anything other than current, error -230 Data corrupt or stale will occur.

:BIAS:VOLTage

The :BIAS:VOLTage command clears the previous List Sweep point table, and sets the DC bias voltage level sweep points. The :BIAS:VOLTage? query returns the current settings of the DC voltage sweep points. This command is effective when the Option 001 DC Bias is installed.

Command Syntax

```
LIST:BIAS:VOLTage <value> [ ,<value>* ]
```

*Max. 10 sweep points

Where,

<value> is the NR1, NR2, or NR3 format

Example

```
OUTPUT 717;"LIST:BIAS:VOLT 2E-1,4E-1,6E-1,8E-1"  
! Set 200 mV to point 1, ... 800 mV to point 4
```

Note



A suffix multiplier and a suffix unit, V (voltage), can be used with this command.

Query Syntax

```
LIST:BIAS:VOLTage?
```

Query Response

Returned format is :

```
<NR3> [ ,<NR3>* ] <NL^END>
```

Example

```
10 DIM A$ [100]  
20 OUTPUT 717;"LIST:BIAS:VOLT?"  
30 ENTER 717;A$  
40 PRINT A$  
50 END
```

Note



If this query is received when the List Sweep parameter is set to anything other than bias voltage, error -230 Data corrupt or stale will occur.

:BIAS:CURRent

The :BIAS:CURRent command clears the previous List Sweep point table, and sets the DC bias current level sweep points. The :BIAS:CURRent? query returns the current settings of the DC current sweep points. This command is effective when the Option 001 DC Bias is installed or the 42841A and the 42842C are combined.

Command Syntax

```
LIST:BIAS:CURRent <value> [ ,<value>* ]
```

*Max. 10 sweep points

Where,

<value> is the NR1, NR2, or NR3 format

Example

```
OUTPUT 717;"LIST:BIAS:CURR 1E-2,2E-2,3E-2,4E-2"  
! Set 10 mA to point 1, ... 40 mA to point 4
```

Note



A suffix multiplier and a suffix unit, A (ampere), can be used with this command.

Query Syntax

```
LIST:BIAS:CURRent?
```

Query Response

Returned format is :

```
<NR3> [ ,<NR3>* ] <NL^END>
```

Example

```
10 DIM A$[100]  
20 OUTPUT 717;"LIST:BIAS:CURR?"  
30 ENTER 717;A$  
40 PRINT A$  
50 END
```

Note



If this query is received when the List Sweep parameter is set to anything other than bias current, error -230 Data corrupt or stale will occur.

:MODE

The :MODE command sets the sweep mode of the List Sweep measurement function. The :MODE? query returns the current mode setting of the List Sweep measurement function.

Command Syntax
$$\text{LIST:MODE } \left\{ \begin{array}{l} \text{SEQ} \\ \text{STEPped} \end{array} \right\}$$

Where,

SEQ Sets to sequence mode

STEPped Sets to stepped mode

Example

```
OUTPUT 717;"LIST:MODE SEQ"
```

Query Syntax

```
LIST:MODE?
```

Query Response

Returned format is :

$$\left\{ \begin{array}{l} \text{SEQ} \\ \text{STEP} \end{array} \right\} \langle \text{NL} \wedge \text{END} \rangle$$
Example

```
10 OUTPUT 717;"LIST:MODE?"
20 ENTER 717;A$
30 PRINT A$
40 END
```

:BAND<n>

The :BAND<n> command sets the limit values of the limit function for the list sweep measurement. The :BAND<n>? query returns the current limit value settings.

Command Syntax

LIST:BAND<n><parameter> [,<low limit n>,<high limit n>]

Where,

<n> 1 to 10 (NR1) : Sweep point number
<parameter> is : A Limit setting enable for primary parameter
B Limit setting enable for secondary parameter
OFF Limit setting disable
<low limit n> NR1, NR2, or NR3 format : low limit for sweep point<n>
<high limit n> NR1, NR2, or NR3 format : high limit for sweep point<n>

Example

OUTPUT 717;"LIST:BAND1 A,10,20"

OUTPUT 717;"LIST:BAND3 OFF"

Query Syntax

LIST:BAND<n>?

Query Response

Returned format is :

<parameter>,<low limit n>,<high limit n>

Example

```
10 DIM A$[30]
20 OUTPUT 717;"LIST:BAND3?"
30 ENTER 717;A$
40 PRINT A$
50 END
```

APERture Subsystem

The APERture command sets the integration time of the A/D converter and the averaging rate. The APERture? query returns the current integration time and the averaging rate settings.

Command Syntax

$$\text{APERture} \left\{ \begin{array}{l} \text{SHORT} \\ \text{MEDIum} \\ \text{LONG} \end{array} \right\} [, <value>]$$

Where,

SHORT Short integration time
 MEDIum Medium integration time
 LONG Long integration time
 <value> 1 to 256 (NR1) : Averaging rate

Example

OUTPUT 717;"APER SHOR"

OUTPUT 717;"APER MED,64"

Query Syntax

APERture?

Query Response

Returned format is :

$$\left\{ \begin{array}{l} \text{SHOR} \\ \text{MED} \\ \text{LONG} \end{array} \right\} , <NR1> <NL \wedge \text{END}>$$

Example

10 OUTPUT 717;"APER?"
 20 ENTER 717;A\$
 30 PRINT A\$
 40 END

TRIGger Subsystem

The TRIGger subsystem command group is used to enable a measurement or a sweep measurement, and to set the trigger mode and the trigger delay time. Figure 9-8 shows the command tree of the TRIGger subsystem command group.

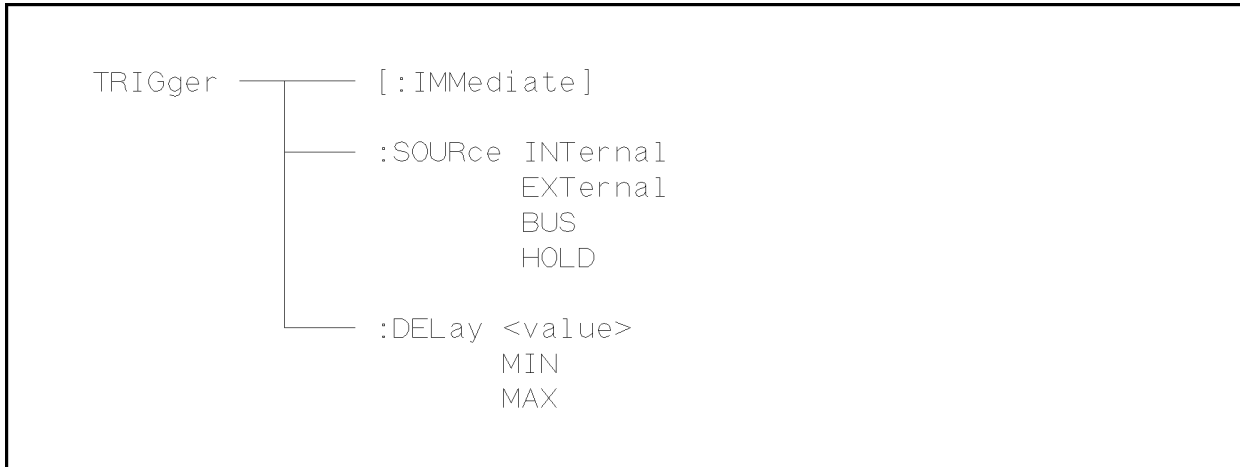

L2009013

Figure 9-8. TRIGger Subsystem Command Tree

:IMMediate

The :IMMediate command causes the trigger to execute a measurement or a sweep measurement, regardless of the trigger state. Refer to “Trigger System” in Chapter 8, for details.

Command Syntax

```
TRIGger[:IMMediate]
```

Example

```
OUTPUT 717;"TRIG"
```

```
OUTPUT 717;"TRIG:IMM"
```

:SOURce

The :SOURce command sets the trigger mode. The :SOURce? query returns the current trigger mode.

Command Syntax

$$\text{TRIGger:SOURce} \left\{ \begin{array}{l} \text{INTernal} \\ \text{EXTernal} \\ \text{BUS} \\ \text{HOLD} \end{array} \right\}$$

Where,

INTernal	Internal trigger mode
EXTernal	External trigger mode
BUS	Bus trigger mode
HOLD	Trigger hold (Manual trigger mode)

Example OUTPUT 717;"TRIG:SOUR BUS"

Query Syntax TRIGger:SOURce?

Query Response Returned format is :

$$\left\{ \begin{array}{l} \text{INT} \\ \text{EXT} \\ \text{BUS} \\ \text{HOLD} \end{array} \right\} \langle \text{NL}^{\wedge} \text{END} \rangle$$

Example

```
10 OUTPUT 717;"TRIG:SOUR?"
20 ENTER 717;A$
30 PRINT A$
40 END
```

:DElay

The :DElay command sets the trigger delay time. The :DElay? query returns the current delay time.

Command Syntax

TRIGger:DElay { *<value>* }
 { MIN
 MAX }

Where,

<value> is the NR1, NR2, or NR3 format; 0 to 60 [s] in 1 ms resolution

MIN Sets the minimum delay value (+0.00000E+00)

MAX Sets the maximum delay value (+6.00000E+01)

Example

OUTPUT 717;"TRIG:DEL 5S" ! Set delay time to 5 s

OUTPUT 717;"TRIG:DEL MIN" ! Set delay time to 0 s

Note



A suffix multiplier and a suffix unit, S (second), can be used with this command.

Query Syntax

TRIGger:DElay? [MIN
 MAX]

Query Response

Returned Format is :

<NR3><NL^END>

Example

10 OUTPUT 717;"TRIG:DEL?"
20 ENTER 717;A
30 PRINT A
40 END

INITiate Subsystem

The INITiate subsystem command group controls initiation of the triggering system. Figure 9-9 shows the command tree of the INITiate subsystem command group.

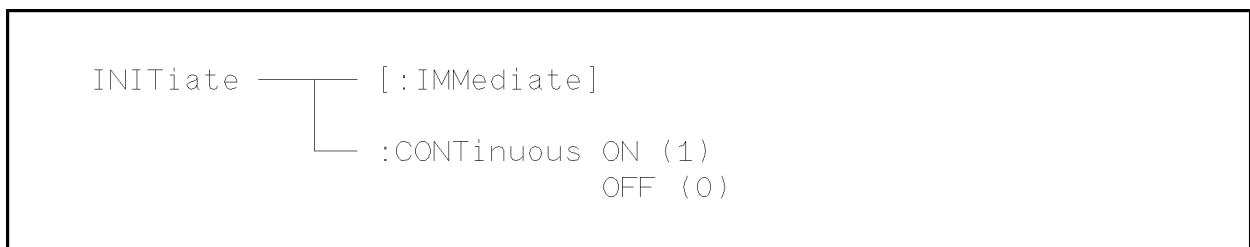

L2009014

Figure 9-9. INITiate Subsystem Command Tree

[:IMMEDIATE]

The [:IMMEDIATE] command changes the trigger state to the IDLE STATE to the WAIT FOR TRIGGER STATE for one trigger sequence. For details, refer to “Trigger System” in Chapter 8.

Command Syntax

```
INITiate[IMMEDIATE]
```

Example

```
OUTPUT 717;"INIT"
```

```
OUTPUT 717;"INIT:IMM"
```

:CONTInuous

The :CONTInuous command sets the trigger system to the CONTInuous ON or OFF condition. In the CONTInuous ON condition, after reading the measurement data by a controller, the IDLE STATE is automatically set to the WAIT FOR TRIGGER STATE. For details refer to "Trigger System" in Chapter 8. The :CONTInuous? query responds the current condition of the CONTInuous ON or OFF.

Command Syntax

$$\text{INITiate:CONTInuous} \left\{ \begin{array}{l} \text{ON} \\ \text{OFF} \\ 1 \\ 0 \end{array} \right\}$$

Where,

1 (decimal 49) When the function is ON
0 (decimal 48) When the function is OFF

Example

```
OUTPUT 717;"INIT:CONT ON"
```

Query Syntax

```
INITiate:CONTInuous?
```

Query Response

Returned format is :

```
<NR1><NL^END>
```

Example

```
10 OUTPUT 717;"INIT:CONT?"
20 ENTER 717;A
30 PRINT A
40 END
```

FETCh? Subsystem

The FETCh? subsystem command group is a sensor-only command which retrieves the measurement data taken by measurement(s) initiated by a trigger, and places the data into the 4285A's output buffer.

Figure 9-10 shows the command tree of the FETCh? subsystem command group.

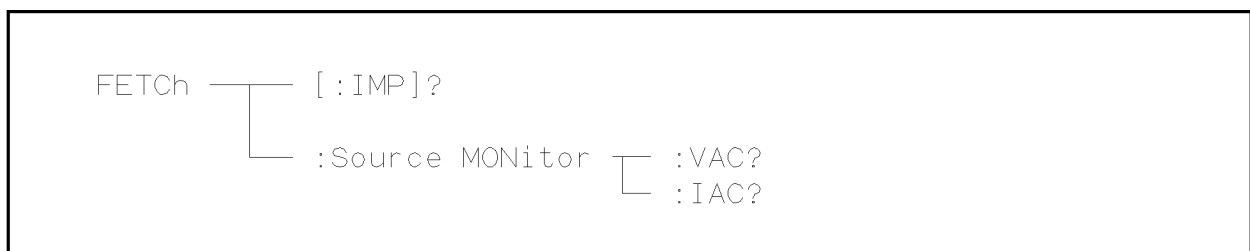

Figure 9-10. FETCh? Subsystem Command Tree

[:IMP] ?

The [:IMP] ? query sets the latest measurement data of the primary and secondary parameters into the 4285A's output buffer. For the returned format, refer to "Data Transfer" in Chapter 8.

Query Syntax

FEtCh [:IMP] ?

Example

```
10 OUTPUT 717;"TRIG:SOUR BUS"  
20 OUTPUT 717;"TRIG"  
30 OUTPUT 717;"FETC?"  
40 ENTER 717;A,B,C  
50 PRINT A,B,C  
60 END
```

**:Source
MONitor:VAC?**

The :Source MONitor:VAC? query sets the latest measured voltage monitor data into the 4285A's output buffer.

Query Syntax

FETCH:SMONitor:VAC?

Query Response

Returned format is :

<NR3><NL^END>.

Example

```
10 OUTPUT 717;"TRIG:SOUR BUS"  
20 OUTPUT 717;"TRIG"  
30 OUTPUT 717;"FETC:SMON:VAC?"  
40 ENTER 717;A  
50 PRINT A  
60 END
```

Note



If this query is received when the voltage level monitor is set to OFF, returned data is 9.9E37.

**:Source
MONitor:IAC?**

The :Source MONitor:IAC? query sets the latest measured current monitor data into the 4285A's output buffer.

Query Syntax

FETCh:SMONitor:IAC?

Query Response

Returned format is :

<NR3><NL^END>.

Example

```
10 OUTPUT 717;"TRIG:SOUR BUS"  
20 TRIGGER 717  
30 OUTPUT 717;"FETC:SMON:IAC?"  
40 ENTER 717;A  
50 PRINT A  
60 END
```

Note

If this query is received when the current level monitor is set to OFF, returned data is 9.9E37.

ABORt Subsystem

The ABORt command sets the trigger system to reset, and the trigger state is in the IDLE STATE on the state diagram. For detail, refer to "Trigger System" in Chapter 8.

Command Syntax

```
ABORt
```

Example

```
OUTPUT 717;"ABOR"
```

FORMat Subsystem

The FORMat command sets the data output format. For details, refer to “Data Transfer” in Chapter 8. The FORMat? query returns the current data format setting.

Command Syntax

$$\text{FORMat} [: \text{DATA}] \left\{ \begin{array}{l} \text{ASCii} \\ \text{REAL} [, 64] \end{array} \right\}$$

Where,

ASCii is set by the ASCII data format

REAL[,64] is set by the IEEE-64 bit floating point data format

Example

```
OUTPUT 717;"FORM REAL"
```

Query Syntax

```
FORMat [ :DATA ] ?
```

Query Response

Returned data format is :

$$\left\{ \begin{array}{l} \text{ASC} \\ \text{REAL}, 64 \end{array} \right\} \langle \text{NL} \wedge \text{END} \rangle$$

Example

```
10 OUTPUT 717;"FORM?"
20 ENTER 717;A$
30 PRINT A$
40 END
```

MEMory Subsystem

The MEMory subsystem command group controls the 4285A's data buffer. Figure 9-11 shows the command tree of the MEMory subsystem command group.



Figure 9-11. MEMory Subsystem Command Tree

:DIM

The :DIM command clears the data buffer memory, and sets the size of the data buffer memory. For details, refer to “Data Transfer” in Chapter 8.

Command Syntax

MEMory: DIM DBUF, <value>

Where,

<value> 1 to 128 (NR1) : Number of data sets

Example

```
OUTPUT 717;"MEM: DIM DBUF,3"
```

! Specify the DBUF size for 3 sets of measurement data

:FILL

The :FILL command enables the data buffer memory to store the measurement data. After execution of the :FILL command, all measurement data will be stored in the data buffer memory. For details, refer to “Data Transfer” in Chapter 8.

Command Syntax

MEMory:FILL DBUF

Example

OUTPUT 717;"MEM:FILL DBUF"

:CLEar

The :CLEar command clears the data buffer memory. After execution of this command, measurement data will not be stored in the data buffer memory until execution of the :FILL command. For details, refer to “Data Transfer” in Chapter 8.

Command Syntax

```
MEMory:CLEar DBUF
```

Example

```
OUTPUT 717;"MEM:CLE DBUF"
```

:READ?

The `:READ?` query places the data in the data buffer memory into the output buffer. If the data buffer memory is not filled to the specified size (specified by the `:DIM` command), the data locations in which data is not stored will be set to `-1` (no data). For details of the returned data format, refer to “Data Transfer” in Chapter 8.

Query Syntax

`MEMory:READ? DBUF`

Example

`OUTPUT 717;"MEM:READ? DBUF"`

CORRection Subsystem

The `CORRection` subsystem command group sets the correction function, including the cable length correction settings, and the `OPEN/SHORT/LOAD` correction settings. Figure 9-12 shows the command tree of the `CORRection` subsystem command group.

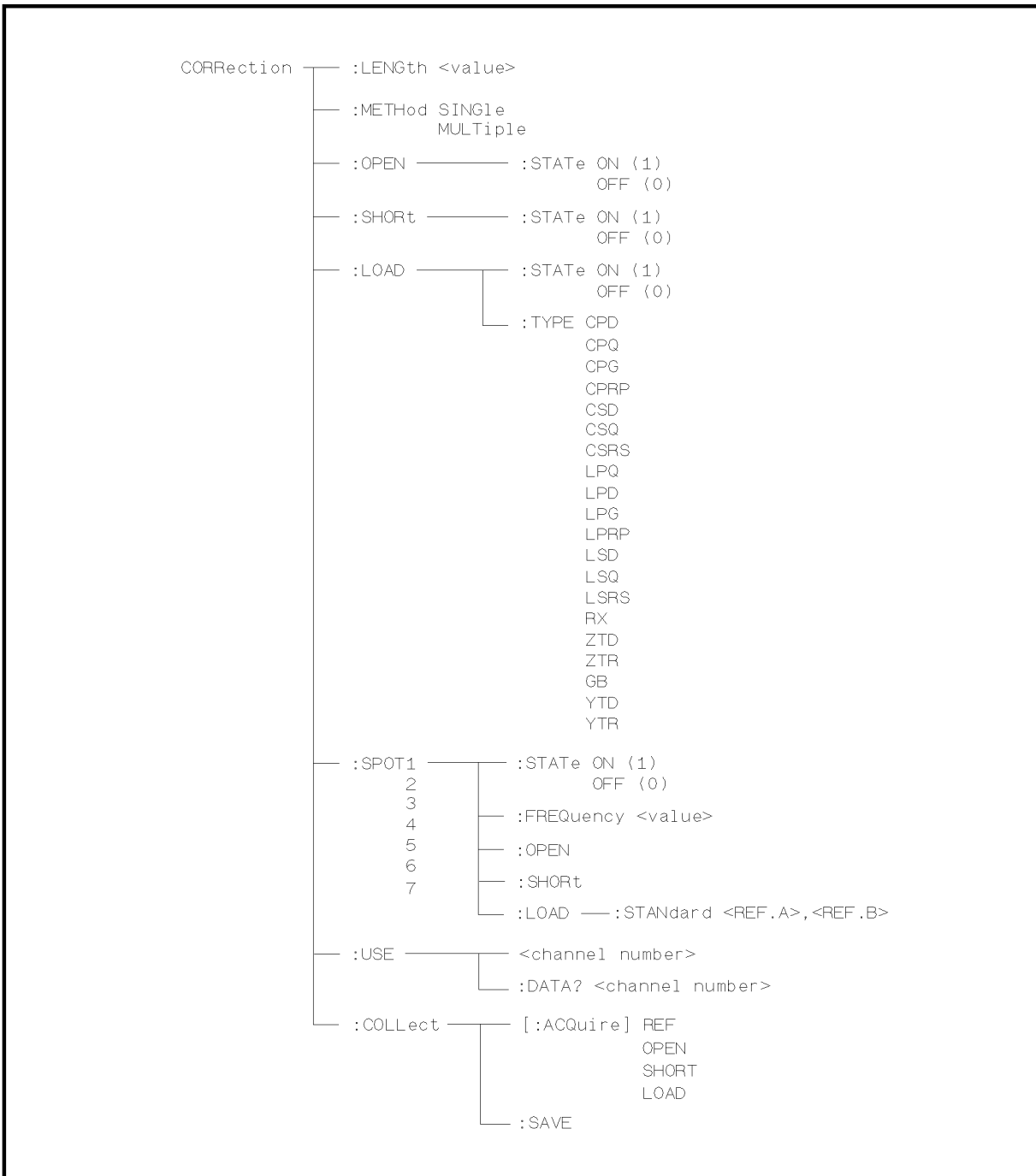

L2009017

Figure 9-12. CORRection Subsystem Command Tree

:LENGth

The :LENGth command sets the cable length correction setting. The :LENGth? query returns the current settings of the cable length correction.

Command Syntax

```
CORRection:LENGth <value>
```

Where,

<value> 0 , 1, or 2 is Cable length in [m]

Note



A suffix with a suffix unit, M (meter), can be used with this command.

Example

```
OUTPUT 717;"CORR:LENG 1M"
```

Query Syntax

```
CORRection:LENGth?
```

Query Response

Returned format is :

```
<NR1><NL^END>
```

Example

```
10 OUTPUT 717;"CORR:LENG?"  
20 ENTER 717;A  
30 PRINT A  
40 END
```

:METHOD

The :METHOD command sets the correction mode. The :METHOD? query returns the current settings of the correction mode.

Command Syntax

$$\text{CORRection:MEtHod} \begin{cases} \text{SINGle} \\ \text{MULTi} \end{cases}$$

Where,

SINGle Sets or returns the single channel correction mode
 MULTi Sets or returns the multi channel correction mode

Example

```
OUTPUT 717;"CORR:METH MULT"
```

Query Syntax

```
CORRection:MEtHod?
```

Query Response

Returned format is :

$$\begin{cases} \text{SING} \\ \text{MULT} \end{cases} \langle \text{NL}^{\wedge} \text{END} \rangle$$
Example

```
10 OUTPUT 717;"CORR:METH?"
20 ENTER 717;A$
30 PRINT A$
40 END
```

:OPEN

The :OPEN command executes 51 presettled OPEN correction data measurement points.

Command Syntax

CORRection:OPEN

Example

OUTPUT 717;"CORR:OPEN"

:OPEN:STATe

The :OPEN:STATe command sets the OPEN correction function to ON or OFF. The :OPEN:STATe? query returns the current ON/OFF condition of the OPEN correction.

Command Syntax

$$\text{CORRection:OPEN:STATe} \left\{ \begin{array}{l} \text{ON} \\ \text{OFF} \\ 1 \\ 0 \end{array} \right\}$$

Where,

1 (decimal 49) When the function is ON
0 (decimal 48) When the function is OFF

Example

```
OUTPUT 717;"CORR:OPEN:STAT ON"
```

Query Syntax

```
CORRection:OPEN:STATe?
```

Query Response

Returned format is :

```
<NR1><NL^END>
```

Example

```
10 OUTPUT 717;"CORR:OPEN:STAT?"  
20 ENTER 717;A  
30 PRINT A  
40 END
```

:SHORT

The :SHORT command executes 51 presettled SHORT correction data measurement points.

Command Syntax

CORRection:SHORt

Example

OUTPUT 717;"CORR:SHOR"

:SHORT:STATE

The :SHORT:STATE command sets the SHORT correction function to ON or OFF. The :SHORT:STATE? query responds the current ON/OFF condition of the SHORT correction.

Command Syntax

$$\text{CORRection:SHORt:STATe} \left\{ \begin{array}{l} \text{ON} \\ \text{OFF} \\ 1 \\ 0 \end{array} \right\}$$

Where,

1 (decimal 49) When the function is ON
0 (decimal 48) When the function is OFF

Example

```
OUTPUT 717;"CORR:SHOR:STAT ON"
```

Query Syntax

```
CORRection:SHORt:STATe?
```

Query Response

Returned format is :

```
<NR1><NL^END>
```

Example

```
10 OUTPUT 717;"CORR:SHOR:STAT?"  
20 ENTER 717;A  
30 PRINT A  
40 END
```

:LOAD:STATe

The :LOAD:STATe command sets the LOAD correction function to ON or OFF. The :LOAD:STATe? query responds the current ON/OFF condition of the LOAD correction.

Command Syntax

$$\text{CORRection:LOAD:STATe} \left\{ \begin{array}{l} \text{ON} \\ \text{OFF} \\ 1 \\ 0 \end{array} \right\}$$

Where,

1 (decimal 49) When the function is ON
0 (decimal 48) When the function is OFF

Example

```
OUTPUT 717;"CORR:LOAD:STAT ON"
```

Query Syntax

```
CORRection:LOAD:STATe?
```

Query Response

Returned format is :

```
<NR1><NL^END>
```

Example

```
10 OUTPUT 717;"CORR:LOAD:STAT?"  
20 ENTER 717;A  
30 PRINT A  
40 END
```

:LOAD:TYPE

The :LOAD:TYPE command sets the function of the reference values for the load correction. The :LOAD:TYPE? query responds the current function of the reference values.

Command Syntax

CORRection:LOAD:TYPE *<function>*

Where, *<function>* is:

CPD	Sets function to C _p -D	LPRP	Sets function to L _p -R _p
CPQ	Sets function to C _p -Q	LSD	Sets function to L _s -D
CPG	Sets function to C _p -G	LSQ	Sets function to L _s -Q
CPRP	Sets function to C _p -R _p	LSRS	Sets function to L _s -R _s
CSD	Sets function to C _s -D	RX	Sets function to R-X
CSQ	Sets function to C _s -Q	ZTD	Sets function to Z- θ (deg)
CSRS	Sets function to C _s -R _s	ZTR	Sets function to Z- θ (rad)
LPQ	Sets function to L _p -Q	GB	Sets function to G-B
LPD	Sets function to L _p -D	YTD	Sets function to Y- θ (deg)
LPG	Sets function to L _p -G	YTR	Sets function to Y- θ (rad)

Example

OUTPUT 717;"CORR:LOAD:TYPE CPD"

Query Syntax

CORRection:LOAD:TYPE?

Query Response

Returned format is :

<function><NL^END>

<function> returns the current function of the reference value, using the abbreviations listed above.

Example

```
10 OUTPUT 717;"CORR:LOAD:TYPE?"
20 ENTER 717;A$
30 PRINT A$
40 END
```

:SPOT<n>:STATe

The :SPOT<n>:STATe command sets the specified frequency point correction (FREQ1-FREQ7) to ON or OFF. The :SPOT<n>:STATe? query responds the current ON/OFF setting of the specified frequency point correction.

Command Syntax
$$\text{CORRection:SPOT}\langle n \rangle\text{:STATe} \left\{ \begin{array}{l} \text{ON} \\ \text{OFF} \\ 1 \\ 0 \end{array} \right\}$$

Where,

1 (decimal 49) When the function is ON
0 (decimal 48) When the function is OFF

<n> is:

1 State setting for FREQ1 point
2 State setting for FREQ2 point
⋮ ⋮
7 State setting for FREQ7 point

Example

```
OUTPUT 717;"CORR:SPOT1:STAT ON"
```

Query Syntax

```
CORRection:SPOT<n>:STATe?
```

Query Response

Returned format is :

```
<NR1><NL^END>
```

Example

```
10 OUTPUT 717;"CORR:SPOT1:STAT?"  
20 ENTER 717;A  
30 PRINT A  
40 END
```

:SPOT<n>:FREQuency

The :SPOT<n>:FREQuency command sets the frequency points (FREQ1 – FREQ7) for the specified frequency point correction. The :SPOT<n>:FREQuency? query returns the current settings of the frequency points (FREQ1 – FREQ7).

Command Syntax

CORRection:SPOT<n>:FREQuency <value>

Where,

<value> is the NR1, NR2, or NR3 format

<n> is:

- 1 Frequency setting for FREQ1 point
- 2 Frequency setting for FREQ2 point
- ⋮
- 7 Frequency setting for FREQ7 point

Example

```
OUTPUT 717;"CORR:SPOT1:FREQ 2MAHZ"! Set 2 MHz to FREQ1
```

Note



A suffix multiplier and a suffix unit, HZ (hertz), can be used with this command. Either MAHZ and MHZ can be used as the suffix multiplier for MHz (1E6 Hz).

Query Syntax

CORRection:SPOT<n>:FREQuency?

Query Response

Returned format is :

<NR3><NL^END>

Example

```
10 OUTPUT 717;"CORR:SPOT1:FREQ?"
20 ENTER 717;A
30 PRINT A
40 END
```

Note



If this query is received when the List Sweep parameter is set to anything other than frequency, error –230 Data corrupt or stale will occur.

:SPOT<n>:OPEN

The :SPOT<n>:OPEN command executes the OPEN correction data measurement for the specified frequency point (FREQ1–FREQ7) correction.

Command Syntax

CORRection:SPOT<n>:OPEN

Where,
<n> is :

- 1 State setting for FREQ1 point
- 2 State setting for FREQ2 point
- ⋮
- 7 State setting for FREQ7 point

Example

OUTPUT 717;"CORR:SPOT1:OPEN"

:SPOT<n>:SHORT

The :SPOT<n>:SHORT command executes the SHORT correction data measurement for the specified frequency point (FREQ1 – FREQ7) correction.

Command Syntax

CORRection:SPOT<n>:SHORT

Where, <n> is:

- 1 State setting for FREQ1 point
- 2 State setting for FREQ2 point
- ⋮
- 7 State setting for FREQ7 point

Example

OUTPUT 717;"CORR:SPOT1:SHOR"

:SPOT<n>:LOAD

The :SPOT<n>:LOAD command executes the LOAD correction data measurement for the specified frequency point (FREQ1 – FREQ7) correction.

Command Syntax

CORRection:SPOT<n>:LOAD

Where,
<n> is :

1	State setting for FREQ1 point
2	State setting for FREQ2 point
⋮	⋮
7	State setting for FREQ7 point

Example

OUTPUT 717;"CORR:SPOT1:LOAD"

:SPOT<n>:LOAD:STANdard

The :SPOT<n>:LOAD:STANdard command sets the reference values of the standard at the specified frequency point (FREQ1 - FREQ7). The :SPOT<n>:LOAD:STANdard? query returns the current settings of the reference values for FREQ1 - FREQ7.

Command Syntax

CORRection:SPOT<n>:LOAD:STANdard <REF.A>,<REF.B>

Where,

<n> 1 Setting for FREQ1 point
 2 Setting for FREQ2 point
 ⋮ ⋮
 7 Setting for FREQ7 point

<REF.A> is the NR1, NR2, or NR3 format :
 Primary parameter's reference value of the standard
 <REF.B> is the NR1, NR2, or NR3 format :
 Secondary parameter's reference value of the
 standard

Example

OUTPUT 717;"CORR:SPOT1:LOAD:STAN 100.7,0.0002"

Query Syntax

CORRection:SPOT<n>:LOAD:STANdard?

Query Response

Returned format is :

<NR3>,<NR3><NL^END>

Example

```
10 OUTPUT 717;"CORR:SPOT1:LOAD:STAN?"
20 ENTER 717;A,B
30 PRINT A,B
40 END
```

:USE

The :USE command sets the channel number to be used for multi channel correction. The :USE? query returns the current settings of the channel selected.

Command Syntax

CORRection:USE <channel number>

Where, <channel number> is : 0 to 89 (NR1, NR2, or NR3) : channel number

Example

OUTPUT 717;"CORR:USE 10" ! Set to channel number 10

Query Syntax

CORRection:USE?

Query Response

Returned format is :

<channel number><NL^END>

Example

```
10 OUTPUT 717;"CORR:USE?"
20 ENTER 717;A
30 PRINT A
40 END
```

:USE:DATA?

The :USE:DATA? query returns the OPEN/SHORT/LOAD correction measurement data at FREQ1 – FREQ7.

Query Syntax

CORRection:USE:DATA? <channel number>

Where, <channel number> is : 0 to 89 (NR1)

Query Response

Returned format is :

```
<open1 A>, <open1 B>, <short1 A>, <short1 B>, <load1 A>,
<load1 B>,
<open2 A>, <open2 B>, <short2 A>, <short2 B>, <load2 A>,
<load2 B>,
<open3 A>, <open3 B>, <short3 A>, <short3 B>, <load3 A>,
<load3 B>,
<open4 A>, <open4 B>, <short4 A>, <short4 B>, <load4 A>,
<load4 B>,
<open5 A>, <open5 B>, <short5 A>, <short5 B>, <load5 A>,
<load5 B>,
<open6 A>, <open6 B>, <short6 A>, <short6 B>, <load6 A>,
<load6 B>,
<open7 A>, <open7 B>, <short7 A>, <short7 B>, <load7 A>,
<load7 B><NL^END>
```

Where,

```
<open1-7 A> NR3 format : primary OPEN correction data at
FREQ1-7.
<open1-7 B> NR3 format : secondary OPEN correction data at
FREQ1-7.
<short1-7 A> NR3 format : primary SHORT correction data at
FREQ1-7.
<short1-7 B> NR3 format : secondary SHORT correction data at
FREQ1-7.
<load1-7 A> NR3 format : primary LOAD correction data at
FREQ1-7.
<load1-7 B> NR3 format : secondary LOAD correction data at
FREQ1-7.
```

Example

```
10 OPTION BASE 1
20 DIM A(18)
30 OUTPUT 717;"CORR:USE:DATA? 89"
40 ENTER 717;A(*)
50 PRINT A(*)
60 END
```

:COL- Lect[:ACQuire]

The :COLlect[:ACQuire] commands execute the cable correction data measurement to adopt the 4285A to individual 16048A/D Test Leads.

Command Syntax

$$\text{CORRection:COLLect[:ACQuire]} \left\{ \begin{array}{l} \text{REF} \\ \text{OPEN} \\ \text{SHORT} \\ \text{LOAD} \end{array} \right\}$$

Where,

REF	Executes the LOAD reference data measurement on the front panel (0 m)
OPEN	Executes the OPEN correction data measurement
SHORT	Executes the SHORT correction data measurement
LOAD	Executes the LOAD correction data measurement

Note



The cable length to be applied for the cable correction must be specified by the CORRection:LENGth command before these correction data measurements are being performed.

Example

OUTPUT 717;"CORR:COLL REF"

OUTPUT 717;"CORR:COLL OPEN"

OUTPUT 717;"CORR:COLL SHORT"

OUTPUT 717;"CORR:COLL LOAD"

:COLLect:SAVE

The :COLLect:SAVE command calculates the cable correction coefficient from the 0 m reference, OPEN, SHORT, and LOAD correction data previously measured, and stores the data into the system configuration memory (EEPROM).

Command Syntax

CORRection:COLLect:SAVE

Example

OUTPUT 717;"CORR:COLL:SAVE"

COMParator Subsystem

The COMParator subsystem command group sets the comparator function, including its ON/OFF setting, limit mode, and limit values. Figure 9-7 shows the command tree of the COMParator subsystem command group.

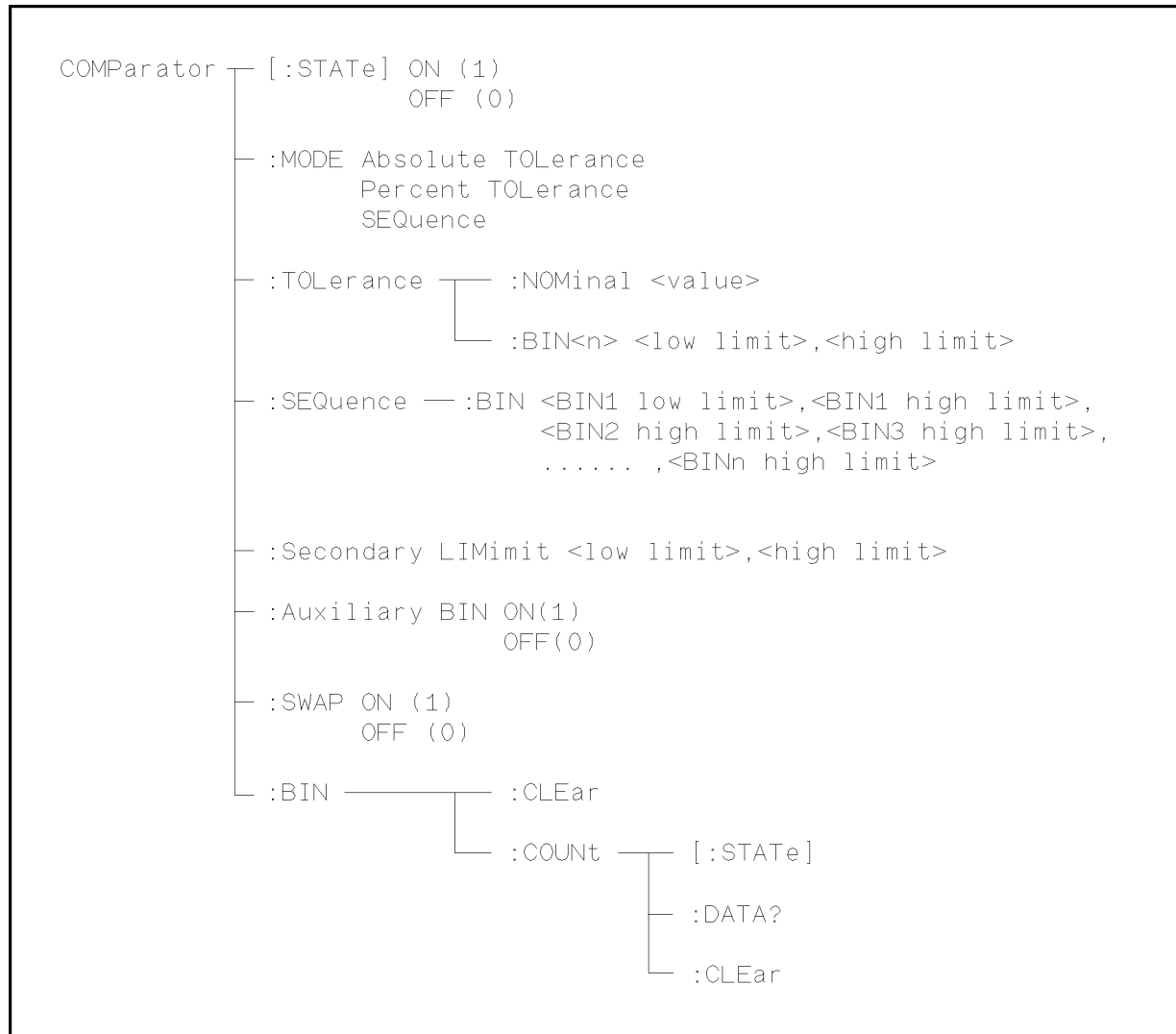

2009016

Figure 9-13. COMPArator Subsystem Command Tree

[:STATe]

The [:STATe] command sets the comparator function to ON or OFF. The [:STATe]? query responds the current ON/OFF condition of comparator function.

Command Syntax

$$\text{COMParator}[:\text{STATe}] \left\{ \begin{array}{l} \text{ON} \\ \text{OFF} \\ 1 \\ 0 \end{array} \right\}$$

Where,

1 (decimal 49) When the function is ON
0 (decimal 48) When the function is OFF

Example

OUTPUT 717;"COMP ON"

Query Syntax

COMParator[:STATe]?

Query Response

Returned format is :

<NR1><NL^END>

Example

10 OUTPUT 717;"COMP?"
20 ENTER 717;A
30 PRINT A
40 END

:MODE

The :MODE command sets the limit mode of the comparator function. The :MODE? query returns the current settings of the limit mode.

Command Syntax

$$\text{COMPARATOR:MODE} \left\{ \begin{array}{l} \text{ATOLerance} \\ \text{PTOLerance} \\ \text{SEQuence} \end{array} \right\}$$

Where,

ATOLerance Set the absolute tolerance mode (parameter value)
PTOLerance Set the percent tolerance mode (the ratio in percent)
SEQuence Set the sequential mode

Example

```
OUTPUT 717;"COMP:MODE ATOL"
```

Query Syntax

```
COMPARATOR:MODE?
```

Query Response

Returned format is:

$$\left\{ \begin{array}{l} \text{ATOL} \\ \text{PTOL} \\ \text{SEQ} \end{array} \right\} \langle \text{NL} \wedge \text{END} \rangle$$

Example

```
10 OUTPUT 717;"COMP:MODE?"  
20 ENTER 717;A$  
30 PRINT A$  
40 END
```

**:TOLer-
ance:NOMinal**

The :TOLerance:NOMinal command sets the nominal value for the tolerance mode of the comparator function. This can be set only when the limit mode is set to the tolerance mode. The :TOLerance:NOMinal? query returns the current settings of the nominal value for the tolerance mode.

Command Syntax

COMParator:TOLerance:NOMinal <value>

Where,

<value> is the NR1, NR2, or NR3 format : nominal value

Example

OUTPUT 717;"COMP:TOL:NOM 100E-12"

Query Syntax

COMParator:TOLerance:NOMinal?

Query Response

Returned Format is :

<NR3><NL^END>

Example

```
10 OUTPUT 717;"CORR:TOL:NOM?"
20 ENTER 717;A
30 PRINT A
40 END
```

:TOLerance:BIN<n>

The :TOLerance:BIN<n> command sets the low/high limit values of each BIN for the comparator function tolerance mode. These limits can be set only when the limit mode is set to the tolerance mode. The :TOLerance:BIN<n> query returns the current settings of the low/high limit values of each of the BINs.

Command Syntax

COMPArator:TOLerance:BIN<n> <low limit>,<high limit>

Where,

<n> 1 to 9 (NR1) : BIN number
<low limit> NR1, NR2, or NR3 format : low limit value
<high limit> NR1, NR2, or NR3 format : high limit value

Note

The low limit value should be lower than the high limit value. If the low limit value is set higher than the high limit, a warning message is displayed when this command is received (an error does not occur).

Example

OUTPUT 717;"COMP:TOL:BIN1 -5,5"

OUTPUT 717;"COMP:TOL:BIN2 -10,10"

Query Syntax

COMPArator:TOLerance:BIN<n>?

Query Resopnse

Returned Format is :

<low limit>,<high limit><NL^END>

Example

```
10 OUTPUT 717;"COMP:TOL:BIN1?"  
20 ENTER 717;A,B  
30 PRINT A,B  
40 END
```

:SEquence:BIN

The :SEquence:BIN command sets the low/high limit values of the BINs for the sequence mode of the comparator function. These limits can be set only when the limit mode is set to the sequence mode. The :SEquence:BIN query returns the current settings of the low/high limit values of the BINs.

Command Syntax

```
COMParator:SEquence:BIN <BIN1 low limit>,<BIN1 high
limit>,<BIN2 high limit>, ... , <BINn high limit>
```

Where,

```
<BIN1 low limit>   NR1, NR2, or NR3 format : low limit value for
                    BIN1
<BIN1 high limit>  NR1, NR2, or NR3 format : high limit value for
                    BIN1
<BINn high limit>  NR1, NR2, or NR3 format : high limit value for
                    BINn (n : max. 9 )
```

Note

The low limit value should be lower than the high limit value.

Example

```
OUTPUT 717;"COMP:SEQ:BIN 10,20,30,40,50"
```

Query Syntax

```
COMParator:SEquence:BIN?
```

Query Response

Returned Format is :

```
<BIN1 low limit>,<BIN1 high limit>,<BIN2 high limit>, ... ,
<BINn high limit><NL^END>
```

Example

```
10 DIM A$[200]
20 OUTPUT 717;"COMP:SEQ:BIN?"
30 ENTER 717;A$
40 PRINT A$
50 END
```

:Secondary LIMit

The :Secondary LIMit command sets the low/high limit values for the comparator function secondary parameter. The :Secondary LIMit? query returns the current settings of the secondary parameter low/high limit values.

Command Syntax

```
COMPARATOR:SLIMit <low limit>,<high limit>
```

Where,

<low limit> is the NR1, NR2, or NR3 format : low limit value

<high limit> is the NR1, NR2, or NR3 format : high limit value

Note



The low limit value should be lower than the high limit value. If the low limit value is set higher than the high limit, a warning message is displayed when this command is received (an error does not occur).

Example

```
OUTPUT 717;"COMP:SLIM 0.001,0.002"
```

Query Syntax

```
COMPARATOR:SLIMit?
```

Query Response

Returned Format is:

```
<NR3>,<NR3><NL^END>
```

Example

```
10 OUTPUT 717;"COMP:SLIM?"
20 ENTER 717;A,B
30 PRINT A,B
40 END
```

:Auxiliary BIN

The :Auxiliary BIN command sets the auxiliary BIN counting function of the comparator to ON or OFF. The :Auxiliary BIN query responds the current ON/OFF condition of the auxiliary BIN counting function.

Command Syntax

$$\text{COMParator:Auxiliary BIN} \left\{ \begin{array}{l} \text{ON} \\ \text{OFF} \\ 1 \\ 0 \end{array} \right\}$$

Where,

0 (decimal 48) When the function is OFF

1 (decimal 49) When the function is ON

Example

```
OUTPUT 717;"COMP:ABIN ON"
```

Query Syntax

```
COMParator:Auxiliary BIN?
```

Query Response

Returned Format is :

```
<NR1><NL^END>
```

Example

```
10 OUTPUT 717;"COMP:ABIN?"
20 ENTER 717;A
30 PRINT A
40 END
```

:SWAP

The :SWAP command sets the swap parameter function to ON (9 BIN settings for secondary parameter) or OFF (9 BIN settings for primary parameter). The :SWAP? query responds the current ON/OFF condition of the auxiliary BIN counting function.

Command Syntax

$$\text{COMParator:SWAP} \left\{ \begin{array}{l} \text{ON} \\ \text{OFF} \\ 1 \\ 0 \end{array} \right\}$$

Where,

0 (decimal 48) When the function is OFF

1 (decimal 49) When the function is ON

Example

```
OUTPUT 717;"COMP:SWAP ON"
```

Query Syntax

```
COMParator:SWAP?
```

Query Response

Returned Format is :

```
<NR1><NL^END>
```

Example

```
10 OUTPUT 717;"COMP:SWAP?"
20 ENTER 717;A
30 PRINT A
40 END
```

:BIN:CLEar

The :BIN:CLEar command clears all of the limit value settings.

Command Syntax

COMParator:BIN:CLEar

Example

OUTPUT 717;"COMP:BIN:CLE"

:BIN:COUNT[:STATe]

The :BIN:COUNT[:STATe] command sets the BIN count function to ON or OFF. The :BIN:COUNT[:STATe]? query responds with the current ON/OFF condition of the BIN count function.

Command Syntax
$$\text{COMParator:BIN:COUNT} [:\text{STATe}] \left\{ \begin{array}{l} \text{ON} \\ \text{OFF} \\ 1 \\ 0 \end{array} \right\}$$

Where,

0 (decimal 48) When the function is OFF
1 (decimal 49) When the function is ON

Example

```
OUTPUT 717;"COMP:BIN:COUN ON"
```

Query Syntax

```
COMParator:BIN:COUNT [ :STATe ] ?
```

Query Response

Returned Format is :

```
<NR1><NL^END>
```

Example

```
10 OUTPUT 717;"COMP:BIN:COUN?"  
20 ENTER 717;A  
30 PRINT A  
40 END
```

:BIN:COUNT:DATA?

The :BIN:COUNT:DATA? query returns the comparator BIN count results.

Query Syntax

COMPARATOR:BIN:COUNT:DATA?

Query Response

Returned Format is :

<BIN1 count>, *<BIN2 count>*, ... , *<BIN9 count>*, *<OUT OF BIN count>*, *<AUX BIN count>* <NL^END>

Where,

<BIN1-9 count>

NR1 format : count result of BIN1-9

<OUT OF BINS count>

NR1 format : count result of OUT OF BINS

<AUX BIN count>

NR1 format : count result of AUX BIN

Example

```

10 OPTION BASE 1
20 DIM A(11)
30 OUTPUT 717;"COMP:BIN:COUN:DATA?"
40 ENTER 717;A(*)
50 PRINT A(*)
60 END

```

:BIN:COUNT:CLEAr

The :BIN:COUNT:CLEAr command clears all BIN counts.

Command Syntax

COMParator:BIN:COUNT:CLEAr

Example

OUTPUT 717;"COMP:BIN:COUN:CLE"

Mass MEMory Subsystem

The Mass MEMory subsystem command group loads or stores setting data from/to the internal EEPROM and the external memory card. Figure 9-14 shows the command tree of the Mass MEMory subsystem command group.

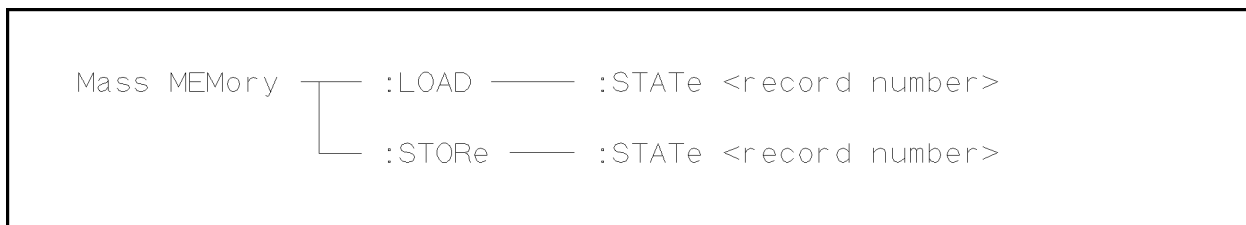

2009019

Figure 9-14. Mass MEMory Subsystem Command Tree

:LOAD:STATe

The :LOAD:STATe command loads the setting data from the internal EEPROM or a memory card.

Command Syntax

MMEMory:LOAD:STATe <value>

Where,

<value> 0 to 9 (NR1) : record number for internal EEPROM
 10 to 19 (NR1) : record number for memory card

Example

OUTPUT 717;"MMEM:LOAD:STAT 10"

:STORe:STATe

The :STORe:STATe command stores the setting data to the internal EEPROM or to the memory card.

Command Syntax

MMEMoRY:STORe:STATe *<value>*

Where,

<value> 0 to 9 (NR1) : record number for EEPROM
 10 to 19 (NR1) : record number for memory card

Example

OUTPUT 717;"MMEM:STOR:STAT 5"

SYSTem:ERRor?

The SYSTem:ERRor? query returns the existing error numbers with the error messages for the errors in the 4285A's error queue.

The 4285A's error queue stores errors generated by the 4285A. As errors are generated, they are placed in the error queue which stores up to five errors. This is a first in, first out queue (FIFO).

If the error queue overflows, the last error in the queue is replaced with error -350, "Too many errors". Anytime the queue overflows, the least recent errors remain in the queue, and the most recent errors are discarded.

When all errors have been read from the queue, further SYSTem:ERRor? queries will return error 0, "no errors". Reading an error from the queue removes that error from the queue, opening a position in the queue for a new error, if one is subsequently generated.

Query Syntax

SYSTem:ERRor?

Query Response

Returned Format is :

<number>,"*<message>*"

Where,

<number> NR1 format : error number
For details, refer to Appendix B.

<message> ASCII string : error message
For details, refer to Appendix B.

Example

```
10 DIM A$(50)
20 FOR I=1 to 5
30  OUTPUT 717;"SYST:ERR?"
40  ENTER 717;A$
50  PRINT A$
60 NEXT I
70 END
```

STATus Subsystem

The STATus subsystem command group sets the Operation Status Registers which report events which are part of the 4285A's normal operation, including measuring and sweeping. Figure 9-15 shows the command tree of the STATus subsystem command group.

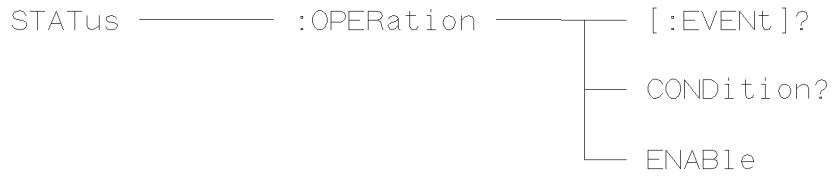

L2009020

Figure 9-15. STATus Subsystem Command Tree

:OPERation[:EVENT]?

The :OPERation[:EVENT]? query returns the contents of the standard operation status event register. Reading the event register using this query has the effect of clearing its contents, but has no effect on the the operation status condition register.

Query Syntax

```
STATus:OPERation[:EVENT]?
```

Query Response

Returned Format is :

```
<value><NL^END>
```

Where,

<value> NR1 format : decimal expression of the contents of the operation status event register

The definition of each bit of the operation status event register is as follows.

Bit No.	Description
15 - 5	Always 0 (zero)
4	Measurement Complete Bit
3	List Sweep Measurement Complete Bit
2, 1	Always 0 (zero)
0	Correction Data Measurement Complete Bit

Example

```
10 OUTPUT 717;"STAT:OPER?"
20 ENTER 717;A
30 PRINT A
40 END
```

:OPERa- tion:CONDition?

The :OPERation:CONDition? query returns the contents of the standard operation status condition register. Reading a condition register using this query does not clear its contents.

Query Syntax

STATus:OPERation:CONDition?

Query Response

Returned Format is :

<value><NL^END>

Where,

<value> NR1 format : decimal expression of the contents of the operation status condition register

The definition of each bit in the operation status condition register is as follows.

Bit No.	Description
15 - 5	Always 0 (zero)
4	Measuring Bit
3	Sweeping Bit
2, 1	Always 0 (zero)
0	Measuring Correction Data Bit

Example

```
10 OUTPUT 717;"STAT:OPER:COND?"  
20 ENTER 717;A  
30 PRINT A  
40 END
```

:OPERation:ENABle

The :OPERation:ENABle command sets the enable bits of the standard operation status event register that allows true conditions in the event register to be reported in the summary bit of the status byte register. The :OPERation:ENABle? query returns the current setting of the enable bits of the operation status event register.

Command Syntax

```
STATus:OPERation:ENABle <value>
```

Where,

<value> NR1 format : decimal expression of enable bits of the operation status event register

The definition of each bit in the operation status event register is as follows.

Bit No.	Description
15 - 5	Always 0 (zero)
4	Measurement Complete Bit
3	List Sweep Measurement Complete Bit
2, 1	Always 0 (zero)
0	Correction Data Measurement Complete Bit

Example

```
OUTPUT 717;"STAT:OPER:ENAB 16"! Bit 4 enable
```

Query Syntax

```
STATus:OPERation:ENABle?
```

Query Response

Returned Format is:

```
<value><NL^END>
```

Example

```
10 OUTPUT 717;"STAT:OPER:ENAB?"
20 ENTER 717;A
30 PRINT A
40 END
```

Common Commands

The GPIB Common commands (from chapter 8) are defined as IEEE 488.2-1987, and are noninstrument specific GPIB commands. A common command consists of an asterisk (*) and a header. The 4285A acceptable GPIB common commands are as follows.

GPIB Common Commands

- *CLS
- *ESE
- *ESR?
- *SRE
- *STB
- *IDN?
- *OPC?
- *WAI?
- *RST
- *TST?
- *TRG
- *LRN?
- *OPT?

***CLS**

The *CLS command (clear status command) clears the status byte register, the event register of the standard operation status register structure, and the standard event status register. It also clears the error queue (refer to the description of the SYSTem:ERRor? query).

Command Syntax

*CLS

Example

OUTPUT 717;"*CLS"

*ESE

The *ESE command (standard Event Status Enable command) sets the enable bits of the standard event status register. The *ESE? query returns the current setting of the enable bits of the event status register.

Command Syntax

*ESE <value>

Where,

<value> NR1 format : decimal expression of enable bits of the operation status register

The definition of each bit in the event status register is as follows.

Bit No.	Description
7	Power On (PON) Bit
6	User Request (URQ) Bit
5	Command Error (CME) Bit
4	Execution Error (EXE) Bit
3	Device Dependent Error (DDE) Bit
2	Query Error (QYE) Bit
1	Request Control (RQC) Bit
0	Operation Complete (OPC) Bit

Example

OUTPUT 717;"*ESE 36"! Bit 2 and 5 enabled

Query Syntax

*ESE?

Query Response

Returned format is :

<value><NL^END>

Example

```
10 OUTPUT 717;"*ESE?"
20 ENTER 717;A
30 PRINT A
40 END
```

***ESR?**

The *ESR? query returns the contents of the standard event status register. Using the *ESR query command to read the standard event status register clears its contents.

Query Syntax

*ESR?

Query Response

Returned format is :

<value><NL^END>

Where,

<value> NR1 format : decimal expression of the contents of the event status register

The definition of each bit of the event status register is as follows.

Bit No.	Description
7	Power On (PON) Bit
6	User Request (URQ) Bit
5	Command Error (CME) Bit
4	Execution Error (EXE) Bit
3	Device Dependent Error (DDE) Bit
2	Query Error (QYE) Bit
1	Request Control (RQC) Bit
0	Operation Complete (OPC) Bit

Example

```
10 OUTPUT 717;"*ESR?"
20 ENTER 717;A
30 PRINT A
40 END
```

***SRE**

The *SRE command (Service Request Enable command) sets the enable bits of the status byte register. The *SRE? query returns the current setting of the status byte register.

Command Syntax

*SRE *<value>*

Where,

<value> NR1 format : decimal expression of enable bits of the status byte register

The definition of each bit of the status byte register is as follows.

Bit No.	Description
7	Operation Status Register Summary Bit
6	RQS (Request Service) Bit
5	Standard Event Status Register Summary Bit
4	MAV (Message Available) Bit
3 - 0	Always 0 (zero)

Example

OUTPUT 717;"*SRE 32"! Bit 5 enabled

Query Syntax

*SRE?

Query Response

Returned format is :

<value><NL^END>

Example

```
10 OUTPUT 717;"*SRE?"
20 ENTER 717;A
30 PRINT A
40 END
```

***STB?**

The *STB? query reads the status byte by reading the master summary status (MSS) bit. These bits represent the contents of the status byte register. Execution of the *STB query command has no effect on the contents of the status byte register.

Query Syntax

*STB?

Query Response

Returned format is :

<value><NL^END>

Where,

<value> NR1 format : decimal expression of the contents of the status byte register

The definition of each bit of the status byte is as follows.

Bit No.	Description
7	Operation Status Register Summary Bit
6	RQS (Request Service) Bit
5	Standard Event Status Register Summary Bit
4	MAV (Message Available) Bit
3 - 0	Always 0 (zero)

Example

```
10 OUTPUT 717;"*STB?"
20 ENTER 717;A
30 PRINT A
40 END
```

*IDN?

The *IDN? query returns the 4285A ID.

Query Syntax

*IDN?

Query Response

Returned format is :

<manufacturer>,*<model>*,*<serial no.>*,*<firmware>*<NL^END>

Where,

<manufacturer> Agilent Technologies
<model> 4285A
<serial number> 0 (not available)
<firmware> REVdd.dd
(dd.dd : ROM firmware revision number)

Example

```
10 DIM A$[30]
20 OUTPUT 717;"*IDN?"
20 ENTER 717;A$
30 PRINT A$
40 END
```

Note



This string data is an arbitrary ASCII response. So, this command should not be sent before a normal query in a program message. (For example, *IDN?;FREQ? can not accepted, FREQ?;*IDN? should be sent.)

***OPC**

The *OPC command (operation complete command) tells the 4285A to set bit 0 (OPC bit) in the standard event status register when it completes all pending operations. The *OPC? command tells the 4285A to place an ASCII "1" (decimal 49) in the 4285A's output buffer when it completes all pending operations.

Command Syntax *OPC

Example

```
OUTPUT 717;"*OPC" ! Set the 4285A to set OPC bit
! when the operation executed by previous command is completed.
```

Query Syntax *OPC?

Query Response Returned format is :

```
1<NL^END>
```

Where,

```
1      1 (ASCII, decimal 49)
```

Example

```
10 OUTPUT 717;"CORR:OPEN" ! Perform OPEN correction measurement
20 OUTPUT 717;"*OPC?"     ! Wait for OPEN correction
30 ENTER 717;A            !     measurement completed
40 END
```

***WAI**

The *WAI command (the wait to continue command) makes the 4285A wait until all previously sent commands are completed. The 4285A then continues executing the commands that follow the *WAI command.

Command Syntax

*WAI

Example

OUTPUT 717; "*WAI"

***RST**

The *RST command (reset command) sets the 4285A to its initial settings. The initial settings set by the *RST command are given in Appendix C. When the 4285A receives a *RST command, it aborts all pending operations, and forgets about any previously received *OPC commands and *OPC? queries.

Command Syntax

*RST

Example

OUTPUT 717;"*RST"

***TST?**

The *TST? query (self-test query) causes the device to execute an internal self-test and reports whether or not it detected any errors. In the case of the 4285A, the response to this query is always "0" (no error).

Query Syntax

*TST?

Query Response

Returned format is :

0<NL^END>

Where,

0 0 (NR1 format)

Example

```
10 OUTPUT 717;"*TST?"
20 ENTER 717;A
30 END
```

***TRG**

The *TRG command (trigger command) performs the same function as the Group Execute Trigger command (refer to “Trigger System” in Chapter 8). This command also moves the primary and secondary parameter measurement data into the 4285A’s output buffer.

Command Syntax***TRG****Example**

```
10 OUTPUT 717;"*TRG"  
20 ENTER 717;A,B,C  
30 PRINT A,B,C  
40 END
```

*LRN?

The *LRN? query (learn device setup query) tells the 4285A to send a response that contains all the necessary commands to set the 4285A to its present state. The response can later be sent back to the 4285A to place it in this state. This provides the user with a means of setting up a device manually and then reading the device setting and storing the information for later use.

Query Syntax

*LRN?

Query Response

Returned format is :

```
:FREQ <NR3>;
:VOLT (or CURR) <NR3>;
:AMPL:ALC {0|1};
(:BIAS:VOLT (or CURR) <NR3>:STAT {0|1};)—in case of #001 or
CONFIG = I-BIAS
(:OUTP:BMON:VOLT {0|1};CURR {0|1};)—in case of #001 is installed
:CORR:LENG <NR1>;METH {SING|MULT};
:CORR:OPEN:STAT {0|1};
:CORR:SHOR:STAT {0|1};
:CORR:LOAD:STAT {0|1};TYPE <function>;
:CORR:SPOT1:STAT {0|1};FREQ <NR3>;LOAD:STAN
<REF.A>,<REF.B>;
:CORR:SPOT2:STAT {0|1};FREQ <NR3>;LOAD:STAN
<REF.A>,<REF.B>;
:CORR:SPOT3:STAT {0|1};FREQ <NR3>;LOAD:STAN
<REF.A>,<REF.B>;
:CORR:SPOT4:STAT {0|1};FREQ <NR3>;LOAD:STAN
<REF.A>,<REF.B>;
:CORR:SPOT5:STAT {0|1};FREQ <NR3>;LOAD:STAN
<REF.A>,<REF.B>;
:CORR:SPOT6:STAT {0|1};FREQ <NR3>;LOAD:STAN
<REF.A>,<REF.B>;
:CORR:SPOT7:STAT {0|1};FREQ <NR3>;LOAD:STAN
<REF.A>,<REF.B>;
:CORR:USE <NR1>;
:FUNC:IMP:TYPE <function>;RANG <NR3>;RANG:AUTO {0|1};
:FUNC:SMON:VAC:STAT {0|1};FUNC:SMON:IAC:STAT {0|1};
:FUNC:DEV1:MODE {ABS|PERC|OFF};REF <NR3>;
:FUNC:DEV2:MODE {ABS|PERC|OFF};REF <NR3>;
:APER {SHOR|MED|LONG},<NR1>;
:TRIG:SOUR {INT|EXT|BUS|HOLD};DEL <NR3>;
:DISP:PAGE <page name>;LINE "<string>";
:FORM {ASC|REAL}[ ,64];
:COMP:STAT {0|1};MODE {ATOL|PTOL|SEQ};
(TOL:NOM <NR3>;BIN1 <low>,<high>;BIN2 <low>,<high>,...;)
or (:COMP:SEQ:BIN <BIN1 low>,<BIN2 high>,<BIN3 high>,...;)
:COMP:SLIM <low>,<high>;ABIN {0|1};SWAP {0|1};BIN:COUN
{0|1};:LIST:FREQ (VOLT,CURR,BIAS:VOLT,or BIAS:CURR) <NR3>
[,<NR3>*];
:LIST:MODE {SEQ|STEP};
BAND1 <parameter>,<low>,<high>;
BAND2 <parameter>,<low>,<high>;
... ; BAND<n>
```

<parameter>, *<low>*, *<high>*

For details, refer to each command reference page.

Example

```
10 DIM A$[1000]
20 OUTPUT 717;"*LRN?"
30 ENTER 717;A$
40 !
50 OUTPUT 717;A$
60 END
```

*OPT?

The *OPT? query (OPTion identification query) tells the 4285A to identify the options installed in the system interface.

Query Syntax

*OPT?

Query Response

Returned format is :

<DC bias>, *<accessory control I/F>*, *<handler I/F>*, *<scanner I/F>* <NL^END>

Where,

<i><DC bias></i> is :	001 (ASCII) : Option 001 is installed
	0 (ASCII) : Option 001 is not installed
<i><accessory control I/F></i> is :	002 (ASCII) : Option 002 is installed
	0 (ASCII) : Option 002 is not installed
<i><handler I/F></i> is :	201 (ASCII) : Option 201 is installed
	202 (ASCII) : Option 202 is installed
	0 (ASCII) : Option 201 and 202 are not installed
<i><scanner I/F></i> is :	301 (ASCII) : Option 301 is installed
	0 (ASCII) : Option 301 is not installed

Note



This string data is the arbitrary ASCII response. So this command should not be sent before a normal query in a program message. (For example, *OPT?;FREQ? can not accepted, FREQ?;*OPT? should be sent.)

Example

```
10 OUTPUT 717;"*OPT?"
20 ENTER 717;A$
30 END
```

Manual Changes

Introduction

This appendix contains the information required to adapt this manual to earlier versions or configurations of the 4285A than the current printing date of this manual. The information in this manual applies directly to 4285A Precision LCR Meter whose serial number prefix is listed on the title page of this manual.

Manual Changes

To adapt this manual to your 4285A, refer to Table A-1 and Table A-2, and make all of the manual changes listed opposite your instrument's serial number and ROM-based firmware's version.

Instruments manufactured after the printing of this manual may be different than those documented in this manual. Later instrument versions will be documented in a manual changes supplement that will accompany the manual shipped with that instrument. If your instrument serial number is not listed on the title page of this manual or in Table A-1, it may be documented in a *yellow MANUAL CHANGES* supplement.

Refer to the description of the *IDN? query in “*IDN?” in Chapter 9 for confirmation of the ROM-based firmware's version. For additional information on serial number coverage, refer to “Serial Number” in Chapter 1.

Table A-1. Manual Changes by Serial Number

Serial Prefix or Number	Make Manual Changes
3041J02018 and below	1

Table A-2. Manual Changes by Firmware's Version

Version	Make Manual Changes

CHANGE1

4285A Operation Manual :Page 1-19 Other Options Delete this accessories.

Option 004 Memory Card

4285A Operation Manual :Page 1-20 Furnished Accessories

Add this accessories.

Memory Card Agilent Part Number 04278-89001

4285A Operation Manual :Page 2-2, Table 2-1. 4285A Contents

Change the following table.

Table 2-1. 4285A Contents

Description	Qty.	Agilent Part Number
4285A		
Power cable ¹	1	—
Memory Card	1	04278-89001
100Ω Resister Box	1	04285-61001
BNC Female-Female Adapter	4	1250-0080
Operation Manual	1	04284-90010
Maintenance Manual	1	04285-90030
Option 201 Fuse		
Fuse	2	2110-0046
Option 907 Handle Kit		
Handle kit	1	5061-9690
Option 908 Rack Flange Kit		
Rack Flange Kit	1	5061-9678
Option 909 Rack Flange & Handle Kit		
Rack Flange and Handle Kit	1	5061-9684

¹ Power Cable depends on where the instrument is used, see “Power Cable” in Chapter 2.

Error and Warning Messages

Introduction

This appendix lists the 4285A's error and warning messages with brief descriptions and solutions.

Error Messages

The 4285A displays error messages on the System Message Line when a measurement error occurs or when an illegal operation is attempted. There are two categories of errors as follows.

Operation Errors

These errors occur while attempting an improper operation. If one of these errors occur, the 4285A displays the error number and a message on its system message line. There are two kinds of errors in this category.

- Device-Specific Error (error numbers 1 to 32767, –300 to –399)
These errors will set the Device-Specific Error bit (bit 3) in the Event Status Register.
- Execution Error (error numbers –200 to –299)
These errors will set the Execution Error bit (bit 4) in the Event Status Register.

GPIB Errors

These errors occur when the 4285A received an improper command via GPIB. If one of these errors occur, the 4285A displays the warning message, GPIB error occurred on the system message line, check the command syntax. There are two kinds of errors in this category.

- Command Error (error numbers –100 to –199)
These errors will set the Command Error bit (bit 5) in the Event Status Register.
- Query Error (error numbers –400 to –499)
These errors will set the Query Error bit (bit 2) in the Event Status Register.

Sample Program to Detect the Error

When you write an GPIB control program for the 4285A, the following sample program is a useful debugging tool (using the 4285A status bytes and the SYST:ERROR? query) for detecting the errors.

```

100  OUTPUT 717;"*ESE 60"           ! Event Status Register enable
110                                     ! (error bits enable)
120  OUTPUT 717;"*SRE 32"         ! Status Byte Register enable
130                                     ! (Event Status Summary bit enable)
140  ON INTR 7,2 CALL Errors
150  ENABLE INTR 7;2

```

```

      :
500   SUB Errors
510   DIM Err$[50]
520   Sp=SPOLL(717)
530   IF BIT(Sp,5) THEN
540     OUTPUT 717;"*ESR?"      ! Clear the Event Status Resister
550     ENTER 717;Esr
560     PRINT "Event Status Resister =";Esr
570     LOOP
580       OUTPUT 717;"SYST:ERR?"! Error No. & message query
590       ENTER 717;Err$
600       EXIT IF VAL(Err$)=0   ! Exit if no error
610       PRINT Err$
620     END LOOP
630   END IF
640   ENABLE INTR 7;2
650   SUBEND

```

The following is a list of the 4285A's error numbers and messages.

Operation Errors

Error No.	Displayed Message	• Description
		→ Solution
Device-Specific Error		
12	DC bias ON/OFF ignored	• Illegal operation, DC BIAS is pressed while in the comment input mode.
		→ Press DC BIAS after exiting the comment input page.
14	V bias disabled	• Illegal operation, set to DC voltage bias while in the high current DC biased measurement mode.
		→ Set the <i>CONFIG</i> field to OFF , or change BIAS to a current value.
15	I bias not available	• Illegal operation, set to DC current bias when the accessory control interface cable or the 42842C are not properly connected.
		→ Properly connect the accessory control interface cable and 42842C.
16	Measurement aborted	• Δ REF data Measurement aborted.
		→ Re-measure.
18	DC bias Opt not installed	• Internal DC bias Option is not installed.
		→ Install Option 001.
19	Bias monitor disabled	• Illegal operation, set the DC bias monitor mode while in the high current DC biased measurement mode.
		→ Set <i>CONFIG</i> field to OFF .

Error No.	Displayed Message	• Description
		→ Solution
20	DC bias unit powered down	• Illegal operation, set to DC current bias when an inoperative 42841A is connected to the 4285A.
		→ Turn the 42841A on after checking the power cord connection and 42842C connection.
21	Fixture circuit defective	• Back-emf protection circuit of the 42842C is defective.
		→ Contact your nearest Agilent Technologies office.
22	Fixture over temperature	• Temperature of the 42842C bias current test fixture exceeded its limit.
		→ Turn the DC BIAS off to let the 42842C cool down.
23	Fixture OPEN det. defective	• Fixture cover open detection wire is open.
		→ Contact your nearest Agilent Technologies office.
24	Fixture cover open	• The cover of the 42842C is open.
		→ Close the cover of the 42842C.
25	DC bias I source overload	• The DC bias source current is overloaded.
		→ If this message is displayed all the time when measuring a DUT which conforms to specifications, contact your nearest Agilent Technologies office.
26	DC bias I sink overload	• The DC bias sink current is overloaded.
		→ If this message is displayed all the time when measuring a DUT which conforms to specifications, contact your nearest Agilent Technologies office.

Error No.	Displayed Message	• Description
		→ Solution
40	Scanner I/F disabled	• Illegal operation, MULTI channel correction mode set or CORRection:USE command is sent via GPIB when the SCANNER I/F is not installed or to OFF.
		→ Install the SCANNER I/F and set it to ON.
41	Measurement aborted	• Correction data measurement aborted.
		→ Re-measure.
43	Measurement failed	• Measurement error, (for example, bridge unbalance), occurred during the correction data measurement.
		→ Confirm measurement condition and measurement contacts, then re-measure.
44	Correction data protected	• Correction data write protected by DIP switch A7SW3. (Refer to Appendix D)
		→ Set bit 6 of DIP switch A7SW3 to the OFF position, and retry.
45	Valid in single mode only	• Illegal operation, OPEN/SHORT correction data (for 51 frequency points) measured when the MULTI channel correction mode is set.
		→ Set to SINGLE mode first, or perform OPEN/SHORT data measurements at FREQ1-7.
46	Correction memory error	• Correction data write error.
		→ Contact your nearest Agilent Technologies office.
47	1m cable only to I BIAS	• Illegal operation, cable length was changed while in the high current DC biased measurement mode.
		→ Set the CONFIG field to OFF or do not change CABLE field in the high current DC biased measurement mode.

Error No.	Displayed Message	• Description
		→ Solution
50	Clear the table first	• Illegal operation, MODE of the LIMIT TABLE changed when the table exists.
		→ Clear the table first.
51	Inconsistent limit setting	• Illegal operation, COMPArator:SEQuence command sent when the TOLerance mode is set, or the COMPArator:TOLerance command was sent when the SEQuence mode is set.
		→ Set TOLerance or SEQuence mode appropriately.
55	REF measurement incomplete	• Illegal operation, attempted to save cable correction data, before performing the REF data measurement.
		→ Perform the REF measurement first.
56	OPEN measurement incomplete	• Illegal operation, attempted to save cable correction data, before performing the OPEN data measurement.
		→ Perform the OPEN measurement first.
57	SHORT measurement incomplete	• Illegal operation, attempted to save cable correction data, before performing the SHORT data measurement.
		→ Perform the SHORT measurement first.
58	LOAD measurement incomplete	• Illegal operation, attempted to save cable correction data, before performing the LOAD data measurement.
		→ Perform the LOAD measurement first.
59	Invalid command at 0m cable	• Illegal operation, attempted to measure cable correction data, when the cable length is set to 0m.
		→ Set the cable length to 1m or 2m before performing CORRection:COLLEct OPEN/SHORT/LOAD or CORRection:COLLEct:SAVE GPIB command.
60	No values in sweep list	• Illegal operation, LIST SWEEP measurement performed when no sweep point settings exist in the LIST SWEEP SETUP.
		→ Set sweep points in the LIST SWEEP SETUP first.
61	Clear the table first	• Illegal operation, the sweep parameter of the LIST SWEEP SETUP is changed when the sweep list for other parameter exists.
		→ Clear the existing list first.
62	Bias off, Turn bias on	• Illegal operation, DC bias sweep was attempted while the DC BIAS is OFF.
		→ Press the DC BIAS to set DC bias to on.

Error No.	Displayed Message	• Description
		→ Solution
70	Handler I/F not installed	• Illegal operation, HANDLER I/F set to ON when Option 201 or 202 was not installed.
		→ Install Option 201 or 202.
		• Illegal operation, HANDLER I/F test was performed when Option 201 or 202 were not installed.
		→ Install Option 201 or 202.
71	Scanner I/F not installed	• Illegal operation, SCANNER I/F set to ON when Option 301 was not installed.
		→ Install Option 301.
		• Illegal operation, Scanner I/F EEPROM R/W test or Scanner I/F I/O test were performed when Option 301 was not installed.
		→ Install Option 301.
72	GPIB I/F not installed	• Illegal operation, GPIB interface used when Option 109 was installed.
		→ Install the GPIB interface.
73	Accessory I/F not installed	• Illegal operation, CONFIG field set to I BIAS or Q ADAPTER when Option 002 is not installed.
		→ Install the ACCESSORY CONTROL interface.
		• Illegal operation, Accessory control I/F test or Q-Adapter buffer test were performed when Option 002 was not installed.
		→ Install the ACCESSORY CONTROL interface.
74	Illegal test setup	• Illegal operation, ACCESSORY CONTROL I/F test performed when the 4285A and the 42841A, the 42851A, or both of them are connected with the accessory control interface cable.
		→ Disconnect the accessory control interface cable from the 42841A and the 42851A.
75	Illegal Accessory config	• Illegal operation, cable correction is attempted, while in the precision Q measurement mode.
		→ Set the CONFIG field to I BIAS (for 1m cable only) or OFF.

Error No.	Displayed Message	• Description
		→ Solution
80	Setup data protected	• Setup data write protected by DIP switch A7SW3. (Refer to Appendix D.)
		→ Set bit 5 of DIP switch A7SW3 to the OFF position.
81	No memory card	• Illegal operation, attempted to store data in record No. 10 to 19 when a memory card was not inserted.
		→ Insert a memory card, or store to record No.0 to 9 (internal memory)
82	Store failed	• Memory card hardware failure (storing function) occurred.
		→ Use another memory card.
		• Internal EEPROM hardware failure (storing function) occurred.
		→ Contact your nearest Agilent Technologies office.
83	No data to load	• Memory card is not inserted.
		→ Insert the memory card completely.
		• No setup data to load in the record number entered.
		→ Confirm the CATALOG, and retry.
84	Load failed	• Memory card hardware failure (loading function) occurred.
		→ Use another memory card.
		• Internal EEPROM hardware failure (loading function) occurred.
		→ Contact your nearest Agilent Technologies office.
85	Different system recorded	• Current configuration mode and recorded configuration mode are different.
		→ Confirm the status of the target record and change the <i>CONFIG</i> field.

Error No.	Displayed Message	• Description
		→ Solution
90	Data buffer overflow	• The amount of data to be stored into the data buffer memory (DBUF) exceeded the defined data buffer size.
		→ Re-define the data buffer memory size, or clear DBUF.
100	Printer down	• Data sent to the output buffer when a printer was not connected to the 4285A with an GPIB cable or the printer was turned OFF.
		→ Connect a printer to the 4285A with an GPIB cable, or turn the printer ON.
		• Printing speed of printer cannot keep up with the 4285A's data output transfer rate.
		→ Set the 4285A's DELAY time appropriately or replace the printer with a higher speed printer that can match the 4285A's data transfer rate.
101	TALK ONLY disabled	• Data sent to the output buffer when the 4285A is addressable.
		→ Set the 4285A to the talk only mode, and set the printer to the listen only mode.
110	Connect Interface Cable	• Illegal operation, set to precision Q measurement mode when the accessory control interface cable is not properly connected.
		→ Connect the 4285A and the 42851A with the accessory control interface cable.

Error No.	Displayed Message	• Description
		→ Solution
111	Q Adapter fan failure	• Cooling fan stopped.
		→ Contact your nearest Agilent Technologies office.
112	Q Adapter powered down	• Illegal operation, set to precision Q measurement mode when an inoperative 42851A is connected to the 4285A.
		→ Check the power cord connection of the 42851A and turn it on.
113	EEPROM Read Status Error	• The 42851A internal EEPROM hardware failure occurred.
		→ Re-store the data to the EEPROM. If this message is still displayed, Contact your nearest Agilent Technologies office.
114	EEPROM Write Status Error	• An 42851A internal EEPROM hardware failure occurred.
		→ Re-store the data to the EEPROM. If this message is still displayed, Contact your nearest Agilent Technologies office.
115	Illegal operation	• Any illegal operation is attempted. (For example, INTERNAL trigger mode while in SERIES or PARALLEL connection modes.)
		→ Perform the correct operation.
116	Q Adapter control failure	• General failure of the 42851A
		→ Turn the 42851A and the 4285A OFF and few seconds later turn ON again. If this message is still displayed, contact your nearest Agilent Technologies office.
-310	System error	• Severe error.
		→ Contact your nearest Agilent Technologies office.
-311	Memory error	• Severe error.
		→ Contact your nearest Agilent Technologies office.

Error No.	Displayed Message	• Description
		→ Solution
Execution Error		
-211	Trigger ignored	• The 4285A Triggered before the previous trigger was executed.
		→ Widen the time interval between triggers.
-222	Data out of range	• Data is out of the setting range.
		→ Enter a value within the available setting range.
-230	Data corrupt or stale	• FETCh? query received after the ABORt or the *RST command was received, or after the power on reset was performed.
		→ Send the FETCh? query during idle state and when the data is valid (after a measurement is performed).
		• FETCh? query received after INITiate command was received, and a trigger was not received.
		→ Send the FETCh? command after the trigger is received.
		• FETCh? query received after the trigger was received in the list sweep mode and the table was not setup.
		→ Setup the list sweep table.
		• Setting value query (for example, VOLTage?, BIAS:CURRent?, LIST:VOLTage?) received when the setting mode is mismatched.
→ Send a setting value query command which matches the current setting mode.		

GPIB Errors

Error No.	Error Message String	• Description
Command Error		
-100	Command error	• Improper command.
-101	Invalid character	• Invalid character was received.
-102	Syntax error	• Unrecognized command or data type was received.
-103	Invalid message unit separator	• The message unit separator (for example, “;”, “,”) is improper.
-104	Data type error	• Improper data type used (for example, string data was expected, but numeric data was received).
-105	GET not allowed	• GET is not allowed inside a program message.
-108	Parameter not allowed	• Too many parameters for the command received.
-109	Missing parameter	• A command with improper number of parameters received.
-112	Program mnemonic too long	• Program mnemonic is too long (maximum length is 12 characters).
-113	Undefined header	• Undefined header or an unrecognized command was received (operation not allowed).
-121	Invalid character in number	• Invalid character in numeric data.
-123	Numeric overflow	• Numeric data value was too large (exponent magnitude >32k).
-124	Too many digits	• Numeric data length was too long (more than 255 digits received).
-128	Numeric data not allowed	• Numeric data not allowed for this operation.
-131	Invalid suffix	• Units are unrecognized, or the units are not appropriate.
-138	Suffix not allowed	• A suffix is not allowed for this operation.
-141	Invalid character data	• Bad character data or unrecognized character data was received.
-144	Character data too long	• Character data is too long (maximum length is 12 characters).
-148	Character data not allowed	• Character data not allowed for this operation.
-150	String data error	• String data is improper.

Error No.	Error Message String	Description
-151	Invalid string data	<ul style="list-style-type: none"> Invalid string data was received (for example, END received before close quote).
-158	String data not allowed	<ul style="list-style-type: none"> String data is not allowed.
-160	Block data error	<ul style="list-style-type: none"> Block data is improper.
-161	Invalid block data	<ul style="list-style-type: none"> Invalid block data was received (for example, END received before length satisfied).
-168	Block data not allowed	<ul style="list-style-type: none"> Block data is not allowed.
-170	Expression error	<ul style="list-style-type: none"> Expression is improper.
-171	Invalid expression	<ul style="list-style-type: none"> Invalid expression was received (for example, illegal character in expression).
-178	Expression data not allowed	<ul style="list-style-type: none"> Expression data is not allowed.
Query Error		
-400	Query error	<ul style="list-style-type: none"> Query is improper.
-410	Query INTERRUPTED	<ul style="list-style-type: none"> Query is followed by DAB or GET before the response was completed.
-420	Query UNTERMINATED	<ul style="list-style-type: none"> Addressed to talk, incomplete program message received.
-430	Query DEADLOCKED	<ul style="list-style-type: none"> Input buffer and output buffer are full; cannot continue.
-440	Query UNTERMINATED error after indefinite response	<ul style="list-style-type: none"> The query which requests arbitrary data response (*IDN? and *OPT? queries) is sent before usual queries in a program message. (for example, FREQ?;*IDN? was expected, but *IDN?;FREQ? is recieved.)

Warning Messages

The 4285A displays warning messages on the System Message Line when an inappropriate operation is attempted, or when the setting is changed automatically due to an inappropriate operation. The warning operation should not set an error bit. The following list describes the 4285A's warning messages.

Warning Message	Description
GPIB error occurred	When the 4285A receives an illegal command via GPIB, this warning message is displayed. To identify the error, use the sample program given in "Sample Program to Detect the Error".
Warning, ALC turned off	When the LEVEL setting is out of the ALC's available range, the ALC function is automatically turned OFF. Set the LEVEL to be within the ALC's available range, and then set ALC to ON.
Warning, ALC unable to regulate	When the LEVEL setting is inappropriate for use with the ALC function, the ALC function will not work, the operation will be the same as if the ALC function is turned OFF. (The data status is set to 4.) Set the LEVEL appropriate for the device.
Warning, Bias changed for fixture	When the SMD Test Fixture is connected to the 42842C and the BIAS setting is out of the available range, the BIAS setting value is reduced to be within the SMD Fixture's available range (2A).
Warning, Correction not effective	When the MULTI correction mode is used and the measurement frequency is not equal to $FREQ1-7$ (correction frequency), correction will not be performed.
Warning, Deviation measurement ON	The deviation measurement is set to ON when the display page is changed to the <i>BIN No. DISPLAY</i> , <i>BIN COUNT DISPLAY</i> , or <i>LIMIT TABLE SETUP</i> page.
Warning, I bias unit disconnected	This message is displayed when the status is changed after the current bias unit is disconnected.
Warning, Improper high/low limits	The high limit value is less than the low limit value of the limit table.
Warning, Level changed for ALC	When the ALC is turned on and the LEVEL setting is out of the ALC's available range, the LEVEL setting is changed to be within the ALC's available range.
Warning, Signal source overload	When the signal source is overloaded, the measurement data is not guaranteed to be valid. (The data status is set to 3.) Reduce the LEVEL.
Warning, Test voltage too high	In the precision Q measurement mode, resonant voltage of the DUT exceeds maximum allowable input voltage of the 4285A. The measurement data is not guaranteed to be valid. Reduce the LEVEL.

Initial Settings and System Memory

Introduction

This appendix lists the 4285A's initial settings and functions whose status is stored in system memory.

There are three ways to initialize the 4285A:

- **POWER ON**
Turn the LINE ON/OFF switch ON.
- ***RST**
Press **SYSTEM RESET** in the *SYS MENU* field of *MEAS SETUP* page, or send the *RST common command via GPIB.
- **DEVICE CLEAR**
Send the device clear bus command (SDC:selected device clear or DCL:clears all devices) via GPIB.

The following list indicates the differences between the three initialization methods on the functions to be initialized. Functions whose status are stored in internal system memory are indicated by "Sys. Memory" on the "POWER ON" column in the following list.

Functions		Initialize Method		
		Power ON	*RST	Device Clear
Settings				
MEAS SETUP	<i>FUNC</i>	Cp-D	Cp-D	Not Affected
	<i>FREQ</i>	1 MHz	1 MHz	Not Affected
	<i>LEVEL</i>	1 V	1 V	Not Affected
	<i>RANGE</i>	AUTO	AUTO	Not Affected
	<i>BIAS</i>	0 V	0 V	Not Affected
	DC BIAS (On/Off)	OFF	OFF	Not Affected
	<i>INTEG</i>	MED	MED	Not Affected
	<i>TRIG</i>	INT	INT	Not Affected
	<i>ALC</i>	OFF	OFF	Not Affected
	<i>MON</i>	V BIAS	V BIAS	Not Affected
	<i>AVG</i>	1	1	Not Affected
	<i>V_m</i>	ON	ON	Not Affected
	<i>I_m</i>	ON	ON	Not Affected
	<i>DELAY</i>	0 s	0 s	Not Affected
	<i>DEV A</i>	OFF	OFF	Not Affected
	<i>REF A</i>	0	0	Not Affected
	<i>DEV B</i>	OFF	OFF	Not Affected
	<i>REF B</i>	0	0	Not Affected

Functions		Initialize Method		
		Power ON	*RST	Device Clear
CORRECTION	<i>OPEN</i>	Sys. Memory	Not Affected	Not Affected
	<i>SHORT</i>	Sys. Memory	Not Affected	Not Affected
	<i>LOAD</i>	Sys. Memory	Not Affected	Not Affected
	<i>CABLE</i>	Sys. Memory	Not Affected	Not Affected
	<i>MODE</i>	Sys. Memory	Not Affected	Not Affected
	<i>CH No.</i>	Sys. Memory	Not Affected	Not Affected
	<i>FUNC</i>	Sys. Memory	Not Affected	Not Affected
	<i>FREQ1 - 7</i>	Sys. Memory	Not Affected	Not Affected
LIMIT TABLE SETUP	<i>REFA</i>	Sys. Memory	Not Affected	Not Affected
	<i>REFB</i>	Sys. Memory	Not Affected	Not Affected
	<i>NOM</i>	0	0	Not Affected
	<i>MODE</i>	% Tolerance	% Tolerance	Not Affected
	<i>AUX</i>	OFF	OFF	Not Affected
	<i>COMP</i>	OFF	OFF	Not Affected
	<i>BIN 1 - 9 LOW</i>	Cleared	Cleared	Not Affected
	<i>BIN 1 - 9 HIGH</i>	Cleared	Cleared	Not Affected
BIN COUNT	<i>2nd LOW</i>	Cleared	Cleared	Not Affected
	<i>2nd HIGH</i>	Cleared	Cleared	Not Affected
LIST SWEEP SETUP	<i>COUNT ON/OFF</i>	OFF	OFF	Not Affected
	<i>MODE</i>	SEQ	SEQ	Not Affected
	<i>sweep parameter</i>	FREQ [Hz]	FREQ [Hz]	Not Affected
SYSTEM CONFIG	<i>sweep points</i>	Cleared	Cleared	Not Affected
	<i>BEEPER</i>	Sys. Memory	Not Affected	Not Affected
	<i>GPIB ADDRESS</i>	Sys. Memory	Not Affected	Not Affected
	<i>TALK ONLY</i>	Sys. Memory	Not Affected	Not Affected
	<i>CONFIG</i>	Sys. Memory	Not Affected	Not Affected
	<i>HANDLER I/F</i>	Sys. Memory	Not Affected	Not Affected
Display Control	<i>SCANNER I/F</i>	Sys. Memory	Not Affected	Not Affected
	<i><display page></i>	<i>MEAS DISPLAY</i>	<i>MEAS DISPLAY</i>	Not Affected
	<i>D.P. FIX A</i>	OFF	OFF	Not Affected
	<i>D.P. FIX B</i>	OFF	OFF	Not Affected
Measurement Data				
	Measurement Data	Cleared	Cleared	Not Affected
	List Sweep Data	Cleared	Cleared	Not Affected
	V / I Monitor Data	Cleared	Cleared	Not Affected
	BIN Count Data	Cleared	Cleared	Not Affected

Functions		Initialize Method		
		Power ON	*RST	Device Clear
GPIB				
	Data Buffer Memory	Cleared	Cleared	Not Affected
	Data Format	ASCII	ASCII	Not Affected
	Input Buffer	Cleared	Not Affected	Cleared
	Output Buffer	Cleared	Not Affected	Cleared
	Error Queue	Cleared	Not Affected	Not Affected
Status Byte ¹	Bit 7	0	Not Affected	Not Affected
	Bit 6	0	Not Affected	Not Affected
	Bit 5	0	Not Affected	Not Affected
	Bit 4	0	Not Affected	0
	Enable Resister	0	Not Affected	Not Affected
Operation Status Register ¹	Bit 4	0	0	Not Affected
	Bit 3	0	0	Not Affected
	Bit 0	0	0	Not Affected
	Enable Resister	0	Not Affected	Not Affected
Standard Event Status Register ¹	Bit 7	1	Not Affected	Not Affected
	Bit 6	0	Not Affected	Not Affected
	Bit 5	0	Not Affected	Not Affected
	Bit 4	0	Not Affected	Not Affected
	Bit 3	0	Not Affected	Not Affected
	Bit 2	0	Not Affected	Not Affected
	Bit 0	0	Not Affected	Not Affected
	Enable Resister	0	Not Affected	Not Affected
Others				
	<i>comment</i>	Cleared	Cleared	Not Affected
	<i>KEY LOCK</i>	OFF	OFF	Not Affected

¹ Any other bits described in this table are not used. (always 0)

Write Protection

Introduction

The 4285A is equipped with an internally mounted write-protect switch. This switch has two write protection features. One feature disables the STORE function for write protecting all of the stored data in the memory card and EEPROM internal memory, and the other feature prevents changing any of the previous correction settings on the *CORRECTION* page. This feature is useful when you want to retain specific 4285A control settings for everyday use, for example, on a production line where it is not necessary to store any information on a memory card, thereby making it impossible to accidentally erase or overwrite the stored data in the memory card or the EEPROM internal memory, and also making it impossible to accidentally erase or overwrite the correction settings.

Write Protection Procedure

The procedure for setting the write protection switch to ON is as follows.

1. Turn the 4285A off and remove the power cord. Allow 1 minutes for the internal capacitors to discharge.

Warning



Dangerous voltage may be present in the 4285A even through the power switch is off. Be sure to wait 1 minutes for the internal capacitors to discharge.

2. Remove the two feet at the back of the top cover.
3. Fully loosen the screw that secures the top cover.
4. Pull the top cover towards the rear of the 4285A and lift up to remove.
5. Loosen the five screws that secure the top shield plate (Larger one).
6. Slide the top shield forward then lift it off.
7. Remove the A7 board. Figure D-1 shows the A7 board's location.

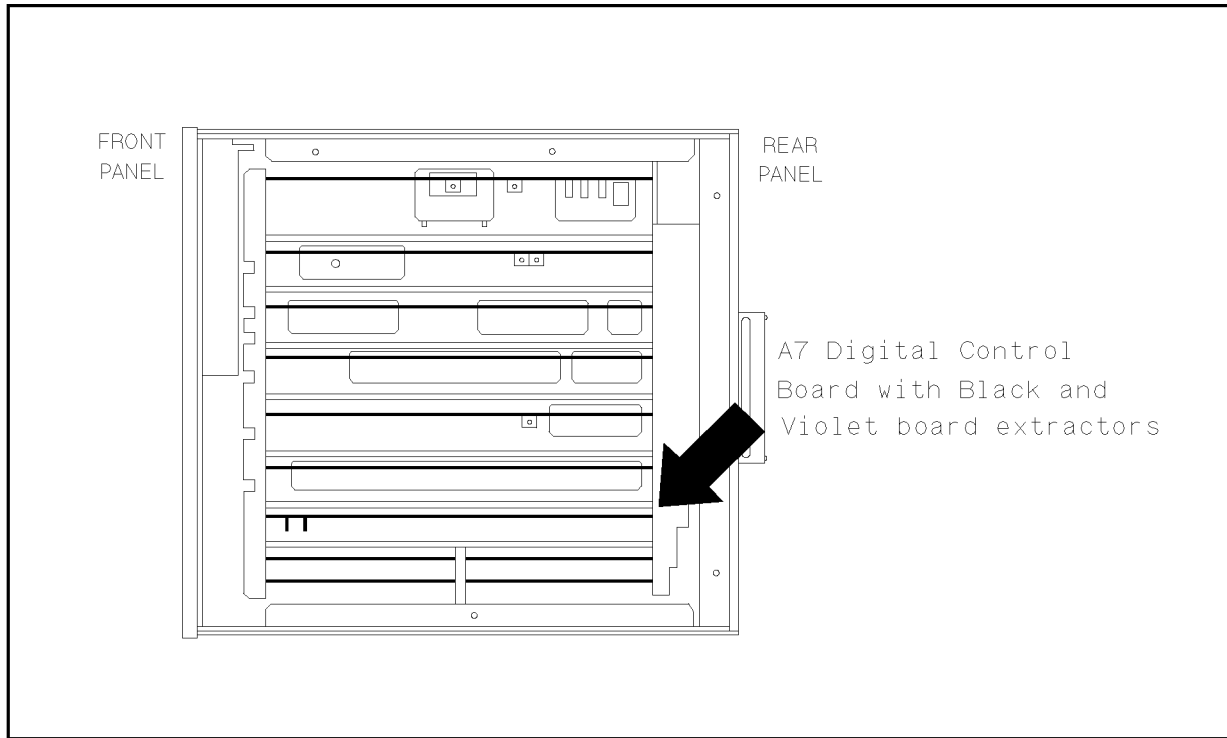

Figure D-1. A7 Digital Board Location

Caution



Semiconductor components are installed on the A7 board. When handling the A7 board, be aware that electrostatic discharge can damage these components.

8. Set A7S3-6 to the right-most position (ON) to disable 4285A's STORE function. Set A7S3-6 to the left-most position (OFF) to enable storing. Refer to Figure D-2.
9. Set A7S3-7 to the right-most position (ON) to disable to change all of the correction settings on the *CORRECTION* page. Set A7S3-7 to the left-most position (OFF) to enable to change all of the correction settings on the *CORRECTION* page. Refer to Figure D-2.

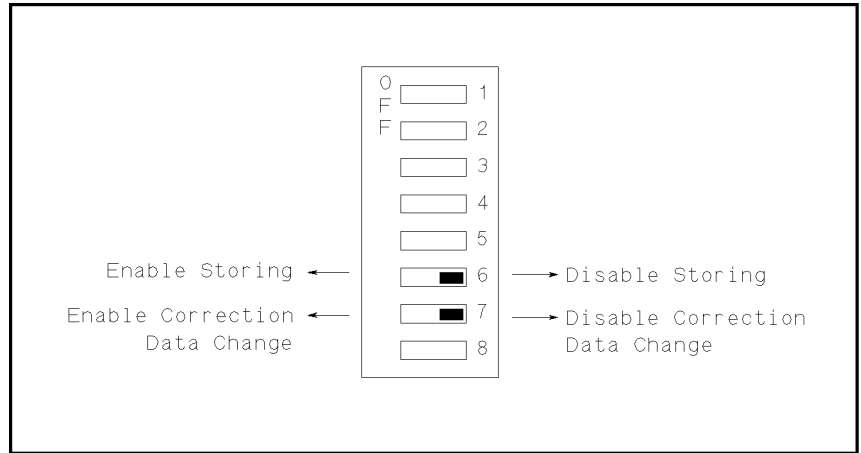

Figure D-2. Write Protection Switch

Note



Do not change any of the other switch settings on the A7 board.

10. Install the configured A7 board into the 4285A.
11. Replace the top shield plate, top cover, and rear feet.

NOTE

The Operation Note for Option 201 Handler Interface, starting from the next page, was written for use with the 4284A. This Operation Note is also applicable to the 4285A without any changes in description.

4284A PRECISION LCR METER
OPERATION NOTE

Option 201 Handler Interface



Agilent Technologies

Printed in JAPAN

TABLE OF CONTENTS

SECTION 1:

GENERAL INFORMATION

INTRODUCTION	1-1
DESCRIPTION	1-1
SPECIFICATIONS	1-1

SECTION 2:

OPERATION

INTRODUCTION	2-1
SIGNAL LINE DEFINITION	2-1
Signal Line Used for Comparator Function	2-1
Signal Line Used for List Sweep	
Comparator Function	2-6
ELECTRICAL CHARACTERISTICS	2-10
DC Isolated Outputs (Opto-coupled)	2-10
DC Isolated Inputs (Opto-coupled)	2-12
SETTING UP THE HANDLER INTERFACE BOARD	2-14
Procedure	2-16
OPERATION	2-23
Setting Procedure For Comparator	
Function	2-23
Setting Procedure For List Sweep	
Comparator Function	2-24

SECTION 1**GENERAL INFORMATION**

INTRODUCTION

This operation note provides the information necessary to use the HP 4284A Precision LCR Meter Option 201 Handler Interface. Refer to the HP 4284A Operation Manual for specific HP 4284A operating procedures.

DESCRIPTION

The HP 4284A Option 201 is a Handler Interface which outputs signals to indicate measurement completed, bin sorting judgments of the comparator function, and Go/No-Go judgments of the list sweep comparator function. The Option 201 Handler Interface also has an input for an external trigger signal and a keylock signal. Using these signals, the HP 4284A can easily be combined with a component handler and a system controller to fully automate component testing, sorting, and quality control data processing to increase production efficiency.

SPECIFICATIONS

Table 1-1 lists the HP 4284A Option 201 Handler Interface specifications only. All other specifications are the same as those for a standard HP 4284A.

Table 1-1. Specifications

Output signal: Negative true, open collector, opto-isolated.

Decision Output:

Comparator Function: Bin number, out of bins, and rejection status.

List Sweep Comparator Function:

IN/OUT at each sweep point and pass/fail for the result of sequential comparisons.

Index: Analog measurement complete.

Measurement Complete: Full measurement complete.

Alarm: Notification that a momentary power failure was detected.

Input Signal: Opto-isolated.

Keylock: Front panel keyboard lockout

External Trigger: Pulse width $\geq 1 \mu\text{s}$

SECTION 2**OPERATION****INTRODUCTION**

This section provides information, including a description of the interface signal lines and their electrical characteristics, necessary to use the Option 201 Handler Interface.

SIGNAL LINE DEFINITION

The handler Interface uses three types of signals: comparison output, control input, and control output. The signal lines for the Comparator Function and the List Sweep Comparator Function are defined differently for comparison output signals and control input signals. The following are signal definitions of the handler interface when used with the Comparator Function and the List Sweep Comparator Function.

Signal Line Used for Comparator Function

The signal definitions for the Comparator Function are as follows.

- Comparison Output Signals:

/BIN1 - /BIN9, /AUX_BIN, /OUT_OF_BINS, /PHI (primary parameter high reject signal), /PLO (primary parameter low reject signal), /SREJ (secondary parameter reject signal), /UNBAL (bridge unbalanced signal). See Figure 2-1.

- Control Output Signals:

/INDEX (analog measurement completed signal), /EOM (End Of Measure and comparison data valid signal) and /ALARM (instrument failure signal).

- Control Input Signal:

/EXT_TRIG (External trigger signal) and /KEY_LOCK (key entry disable signal)

The contact assignments and a brief description of each are given in Table 2-1 and Figure 2-2. The timing diagram is shown in Figure 2-3.

NOTE

The / (back slash) in the signal name means that the signal is asserted when LOW.

Table 2-1. Contact Assignments for Comparator Function (sheet 1 of 2)

Pin No.	Signal Name	Description
1 2 3 4 5 6 7 8 9 10 11	/BIN1 /BIN2 /BIN3 /BIN4 /BIN5 /BIN6 /BIN7 /BIN8 /BIN9 /OUT_OF_BINS /AUX_BIN	Sorting judgments. All /BIN_ signal outputs are open collector.
12 13	/EXT_TRIG /EXT_TRIG	External Trigger: HP 4284A is triggered on the rising edge of a pulse applied to this pin when the trigger mode is set to EXT_TRIG.
14 15	EXT.DCV2 EXT.DCV2	External DC voltage 2: DC voltage supply pins for DC Isolated inputs (/EXT_TRIG, /KEY_LOCK) and DC Isolated outputs (/ALARM, /INDEX, /EOM). Setting of internal jumpers must be changed when using an internal voltage supply.
16 17 18	+5V +5V +5V	Internal voltage supply (max. 0.5A). Exceeding 0.5A will cause the fuse to blow on the handler interface board, and the internal voltage will no longer be output (refer to the pink page at the front of this manual).
19	/PHI	Primary Parameter High Reject: The measurement value is greater than the high limit value of BIN1 - BIN9. (See Figure 2-1)
20	/PLO	Primary Parameter Low Reject: The measurement value is less than the low limit value of BIN1 - BIN9. (See Figure 2-1)
21	/SREJ	Secondary Parameter Reject: The measurement value is not within the range of the secondary parameter limit. (See Figure 2-1)
22 23	NC NC	No Connection No Connection

Table 2-1. Contact Assignments for Comparator Function (sheet 2 of 2)

Pin No.	Signal Name	Description
24	/UNBAL	Unbalance: The bridge is unbalanced.
25	/KEYLOCK	When this line is asserted, all of the HP 4284A's front panel key functions are disabled.
26	NC	No Connection
27 28	EXT.DCV1 EXT.DCV1	External DC Voltage 1: DC voltage supply pins for DC isolated open collector outputs, /BIN1 - /BIN9, /AUX_BIN, /OUT_OF_BINS, /PHI, /PLO, /SREJ, /UNBAL. The setting of internal jumpers must be changed when using the internal voltage supply.
29	/ALARM	/ALARM is asserted when a POWER FAILURE occurs.
30	/INDEX	/INDEX signal is asserted when an analog measurement is complete and the HP 4284A is ready for the next DUT to be connected to the UNKNOWN terminals. The measurement data, however, is not valid until /EOM is asserted. (See Figure 2-3).
31	/EOM	End Of Measurement: This signal is asserted when the measurement data and comparison results are valid. (See Figure 2-3)
32 33	COM2 COM2	Common for EXT.DCV2
34 35 36	COM1 COM1 COM1	Common for EXT.DCV1

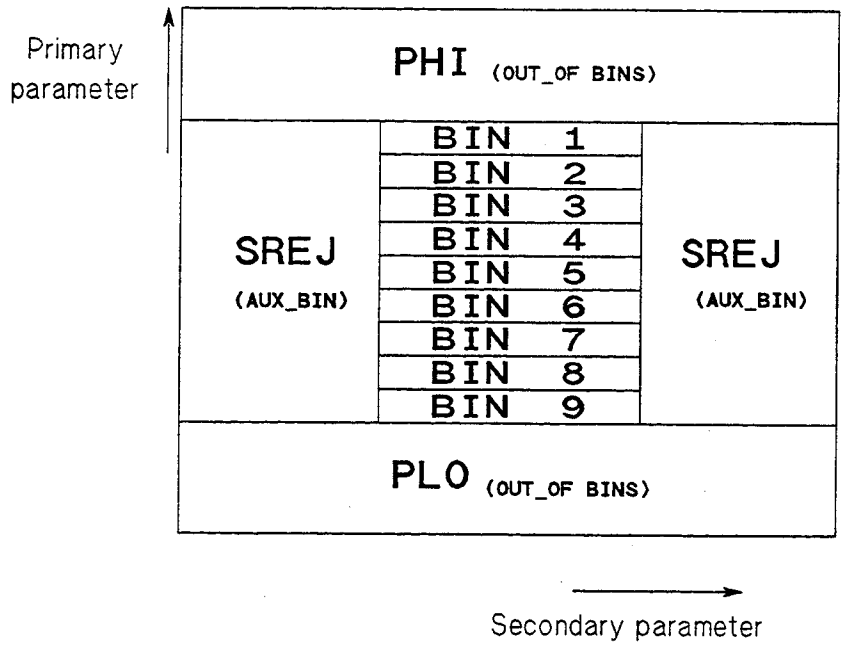

Figure 2-1. /PHI, /PLO, /SREJ Signal's Area Example
(For The Comparator Function)

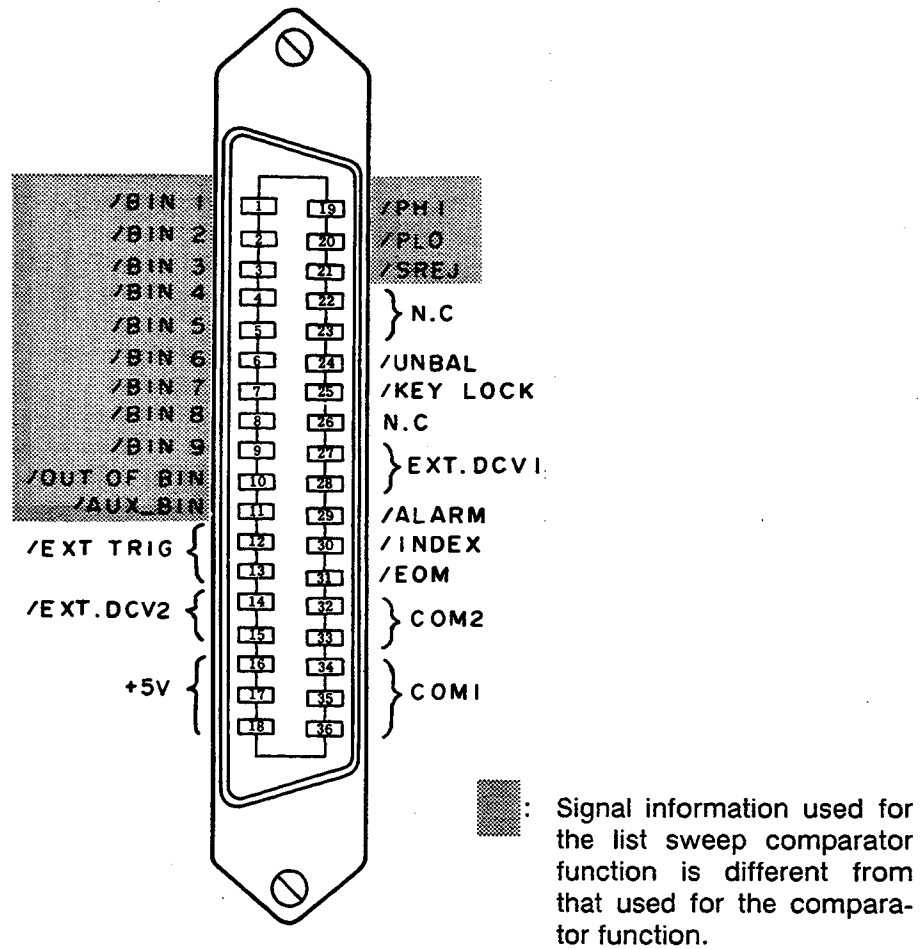
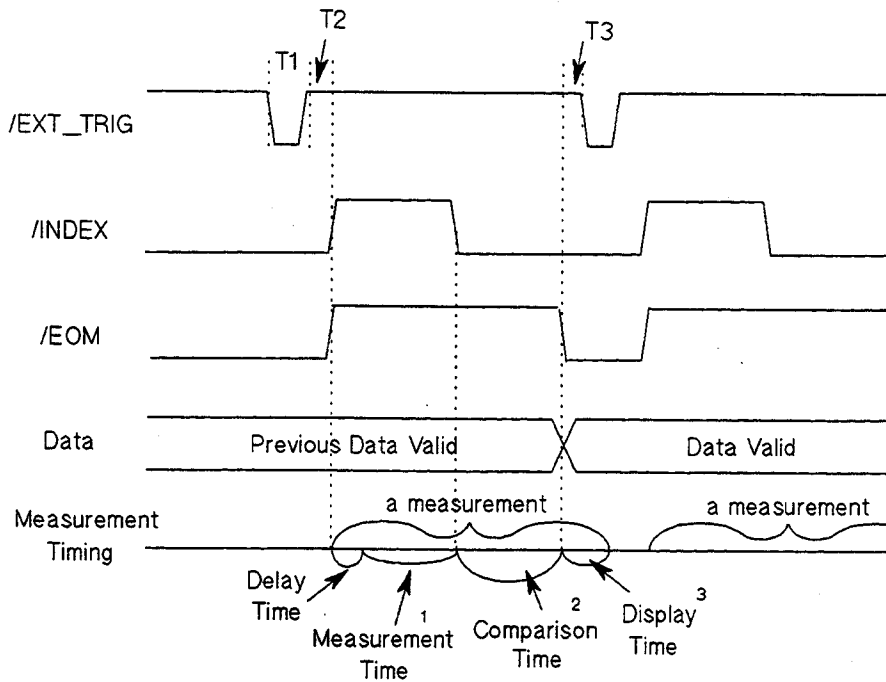

Figure 2-2. Pin Assignment For Handler Interface Connector



Time	Minimum Value	Maximum Value
T1 Trigger Pulse Width	1 μ s	---
T2 Measurement Start Delay Time	200 μ s	Display Time ³ + 200 μ s
T3 Trigger Wait Time After /EOM Output	0 μ s	---

¹ Refer to the HP 4284A Operation Manual.

² Typical comparison time is approximately 1 ms.

³ Typical display time for each display format is as follows.

MEAS DISPLAY page	approx. 8 ms
BIN No.DISPLAY page	approx. 5 ms
BIN COUNT DISPLAY page	approx. 0.5 ms

Figure 2-3. Timing Diagram

**Signal Line
Used for List Sweep
Comparator
Function**

Signal definition used for the list sweep comparator function is different from that used for the comparator function. Signal definition used for the list sweep comparator function is as follows.

- **Comparison Output Signals:**

/BIN1 - /BIN9 and /OUT_OF BINS indicate IN/OUT judgments for each sweep point (refer to Figure 2-4). /AUX_BIN indicates pass/fail judgment (one or more failed judgments of Steps 1 to 10 occurred during a single sweep).

These signals are output when the sweep measurement is completed.

- **Control Output Signals:**

/INDEX (analog measurement completed signal) and /EOM (end of measurement signal). The timing when /INDEX and /EOM are asserted is as follows: (different from that used for the comparator function).

- **In the SEQ sweep mode:**

/INDEX is asserted when the last step of an analog measurement of a sweep measurement is completed. /EOM is asserted when all of the comparison results are valid after a sweep measurement.

- **In the STEP sweep mode:**

/INDEX is asserted after each step of analog measurement in a sweep measurement is completed. /EOM is asserted after each step measurement, including comparison time, is completed.

The contact assignments and a brief description of signals used for the list sweep function are given in Table 2-2 and Figure 2-2 (pin assignments for the list sweep comparator function are the same as for the comparator function). The timing diagram is shown in Figure 2-5.

NOTE

The / (back slash) in the signal name means that the signal is asserted when LOW.

Table 2-2. Contact Assignments for List Sweep Comparator Function

Pin No.	Signal Name	Description
1	/BIN1	Failed (out of limit) at sweep Point 1
2	/BIN2	Failed (out of limit) at sweep Point 2
3	/BIN3	Failed (out of limit) at sweep Point 3
4	/BIN4	Failed (out of limit) at sweep Point 4
5	/BIN5	Failed (out of limit) at sweep Point 5
6	/BIN6	Failed (out of limit) at sweep Point 6
7	/BIN7	Failed (out of limit) at sweep Point 7
8	/BIN8	Failed (out of limit) at sweep Point 8
9	/BIN9	Failed (out of limit) at sweep Point 9
10	/OUT_OF_BINS	Failed (out of limit) at sweep Point 10
11	/AUX_BIN	/AUX_BIN is asserted when one or more fail judgments of Steps 1 to 10 occur in a single sweep.
19 - 21	N.U.	Not Used (Off state, HIGH level)
30	/INDEX	<p>In the SEQ sweep mode: /INDEX is asserted when an analog measurement of the last sweep step is completed, and the HP 4284A is ready for the next DUT to be connected to the UNKNOWN terminals. The measurement data, however, is not valid until /EOM is asserted. (See Figure 2-5.)</p> <p>In the STEP sweep mode: /INDEX is asserted when each analog measurement is complete and the HP 4284A is ready for the next sweep step. The measurement data, however, is not valid until /EOM is asserted. (See Figure 2-5.)</p>
31	/EOM	<p>End Of Measurement:</p> <p>In the SEQ sweep mode: /EOM is asserted when the measurement data and comparison results are valid after the last step measurement is completed. (See Figure 2-5.)</p> <p>In the STEP sweep mode: /EOM is asserted when each step measurement, including the comparison times, is completed and the measurement data is valid. The comparison results are valid after the /EOM signal of the last sweep point is asserted. (See Figure 2-5.)</p>
12 - 18, 22 - 29, 32 - 36		Same as the assignments for the comparator function (Refer to Table 2-1).

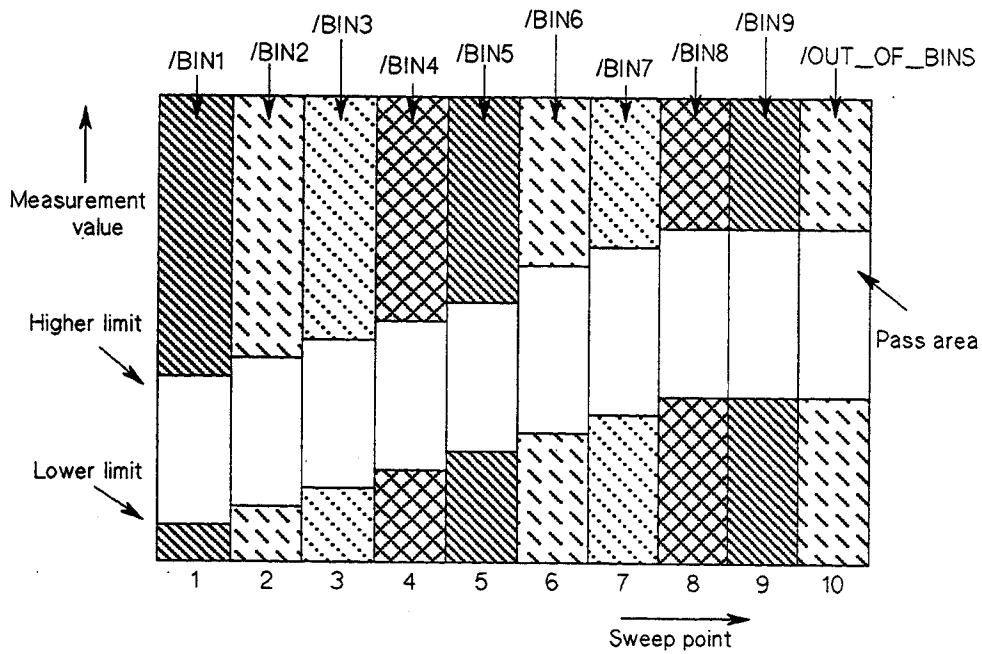
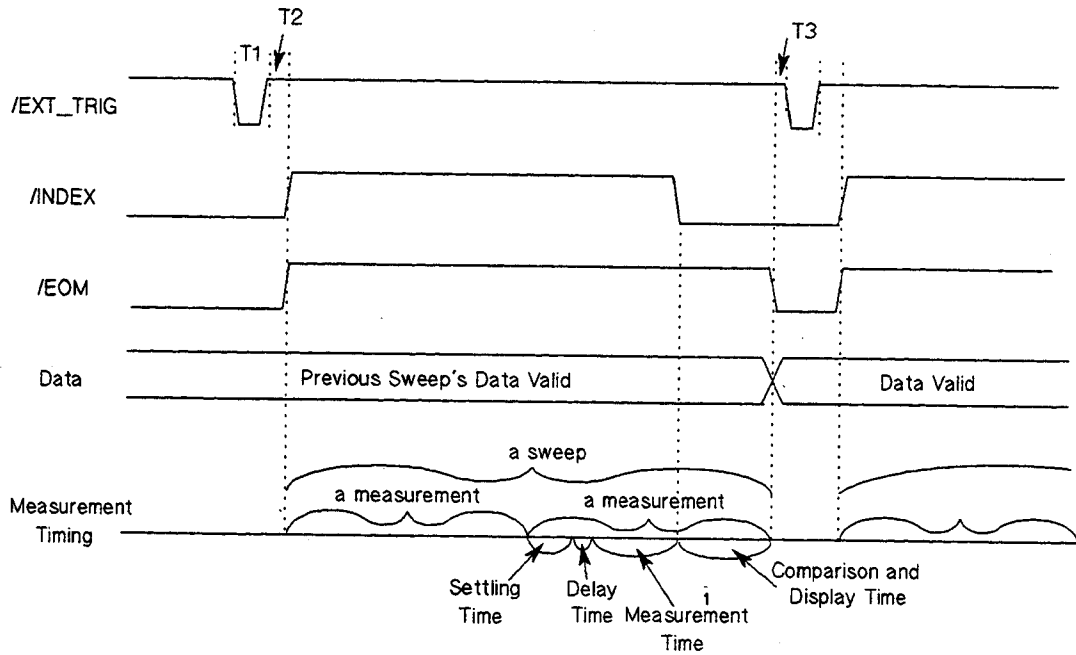
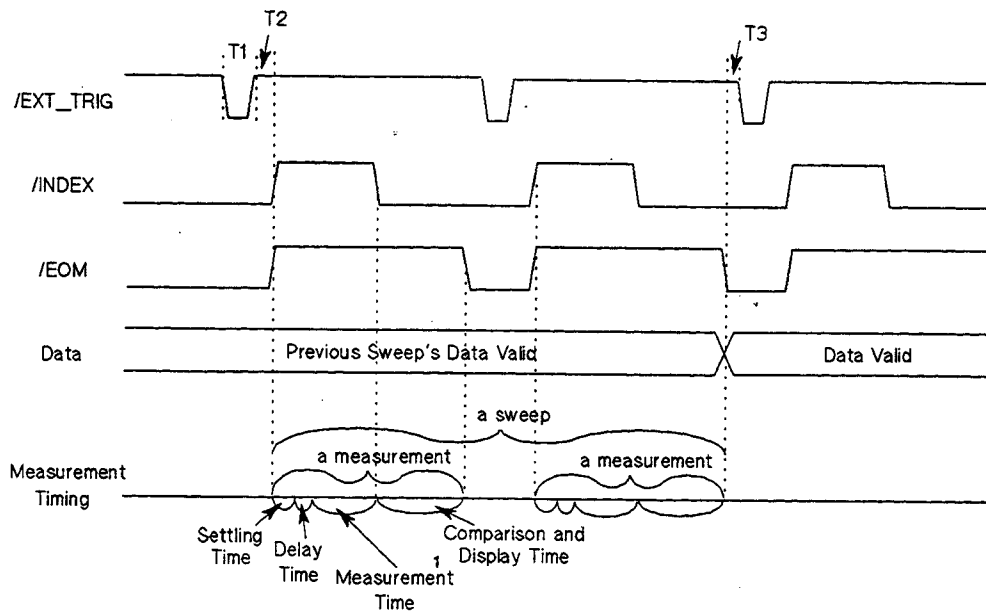

Figure 2-4. Signal Area Example
 (For The List Sweep Comparator Function)

SEQ Sweep Mode:



STEP Sweep Mode:



NOTE

Setting Time includes Correction Data Switching Time. Comparison and Display Time is approx. 4.5 ms. Refer to Figure 2-3 for information of T1, T2, T3.

Figure 2-5. Timing Diagram

ELECTRICAL CHARACTERISTICS

As mentioned in the previous paragraph, the meaning of some of the signals is different for the the comparator function and the list sweep comparator function. However, the electrical characteristics of these signals are identical for the two operations. The following descriptions apply to both the comparator function and the list sweep comparator function.

DC Isolated Outputs (Opto-coupled)

Each DC output (pins 1 through 11, pins 19 through 24, pins 29 through 31) is isolated using an open collector output optocoupler. The output voltage of each line is set by a pull-up resistor on the handler interface board. The pull-up resistors can be connected to the internally supplied voltages (+5 V and +12 V), or to an externally applied voltage (EXT.DCV.1: +5 V to +24 V, EXT.DCV.2: +5 V to +15 V) by setting jumpers (refer to page 2-15, **SETTING UP THE HANDLER INTERFACE BOARD**).

The electrical characteristics of the DC isolated outputs are divided into two types, (See Table 2-3).

Since the power source for the Comparison Output and Control Output signals are different, two circuit commons (COM1, COM2) are made available.

Table 2-3. DC Isolated Output Electrical Characteristics

Output Signals	Voltage Output Rating		Maximum Current	Circuit Common
	Low	High		
Comparison Signals /BIN1 - /BIN9 /AUX_BIN /OUT_OF_BINS /PHI /PLO /UNBAL	≤0.5 V	+5 V - +24 V	6 mA	Internal pull-up voltage: HP 4284A circuit common External voltage (EXT.DCV.1): COM1
Control Signals /INDEX /EOM /ALARM	≤0.5 V	+5 V - +15 V	5 mA	Internal pull-up voltage: HP 4284A circuit common External voltage (EXT.DCV.2): COM2

A simplified diagram of the output signals is shown in Figure 2-6 (Comparison Signals) and Figure 2-7 (Control Signals).

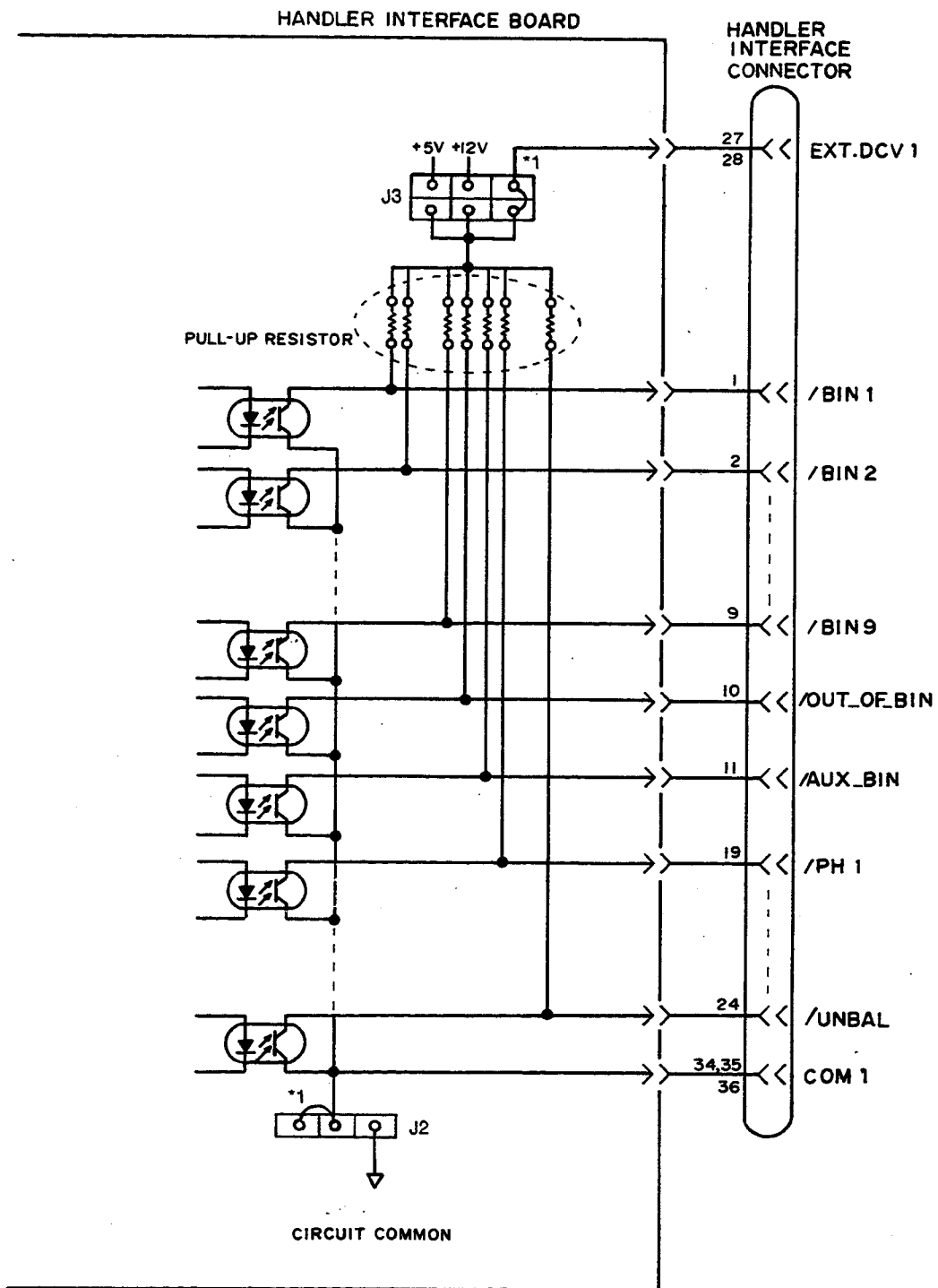

¹ Factory shipped jumper setting

Figure 2-6. Simplified Diagram of The Comparison Output Signals

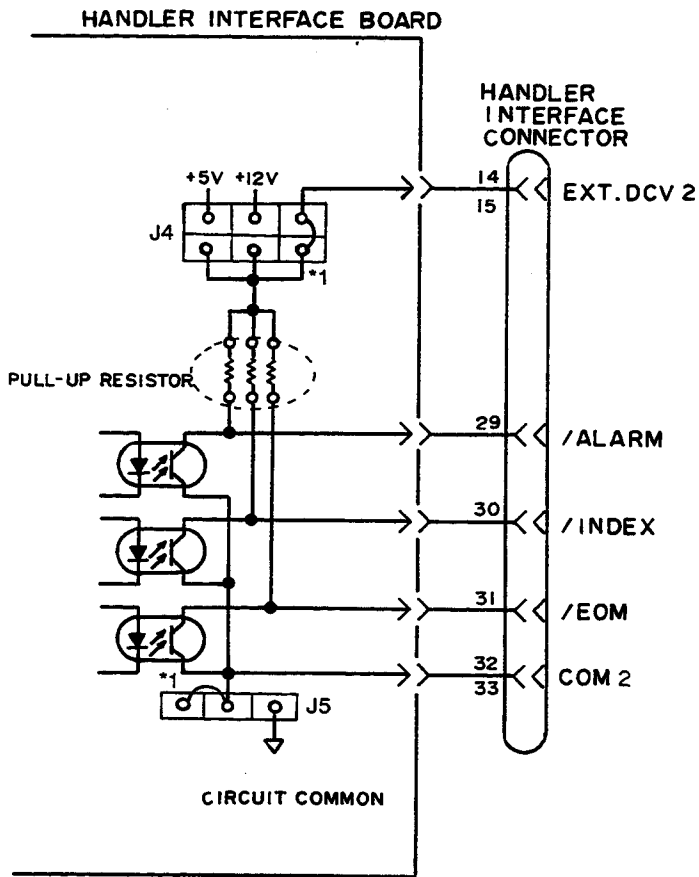

¹ Factory shipped jumper setting

Figure 2-7. Simplified Diagram of The Control Output Signals

DC Isolated Input (Optocoupled)

The electrical characteristics of the DC isolated input are divided into two types.

1. /EXT_TRIG

The /EXT_TRIG signal (pins 12 and 13) is connected to the cathode of the LED in an optocoupler. The HP 4284A is triggered on the rising edge of the /EXT_TRIG pulse. The anode of the LED can be powered from the internal 5 V and 12 V supplies, or by an external voltage source (EXT.DCV2).

NOTE

To limit the trigger current, jumper J6 must be selected considering the optocoupler anode voltage being used. See page 2-15, **SETTING UP THE HANDLER INTERFACE BOARD.**

2. /KEY_LOCK

The /KEY_LOCK signal (pin 25) is connected to the cathode of the LED in an optocoupler. All of the HP 4284A's front panel keys are disabled when the /KEY_LOCK signal is asserted. The LED's anode can be connected to the internal 5V or 12V supplies, or can be connected to an external voltage source (EXT.DCV2), which is connected to pin 15 or 16 on the handler interface connector.

The OFF state voltage (high level) of the /KEY_LOCK (pin 25) and /EXT_TRIG (pins 12, 13) signals depends on the pull-up voltage selected using jumper J4.

A diagram for the input signals is shown in Figure 2-8.

The electrical characteristics of the signals are listed in Table 2-4.

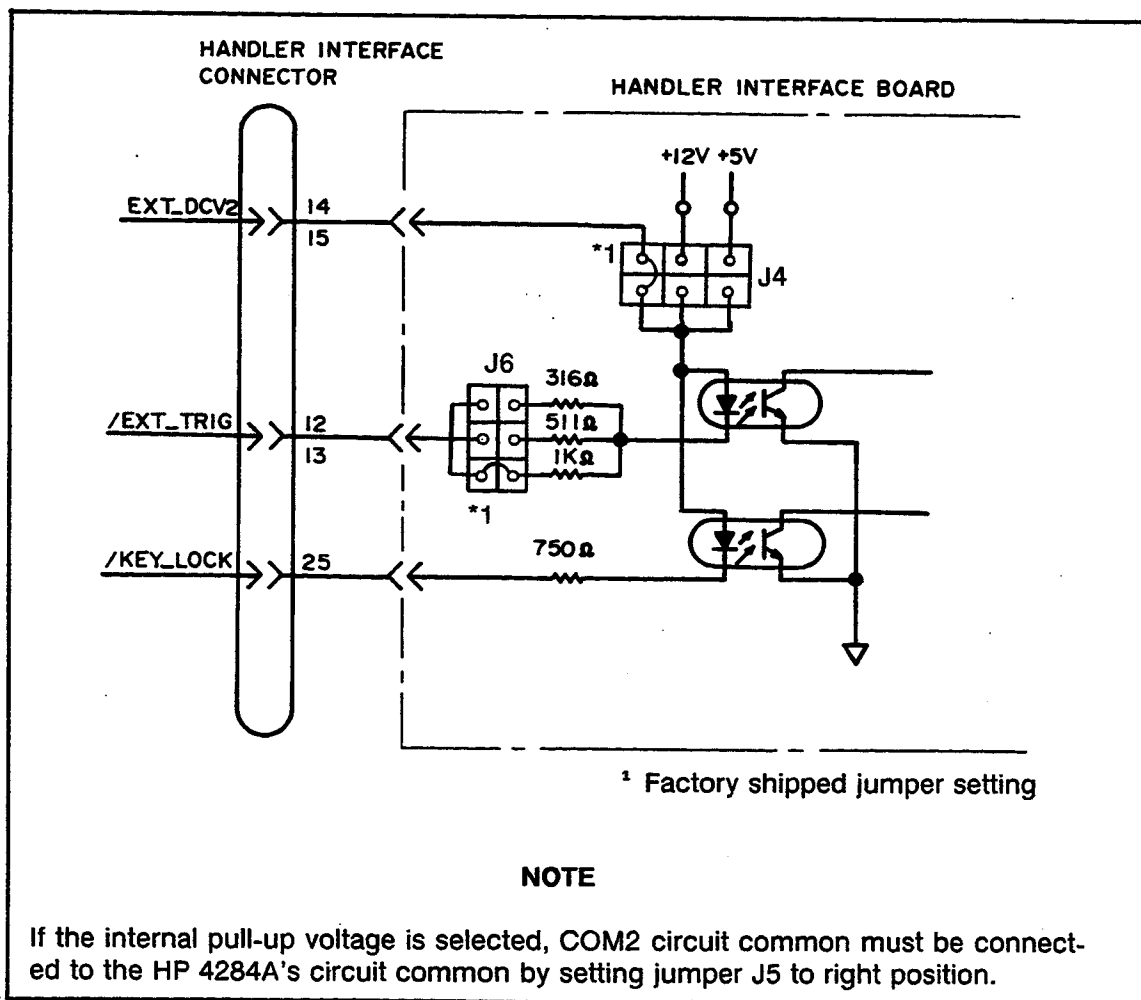

Figure 2-8. Handler Interface Input Signal Diagram

Table 2-4. Typical Electrical Characteristics

Signal	Input Voltage		Input Current (Low) Pull-up Voltage			Circuit Common
	LOW	HIGH	+5V	+12V	+15V	
/EXT_TRIG	≤1V	5V~15V	11.1mA	10.5mA	13.5mA	Internal Pull-up Voltage: HP 4284A circuit common External Pull-up Voltage: COM2
/KEY_LOCK	≤1V	5V~15V	5.2mA	14.5mA	18.5mA	Internal Pull-up Voltage: HP 4284A circuit common External Pull-up Voltage: COM2

**SETTING UP
THE HANDLER
INTERFACE
BOARD**

Jumpers on the Handler Interface board must be set to select the signal outputs (Open collector, Internal voltage outputs, or External voltage outputs). A description of each of the five jumpers (J2 - J6), is given in Table 2-5, and their locations are shown in Figure 2-9.

Table 2-5. Internal Jumper Settings

Jumper		Description	Signals
No.	Position		
J2	Upper(N)	DC Isolated outputs are isolated.	/BIN1 - /BIN9 /AUX_BIN /OUT_OF_BINS /PHI - /UNBAL
	Lower	DC Isolated outputs are not isolated. COM1 is connected to the 4284A circuit common.	
J3	Right(N)	The open collector outputs are pulled up to the /EXT.DCV1(5V~24V).	
	Center	The open collector outputs are pulled up to the internal 12V.	
	Left	The open collector outputs are pulled up to the internal 5V.	
J4	Right(N)	The open collector outputs are pulled up to the EXT.DCV2(5V~15V).	
	Center	The open collector outputs are pulled up to the internal +12V.	
	Left	The open collector outputs are pulled up to the internal +5V.	
J5	Upper(N)	DC Isolated outputs are isolated.	
	Lower	DC Isolated outputs are not isolated. COM2 is connected to 4284A circuit common.	
J6	Right(N)	Trigger current limiting resistor is 1k Ω . This position should be set when EXT.DCV2 is between 9V to 15V or J4 is set to the center position.	/EXT_TRIG
	Center	Trigger current limiting resistor is 511 Ω . This position should be set when EXT.DCV2 is between 6V to 9V.	
	Left	Trigger current limiting resistor is 316 Ω . This position should be set when EXT.DCV2 is between 5V to 6V or J4 is set to left position.	

* When shipped from the factory, each jumper is set to the (N) position (marked "N" on the handler interface board).

NOTE

When the internal 5V (pin 16-18) of the handler interface connector is used by the handler, either jumper J2 or J5 must be set to lower position, and either COM1 or COM2 must be used as the +5 V common.

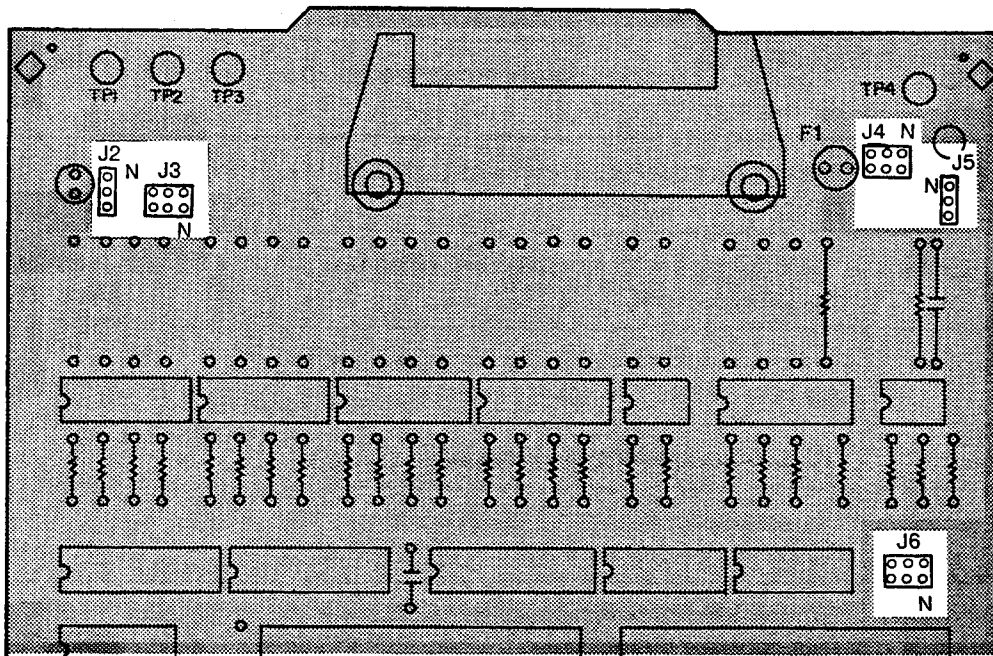

Figure 2-9. Jumper Locations

Procedure

To set up the jumpers and pull-up resistors, perform the following steps.

1. Disconnect the power cable from the HP 4284A and allow enough time (a few minutes), for the internal capacitors to discharge.

WARNING

DANGEROUS ENERGY/VOLTAGE EXISTS WHEN THE HP 4284A IS IN OPERATION AND JUST AFTER IT IS POWERED DOWN. ALLOW A FEW MINUTES FOR THE INTERNAL CAPACITORS TO DISCHARGE.

2. Disconnect the two rear feet which lock the top cover and rear panel together.
3. Fully loosen the top cover retaining screws located on the rear of the top cover.
4. Slide the top cover towards the rear and lift it off. The top shield plate will be visible.
5. Remove the top shield plate to expose the PC boards.
6. Disconnect the flat cable connected to the handler interface board.

NOTE

The handler interface board has the red and orange extractors. See Figure 2-10.

7. Reinstall the handler interface board.

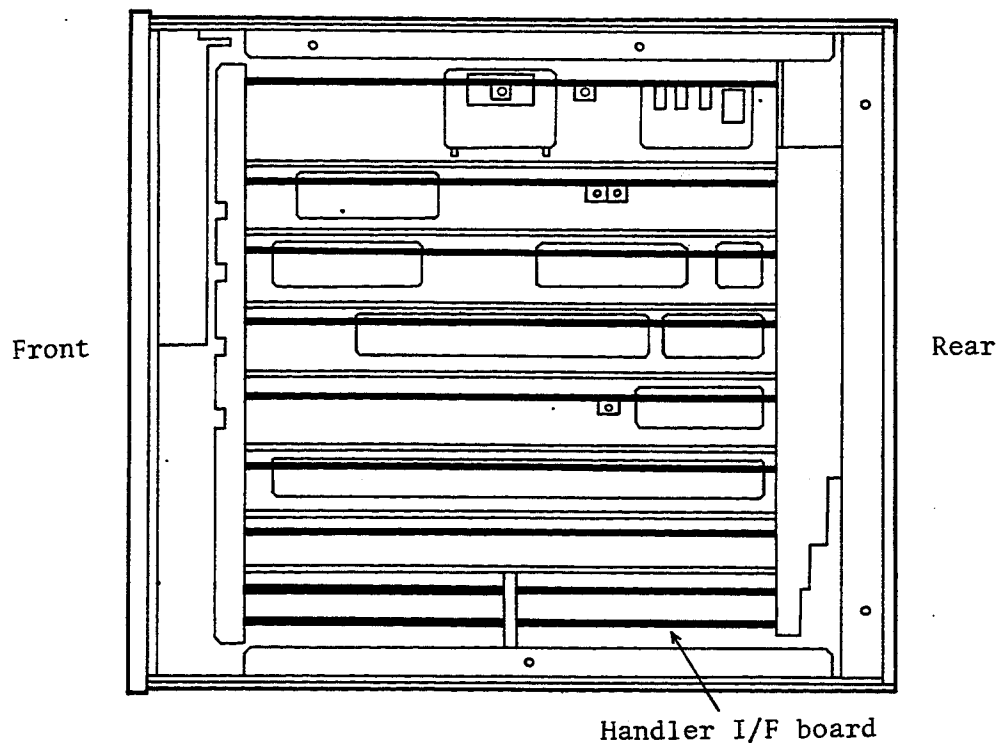
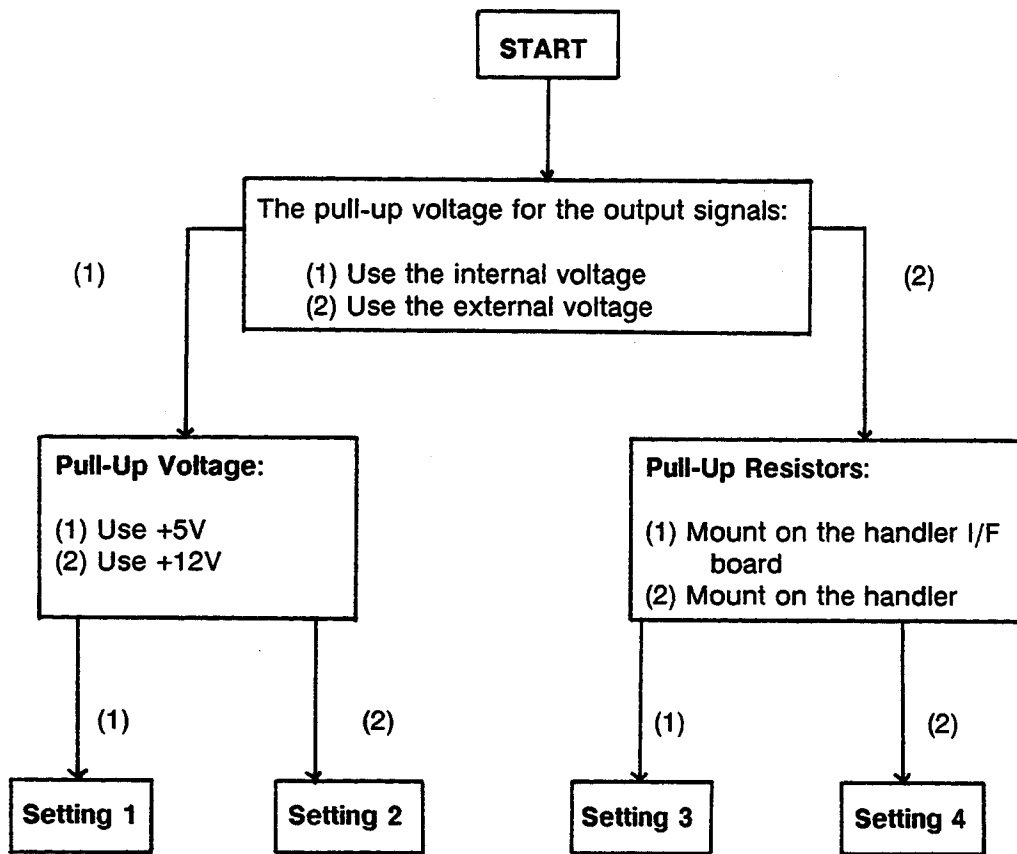

Figure 2-10. Handler Interface Board Locations

8. Use the following flow chart to set the jumpers for the comparison output signals.



9. Install jumpers according to Table 2-6, (See Figure 2-11).

10. Mount the pull-up resistors for the comparison output signals when pull-up resistors are called for in Table 2-6.

Table 2-6. Jumper Setting (1)

Setting Number	Jumper Setting		Circuit Common	Pull-up resistor	Pull-up voltage
	J2	J3			
1	Lower	Left	4284A's COM	Required	Internal+5V
2	Lower	Center	4284A's COM	Required	Internal+12V
3	Upper(N)	Right(N)	COM1	Required	EXT.DCV.1 (5V~24V)
4	Upper(N)	-	COM1	Not required	-

NOTE

Use the following equation to determine the value of the pull-up resistors.

$$R[k\Omega] \approx \frac{V_p[V]}{3}$$

Where,

V_p: Pull-up voltage

R: Pull-up resistor

The typical pull-up resistor values are:

Pull-Up Voltage	Pull-Up Resistor	HP Part Number
5 V	1.78kΩ	PN 0757-0278
12 V	3.16kΩ	PN 0698-3154
24 V	8.25kΩ	PN 0757-0441

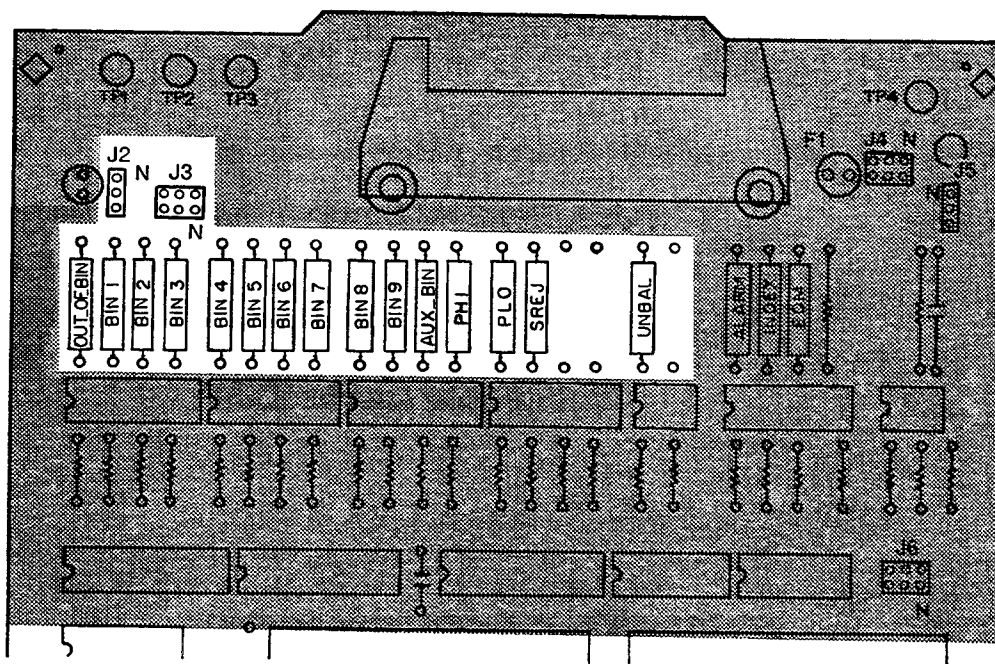

Figure 2-11. How to Set Up the Handler Interface Board (1)

11. Follow the flow chart in step 8 to set up the jumpers for the control output signals.

12. Set the jumpers in accordance to Table 2-7, (See Figure 2-12).

Table 2-7. Jumper Settings (2)

Setting Number	Jumper Setting		Circuit Common	Pull-up resistor	Pull-up voltage
	J4	J5			
1	Left	Lower	4284A's COM	Required	Internal+5V
2	Center	Lower	4284A's COM	Required	Internal+12V
3	Right(N)	Upper(N)	COM2	Required	EXT.DCV.2 (5V~15V)
4	- ¹	Upper(N)	COM2	Not required	-

- ¹ When input signals are used, J4 is set to the Right(N) position, (a pull-up resistor is not required).

13. Mount the pull-up resistors for the control output signals when pull-up resistors are called out in Table 2-7.

NOTE

Use the following equation to determine the pull-up resistor values.

$$R[k\Omega] \approx \frac{V_p[V]}{2.5}$$

Where,

V_p: Pull-up voltage

R: Pull-up resistor

The typical pull-up resistor values are:

Pull-Up Voltage	Pull-Up Resistor	HP Part Number
5 V	1.78kΩ	PN 0757-0278
9 V	3.16kΩ	PN 0757-0279
12 V	4.22kΩ	PN 0698-3154
15 V	5.11kΩ	PN 0757-0438

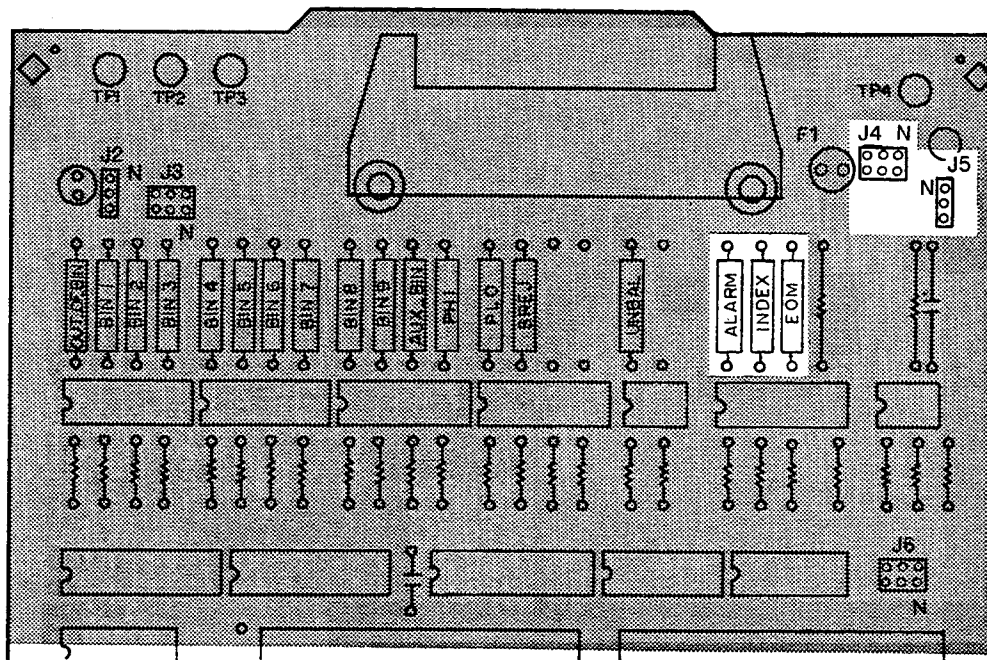

Figure 2-12. How to Set Up the Handler Interface Board (2)

14. Install the jumpers for the input signals according to Table 2-8 (See Figure 2-13).

NOTE

The drive voltage of the input signals uses the pull-up voltage for the control signals.

Table 2-8. Jumper Settings (3)

Drive Voltage	Jumper Setting	Circuit Common
	J6	
Internal +5V	Left	4284A's circuit common
Internal +12V	Right(N)	4284A's circuit common
EXT.DCV.2 (5~6V)	Left	COM2
EXT.DCV.2 (6~9V)	Center	COM2
EXT.DCV.2 (9~15V)	Right(N)	COM2

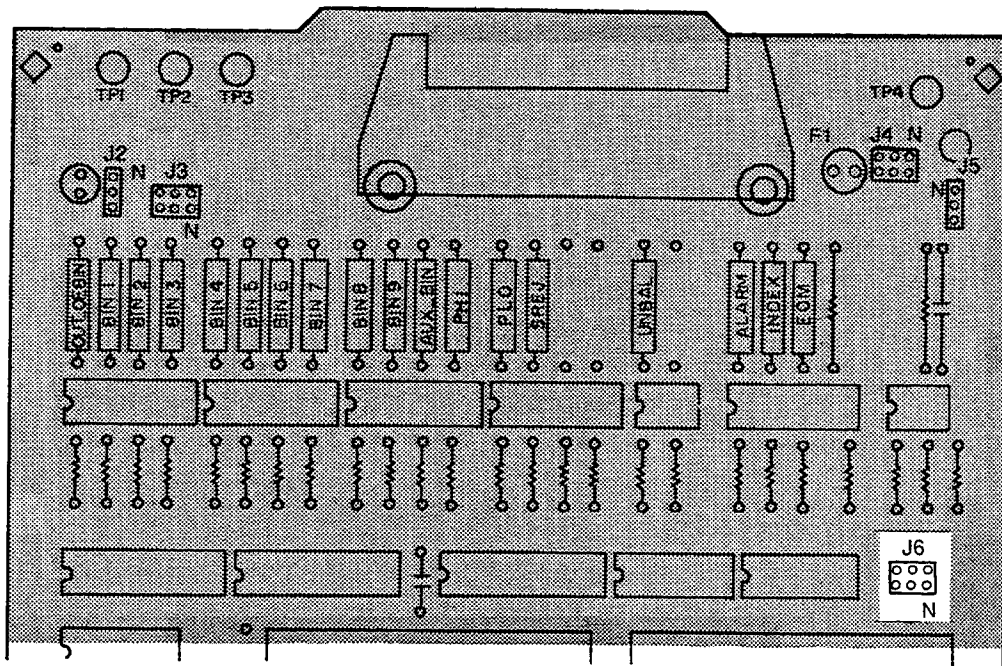

Figure 2-13. How to Set Up the Handler Interface Board (3)

15. Replace the handler interface board, top shield plate, rear feet, and top cover.

OPERATION

To use the handler interface, after setting up the handler interface board, setup the limit table for using the comparator function or the list sweep setup table for using the list sweep comparator function. Then set the handler interface to be enable to output/input the signals. The following procedures are for using the handler interface with the comparator function or the list sweep comparator function.

Setting Procedure For Comparator Function

The following operation procedures are for using the handler interface with the comparator function.

1. Press the **MEAS SETUP MENU** key, and the '**LIMIT TABLE**' softkey. The **LIMIT TABLE SETUP** page is displayed.
2. Setup a limit table for bin sorting (refer to the HP 4284A Operation Manual for details).
3. Use the **CURSOR** arrow keys to move the cursor to the **COMP** field. The following softkeys will be displayed in the softkey label area.
 - '**ON**'
 - '**OFF**'
4. Press the '**ON**' softkey. The comparator function is enabled.
5. Press the **CATALOG/SYSTEM MENU** key, and the '**SYSTEM CONFIG**' softkey. The **SYSTEM CONFIG** page is displayed.
6. Use the **CURSOR** arrow keys to move the cursor to the **HANDLER I/F (#201)** field. The following softkeys will be displayed in the softkey label area.
 - '**ON**'
 - '**OFF**'
7. Press the '**ON**' softkey. The handler interface can be used to output/input the signals.
8. Press the **DISPLAY FORMAT MENU** key. To perform a measurement, select the '**MEAS DISP**', '**BIN No.**', or '**BIN COUNT**' softkey.

NOTE

The comparator function ON/OFF can be set on the **BIN No. DISPLAY** page.

**Setting procedure
For List Sweep
Comparator
Function**

The following operation procedures are for using the handler interface with the list sweep comparator function.

1. Press the **MEAS SETUP MENU** key, and the **'LIST SETUP'** softkey. The **LIST SWEEP SETUP** page will be displayed.
2. Setup a list table including sweep steps and high/low limits for the list sweep measurement (refer to the HP 4284A Operation Manual for details).
3. Press the **CATALOG/SYSTEM MENU** key, and the **'SYSTEM CONFIG'** softkey. The **SYSTEM CONFIG** page will be displayed.
4. Use the **CURSOR** arrow keys to move the cursor to the **HANDLER I/F (#201)** field. The following softkeys will be displayed in the softkey label area.
 - **'ON'**
 - **'OFF'**
5. Press the **'ON'** softkey. Then the handler interface can be used to output/input the signals.
6. Press the **DISPLAY FORMAT MENU** key. To perform list sweep measurements, select the **'LIST SWEEP'** softkey.

NOTE

The Operation Note for Option 202 Handler Interface, starting from the next page, was written for use with the 4284A. This Operation Note is also applicable to the 4285A without any changes in description.

4284A PRECISION LCR METER
OPERATION NOTE

Option 202 Handler Interface



Agilent Technologies

Printed in JAPAN

TABLE OF CONTENTS

SECTION 1:

GENERAL INFORMATION

INTRODUCTION	1-1
DESCRIPTION	1-1
SPECIFICATIONS	1-1

SECTION 2:

OPERATION

INTRODUCTION	2-1
SIGNAL LINE DEFINITION	2-1
Signal Line Used for Comparator Function	2-1
Signal Line Used for List Sweep	
Comparator Function	2-5
ELECTRICAL CHARACTERISTICS	2-9
DC Isolated Outputs	2-9
DC Isolated Inputs	2-12
OPERATION	2-14
Setting Procedure For Comparator Function	2-14
Setting Procedure For List Sweep Comparator Function	2-15

SECTION 3:

SETTING UP THE HANDLER INTERFACE BOARD

INTRODUCTION	3-1
GENERAL CONFIGURATION	3-1
General Configuration Procedure	3-3
CONFIGURATION EXAMPLES	3-7
Standard Configuration	3-7
Palomar Model M16	3-9
Palomar Model M11	3-11
Q-Corporation RTR2	3-13
Isumeca 83	3-15
EA Model M015	3-17

GENERAL INFORMATION

INTRODUCTION

This operation note provides the information necessary to use the HP 4284A precision LCR Meter Option 202 Handler Interface. Refer to the HP 4284A Operation Manual for HP 4284A specific operating procedures.

DESCRIPTION

The Option 202 Handler Interface can be configured to physically and electrically interface the HP 4284A to the following component handlers:

- Palomar Model M16 Handler
- Palomar Model M11 Handler
- Q-Corporation RTR2 Handler
- Isumeca 83 Handler
- EA Model M015 Handler

The HP 4284A Option 202 is a Handler Interface to output signals, including a measurement completed signal, and bin sort judgments of the comparator function, or Go/No-Go judgments of the list sweep comparator function, and to input external trigger signal and keylock signal. By using these signals, the HP 4284A can easily be combined with any of the component handlers listed above, and a system controller to fully automate LCR component testing, sorting, and quality control data processing to increase production efficiency.

SPECIFICATIONS

Table 1-1 lists the HP 4284A Option 202 Handler Interface specifications only. Other specifications are the same as for a standard HP 4284A.

Table 1-1. Specifications

Output signal:	Opto-isolated and Open collector with internal pull-up resistor (to + 5 V), or external pull-up resistor and pull-up supply voltage (+ 24 V, 80 mA maximum).
Decision Output:	
Comparator Function:	Bin number
List Sweep Comparator Function:	
	IN/OUT at each sweep point and pass/fail for the result of sequential comparisons.
EOC:	End of conversion A/D output.
BUSY:	HP 4284A is busy with conversion or calculation.
Input Signal:	Opto-isolated or TTL. Opto-isolated input is a current input (5 mA to 60 mA). TTL input is a schmitt-trigger input (hysteresis = 0.8 V) with an internal 1 K Ω pull-up resistor.
START IN:	Input trigger to start a measurement. Minimum required pulse width is $\geq 5 \mu\text{s}$ with W11 installed.

OPERATION

INTRODUCTION

This section provides information necessary to use the Option 202 Handler Interface, including descriptions of the interface signal lines and their electrical characteristics.

SIGNAL LINE DEFINITION

The handler Interface uses three types of signals, comparison output, control input and control output. The signal lines for the Comparator Function and the List Sweep Comparator Function are defined differently for comparison output and control output signals. The following defines the the signals when the handler interface Comparator Function and the List Sweep Comparator Function are used.

Signal Line Used for Comparator Function

The signal definitions used for the Comparator Function are as follows.

- Comparison Output Signals:

BIN1 - BIN10. See Figure 2-1.

- Control Input Signal:

START IN (Triggers the HP 4284A to start a measurement.)

- Control Output Signals:

EOC:

An opto-isolated signal output by the HP 4284A to tell the handler when the end of conversion occurs. At the End Of Conversion the HP 4284A enters the correction, calculation and comparison phase and the handler is free to position the next DUT for testing.

BUSY:

An opto-isolated signal output by the HP 4284A telling the Handler that the HP 4284A is busy performing a measurement, comparison, or calculation.

NOTE

The assertion level of the following signals is selected by the jumper settings W3 through W13. Refer to **SECTION 3** for jumper setting details.

The contact assignments and a brief description of each signal used for the comparator function are given in Table 2-1 and Figure 2-2. The timing diagram is shown in Figure 2-3.

Table 2-1. Pin Assignments For Comparator Function

Pin No.	Signal Name	Description
1	Common	Isolated Common
2 3 4 5 6 7 8 9 10 11	BIN0 BIN1 BIN2 BIN3 BIN4 BIN5 BIN6 BIN7 BIN8 BIN9	Bin sorting results Opto-Isolated open collector output
12	+ 5V OUT	+5 V for external use.
13	System Ground	Instrument Logic Ground
14	START IN	Trigger Input (Signal from Handler)
15	EOC	End of Conversion A/D output
16	BIN10	Bin 10 Sorting result (same as BIN0 - 9)
17		+5 V output when jumper W1 is installed
18	BUSY	BUSY (conversion, calculation) output
19 - 36		No Connection

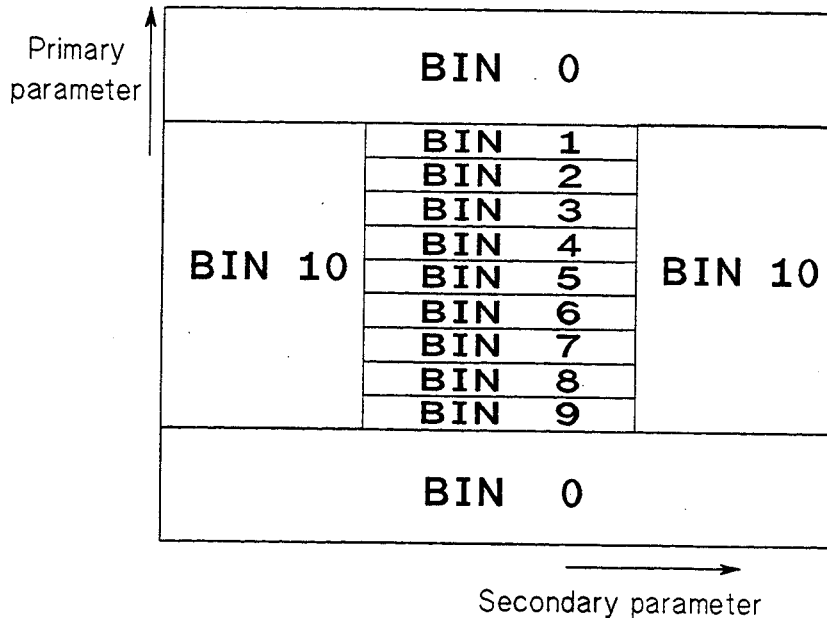

Figure 2-1. BIN0 - BIN10 Limit Map
(For The Comparator Function)

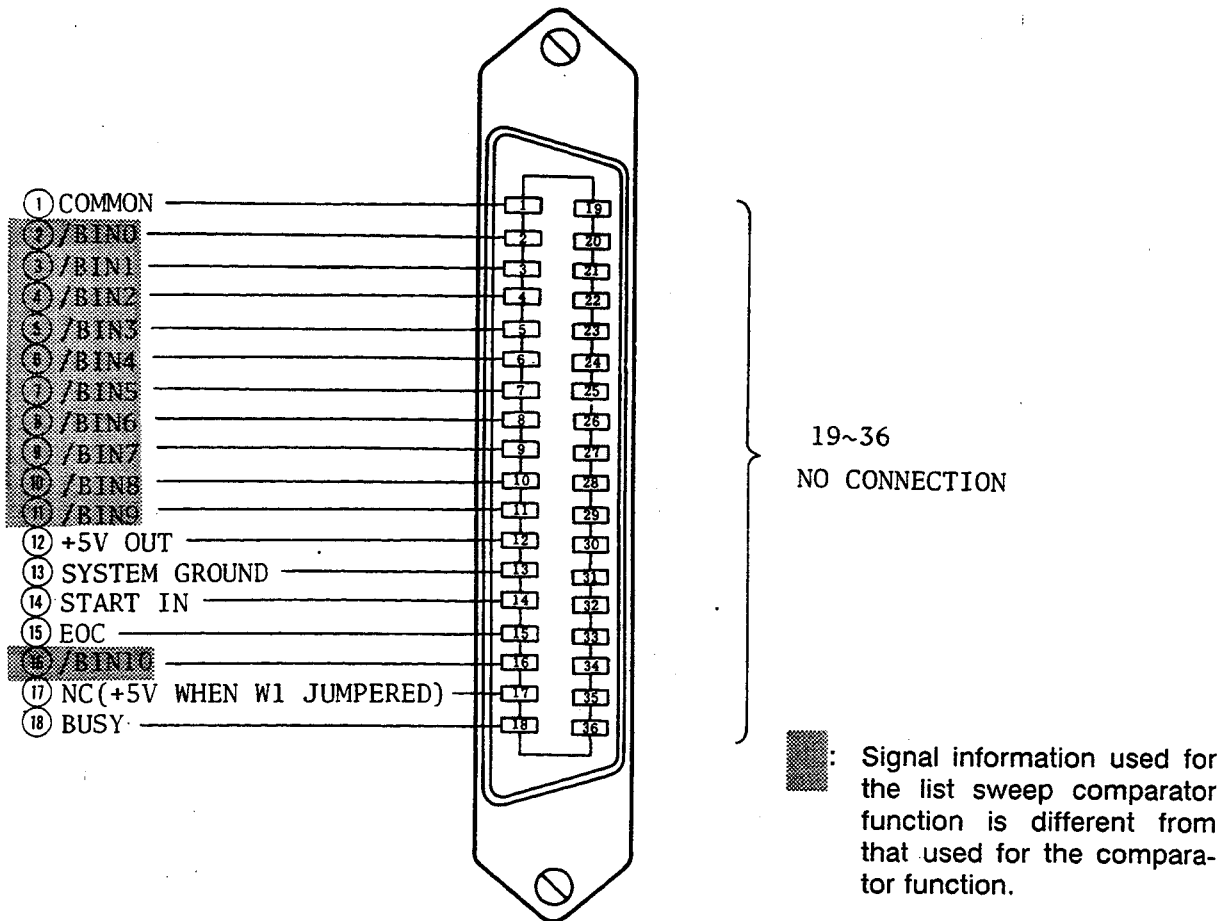
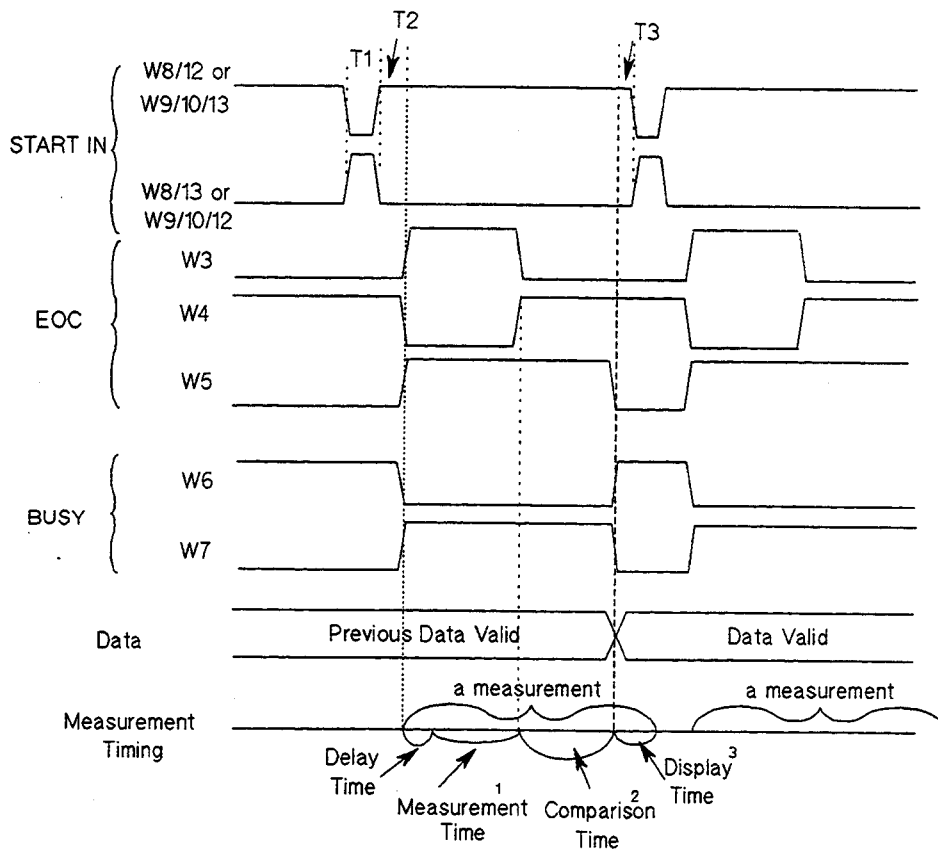

Figure 2-2. Handler Interface Connector Pin Assignments



Time	Description	Min.	Max.
T1	Trigger Pulse Width	5 μ s or 50 μ s ⁴	---
T2	Measurement Delay Time	200 μ s	Display Time ³ + 200 μ s
T3	Trigger Wait Time after EOC is output	0 s	---

¹ Refer to the HP 4284A Operation Manual.

² Typical comparison time is approximately 1 ms.

³ Typical display time for each display format is as follows.

MEAS DISPLAY page	approx. 8 ms
BIN No.DISPLAY page	approx. 5 ms
BIN COUNT DISPLAY page	approx. 0.5 ms

⁴ Trigger pulse width is selected by installing or leaving open jumper W11 on the Handler Interface Board.

Figure 2-3. Timing Diagram (For The Comparator Function)

Signal Line Used for List Sweep Comparator Function

The signal definitions for the list sweep comparator function are different from the definitions for the comparator function. The List Sweep Comparator function signal definitions are as follows.

- Comparison Output Signals:

BIN1 - BIN10 indicate IN/OUT judgments at each sweep point (refer to Figure 2-4). BIN0 indicates pass/fail judgment (one or more fail judgments of Step 1 to Step 10 occurred during a single sweep).

These signals are output when a sweep measurement is completed.

- Control Output Signals:

EOC (analog measurement completed signal) and BUSY (end of measurement signal). The timing when EOC and BUSY are asserted is as follows (different from the timing used for the comparator function).

- In the SEQ sweep mode:

EOC is asserted when last step analog measurement of the sweep measurement is completed, and BUSY is asserted when the all of comparison results are valid after a sweep measurement.

- In the STEP sweep mode:

EOC is asserted when each step analog measurement of the sweep measurement is completed, and BUSY is asserted when each step measurement including comparing time is completed.

The contact assignments and a brief description of signals used for the list sweep function are given in Table 2-2 and Figure 2-2 (pin assignments for the list sweep comparator function is same to for the comparator function). The timing diagram is shown in Figure 2-5.

NOTE

The assertion level of the following signals is selected by the jumper settings W3 through W13. Refer to **SECTION 3** for jumper setting details.

Table 2-2. List Sweep Comparator Function Pin Assignments

Pin No.	Signal Name	Description
2	BIN0	Is asserted when one or more fail judgments of Step 1 to Step 10 occur.
3 4 5 6 7 8 9 10 11	BIN1 BIN2 BIN3 BIN4 BIN5 BIN6 BIN7 BIN8 BIN9	Failed (out of limit) at sweep Point 1 Failed (out of limit) at sweep Point 2 Failed (out of limit) at sweep Point 3 Failed (out of limit) at sweep Point 4 Failed (out of limit) at sweep Point 5 Failed (out of limit) at sweep Point 6 Failed (out of limit) at sweep Point 7 Failed (out of limit) at sweep Point 8 Failed (out of limit) at sweep Point 9
15	EOC	In the SEQ sweep mode: EOC is asserted when a analog measurement of last sweep step is complete and the HP 4284A is ready for the next DUT to be connected to the UNKNOWN terminals. The measurement data, however, is not valid until the BUSY line is asserted. (See Figure 2-5.) In the STEP sweep mode: EOC is asserted when each analog measurement is complete and the HP 4284A is ready for the next sweep step. The measurement data, however, is not valid until the BUSY line is asserted. (See Figure 2-5.)
16	BIN10	Failed (out of limit) at sweep Point 10
18	BUSY	BUSY (conversion, calculation) output In the SEQ sweep mode: This signal is asserted when the measurement data and comparison results are valid after the last step measurement is completed. (See Figure 2-5.) In the STEP sweep mode: This signal is asserted when each step measurement including comparison time is completed and the measurement data is valid. The comparison results are valid after BUSY is asserted after the last sweep point. (See Figure 2-5.)
1, 12 - 14, 17, 19 - 36		Same assignments as for the comparator function (refer to Table 2-1).

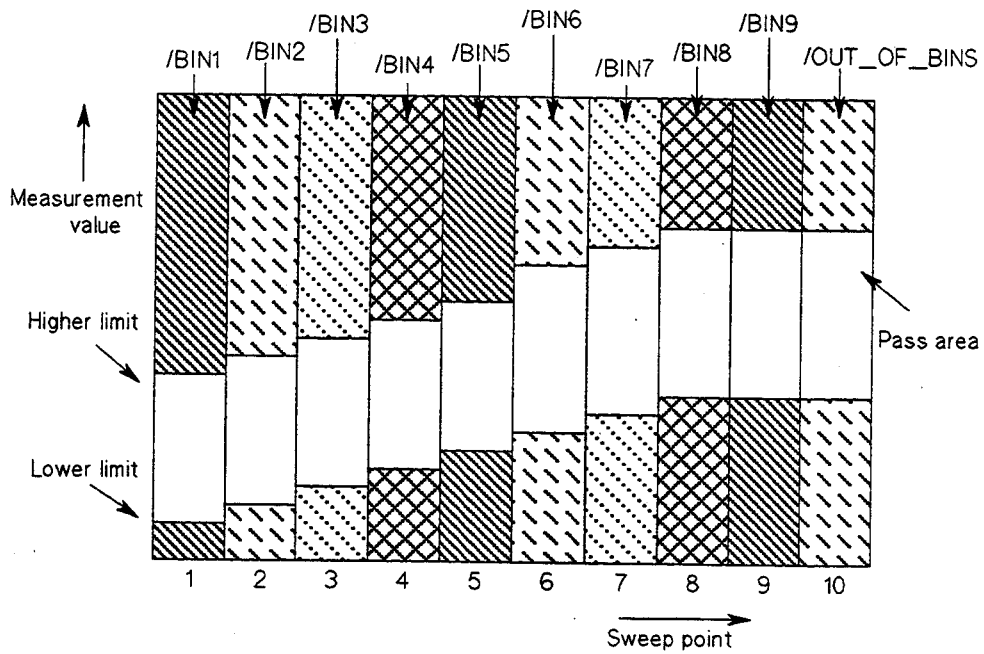
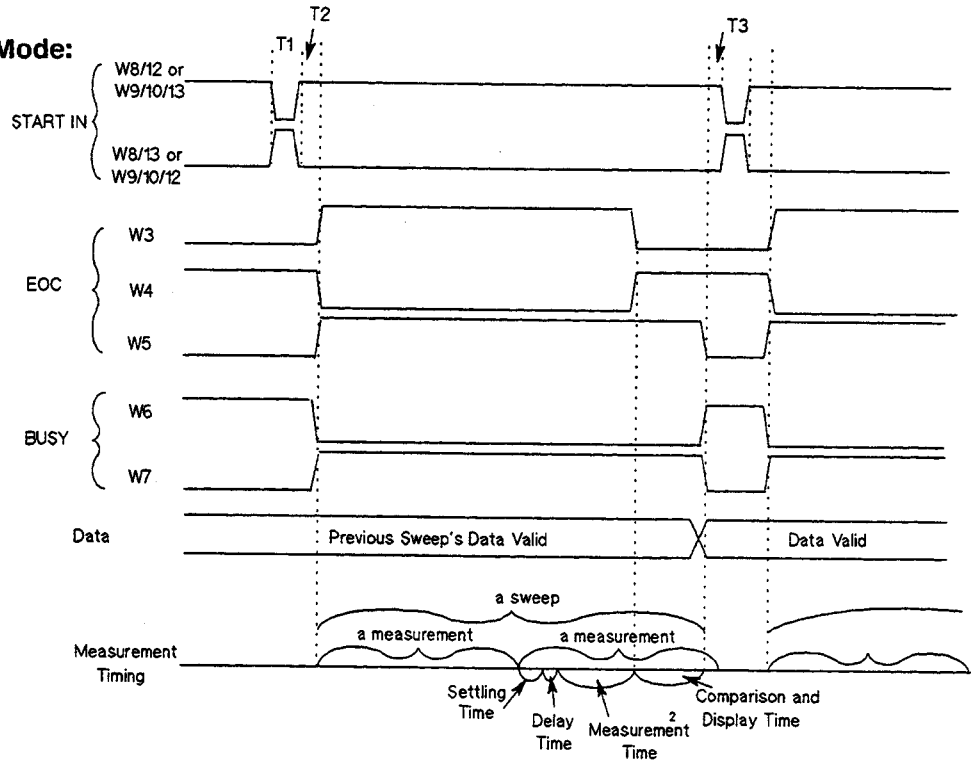
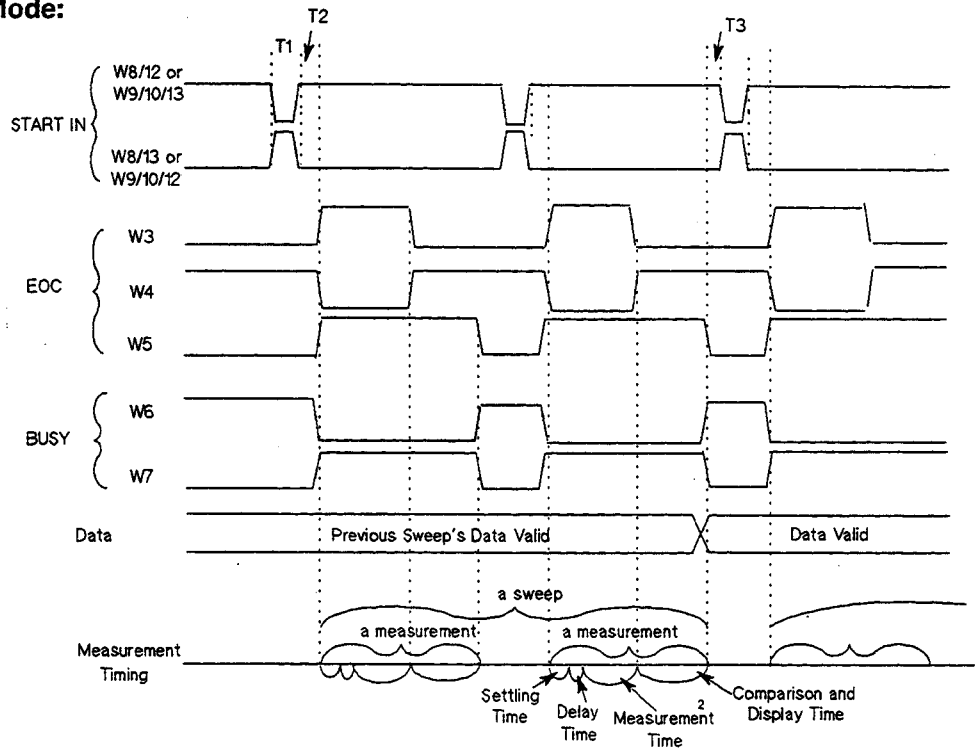

Figure 2-4. Signal Area Example
 (For The List Sweep Comparator Function)

SEQ Sweep Mode:



STEP Sweep Mode:



NOTE

Settling Time includes Correction Data Switching Time. Comparison and Display Time is approx. 4.5 ms. Refer to Figure 2-3 for information on T1, T2, T3.

Figure 2-5. Timing Diagram for The List Sweep Comparator Function

ELECTRICAL**CHARACTERISTICS**

As mentioned in a previous paragraph, some of the signal's represent different information when used for the comparator function and for the list sweep comparator function. However, the electrical characteristics of these signals are completely the same between the two operations. The following description applies when using both the comparator function and the list sweep comparator function.

Opto-Isolated Outputs

The outputs from the HP 4284A are Opto-Isolated for added interfacing flexibility and to increase reliability by reducing noise pickup. Provisions have been made for mounting pull-up resistors connected to +5 V on board for systems using TTL logic levels, otherwise the supply voltage (24 V maximum), and the pull-up resistors are located in the handler (the combination of the pull-up resistor and the pull-up supply voltage used must result in a current through the opto-isolator of less than 80 mA). The opto-isolator common supply path can be connected to or isolated from the HP 4284A's system ground with jumper W2. Installing jumper W2 connects the opto-isolator common to the HP 4284A's system ground.

Table 2-3. Electrical DC Characteristics of Opto-Isolated Outputs

Output Signals	Voltage Output Level		Maximum Current
	Low	High	
Binning Signals BIN0 - BIN10	$\leq 0.5 \text{ V}$	$5 - 24 \text{ V}^1$	80 mA
Control Signals EOC	$\leq 0.5 \text{ V}$	$5 - 24 \text{ V}^1$	80 mA
BUSY	$\leq 0.5 \text{ V}$	$5 - 24 \text{ V}^1$	80 mA

¹ Depends on the value of pull-up voltage used. The pull-up voltage on the handler interface board is +5 V, and up to 24 V can be used from an external source (from the handler).

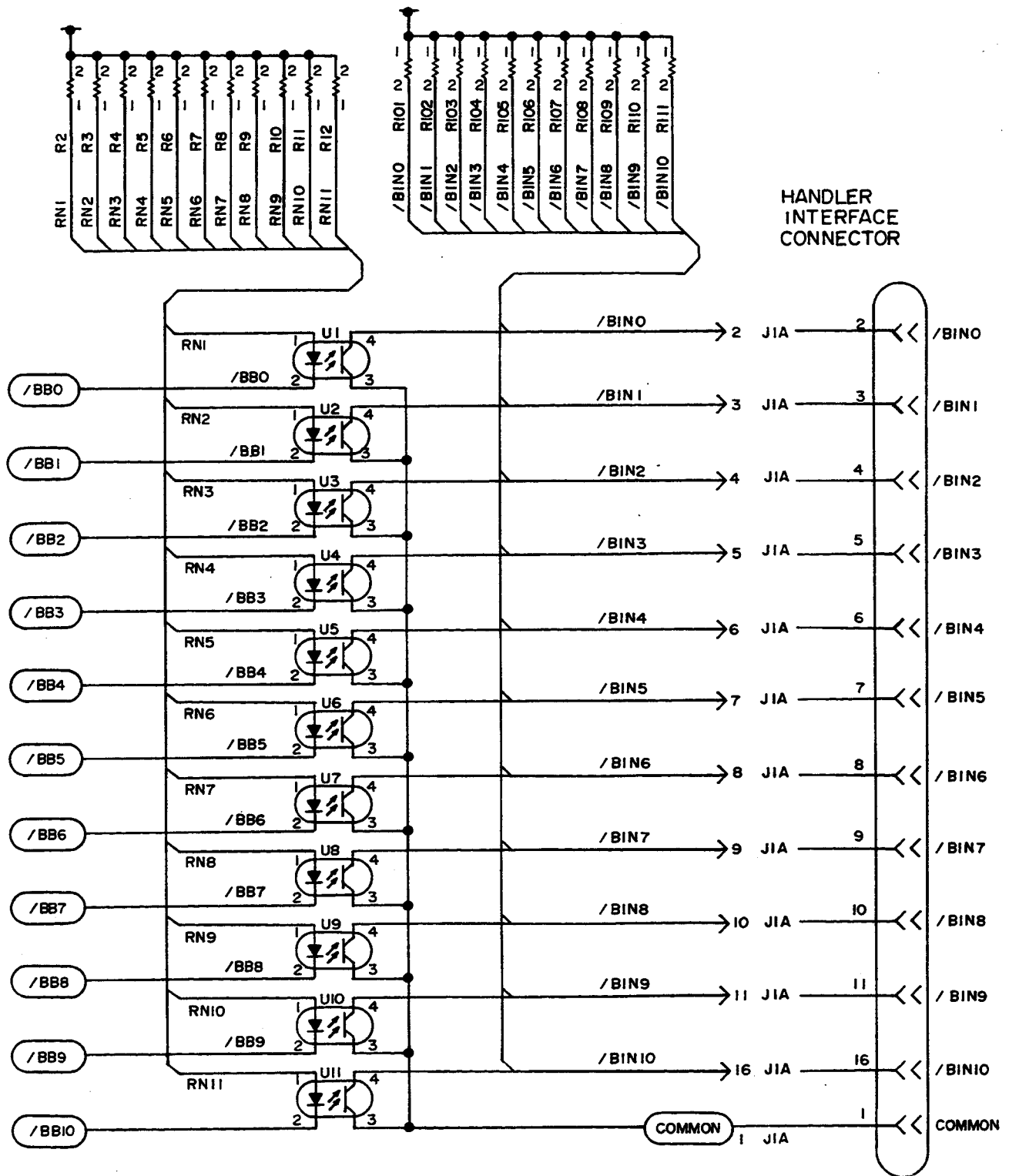

Figure 2-6. Simplified Binning Output Schematic

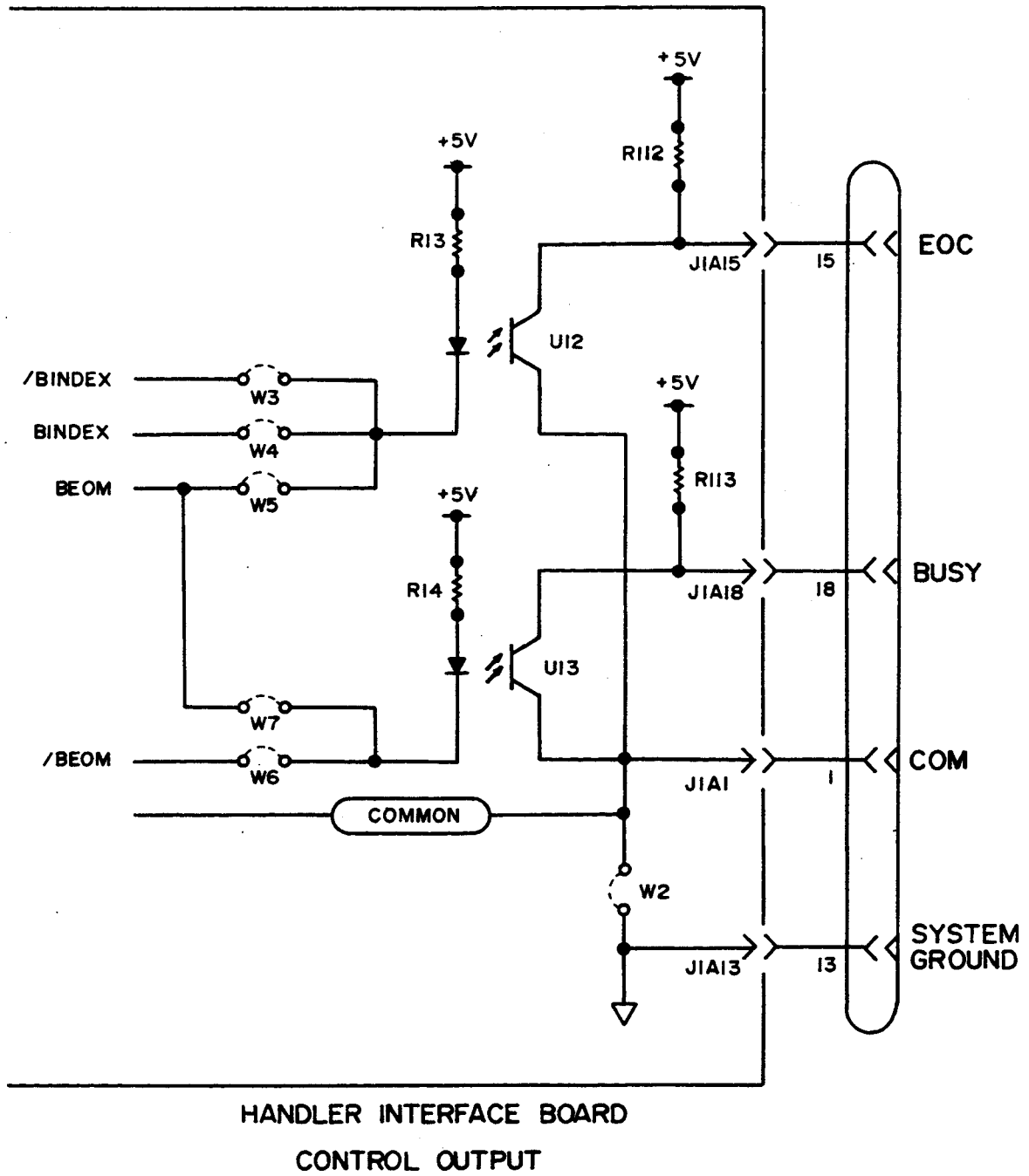

Figure 2-7. Simplified Control Output Schematic

Opto-Isolated Input

The START IN input trigger signal can be opto-isolated by installing jumpers W9 and W10 while leaving jumper position W8 open. When this input is used as an opto-isolated input, it is current driven and requires 5 - 60 mA for proper operation. For TTL level trigger input signals, install jumper W8 and leave jumper positions W9 and W10 open.

Table 2-4. Typical Input Electrical Characteristics

Input Signal	Input Electrical Characteristics			
START IN (Opto-Isolated)	Input Current		Input Voltage	
	Low	High		
	0 - 250 μ A	5 - 60 mA ²	2.0 V (Input Current= 5 mA)	
START IN ¹ (TTL Level)	Input Threshold Voltage		Input Current	
	Low	High	Low	High
	0.8 V	1.6 V	-0.4 mA	20 μ A

¹ Schmitt-Trigger input, hysteresis = 0.8 V.

² Do not use less than 5 mA, the opto-isolator LED requires a minimum of 5 mA for proper operation.

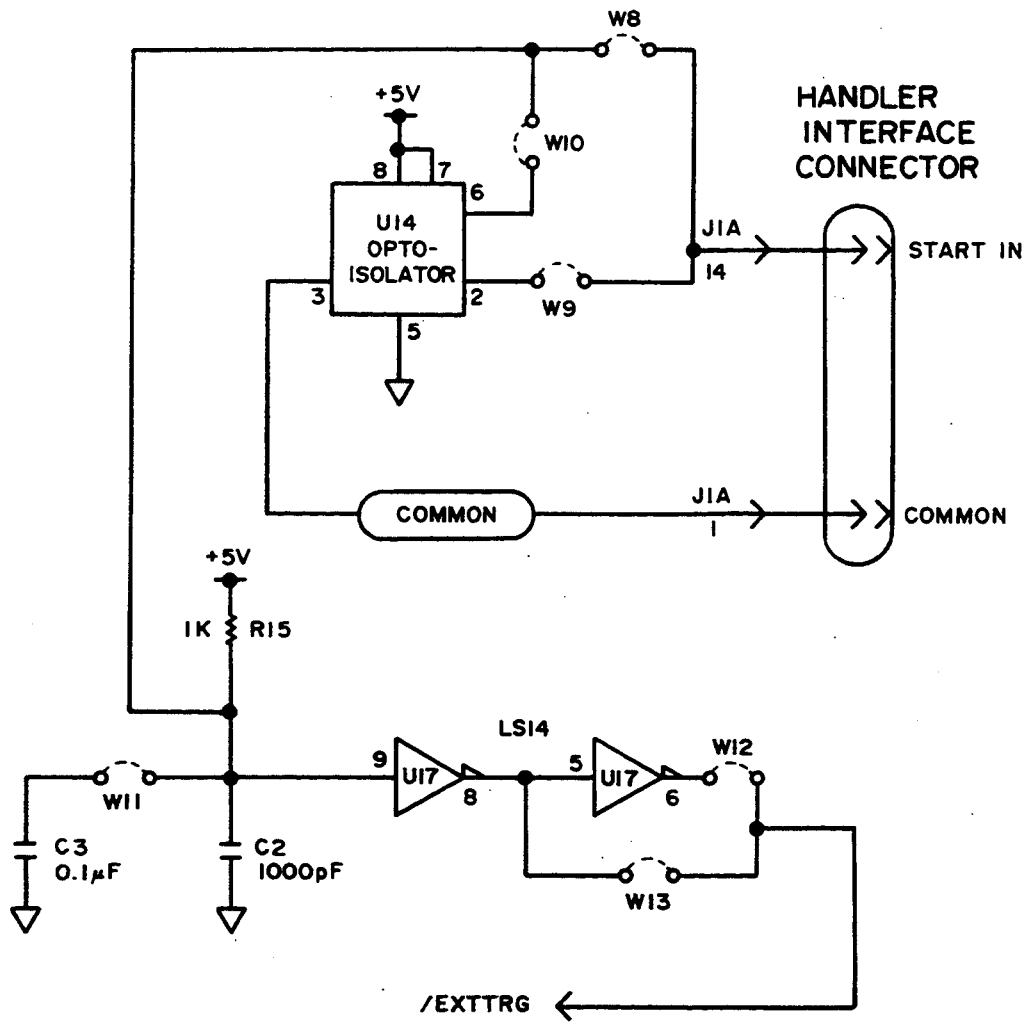

Figure 2-8. Handler Interface Input Schematic

OPERATION

To use the handler interface, setup the comparator function or the list sweep comparator function, and set the handler interface to be enable to output/input signals. The followings are procedure to use the handler interface with the comparator function or the list sweep comparator function.

Setting Procedure For Comparator Function

The followings are operation procedure to use the handler interface with the comparator function.

1. Setup the Handler Interface Board consists of installing jumpers and pull-up resistors as required for the handler. See **SECTION 3, SETTING UP THE HANDLER INTERFACE BOARD.**
2. Turn the HP 4284A ON.
3. Setup for the appropriate measurement conditions.
4. Press the **MEAS SETUP MENU** key, and the '**LIMIT TABLE**' softkey. The **LIMIT TABLE SETUP** page is displayed.
5. Setup a limit table for bin sorting (refer to the HP 4284A Operation Manual for details).
6. Move the cursor to the **COMP** field using the **CURSOR** arrow key. Then the following softkeys will be displayed on the softkey label area.
 - '**ON**' softkey
 - '**OFF**' softkey
7. Press the '**ON**' softkey to enable the comparator function.
8. Press the **CATALOG/SYSTEM MENU** key, and the '**SYSTEM CONFIG**' softkey. The **SYSTEM CONFIG** page is displayed.
9. Move the cursor to the **HANDLER I/F (#202)** field using the **CURSOR** arrow key. Then the following softkeys will be displayed on the softkey label area.
 - '**ON**' softkey
 - '**OFF**' softkey
10. Press the '**ON**' softkey. Then the handler interface can be used to output/input the signals.
11. Press the **DISPLAY FORMAT MENU** key. To perform measurement, select the '**MEAS DISP**', '**BIN No.**', or '**BIN COUNT**' softkey.

NOTE

The Comparator function ON/OFF can be set on the **BIN No. DISPLAY** page.

Setting procedure For List Sweep Comparator Function

The following are operation procedures for using handler interface with the list sweep comparator function.

1. Setup the Handler Interface Board consists of installing jumpers and pull-up resistors as required for the handler. See **SECTION 3, SETTING UP THE HANDLER INTERFACE BOARD**.
2. Turn the HP 4284A ON.
3. Setup for the appropriate measurement conditions.
4. Press the **MEAS SETUP MENU** key, and the '**LIST SETUP**' softkey. The **LIST SWEEP SETUP** page is displayed.
5. Setup a list table including sweep steps and high/low limits for the list sweep measurement (refer to the HP 4284A Operation Manual for details).
6. Press the **CATALOG/SYSTEM MENU** key, and the '**SYSTEM CONFIG**' softkey. The **SYSTEM CONFIG** page is displayed.
7. Move the cursor to the **HANDLER I/F (#202)** field using the **CURSOR** arrow key. Then the following softkeys will be displayed on the softkey label area.
 - '**ON**' softkey
 - '**OFF**' softkey
8. Press the '**ON**' softkey. Then the handler interface can be used to output/input the signals.
9. Press the **DISPLAY FORMAT MENU** key. To perform list sweep measurements, select the '**LIST SWEEP**' softkey.

NOTES

SETTING UP THE HANDLER INTERFACE BOARD

INTRODUCTION

This section provides information on how to setup the handler interface board to interface your handler. Setting up the handler interface board consists of installing jumpers and pull-up resistors as required.

GENERAL CONFIGURATION

Table 3-1 lists the jumpers and pull-up resistors to install for various handlers on the market, and Table 3-2 lists jumper definitions.

Table 3-1. Internal Jumper Settings

Handler	EOC	BUSY	START IN	+5, GND	Note
(standard)	W4	W6	W9, 10, 13		Default jumpers installed at the factory
PALOMAR M16	W5	W6	W8, 13	W1, 2	Mount 1.78 K Ω pull-up resistors at locations R101 - R113 for BIN 0 - BIN 10, EOC, and BUSY.
PALOMAR M11	W4	W6	W8, 12	W1, 2	MOUNT 1.78 K Ω pull-up resistors at locations R101 - R113 for BIN 0 - BIN 10, EOC, and BUSY.
Q Model RTR2	W4	W6	W9, 10, 13	W1, 2	
ISUMECA	W4	W6	W9, 10, 11 and W13		
EA Model 015	W4	W6	W9, 10, 12		

Table 3-2. Jumper Definitions

Jumper	Definition When Installed
W1	+5 V is supplied at pin 17.
W2	COMMON is connected to the system ground. When +5 V from the handler interface is used, this jumper must be installed.
W3	EOC is asserted LOW when the measurement is completed and the HP 4284A is ready for the next DUT.
W4	EOC is asserted HIGH when the measurement is completed and the HP 4284A is ready for the next DUT.
W5	EOC is asserted LOW while the measurement data and comparison results are invalid.
W6	BUSY is asserted HIGH while the measurement data and comparison results are invalid.
W7	BUSY is asserted LOW while the measurement data and comparison results are invalid.
W8	Sets the START IN input to operate at TTL levels. W9 and W10 must be left open.
W9, W10	Opto-isolates the START IN input, both W9 and W10 must have jumpers installed and W8 must be left open.
W11	Adds a 0.1 μ F capacitor to filter out noise on the START IN input.
W12	Sets the HP 4284A to trigger on the falling edge of the START IN input signal (Opto-Isolator).
	Sets the HP 4284A to trigger on the raising edge of the START IN input signal (TTL).
W13	Sets the HP 4284A to trigger on the raising edge of the START IN input (Opto-Isolator).
	Sets the HP 4284A to trigger on the falling edge of the START IN input signal (TTL).

General Configuration Procedure

If you are using one of the handlers listed below perform steps 1 through 6 of the following general configuration procedure, and then go to page 3-7, **CONFIGURATION EXAMPLES** for your handler and install the pull-up resistors and jumpers as directed. Use the complete procedure to configure the Option 202 Handler Interface Board for a handler that is not listed.

- Palomar Model M16
- Palomar Model M11
- Q-Corporation RTR2
- Isumeca 83
- EA Model M015

Figure 3-1 shows the location of the handler interface board in the HP 4284A, Figure 3-2 shows the locations of the pull-up resistors on the handler interface board, and Figure 3-3 shows the locations of the handler interface jumpers.

1. Disconnect the HP 4284A's power cord and allow enough time (a few minutes) for the internal supply filter capacitors to discharge.

WARNING

DANGEROUS ENERGY/VOLTAGE EXISTS WHEN 4284A IS IN OPERATION AND JUST AFTER IT IS POWERED DOWN. ALLOW A FEW MINUTES FOR THE INTERNAL CAPACITORS TO DISCHARGE.

2. Disconnect the two rear feet which lock the top cover and rear panel together.
3. Fully loosen the top cover retaining screws located at the rear of the top panel.
4. Slide the top cover towards the rear and lift it off to expose the top shield plate.
5. Remove the top shield plate to gain access to the PC boards.
6. Disconnect the flat cable connected to the handler interface board which has Brown and Orange extractors, as shown in Figure 3-1.

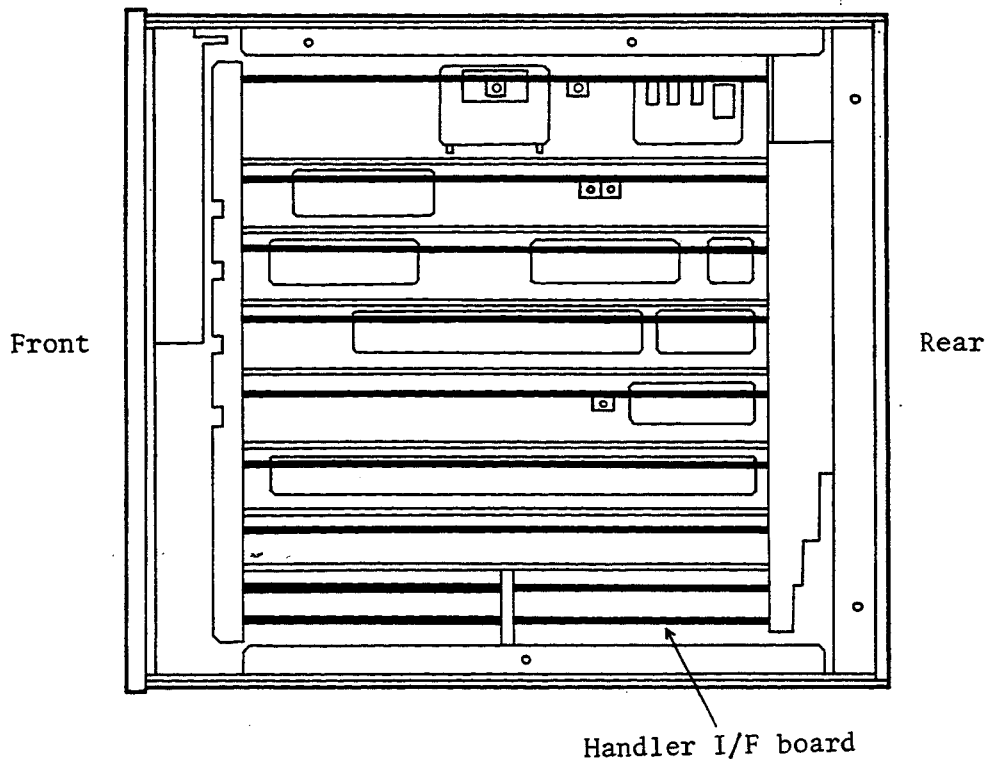

Figure 3-1. Handler Interface Board Location

7. If the comparison output signals are TTL levels signals and if these signals are not pulled up by the handler, determine the pull-up resistor value (1.78 K Ω is recommended) and referring to Figure 3-2 for the locations of the BIN pull-up resistors, install the pull-up resistors.

8. If the control outputs (EOC, BUSY) are to be TTL level signals and if these signals are not pulled up by the handler, determine the pull-up resistor value (1.78 K Ω is recommended) and referring to Figure 3-2 for the locations of R112 (EOC) and R113 (BUSY), install the pull-up resistors.

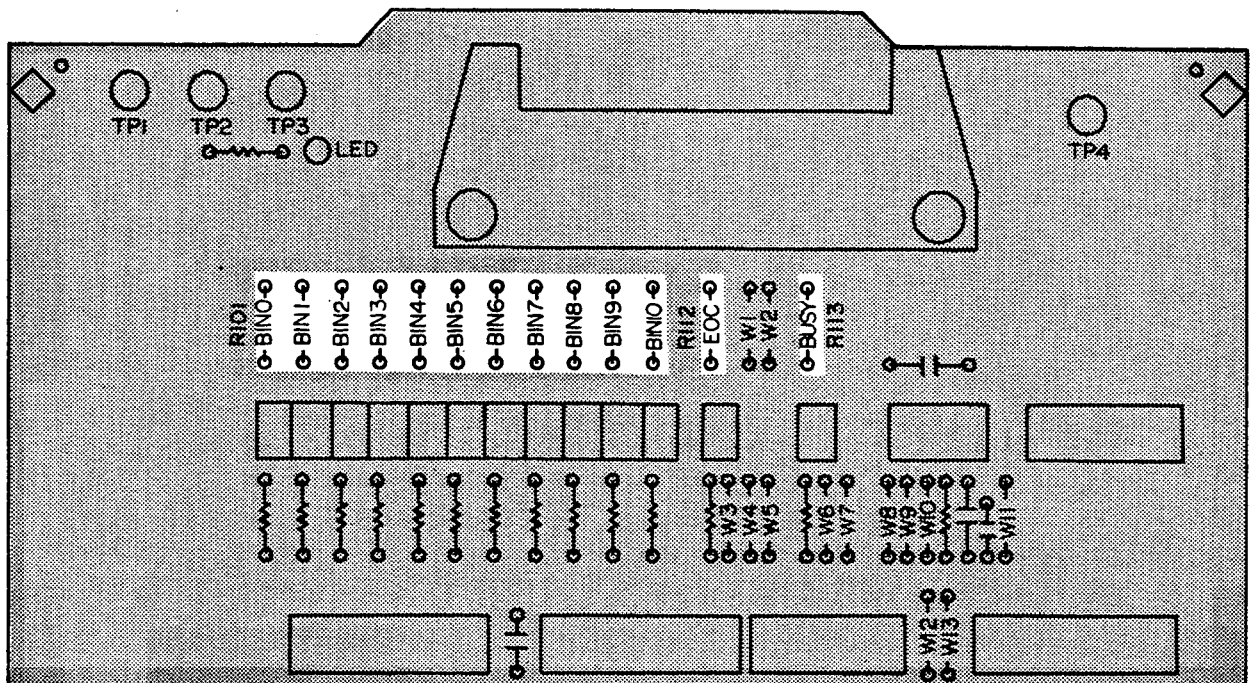

Figure 3-2. Pull-Up Resistor Locations

9. Refer to Table 3-2 to determine which jumpers to install to configure the EOC and BUSY outputs.
10. Use Figure 3-3 to locate the location of the required jumpers and install the jumpers.
11. Refer to Table 3-2 to determine the jumpers required to configure the START IN input.
12. Use Figure 3-3 to find the location of the required jumpers and install the jumpers.

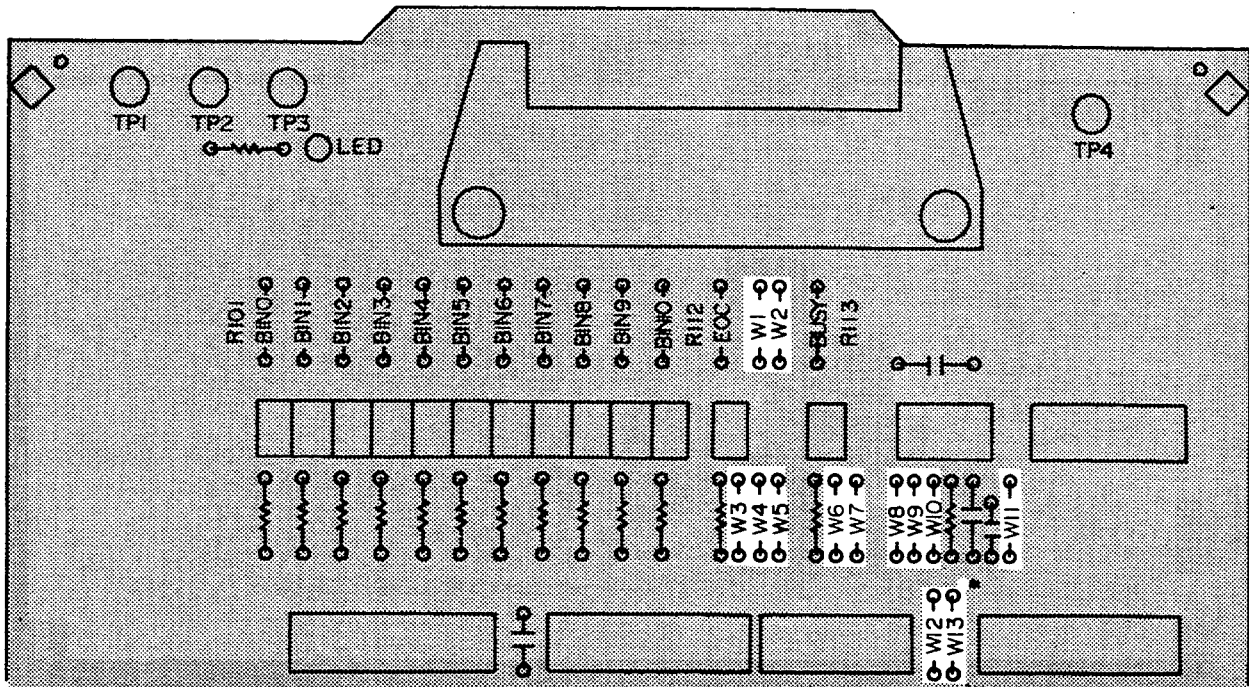

Figure 3-3. Configuration Jumper Locations

13. Install the configured handler interface board into the HP 4284A.
14. Replace the top shield plate, rear feet, and top cover.

CONFIGURATION EXAMPLES

Setup example information consisting of handler interface board configuration, timing diagrams, list of signals used, logic levels used, and other special information pertaining to the handler under discussion will now be given. Setup examples are given for the following handlers:

- Standard Configuration (default setting)
- Palomar Model M16
- Palomar Model M11
- Q-Corporation RTR2
- Isumeca 83
- EA Model M015

Standard Configuration

The default setting is the standard configuration of the Option 202 handler interface board as it is shipped from the factory. The timing for the default setup is shown in Figure 3-4 for reference.

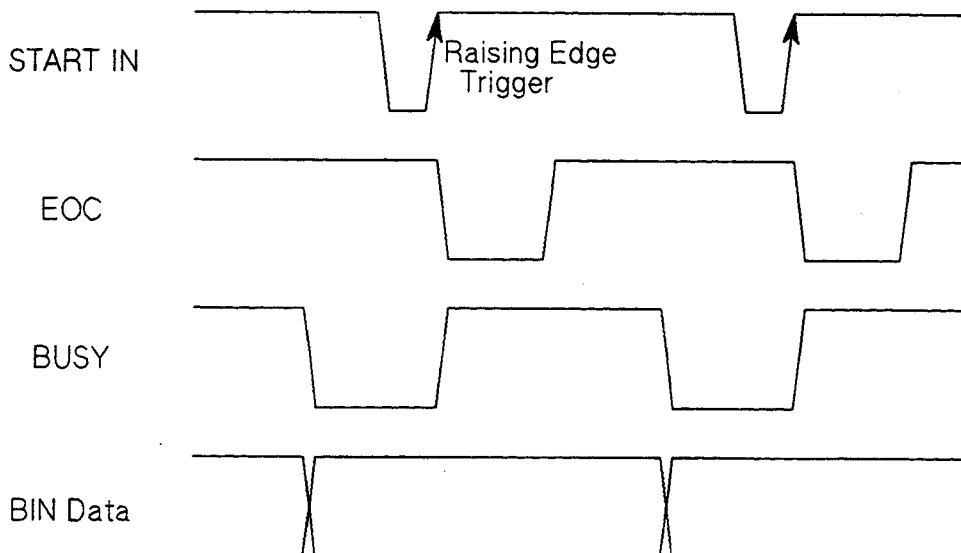

Figure 3-4. Timing for Standard Configuration
(Used with The Comparator Function)

Standard Configuration Procedure:

1. Perform steps 1 through 6 of the **General Configuration Procedure** on page 3-3.
2. Configure the following interface signals by installing the jumpers as shown in Figure 3-5.

START IN Install jumper at W9, W10 and W13
BUSY Install jumper at W6
EOC Install jumper at W4

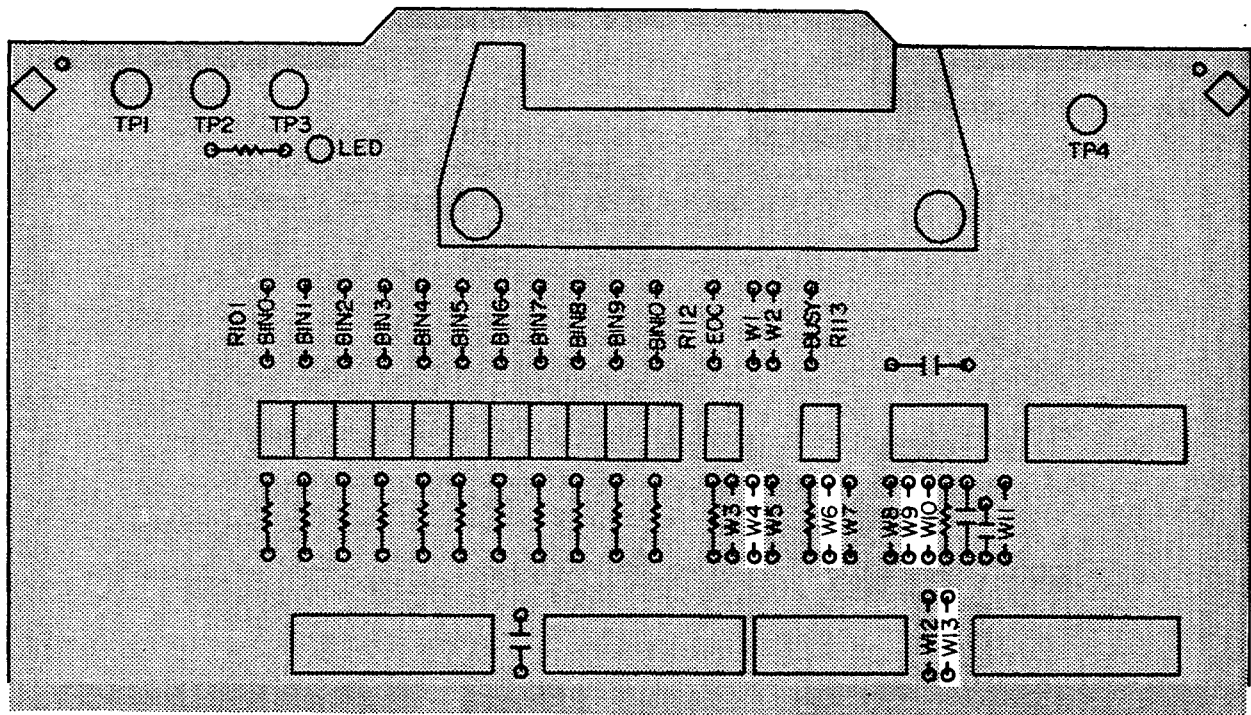

Figure 3-5. Jumper and Pull-Up Resistor Locations for Standard Configuration

3. Install the configured handler interface board into the HP 4284A.
4. Replace the top shield plate, rear feet, and top cover.

Palomar Model M16

The Palomar M16 timing diagram is shown in Figure 3-6 for reference.

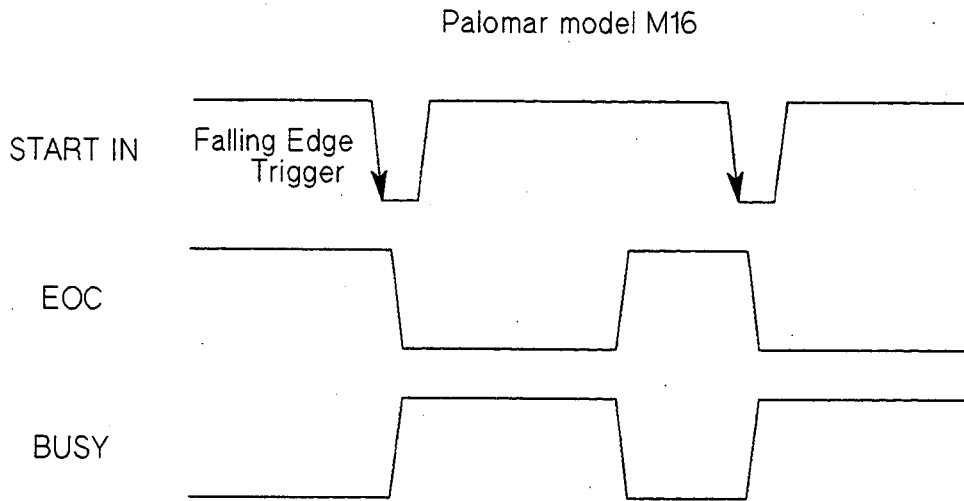

Figure 3-6. Palomar M16 Timing
(Used with The Comparator Function)

Palomar M16 Configuration Procedure:

1. Perform steps 1 through 6 of the **General Configuration Procedure** on page 3-3.
2. Configure the following interface signals by installing the jumpers as shown in Figure 3-7.

START IN Install jumper at W8 and W13
BUSY Install jumper at W6
EOC Install jumper at W5

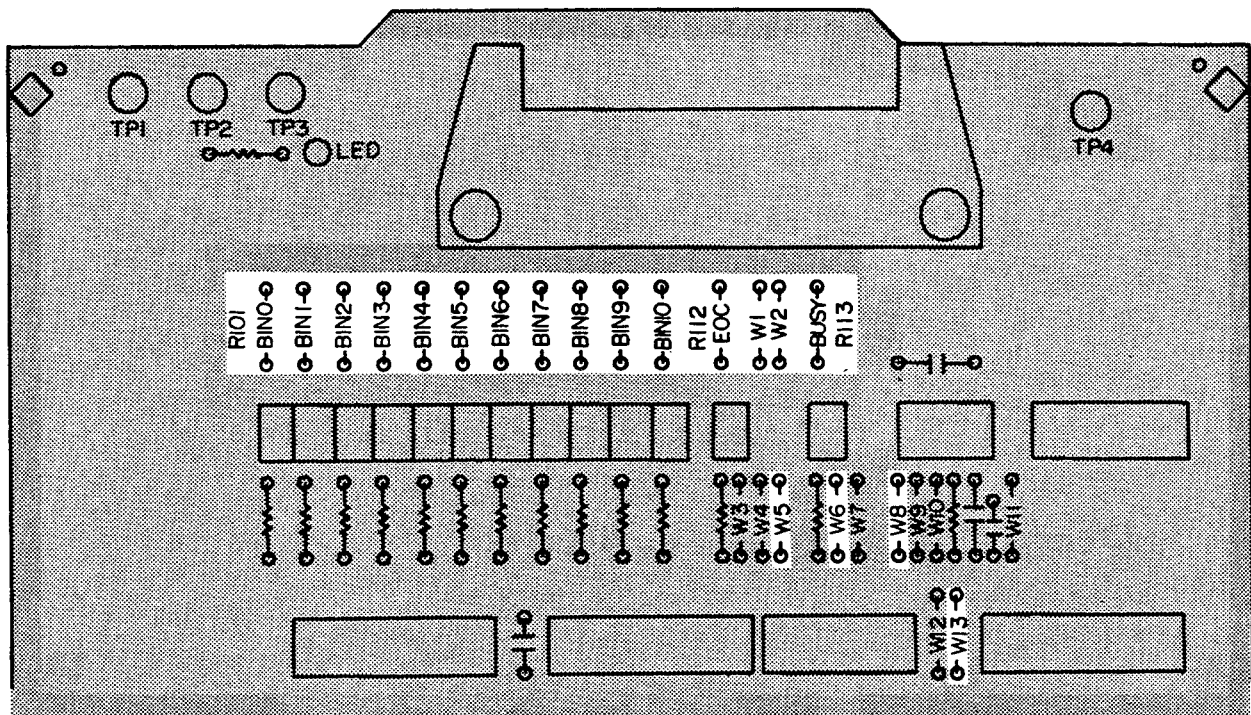

Figure 3-7. Palomar M16 Jumper and Pull-Up Resistor Locations

3. All I/O signals are TTL level so you must install all pull-up resistors to +5 V (install pull-up resistors R101 - R113). Refer to Figure 3-7 for the pull-up resistor locations.
4. Bring +5 V out through pins 12 and 17 of the handler interface rear panel connector (install a jumper at W1 for +5 V and at W2 for the COMMON connection). Refer to Figure 3-7 for the locations of W1 and W2.
5. Install the configured handler interface board into the HP 4284A.
6. Replace the top shield plate, rear feet, and top cover.

Palomar Model M11

The Palomar M11 timing diagram is shown in Figure 3-8 for reference.

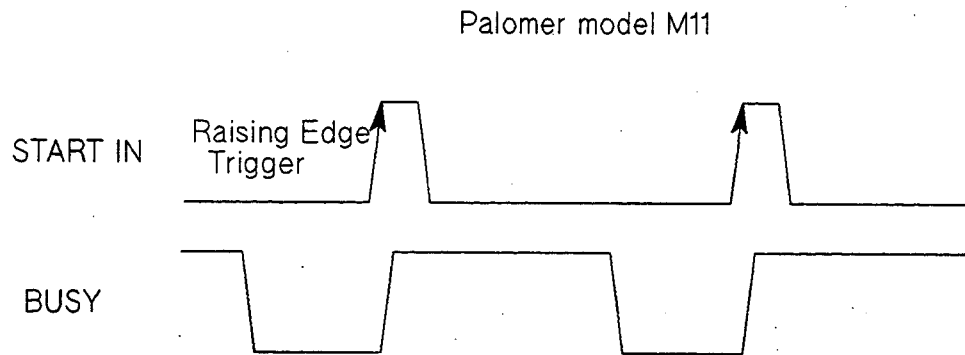

Figure 3-8. Palomar M11 I/O Timing
(Used with The Comparator Function)

Palomar M11 Configuration Procedure:

1. Perform steps 1 through 6 of the **General Configuration Procedure** on page 3-3.
2. Configure the following interface signals by installing the jumpers as shown in Figure 3-9.

START IN Install jumper at W8 and W12
BUSY Install jumper at W6
EOC Install jumper at W4

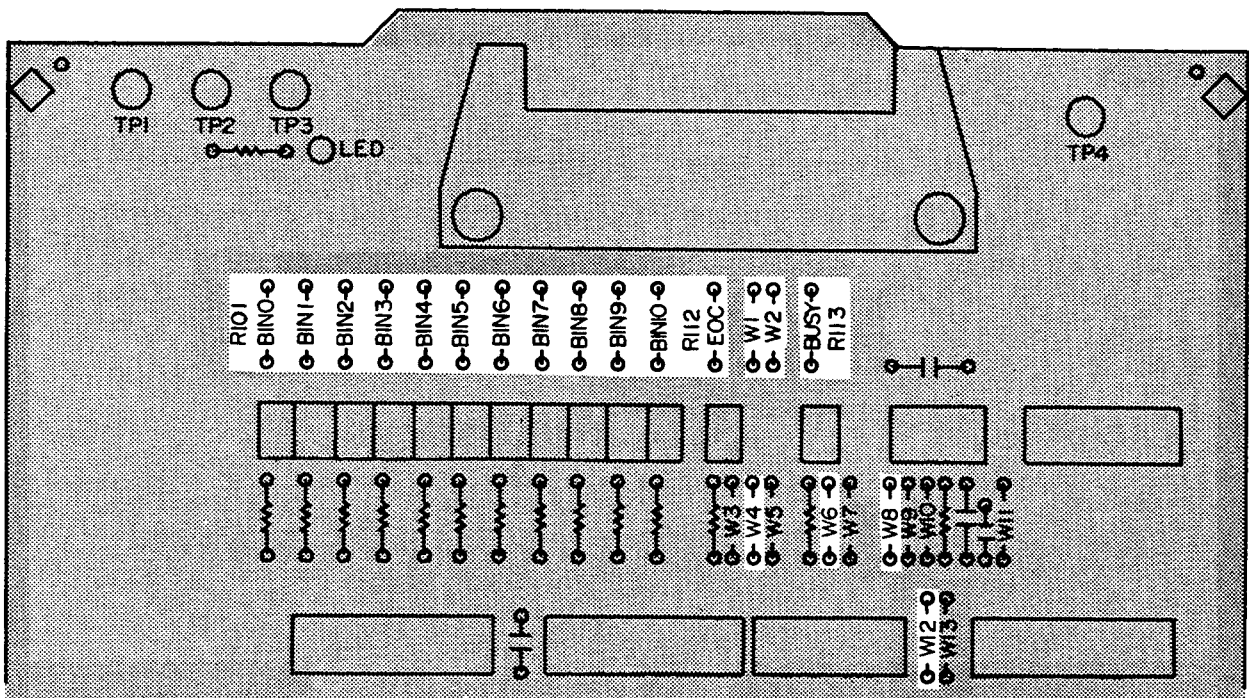

Figure 3-9. Palomar M11 Jumper and Pull-up Resistor Locations

3. All I/O signals are TTL level so you must install all pull-up resistors to +5 V (install pull-up resistors R101 - R113). Refer to Figure 3-9 for the pull-up resistor locations.
4. Bring + 5V out through pins 12 and 17 of the handler interface rear panel connector (install a jumper at W1 for +5 V and at W2 for the COMMON connection). Refer to Figure 3-9 for the locations of W1 and W2.
5. Install the configured handler interface board into the HP 4284A.
6. Replace the top shield plate, rear feet, and top cover.

Q-Corporation RTR2 The RTR2 timing diagram is shown in Figure 3-10 for reference.

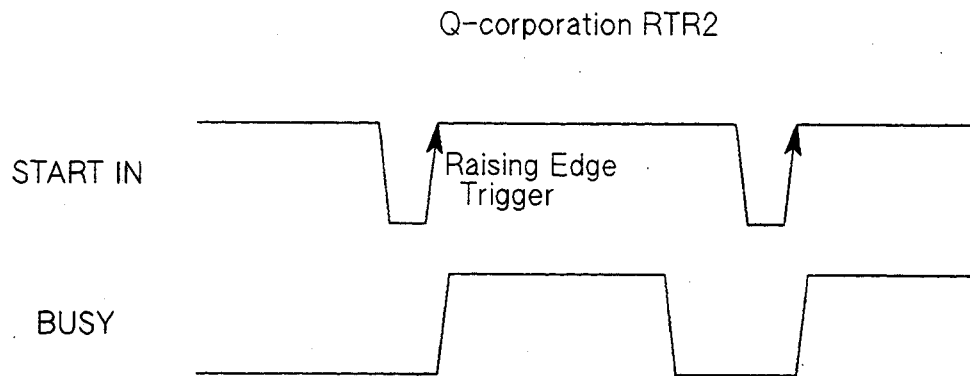

Figure 3-10. RTR2 I/O Timing
(Used with The Comparator Function)

Q-Corporation RTR2 Configuration Procedure:

1. Perform steps 1 through 6 of the **General Configuration Procedure** on page 3-3.
2. Configure the following interface signals by installing the jumpers as shown in Figure 3-11.

START IN	Install jumper at W9, W10, and W13
BUSY	Install jumper at W6
EOC	Install jumper at W4

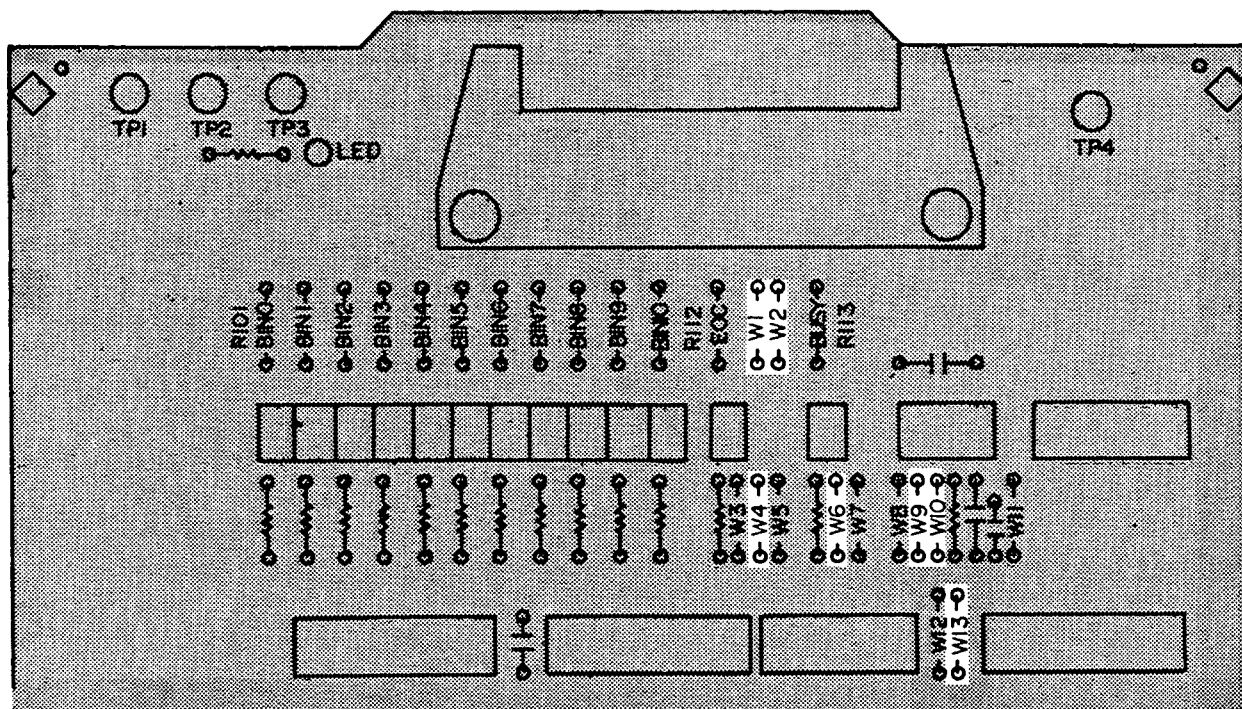
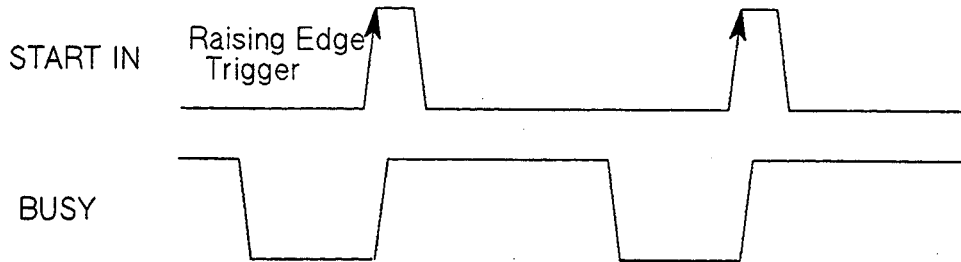

Figure 3-11. RTR2 Jumper and Pull-Up Resistor Locations

3. Bring +5 V out through pins 12 and 17 of the handler interface rear panel connector (install a jumper at W1 for +5 V and at W2 for the COMMON connection). Refer to Figure 3-11 for the locations of W1 and W2.
4. Install the configured handler interface board into the HP 4284A.
5. Replace the top shield plate, rear feet, and top cover.

Isumeca 83

The Isumeca 83 timing diagram is shown in Figure 3-12 for reference.



**Figure 3-12. Isumeca 83 I/O Timing
(Used with The Comparator Function)**

Isumeca 83 Configuration Procedure:

1. Perform steps 1 through 6 of the **General Configuration Procedure** on page 3-3.
2. Configure the following interface signals by installing the jumpers as shown in Figure 3-13.

START IN Install jumper at W9, W10, W11, and W13
BUSY Install jumper at W6
EOC Install jumper at W4

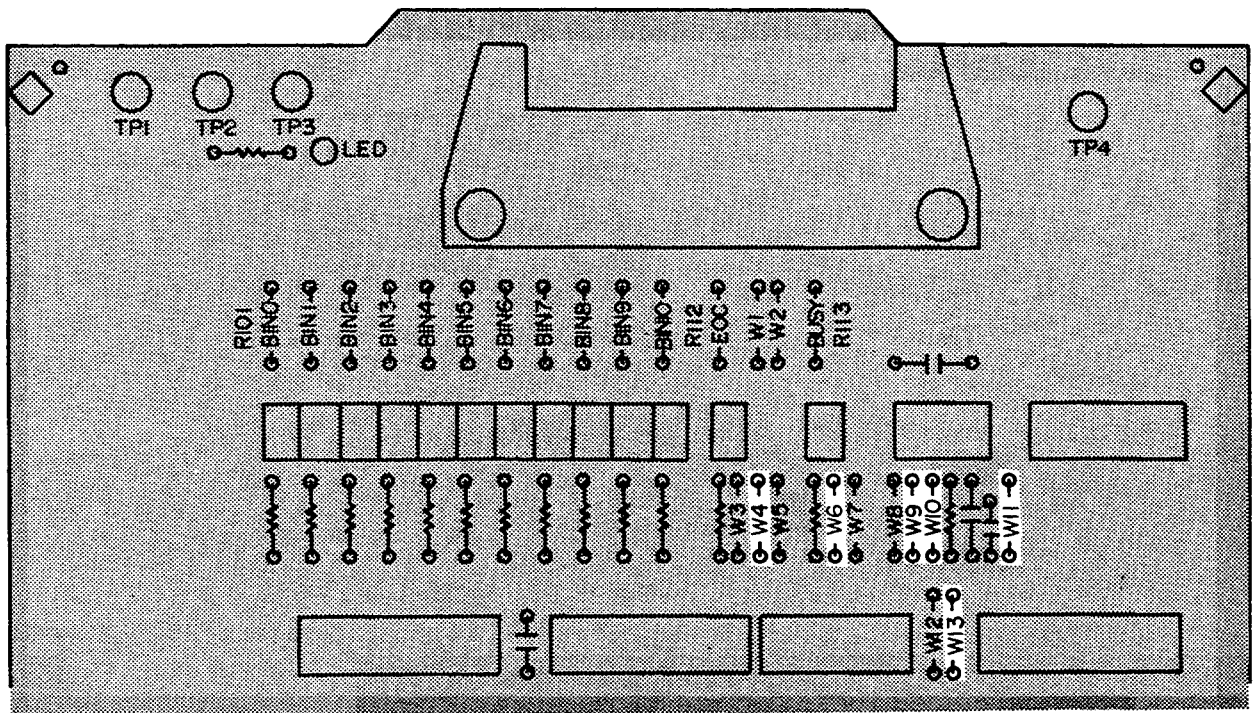

Figure 3-13. Isumeca 83 Jumper and Pull-Up Resistor Locations

3. Install the configured handler interface board into the HP 4284A.
4. Replace the top shield plate, rear feet, and top cover.

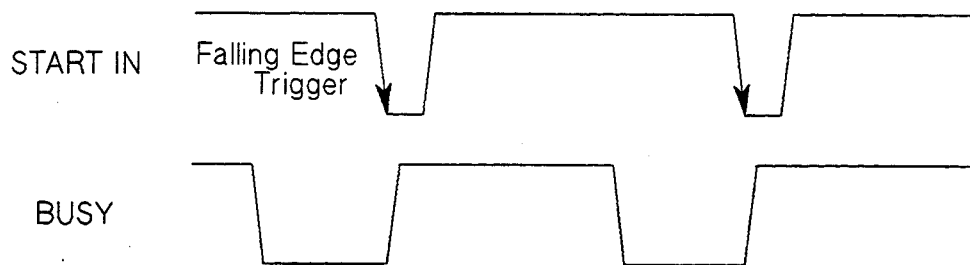

Figure 3-14. EA M015 I/O Timing
(Used with The Comparator Function)

EA Model M015 Configuration Procedure:

1. Perform steps 1 through 6 of the **General Configuration Procedure** on page 3-3.
2. Configure the following interface signals by installing the jumpers as shown in Figure 3-15.

START IN Install jumper at W9, W10, and W12
BUSY Install jumper at W6
EOC Install jumper at W4

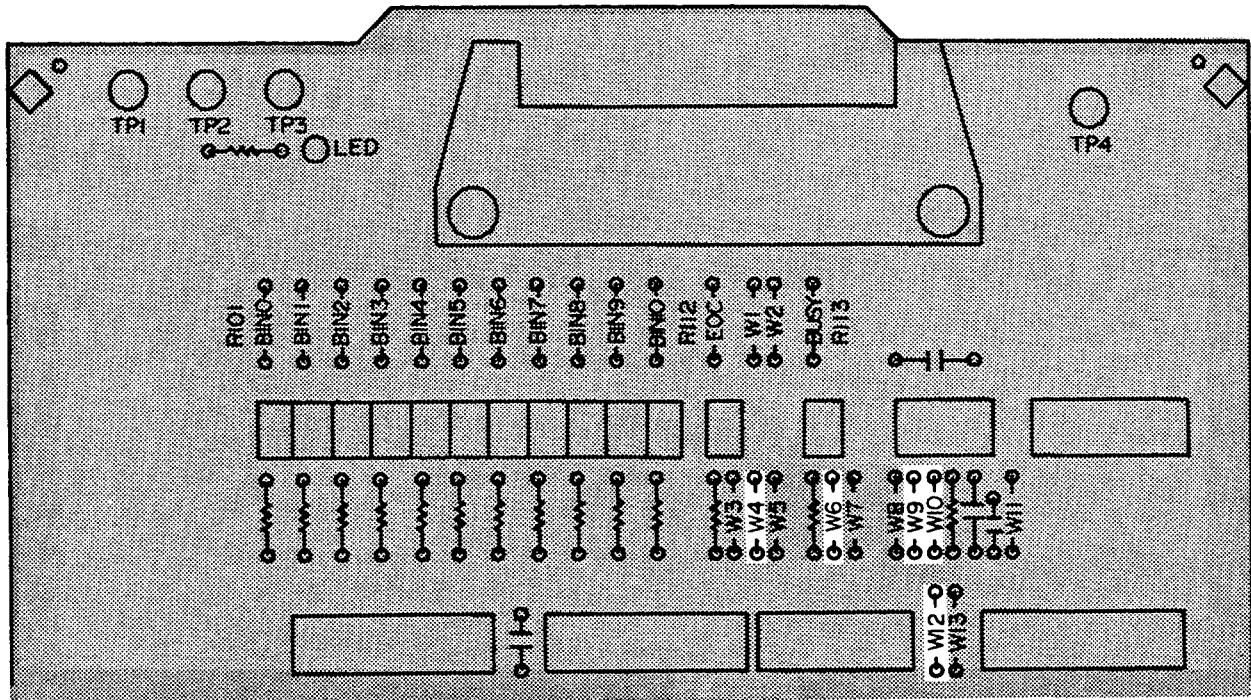

Figure 3-15. EA M015 Jumper and Pull-Up Resistor Locations

3. Install the configured handler interface board into the HP 4284A.
4. Replace the top shield plate, rear feet, and top cover.

NOTE

The Operation Note for Option 301 Scanner Interface, starting from the next page, was written for use with the 4284A. This Operation Note is also applicable to the 4285A by making the following changes.

Scanner Channel Number 128 \Rightarrow 90

Spot Correction Points 3 \Rightarrow 7

4284A PRECISION LCR METER
OPERATION NOTE
Option 301 Scanner Interface

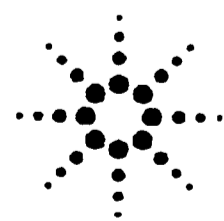

Agilent Technologies

Printed in JAPAN

TABLE OF CONTENTS

SECTION 1:

GENERAL INFORMATION

INTRODUCTION	1-1
DESCRIPTION	1-1
SPECIFICATIONS	1-2

SECTION 2:

INTERFACE SIGNAL DEFINITION

INTRODUCTION	2-1
SCANNER INTERFACE SIGNAL INPUT/OUTPUT CONNECTOR	2-1
Channel Selection Input Signals	2-1
Control Output Signals	2-1
Control Input Signals	2-2
ELECTRICAL CHARACTERISTICS	2-8
Channel Selection Input Signals (Optocoupled)	2-8
External Trigger Input Signals (Optocoupled)	2-8
Control Output Signals (Optocoupled)	2-10
SETTING UP THE SCANNER INTERFACE BOARD	2-11

SECTION 3:

OPERATION

INTRODUCTION	3-1
BASIC PROCEDURE	3-1
ACTIVATING SCANNER INTERFACE	3-3
CORRECTION MODE	3-4
TEST FREQUENCY AND REFERENCE VALUE ENTRY	3-5
CORRECTION DATA SELECTION	3-6
Channel Selection Using Interface Connector	3-6
Channel Selection Using HP-IB	3-7
Monitoring Current Channel	3-7
CORRECTION DATA MEASUREMENTS	3-8
ACTIVATING THE CORRECTION FUNCTION	3-9
CORRECTION DATA CONFIRMATION	3-10

GENERAL INFORMATION

INTRODUCTION

This operation note provides the information necessary to use the HP 4284A Precision LCR Meter Option 301 Scanner Interface. Refer to the HP 4284A Operation Manual for specific HP 4284A operating procedures.

DESCRIPTION

When the HP 4284A is used with the Option 301 Scanner Interface, up to 128 sets of correction measurement data (OPEN, SHORT and LOAD) for up to 3 user defined frequencies can be stored and used. These 128 sets of correction data can be used for each measurement using the multi correction function (modeled in Figure 1-1). The HP 4284A can correct for stray admittance, residual impedance, and other errors for each channel from the calibration plane (depends on the CABLE LENGTH selected) to the connection contacts at the device.

Option 301 uses an Amphenol 14-pin connector to interface between the HP 4284A and the scanner. Therefore an Option 301 HP 4284A can accurately measure impedance values without any degradation of repeatability, or differences between channels. Timing synchronization is also provided.

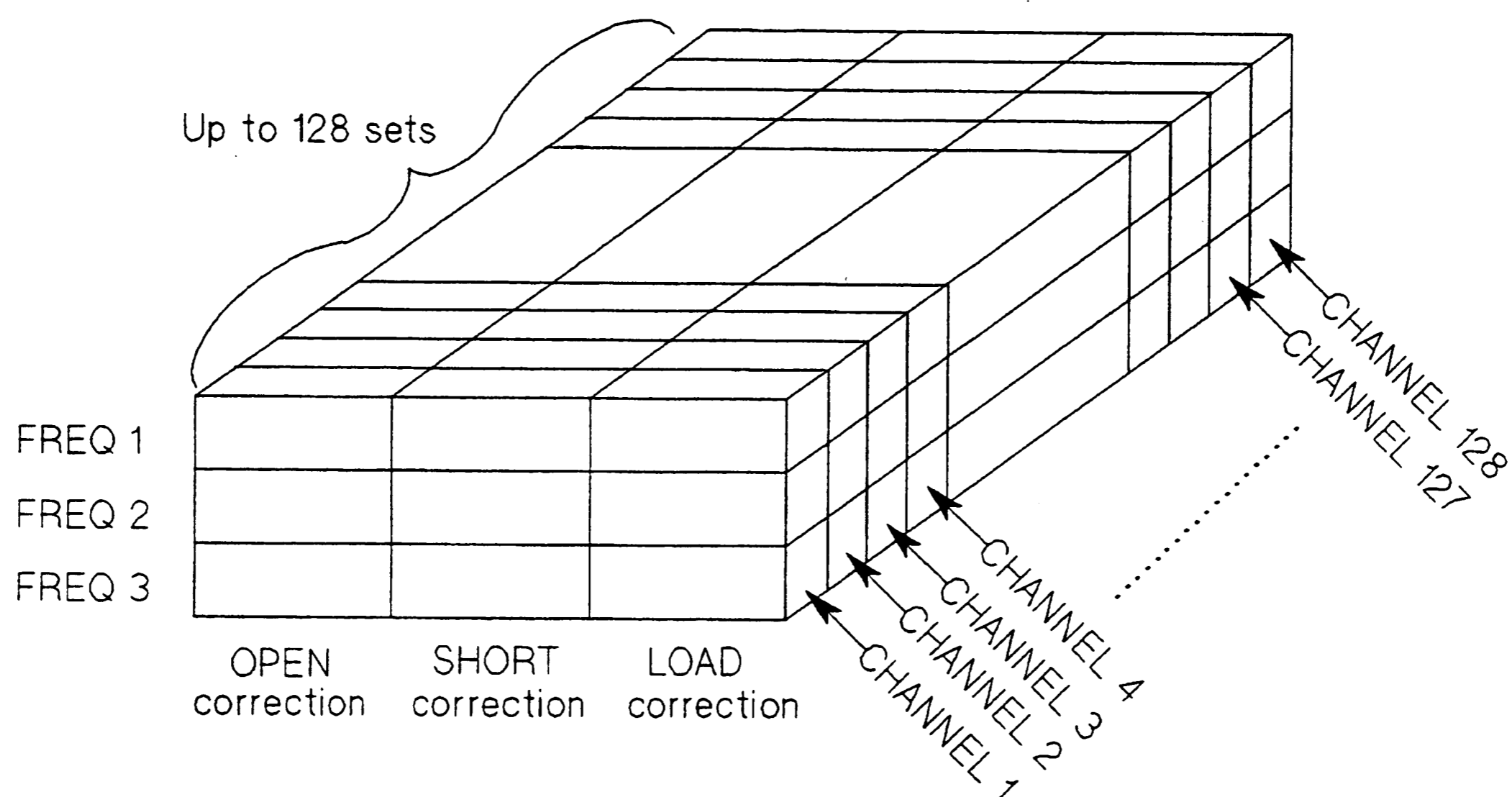

Figure 1-1. Multi Correction Data Memory Model

SPECIFICATIONS

Table 1-1 and 1-2 list the HP 4284A Option 301 specifications and supplemental performance characteristics. Other specifications are the same as those for a standard HP 4284A.

Table 1-1. Specifications

Interface Connector: Amphenol 14-pin connector

Maximum Number of Channels: 128

Output signal:

/INDEX: Analog measurement complete (1 bit).

/EOM: Full measurement complete (1 bit).

Input Signal:

/CH0 to /CH7: 8-bit parallel input signals for selecting the channel.

/CH_VALID: Signal valid or invalid for /CH0 to /CH7

EXT_TRIG: External trigger signal (1 bit).

Multi-Channel Correction:

The multi channel correction function can store OPEN, SHORT, LOAD correction data for each channel independently and correct each channel. The correction data at 3 test frequencies can be taken and stored in non-volatile memory.

Table 1-2. Supplemental Performance Characteristics

Electrical Characteristics:

(1) Input Signal Characteristics: Opto-isolated, negative true

Signal Name	Input Voltage Rate High Low	External Pull-up Voltage	Input Current
CH0 to CH7 /CH_VALID	Pull-up Voltage ≤ 1 V	5 to 15 V	5 to 20 mA
EXT_TRIG	Pull-up Voltage ≤ 1 V	5 to 15 V	6.3 to 15 mA

(2) Output Signal Characteristics: Opto-isolated, negative true

Signal Name	External Pull-Up Voltage	Maximum Current
/INDEX, /EOM	Max. 15 V	6 mA

Measurement Time:

Correction Data Switching Time:

Measurement frequency is equal to FREQ 1 ¹ :	approx. 3.6 ms
Measurement frequency is equal to FREQ 2 ¹ :	approx. 4.0 ms
Measurement frequency is equal to FREQ 3 ¹ :	approx. 4.8 ms
Measurement frequency is not equal to FREQ 1/2/3 ¹ (correction not performed):	approx. 3.0 ms

When multi-channel correction is performed, correction data switching times are added to the measurement time.

¹: Correction frequency

NOTES

INTERFACE SIGNAL DEFINITION

INTRODUCTION

This section provides information necessary to use the Option 301 Scanner Interface, including description of the interface signal lines and their electrical characteristics.

SCANNER INTERFACE SIGNAL INPUT/OUTPUT CONNECTOR

The scanner interface I/O connector, a standard 14-contact female Amphenol connector, is mounted on the HP 4284A's rear panel for interconnection between the HP 4284A and your scanner. The scanner interface I/O signals are divided into three types as follows.

Channel Selection Input Signals

These signals are used to select the correction data which corresponds to the channel number of the scanner.

- /CH0 to /CH7 Channel Selection (8-bit binary input)
- /CH_VALID Channel Valid

Control Output Signals

These signals are used to control the timing between the HP 4284A and the scanner.

- /INDEX Analog measurement complete
- /EOM End of measurement (measurement data valid)

Assertion timing for /INDEX and /EOM is different for normal measurements and sweep measurements.

[Normal Measurement Timing]

/INDEX is asserted when an analog measurement is complete and the HP 4284A is ready for the next DUT to be connected to the **UNKNOWN** terminals. /EOM is asserted when the measurement data and the comparison results are valid. (See Figure 2-2)

[List Sweep Measurement Timing]

- In the SEQ mode:
/INDEX is asserted when the last analog measurement of a sweep measurement is completed, and /EOM is asserted when the measurement results are valid after a sweep measurement is completed.
- In the STEP mode:
/INDEX is asserted when each analog measurement of a sweep measurement is completed, and /EOM is asserted when each step measurement, including comparison time, is completed.

Control Input Signal

This signal triggers the HP 4284A on the rising edge of a pulse when the trigger mode is set to the EXT_TRIG.

- EXT_TRIG External Trigger

NOTE

The / (back slash) in the signal name means that the signal is asserted when low.

The scanner interface I/O connector pin assignments are shown in Figure 2-1, and the contact assignments and a brief description of each are given in Table 2-1.

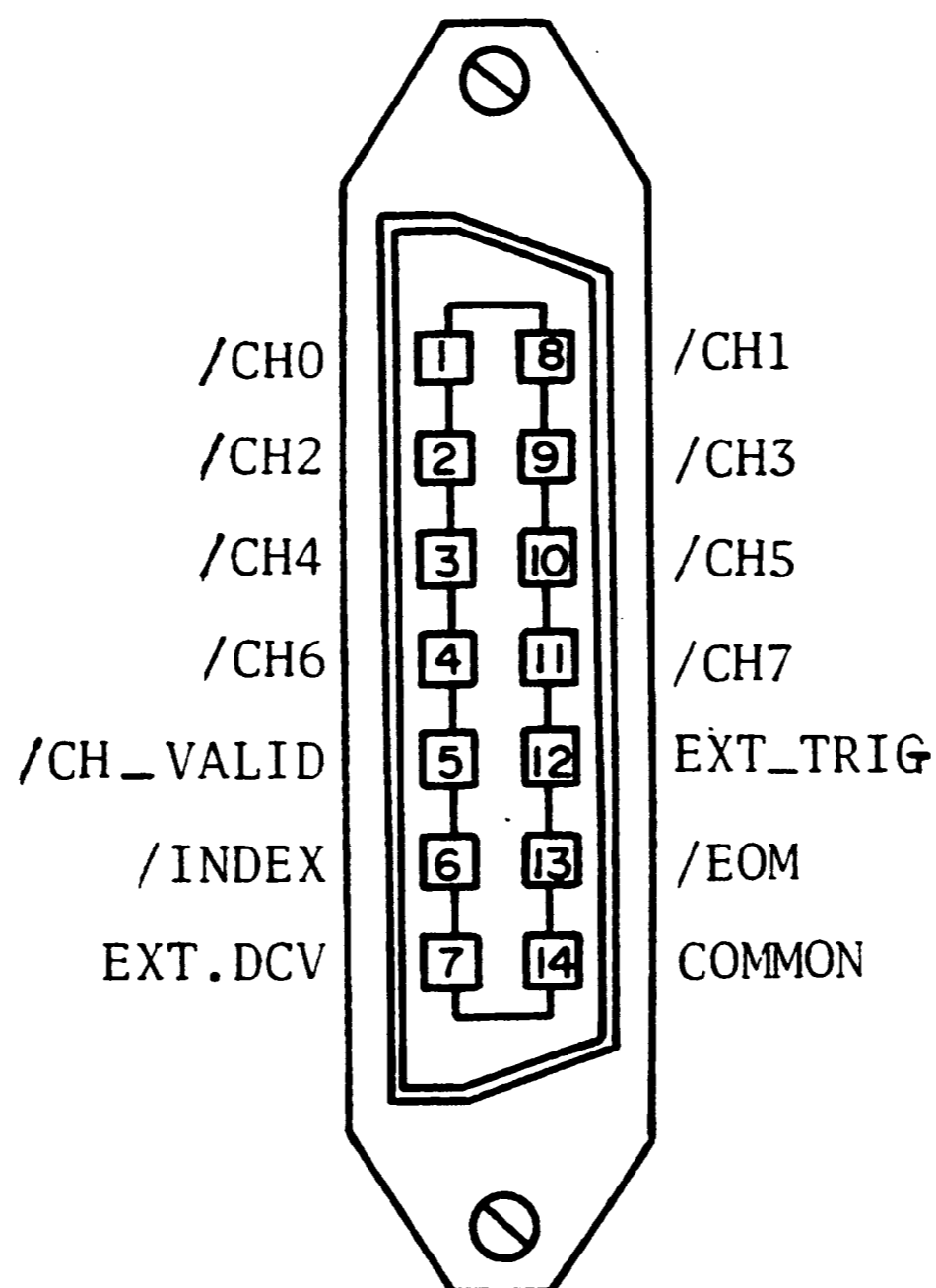

Figure 2-1. Control Assignments

2-2 INTERFACE SIGNAL DEFINITION

Table 2-1. Contact Assignments

Pin No.	Signal Name	Description
1 2 3 4	/CH0 /CH2 /CH4 /CH6	Channel Selection Signals (Input)
5	/CH_VALID	Channel Valid Signal (Input Signal). This signal makes the channel selection signals valid or invalid.
6	/INDEX ¹	Analog Measurement Complete Signal (Output). /INDEX is asserted when a measurement is completed and the HP 4284A is ready for the next DUT to be connected to the UNKNOWN terminals. The measurement data is not valid until /EOM is asserted.
7	EXT.DCV	External DC voltage.
8 9 10 11	/CH1 /CH3 /CH5 /CH7	Channel Selection Signal (Input)
12	EXT.TRIG	External Trigger Signal (Input).
13	/EOM ¹	End of Measurement Signal (Output). This signal is asserted when the measurement is completed and the measurement data and comparison results are valid.
14	COMMON	Common for EXT.DCV.

¹ Assertion timing for these signals is different for normal measurements and list sweep measurements. Refer to Figure 2-3.

The scanner system will operate more efficiently when the input/output control signals are used as follows.

1. Set the scanner channel CHANNEL 0, the first scanner channel.
2. Set the channel selection signals (/CH0 to /CH7) and the channel valid signal (/CH_VALID) to compensate CHANNEL 0.
3. Trigger the HP 4284A with a trigger pulse input through the scanner input/output connector on the rear panel. The HP 4284A will acknowledge the channel number as CHANNEL 0, and then measure the device connected to scanner channel 0 using the correction data for channel 0.
4. Disassert /CH_VALID after disasserting /INDEX.
5. Set the scanner channel, channel selection signals, and the channel valid signal to the next channel to be measured when /INDEX is asserted
6. After /EOM is asserted the HP 4284A is ready to make the next measurement.
7. Repeat steps 4 through 6.

The timing chart for the preceding procedure is shown in Figure 2-2.

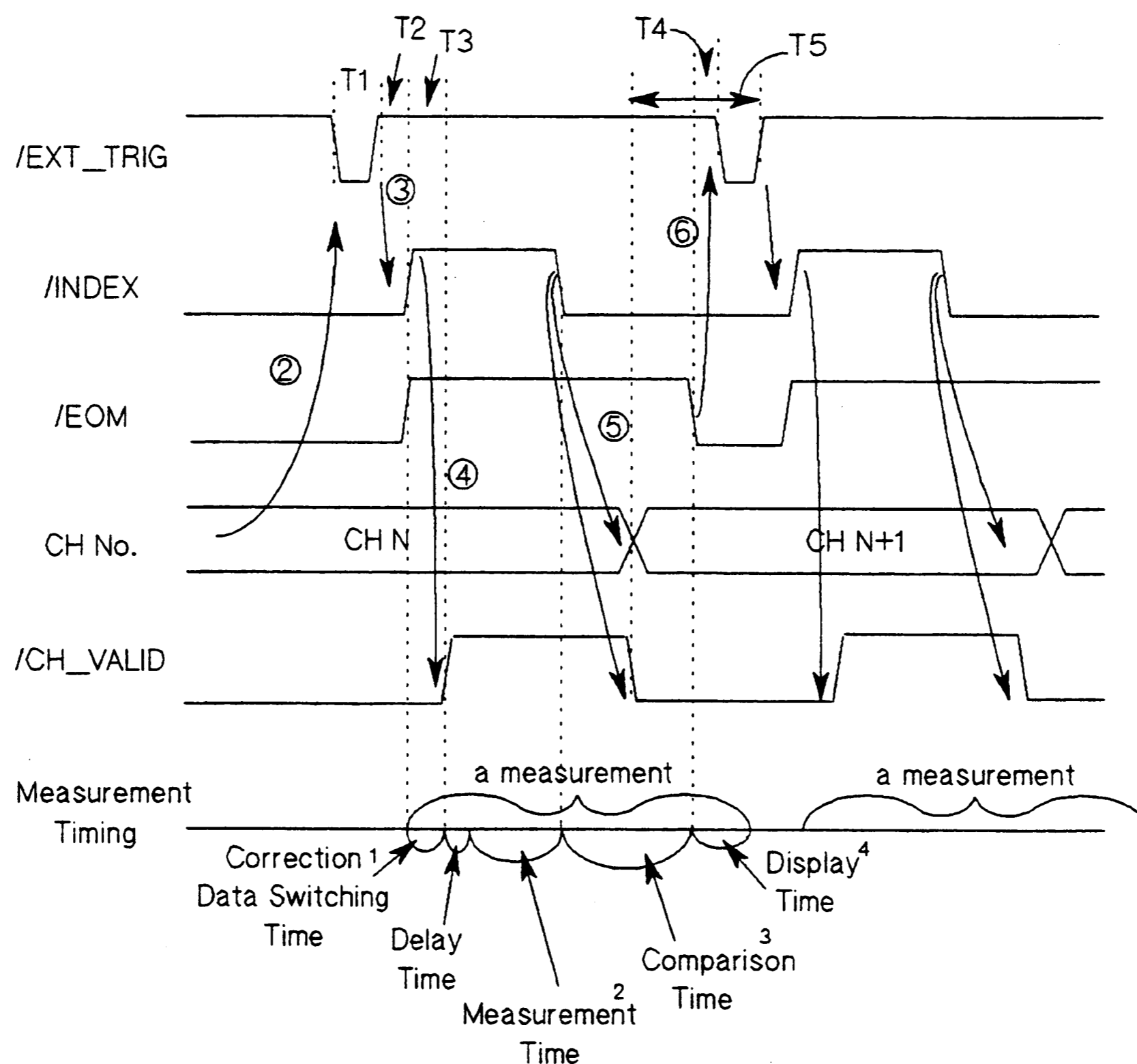

Time	Description	Minimum	Maximum
T1	Trigger Pulse Width	1 μ s	--
T2	Measurement Start Delay Time	200 μ s	Display Time ⁴ + 200 μ s
T3	/CH_VALID Wait Time After Measurement Start	0 ns	--
T4	Wait Time After /EOM Output	0 μ s	--
T5	/CH_VALID Pulse Width	50 μ s	--

¹ Refer to Table 1-2.

² Refer to the HP 4284A Operation Manual.

³ Typical comparison time is approximately 1 ms.

⁴ Typical display time for each display format is as follows.

MEAS DISPLAY page	approx. 8 ms
BIN No.DISPLAY page	approx. 5 ms
BIN COUNT DISPLAY page	approx. 0.5 ms

Figure 2-2. Timing Chart (for Normal Measurements)

SEQ Sweep Mode:

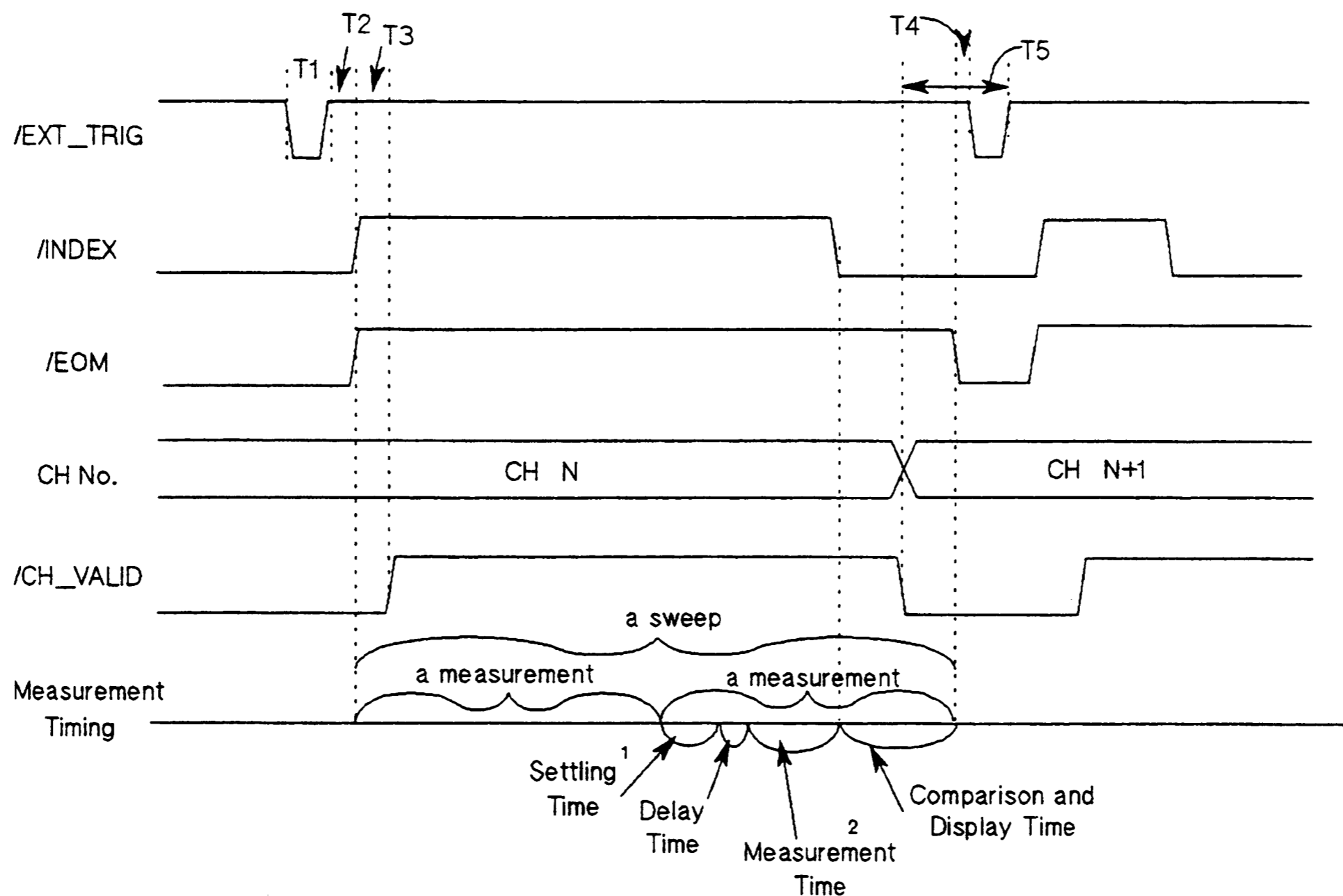

STEP Sweep Mode:

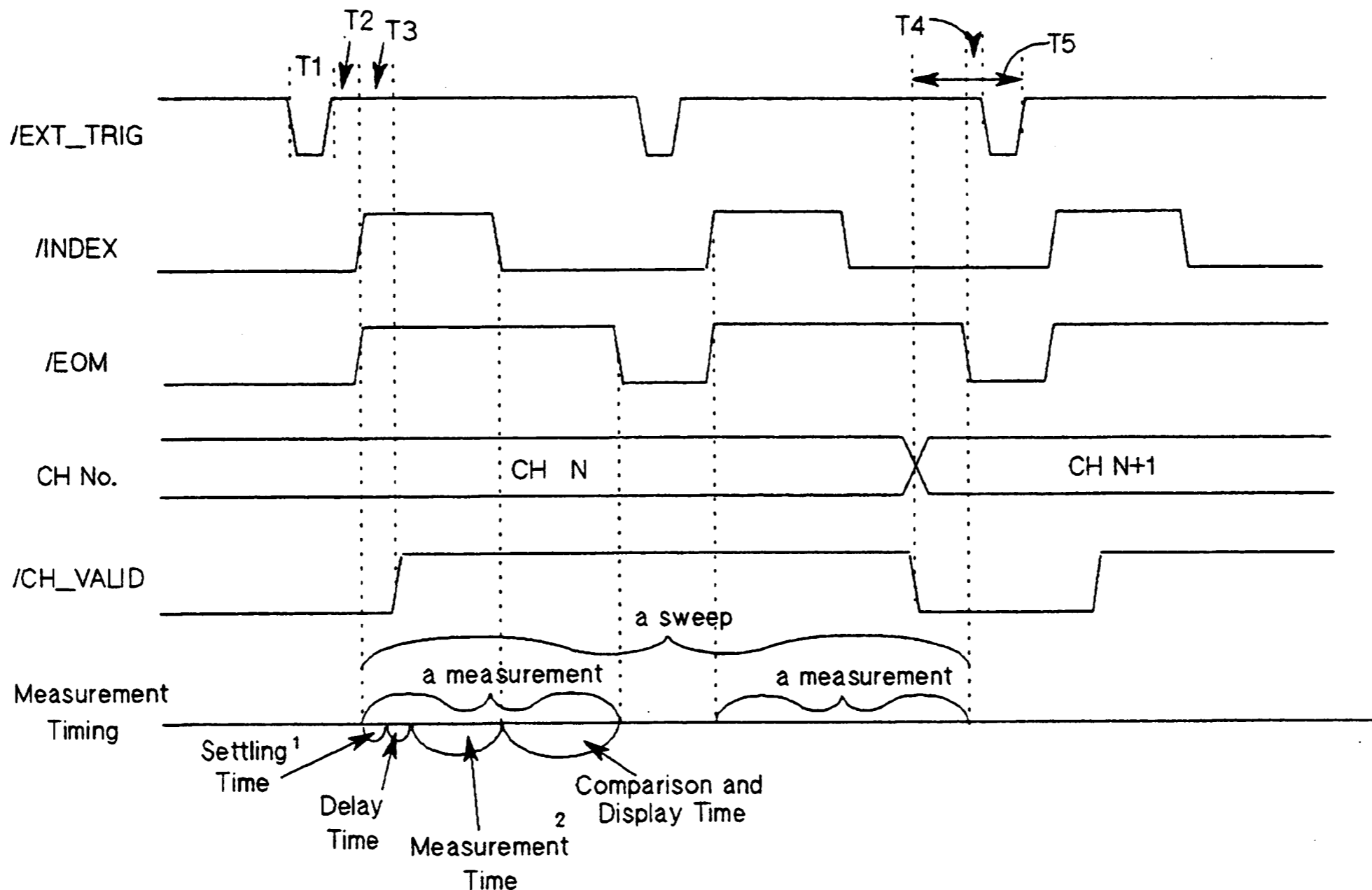

NOTE

Settling Time includes Correction Data Switching Time (refer to Table 1-2). Comparison and Display Time is approx. 4.5 ms. Refer to Figure 2-2 for information on T1, T2, T3, T4 and T5.

Figure 2-3. Timing Diagram (for List Sweep Measurements)

The scanner system setup for the preceding procedure is shown in Figure 2-4.

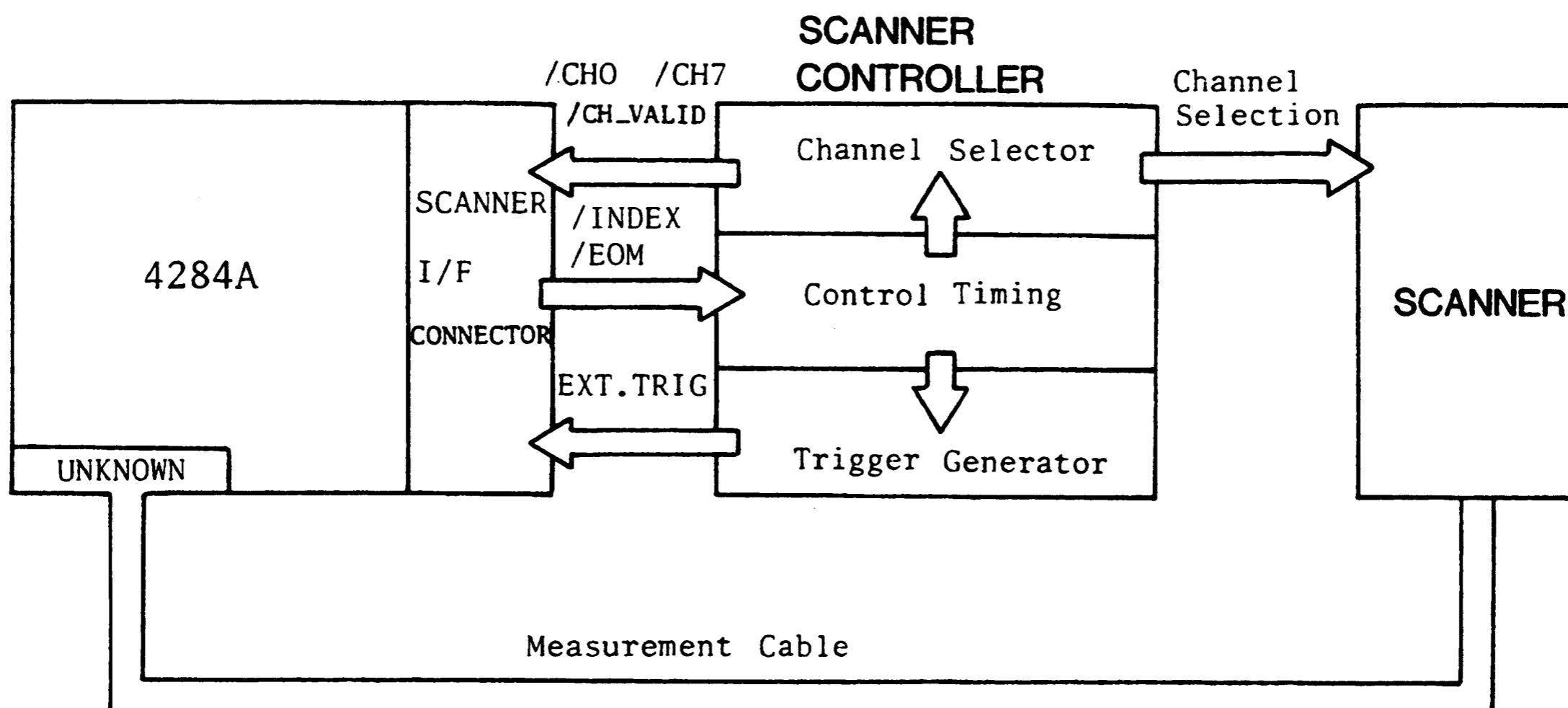

Figure 2-4. Scanner System Example

ELECTRICAL

CHARACTERISTICS The electrical characteristics of the I/O signals are as follows.

Channel Selection

Input Signals

(Optocoupled)

The /CH0 to /CH7 and /CH_VALID signals are optocoupled to isolate inputs at dc. Each signal is connected to the cathode of an LED in the optocoupler which is current driven, requiring 5 mA to 20 mA for proper operation. The OFF state voltage (high level) of each signal depends on the pull-up voltage (EXT.DCV) used. EXT.DCV can be set from 5 V to 15 V. The selector switches must be set according to the value of EXT.DCV used (Refer to Table 2-2).

External Trigger

Input Signals

(Optocoupled)

The EXT_TRIG signal is optocoupled to dc isolate the input. This signal is connected to the cathode of an LED in an optocoupler which is current driven, requiring 6.3 mA to 15 mA for proper operation. The OFF state voltage (high level) of each signal depends on the pull-up voltage (EXT.DCV) used. EXT.DCV can be set from 5 V to 15 V. The bit selector switches must be set according to the value of EXT.DCV used (Refer to Table 2-2).

Table 2-2. Electrical Characteristics

Input Signal	Voltage Input Rating		Maximum Current
	LOW	HIGH	
/CH0 to /CH7 /CH_VALID	≤1 V	5 V to 15 V	5 mA to 20 mA
EXT_TRIG	≤1 V	5 V to 15 V	6.3 mA to 15 mA

A diagram of the input signals is shown in Figure 2-5.

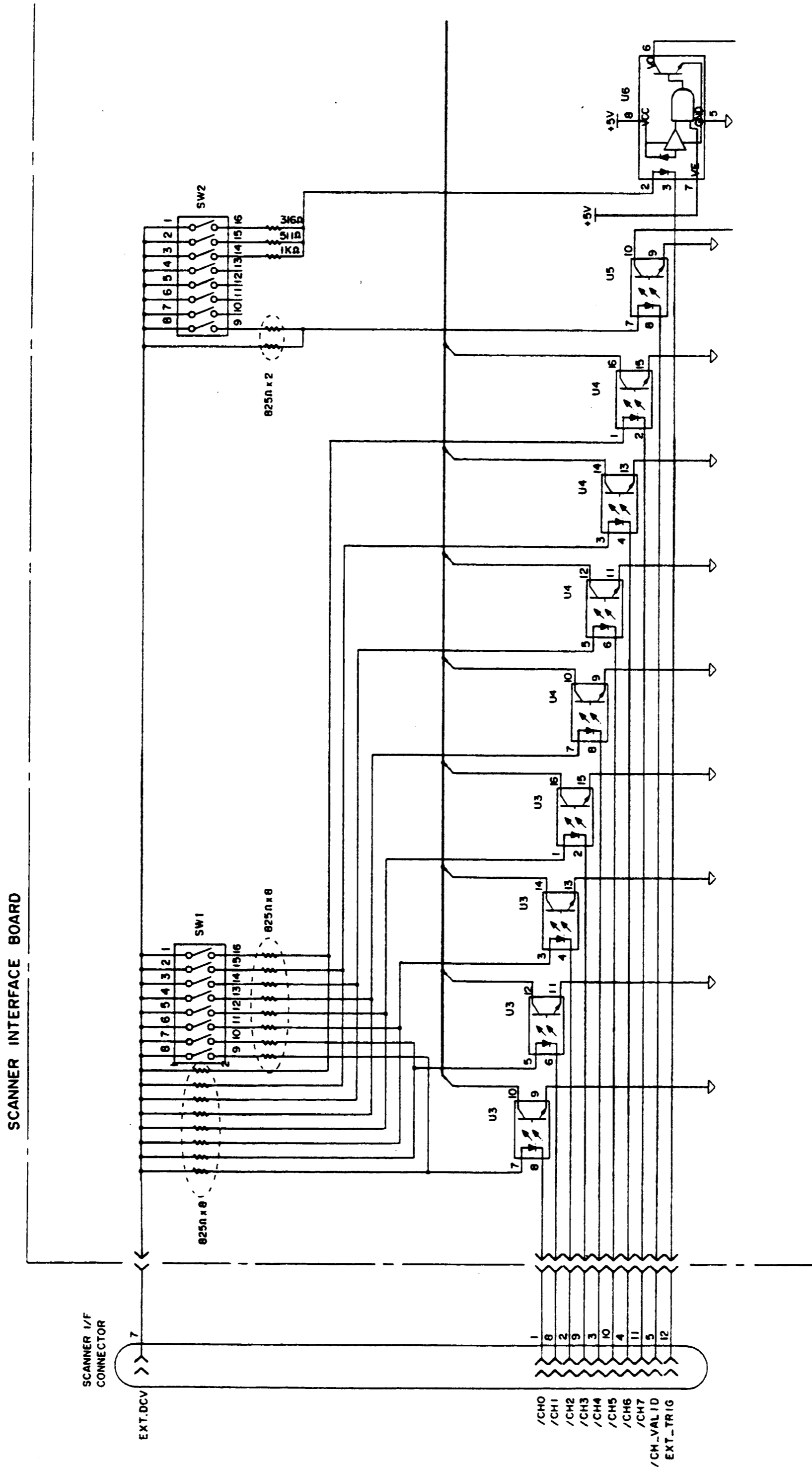

Figure 2-5. Simple Diagram of the Inputs Signals

**Control Output
Signals
(Optocoupled)**

The /INDEX and /EOM signals have optocoupled open collector outputs. The combination of pull-up resistor and pull-up voltage must result in a current through the optocoupler of less than 6 mA (Refer to Table 2-3).

Table 2-3. Output Signal Electrical Characteristics

Signal Name	External Pull-up Voltage	Maximum Current
/INDEX /EOM	15 V max.	6 mA

A schematic of the /INDEX and /EOM output circuits is shown in Figure 2-6.

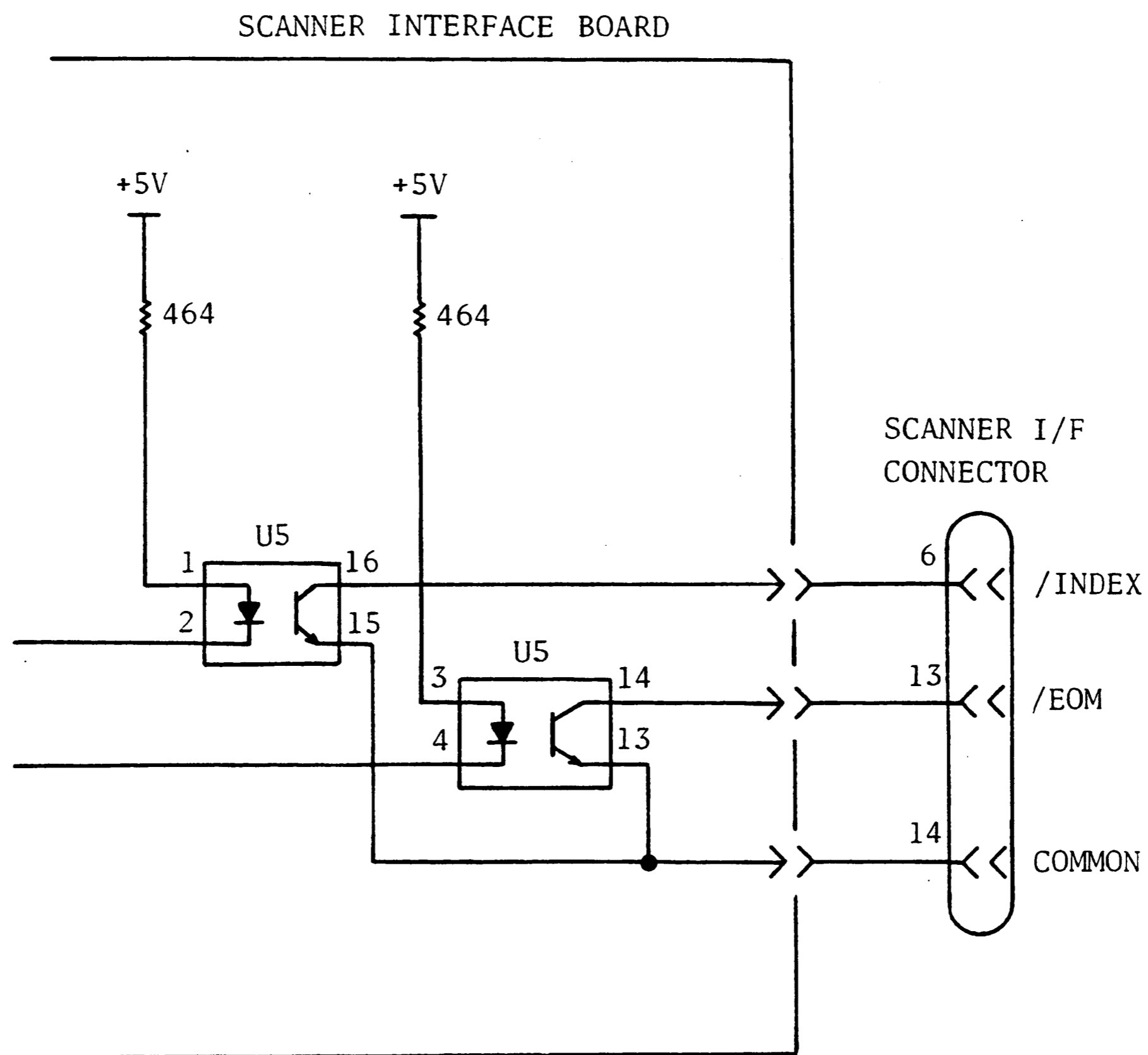

Figure 2-6. Simplified Diagram of the Output Circuits

SETTING UP THE SCANNER INTERFACE BOARD

When you use the rear panel scanner I/O connector, you must set two switches on the scanner interface board according to the external dc voltage (EXT_DCV) used. Perform the following steps.

1. Disconnect the power cable from the HP 4284A and allow enough time (a few minutes) for the internal capacitors to discharge.

WARNING

DANGEROUS ENERGY/VOLTAGE EXISTS WHEN THE HP 4284A IS IN OPERATION AND JUST AFTER IT IS POWERED DOWN. ALLOW A FEW MINUTES FOR THE INTERNAL CAPACITORS TO DISCHARGE.

2. Disconnect the two rear feet which lock the top cover and rear panel together.
3. Fully loosen the top cover retaining screws located on the rear of the top cover.
4. Slide the top cover towards the rear and lift it off. The top shield plate will be visible.
5. Remove the top shield plate to expose the PC boards.
6. Disconnect the flat cable connected to the scanner interface.

NOTE

The scanner interface board is the one with the **BLACK** and **YELLOW** extractors (See Figure 2-7).

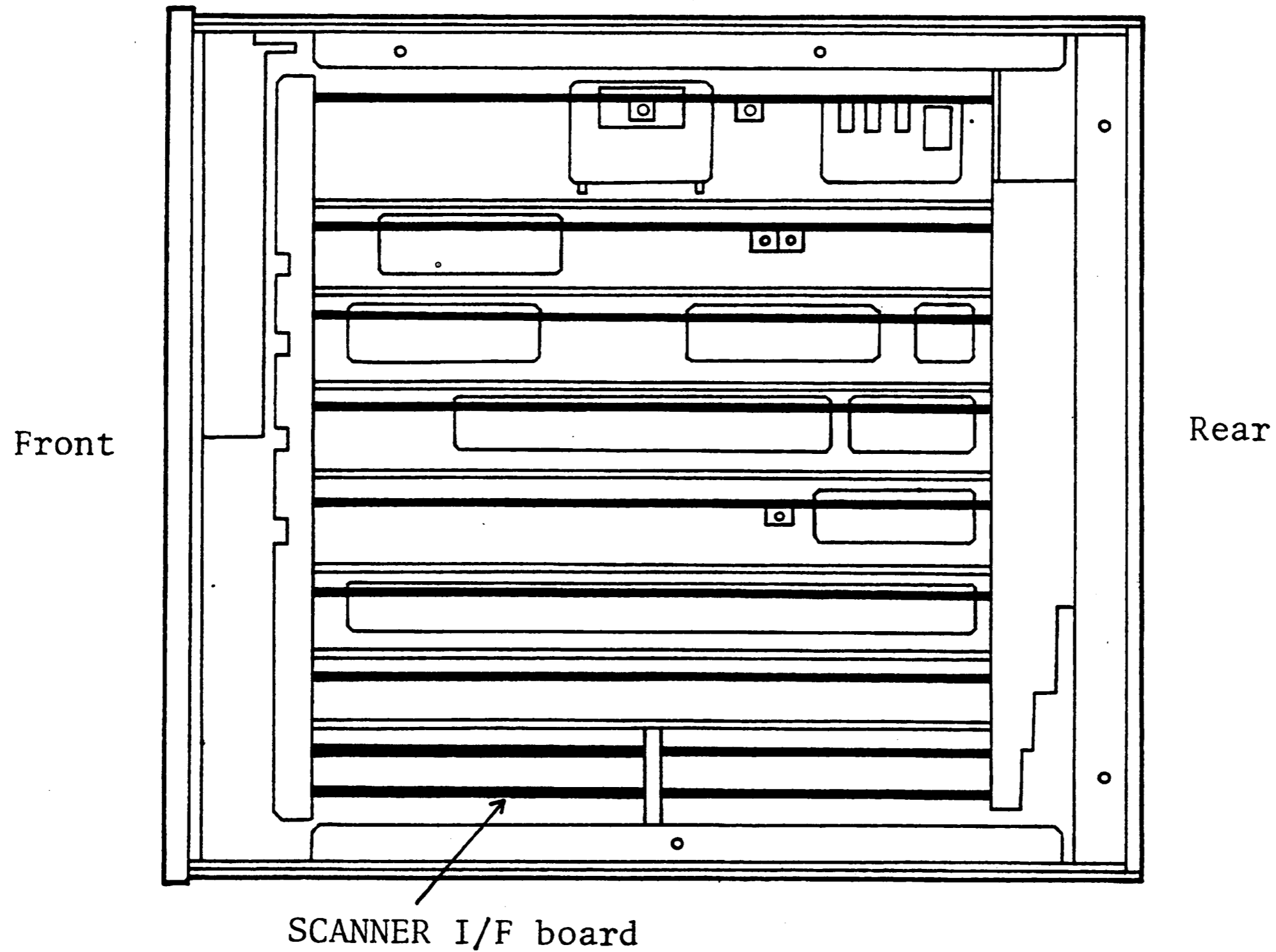

Figure 2-7. Scanner Interface Board Location

7. Remove the scanner interface board.
8. Set switches SW1 and SW2 according to Table 2-4. The location switches SW1 and SW2 are shown in Figure 2-8.
9. Replace the scanner interface board, top shield plate, rear feet, and top cover.

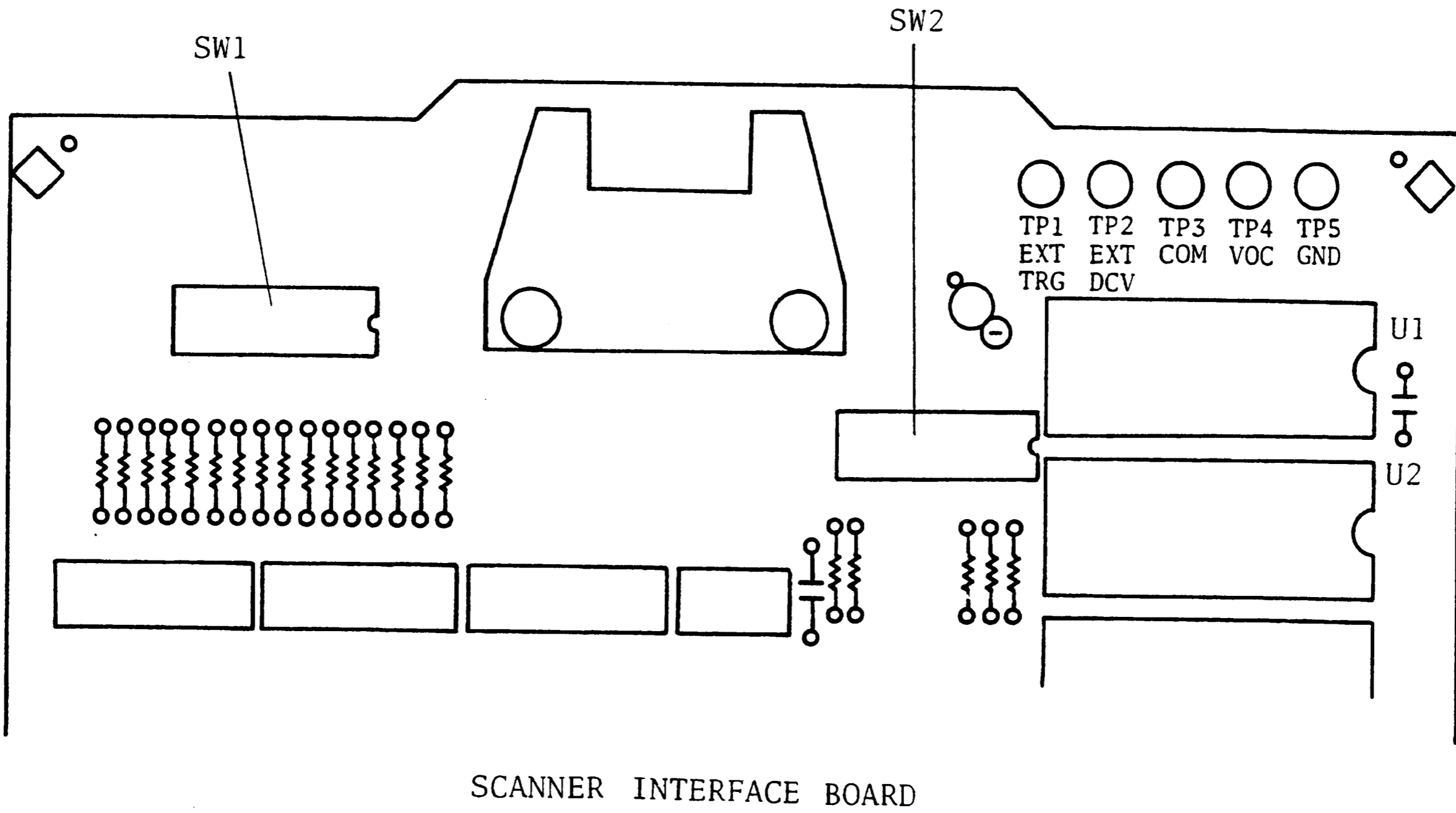
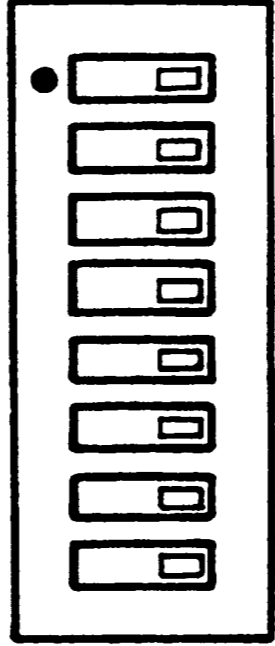
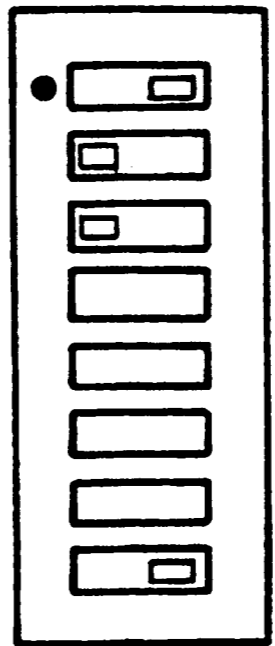
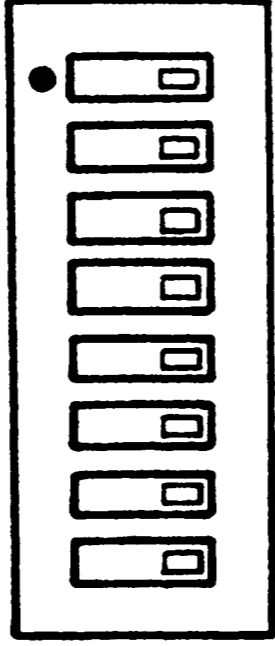
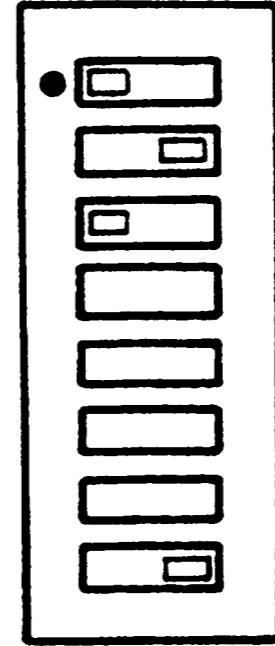
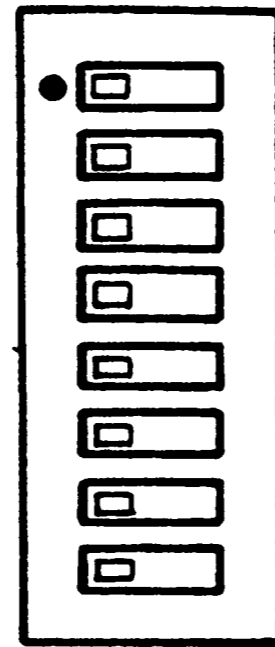
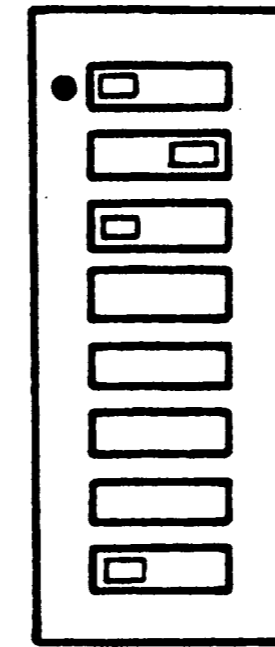
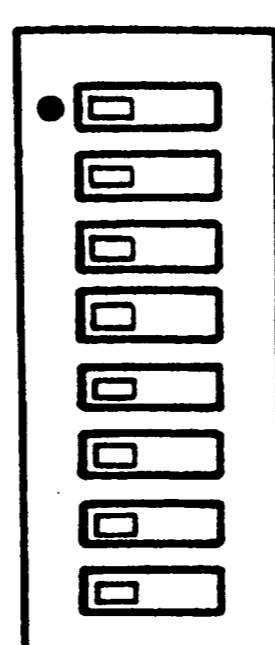
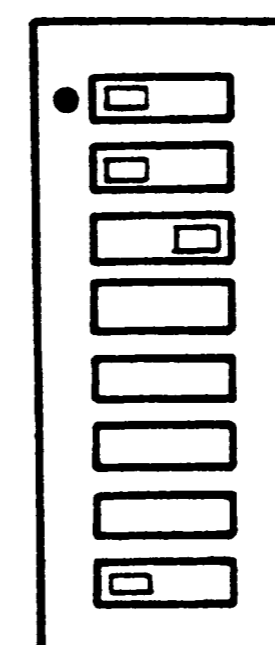

Figure 2-8. SW1 and SW2 Switch Locations

Table 2-4. SW1 and SW2 Settings

EXT_DCV	SW1	SW2
<p>5 to 6 V Factory shipped Setting</p>	 <p>OFF ← → ON</p>	 <p>OFF ← → ON</p>
<p>6 to 8 V</p>	 <p>OFF ← → ON</p>	 <p>OFF ← → ON</p>
<p>8 to 9 V</p>	 <p>OFF ← → ON</p>	 <p>OFF ← → ON</p>
<p>9 to 15 V</p>	 <p>OFF ← → ON</p>	 <p>OFF ← → ON</p>

OPERATION

INTRODUCTION

This section provides information necessary for the HP 4284A to operate using the Option 301 Scanner Interface.

BASIC PROCEDURE

Figure 3-1 shows a sample procedure to use the scanner interface. Follow this flow chart, referring to the following paragraphs describe details.

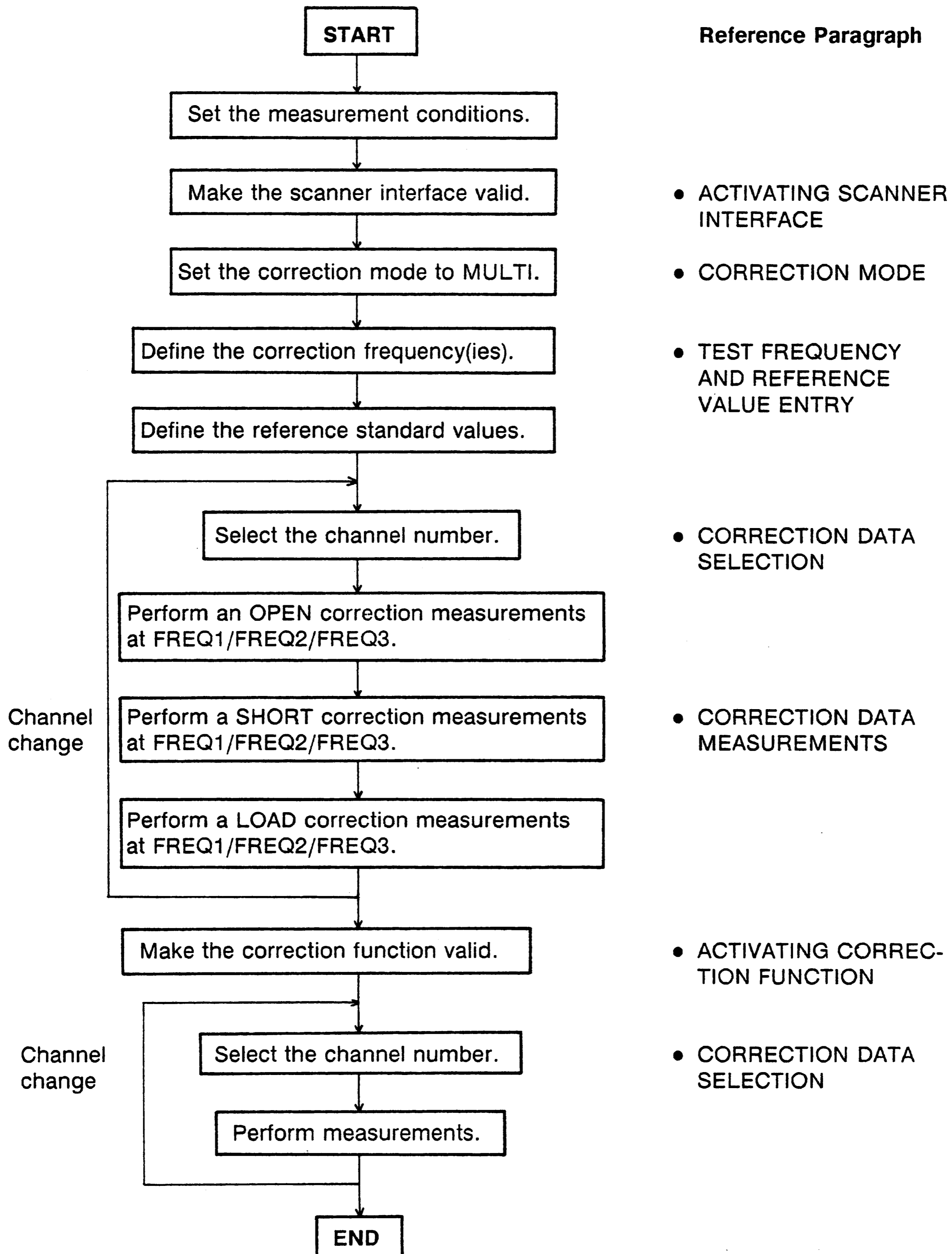

Figure 3-1. Basic Procedure

ACTIVATING SCANNER INTERFACE

Make the scanner interface valid to perform multi channel correction, and to input/output signals through the interface connector on the HP 4284A's rear panel.

NOTE

To use the multi correction function, this procedure must be performed, even if the multi correction function is used without the interface connector on the rear panel, for example in the case of controlling a scanner and the HP 4284A via HP-IB.

1. Press the **CATALOG/SYSTEM MENU** key, and the '**SYSTEM CONFIG**' softkey. The **SYSTEM CONFIG** page is displayed.
2. Use the **CURSOR** arrow keys to move the cursor to the **SCANNER I/F (#301)** field. The following softkeys will be displayed in the softkey label area.
 - '**ON**'
 - '**OFF**'
3. Press the '**ON**' softkey. The scanner interface is now valid to output/input signals.

CORRECTION MODE

To use the multi correction function, set the correction mode to **MULTI** as follows.

NOTE

Before setting the multi correction function, it is necessary to set the scanner interface to ON.

1. Press the **MEAS SETUP MENU** key, and the '**CORRECTION**' softkey. The **CORRECTION** page is displayed.
2. Use the **CURSOR** arrow keys to move the cursor to the **MODE** field. The following softkeys will be displayed on the softkey label area.
 - '**SINGLE**'
 - '**MULTI**'
3. Press the '**MULTI**' softkey to use the multi channel correction function.

TEST FREQUENCY AND REFERENCE VALUE ENTRY

The correction data can be stored at three test frequencies. These test frequencies are defined and monitored on the **CORRECTION** page.

Also on this page, the reference values (**REF A** and **REF B**) of the standards used for LOAD correction are defined at three frequencies. The reference values can be stored with appropriate function (**FUNC**). For example, to use the standard capacitor which has reference parallel capacitance and D values, the reference values should be stored with Cp-D function. Also the function of reference values can be stored on the **CORRECTION** page.

NOTE

The function of the standard on the **CORRECTION** page can be defined independently of the measurement function set on the **MEAS SETUP** page. For example, if the reference values are defined as the Cp-D function (entered with capacitance value and D value), the $Z-\theta$ parameter can be measured with performing the correction.

The following is the setting procedure.

1. Press the **MEAS SETUP MENU** key, and the '**CORRECTION**' softkey. The **CORRECTION** page will be displayed.
2. Move the cursor to the **FUNC** field.
3. Use the softkeys to select the function to be used for entering the reference values.
4. Move the cursor to the **FREQ1** field.
5. If the **FREQ1** is set to OFF, press the '**ON**' softkey to use the **FREQ1** correction data.
6. Enter the frequency value for the **FREQ1** correction.
7. Move the cursor to the **REF A** field under the **FREQ1** field.
8. Enter the reference value of the primary parameter at **FREQ1**.
9. Move the cursor to **B** field on right side of **REF A** field.
10. Enter reference value of the secondary parameter at the **FREQ1**.
11. If necessary, move the cursor to the **FREQ2** field, and repeat steps 4 to 10 at the second correction frequency.

12. If necessary, move the cursor to the **FREQ3** field, and repeat steps 4 to 10 at the third correction frequency.

NOTE

If measurement frequency is not equal to the correction frequency, correction (including OPEN, SHORT and LOAD correction) will not be performed. So in this case, the HP 4284A displays the raw measurement value including additional error due to the test fixture's residuals.

**CORRECTION
DATA
SELECTION**

The correction data for each scanner channel is stored in the internal memory, and each set of correction data is assigned a channel number. To select correction data, the channel number must be set using the /CH0 to /CH7 signals, and the /CH_VALID signal on the rear panel connector, or the **CORREction:USE** command via HP-IB.

**Channel Selection
Using Interface
Connector**

The channel number (correction data selection) can be selected with the channel selection signals (/CH0 to /CH7) and the channel valid signal (/CH_VALID). The /CH0 to /CH7 signals are the 8-bit binary signals. /CH0 is the LSB, and /CH7 is the MSB.

For example,

/CH0	/CH1	/CH2	/CH3	/CH4	/CH5	/CH6	/CH7	CHANNEL No.
1	0	0	0	0	0	0	0	1
0	1	0	0	0	0	0	0	2
0	0	1	0	0	0	0	0	4
0	0	0	1	0	0	0	0	8
0	0	0	0	1	0	0	0	16
0	0	0	0	0	1	0	0	32
0	0	0	0	0	0	1	0	64
1	1	1	1	1	1	1	0	127

1: LOW
0: HIGH

If /CH_VALID is set to HIGH when the channel number is set using the /CH0 to /CH7 signals, the HP 4284A cannot acknowledge the channel number, and the HP 4284A will use the currently specified correction data.

NOTE

In case of the channel number selection using the interface connector: when the HP 4284A is triggered, or when the HP 4284A starts a correction data measurement (for example: when the '**MEAS OPEN**' softkey is pressed), the HP 4284A acknowledges the channel number. So if /CH0 to /CH7 signal and /CH_VALID signal are sent, the HP 4284A will not set the channel number until it is triggered or until it starts a correction data measurement.

**Channel Selection
Using HP-IB**

The channel number used to select the correction data can be set using the **CORREction:USE** command via HP-IB. The syntax of this command is:

CORREction:USE <channel number>

where,

<channel number> : 0 to 127 (integer)

For example, the sample program for the channel number=20 is as follows.

```
10  OUTPUT 717;"CORR:METH MULT" ! Set the multi compen.
    mode
20  OUTPUT 717;"CORR:USE 20" ! Set the CH. No to 20
30  END
```

NOTE

In case of the channel number selection using the **CORREction:USE** command, the HP 4284A acknowledges the channel number when the HP 4284A receives this command. So if the "**CORREction:USE 10**" command is sent via HP-IB, the HP 4284A will set the channel number when the HP 4284A will receive the command.

**Monitoring Current
Channel**

You can monitor current channel number selected for correction on the **CORRECTION** page and the **MEAS DISPLAY** page. '**CH No.:**' on these pages indicates current channel selected for correction.

CORRECTION DATA MEASUREMENTS

It is necessary to perform correction data measurements, OPEN, SHORT and LOAD data measurements at 3 test frequencies, for each channel.

The following is a sample procedure for performing correction measurements for a channel. Repeat the following procedure for each scanner channel to be used.

1. Select the scanner channel.
2. Set the HP 4284A's channel number equal to that selected in step 1.
3. Press the **MEAS SETUP MENU** key, and the '**CORRECTION**' softkey. The **CORRECTION** page will be displayed.

[OPEN Correction]

4. Open the measurement contacts of the selected scanner channel.
5. Move the cursor to the **FREQ1** field, and press the '**MEAS OPEN**' softkey to measure OPEN condition at the FREQ1. Wait for the end of OPEN correction measurement.
6. If necessary, repeat step 5 for the **FREQ2** and **FREQ3** fields.

[SHORT Correction]

7. Short the measurement contacts of the selected scanner channel.
8. Move the cursor to the **FREQ1** field, and press the '**MEAS SHORT**' softkey to measure the SHORT condition at the FREQ1. Wait for the end of SHORT correction measurement.
9. If necessary, repeat step 8 for the **FREQ2** and **FREQ3** fields.

[LOAD Correction]

10. Connect the standard for the FREQ1 correction to the measurement contacts of the selected scanner channel.
11. Move the cursor to the **FREQ1** field, and press the '**MEAS LOAD**' softkey to measure the standard at the FREQ1. Wait for the end of LOAD correction measurement.

12. If necessary, repeat steps 10 and 11 for the **FREQ2** and **FREQ3** corrections.
13. Change the scanner's and the HP 4284A's channel, and repeat steps 4 through 12 until this procedure has been performed for all scanner channels.

ACTIVATING THE CORRECTION FUNCTION

To set the correction function to ON, performing the correction using the correction data, set as follows.

1. Press the **MEAS SETUP MENU** key, and the '**CORRECTION**' softkey. The **CORRECTION** page will be displayed.
2. Confirm the correction frequencies (**FREQ1**, **FREQ2** and **FREQ3**) to be used are set to ON (frequency and reference values are displayed, the "**OFF**" will not be displayed).
3. Move the cursor to the **OPEN** field.
4. Press the '**ON**' softkey to set the **OPEN** correction function to ON.
5. Move the cursor to the **SHORT** field.
6. Press the '**ON**' softkey to set the **SHORT** correction function to ON.
7. Move the cursor to the **LOAD** field.
8. Press the '**ON**' softkey to set the **LOAD** correction function to ON.

CORRECTION DATA CONFIRMATION

To confirm the measurement data for each channel correction, read the data via HP-IB using the following query.

The syntax of which is:

CORREction:USE:DATA? <channel number>

Where,

<channel number> : 0 to 127 (integer)

Query response :

<open1 A>,<open1 B>,<short1 A>,<short1 B>,
<load1 A>,<load1 B>,<open2 A>,<open2 B>,
<short2 A>,<short2 B>,<load2 A>,<load2 B>,
<open3 A>,<open3 B>,<short3 A>,<short3 B>,
<load3 A>,<load3 B><NL^END>

where,

<open1/2/3 A>	:	Primary parameter measurement data of OPEN correction at FREQ 1/2/3.
<open1/2/3 B>	:	Secondary parameter measurement data of OPEN correction at FREQ 1/2/3.
<short1/2/3 A>	:	Primary parameter measurement data of SHORT correction at FREQ 1/2/3.
<short1/2/3 B>	:	Secondary parameter measurement data of SHORT correction at FREQ 1/2/3.
<load1/2/3 A>	:	Primary parameter measurement data of LOAD correction at FREQ 1/2/3.
<load1/2/3 B>	:	Secondary parameter measurement data of LOAD correction at FREQ 1/2/3.
<NL^END>	:	Terminators (the EOI line is asserted while the New Line or ASCII Line Feed character is being sent on the bus).

In addition to the query, the following queries are useful to confirm status of the multi channel correction mode.

- **CORREction:SPOT{1 | 2 | 3}:STATE? query**
::= returns ON/OFF condition of FREQ1, FREQ2 or FREQ3 correction.
- **CORREction:SPOT{1 | 2 | 3}:FREQUency? query**
::= returns the correction frequency of FREQ1, FREQ2 or FREQ3.

- **CORRection:SPOT{1|2|3}:LOAD:STANdard?** query
 ::= returns the reference values of the standard for
 FREQ1, FREQ2 or FREQ3.

Refer to **SECTION 8, COMMAND REFERENCE** of the **HP 4284A OPERATION MANUAL** for details.

The following procedure and sample program are a guide to reading the correction frequency, reference values for LOAD correction, and a channel's correction data via HP-IB.

1. Set the HP 4284A's HP-IB address to 17.
2. Load BASIC and input the following program. (This program can be used with HP 9000 series 200 or 300 computers).

```

10  OPTION BASE 1
20  DIM State(3),Freq(3),Ref_a(3),Ref_b(3),Corr_data(3,6)
30  OUTPUT 717;"CORR:METH MULT"! Set MULTI correction mode
40  !
50  FOR I=1 TO 3
60  OUTPUT 717;"CORR:SPOT"&VAL$(I)&":STAT?;FREQ?"!Status & freq.queries
70  ENTER 717;State(I),Freq(I)
80  OUTPUT 717;"CORR:SPOT"&VAL$(I)&":LOAD:STAN?"!Reference value query
90  ENTER 717;Ref_a(I),Ref_b(I)
100 NEXT I
110 !
120 OUTPUT 717;"CORR:USE:DATA? 10"!Correction measurement data query
130 ENTER 717;Corr_data(*)
140 !
150 FOR I=1 TO 3
160 PRINT "FREQ"&VAL$(I)&"=";Freq(I);"Hz :";State(I)
170 PRINT " REF  :",Ref_a(I),";";Ref_b(I)
180 PRINT " MEAS DATA"
190 PRINT " OPEN  A: ",Corr_data(I,1),"B: ";Corr_data(I,2)
200 PRINT " SHORT A: ",Corr_data(I,3),"B: ";Corr_data(I,4)
210 PRINT " LOAD  A: ",Corr_data(I,5),"B: ";Corr_data(I,6)
220 PRINT
230 NEXT I
240 END

```

NOTE

In this example channel 10 is selected.

3. RUN the program. The correction data for channel 10 will be displayed on the computer as follows.

```
FREQ1= 1000 Hz : 1
REF : 1909.4 ; -1.59117E+6
MEAS DATA
OPEN A: .0993735 B: -9.36068E-5
SHORT A: .012764 B: .00328798
LOAD A: 2611.29 B: -368124
```

```
FREQ2= 2000 Hz : 1
REF : 1989.23 ; -795690
MEAS DATA
OPEN A: .0993439 B: -9.16435E-5
SHORT A: .0750794 B: .00345303
LOAD A: 6663.75 B: -864755
```

```
FREQ3= 5000 Hz : 1
REF : 19.7139 ; -70407
MEAS DATA
OPEN A: .0993221 B: -.000113075
SHORT A: .0244617 B: .00475126
LOAD A: 617.902 B: -73157.1
```

NOTE

On the HP 4284A's LCD you can monitor the correction data only for the LOAD correction (**MEA A/B** of the **FREQ1/2/3**) of the indicated channel (**CH No.**) on the **CORRECTION** page.

Index

- Special characters**
- *, 5-9
 - , 5-19
 - , 3-8
 - :, 9-2
- 4**
- 42841A Bias Current Source, 5-10
 - 42842C Bias Current Test Fixture, 5-10
- A**
- ABORT I/O (IFC), 8-4
 - ABORt Subsystem, 9-51
 - Absolute Tolerance Mode, 5-48
 - Accessories Available, 1-20
 - Accessory Control I/F Test, 6-23
 - Accuracy Calculation, 1-10
 - Example, 1-15
 - ADC ERR, 3-8
 - Admittance, 7-3
 - ALC, 7-7
 - Operating Time, 5-16
 - Operation Range, 5-17
 - Resolution, 5-16
 - Setting Range, 5-16
 - Theory of Operation, 5-16
 - ALC Field, 5-16
 - ALC Function, 9-16
 - Altitude, 1-21
 - AMPLitude Subsystem, 9-16
 - APERture Subsystem, 9-41
 - Arbitrary Sweep. *See* List Sweep
 - ASCII Format, 8-7
 - (Data Buffer Memory), 8-17
 - Examples, 8-36
 - Assistance, ix
 - * (Asterisk on *LEVEL* field), 5-9
 - Auto Load function, 4-5
 - AUX Field, 5-55
 - AUXiliary Bin, 5-55
 - Averaging Function, 5-20
 - Averaging Rate, 9-41
 - AVG Field, 5-20

- B**
 - B, 7-3
 - B Accuracy, 1-9
 - Basic Measurement Procedure, 7-1
 - Basic Operation, 3-16
 - Basic Rules of TMSL, 9-3
 - BEEPER* Field, 6-9
 - Beeping Condition, 6-9
 - B* Field
 - (Deviation), 5-21
 - (Deviation Reference), 5-22
 - (LOAD), 5-35
 - BIAS* Field, 5-10
 - BIAS Subsystem, 9-20
 - BINARY Format, 8-9
 - (Data Buffer Memory), 8-18
 - Examples, 8-38
 - BIN COUNT DISPLAY* Page, 3-11, **4-15**
 - Bin Counter, 4-16
 - BIN No. DISPLAY* Page, 3-11, **4-10**
 - BIN Sorting, 5-44
 - BUS Trigger mode, 5-15

- C**
 - C, 7-3
 - Cable Correction
 - Condition, 6-14
 - CABLE CORRECTION MENU* Field, 6-14
 - CABLE CORRECTION* Page, 3-12, **6-14**
 - Cable Extension, 7-14
 - CABLE* Field, 5-41
 - Cable Length Correction , 9-56
 - Cable Termination, 7-12
 - C Accuracy, 1-9
 - Capacitance, 7-3
 - Capacitance to Ground, 7-9
 - CATALOG* Page, 3-12, **6-1**
 - CATALOG/SYSTEM Menu, 6-1
 - Certification, viii
 - Character Data, 9-5
 - Characteristics Example, 7-22
 - Characters not Recognized by the Printer, 4-7
 - cleaning , 2-7
 - CLEAR LOCKOUT, 8-4
 - Clear Status Command, 9-97
 - *CLS Command, 9-97
 - Command
 - Abbreviations, 9-4
 - ABORt Subsystem, 9-51
 - AMPLitude Subsystem, 9-16
 - APERture Subsystem, 9-41
 - BIAS Subsystem, 9-20
 - *CLS, 9-97
 - COMParator Subsystem, 9-75
 - CORRection Subsystem, 9-56
 - CURRent Subsystem, 9-15

DISPlay Subsystem, 9-10
 Error , B-1
 *ESE, 9-98
 FETCh? Subsystem, 9-47
 FORMat Subsystem, 9-52
 FREQuency Subsystem, 9-13
 FUNCTion Subsystem, 9-24
 Header, 9-5
 INITiate Subsystem, 9-45
 LIST Subsystem, 9-33
 Mass MEMory Subsystem, 9-88
 MEMory Subsystem, 9-52
 *OPC, 9-103
 OUTPut Subsystem, 9-17
 Reference, 9-1, 9-9
 *RST, 9-105
 *SRE, 9-100
 STATus Subsystem, 9-92
 Structure, 9-2
 SYSTem:ERRor? Query, 9-91
 *TRG, 9-107
 TRIGger Subsystem, 9-42
 VOLTage Subsystem, 9-14
 *WAI, 9-104
 Command Error (CME) Bit, 8-29
Comment Field, 3-7, **5-13**
 Comment Input, 9-12
COMMENT Monitor Area, 6-3
 Common Commands, 8-6, **9-96**
 Comparator, 1-18, 5-51
 COMPArator Subsystem, 9-75
COMP Field, 4-12, 5-51
 Components not Covered by Warranty, 1-1
 Conductance, 7-3
CONFIG Field, 6-10
 Contact Resistance, 7-11
 Contacts, 7-9
 CONTRAST Control Knob, 3-3
 Control Setting Examples, 8-31
 Correction Data Measurement Complete Bit, 8-25, 9-93, 9-95
 Correction Functions, 1-17, 5-26, 7-16
 Correction Mode, 5-40
CORRECTION Page, 3-11, **5-26**
 CORRection Subsystem, 9-56
 COUNT Function On/Off, 4-16
 CURRent Subsystem, 9-15
 CURSOR, 3-16
 CURSOR Keys, 3-3

D D Accuracy, 1-9
 Data Buffer, 9-52
 Memory, 8-16
 Data Output Format, 9-52
 Data Transfer, 8-7
 Examples, 8-36
 Rate, 8-19
 DC Bias, 5-10, 9-20
 Monitor Accuracy, 1-18
 Monitor Accuracy (Option 001), 5-19
 Monitor Function, 9-17
 Monitor Mode, 5-19
 Resolution, 5-10
 Setting Range, 5-10
 Settling Time, 1-23
DC BIAS Key, **3-3**, 5-11
 DCL (Device Clear), 8-4
 D (Dissipation Factor), 7-3
 Default Address, 6-9
 Definitions, 9-1
DELAY Field, 5-20
 DELETE. *See* PURGE
DEV A Field, 5-21
 (*DEV*) *B* Field, 5-21
 Deviation
 DEV A Field, 5-21
 (*DEV*) *B* Field, 5-21
 Measurement, 5-21
 REF A Field, 5-22
 (*REF*) *B* Field, 5-22
 Reference, 5-22
 DEVICE CLEAR (SDC or DCL), 8-4
 Device Dependent Messages, 8-6
 Device-Specific Error , B-1
 Device Specific Error (DDE) Bit, 8-29
 Dimensions, 1-21
 Display Area Definition, 3-7
DISPLAY FORMAT Menu, 4-1
 Display Page, 3-8
 Display Page Format Field, 3-7
 Display Range, 5-5
 DISPlay Subsystem, 9-10
 Documentation Map, vi
 DUT Characteristics, 7-22

- E**
 - Effective Measurement Range, 1-7, 5-5
 - Electromagnetic Compatibility, **2-6**
 - ENTRY Keys, 3-3
 - Equivalent Circuit Mode, 7-4
 - Error
 - Handling, B-1
 - Messages, B-1
 - *ESE Command, 9-98
 - *ESR? Query, 9-99
 - Exclusive Remedies, ix
 - Execution Error, B-1
 - Execution Error (EXE) Bit, 8-29
 - External Memory Card, 9-88
 - External Trigger Pulse Specification, 5-15
 - EXT TRIGGER Connector, 3-5

- F**
 - FETCh? Subsystem, 9-47
 - Fixed Decimal Point Display, 4-6
 - FORMat Subsystem, 9-52
 - Four-Terminal Pair Configuration, 7-8
 - FRAME Terminal, 3-4
 - FREQ1-7* Fields, 5-34
 - FREQ* Field, 5-7
 - FREQuency Subsystem, 9-13
 - Front Panel, 3-2
 - FUNC* Field
 - (Limit Table), 5-46
 - (LOAD Correction), 5-38
 - (Measurement), 5-4
 - Function
 - (Limit Table), 5-46
 - (LOAD Correction), 5-38
 - Measurement, 5-4
 - FUNCTion Subsystem, 9-24
 - Furnished Accessories, **1-20**
 - Fuse Selection, 2-5

- G**
 - G, 7-3
 - G Accuracy, 1-9, 1-10
 - Garding, 7-14
 - General Information, 1-1
 - General Purpose Interface Bus (GP-IB), 8-1
 - GPIB
 - Addressing, 8-4
 - Bus Capability, 8-4
 - Command. *See* Command
 - Common Commands, 9-2, **9-96**
 - Connection, 8-1
 - Connector Signal/Pin, 8-2
 - Errors, B-1
 - Interconnect Cables, 8-2
 - Interface Capability, 8-3
 - Interface Connector, 3-5
 - Status Indicator, 3-3

Typical Interconnection, 8-3
GPIB ADDRESS Field, 6-9
Group Execute Trigger (GET), 8-5
GTL, 8-4

H *HANDLER I/F (#201)/(#202)* Field, 6-11
Handler I/F Test, 6-22
Header, 9-5
High DC Current Bias System, 6-10
HIGH Field
 Primary Parameter, 5-52
 Secondary Parameter, 5-54
 Sweep Limit, 5-63
How To Use This Manual, vii
Humidity, 1-21

I I BIAS, 5-19
I BIAS Softkey, 6-10
IDLE state, 8-12
*IDN? Query, 9-102
IEEE
 488.2 Common Commands, 8-6, **9-96**
 754 Floating Point Format, 8-10
 standard 488.1-1987, 8-1
 standard 488-1978, 8-1
 standard 488.2-1987, 9-2
IFC, 8-4
Im Field, 5-21
Impedance, 7-2
 Parameters, 7-1
incoming inspection , 2-1
INFINITY, 3-8
Initialize. *See* Reset
Initial Settings, C-1
INITiate Subsystem, 9-45
Input Line Area, 3-8
Input Protection, 1-22
Installation, 2-1
 Rack/Handle, 2-7
installation , 2-1
INT DC BIAS MONITOR BNC Connector, 3-5, **5-19**
INTEG Field, 5-12
Integration Time, 9-41
Interface Connectors, 3-5
Internal Memory (EEPROM), 6-3
 GPIB Command, 9-88
Interpolation
 OPEN Correction, 5-29
 SHORT Correction, 5-32
Introduction, 3-1

K KEY LOCK Function, **4-9**, 4-14, 4-18, 4-24

L L, 7-3

L Accuracy, 1-9

LCD Display Test, 6-22

LCD Panel, 3-2

(LCL) Key, 3-3

Learn Device Setup Query, 9-108

LED Display Test, 6-21

LEVEL Field, 5-9

Limitation of Warranty, ix

Limit Field, 5-63

Limit Mode, 5-47

LIMIT TABLE SETUP Page, 3-11, **5-44**

Line Frequency, 1-21

LINE Fuse Holder, 3-6

LINE Input Receptacle, 3-6

LINE On/Off Switch, 3-2

Line Voltage, 1-21, 2-5

LINE VOLTAGE SELECTOR, 3-6

Liquid Crystal Display, 3-2

Area Definition, 3-7

LIST Subsystem, 9-33

LIST SWEEP DISPLAY Page, 3-11, **4-19**

List Sweep Measurement Complete Bit, 8-25, 9-93, 9-95

List Sweep Measurement Function, 9-33

List Sweep Parameter Field, 5-62

LIST SWEEP SETUP Page, 3-12, **5-59**

LMT Field, 5-63

LOAD

Correction, 5-34, 5-36

Function, **4-4**, 4-13, 4-17, 4-22, 5-23, 5-56, 5-65, 6-4

REF A Field, 5-35

(REF) B Field, 5-35

Reference, 5-35

LOCAL, 8-4

LOCAL LOCKOUT (LLO), 8-4

LONG, 1-23, **5-12**

LOW Field

Primary Parameter, 5-52

Secondary Parameter, 5-54

Sweep Limit, 5-63

*LRN? Query, 9-108

M Major. *See* Primary

Manual Changes, A-1

Manual Printing History, iii

Mass MEMory Subsystem, 9-88

MAV (Message Available) Bit, 8-21

MEAS DISPLAY Page, 3-11, **4-1**

(MEAS SETUP) Menu, 5-1

MEAS SETUP Page, 3-11, **5-1**

Measurement

Accuracy, 1-6

- Basics, 7-1
- Cable Length, 5-41
- Cable Termination, 7-12
- Contacts, 7-9
- Functions, 1-3, 9-24
- Range, 5-5
- Reference Plane, 1-6
- Setup Clear, 5-23
- Measurement Complete Bit, 8-25, 9-93, 9-95
- MEASUREMENT state, 8-15
- Measurement Time, 1-23
- Measuring Bit, 8-24, 9-94
- Measuring Correction Data Bit, 8-24, 9-94
- Media* Monitor Area, 6-3
- Media Type, 6-3
 - Switch, 6-4
- MEDium, 1-23, **5-12**
- Memory
 - PURGE, 6-5
- Memory Card, 6-3
- Memory Card R/W Test, 6-20
- MEMORY Card Slot, 3-3
- MEMory Subsystem, 9-52
- MENU Keys, 3-2, 3-8
- Minor. *See* Secondary
- Mode
 - Correction, 5-40
 - Limit, 5-47
 - Sweep, 5-61
- MODE* Field, 4-21, 5-40, 5-47, 5-61
- MON* Field, 5-19
- MSS (Master Summary) Bit, 8-21
- MULTI Correction Mode, 5-40
- Multiple Command Rules, 9-3

N

- NOM* Field, 5-51
- No.* Monitor Area, 6-3
- Normal LCR Measurement Mode, 6-11
- Notation Conventions, 9-1
- NR1 Format, 9-5
- NR2 Format, 9-6
- NR3 Format, 9-6
- Number of Averages, 5-20
- Numeric Data, 9-5
- Numeric Entry, 3-17

- O** OFF Softkey, 6-10
 - *0PC Command, 9-103
 - OPEN Correction, 5-29
 - OPEN* Field, 5-29
 - OPEN/SHORT/LOAD Correction, 9-56
 - Operating Environment, 1-21, **2-6**
 - Altitude, 1-21
 - Humidity, 1-21
 - Temperature, 1-21
 - Operation Complete Command, 9-103
 - Operation Complete (OPC) Bit, 8-29
 - Operation Errors, B-1
 - Operation Status Registers Group, 8-23, 9-92
 - Operation Status Summary Bit, 8-26
 - Option, 1-18
 - trigger mode, 5-15
 - Option 001 DC Bias, 1-18, **5-10**
 - Monitor Accuracy, 5-19
 - Resolution, 5-10
 - Setting Range, 5-10
 - Option 002 Accessory Control Interface, 5-10
 - Option 201 Handler Interface, 6-11
 - Option 202 Handler Interface, 6-11
 - Option 301 Scanner Interface, 6-12
 - Option 907 Handle Kit, 2-7
 - Option 908 Rack Flange Kit, 2-7
 - Option 909 Rack Flange & Handle Kit, 2-8
 - OPTion Identification Query, 9-110
 - *0PT? Query, 9-110
 - Oscillator
 - level, 7-7
 - Level, 5-9
 - Resolution, 5-9
 - Setting Range, 5-9
 - OUTPut Subsystem, 9-17
 - Overview, 3-1

- P** Page Setup Clear
 - LIMIT TABLE SETUP* Page, 5-57
 - LIST SWEEP SETUP* Page, 5-66
 - MEAS SETUP* Page, 5-23
- Parallel Circuit Mode, 7-4
- Parallel Resistance, 7-3
- Parameters, 9-5
- Parameters Combinations, 1-3
- Parasitic Components, 7-21
- Percent Tolerance Mode, 5-48
- Polar Form, 7-1
- Power Consumption, 1-21
- Power Cord Selection, 2-3
- Power On (PON) Bit, 8-29
- Power Requirements, 1-21, **2-3**
- Precision Q Measurement System, 6-11
- Preset Correction Frequency Points, 5-29

Primary Parameter, 5-46, 5-51
Print DATA Format, 4-7
Print Out
 (*BIN COUNT DISPLAY* Page), 4-17
 (*CATALOG* Page), 6-4
 (*CORRECTION* Page), 5-42
 (*LIMIT TABLE SETUP* Page), 5-57
 (*LIST SWEEP DISPLAY* Page), 4-22
 (*LIST SWEEP SETUP* Page), 5-66
 (*MEAS DISP* Page), 4-6
 (*MEAS SETUP* Page), 5-24
 (*SYSTEM CONFIG* Page), 6-12
Program Message Terminators, 9-7
PURGE, 6-5

Q Q Accuracy, 1-9
Q-Adapter Buffer Test, 6-23
Q ADAPTER Softkey, 6-10
Q (Quality Factor), 7-3
Query
 *ESR?, 9-99
 *IDN?, 9-102
 *LRN?, 9-108
 *OPT?, 9-110
 *STB?, 9-101
 *TST?, 9-106
Query Error , B-1
Query Error (QYE) Bit, 8-29

R R, 7-2
R Accuracy, 1-9
Rack/Handle Installation, 2-7
RANGE Field, 5-5
Reactance, 7-2
Rear Panel, 3-5
Record
 Delete. *See* Memory, PURGE
 Number, 6-3
 Status, 6-3
Rectangular Form, 7-1
REF A Field
 (Deviation Reference), 5-22
 (Load), 5-35
(REF) B Field
 (Deviation), 5-22
 (Load), 5-35
Reference
 Plane, 5-41
 Value, 7-20
REMOTE, 8-5
Remote Control, 8-1
Reset, 5-25
 Command, 9-105
Resistance, 7-2

- Response Message Terminators, 9-8
- R_p, 7-3
 - Accuracy, 1-10
- RQS (Request Service) Bit, 8-5, 8-21
- R_s, 7-2
 - Accuracy, 1-10
- *RST Command, 9-105

S

- Safety
 - Summary, iv
 - Symbols, v
- Sample Programs, 8-31
- SCANNER I/F (#301)* Field, 6-12
- Scanner I/F EEPROM R/W Test, 6-22
- Scanner I/F I/O Test, 6-23
- SDC (Selected Device Clear), 8-4
- Secondary Parameter, 5-46, 5-51
- SELF TEST* Page, 3-12, 6-19
- Self-test Query, 9-106
- SEquence Mode, 5-61
- Sequential Tolerance Mode, 5-49
- Serial Number, 1-1
- Serial Polling, 8-5
- Series Circuit Mode, 7-4
- Service Request Enable Command, 9-100
- SERVICE REQUEST (SRQ), 8-5
- SET LOCAL, 8-4
- Settling Time, 1-22
- Shielding, 7-15
- SHORT, 1-23, **5-12**
- SHORT Correction, 5-32
- SHORT* Field, 5-32
- SINGLE Correction Mode, 5-40
- S Monitor Area, 6-3
- Softkey Area, 3-8
- Softkey Label, 3-8
- SOFTKEYS, 3-2
- Specifications, 1-3
- SPOLL, 8-5
- Spot
 - LOAD Correction, 5-34
 - OPEN Correction, 5-30
 - SHORT Correction, 5-32
- Spot OPEN/SHORT Correction, 5-35
- *SRE Command, 9-100
- Stability, 1-22
- Standard Event Status Enable Command, 9-98
- Standard Event Status Register, 8-27
- Standard Event Status Register Summary Bit, 8-21
- Standard Operation Status Condition Register, 8-24
- Standard Operation Status Event Enable Register, 8-26
- Standard Operation Status Event Register, 8-25
- Status Byte, 8-20
- Status Indicator, 3-3

- STATus Subsystem, 9-92
- *STB? Query, 9-101
- STEP Mode, 5-61
- STORE Function, **4-4**, 4-13, 4-17, 4-22, 5-23, 5-56, 5-65, 6-4
 - Contents, 4-4
- Stray Capacitance, 7-14
- String Data, 9-5
- Suceptance, 7-3
- Suffix
 - Multiplier, 9-6
 - Units, 9-6
- Summary of Pages, 3-11
- Supplemental Performance Characteristics, 1-22
- Swapping Parameter, 5-46
- Sweeping Bit, 8-24, 9-94
- Sweep Mode, 5-61
- Sweep Points* Field, 5-63
- SYS MENU* Field
 - (*BIN COUNT DISPLAY* Page), 4-16
 - (*BIN No. DISPLAY* Page), 4-13
 - (*CATALOG* Page), 6-3
 - (*CORRECTION* Page), 5-42
 - (*LIMIT TABLE SETUP* Page), 5-56
 - (*LIST SWEEP DISPLAY* Page), 4-21
 - (*LIST SWEEP SETUP* Page), 5-65
 - (*MEAS DISPLAY* Page), 4-4
 - (*MEAS SETUP* Page), 5-23
 - (*SYSTEM CONFIG* Page), 6-12
- SYSTEM CONFIG* Page, 3-12, **6-6**
- System Configuration Memory, 4-5
- SYSTEM:ERRor? Query, 9-91
- System Memory, C-1
- System Menu Field, 3-7. *See also SYS MENU* Field
- System Message Area, 3-8
- SYSTEM RESET, 5-25

T

- TALK ONLY* Field, 6-9
- Temperature
 - Coefficient, 1-22
 - Range, 1-21
- Termination, 7-12
- Terminators, 9-7
- Test and Measurement Systems Language (TMSL), 8-6
- Test Cable Configuration, 7-8
- Test Fixtures, 1-20
- Test Leads, 1-20
 - Configuration, 7-8, 7-12
 - Extension, 7-14
- TEST MENU* Field, 6-20
- Test Signal
 - Level, 1-4, 5-9, 7-7
 - Level Monitor, 5-21
 - Level Monitor Accuracy, 1-5
 - Resolution, 5-9

- Setting Accuracy, 1-4
- Setting Range, 5-9
- θ , 7-2
- θ Accuracy, 1-9
- TMSL Command. *See* Command
- % Tolerance Mode, 5-48
- Tolerance Mode, 5-48
 - Absolute, 5-48
 - Percent, 5-48
 - Sequential, 5-49
- *TRG Command, 9-107
- TRIG Field, 5-14
- Trigger
 - Command, 9-107
 - Control, 5-14
 - Delay Time, 5-20
 - Input Voltage/Current, 5-15
 - Pulse Width, 5-15
 - System, 8-12
- TRIGGER, 8-5
- TRIGGER Key, 3-3
- TRIGGER Subsystem, 9-42
- *TST? Query, 9-106
- Typeface Conventions, viii

U

- UNBAL, 3-8
- Unit Softkeys, 3-17
- UNKNOWN Terminals, 3-4
- UNLOCK Button, 3-3

V

- V BIAS, 5-19
- ventilation requirement, 2-7
- V_m Field, 5-21
- VOLTage Subsystem, 9-14

W

- *WAI Command, 9-104
- WAITING FOR TRIGGER state, 8-13
- Warm-up time, 1-6
- Warning
 - Messages, B-1, **B-14**
- Warranty, ix
- Weight, 1-21
- White Space, 9-7
- Working Standard, 7-20
- Write Protection, D-1

- X** X, 7-2
X Accuracy, 1-9
- Y** |Y|, 7-3
|Y| Accuracy, 1-9
 \dot{Y} , 7-3
- Z** |Z|, 7-2
|Z| Accuracy, 1-9
 \dot{Z} , 7-2

REGIONAL SALES AND SUPPORT OFFICES

For more information about Agilent Technologies test and measurement products, applications, services, and for a current sales office listing, visit our web site: <http://www.agilent.com/find/tmdir>. You can also contact one of the following centers and ask for a test and measurement sales representative. 11/29/99

United States:

Agilent Technologies
Test and Measurement Call Center
P.O.Box 4026
Englewood, CO 80155-4026
(tel) 1 800 452 4844

(fax) (61 3) 9272 0749
(tel) 0 800 738 378 (New Zealand)
(fax) (64 4) 802 6881

Canada:

Agilent Technologies Canada Inc.
5150 Spectrum Way
Mississauga, Ontario
L4W 5G1
(tel) 1 877 894 4414

Asia Pacific:

Agilent Technologies
24/F, Cityplaza One, 1111 King's Road,
Taikoo Shing, Hong Kong
(tel) (852)-3197-7777
(fax) (852)-2506-9284

Europe:

Agilent Technologies
Test & Measurement
European Marketing Organization
P.O.Box 999
1180 AZ Amstelveen
The Netherlands
(tel) (31 20) 547 9999

Japan:

Agilent Technologies Japan Ltd.
Call Center
9-1, Takakura-Cho, Hachioji-Shi,
Tokyo 192-8510, Japan
(tel) (81) 426 56 7832
(fax) (81) 426 56 7840

Latin America:

Agilent Technologies
Latin American Region Headquarters
5200 Blue Lagoon Drive, Suite #950
Miami, Florida 33126
U.S.A.
(tel) (305) 267 4245
(fax) (305) 267 4286

Australia/New Zealand:

Agilent Technologies Australia Pty Ltd
347 Burwood Highway
Forest Hill, Victoria 3131
(tel) 1-800 629 485 (Australia)