

**KEITHLEY**

# Model 580 Micro-ohmmeter Operator's Manual

A GREATER MEASURE OF CONFIDENCE



## WARRANTY

Keithley Instruments, Inc. warrants this product to be free from defects in material and workmanship for a period of 1 year from date of shipment.

Keithley Instruments, Inc. warrants the following items for 90 days from the date of shipment: probes, cables, rechargeable batteries, diskettes, and documentation.

During the warranty period, we will, at our option, either repair or replace any product that proves to be defective.

To exercise this warranty, write or call your local Keithley representative, or contact Keithley headquarters in Cleveland, Ohio. You will be given prompt assistance and return instructions. Send the product, transportation prepaid, to the indicated service facility. Repairs will be made and the product returned, transportation prepaid. Repaired or replaced products are warranted for the balance of the original warranty period, or at least 90 days.

## LIMITATION OF WARRANTY

This warranty does not apply to defects resulting from product modification without Keithley's express written consent, or misuse of any product or part. This warranty also does not apply to fuses, software, non-rechargeable batteries, damage from battery leakage, or problems arising from normal wear or failure to follow instructions.

**THIS WARRANTY IS IN LIEU OF ALL OTHER WARRANTIES, EXPRESSED OR IMPLIED, INCLUDING ANY IMPLIED WARRANTY OF MERCHANTABILITY OR FITNESS FOR A PARTICULAR USE. THE REMEDIES PROVIDED HEREIN ARE BUYER'S SOLE AND EXCLUSIVE REMEDIES.**

**NEITHER KEITHLEY INSTRUMENTS, INC. NOR ANY OF ITS EMPLOYEES SHALL BE LIABLE FOR ANY DIRECT, INDIRECT, SPECIAL, INCIDENTAL OR CONSEQUENTIAL DAMAGES ARISING OUT OF THE USE OF ITS INSTRUMENTS AND SOFTWARE EVEN IF KEITHLEY INSTRUMENTS, INC., HAS BEEN ADVISED IN ADVANCE OF THE POSSIBILITY OF SUCH DAMAGES. SUCH EXCLUDED DAMAGES SHALL INCLUDE, BUT ARE NOT LIMITED TO: COSTS OF REMOVAL AND INSTALLATION, LOSSES SUSTAINED AS THE RESULT OF INJURY TO ANY PERSON, OR DAMAGE TO PROPERTY.**

## KEITHLEY

Keithley Instruments, Inc. 28775 Aurora Road • Cleveland, Ohio 44139 • 440-248-0400 • Fax: 440-248-6168  
1-888-KEITHLEY (534-8453) • [www.keithley.com](http://www.keithley.com)

Sales Offices: BELGIUM: Bergensesteenweg 709 • B-1600 Sint-Pieters-Leeuw • 02-363 00 40 • Fax: 02/363 00 64  
CHINA: Yuan Chen Xin Building, Room 705 • 12 Yumin Road, Dewai, Madian • Beijing 100029 • 8610-6202-2886 • Fax: 8610-6202-2892  
FINLAND: Tietijantie 2 • 02130 Espoo • Phone: 09-54 75 08 10 • Fax: 09-25 10 51 00  
FRANCE: 3, allée des Garays • 91127 Palaiseau Cédex • 01-64 53 20 20 • Fax: 01-60 11 77 26  
GERMANY: Landsberger Strasse 65 • 82110 Germering • 089/84 93 07-40 • Fax: 089/84 93 07-34  
GREAT BRITAIN: Unit 2 Commerce Park, Brunel Road • Theale • Berkshire RG7 4AB • 0118 929 7500 • Fax: 0118 929 7519  
INDIA: Flat 2B, Willocrissa • 14, Rest House Crescent • Bangalore 560 001 • 91-80-509-1320/21 • Fax: 91-80-509-1322  
ITALY: Viale San Gimignano, 38 • 20146 Milano • 02-48 39 16 01 • Fax: 02-48 30 22 74  
JAPAN: New Pier Takeshiba North Tower 13F • 11-1, Kaigan 1-chome • Minato-ku, Tokyo 105-0022 • 81-3-5733-7555 • Fax: 81-3-5733-7556  
KOREA: FL., URI Building • 2-14 Yangjae-Dong • Seocho-Gu, Seoul 137-130 • 82-2-574-7778 • Fax: 82-2-574-7838  
NETHERLANDS: Postbus 559 • 4200 AN Gorinchem • 0183-635333 • Fax: 0183-630821  
SWEDEN: c/o Regus Business Centre • Frosundaviks Allé 15, 4tr • 169 70 Solna • 08-509 04 679 • Fax: 08-655 26 10  
SWITZERLAND: Kriesbachstrasse 4 • 8600 Dübendorf • 01-821 94 44 • Fax: 01-820 30 81  
TAIWAN: 1FL., 85 Po Ai Street • Hsinchu, Taiwan, R.O.C. • 886-3-572-9077 • Fax: 886-3-572-9031

# Model 580 Micro-ohmmeter Operator's Manual

©1985, Keithley Instruments, Inc.  
All rights reserved.  
Cleveland, Ohio, U.S.A.  
Fourth Printing, February 2001  
Document Number: 580-900-01 Rev. D

# SPECIFICATIONS/580

---

Range	Resolution	Maximum Test Current	Non Dry Circuit Test		Dry Circuit Test	
			Accuracy 1 Year, 18°-28°C ± (%Rdg + Counts) Pulsed      DC		Maximum Power Dissipation in Sample	Accuracy 1 Year, 18°-28°C ± (%Rdg + Counts) Pulsed
200mΩ	10 μΩ	100mA	0.04 + 2	0.04 + 3	500μW	0.05 + 2
2 Ω	100 μΩ	10mA	0.04 + 2	0.04 + 3	50μW	0.05 + 2
20 Ω	1mΩ	1mA	0.04 + 2	0.04 + 3	5μW	0.05 + 2
200 Ω	10mΩ	1mA	0.04 + 2	0.04 + 2		
2 kΩ	100mΩ	1mA	0.04 + 2	0.04 + 2		
20 kΩ	1 Ω	10 μA	0.05 + 2	0.05 + 2		
200 kΩ	10 Ω	10 μA	0.075 + 2	0.075 + 2		

**CONFIGURATION:** 4-wire (two sense, two source).

**MAXIMUM SOURCE VOLTAGE:** 20mV in Dry Circuit Test, 1V otherwise.

**MAXIMUM TEST LEAD RESISTANCE**

**200mΩ and 2Ω Ranges:** Up to 5Ω in each SOURCE lead and 10Ω in each SENSE lead with Non Dry Circuit Test; up to the selected full range resistance in each SOURCE lead and 10Ω in each SENSE lead with Dry Circuit Test.

**20Ω through 200kΩ Ranges:** Up to half of the selected range in each test lead.

**CONVERSION RATE:** 3 readings/second typical.

**RANGING:** Auto or manual.

**AUTORANGING TIME:** 200ms per range change, average.

**SETTLING TIME:** Less than 1 second to within 10 counts on range.

**MAXIMUM INPUT OVERLOAD:** 10V limited to 10A.

**MAXIMUM COMMON MODE VOLTAGE:** 30V rms at dc, 50 or 60Hz.

**TEMPERATURE COEFFICIENT (0°-18°C and 28°-50°C):** ±(0.1 × applicable accuracy specification)/°C.

## GENERAL

---

**DISPLAY:** ±20,000 count LCD, range and status information displayed.

**OVERRANGE INDICATION:** "OL" displayed.

**CONNECTORS:** Measurement and rear panel EXTERNAL TRIGGER inputs: Banana jacks.

**RELative:** Allows zeroing of on-range readings. Allows readings to be made with respect to baseline value. Display annunciator indicates REL.

**DRIVE:** Selects either pulsed or dc SOURCE current. Pulsed drive provides automatic cancellation of thermal offsets, using 50% duty cycle pulse. Display annunciator indicates drive selected.

**POLARITY:** Selects either positive or negative SOURCE current in either drive. Display annunciator indicates polarity selected.

**TRIGger:** Allows single pulsed measurements.

**OPERATING ENVIRONMENT:** 0°-50°C, less than 80% R.H. up to 35°C; linearly derate 3% R.H./°C from 35° to 50°C.

**STORAGE ENVIRONMENT:** -25° to +60°C.

**POWER:** 105-125V or 210-250V (switch selected), 90-110V available. 50-60Hz, 12VA. Optional 6 hour battery pack, Model 1978.

**DIMENSIONS, WEIGHT:** 89mm high × 241mm wide × 300mm deep (3½in. × 9½in. × 11¾in.). Net weight 3.2kg (7 lbs.). Test lead pouch adds 76mm (3in.) in height.

**ACCESSORIES AVAILABLE:**

**Model 1010:** Single Rack Mounting Kit.

**Model 1017:** Dual Rack Mounting Kit.

**Model 1755:** Calibration Interface.

**Model 1978:** Rechargeable Battery Pack.

**Model 5801:** Test Lead Pouch.

**Model 5802:** Isolated Analog Output/IEEE-488 Interface.

**Model 5804:** Test Lead Set.

**Model 5805:** Kelvin Probes.

**Model 5806:** Kelvin Clip Leads.

**Model 7007-1:** Shielded IEEE-488 Digital Cable (1m).

**Model 7007-2:** Shielded IEEE-488 Digital Cable (2m).

**Model 7008-3:** IEEE-488 Digital Cable (3ft.).

**Model 7008-6:** IEEE-488 Digital Cable (6ft.).

**Model 8003:** Low Resistance Test Fixture.

**ACCESSORIES SUPPLIED:** Models 5801, 5804, 5805, 5806, Operator's and Service Manuals.

The following safety precautions should be observed before using this product and any associated instrumentation. Although some instruments and accessories would normally be used with non-hazardous voltages, there are situations where hazardous conditions may be present.

This product is intended for use by qualified personnel who recognize shock hazards and are familiar with the safety precautions required to avoid possible injury. Read and follow all installation, operation, and maintenance information carefully before using the product. Refer to the manual for complete product specifications.

If the product is used in a manner not specified, the protection provided by the product may be impaired.

The types of product users are:

**Responsible body** is the individual or group responsible for the use and maintenance of equipment, for ensuring that the equipment is operated within its specifications and operating limits, and for ensuring that operators are adequately trained.

**Operators** use the product for its intended function. They must be trained in electrical safety procedures and proper use of the instrument. They must be protected from electric shock and contact with hazardous live circuits.

**Maintenance personnel** perform routine procedures on the product to keep it operating properly, for example, setting the line voltage or replacing consumable materials. Maintenance procedures are described in the manual. The procedures explicitly state if the operator may perform them. Otherwise, they should be performed only by service personnel.

**Service personnel** are trained to work on live circuits, and perform safe installations and repairs of products. Only properly trained service personnel may perform installation and service procedures.

Keithley products are designed for use with electrical signals that are rated Installation Category I and Installation Category II, as described in the International Electrotechnical Commission (IEC) Standard IEC 60664. Most measurement, control, and data I/O signals are Installation Category I and must not be directly connected to mains voltage or to voltage sources with high transient over-voltages. Installation Category II connections require protection for high transient over-voltages often associated with local AC mains connections. Assume all measurement, control, and data I/O connections are for connection to Category I sources unless otherwise marked or described in the Manual.

Exercise extreme caution when a shock hazard is present. Lethal voltage may be present on cable connector jacks or test fixtures. The American National Standards Institute (ANSI) states that a shock hazard exists when voltage levels greater than 30V RMS, 42.4V peak, or 60VDC are present. **A good safety practice is to expect that hazardous voltage is present in any unknown circuit before measuring.**

Operators of this product must be protected from electric shock at all times. The responsible body must ensure that operators are prevented access and/or insulated from every connection point. In some cases, connections must be exposed to potential human contact. Product operators in these circumstances must be trained to protect themselves from the risk of electric shock. If the circuit is capable of operating at or above 1000 volts, **no conductive part of the circuit may be exposed.**

Do not connect switching cards directly to unlimited power circuits. They are intended to be used with impedance limited sources. NEVER connect switching cards directly to AC mains. When connecting sources to switching cards, install protective devices to limit fault current and voltage to the card.

Before operating an instrument, make sure the line cord is connected to a properly grounded power receptacle. Inspect the connecting cables, test leads, and jumpers for possible wear, cracks, or breaks before each use.

When installing equipment where access to the main power cord is restricted, such as rack mounting, a separate main input power disconnect device must be provided, in close proximity to the equipment and within easy reach of the operator.

For maximum safety, do not touch the product, test cables, or any other instruments while power is applied to the circuit under test. ALWAYS remove power from the entire test system and discharge any capacitors before: connecting or disconnecting cables or jumpers, installing or removing switching cards, or making internal changes, such as installing or removing jumpers.

Do not touch any object that could provide a current path to the common side of the circuit under test or power line (earth) ground. Always make measurements with dry hands while standing on a dry, insulated surface capable of withstanding the voltage being measured.

The instrument and accessories must be used in accordance with its specifications and operating instructions or the safety of the equipment may be impaired.

Do not exceed the maximum signal levels of the instruments and accessories, as defined in the specifications and operating information, and as shown on the instrument or test fixture panels, or switching card.

When fuses are used in a product, replace with same type and rating for continued protection against fire hazard.

Chassis connections must only be used as shield connections for measuring circuits, NOT as safety earth ground connections.

If you are using a test fixture, keep the lid closed while power is applied to the device under test. Safe operation requires the use of a lid interlock.

If a  screw is present, connect it to safety earth ground using the wire recommended in the user documentation.

The  symbol on an instrument indicates that the user should refer to the operating instructions located in the manual.

The  symbol on an instrument shows that it can source or measure 1000 volts or more, including the combined effect of normal and common mode voltages. Use standard safety precautions to avoid personal contact with these voltages.

The **WARNING** heading in a manual explains dangers that might result in personal injury or death. Always read the associated information very carefully before performing the indicated procedure.

The **CAUTION** heading in a manual explains hazards that could damage the instrument. Such damage may invalidate the warranty.

Instrumentation and accessories shall not be connected to humans.

Before performing any maintenance, disconnect the line cord and all test cables.

To maintain protection from electric shock and fire, replacement components in mains circuits, including the power transformer, test leads, and input jacks, must be purchased from Keithley Instruments. Standard fuses, with applicable national safety approvals, may be used if the rating and type are the same. Other components that are not safety related may be purchased from other suppliers as long as they are equivalent to the original component. (Note that selected parts should be purchased only through Keithley Instruments to maintain accuracy and functionality of the product.) If you are unsure about the applicability of a replacement component, call a Keithley Instruments office for information.

To clean an instrument, use a damp cloth or mild, water based cleaner. Clean the exterior of the instrument only. Do not apply cleaner directly to the instrument or allow liquids to enter or spill on the instrument. Products that consist of a circuit board with no case or chassis (e.g., data acquisition board for installation into a computer) should never require cleaning if handled according to instructions. If the board becomes contaminated and operation is affected, the board should be returned to the factory for proper cleaning/servicing.

# TABLE OF CONTENTS

## SECTION 1—GENERAL INFORMATION

1.1	INTRODUCTION .....	1-1
1.2	FEATURES .....	1-1
1.3	WARRANTY INFORMATION .....	1-2
1.4	MANUAL ADDENDA .....	1-2
1.5	SAFETY SYMBOLS AND TERMS .....	1-2
1.6	SPECIFICATIONS .....	1-3
1.7	UNPACKING AND INSPECTION .....	1-3
1.8	USING THE MODEL 580 MANUAL .....	1-3
1.9	OPTIONAL ACCESSORIES .....	1-4

## SECTION 2—BENCH OPERATION

2.1	INTRODUCTION .....	2-1
2.2	PREPARATION FOR USE .....	2-1
2.2.1	Line Power .....	2-1
2.2.2	Battery Pack Power .....	2-2
2.2.3	Battery Charging .....	2-2
2.3	FRONT PANEL FAMILIARIZATION .....	2-3
2.3.1	Display .....	2-3
2.3.2	Front Panel Controls .....	2-6
2.3.3	Rear Panel Functions .....	2-7
2.3.4	SOURCE/SENSE Terminals and Test Leads .....	2-9
2.4	ERROR AND OPERATIONAL MESSAGES .....	2-9
2.5	OPERATING CONDITIONS .....	2-12
2.5.1	Environmental Conditions .....	2-12
2.5.2	Maximum Allowable Inputs .....	2-12
2.5.3	Warm Up .....	2-12
2.6	BASIC MEASUREMENTS .....	2-12
2.6.1	Connecting Test Leads .....	2-13
2.6.2	Resistance Measurement Procedure .....	2-16
2.6.3	Example Measurements .....	2-16
2.6.4	Polarity .....	2-17
2.6.5	Drive .....	2-18
2.6.6	Relative .....	2-21



2.6.7	Trigger .....	2-21
2.6.8	Dry Circuit Test .....	2-25
2.7	SPECIAL MEASUREMENT CONSIDERATIONS .....	2-26
2.7.1	Thermal EMFs and DRIVE $\rightleftharpoons$ .....	2-26
2.7.2	Material Temperature Coefficient .....	2-28
2.7.3	Noisy High Resistance Measurements .....	2-30
2.7.4	Common Mode Voltage Noise .....	2-32
2.7.5	Erratic or Noisy Low Resistance Measurements .....	2-32

## **APPENDIX A**

IEEE-488 Commands .....	A-1
-------------------------	-----

## **APPENDIX B**

IEEE-488 Programs .....	B-1
-------------------------	-----

# LIST OF TABLES

## SECTION 2—BENCH OPERATION

2-1	Error Messages .....	2-10
2-2	Operational Messages .....	2-11
2-3	Maximum Test Lead Resistance in Each Lead .....	2-15
2-4	Maximum Inductance and Capacitance Values .....	2-18
2-5	Dry Circuit Test .....	2-26
2-6	Thermoelectric Potentials .....	2-27
2-7	Voltage Sensitivities .....	2-28
2-8	Common Material Temperature Coefficients of Resistance .....	2-29

# LIST OF ILLUSTRATIONS

## SECTION 2—BENCH OPERATION

2-1	Front Panel Layout.....	2-5
2-2	Rear Panel Layout .....	2-8
2-3	Test Lead Connections.....	2-14
2-4	Drive Waveforms .....	2-20
2-5	External Trigger Specifications .....	2-23
2-6	External Trigger Isolation .....	2-24
2-7	Alternate Test Lead Connections for Resistances Above 2k $\Omega$ .....	2-31
2-8	Open Test Leads .....	2-33

## APPENDIX A

A-1	Model 5802 Primary Address Switch .....	A-7
-----	---	-----

---

# SECTION 1

## General Information

### 1.1 INTRODUCTION

The Model 580 is a 4½ digit resolution autoranging micro-ohmmeter with a  $\pm 20,000$  count LCD (Liquid Crystal Display). This unit is designed for low resistance measurement requirements from  $10\mu\Omega$  to  $200k\Omega$ .

The Model 580 has an analog output/IEEE-488 interface option, the Model 5802. This optional interface enhances the capabilities of the Model 580 by allowing programmed control over the IEEE-488 bus. The bus commands used by the Model 5802 respond to standard IEEE-488 protocol.

### 1.2 FEATURES

1. Low Resistance Measurement—Seven resistance ranges from  $200m\Omega$  to  $200k\Omega$ , with  $10\mu\Omega$  resolution on the lowest range.
2. Relative (REL)—Allows measurements to be made as compared to a previously measured resistance (a base reading is subtracted from subsequent readings).
3. Digital Calibration—Performed from the front panel or over IEEE-488 bus. Non-volatile RAM retains calibration constants.
4. Autoranging—Model 580 includes a fast autoranging feature for easier measurements.
5. Trigger (TRIG)—Allows operator to make single resistance measurements at desired intervals.
6. Dry Circuit Test—Limits test voltages to  $20mV$  to protect sensitive contact junctions (Dry Circuit Test used in  $200m$ ,  $2$ , and  $20\Omega$  ranges only).

- 
7. DRIVE—Select pulsed or DC SOURCE current.
  8. POLARITY—Selects positive or negative SOURCE current. Red SOURCE terminal positive when POL+ displayed; negative when POL- displayed.

### 1.3 WARRANTY INFORMATION

Warranty information may be found on the inside front cover of this manual. Should it become necessary to exercise the warranty, contact your Keithley representative or the factory to determine the proper course of action. Keithley Instruments maintains service facilities in the United States, United Kingdom and throughout Europe. Information concerning the application, operation or service of your instrument may be directed to the applications engineer at any of these locations. Check the inside front cover for addresses.

### 1.4 MANUAL ADDENDA

Information concerning improvements or changes to this instrument which occur after the printing of this manual will be found on an addendum sheet included with this manual. Be sure to review these changes before attempting to operate or service the instrument.

### 1.5 SAFETY SYMBOLS AND TERMS

The following safety symbols/terms are used in this manual or are found on the Model 580.

The  symbol on the instrument denotes the user should refer to the operating instructions in this manual.

The **WARNING** heading used in this manual explains dangers that could result in personal injury or death.

The **CAUTION** heading used in this manual explains hazards that could damage the instrument.

---

## **1.6 SPECIFICATIONS**

Detailed Model 580 specifications may be found preceding the Table of Contents of this manual.

## **1.7 UNPACKING AND INSPECTION**

The Model 580 Micro-ohmmeter was carefully inspected, both electrical-ly and mechanically, before shipment. Upon receiving the instrument, carefully unpack all items from the shipping carton and check for any obvious signs of physical damage that may have occurred during transit. Report any damage to the shipping agent. Retain and use the original packing materials in case reshipment is necessary. The following items are shipped with every Model 580 order:

- Model 580 Micro-Ohmmeter
- Model 580 Operator's Manual
- Model 580 Service Manual
- Model 5801 Test Lead Pouch
- Model 5804 Test Lead Set
- Model 5805 Kelvin Probes
- Model 5806 Kelvin Clip Lead Set
- Additional accessories as ordered.

If an additional instruction manual is required, order the manual package (Keithley Part Number 580-900-00). The manual package includes an operator's manual and any applicable addenda.

## **1.8 USING THE MODEL 580 OPERATOR'S MANUAL**

This manual contains information necessary for operating the Model 580 Micro-Ohmmeter and the Model 1978 Rechargeable Battery Pack. The information is divided into the following sections.

- 
1. Section 1 contains general information including initial operation and accessories.
  2. Section 2 contains detailed bench operation information for the Model 580.

If an optional Model 5802 IEEE-488 Interface was purchased for Model 580 Micro-ohmmeter, refer to Appendix A, which lists the device-dependent commands available to the Model 580; and Appendix B, which includes sample programs which may be used by different controllers to communicate with or operate the Model 580.

#### **NOTE**

The Model 5802 IEEE-488 Interface comes supplied with its own instruction manual.

## **1.9 OPTIONAL ACCESSORIES**

The following optional accessories can be used with the Model 580.

**MODEL 1010 SINGLE RACK MOUNTING KIT**—Used to mount one Model 580 in a standard 5¼" × 19" rack.

**MODEL 1017 DUAL RACK MOUNTING KIT**—Used to mount two Model 580s (or similar style instruments) in a standard 5¼" × 19" rack.

**MODEL 1755 CALIBRATION INTERFACE OPTION**—The Model 580 may be digitally calibrated via Model 1755 Calibration Interface. The IEEE-488 interface board is installed in the calibration interface rather than in the Model 580, which is mounted directly on top of the calibration interface. This arrangement allows remote calibration from an IEEE-488 controller (such as an IBM PC or HP-85) over the IEEE-488 bus when the IEEE-488 option (5802) is not installed in the instrument.

---

An advantage of calibration with the Model 1755 includes closed case, automated performance verification and calibration which results in reduced labor costs. In addition, only one IEEE-488 interface board is required, no matter how many Model 580s are calibrated. NOTE: Only the Model 5802 may be used in the Model 1755 when calibrating the Model 580. An IEEE-488 interface board designed for one instrument type cannot be used with a different instrument type. For more information on Model 1755, refer to Instruction Manual 1755-901-01, or contact a Keithley representative.

**MODEL 1978 RECHARGEABLE BATTERY PACK** — The rechargeable battery pack allows offline or in-the-field operation of the Model 580. The pack typically provides six hours operation from full charge. The battery pack contains its own charging circuit and can be recharged within 15 hours. The battery pack is field installable.

**MODEL 5801 TEST LEAD POUCH** — A padded vinyl test lead pouch is included with every Model 580. This 7.5" x 10.5" x 4" (when open) pouch holds test probes and leads for the Model 580 as well as the Model 580 Operator's Manual. The pouch slips on top of the Model 580 and fastens beneath it with two Velcro® straps.

**MODEL 5802 ANALOG OUTPUT/IEEE-488 INTERFACE** — The Model 5802 is an optional IEEE-488 interface for the Model 580 Micro-ohmmeter. This interface adds extra versatility to the Model 580 by allowing the transmission of data and commands over the IEEE-488 bus. The scaled analog output follows the display of the Model 580. The Model 5802 interface is field installable.

**MODEL 5804 TEST LEAD SET** — The Model 5804 set includes: two test probes with spring-loaded plunger clip adapters to fit test probes, two spring-loaded plunger test clips with in-line banana jacks, and four solid copper alligator clips with insulator boots. This test lead set is included with the Model 580 Micro-ohmmeter.



---

**MODEL 5805 KELVIN PROBES**—The Model 5805 includes two spring-loaded Kelvin test probes (one red, one black), with 48-inch banana plug cable assemblies. The Kelvin test probes are included with the Model 580 Micro-ohmmeter. A set of eight replacement contacts for the Model 5805 Kelvin test probes is also available (Keithley P/N CS-551).

**MODEL 5806 KELVIN CLIP LEAD SET**—The Model 5806 includes two Kelvin clip test lead assemblies with banana plug termination (one red, one black). The Model 5806 is included with the Model 580 Micro-ohmmeter. A set of eight replacement rubber bands for the Model 5806 is also available (Keithley P/N GA-22).

**MODEL 7007 IEEE-488 SHIELDED DIGITAL CABLE**—Used to connect the Model 5802 interface to the IEEE-488 bus. The Model 7007 cable and its connectors are shielded. Available in 1m (3.3 ft., Model 7007-1) and 2m (6.6 ft. Model 7007-2) lengths.

**MODEL 7008 IEEE-488 DIGITAL CABLE**—Used to connect the Model 5802 to the IEEE-488 bus. The Model 7008-3 is 0.9 m (3 ft.) long and has a standard IEEE-488 connector at each end. The Model 7008-6 is 1.8m (6 ft.) long and has a standard IEEE-488 connector at each end.

---

# SECTION 2

## Bench Operation

### 2.1 INTRODUCTION

This section contains the information needed to prepare and operate the Model 580. Installation and operation of the optional battery pack (Model 1978) is included in this section. The capabilities of the Model 580 can be enhanced with the addition of the Model 5802 IEEE-488 interface. IEEE-488 interface operation is covered in the Model 5802 Instruction Manual.

### 2.2 PREPARATION FOR USE

#### 2.2.1 Line Power

The Model 580 has a three-wire line cord which mates with three-wire grounded receptacles. Connect the instrument to AC line power as follows:

1. Set the LINE VOLTAGE switch on the back of the instrument to correspond to line voltage available. Ranges are 105V-125V or 210V-250V (90-110V or 195-235V for Japanese versions), frequency 50/60Hz AC.

#### **CAUTION**

**Connect only to the line voltage selected. Application of incorrect voltage can damage the instrument.**

2. Plug the power cord into a properly grounded outlet.

---

### **WARNING**

**Ground the instrument through a properly grounded receptacle before operation. Failure to ground the instrument can result in severe injury or death in event of a short circuit or malfunction.**

3. Turn on instrument and check if unit is set to proper line frequency. The frequency setting is immediately displayed on power up (F50=50Hz, F60=60Hz).
4. To change the line frequency setting, place the CALIBRATION switch in ENABLED. Then, turn off the instrument and power up again while pressing SHIFT to put the unit in 60Hz, or power up while pressing POLARITY to put the unit in 50Hz. Return calibration switch to DISABLED. To temporarily change frequency, leave CALIBRATION switch in DISABLED, then repeat step 4.

### **NOTE**

Although the Model 580 is specified at 50 and 60Hz, the instrument may be operated at 400Hz (F50 line frequency setting).

## **2.2.2 Battery Pack Power**

The Model 580 may be operated from rechargeable sealed nickel-cadmium batteries contained in the optional Model 1978 Rechargeable Battery Pack. The battery pack will operate the Model 580 for typically six hours. The BAT annunciator turns on when the charge is insufficient to maintain accurate readings.

## **2.2.3 Battery Charging**

After the Model 1978 is installed in the Model 580, it can be charged or recharged as follows:

- 
1. Connect the instrument to line power as described in paragraph 2.2.1.
  2. The battery charge circuit is energized automatically when the instrument is plugged into the A.C. line. The rate at which the batteries charge is the same regardless of the power switch state. When the battery pack is first installed, or if it is completely discharged, allow it to charge for a minimum of 15 hours.

#### **NOTE**

For maximum battery life and performance, frequently cycle instrument from line power to battery power. If the batteries are continuously charged (i.e., operating off line power) for several days or weeks, the available capacity of the batteries decreases, thereby reducing battery operation time. If this has occurred, it is possible to return the batteries to normal capacity by cycling the battery pack through five to ten complete 15 hour charge and discharge cycles.

3. When the Model 580 is in use on line power, the battery charger maintains a trickle charge on the battery pack.

#### **NOTE**

The IEEE-488 option (Model 5802) does not run off of battery power.

## **2.3 FRONT PANEL FAMILIARIZATION**

Figure 2-1 and the following paragraphs provide a brief description of the display, front panel controls and input terminals.

### **2.3.1 Display**

The Model 580 has a 4½ digit liquid crystal display (LCD). The plus sign is implied by the absence of the minus sign. The following annunciators are displayed on the LCD.

---

## ANNUNCIATORS

BAT—Low battery indicator

$\Omega$ , m $\Omega$ , k $\Omega$ —ohms, milliohms, kilohms



REL—Relative

AUTO—Autorange

TRIG—Trigger

POL—SOURCE polarity is positive (+) or negative (-)

CAL—Calibration in progress. Flashes to indicate invalid or temporary calibration.

DRIVE—SOURCE is pulsed (  ) or continuous (  )

DRY CIRCUIT TEST—Applicable in 200m, 2 and 20 $\Omega$  ranges

## IEEE-488 ANNUNCIATORS

RMT (REMOTE)—Control over the IEEE-488 bus (Model 5802 installed)

LLO—Local Lockout (Model 5802 installed). Front panel controls ignored.

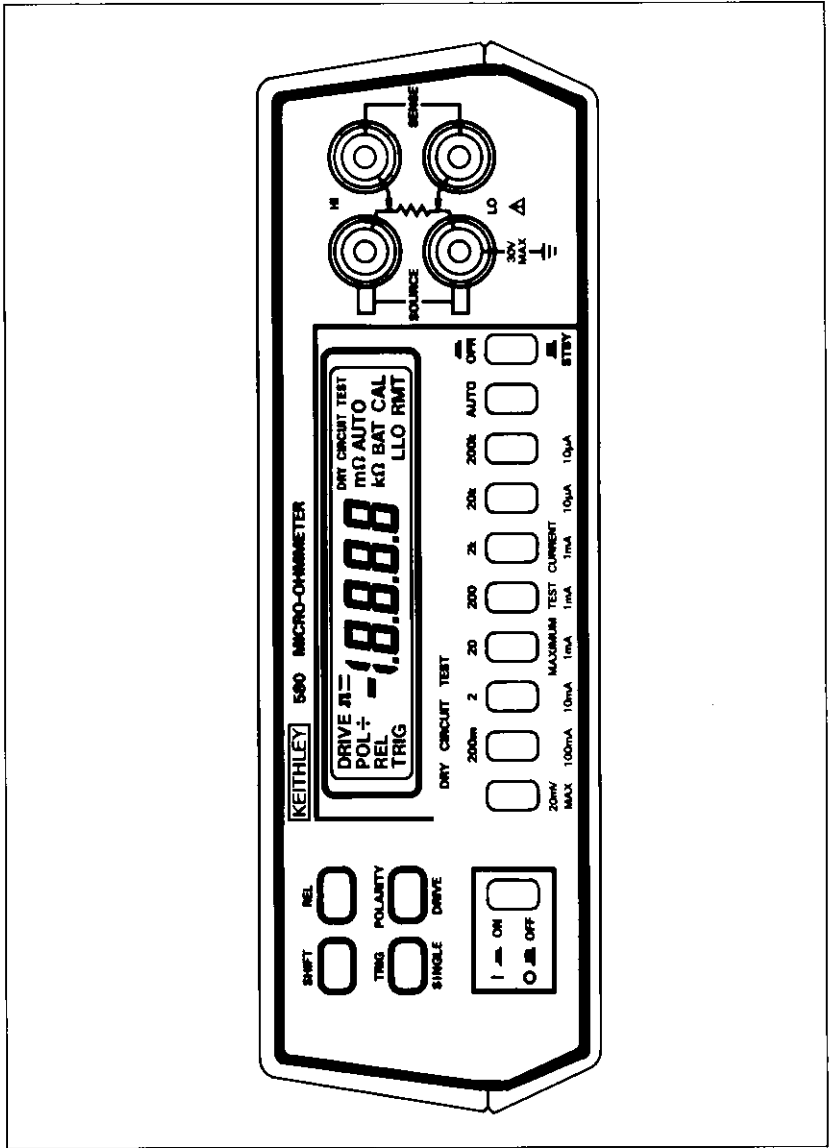

Figure 2-1. Front Panel Layout



---

## 2.3.2 Front Panel Controls

**ON/OFF**—Depressing this button turns on the Model 580; releasing it turns off the instrument.

**SHIFT**—This button allows the user to engage the **SINGLE** and **DRIVE** function buttons (yellow color codes). First press **SHIFT**, then press desired function key.

**RELative**—Cancels test lead resistance, offsets, or stores input as reference level.

**DRIVE**—Press **SHIFT** then **DRIVE** to toggle **SOURCE** between pulsed (  ) or DC (  ). On power up, **DRIVE** is pulsed.

**POLARITY**—Selects positive or negative **SOURCE** current. Red **SOURCE** terminal positive when **POL+** displayed; negative when **POL-** displayed. **POLARITY** is positive on power up.

**TRIGger/SINGLE**—Allows single measurement for minimum heating of unknown. To select, press **SHIFT** then **SINGLE**. Subsequent **TRIG** button presses or **EXTERNAL TRIGGER** (rear panel) inputs will trigger a single measurement. To cancel press **SHIFT** then **SINGLE** again.

**DRY CIRCUIT TEST**—This function clamps the test voltage at a maximum of 20mV. Applicable to 200m, 2 and 20 $\Omega$  ranges only.

**OPR/STBY**—When this button is pressed, the instrument will take readings. When released, instrument goes into Standby, which programs the **SOURCE** and **SENSE** terminals to 0V. Standby should be used when setting up measurements.

**Range Buttons**—Manual ranging is accomplished by pressing the appropriate range button. Pressing the **AUTO** button allows the instrument to autorange.

---

### **2.3.3 Rear Panel Functions**

**LINE VOLTAGE SWITCH**—Used to select Model 580 line voltage. Ranges are 105-125V or 210-250V. (90-110V or 195-235V on Japanese version)

**CALIBRATION SWITCH**—When in the **ENABLED** position, the calibration switch permits calibration to be permanently stored. When in the **DISABLED** position, calibration storage is impossible.

**EXTERNAL TRIGGER**—An external stimulus (e.g., foot pedal switch closure) may be used to trigger single resistance measurements.



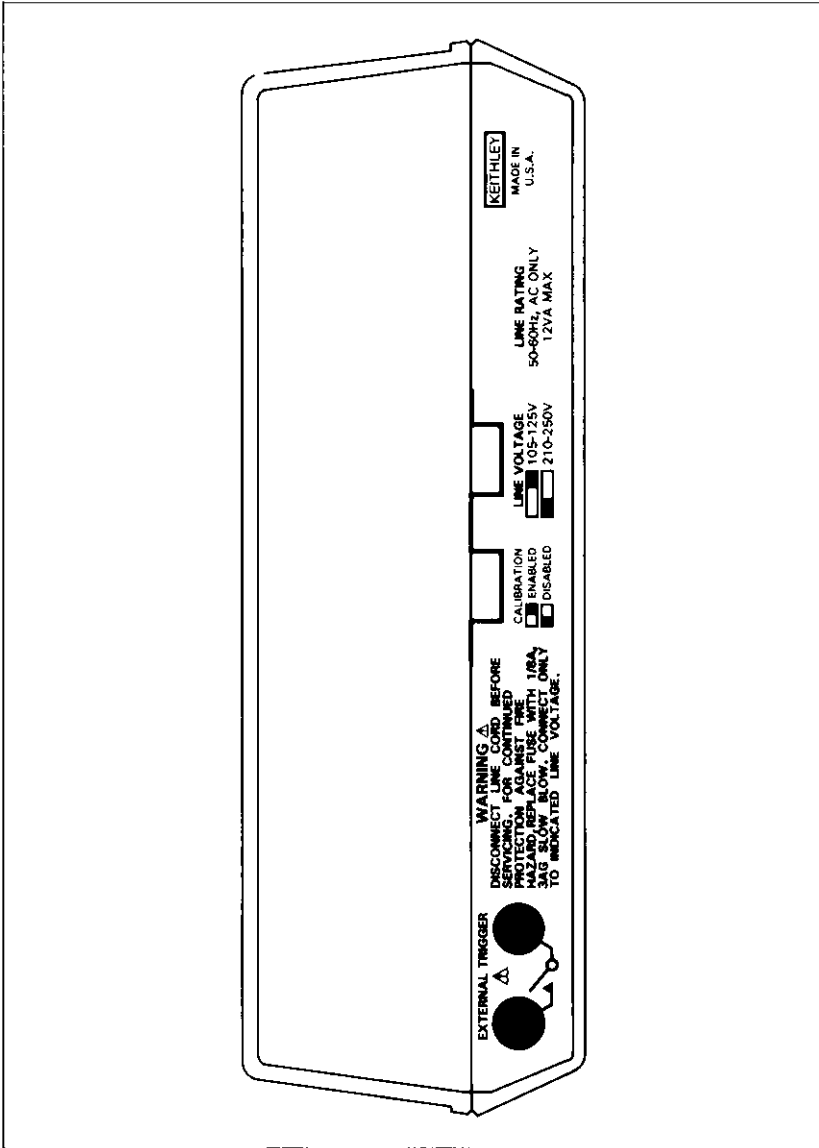

Figure 2-2. Rear Panel Layout

---

### **2.3.4 SOURCE/SENSE Terminals and Test Leads**





The SOURCE and SENSE terminals are intended to be used with the test leads supplied with the Model 580 (see paragraph 1.7). In addition, any other leads designed for use with four-wire resistance measurements may be used with the Model 580.

The SOURCE terminals provide a known test current (maximum 100mA) to the sample. The SENSE terminals read the voltage drop across the sample, and the sample's resistance is determined from this value.







## **2.4 ERROR AND OPERATIONAL MESSAGES**

Table 2-1 lists the error messages associated with basic front panel operation. Note that the instrument has a number of operational messages that are shown in Table 2-2.

**Table 2-1. Error Messages**

Display	Message	Comments
	Overload	Leads improperly connected or range inappropriately set.
	Invalid range for dry circuit test.	"Dry Circuit Test" and "Ω" annunciators flash. Only 200m, 2 and 20Ω ranges operate Dry Circuit Test when selected.
	Calibration error (NVRAM Failure)	U125 may be defective. See Service Manual.
	If displayed at power up indicates RAM failure.	RAM (U118) may be defective. See Service Manual.

**Table 2-2. Operational Messages**

Display	Message	Comments
	Standby	Indicates instrument is in standby (STBY/OPR switch released).
	Calibration program entry	This is displayed when entering calibration.
	Out	Displayed when calibration is exited and calibration is temporarily stored. The instrument retains temporary calibration until power is cycled. The CAL annunciator flashes, indicating temporary calibration.
	Store	Displayed when calibration is exited and permanently stored.
	Software revision level	Displayed as part of diagnostics. See Service Manual.
	50Hz	Instrument integration time is set to reject 50Hz or 400Hz line interference.
	60Hz	Instrument integration time is set to reject 60Hz line interference.

---

## **2.5 OPERATING CONDITIONS**

### **2.5.1 Environmental Conditions**

All measurements should be made at an ambient temperature within the range of 0°C to 50°C, and with a relative humidity of less than 80% up to 35°C. For ambient above 35°C, derate humidity 3% per degree Celsius up to 50°C. If the instrument has been subjected to extreme temperatures, allow sufficient time for internal temperature to reach environmental conditions. Typically, it takes one hour to stabilize a unit that is 10°C (18°F) out of the specified temperature range.

### **2.5.2 Maximum Allowable Inputs**

For normal operation, the only input to the Model 580 should be a resistance. If voltage or current is applied to the Model 580, it must be limited to 10V at 10A or instrument damage may result.

### **2.5.3 Warm Up**

The Model 580 requires no warm-up time to achieve rated accuracy when the IEEE interface is not installed. When the Model 5802 is installed, the Model 580 requires one hour to warm up.

## **2.6 BASIC MEASUREMENTS**

The following paragraphs will describe basic resistance measurement techniques and features of the Model 580 Micro-ohmmeter.

---

## 2.6.1 Connecting Test Leads

Three sets of test leads (Models 5804, 5805 and 5806) are supplied with the Model 580 for making 4-wire resistance measurements (see Figure 2-3). These test leads allow easy connections and probing for accurate measurements. The Model 5806 Kelvin Clip Leads should be used for devices with two leads, the Model 5804 Test Leads for devices with four leads, and the Model 5805 Kelvin Probes on flat surfaces such as printed circuit board traces.

All three test lead sets connect to the Model 580 the same way. The red dual banana plug should be connected to SOURCE HI and SENSE HI and the black dual banana plug to SOURCE LO and SENSE LO (see Figure 2-3). In both cases, the tab side of the dual banana plug should face the SOURCE terminal. Improperly connected test leads will give a zero resistance reading or an overload indication (OL) when connected to the unknown.

The test leads supplied with the Model 580 are marked in order to properly identify the SOURCE and SENSE connections when measuring an unknown. Model 5805 is marked with a tab on its probe that corresponds with the tab on its banana plug. Model 5806 is marked with a heat shrink sleeve on the clip handle that corresponds with the tab on its banana plug. The single banana jack of the Model 5804 corresponds to the tab side of the dual banana plug. When the test leads are connected to the Model 580 as shown in Figure 2-3, the SOURCE HI or SOURCE LO corresponds to the tab on the Model 5805, the heat shrink sleeve on the Model 5806, and the single banana plug on the Model 5804.

### **WARNING**

**The Model 5804 and Model 5805 test probes have very sharp tips. Use caution when handling these probes.**

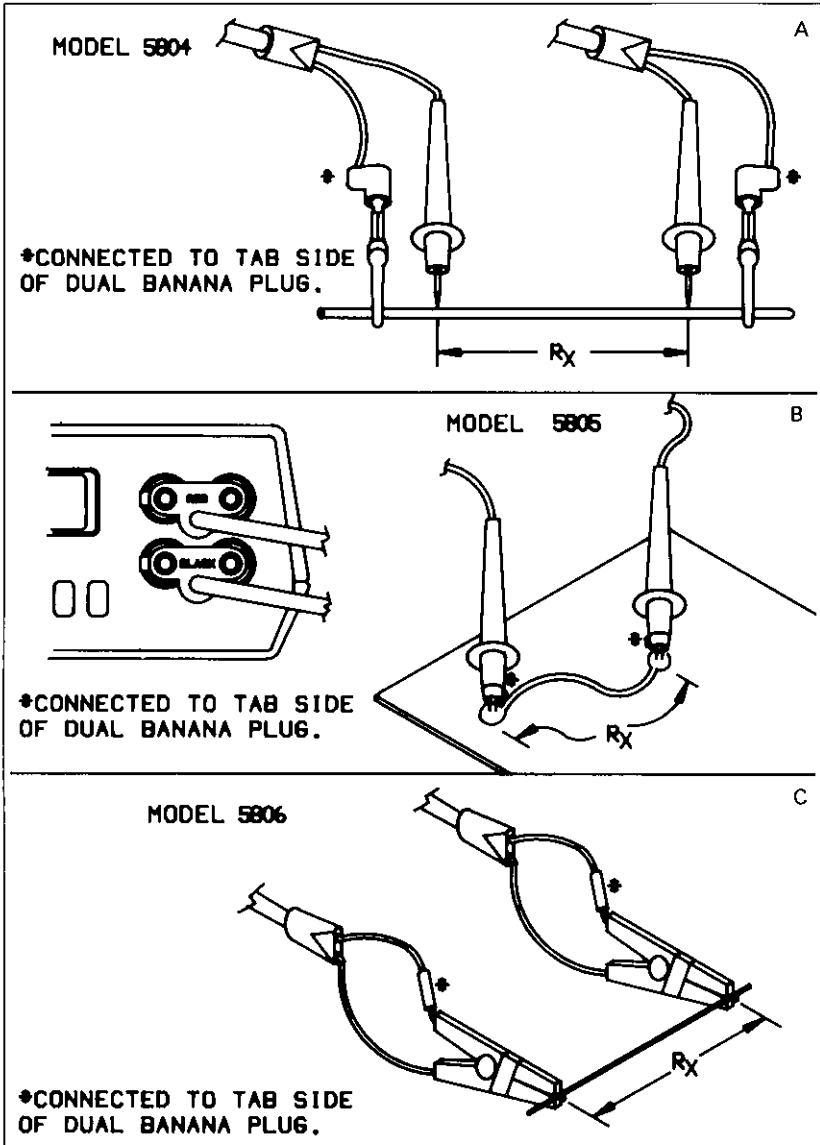

**Figure 2-3. Test Lead Connections**

Since the Model 580 makes 4-wire resistance measurements, the unknown resistance ( $R_x$ ) displayed is not affected by test lead resistance within specified limits (see Table 2-3).

**Table 2-3. Maximum Test Lead Resistances in Each Lead**

Range	Non Dry Circuit Test		Dry Circuit Test	
	Source	Sense	Source	Sense
200m $\Omega$	5 $\Omega$	10 $\Omega$	0.2 $\Omega$	10 $\Omega$
2 $\Omega$	5 $\Omega$	10 $\Omega$	2 $\Omega$	10 $\Omega$
20 $\Omega$	10 $\Omega$	10 $\Omega$	10 $\Omega$	10 $\Omega$
200 $\Omega$	100 $\Omega$	100 $\Omega$		
2 k $\Omega$	1k $\Omega$	1k $\Omega$		
20 k $\Omega$	10k $\Omega$	10 k $\Omega$		
200 k $\Omega$	100k $\Omega$	100k $\Omega$		

The Model 5805 and 5806 test leads measure the resistance present between the two test probes. The Model 5804 test leads measure the resistance present between the SENSE probes (see Figure 2-3).

**WARNING**

**The maximum allowable test lead voltage is 42.4V peak. Higher voltages present a shock hazard at the test leads and operator injury may result.**

Although three sets of leads are supplied with the Model 580, any leads capable of performing 4-wire resistance measurements may be used, provided their maximum test lead resistances do not exceed the values in Table 2-3.



---

## 2.6.2 Resistance Measurement Procedure

The following procedure should be followed to make most resistance measurements with the Model 580.

1. Set the line voltage switch on the rear panel to the appropriate setting (105-125V or 210-250V).
2. Turn on power; put instrument in STBY (standby).
3. Select proper range button (or autorange), appropriate POLARITY (see paragraph 2.6.4), and DRIVE (see paragraph 2.6.5).
4. Connect the test leads to the Model 580 and to the unknown (refer to Figure 2-3 for proper test lead connections).
5. Set the instrument on OPR (operate) and take a measurement.

It is a good practice to keep the Model 580 in standby (STBY) until ready to take a measurement. Then, put the instrument in operate (OPR). This is especially important with Dry Circuit Test measurements or with thermally sensitive devices. Inadvertent transients or SOURCE current flow encountered during test lead hookup might have detrimental effects on sensitive samples.

## 2.6.3 Example Measurements

The various test leads included with the Model 580 allow the operator to make a multitude of resistance measurements. This section describes several types of measurements commonly encountered in a lab situation.

All these measurements should be made according to the procedure described in paragraph 2.6.2. Make sure power-up conditions are used (DRIVE  $\Rightarrow$ , POL +).

---

### **Example 1**

Use the Model 5804 Test Leads included with the Model 580 to measure a carbon-composition resistor. Place the SENSE leads closest to the resistor body and the SOURCE leads to the outside of the SENSE leads to get a proper measurement (see Figure 2-3A).

### **Example 2**

Now try measuring the resistance on a piece of FR-4 copper-clad board. Use the spring-loaded Kelvin probes provided with the Model 580 and position them as illustrated in Figure 2-3B. Try moving the probes around to different positions on the board and see how this affects the resistance measured. As the probes move farther apart, note that resistance increases.

### **Example 3**

Measure the resistance of a six-inch long piece of solid copper 18 AWG wire. This resistance can be measured with the Model 5806 Kelvin Clip Leads that are supplied with the instrument. Make connections as illustrated in Figure 2-3C. A reading of approximately  $3.10\text{m}\Omega$  should appear on the Model 580 display.

Also try making readings by either manually selecting the anticipated range button or pressing the autorange button (AUTO) to select the correct range automatically.



## **2.6.4 Polarity**

The POLARITY button allows the user to select a positive or negative SOURCE. By pressing POLARITY the SOURCE will reverse direction. The red SOURCE terminal is positive when POL+ is displayed and negative when POL- is displayed.

---

The POLARITY button does not affect the sign of the displayed reading, only the direction of the SOURCE current. If a negative reading is displayed, check to see if SOURCE HI, SENSE HI and SOURCE LO, SENSE LO are properly connected. A negative reading may also be caused by inputs to the instrument that are less than the stored REL value (see paragraph 2.6.6).

## 2.6.5 Drive

The DRIVE feature of the Model 580 allows the user to select between two SOURCE waveforms, pulsed () or DC (). Upon power up, the Model 580 defaults to positive polarity (POL +) and pulsed drive (DRIVE ). The user can select between the two drives by pressing SHIFT, then DRIVE. This will toggle the SOURCE current between pulsed and DC. Pulsed drive is recommended for most resistance measurements since it cancels thermal offsets in the test lead connections and the unknown resistance. DC drive should be used for reactive unknowns such as transformers, inductors or resistors paralleled by capacitors whose inductance or capacitance exceeds the values listed in Table 2-4.

**Table 2-4. Maximum Inductance and Capacitance Values For Pulsed Drive**

Range	Capacitance	Inductance
200m $\Omega$	1000 $\mu$ F	1000 $\mu$ H
2 $\Omega$	100 $\mu$ F	10mH
20 $\Omega$	10 $\mu$ F	100mH
200 $\Omega$	1 $\mu$ F	100mH
2 k $\Omega$	.1 $\mu$ F	100mH
20 k $\Omega$	.01 $\mu$ F	1 H
200 k $\Omega$	.001 $\mu$ F	1 H

---

If DC drive is used, thermal EMFs are not cancelled during every measurement cycle and may cause inaccurate readings. These thermal EMFs can be compensated for by using OPR/STBY with DC drive as described below:

1. Set the Model 580 to DRIVE ---
2. Select STBY (standby) by releasing the OPR/STBY switch.
3. Connect the test leads to the unknown. When attaching the test leads to the unknown, avoid warming the contact area with fingers to keep thermal offsets to a minimum.
4. Select OPR (operate).

#### NOTE

The test leads must be connected to the unknown before selecting OPR or inaccurate readings may result.

Before the Model 580 applies the SOURCE current, an offset measurement is taken to compensate for thermal EMFs. This measurement is used in the calculation of the unknown resistance. Only one offset measurement is taken when OPR is selected, so if the thermal EMFs change, the OPR/STBY switch must be cycled to compensate for the new offsets.

For resistance measurements of inductors or transformers above 15mH the Model 580 must be left in the STBY position for period long enough to adequately dissipate the inductor's stored energy or an improper offset measurement will be taken. The time period the Model 580 must be left in STBY is:

$$\text{time (seconds)} = \frac{10 * \text{Inductance of unknown (in Henries)}}{0.2\Omega + \text{Approximate resistance of unknown (in ohms)}}$$

For example, if a 1H inductance with approximately 1 $\Omega$  of total resistance is to be measured, the minimum time STBY must be selected is:

$$\frac{10 * 1H}{0.2\Omega + 1.0\Omega} = 8.3 \text{ seconds}$$

To determine the approximate resistance of the unknown for use in the above equation, simply use the resistance reading obtained with DC (—) DRIVE selected.

If the inductance of the device under test is not known or the inductance is so large that the STBY time selected is inconvenient, an averaging method may be used to compute the reading which accounts for thermal offsets. To perform the averaging method, select DC (—) DRIVE, POL+ and measure the unknown. Record the reading after it has stabilized. Next, press the POLARITY button to change the test current to POL- and record this reading after it has stabilized. Now add each of the readings obtained with POL+ and POL- selected and divide the result by two. This represents the resistance of the unknown.

The waveforms and timing associated with the two drives are given in Figure 2-4.

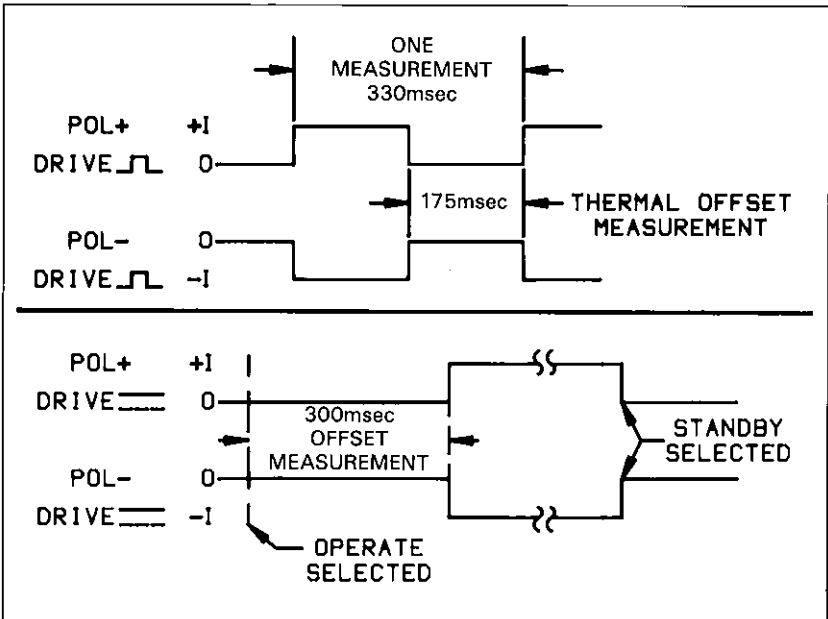

Figure 2-4. Drive Waveforms

---

## 2.6.6 Relative

The relative (REL) function is used to establish a baseline reading. This reading is subtracted from all subsequent readings. The purpose of making REL measurements is to cancel test lead and offset resistances or to store an input as a reference level.

Once a REL level is established, it remains in effect until another REL level is set. The REL value is only good for the range the value was taken on and higher ranges. If a lower range is selected than that on which the REL was taken, inaccurate results may occur. REL cannot be activated when "OL" is displayed.

When the REL button is pressed with an on-range reading displayed, the following occurs:

1. The REL annunciator is displayed.
2. The next reading is stored, and zeroes now appear on the display.
3. This stored reading is algebraically subtracted from all subsequent readings and the difference is displayed.

The Model 580 will display OL when the particular resistance applied exceeds the limits of the range selected. The instrument accepts a  $\pm 19,999$  count input before going into the overrange condition. Also, if the algebraic result of the REL calculation exceeds the limit of the display, an overrange condition will occur.

## 2.6.7 Trigger

For some resistance measurements (e.g., thermistors, thermoelectric devices, fuses), keeping the power dissipation in the unknown to a minimum is necessary. To accomplish this, the Model 580 can be triggered on a single shot basis from the front panel, EXTERNAL TRIGGER input (rear panel), or Model 5802 analog output/IEEE-488 option using the T1, T3 or T5 trigger commands.

---

To enter single trigger from the front panel, proceed as follows:

1. Select STBY.
2. Select DRIVE .
3. Select range and other function as desired (e.g., POLARITY, DRY CIRCUIT TEST, etc.)
4. Press SHIFT then SINGLE to enter single trigger.
5. Connect the unknown to the test leads.
6. Select OPR. Upon selecting OPR, one reading will be taken.
7. Press TRIG to take subsequent measurements. Each time TRIG is pressed, a new reading will be taken.

With pulsed drive selected, the unknown will be excited with each trigger for 150msec. Single trigger may also be used with DC drive, but the unknown will be continuously excited; with each trigger, the display will be updated.

If REL is pressed while in single trigger a new reading will be taken and used as the relative value.

While in single trigger, any front panel button press will trigger a reading to be taken.

Triggering may also be accomplished using the EXTERNAL TRIGGER input. This input requires a falling edge pulse as shown in Figure 2-5. It is protected to  $\pm 15V$  peak. The trigger pulse may be supplied by a foot pedal switch closure or logic circuit that can sink  $250\mu A$  while maintaining a low voltage of  $0.4V$ . This pulse must remain low for a minimum of 1msec. There is no maximum since this input is debounced.

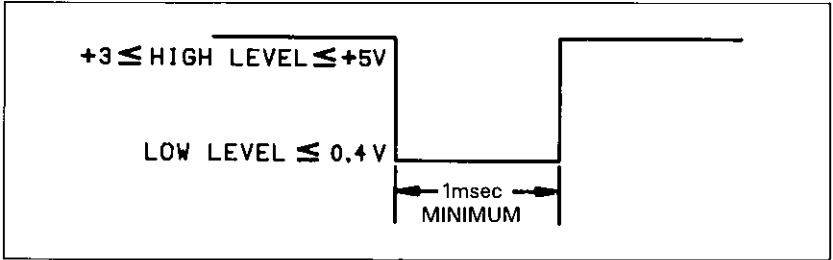

**Figure 2-5. External Trigger Specifications**

**CAUTION**

**EXTERNAL TRIGGER low (black terminal) is connected to SOURCE LO through a  $1\text{k}\Omega$  resistor.**

The EXTERNAL TRIGGER low (black terminal) input is connected to SOURCE LO through a  $1\text{k}\Omega$  resistor so care must be taken to avoid ground loops. If complete isolation is required the instrument may be triggered using the Model 5802 IEEE-488 option and a controller or by isolating the EXTERNAL TRIGGER input as shown in Figure 2-6. A small relay can also be used if desired. For information regarding triggering with the Model 5802, see the Model 5802 Instruction Manual.

The TREADLITE foot pedal switch (Cat. No. T-51-S) is recommended for use with the EXTERNAL TRIGGER of the Model 580. Contact Linemaster Switch Corp., 74 Plaine Hill Road, Woodstock, CT. 06281. (Phone (203) 974-1000).



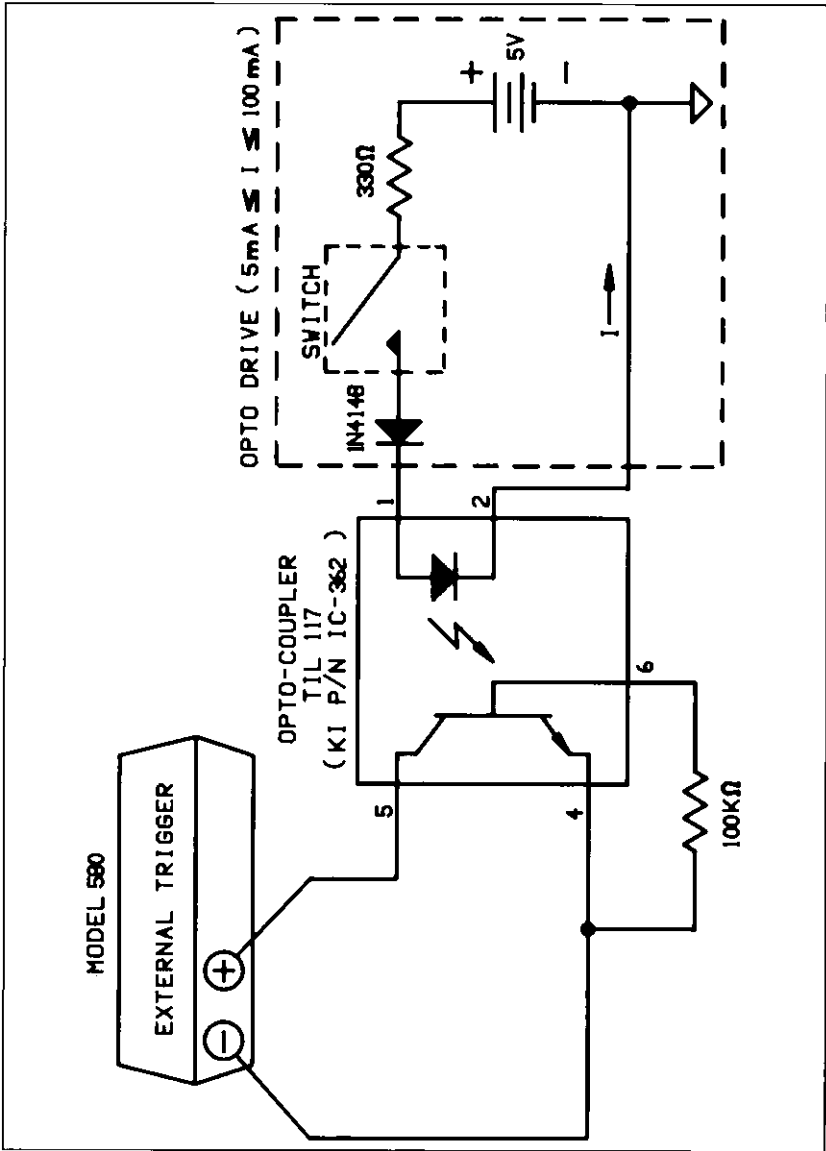

Figure 2-6. External Trigger Isolation

---

## 2.6.8 Dry Circuit Test

A dry circuit test requires limited current and voltage levels to minimize any physical and electrical changes in the contact junction. The DRY CIRCUIT TEST feature of the Model 580 is used to measure such contact resistances or similar situations where the maximum SOURCE voltage must be limited to 20mV.

Limiting the voltage in the measuring circuit will leave the resistive surface films built up on the contacts undisturbed. Voltages under 20mV (used by the Model 580) will not rupture these sensitive films, thus allowing measurement of the resistance resulting from these films.

To make dry circuit tests, simply press the DRY CIRCUIT TEST button and either the 200m $\Omega$ , 2 $\Omega$  or 20 $\Omega$  range buttons, then follow the standard resistance measurement procedure described in paragraph 2.6.2.

### NOTE

Do not attempt to use any range higher than 20 $\Omega$  with DRY CIRCUIT TEST. If a higher range is selected, the Model 580 will display "Err" and the ohms and DRY CIRCUIT TEST annunciators will flash to indicate that this is an invalid dry circuit test range. Voltage will be automatically clamped at 20mV.

If standby is used with DRY CIRCUIT TEST, all inputs are maintained within 1mV of SOURCE LO to prevent unexpected excitation of the device under test. When OPR is pressed, the instrument will begin taking measurements.

Refer to Table 2-5 for values of maximum power dissipation in sample and maximum allowable test lead resistance applicable in DRY CIRCUIT TEST.

Although not specified, Model 580 can be used in DRY CIRCUIT TEST with DRIVE = . Table 2-5 lists performance limits for this condition which can be expected on typical units.

**Table 2-5. Dry Circuit Test**

Range	Maximum Short Circuit Current	Maximum Power Available to the Unknown	Typical DC Accuracy $\pm$ (%Rdg + Counts)	Maximum Resistance in Each Lead	
				Sense	Source
200m $\Omega$	100mA	500 $\mu$ W	0.05 + 6	5 $\Omega$	0.2 $\Omega$
2 $\Omega$	10mA	50 $\mu$ W	0.05 + 6	5 $\Omega$	2.0 $\Omega$
20 $\Omega$	1mA	5 $\mu$ W	0.05 + 6	10 $\Omega$	10 $\Omega$

## 2.7 SPECIAL MEASUREMENT CONSIDERATIONS

The following sections contain practical considerations which may prove useful under special conditions or in unusual environments.

### 2.7.1 Thermal EMFs and DRIVE =

Thermoelectric voltages (EMFs) are the most common source of error in low resistance measurements. The Model 580 eliminates these errors in pulsed drive by measuring the offsets and using this measurement in the calculation of the unknown resistance. Thermal EMFs occur when junctions of dissimilar metals in a circuit are at different temperatures, such as the test leads' probe tip connections to the unknown being measured. The magnitude of the offset is dependent on the temperature difference between the junctions and composition of the connecting materials. Table 2-6 lists some common thermoelectric potentials with copper as one of the connecting materials.

---

**Table 2-6. Thermoelectric Potentials**

<b>Materials</b>	<b>Thermoelectric Potentials</b>
Cu-Cu	$<0.2\mu\text{V}/\text{C}$
Cu-Ag	$0.3\mu\text{V}/\text{C}$
Cu-Au	$0.3\mu\text{V}/\text{C}$
Cu-Pb/Sn	$1-3\mu\text{V}/\text{C}$
Cu-Brass	$3\mu\text{V}/\text{C}$
*Cu-Kovar	$40\mu\text{V}/\text{C}$
Cu-Si	$400\mu\text{V}/\text{C}$
Cu-CuO	$1000\mu\text{V}/\text{C}$

\*Kovar is a registered trademark of Westinghouse

In DC drive, thermal EMFs are not cancelled unless DC drive is used with OPR/STBY. When the OPR/STBY button is cycled while the test leads are connected to the unknown resistance, an offset measurement is taken which is accounted for in computing the unknown resistance so as to cancel any thermal EMFs present. The offset measurement is good only as long as the temperature gradient across the two junctions remains constant.

The Model 580 has its greatest sensitivity to thermals on the 200m $\Omega$ , 2 $\Omega$  and 20 $\Omega$  ranges. Table 2-7 lists the voltage sensitivities of the various ranges. The values in the table correspond to the thermal EMFs necessary to cause one count of error on the display.

---

**Table 2-7. Voltage Sensitivities**

Range	Sensitivity	
	Non-Dry Circuit Test	Dry Circuit Test
200m $\Omega$	1 $\mu$ V	200nV
2 $\Omega$	1 $\mu$ V	250nV
20 $\Omega$	1 $\mu$ V	250nV
200 $\Omega$	10 $\mu$ V	
2 k $\Omega$	100 $\mu$ V	
20 k $\Omega$	10 $\mu$ V	
200 k $\Omega$	100 $\mu$ V	

**Example:**

Connect the Model 5806 Kelvin test clip to a six-inch Kovar wire. Handling the Kovar wire and test clips might result in a 1°C temperature difference between the two Kovar to test clip junctions (which generates approximately 40 $\mu$ V). This corresponds to 40 counts on the 200m $\Omega$  range. When measuring resistance in DC drive, let the circuit reach thermal equilibrium before taking the measurement after handling interconnects to avoid an unstable reading. One minute is usually adequate.

### **2.7.2 Material Temperature Coefficient**

Ambient temperature may also affect the resistance being measured depending on the temperature coefficient of the sample. Table 2-8 lists some common materials and their temperature coefficients.

**Table 2-8. Common Material Temperature Coefficients of Resistance**

Materials	Temperature Coefficient ( $\alpha$ )
Constantan	.00001/°C
Manganin	.00001/°C
Phosphor Bronze	.0018/°C
Brass	.002/°C
Gold	.0034/°C
Silver	.0038/°C
Aluminum	.0039/°C
Copper (annealed)	.0039/°C
Lead	.0039/°C
Tin	.0042/°C
Tungsten (drawn)	.0045/°C
Iron	.005/°C
Nickel	.006/°C

**Example:**

The temperature coefficient given in Table 2-8 can be used to compute the change in resistance of an unknown given a specific temperature change using the following equation:

$$\Delta R_x = \alpha (T_2 - T_1) R_x^*$$

Where:

$T_1$  = Temperature at which  $R_x$  was measured

$T_2$  = New temperature

$R_x$  = Resistance of unknown being measured at  $T_1$

$\Delta R_x$  = Resistance change caused by temperature change

$\alpha$  = Temperature coefficient given in Table 2-8

\*This equation is valid for small temperature changes around ambient.

---

For example, a one-foot piece of 24 AWG solid copper wire at 20°C measures 25.66mΩ. If the ambient air temperature changes +5°C, the resistance will change:

$$\begin{aligned}\Delta R_x &= (.0039) (25^\circ\text{C} - 20^\circ\text{C}) (25.66\text{m}\Omega) \\ \Delta R_x &= 0.50\text{m}\Omega\end{aligned}$$

So the resistance at 25°C will be  $R_x + \Delta R_x = 26.16\text{m}\Omega$

### 2.7.3 Noisy High Resistance Measurements

The Model 580 is designed to minimize the excitation voltage and current to the unknown in order to reduce any heating effects or voltage offsets. This effectively reduces the signal-to-noise ratio for resistances greater than 2kΩ. Normally this presents no problem due to the low noise circuitry employed in the Model 580. In certain electrically noisy environments, however, some instability in the reading may result for samples greater than 2kΩ.

The Model 5804 test leads supplied with the unit may be connected as shown in Figure 2-7 to help reduce any displayed noise in this situation. If POL- is used, the tabbed end of the dual banana plugs should be connected to SOURCE HI and SENSE HI.

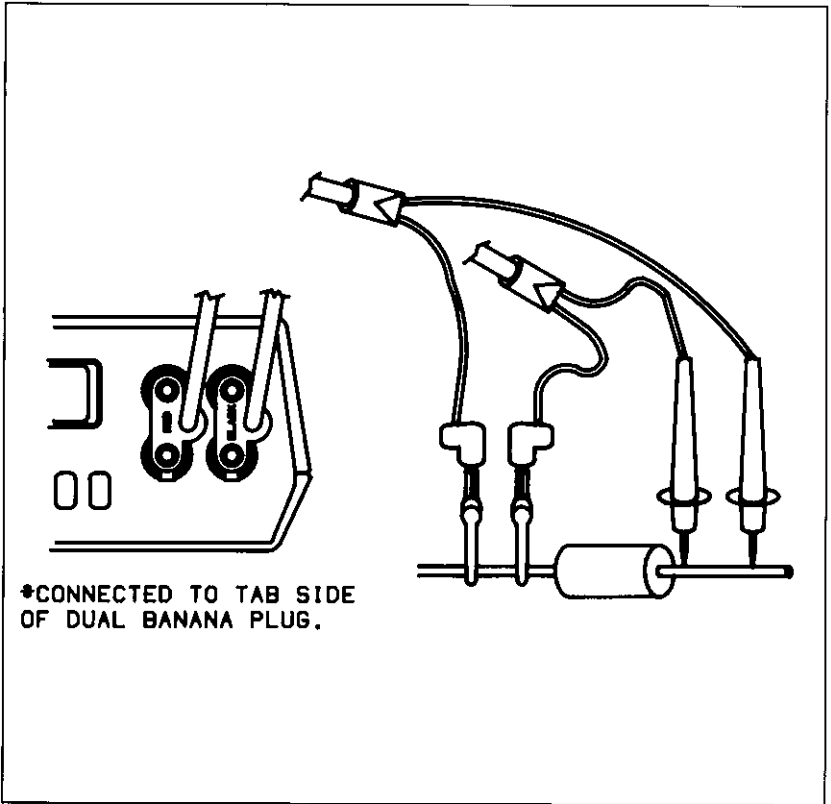

**Figure 2-7. Alternate Test Lead Connections for Resistances Above 2kΩ**



---

## 2.7.4 Common Mode Voltage Noise

The Model 580 is specified for a maximum common mode voltage of 30V at DC, 50 or 60Hz. The Model 580 may be subjected to common mode signals from DC to 400Hz provided the maximum peak voltage does not exceed 42.4V

Excessive noise may result on the 20k $\Omega$  or 200k $\Omega$  ranges for common mode signals with frequencies that are not whole multiples of the line frequency setting selected. For example, if a 400Hz common mode signal is present, the Model 580 must be set to a line frequency setting of 50Hz (F50) since 400Hz is a whole multiple of 50Hz. Similarly, for a 180Hz common mode signal, a 60Hz (F60) line frequency setting would be used.

If the common mode signal is not a whole multiple of either 50 or 60Hz, try to eliminate the effect of the common mode signal by shielding the unknown and operating the Model 580 from the Model 1978 Battery Pack. To obtain the full benefit of the battery pack isolation, disconnect the line cord from the power receptacle and wrap the power cord around the feet of the Model 580.

## 2.7.5 Erratic or Noisy Low Resistance Measurements

The Model 580 will normally detect an open test lead or other conditions where a good measurement is not possible (see Figure 2-8). In these cases the unit will display an overload indication (OL).

However, it is possible that extraneous signals or other situations may defeat this feature. A symptom of this problem is usually erratic or noisy readings. To guard against this possibility, follow these steps:

- 
1. Ensure that all four leads are making good contact.
  2. View the resistance reading for several seconds to make sure it is stable.

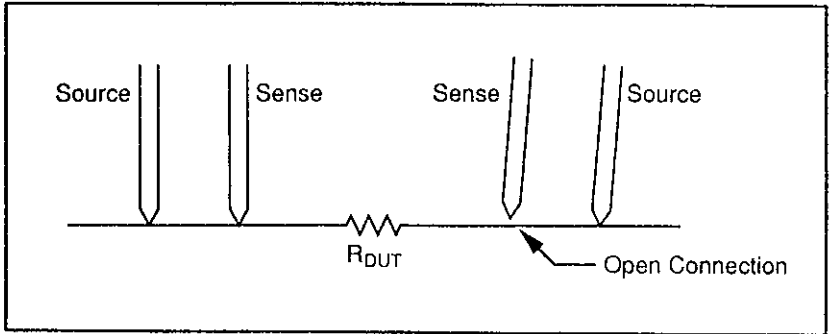

**Figure 2-8. Open Test Leads**

---

# APPENDIX A

## IEEE-488 Commands

Appendix A contains a list of Model 5802 device-dependent commands. They are listed here only as a convenience to the operator. For complete information about the interface, refer to the Model 5802 Instruction Manual.



### IEEE-488 PROGRAMMING

The Model 580's optional IEEE-488 interface (Model 5802) can be ordered with the instrument or added later. With the Model 5802 installed, the Model 580 can be controlled over the IEEE-488 bus. Inclusion of the interface option is apparent by the connector and address switch at the rear panel. The field installable option kit includes a replacement top cover with appropriate access openings on the rear panel.

The following lists all the device-dependent commands available to the Model 580.

### DEVICE-DEPENDENT COMMANDS

POLARITY	
P0	Positive
P1	Negative

DRIVE	
D0	Pulsed (  )
D1	DC (  )

DRY CIRCUIT TEST	
C0	Non-Dry Circuit Test
C1	Dry Circuit Test

RANGES		
	NON-DRY CIRCUIT TEST	DRY CIRCUIT TEST
R0	AUTO	AUTO
R1	200m	200m
R2	2	2
R3	20	20
R4	200	20
R5	2K	20
R6	20K	20
R7	200K	20

OPERATE	
O0	Standby
O1	Operate

RELATIVE	
Z0	Off
Z1	On

<b>STORE CALIBRATION CONSTANTS</b>	
L0	Store calibration constants and exit calibration.

<b>CALIBRATION VALUE</b>	
V+n.nnnnE+nn	Enter calibration. Calibration value equal to the applied resistance.

<b>TRIGGER</b>	
T0	Continuous on Talk
T1	One-shot on Talk
T2	Continuous on GET
T3	One-shot on GET
T4	Continuous on "X"
T5	One-shot on "X"

NOTE: Any IEEE "one-shot" trigger is equivalent to front panel "SINGLE" trigger.

<b>END OR IDENTIFY</b>	
K0	EOI is transmitted on the last byte out.
K1	EOI is not transmitted.

<b>SRQ</b>			
<b>Mnnn</b>	nnn=0 to 255 base 10 N/A = Bit ignored		
	<b>BITS</b>	<b>DATA</b>	<b>ERROR</b>
<b>MSB</b>	7	N/A	N/A
	6	SRQ	SRQ
	5	Normal = 0	Error = 1
	4	Busy	N/A
	3	Reading done	N/A
	2	N/A	Not in remote
	1	N/A	IDDC
<b>LSB</b>	0	Reading overflow	IDDCO

<b>PREFIX</b>	
<b>G0</b>	Send prefix
<b>G1</b>	Do not send prefix

<b>OUTPUT ALTERNATE STRING ON TALK</b>	
<b>U0</b>	Output the status word on the next read

<b>INSTALL IEEE-488 TERMINATOR CHARACTER</b>	
Yc	<p>The (ASCII) byte contains an ASCII character which will be used as the terminator for all data until changed. The power-up default is (CR) (LF).</p> <p>NOTE: ASCII (DEL) indicates no terminator, ASCII (LF) indicates (CR) (LF), and ASCII (CR) indicates (LF) (CR).</p> <p>Illegal Terminators:  All capital letters  All numbers  (blank)  +  —  /  '  .  e</p>

<b>EXECUTE</b>	
X	Implement all DDCs (device-dependent commands) received when an X is received.

---

## DEFAULT CONDITIONS FOR SDC AND DCL MULTILINE COMMANDS

Function	Default Condition
Range	Reflects front panel buttons
Operate	Reflects front panel buttons
Dry circuit test	Reflects front panel buttons
Relative	Off
Calibration	Off
Polarity	Positive
Drive	Pulsed
Trigger	Continuous on talk
EOI	EOI is transmitted on the last byte out
SRQ	No SRQ
Alternate output	Standard output
Prefix	Prefix enabled
Terminator	(CR)(LF)

### NOTE

The primary address is selected with a switch located on the rear of the instrument (see Figure A-1). Although the factory-designated primary address is 25, it can be changed by turning the power off, changing the primary address switch, then turning the power back on to update the IEEE-488 address.



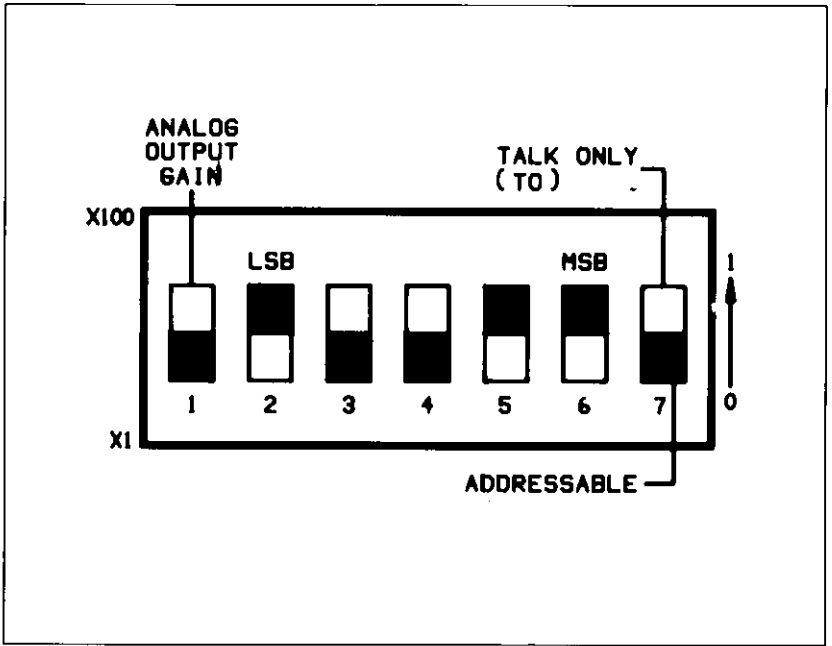

**Figure A-1. Model 5802 Primary Address Switch**

## TALK ONLY OPERATION

Talk only may be used to send data to a listen only device such as a printer. When the Model 580 is in talk only, it ignores commands given over the bus. Talk only is enabled by placing the TO/ADDRESSABLE switch in the TO position and then cycling power to the instrument.

If the LSB of the address is set to 0, then the prefix is not sent; if set to 1, then the prefix is sent.

---

# **APPENDIX B**

## **IEEE-488 Programs**

The following programs are designed to be a simple aid to the user. They are not intended to suit specific needs. Detailed programming information can be found in the Model 5802 Instruction Manual.

---

## **IBM PERSONAL COMPUTER XT OR PC**

### **(Keithley Model 8573A GPIB Interface)**

---

The following program sends a command string to the Model 580 from an IBM PC or XT computer and displays the instrument reading on the CRT. The computer must be equipped with a Keithley Instruments Model 8573A GPIB IEEE interface and the DOS 2.0 operating system. The GPIB software and hardware must be configured per the Model 8573A Instruction Manual.

### **DIRECTIONS**

1. Using the rear panel switches set the primary address of the Model 580 to 25 (11001).
2. With the power off, connect the Model 580 to the IEEE-488 interface installed in the IBM computer.
3. Using the interface software IBCONF program, set up the GPIB.COM handler so that "DEV25" has a primary address of 25. Again, consult the interface board instruction manual for complete details.
4. Place the instrument software disk in the default drive, type BASICA press return, then type LOAD "DECL", and press the return key.
5. Enter the following program into the computer, pressing the return key after each line is typed. Lines 1-6 are part of the DECL program previously loaded and need not be typed in.
6. Run the program and type in the desired command string when prompted. For example: to place the Model 580 into the one shot on talk trigger mode and in the  $2\Omega$  range, type in T1R2X and press the return key.
7. The display will show the Model 580 reading string on the CRT.
8. To exit the program type EXIT and press return.

PROGRAM	COMMENTS
10 CLS	
20 NA\$=' GPIB0' :CALL IBFIND (NA\$,BRD0%)	Find the board number.
30 M580\$=' DEV15' :CALL IBFIND (M580\$,M580%)	Find the 580 number.
40 U%=25:CALL IBPAD (M580%,U%)	Change to primary address 25.
50 U%=1:CALL IBSRE (BRD0%,U%)	Set REN true.
60 INPUT 'COMMAND' :CMD\$	Prompt for command string.
70 IF CMD\$='EXIT' THEN 140	See if program is to be halted.
80 IF CMD\$='' THEN 60	If null command string go back and get another.
90 CALL IBWRT(M580%,CMD\$)	Address 580 to listen and send command string.
100 RD\$=SPACE\$(50)	Assign reading input buffer.
105 CALL IBRD (M580%, RD\$)	
110 RD\$=LEFT\$(RD\$, IBCNT%)	Trim string to proper size.
120 PRINT RD\$	Display the reading on the CRT.
130 GOTO 60	Repeat
140 U%=0:CALL IBONL (BRD0%,U%)	Close the instrument file.
150 CALL IBONL(M580%,U%)	Close the board file.
160 END	

NOTE: Lines 1-6 of this program need not be typed in. They are contained on the floppy disk. When the command LOAD"DECL" is entered, these lines are already there.

NOTE: If conversion to numeric variable is desired, change lines 110 and 120 as follows:

```
110 RD=VAL(MID$(RD$,5,14))
120 PRINT RD
```

---

## **APPLE II (APPLE Interface)**

---

The following program obtains one reading from the Model 580 Microohmmeter and displays the reading on the APPLE II screen, using an APPLE IEEE-488 interface.

### **DIRECTIONS**

1. Using the rear panel switches, set the primary address of the Model 580 to 25 (11001).
2. Connect the Model 580 to the APPLE II and APPLE IEEE-488 interface.
3. Enter the following program using the RETURN key after each line.
4. Type in RUN and press the RETURN key.
5. The display will read "TEST SETUP".
6. To program the Model 580 to the 2 $\Omega$  range and take a reading, type in R2TX and press the RETURN key.

NOTE: This program assumes that the APPLE interface card is in slot #3.

---

PROGRAM	COMMENTS
10 DIM A\$(20), B\$(20)	Dimension data string.
20 Z#=CHR\$(26)	Terminator
30 INPUT "TEST SETUP?"; B#	Enter programming command. Example: 2Ω range=R2T1X
40 PR#3	Send output to IEEE bus.
50 IN#3	Get input from IEEE bus.
60 PRINT "RA"	Turn remote on.
70 PRINT "WT9"; Z#; B#	Write B\$ to 580.
80 PRINT "LF1"	Linefeed on.
90 PRINT "RDY"; Z#; INPUT " "; A#	Read data from 580.
100 PRINT "UT"	
110 PR#0	Send output to CRT.
120 IN#0	Get input from keyboard.
130 PRINT A#	
140 GO TO 30	Repeat

---

NOTE: If conversion to numeric variable is needed, add the following:

```
134 A=VAL(MID$(A#,5,11))
136 PRINT A
```

---

## HP-85

---

The following program obtains one reading from the Model 580 Micro-ohmmeter and displays the reading on the HP-85 CRT screen, using the 82937A GPIB interface and an I/O ROM.

### DIRECTIONS

1. Using the rear panel switches set the primary address on the Model 580 to 25 (11001).
2. Connect the Model 580 to the HP 82937A IEEE interface.
3. Enter the following program using the END LINE key after each line is typed.
4. Press the RUN key.
5. The display will read "TEST SETUP".
6. To program the Model 580 to the  $2\Omega$  range and take a reading, type in R211X and press the END LINE key.

PROGRAM	COMMENTS
10 REMOTE 725	Set to remote.
20 DISP ' ' TEST SETUP' '	Prompt for test setup.
30 INPUT B#	
40 OUTPUT 725; B#	Prompt the 580.
50 ENTER 725; A#	Get data from 580.
60 DISP A#	
70 GO TO 20	Repeat
80 END	

NOTE: If conversion to numeric variable is needed, change line 60 as follows:

```
60 DISP VAL(A#[5])
```

---

## HP 9825A

---

The following program obtains one reading from the Model 580 Microohmmeter and displays the reading on the HP-9825A using a 98034A HPIB interface and a 9872A extended I/O ROM.

### DIRECTIONS

1. Using the rear panel switches set the primary address of the Model 580 to 25 (11001).
2. Connect the Model 580 to HP 9825A and 98034A HPIB interface.
3. Enter the following program using the STORE key after each line is typed. Line numbers are automatically assigned by the 9825A.
4. Press the RUN key.
5. The display will read "TEST SETUP".
6. To program the Model 580 to the  $2\Omega$  range and take a reading, type in R2TIX and press the CONTINUE key.

PROGRAM	COMMENTS
0 dim A#[20], B#[20]	Dimension data strings.
1 dev '580', 725	Define Model 580 address 25.
2 rem '580'	Set to remote.
3 ent 'TEST SETUP', B#	Enter programming command. (Example: $2\Omega$ range=R2TIX)
4 wrt '580', B#	Output program command to Model 580 via IEEE bus.
5 red '580', A#	Read data from Model 580 via IEEE bus.
6 prt A#	Print data on hard copy printer.
7 gto 3	Repeat.

NOTE: If conversion to numeric variable is desired, omit lines 6 and 7 and substitute:

6 'e' → A#[13, 13]; flt5	Convert to numeric variable.
7 prt val(A#[5])	
8 gto 3	Repeat



---

## HP 9816

---

The following program sends a command string to the Model 580 Microohmmeter, reads data and displays the data on the HP 9816 CRT, using BASIC 2.0.

### DIRECTIONS

1. Using the rear panel switches set the primary address of the Model 580 to 25 (11001).
2. With the power off, connect the Model 580 to the HP 9816 and HP 82937A GPIB interface.
3. Type EDIT and press the EXEC key.
4. Enter the following program using the ENTER key after each line is typed.
5. Press the HP 9816 RUN key.
6. The display will read "TEST SETUP".
7. To program the Model 580 to the 2 $\Omega$  range and to take a reading type in R2TLX and press the ENTER key.

PROGRAM	COMMENTS
10 REMOTE 725	Set to remote.
20 INPUT "TEST SETUP", A\$	Prompt for test setup.
30 OUTPUT 725; A\$	Send command string to 580.
40 ENTER 725; B\$	Get data string from 580.
50 PRINT B\$	Display data string.
60 GO TO 20	Repeat
70 END	

NOTE: If conversion to numeric variable is desired, change lines 40 and 50 as follows:

```
40 ENTER 725; B
50 PRINT B
```

---

## DEC LSI 11

---

The following program obtains one reading from the Model 580 Micro-ohmmeter and displays the reading on the DEC LSI 11 microcomputer CRT terminal. The LSI 11 must be configured with 16K words of RAM and an IBV 11 IEEE interface. The software must be configured with IB software as well as FORTRAN and the RT 11 operating system.

### DIRECTIONS

1. Using the rear panel switches set the primary address on the Model 580 to 25 (11001).
2. Connect the Model 580 to the IBV 11 IEEE cable.
3. Enter the following program, using the editor under RT 11 and the name IEEE.FOR.
4. Compile using the FORTRAN compiler as follows: FORTRAN IEEE.
5. Link with the system and IB libraries as follows: LINK IEEE,IBLIB.
6. Type RUN IEEE and press the RETURN key.
7. The display will read "ENTER ADDRESS".
8. Type in 25 and press the RETURN key.
9. The display will read "TEST SETUP".
10. To program the Model 580 to the 2 $\Omega$  range and take a reading, type in R2TLX and press the RETURN key.

---

**PROGRAM****COMMENTS**

---

```
    INTEGER*2 PRIADR
    LOGICAL*1MSG(80), INPUT(80)
    DO 2 I = 1, 10
    CALL IBSTER(I, 0)
2 CONTINUE
    CALL IBSTER(15, 5)
    CALL IBTMO(120)
    CALL IBTERM(''10)
    CALL IBREN
4 TYPE 5
5 FORMAT(1X, 'ENTER
  ADDRESS:', #) ACCEPT 10,
  PRIADR
10 FORMAT(12)
12 TYPE 15
15 FORMAT(1X, 'TEST SETUP:', #)
    CALL GETSTR(5, MSG, 72)
    CALL IBSEOI(MSG, -1,
    PRIADR)
18 I=IBRECU(INPUT, 80, PRIADR)
    INPUT(I+1) = 0
    CALL PUTSTR(7, INPUT, '0')
    CALL IBUNT
    GO TO 12
END
```

Turn off errors.

Allow 5 error 15's.  
Allow 1 sec bus timeout.  
Set LF as terminator.  
Turn remote on.

Input the address 25.

Prompt for the test setup.  
Get the test setup.  
Program the 580.

Untalk the 580.  
Repeat

---

---

## PET/CBM 2001

---

The following program obtains one reading from the Model 580 Micro-ohmmeter and displays the reading on the PET/CBM 2001 screen.

### DIRECTIONS

1. Using the rear panel switches set the primary address on the Model 580 to 25 (11001).
2. Connect the Model 580 to the PET/CBM 2001 IEEE interface.
3. Enter the following program using the RETURN key after each line.
4. Type RUN and depress the RETURN key.
5. The display will read "TEST SETUP".
6. To program the Model 580 to the  $2\Omega$  range and take a reading, type in R2TX and press the RETURN key.

PROGRAM	COMMENTS
10 OPEN 6,25	Open file 6, primary address 25.
20 INPUT "TEST SETUP";B#	Enter programming command. (Example: $2\Omega$ range = R2TX).
30 PRINT#6,B#	Output to IEEE bus.
40 INPUT#6,A#	Read data from Model 580 via IEEE bus.
50 IF ST = 2 THEN 40	If time out, input again.
60 PRINT A#	Print data.
70 GO TO 20	Repeat

NOTE: If conversion to numeric variable is desired, omit line 70 and type the following:

70 A = VAL(MID\$(A#,5,15))	Convert to numeric variable.
80 PRINT "A=";A	
90 GO TO 20	Repeat

# SPECIFICATIONS/5802

---

## ANALOG OUTPUT

---

**LEVEL:** 1V = 10,000 counts on X1 gain.

1V = 100 counts on X100 gain.

Maximum output voltage =  $\pm 4V$ .

**ACCURACY:**  $\pm(0.25\%$  of displayed reading +2mV). In X100, 2mV output = 0.2 displayed counts.

**RESPONSE TIME:** Follows display conversion rate.

**OUTPUT RESISTANCE:** 1000 $\Omega$ .

**ISOLATION:** ANALOG OUTPUT LO is connected to IEEE COMMON. Maximum common mode voltage from IEEE COMMON to earth ground is 30V rms at dc, 50 or 60Hz.

## IEEE-488 BUS IMPLEMENTATION

---

**MULTILINE COMMANDS:** DCL, SDC, GET, GTL, UNT, UNL, SPE, SPD, LLO.

**UNILINE COMMANDS:** IFC, REN, EOI, SRQ, ATN.

**INTERFACE FUNCTIONS:** SH1, AH1, T5, TE0, L4, LE0, SR1, RL0, PP0, DC1, DT1, C0, E1.

**PROGRAMMABLE PARAMETERS:** Range, DRY CIRCUIT TEST, Operate, RELative, POLARITY, DRIVE, TRIGger, Calibration, EOI, SRQ, Status, Data Format, Terminator.

**DEVICE-DEPENDENT COMMANDS:**

**RANGE:**

	NON DRY CIRCUIT TEST	DRY CIRCUIT TEST
R0	Auto	Auto
R1	200m $\Omega$	200m $\Omega$
R2	2 $\Omega$	2 $\Omega$
R3	20 $\Omega$	20 $\Omega$
R4	200 $\Omega$	20 $\Omega$
R5	2k $\Omega$	20 $\Omega$
R6	20k $\Omega$	20 $\Omega$
R7	200k $\Omega$	20 $\Omega$

**RELATIVE:**

Z0 = REL off

Z1 = REL on

**OPERATE:**

O0 = STBY (Standby)

O1 = OPR (Operate)

**POLARITY:**

P0 = POL +

P1 = POL -

**DRIVE:**D0 = DRIVE  $\square$  (pulsed)

D1 = DRIVE --- (dc)

**DRY CIRCUIT TEST:**

C0 = NON DRY CIRCUIT TEST

C1 = DRY CIRCUIT TEST

**DIGITAL CALIBRATION:**V  $\pm$  n.nnnnE  $\pm$  nn = enter calibration value.**STORE:**

L0 = Store calibration constants.

**TRIGGER:**

T0 = Continuous on Talk

T1 = One-shot on Talk

T2 = Continuous on GET

T3 = One-shot on GET

T4 = Continuous on X

T5 = One-shot on X

**EXECUTE:**

X = Execute device-dependent commands.

**EOI:**

K0 = EOI Enabled

K1 = EOI Disabled

**STATUS WORD:**

U0 = Output status word.

**DATA FORMAT:**

G0 = Readings and status word with prefix.

G1 = Readings and status word without prefix.

**SRQ:**

M0 = Clear SRQ Data Mask

M1 = Reading Overflow

M8 = Reading Done

M9 = Reading Done or Reading Overflow

M16 = Busy

M17 = Busy or Reading Overflow

M24 = Busy or Reading Done

M25 = Busy, Reading Done or Reading Overflow

M32 = Clear SRQ Error Mask

M33 = IDDCO

M34 = IDDC

M35 = IDDC or IDDCO

M36 = Not in Remote

M37 = Not in Remote or IDDCO

M38 = Not in Remote or IDDC

M39 = Not in Remote, IDDC or IDDCO

**TERMINATOR:**

Y(ASCII) = ASCII Character

Y(LF) = CR LF

Y(CR) = LF CR

Y(DEL) = None

**TIME FROM TRIGGER TO FIRST BYTE OUT:** 350ms to 500ms.**ADDRESS MODES:** Talk Only, Addressable.

# DATA FORMAT AND STATUS BYTE OUTPUT

---

## DATA FORMAT:

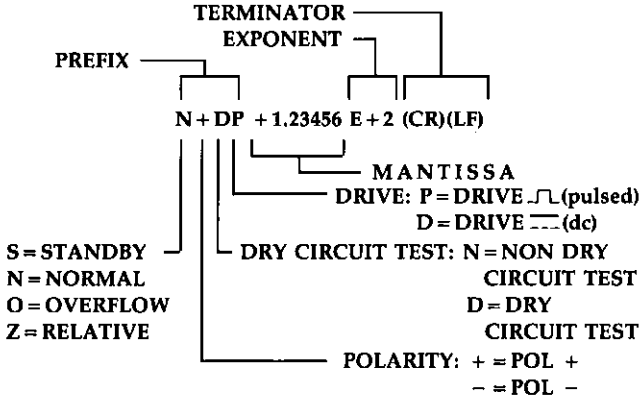

## STATUS BYTE OUTPUT:

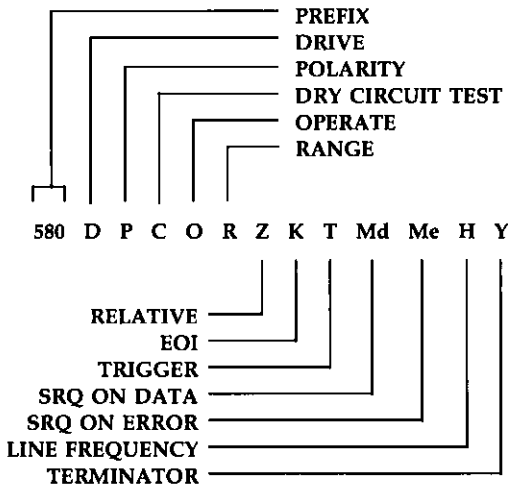



# Service Form

Model No. \_\_\_\_\_ Serial No. \_\_\_\_\_ Date \_\_\_\_\_

Name and Telephone No. \_\_\_\_\_

Company \_\_\_\_\_

List all control settings, describe problem and check boxes that apply to problem. \_\_\_\_\_

- |  |  |  |
|--|--|--|
| <input type="checkbox"/> Intermittent            | <input type="checkbox"/> Analog output follows display   | <input type="checkbox"/> Particular range or function bad; specify _____ |
| <input type="checkbox"/> IEEE failure            | <input type="checkbox"/> Obvious problem on power-up     | <input type="checkbox"/> Batteries and fuses are OK                      |
| <input type="checkbox"/> Front panel operational | <input type="checkbox"/> All ranges or functions are bad | <input type="checkbox"/> Checked all cables                              |

Display or output (check one)

- |   |  |
|---|--|
| <input type="checkbox"/> Drifts           | <input type="checkbox"/> Unable to zero                      |
| <input type="checkbox"/> Unstable         | <input type="checkbox"/> Will not read applied input         |
| <input type="checkbox"/> Overload         |  |
| <input type="checkbox"/> Calibration only | <input type="checkbox"/> Certificate of calibration required |
| <input type="checkbox"/> Data required    |  |

(attach any additional sheets as necessary)

Show a block diagram of your measurement system including all instruments connected (whether power is turned on or not). Also, describe signal source.

Where is the measurement being performed? (factory, controlled laboratory, out-of-doors, etc.) \_\_\_\_\_

What power line voltage is used? \_\_\_\_\_ Ambient temperature? \_\_\_\_\_ °F

Relative humidity? \_\_\_\_\_ Other? \_\_\_\_\_

Any additional information. (If special modifications have been made by the user, please describe.) \_\_\_\_\_

Be sure to include your name and phone number on this service form.



Specifications are subject to change without notice.

All Keithley trademarks and trade names are the property of Keithley Instruments, Inc. All other trademarks and trade names are the property of their respective companies.



**Keithley Instruments, Inc.** 28775 Aurora Road • Cleveland, Ohio 44139 • 440-248-0400 • Fax: 440-248-6168  
1-888-KEITHLEY (534-8453) [www.keithley.com](http://www.keithley.com)