

Model 2601B-PULSE System SourceMeter Instrument

Reference Manual

2601B-PULSE-901-01 Rev. A April 2020



2601B-PULSE-901-01A

Model 2601B-PULSE
System SourceMeter Instrument
Reference Manual

© 2020, Keithley Instruments, LLC

Cleveland, Ohio, U.S.A.

All rights reserved.

Any unauthorized reproduction, photocopy, or use of the information herein, in whole or in part, without the prior written approval of Keithley Instruments, LLC, is strictly prohibited.

These are the original instructions in English.

TSP®, TSP-Link®, and TSP-Net® are trademarks of Keithley Instruments, LLC. All Keithley Instruments product names are trademarks or registered trademarks of Keithley Instruments, LLC.

Other brand names are trademarks or registered trademarks of their respective holders.

The Lua 5.0 software and associated documentation files are copyright © 1994 - 2015, Lua.org, PUC-Rio. You can access terms of license for the Lua software and associated documentation at the Lua licensing site (<https://www.lua.org/license.html>).

Microsoft, Visual C++, Excel, and Windows are either registered trademarks or trademarks of Microsoft Corporation in the United States and/or other countries.

Document number: 2601B-PULSE-901-01A April 2020

The following safety precautions should be observed before using this product and any associated instrumentation. Although some instruments and accessories would normally be used with nonhazardous voltages, there are situations where hazardous conditions may be present.

This product is intended for use by personnel who recognize shock hazards and are familiar with the safety precautions required to avoid possible injury. Read and follow all installation, operation, and maintenance information carefully before using the product. Refer to the user documentation for complete product specifications.

If the product is used in a manner not specified, the protection provided by the product warranty may be impaired.

The types of product users are:

Responsible body is the individual or group responsible for the use and maintenance of equipment, for ensuring that the equipment is operated within its specifications and operating limits, and for ensuring that operators are adequately trained.

Operators use the product for its intended function. They must be trained in electrical safety procedures and proper use of the instrument. They must be protected from electric shock and contact with hazardous live circuits.

Maintenance personnel perform routine procedures on the product to keep it operating properly, for example, setting the line voltage or replacing consumable materials. Maintenance procedures are described in the user documentation. The procedures explicitly state if the operator may perform them. Otherwise, they should be performed only by service personnel.

Service personnel are trained to work on live circuits, perform safe installations, and repair products. Only properly trained service personnel may perform installation and service procedures.

Keithley products are designed for use with electrical signals that are measurement, control, and data I/O connections, with low transient overvoltages, and must not be directly connected to mains voltage or to voltage sources with high transient overvoltages. Measurement Category II (as referenced in IEC 60664) connections require protection for high transient overvoltages often associated with local AC mains connections. Certain Keithley measuring instruments may be connected to mains. These instruments will be marked as category II or higher.

Unless explicitly allowed in the specifications, operating manual, and instrument labels, do not connect any instrument to mains.

Exercise extreme caution when a shock hazard is present. Lethal voltage may be present on cable connector jacks or test fixtures. The American National Standards Institute (ANSI) states that a shock hazard exists when voltage levels greater than 30 V RMS, 42.4 V peak, or 60 VDC are present. A good safety practice is to expect that hazardous voltage is present in any unknown circuit before measuring.

Operators of this product must be protected from electric shock at all times. The responsible body must ensure that operators are prevented access and/or insulated from every connection point. In some cases, connections must be exposed to potential human contact. Product operators in these circumstances must be trained to protect themselves from the risk of electric shock. If the circuit is capable of operating at or above 1000 V, no conductive part of the circuit may be exposed.

Do not connect switching cards directly to unlimited power circuits. They are intended to be used with impedance-limited sources. NEVER connect switching cards directly to AC mains. When connecting sources to switching cards, install protective devices to limit fault current and voltage to the card.

Before operating an instrument, ensure that the line cord is connected to a properly-grounded power receptacle. Inspect the connecting cables, test leads, and jumpers for possible wear, cracks, or breaks before each use.

When installing equipment where access to the main power cord is restricted, such as rack mounting, a separate main input power disconnect device must be provided in close proximity to the equipment and within easy reach of the operator.

For maximum safety, do not touch the product, test cables, or any other instruments while power is applied to the circuit under test. ALWAYS remove power from the entire test system and discharge any capacitors before: connecting or disconnecting cables or jumpers, installing or removing switching cards, or making internal changes, such as installing or removing jumpers.

Do not touch any object that could provide a current path to the common side of the circuit under test or power line (earth) ground. Always make measurements with dry hands while standing on a dry, insulated surface capable of withstanding the voltage being measured.

For safety, instruments and accessories must be used in accordance with the operating instructions. If the instruments or accessories are used in a manner not specified in the operating instructions, the protection provided by the equipment may be impaired.

Do not exceed the maximum signal levels of the instruments and accessories. Maximum signal levels are defined in the specifications and operating information and shown on the instrument panels, test fixture panels, and switching cards.

When fuses are used in a product, replace with the same type and rating for continued protection against fire hazard.

Chassis connections must only be used as shield connections for measuring circuits, NOT as protective earth (safety ground) connections.

If you are using a test fixture, keep the lid closed while power is applied to the device under test. Safe operation requires the use of a lid interlock.

If a  screw is present, connect it to protective earth (safety ground) using the wire recommended in the user documentation.

The  symbol on an instrument means caution, risk of hazard. The user must refer to the operating instructions located in the user documentation in all cases where the symbol is marked on the instrument.

The  symbol on an instrument means warning, risk of electric shock. Use standard safety precautions to avoid personal contact with these voltages.

The  symbol on an instrument shows that the surface may be hot. Avoid personal contact to prevent burns.

The  symbol indicates a connection terminal to the equipment frame.

If this  symbol is on a product, it indicates that mercury is present in the display lamp. Please note that the lamp must be properly disposed of according to federal, state, and local laws.

The **WARNING** heading in the user documentation explains hazards that might result in personal injury or death. Always read the associated information very carefully before performing the indicated procedure.

The **CAUTION** heading in the user documentation explains hazards that could damage the instrument. Such damage may invalidate the warranty.

The **CAUTION** heading with the  symbol in the user documentation explains hazards that could result in moderate or minor injury or damage the instrument. Always read the associated information very carefully before performing the indicated procedure. Damage to the instrument may invalidate the warranty.

Instrumentation and accessories shall not be connected to humans.

Before performing any maintenance, disconnect the line cord and all test cables.

To maintain protection from electric shock and fire, replacement components in mains circuits — including the power transformer, test leads, and input jacks — must be purchased from Keithley. Standard fuses with applicable national safety approvals may be used if the rating and type are the same. The detachable mains power cord provided with the instrument may only be replaced with a similarly rated power cord. Other components that are not safety-related may be purchased from other suppliers as long as they are equivalent to the original component (note that selected parts should be purchased only through Keithley to maintain accuracy and functionality of the product). If you are unsure about the applicability of a replacement component, call a Keithley office for information.

Unless otherwise noted in product-specific literature, Keithley instruments are designed to operate indoors only, in the following environment: Altitude at or below 2,000 m (6,562 ft); temperature 0 °C to 50 °C (32 °F to 122 °F); and pollution degree 1 or 2.

To clean an instrument, use a cloth dampened with deionized water or mild, water-based cleaner. Clean the exterior of the instrument only. Do not apply cleaner directly to the instrument or allow liquids to enter or spill on the instrument. Products that consist of a circuit board with no case or chassis (e.g., a data acquisition board for installation into a computer) should never require cleaning if handled according to instructions. If the board becomes contaminated and operation is affected, the board should be returned to the factory for proper cleaning/servicing.

Safety precaution revision as of June 2017.

Table of contents

Introduction	1-1
Welcome	1-1
Extended warranty	1-1
Contact information	1-1
Customer documentation	1-2
Product software and drivers	1-2
Capabilities and features.....	1-3
Power and environmental ratings	1-4
Installation	2-1
Introduction	2-1
2601B-PULSE weights and dimensions	2-1
Preparing the instrument for rack mounting	2-5
2601B-P-INT dimensions	2-6
Installing the 2601B-P-INT	2-6
Cooling vents	2-8
Turning the instrument on and off	2-9
Placing a 2601B-PULSE in standby	2-10
Warmup period.....	2-10
Line frequency configuration	2-11
Remote communications interfaces	2-11
Remote interface connections	2-12
Output queue	2-13
USB communications	2-13
LAN communications	2-15
GPIB operation.....	2-29
RS-232 interface operation	2-32
Software components for applications and instrument drivers	2-36
Keithley I/O layer.....	2-39
General bus commands	2-40
Using the interlock.....	2-42
Interlock operation.....	2-43
System information	2-46
Instrument description	3-1
Controls, indicators, and connectors.....	3-1
Front panel.....	3-1
Rear panel.....	3-5
Menu overview	3-7
Menu navigation.....	3-7
Menu trees	3-7
Setting values.....	3-11

Beeper	3-13
Displayed error and status messages.....	3-13
Display operations.....	3-14
Display mode	3-14
Display functions and attributes	3-15
Display features	3-15
Display messages	3-17
Input prompting	3-21
Indicators.....	3-23
Local lockout	3-24
Load test menu	3-24
Running a test from the front panel	3-26
Key-press codes	3-26
USB storage overview.....	3-28
Connecting the USB flash drive	3-28
File system navigation.....	3-29
Sourcing and measuring	4-1
Operation overview	4-1
Limits.....	4-2
Setting the limit.....	4-3
Pulser protection levels	4-4
Sink operation	4-5
DUT test connections.....	4-6
FORCE and SENSE connectors	4-8
2-wire local sensing connections.....	4-10
4-wire remote sensing connections.....	4-10
Connections for pulser operation	4-11
Contact check connections	4-12
Combining SMU outputs	4-14
Guarding and shielding	4-20
Test fixture	4-23
DUT connection settings	4-25
Sense mode selection.....	4-25
Output-off modes	4-26
Output-off function.....	4-27
Output-off limits (compliance).....	4-28
Remote programming output-off states quick reference	4-29
Basic source-measure procedure	4-30
Front-panel source-measure procedure.....	4-30
Remote source-measure commands	4-31
Pulser operation.....	4-33
Operation considerations for the ADC	4-41
Autozero.....	4-41
NPLC caching	4-42
Triggering in local mode.....	4-42
Configuring trigger attributes in local mode	4-44
Front-panel triggering example	4-44
Configuring for measure-only tests using the MODE key.....	4-45
Voltmeter and ammeter measurements.....	4-45
Ohms measurements.....	4-46

Ohms ranging.....	4-46
Basic ohms measurement procedure.....	4-46
Ohms sensing	4-48
Power measurements	4-49
Basic power measurement procedure.....	4-50
Power measurements using the remote interface	4-50
Saved setups	4-51
Saving user setups.....	4-51
Recalling a saved setup	4-52
Start-up configuration.....	4-53
Saving user setups from a remote interface.....	4-53
Range.....	4-54
Available ranges.....	4-54
Maximum source values and readings	4-55
Measure auto delay.....	4-55
Manual ranging	4-55
Ranging limitations.....	4-56
Autoranging.....	4-56
Low range limits	4-56
Range considerations	4-57
Range commands	4-57
Range programming example	4-58
Digits	4-59
Setting display resolution from the front panel	4-59
Setting display resolution from a remote interface	4-59
Speed when the pulser is disabled	4-60
Setting speed	4-60
Sweep operation	4-61
Linear staircase sweeps.....	4-64
Logarithmic staircase sweeps	4-65
List sweeps	4-68
Pulse sweeps.....	4-69
Configuring and running sweeps.....	4-71
Sweeping using factory scripts.....	4-73
Sweep programming examples.....	4-74
Relative offset	4-75
Front panel relative offset.....	4-75
Remote relative offset programming	4-76
Filters.....	4-77
Filter types.....	4-77
Response time	4-78
Front panel filter control	4-78
Remote filter programming.....	4-79
High-capacitance mode	4-80
Understanding high-capacitance mode.....	4-80
Enabling high-capacitance mode	4-82
Reading buffers.....	5-1
Overview	5-1
Front-panel reading buffer control.....	5-1
Reading buffer options	5-1
Configuring reading buffers	5-2
Appending or overwriting existing reading buffers.....	5-3

Storage operation.....	5-3
Saving reading buffers	5-4
Recalling readings.....	5-5
Remote reading buffer programming	5-6
Dedicated reading buffer designations	5-6
Reading buffer commands	5-6
Buffer status	5-12
Dynamic reading buffers	5-12
Buffer examples	5-12
Triggering	6-1
Triggering	6-1
Remote triggering overview	6-1
Using the trigger model	6-3
SMU event detectors.....	6-8
Clearing SMU event detectors	6-8
Using the TRIG key to trigger a sweep	6-8
Using trigger events to start actions on trigger objects	6-10
Action overruns	6-10
Digital I/O port and TSP-Link synchronization lines.....	6-11
Mode	6-11
Pulsewidth.....	6-11
Trigger configuration on hardware lines	6-11
Action overruns on hardware lines	6-13
Timers	6-13
Timer attributes	6-13
Triggering a timer	6-14
Timer action overruns	6-15
Using timers to perform pulsed sweeps	6-15
Event blenders	6-19
Event blender modes	6-20
Assigning input trigger events	6-20
Action overruns	6-20
LAN triggering overview	6-20
Understanding hardware value and pseudo line state	6-21
Understanding LXI trigger event designations	6-22
Generating LXI trigger packets.....	6-22
Command interface triggering.....	6-22
Trigger generator	6-23
Manual triggering	6-23
Interactive triggering.....	6-23
Detecting trigger events using the wait() function.....	6-24
Using the assert function to generate output triggers.....	6-24
Using the release function of the hardware lines.....	6-25
Using the set function to bypass SMU event detectors	6-25
Event detector overruns	6-26
Examples using interactive triggering.....	6-26
Hardware trigger modes.....	6-28
Falling edge trigger mode	6-28
Rising edge master trigger mode	6-29
Rising edge acceptor trigger mode	6-30

Either edge trigger mode.....	6-31
Understanding synchronous triggering modes	6-32
Synchronous master trigger mode (SynchronousM)	6-32
Synchronous acceptor trigger mode (SynchronousA).....	6-34
Synchronous trigger mode	6-35
Digital I/O	6-36
Port configuration	6-36
Digital I/O configuration.....	6-37
Controlling digital I/O lines.....	6-37
TSP-Link trigger lines.....	6-39
Theory of operation	7-1
Analog-to-digital converters	7-1
Source-measure concepts	7-1
Limit principles	7-2
Power equations	7-2
Duty cycle with the pulser disabled	7-2
Duty cycle with the pulser enabled.....	7-4
Optimizing apertures and filters for the 1 MS/s sample rate.....	7-5
Operating boundaries.....	7-6
Basic circuit configurations.....	7-19
Guard	7-24
Measurement settling time considerations.....	7-26
Programming example for controlling settling time delay	7-27
Effects of load on current source settling time	7-27
Creating pulses with the 2601B-PULSE SMU	7-28
Pulse rise and fall times	7-28
SMU pulse width	7-30
Maintenance	8-1
Introduction	8-1
Displaying the serial number.....	8-1
Line fuse replacement.....	8-2
Front-panel tests	8-3
Keys test	8-3
Display patterns test.....	8-4
Upgrading the firmware	8-5
Using TSB to upgrade the firmware	8-6
Introduction to TSP operation.....	9-1
Introduction to TSP operation	9-1
Controlling the instrument by sending individual command messages	9-1
Queries	9-3
Information on scripting and programming	9-3
About TSP commands	9-3
Beeper control.....	9-3
Bit manipulation and logic operations.....	9-4
Calibration	9-5
Data queue.....	9-5

Digital I/O	9-6
Display	9-6
Error queue	9-7
Event log	9-7
File I/O	9-7
GPIB	9-8
Instrument identification	9-9
LAN and LXI	9-9
Miscellaneous	9-10
Parallel script execution	9-10
Queries and response messages	9-11
Reading buffer	9-11
Reset	9-12
RS-232	9-12
Saved setups	9-12
Scripting	9-12
SMU	9-13
Status model	9-15
Time	9-16
Triggering	9-16
TSP-Link	9-18
TSP-Net	9-18
Userstrings	9-19
Factory scripts	9-19
Running a factory script	9-20
Retrieving and modifying a factory script listing	9-21
KISweep factory script	9-21
KHighC factory script	9-21
KIParlib factory script	9-22
KISavebuffer factory script	9-22

Instrument programming..... 10-1

Fundamentals of scripting for TSP	10-1
What is a script?	10-2
Runtime and nonvolatile memory storage of scripts	10-2
What can be included in scripts?	10-2
Commands that cannot be used in scripts	10-3
Manage scripts	10-3
Working with scripts in nonvolatile memory	10-10
Interactive script example	10-12
Fundamentals of programming for TSP	10-13
What is Lua?	10-13
Lua basics	10-13
Standard libraries	10-27
Programming example	10-30
Test Script Builder	10-30
Installing the TSB software	10-30
Using Test Script Builder (TSB)	10-31
Project navigator	10-32
Script editor	10-33
Outline view	10-33
Programming interaction	10-34
Password management	10-34
Setting the password from a command or web interface	10-34
Unlocking the remote interface	10-35
Resetting the password	10-35

Advanced scripting for TSP	10-36
Global variables and the script.user.scripts table	10-36
Create a script using the script.new() command	10-37
Rename a script	10-40
Retrieve a user script	10-42
Delete user scripts from the instrument	10-43
Restore a script to the runtime environment	10-44
Memory considerations for the runtime environment	10-44
TSP-Link system expansion interface	10-45
Master and subordinates	10-46
TSP-Link nodes	10-46
Connections	10-47
Initialization	10-47
Resetting the TSP-Link network	10-48
Using the expanded system	10-49
TSP advanced features	10-51
Using groups to manage nodes on TSP-Link network	10-53
Running simultaneous test scripts	10-54
Using the data queue for real-time communication	10-56
Copying test scripts across the TSP-Link network	10-56
Removing stale values from the reading buffer cache	10-57
TSP-Net	10-58
TSP-Net capabilities	10-58
Using TSP-Net with any ethernet-enabled instrument	10-58
TSP-Net compared to TSP-Link to communicate with TSP-enabled devices	10-60
TSP-Net instrument commands: General device control	10-61
TSP-Net instrument commands: TSP-enabled device control	10-61
Example: Using tspnet commands	10-62
TSP command reference	11-1
TSP command programming notes	11-1
Placeholder text	11-1
Syntax rules	11-2
Time and date values	11-2
Settings ignored when the pulser is enabled	11-3
Settings ignored when the pulser is disabled	11-3
Using the TSP command reference	11-4
Command name and summary table	11-4
Command usage	11-6
Command details	11-6
Example section	11-7
Related commands and information	11-7
TSP commands	11-8
beeper.beep()	11-8
beeper.enable	11-8
bit.bitand()	11-9
bit.bitor()	11-10
bit.bitxor()	11-10
bit.clear()	11-11
bit.get()	11-12
bit.getfield()	11-13
bit.set()	11-14
bit.setfield()	11-15
bit.test()	11-16
bit.toggle()	11-17
bufferVar.appendmode	11-17

bufferVar.basetimestamp	11-18
bufferVar.cachemode	11-19
bufferVar.capacity	11-20
bufferVar.clear()	11-21
bufferVar.clearcache()	11-22
bufferVar.collectsourcevalues	11-23
bufferVar.collecttimestamps	11-24
bufferVar.fillcount	11-25
bufferVar.fillmode	11-25
bufferVar.measurefunctions	11-26
bufferVar.measureranges	11-27
bufferVar.n	11-28
bufferVar.readings	11-29
bufferVar.sourcefunctions	11-30
bufferVar.sourceoutputstates	11-31
bufferVar.sourceranges	11-32
bufferVar.sourcevalues	11-33
bufferVar.statuses	11-34
bufferVar.timestampresolution	11-36
bufferVar.timestamps	11-37
dataqueue.add()	11-38
dataqueue.CAPACITY	11-39
dataqueue.clear()	11-39
dataqueue.count	11-40
dataqueue.next()	11-41
delay()	11-42
digio.readbit()	11-42
digio.readport()	11-43
digio.trigger[N].assert()	11-44
digio.trigger[N].clear()	11-44
digio.trigger[N].EVENT_ID	11-45
digio.trigger[N].mode	11-45
digio.trigger[N].overrun	11-47
digio.trigger[N].pulsewidth	11-47
digio.trigger[N].release()	11-48
digio.trigger[N].reset()	11-49
digio.trigger[N].stimulus	11-50
digio.trigger[N].wait()	11-51
digio.writebit()	11-52
digio.writeport()	11-52
digio.writeprotect	11-53
display.clear()	11-54
display.getannunciators()	11-54
display.getcursor()	11-56
display.getlastkey()	11-57
display.gettext()	11-58
display.inputvalue()	11-59
display.loadmenu.add()	11-61
display.loadmenu.catalog()	11-62
display.loadmenu.delete()	11-63
display.locallockout	11-63
display.menu()	11-64
display.numpad	11-65
display.prompt()	11-65
display.screen	11-67
display.sendkey()	11-67
display.smua.digits	11-68
display.setcursor()	11-69
display.settext()	11-70
display.smua.limit.func	11-71
display.smua.measure.func	11-71

display.trigger.clear()	11-72
display.trigger.EVENT_ID	11-73
display.trigger. overrun	11-73
display.trigger.wait()	11-74
display.waitkey()	11-74
errorqueue.clear()	11-76
errorqueue.count	11-76
errorqueue.next()	11-77
eventlog.all()	11-78
eventlog.clear()	11-79
eventlog.count	11-79
eventlog.enable	11-80
eventlog.next()	11-81
eventlog.overwritemethod	11-82
exit()	11-82
fileVar.close()	11-83
fileVar.flush()	11-84
fileVar.read()	11-85
fileVar.seek()	11-86
fileVar.write()	11-88
format.asciiprecision	11-89
format.byteorder	11-89
format.data	11-91
fs.chdir()	11-92
fs.cwd()	11-93
fs.is_dir()	11-93
fs.is_file()	11-94
fs.mkdir()	11-95
fs.readdir()	11-95
fs.rmdir()	11-96
gettimezone()	11-97
gm_isweep()	11-97
gm_vsweep()	11-98
gpib.address	11-99
i_leakage_measure()	11-100
i_leakage_threshold()	11-101
io.close()	11-102
io.flush()	11-103
io.input()	11-104
io.open()	11-104
io.output()	11-105
io.read()	11-106
io.type()	11-107
io.write()	11-108
lan.applysettings()	11-109
lan.autoconnect	11-110
lan.config.dns.address[N]	11-111
lan.config.dns.domain	11-112
lan.config.dns.dynamic	11-112
lan.config.dns.hostname	11-113
lan.config.dns.verify	11-114
lan.config.duplex	11-114
lan.config.gateway	11-115
lan.config.ipaddress	11-116
lan.config.method	11-116
lan.config.speed	11-117
lan.config.subnetmask	11-118
lan.linktimeout	11-118
lan.lxidomain	11-119
lan.nagle	11-120
lan.reset()	11-120

lan.restoredefaults()	11-121
lan.status.dns.address[N]	11-122
lan.status.dns.name	11-122
lan.status.duplex	11-123
lan.status.gateway	11-124
lan.status.ipaddress	11-124
lan.status.macaddress	11-125
lan.status.port.dst	11-125
lan.status.port.rawsocket	11-126
lan.status.port.telnet	11-126
lan.status.port.vxi11	11-127
lan.status.speed	11-127
lan.status.subnetmask	11-128
lan.timedwait	11-128
lan.trigger[N].assert()	11-129
lan.trigger[N].clear()	11-129
lan.trigger[N].connect()	11-130
lan.trigger[N].connected	11-131
lan.trigger[N].disconnect()	11-131
lan.trigger[N].EVENT_ID	11-132
lan.trigger[N].ipaddress	11-132
lan.trigger[N].mode	11-133
lan.trigger[N].overrun	11-134
lan.trigger[N].protocol	11-135
lan.trigger[N].pseudostate	11-135
lan.trigger[N].stimulus	11-136
lan.trigger[N].wait()	11-137
localnode.autolinefreq	11-138
localnode.description	11-139
localnode.license	11-139
localnode.linefreq	11-140
localnode.model	11-140
localnode.password	11-141
localnode.passwordmode	11-141
localnode.prompts	11-142
localnode.prompts4882	11-143
localnode.reset()	11-144
localnode.revision	11-145
localnode.serialno	11-145
localnode.showerrors	11-146
makegetter()	11-146
makesetter()	11-147
meminfo()	11-148
node[N].execute()	11-148
node[N].getglobal()	11-149
node[N].setglobal()	11-150
opc()	11-150
os.remove()	11-151
os.rename()	11-151
os.time()	11-152
print()	11-153
printbuffer()	11-154
prinnumber()	11-155
reset()	11-156
savebuffer()	11-156
script.anonymous	11-157
script.delete()	11-158
script.factory.catalog()	11-158
script.load()	11-159
script.new()	11-160
script.newautorun()	11-161

script.restore()	11-162
script.run()	11-162
script.user.catalog()	11-163
scriptVar.autorun	11-163
scriptVar.list()	11-164
scriptVar.name	11-165
scriptVar.run()	11-166
scriptVar.save()	11-166
scriptVar.source	11-167
serial.baud	11-168
serial.databits	11-169
serial.flowcontrol	11-170
serial.parity	11-170
serial.read()	11-171
serial.write()	11-172
settime()	11-172
settimezone()	11-173
setup.poweron	11-174
setup.recall()	11-175
setup.save()	11-176
smua.abort()	11-176
smua.buffer.getstats()	11-177
smua.buffer.recalculatestats()	11-179
smua.cal.adjustdate	11-179
smua.cal.date	11-180
smua.cal.due	11-181
smua.cal.lock()	11-182
smua.cal.password	11-182
smua.cal.polarity	11-183
smua.cal.restore()	11-184
smua.cal.save()	11-184
smua.cal.state	11-185
smua.cal.unlock()	11-186
smua.contact.calibratehi()	11-186
smua.contact.calibratelo()	11-187
smua.contact.check()	11-188
smua.contact.r()	11-190
smua.contact.speed	11-191
smua.contact.threshold	11-192
smua.interlock.enable	11-192
smua.makebuffer()	11-193
smua.measure.autorangeY	11-194
smua.measure.autozero	11-195
smua.measure.calibrateY()	11-196
smua.measure.count	11-197
smua.measure.delay	11-198
smua.measure.delayfactor	11-199
smua.measure.filter.count	11-199
smua.measure.filter.enable	11-200
smua.measure.filter.type	11-201
smua.measure.highcrangedelayfactor	11-202
smua.measure.interval	11-202
smua.measure.lowrangeY	11-203
smua.measure.nplc	11-204
smua.measure.overlappedY()	11-205
smua.measure.rangeY	11-206
smua.measure.rel.enableY	11-207
smua.measure.rel.levelY	11-208
smua.measure.Y()	11-209
smua.measureYandstep()	11-210
smua.nvbufferY	11-211

smua.pulser.enable	11-212
smua.pulser.measure.aperture	11-213
smua.pulser.measure.calibrateY()	11-214
smua.pulser.measure.delay	11-215
smua.pulser.protect.sensev	11-216
smua.pulser.protect.sourcev	11-217
smua.pulser.protect.tripped	11-218
smua.pulser.source.calibratebiasi()	11-219
smua.pulser.rangeY	11-220
smua.pulser.source.calibratei()	11-221
smua.reset()	11-222
smua.savebuffer()	11-222
smua.sense	11-223
smua.source.autorangeY	11-224
smua.source.calibrateY()	11-225
smua.source.compliance	11-226
smua.source.delay	11-226
smua.source.func	11-227
smua.source.highc	11-228
smua.source.levelY	11-229
smua.source.limitY	11-230
smua.source.lowrangeY	11-231
smua.source.offfunc	11-231
smua.source.offlimitY	11-232
smua.source.offmode	11-233
smua.source.output	11-234
smua.source.rangeY	11-235
smua.source.settling	11-236
smua.source.sink	11-237
smua.trigger.arm.count	11-237
smua.trigger.arm.set()	11-238
smua.trigger.arm.stimulus	11-239
smua.trigger.ARMED_EVENT_ID	11-240
smua.trigger.autoclear	11-240
smua.trigger.count	11-241
smua.trigger.endpulse.action	11-243
smua.trigger.endpulse.set()	11-243
smua.trigger.endpulse.stimulus	11-245
smua.trigger.endsweep.action	11-246
smua.trigger.IDLE_EVENT_ID	11-246
smua.trigger.initiate()	11-247
smua.trigger.measure.action	11-248
smua.trigger.measure.set()	11-249
smua.trigger.measure.stimulus	11-250
smua.trigger.measure.Y()	11-251
smua.trigger.MEASURE_COMPLETE_EVENT_ID	11-252
smua.trigger.PULSE_COMPLETE_EVENT_ID	11-252
smua.trigger.source.action	11-253
smua.trigger.source.limitY	11-253
smua.trigger.source.linearY()	11-254
smua.trigger.source.listY()	11-255
smua.trigger.source.logY()	11-256
smua.trigger.source.pulsewidth	11-258
smua.trigger.source.set()	11-258
smua.trigger.source.stimulus	11-259
smua.trigger.SOURCE_COMPLETE_EVENT_ID	11-261
smua.trigger.SWEEP_COMPLETE_EVENT_ID	11-261
smua.trigger.SWEEPING_EVENT_ID	11-262
status.condition	11-263
status.measurement.*	11-265
status.measurement.buffer_available.*	11-267

status.measurement.current_limit.*	11-268
status.measurement.instrument.*	11-270
status.measurement.instrument.smua.*	11-271
status.measurement.protection.*	11-273
status.measurement.reading_overflow.*	11-274
status.measurement.voltage_limit.*	11-276
status.node_enable	11-277
status.node_event	11-279
status.operation.*	11-281
status.operation.calibrating.*	11-283
status.operation.instrument.*	11-284
status.operation.instrument.digio.*	11-286
status.operation.instrument.digio.trigger_overrun.*	11-288
status.operation.instrument.lan.*	11-290
status.operation.instrument.lan.trigger_overrun.*	11-292
status.operation.instrument.smua.*	11-294
status.operation.instrument.smua.trigger_overrun.*	11-296
status.operation.instrument.trigger_blender.*	11-298
status.operation.instrument.trigger_blender.trigger_overrun.*	11-299
status.operation.instrument.trigger_timer.*	11-301
status.operation.instrument.trigger_timer.trigger_overrun.*	11-302
status.operation.instrument.tsplink.*	11-304
status.operation.instrument.tsplink.trigger_overrun.*	11-305
status.operation.measuring.*	11-307
status.operation.remote.*	11-308
status.operation.sweeping.*	11-310
status.operation.trigger_overrun.*	11-311
status.operation.user.*	11-313
status.questionable.*	11-316
status.questionable.calibration.*	11-318
status.questionable.instrument.*	11-319
status.questionable.instrument.smua.*	11-320
status.questionable.over_temperature.*	11-322
status.questionable.unstable_output.*	11-323
status.request_enable	11-324
status.request_event	11-326
status.reset()	11-328
status.standard.*	11-329
status.system.*	11-331
status.system2.*	11-333
status.system3.*	11-335
status.system4.*	11-338
status.system5.*	11-340
SweepILinMeasureV()	11-342
SweepIListMeasureV()	11-343
SweepILogMeasureV()	11-344
SweepVLinMeasureI()	11-345
SweepVListMeasureI()	11-346
SweepVLogMeasureI()	11-347
timer.measure.t()	11-349
timer.reset()	11-349
trigger.blender[N].clear()	11-350
trigger.blender[N].EVENT_ID	11-350
trigger.blender[N].orenable	11-351
trigger.blender[N].overrun	11-352
trigger.blender[N].reset()	11-352
trigger.blender[N].stimulus[M]	11-353
trigger.blender[N].wait()	11-354
trigger.clear()	11-355
trigger.EVENT_ID	11-355
trigger.generator[N].assert()	11-356

trigger.generator[N].EVENT_ID.....	11-356
trigger.timer[N].clear()	11-357
trigger.timer[N].count.....	11-357
trigger.timer[N].delay	11-358
trigger.timer[N].delaylist	11-359
trigger.timer[N].EVENT_ID	11-360
trigger.timer[N].overrun	11-360
trigger.timer[N].passthrough.....	11-361
trigger.timer[N].reset()	11-361
trigger.timer[N].stimulus	11-362
trigger.timer[N].wait().....	11-364
trigger.wait()	11-364
tsplink.group.....	11-365
tsplink.master	11-366
tsplink.node	11-366
tsplink.readbit().....	11-367
tsplink.readport()	11-367
tsplink.reset().....	11-368
tsplink.state	11-369
tsplink.trigger[N].assert()	11-369
tsplink.trigger[N].clear()	11-370
tsplink.trigger[N].EVENT_ID.....	11-370
tsplink.trigger[N].mode	11-371
tsplink.trigger[N].overrun	11-372
tsplink.trigger[N].pulsewidth	11-373
tsplink.trigger[N].release()	11-374
tsplink.trigger[N].reset()	11-374
tsplink.trigger[N].stimulus	11-375
tsplink.trigger[N].wait()	11-376
tsplink.writebit()	11-377
tsplink.writeport()	11-378
tsplink.writeprotect	11-378
tspnet.clear()	11-379
tspnet.connect()	11-380
tspnet.disconnect().....	11-381
tspnet.execute()	11-382
tspnet.idn()	11-383
tspnet.read().....	11-383
tspnet.readavailable().....	11-384
tspnet.reset()	11-385
tspnet.termination()	11-385
tspnet.timeout.....	11-386
tspnet.tsp.abort()	11-387
tspnet.tsp.abortonconnect	11-387
tspnet.tsp.rhtablecopy().....	11-388
tspnet.tsp.runscript()	11-389
tspnet.write()	11-390
userstring.add()	11-390
userstring.catalog()	11-391
userstring.delete()	11-392
userstring.get()	11-393
waitcomplete().....	11-393

Troubleshooting guide 12-1

Introduction	12-1
Error levels	12-1
Effects of errors on scripts	12-1

Retrieving errors.....	12-2
Error summary list	12-2
Calibration	13-1
Calibration	13-1
Calibration test requirements	13-2
Uninstalling the 2601B-P-INT.....	13-5
Restoring factory defaults.....	13-5
Performing the calibration test procedures.....	13-6
Current source accuracy	13-8
Current measurement accuracy	13-10
Voltage source accuracy	13-12
Voltage measurement accuracy	13-14
Pulse accuracy	13-15
Bias source accuracy	13-18
Adjustment	13-19
Environmental conditions	13-20
Adjustment considerations	13-20
Adjustment overview	13-22
Calibration and adjustment commands quick reference.....	13-23
Adjustment procedure	13-26
Common commands.....	14-1
Command summary.....	14-1
Script command equivalents.....	14-2
Command reference	14-3
Identification query: *IDN?.....	14-3
Operation complete and query: *OPC and *OPC?.....	14-3
Reset: *RST	14-3
Self-test query: *TST?.....	14-4
Trigger: *TRG.....	14-4
Wait-to-continue: *WAI.....	14-4
Status model	15-1
Overview	15-1
Status register set contents.....	15-1
Queues	15-2
Status function summary.....	15-3
Status model diagrams	15-5
Clearing registers.....	15-13
Programming enable and transition registers	15-14
Reading registers	15-15
Status byte and service request (SRQ)	15-15
Status Byte Register	15-16
Service Request Enable Register	15-17
Serial polling and SRQ.....	15-18
SPE, SPD (serial polling)	15-18
Status byte and service request commands.....	15-19
Enable and transition registers.....	15-19
Controlling node and SRQ enable registers.....	15-19

Status register sets	15-20
System Summary Registers.....	15-20
Standard Event Register	15-21
Operation Status Registers	15-22
Questionable Status Registers.....	15-23
Measurement Event Registers	15-24
Register programming example	15-25
TSP-Link system status	15-25
Status model configuration example	15-25
Display character codes	16-1
2601B-PULSE display character codes	16-1
Frequently asked questions	17-1
How do I display the instrument's serial number?	17-1
How do I optimize performance?	17-2
Disabling autozero to increase speed	17-2
How do I upgrade the firmware?	17-2
How do I use the digital I/O port?.....	17-3
How do I trigger other instruments?.....	17-3
Triggering a scanner	17-3
Interactive trigger programming	17-4
More information about triggering	17-4
How do I generate a GPIB service request?.....	17-4
Setting up a service request.....	17-4
Service request programming example.....	17-5
Polling for SRQs.....	17-5
How do I store measurements in nonvolatile memory?	17-5
When should I change the output-off state?	17-6
How do I make contact check measurements?	17-6
How can I change the line frequency or voltage?	17-7
Where can I get the LabVIEW driver?	17-7
What should I do if I get an 802 interlock error?	17-7
Why is the reading value 9.91e37?	17-7
Next steps.....	18-1
Additional 2601B-PULSE information	18-1

Introduction

In this section:

Welcome	1-1
Extended warranty	1-1
Contact information	1-1
Customer documentation	1-2
Product software and drivers.....	1-2
Capabilities and features.....	1-3
Power and environmental ratings.....	1-4

Welcome

Thank you for choosing a Keithley Instruments product. The 2601B-PULSE System SourceMeter® 10 μ s Pulser/SMU Instrument with PulseMeter™ technology is an industry-leading high current/high speed pulser with measure capabilities and the full functionality of a traditional source-measure instrument (SMU). This instrument offers 10 A current pulse output at 10 V with a minimum pulse width of 10 μ s. Its built-in dual 1 Megasample/second (MS/s), 18-bit digitizers make it possible to acquire both pulse current and voltage waveforms simultaneously without the need to use a separate instrument.

Extended warranty

Additional years of warranty coverage are available on many products. These valuable contracts protect you from unbudgeted service expenses and provide additional years of protection at a fraction of the price of a repair. Extended warranties are available on new and existing products. Contact your local Keithley Instruments office, sales partner, or distributor for details.

Contact information

If you have any questions after you review the information in this documentation, please contact your local Keithley Instruments office, sales partner, or distributor. You can also call the Tektronix corporate headquarters (toll-free inside the U.S. and Canada only) at 1-800-833-9200. For worldwide contact numbers, visit tek.com/contact-us.

Customer documentation

The documentation for the 2601B-PULSE includes a Quick Start Guide and Reference Manual (this document). The 2601B-PULSE Quick Start Guide is provided as a hard copy with the instrument. You can also access it from tek.com/keithley as an Adobe Acrobat PDF file.

- **Quick Start Guide:** Provides unpacking instructions, describes basic connections, and reviews basic operation information. If you are new to Keithley Instruments equipment, refer to the Quick Start Guide to take the steps needed to unpack, set up, and verify operation.
- **Reference Manual:** Includes advanced operation topics and maintenance information. Programmers looking for a command reference and users looking for an in-depth description of the way the instrument works (including troubleshooting and optimization) should refer to the Reference Manual.

Product software and drivers

Go to the [Product Support web page \(tek.com/product-support\)](http://tek.com/product-support) to download drivers and software for your instrument.

Available drivers and software include:

- **KickStart Software:** Enables quick test setup and data visualization when using one or more instruments.
- **Test Script Builder (TSB):** This software provides an environment to develop a test program and the ability to load the test program onto the instrument. Running a program loaded on the instrument eliminates the need to send individual commands from the host computer to the instrument when running a test. For more information, see [Installing the TSB software](#) (on page 10-30).
- **IVI-COM Driver:** An IVI instrument driver you can use to create your own test applications in C/C++, VB.NET or C#. It can also be called from other languages that support calling a DLL or ActiveX (COM) object. Refer to [IVI Foundation \(ivifoundation.org\)](http://ivifoundation.org) for additional information.
- **LabVIEW™ Software drivers:** Drivers to communicate with National Instruments LabVIEW Software.
- **Keithley I/O layer:** Manages the communications between Keithley instrument drivers and software applications and the instrument itself. The I/O Layer handles differences in communications required to support GPIB, serial, ethernet, and other communications buses so that drivers and software applications do not need to handle the differences themselves.

To identify IP addresses of instruments that are connected to the local area network (LAN) and support the VXI-11 discovery protocol, you can also use LXI Discovery Tool, available from the [Resources \(Ixistandard.org/Resources/Resources.aspx\)](http://Ixistandard.org/Resources/Resources.aspx) page of the [LXI Consortium website \(Ixistandard.org\)](http://Ixistandard.org).

Capabilities and features

Key features:

- Pulser output of 10 A at 10 V
- SMU output of 10 A at 20 V
- No tuning required; works with inductive loads up to 3 μ H
- Pulser has dual 1 megasample/second digitizers for simultaneous high-speed sampling of current and voltage
- SMU has dual integrating analog-to-digital converters for simultaneous measurement of current and voltage
- DC capability up to ± 40 V at ± 1.0 A, 40 W
- TSP technology embeds complete test programs inside the instrument for best-in-class system-level throughput
- TSP-Link expansion technology for multi-channel parallel test without a mainframe
- USB 2.0, ethernet, GPIB, RS-232, and digital I/O interfaces
- Supported in the Keithley KickStart non-programming software tool

General features:

- 4.5, 5.5, or 6.5 digit display resolution
- Resistance and power measurement functions
- Four-quadrant sink or source operation
- Linear, logarithmic, and custom sweeping
- Filtering to reduce reading noise
- Trigger model supports extensive triggering and synchronization schemes at hardware speeds
- The SMU provides contact check
- The SMU provides high-capacitance mode for load impedances up to 50 μ F
- Internal memory stores five user setup options
- Dedicated reading buffers that can each store and recall over 140,000 measurements; additional dynamic reading buffers can be created
- USB flash drive access for saving data buffers, test scripts, and user setups
- Digital I/O port: Allows the 2601B-PULSE to control other devices
- Version 1.5 LXI Device Specification 2016 compliant

Power and environmental ratings

The 2601B-PULSE power and environmental ratings and connections are listed in the following tables.

Category	Specification
Power supply	100 V ac to 240 V ac, 50 Hz or 60 Hz (autosensing). 240 VA maximum
Input and output connections	See Front panel (on page 3-1) and Rear panel (on page 3-5)
Environmental conditions	<p>For indoor use only.</p> <p>Operating altitude: Maximum 2000 meters (6562 feet) above sea level</p> <p>Operating temperature: 0 °C to 35 °C at up to 70% relative humidity; at 35 °C to 50 °C, derate 3% relative humidity per °C</p> <p>Storage: –25 °C to 65 °C</p> <p>Pollution degree: 1 or 2</p>

	Source output electrical ratings
Voltage	40 V dc maximum
Current	3 A maximum at 6 V dc, 1 A maximum at 40 V dc

	SMU pulse output, region 4
Region maximums	10 A at 20 V
Maximum pulse width	1.8 ms
Maximum duty cycle	1%

	Measure input electrical ratings
Measurement category	O
Voltage	40 V dc maximum HI to LO
Current	3 A maximum at 6 V dc, 1 A maximum at 40 V dc
Impedance	Variable

In this section:

Introduction 2-1
 2601B-PULSE weights and dimensions..... 2-1
 Installing the 2601B-P-INT 2-6
 Cooling vents 2-8
 Turning the instrument on and off 2-9
 Placing a 2601B-PULSE in standby..... 2-10
 Warmup period..... 2-10
 Line frequency configuration 2-11
 Remote communications interfaces 2-11
 Using the interlock..... 2-42
 System information 2-46

Introduction

This section provides the information you need to install the 2601B-PULSE, make communications connections, and power up the instrument.

2601B-PULSE weights and dimensions

The instrument weighs 5.9 kg (13 lb) without the 2601B-P-INT attached. With the 2601B-P-INT attached, it weighs 6.4 kg (14 lb).

The following figure shows the mounting screw locations and dimensions. The dimensions shown are typical for both sides of the instrument.

For front mounting, use #8-32 × 3/8 in. Phillips pan-head screws. For rear mounting, use #10-32 × 3/8 in. Phillips pan-head SEMS screws.

Figure 1: Mounting screw locations and dimensions

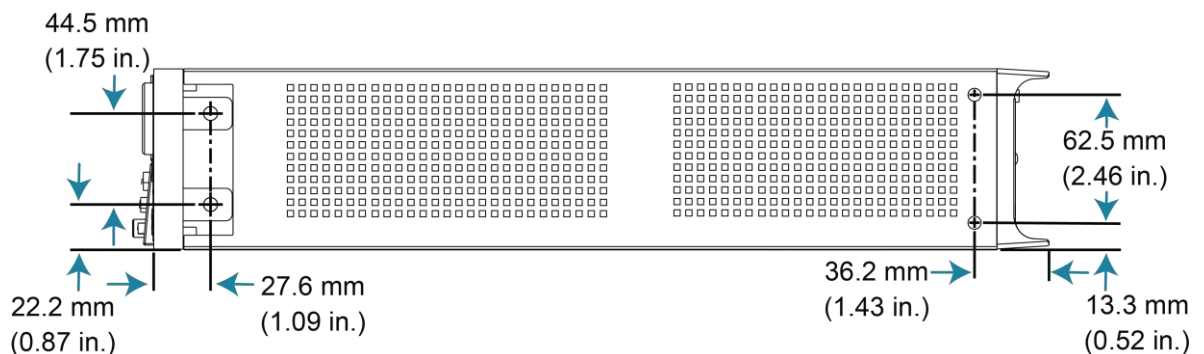

The following figures show the dimensions when the handle is installed.

Figure 2: 2601B-PULSE dimensions front and rear with handle

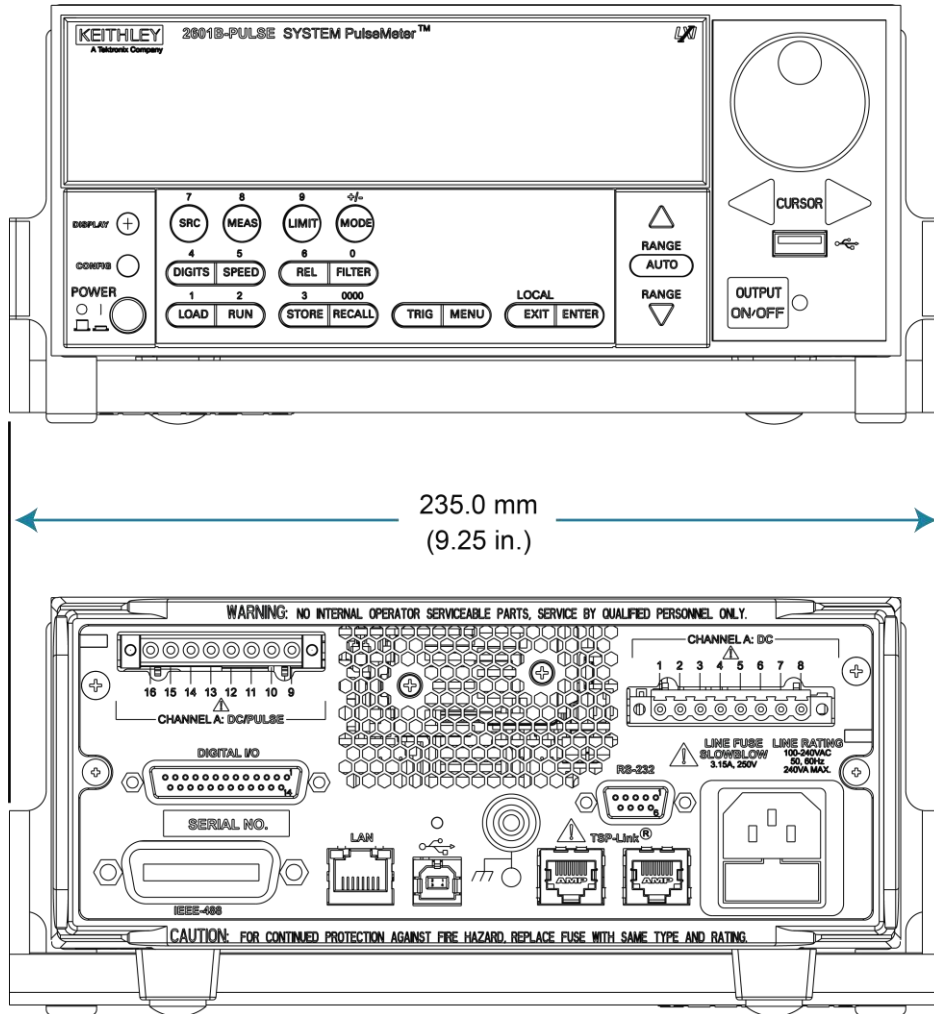

The following figures show the dimensions when the handle has been removed.

Figure 3: 2601B-PULSE front and rear panel dimensions with handle removed

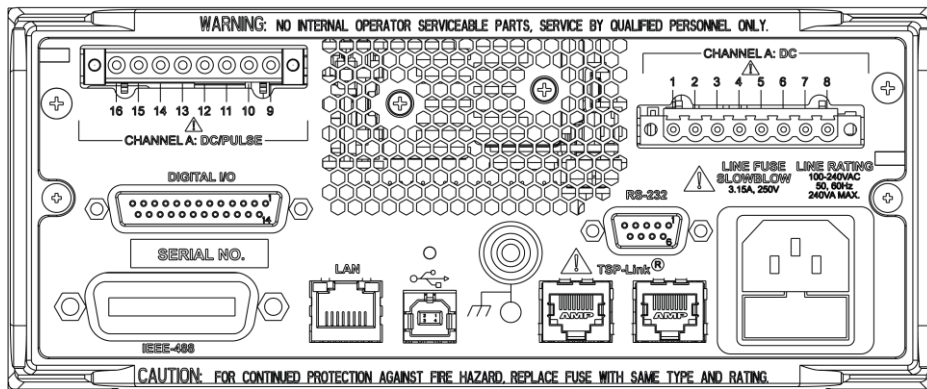
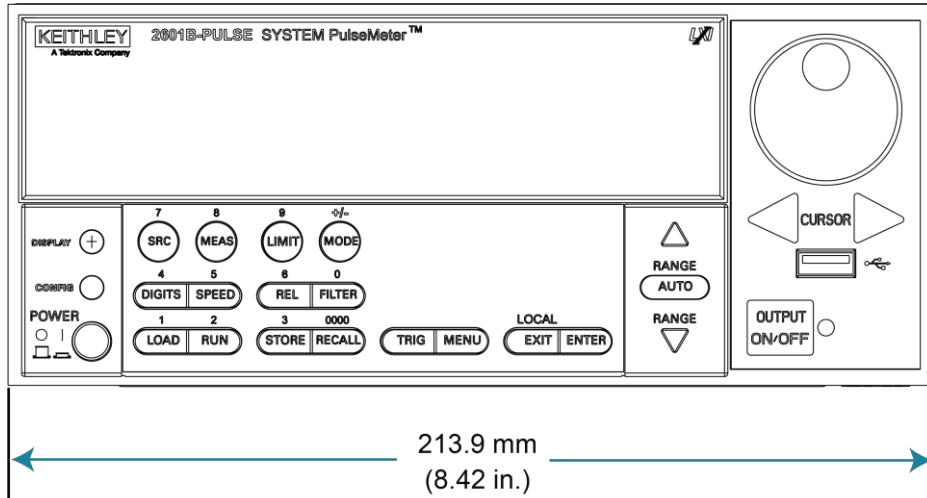

Figure 4: 2601B-PULSE height and length

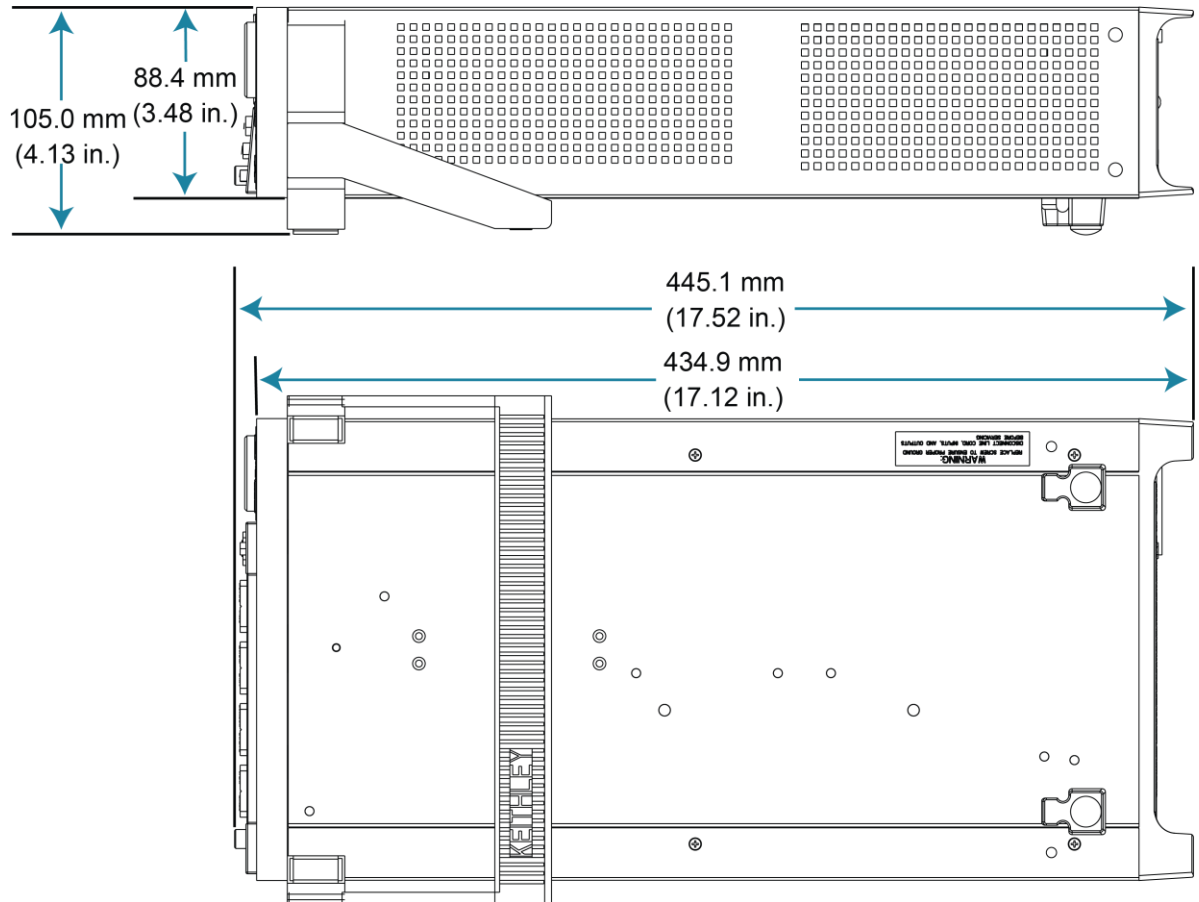
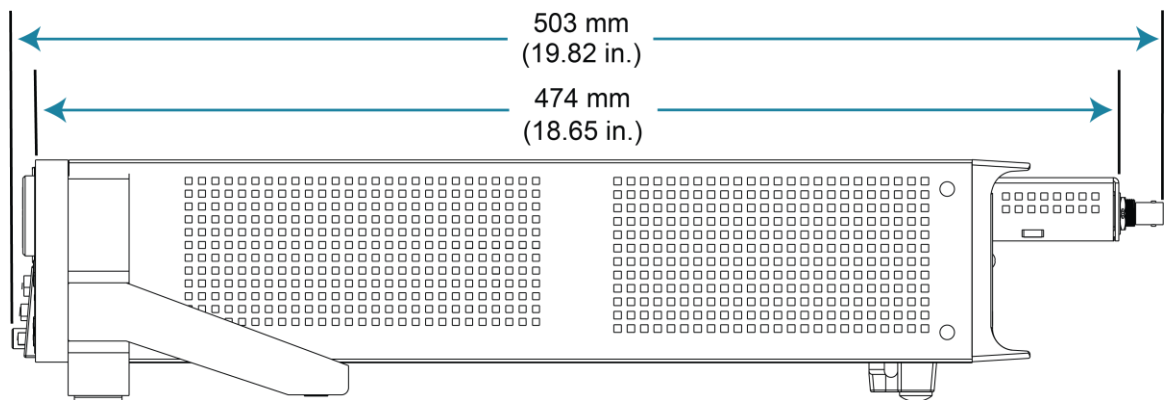

Figure 5: 2601B-PULSE with 2601B-P-INT length



Preparing the instrument for rack mounting

To remove the handle, mounting ears, and rear feet:

1. Adjust the handle by gently pulling it away from the sides of the instrument case and swinging it up or down until the orientation arrows on the handles line up with the orientation arrows on the mounting ears, as shown in the figure below.
2. Pull the ends of the handle away from the case.
3. On each mounting ear, remove the screw that secures the ear.
4. Pull down and out to remove each ear.
5. On the rear feet, pull out the rubber piece.
6. Remove the screws from the rear feet and remove the feet.

Figure 6: Handle removal

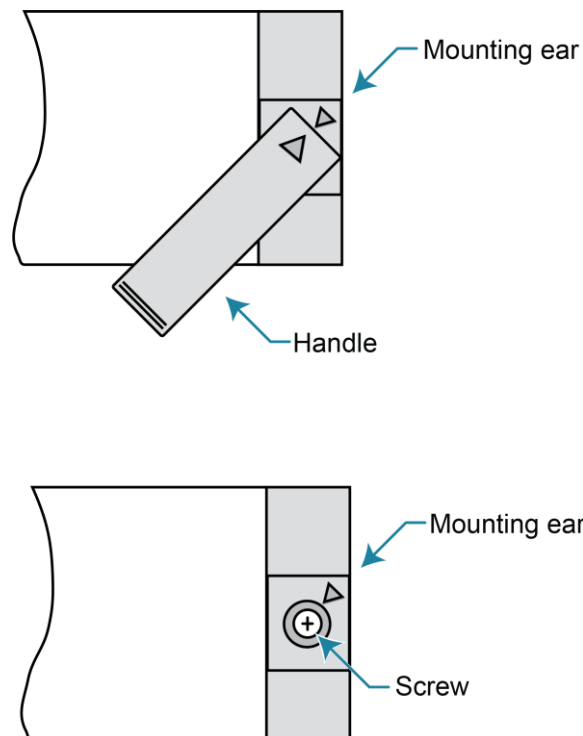

NOTE

Do not reinstall the mounting ear or rear feet screws. Save all removed parts for future benchtop use of the instrument.

2601B-P-INT dimensions

The following figure show the dimensions of the 2601B-P-INT Interlock and Cable Connector Box.

The 2601B-P-INT weighs 0.5 kg (1 lb).

Figure 7: 2601B-P-INT dimensions

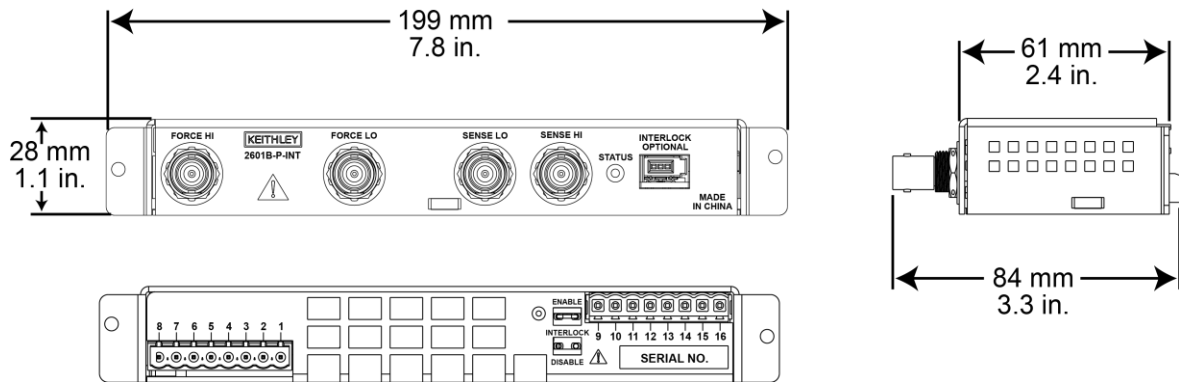

Installing the 2601B-P-INT

The 2601B-PULSE is shipped with the 2601B-P-INT Rear Panel Interlock and Cable Connector Box accessory. The 2601B-P-INT:

- Simplifies test connections to the 2601B-PULSE by converting terminal strip connections to standard BNC connectors
- Makes the connections between the CHANNEL A: DC and CHANNEL A: DC/PULSE terminal strips
- Provides connections for an optional interlock

Refer to [Using the interlock](#) (on page 2-42) for detail on connecting the interlock.

NOTE

You must use the screws that are provided with the 2601B-P-INT to attach it to the instrument. The screws that you remove from the instrument will not provide a secure connection.

To install the 2601B-P-INT:

1. Remove power connections from the 2601B-PULSE.
2. On the rear panel of the 2601B-PULSE, remove the screws to the left of the CHANNEL A: DC/PULSE terminal strip and to the right of the CHANNEL A: DC terminal strip. Save the screws for operation with the 2601B-P-INT uninstalled. Screw locations are shown in the following figure.

Figure 8: Remove screws from 2601B-PULSE rear panel

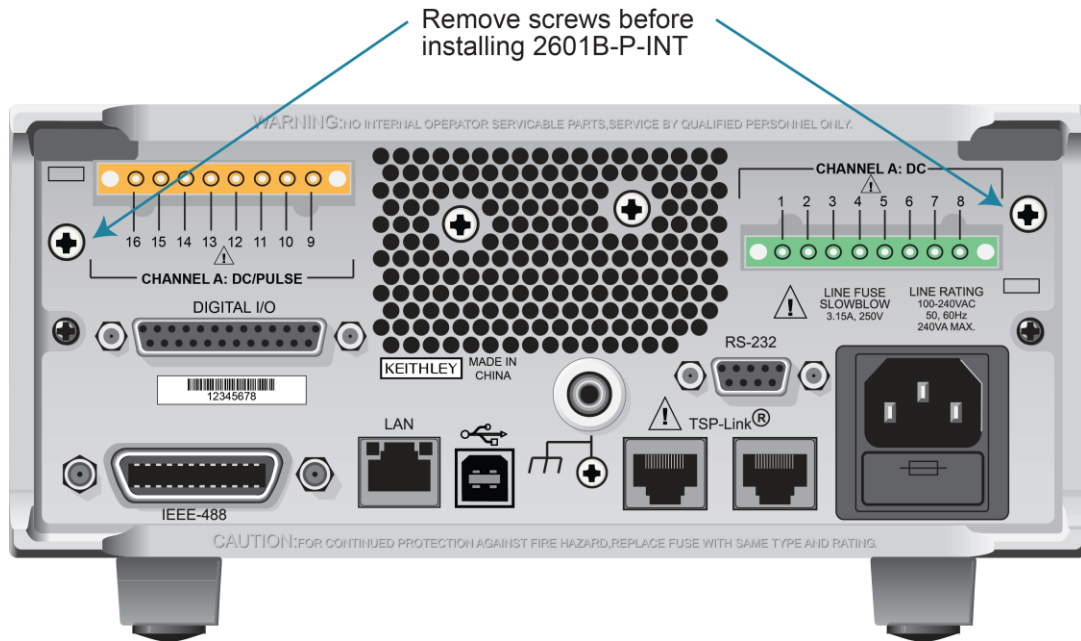

3. On the terminal strip panel of the 2601B-P-INT, position the INTERLOCK jumper. Use needle-nose pliers to position the jumper in the ENABLE slot if you are using an interlock or DISABLE if you are not using the interlock.

Figure 9: 2601B-P-INT Interlock Box terminal strip panel

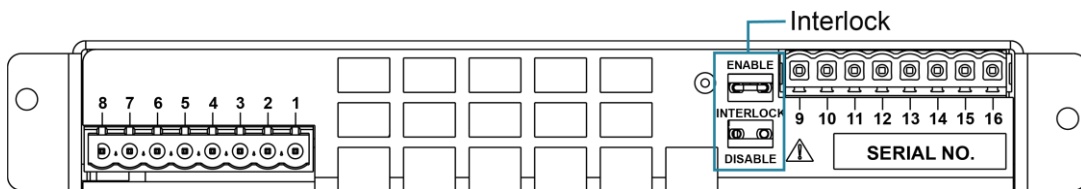

4. Align the terminal strip panel of the 2601B-P-INT to the terminal strips on the rear panel of the 2601B-PULSE.
5. Press the 2601B-P-INT connections firmly onto the terminal strips on the rear panel of the 2601B-PULSE.
6. Use the screws provided with the 2601B-P-INT to secure it to the rear panel of the 2601B-PULSE.

Figure 10: Installation of the 2601B-P-INT

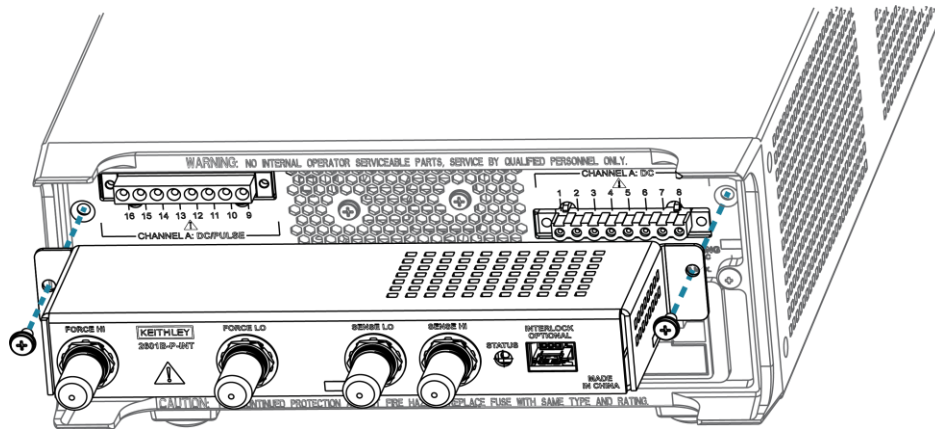

NOTE

Replacement jumpers are available from Keystone Electronics Corp., part number 1430-1, Uninsulated Shorting Pin.

Cooling vents

The 2601B-PULSE has side and top intake and rear exhaust vents. One side must be unobstructed to dissipate heat.

Excessive heat could damage the 2601B-PULSE and degrade its performance. Only operate the 2601B-PULSE in an environment where the ambient temperature does not exceed 50 °C.

Do not place a container of liquid (water or coffee, for instance) on the top cover. If it spills, the liquid may enter the case through the vents and cause severe damage.

CAUTION

To prevent damaging heat build-up and ensure specified performance, use the following guidelines.

The rear exhaust vent and either the top or both side intake vents must be unobstructed to properly dissipate heat. Even partial blockage could impair proper cooling.

Do not position any devices adjacent to the 2601B-PULSE that force air (heated or unheated) toward its cooling vents or surfaces. This additional airflow could compromise accuracy.

When rack mounting the 2601B-PULSE, make sure there is adequate airflow around both sides to ensure proper cooling. Adequate airflow enables air temperatures within approximately one inch of the 2601B-PULSE surfaces to remain within specified limits under all operating conditions.

CAUTION

If high power dissipation equipment is rack mounted next to the 2601B-PULSE, it could cause excessive heating. To produce specified 2601B-PULSE accuracies, maintain the specified ambient temperature around the surfaces of the 2601B-PULSE. In rack configurations with convection cooling only, proper cooling practice places the hottest non-precision equipment (for example, the power supply) at the top of the rack away from and above precision equipment (such as the 2601B-PULSE).

Mount precision equipment as low as possible in the rack, where temperatures are coolest. Adding space panels above and below the 2601B-PULSE will help provide adequate airflow.

Turning the instrument on and off

The 2601B-PULSE operates from a line voltage of 100 V to 240 V at a frequency of 50 Hz or 60 Hz. Line voltage is automatically sensed (there are no switches to set). Make sure the operating voltage in your area is compatible.

Follow the procedure below to connect the 2601B-PULSE to line power and turn on the instrument.

CAUTION

Operating the instrument on an incorrect line voltage may cause damage to the instrument, possibly voiding the warranty.

To turn a 2601B-PULSE on and off:

1. Before plugging in the power cord, make sure that the front-panel POWER switch is in the off (O) position.
2. Connect the female end of the supplied power cord to the AC receptacle on the rear panel.
3. Connect the other end of the power cord to a grounded AC outlet.

WARNING

The power cord supplied with the 2601B-PULSE contains a separate protective earth (safety ground) wire for use with grounded outlets. When proper connections are made, the instrument chassis is connected to power-line ground through the ground wire in the power cord. In addition, a chassis ground connection is provided through a screw on the rear panel. This terminal should be connected to a known protective earth. In the event of a failure, not using a properly grounded protective earth and grounded outlet may result in personal injury or death due to electric shock.

Do not replace detachable mains supply cords with inadequately rated cords. Failure to use properly rated cords may result in personal injury or death due to electric shock.

⚠ WARNING

Hazardous voltages may be present in the test system. To prevent injury or death, remove power from the instrument or test system and discharge any energy storage components (for example, capacitors or cables) before changing any connections that might allow contact with an uninsulated conductor.

NOTE

On some sensitive or easily damaged devices under test (DUTs), the instrument power-up and power-down sequence can apply transient signals to the DUT that may affect or damage it. When testing this type of DUT, do not make final connections to it until the instrument has completed its power-up sequence and is in a known operating state. When testing this type of DUT, disconnect it from the instrument before turning the instrument off.

To prevent any human contact with a live conductor, connections to the DUT must be fully insulated and the final connections to the DUT must only use safety-rated safety-jack-socket connectors that do not allow bodily contact.

4. To turn your instrument on, press the front-panel **POWER** switch to place it in the on (I) position.
5. To turn your instrument off, press the front-panel **POWER** switch to place it in the off (O) position.

Placing a 2601B-PULSE in standby

⚠ WARNING

Placing the 2601B-PULSE in standby does not place the instrument in a safe state (an interlock is provided for this function).

When the instrument is on, the output may be placed in an active output state (output on) or a standby mode (output off). From the front panel, pressing the **OUTPUT ON/OFF** control toggles the output using the present instrument configuration. You can also place the output in standby over the remote interface by sending the following command:

```
smua.source.output = smua.OUTPUT_OFF
```

Even though the instrument is placed in standby, the output may not actually be off.

Warmup period



The 2601B-PULSE must be turned on and allowed to warm up for at least two hours to achieve rated accuracies.

Line frequency configuration

The factory configures the 2601B-PULSE to detect the power line frequency automatically at each power-up. This detected line frequency (either 50 Hz or 60 Hz) is used for aperture (NPLC) calculations.

In noisy environments, you can manually configure the instrument to match the actual line frequency.

To configure the line frequency from the front panel:

1. Press the **MENU** key, then turn the navigation wheel  to select **LINE-FREQ**, and then press the **ENTER** key.
2. Turn the navigation wheel  to select the appropriate frequency and then press the **ENTER** key. To configure the instrument to automatically detect line frequency at each power-up, select **AUTO**.
3. Press the **EXIT (LOCAL)** key to return to the main display.

To configure the line frequency from a remote interface:

Set the `localnode.linefreq` or the `localnode.autolinefreq` attribute. To set the line frequency to 60 Hz, send:

```
localnode.linefreq = 60
```

To configure the instrument to automatically detect line frequency at each power-up:

```
localnode.autolinefreq = true
```

Remote communications interfaces

You can choose from one of several communication interfaces to send commands to and receive responses from the 2601B-PULSE.

You can control the 2601B-PULSE from only one communications interface at a time. The first interface on which the instrument receives a message takes control of the instrument. If another interface sends a message, that interface can take control of the instrument. You may need to enter a password to change the interface, depending on the setting of interface access.

The 2601B-PULSE automatically detects the type of communications interface (LAN, USB, GPIB, or RS-232) when you connect to the respective port on the rear panel of the instrument. In most cases, you do not need to configure anything on the instrument. In addition, you do not need to reboot if you change the type of interface that is connected.

Remote interface connections

The 2601B-PULSE supports the following remote interfaces:

- **USB:** Communicate with the instrument over a USB connection.
- **LAN:** Local area network (LAN) communications provide the flexibility to build scalable and functional test or data acquisition systems with a large degree of flexibility.
- **GPIB:** General purpose interface bus is an IEEE-488 instrumentation data bus.
- **RS-232:** Communicate with the instrument over the serial port or with another instrument using its serial port.

NOTE

The 2601B-PULSE can be controlled from only one communication interface at a time. The first interface from which it receives a message takes control of the instrument. It ignores the other interfaces until the instrument is returned to local operation.

For more information about the remote interfaces, see:

- [USB communications](#) (on page 2-13)
- [LAN communications](#) (on page 2-15)
- [GPIB operation](#) (on page 2-29)
- [RS-232 interface operation](#) (on page 2-32)

Figure 11: 2601B-PULSE IEEE-488, LAN, USB, and RS-232 connections

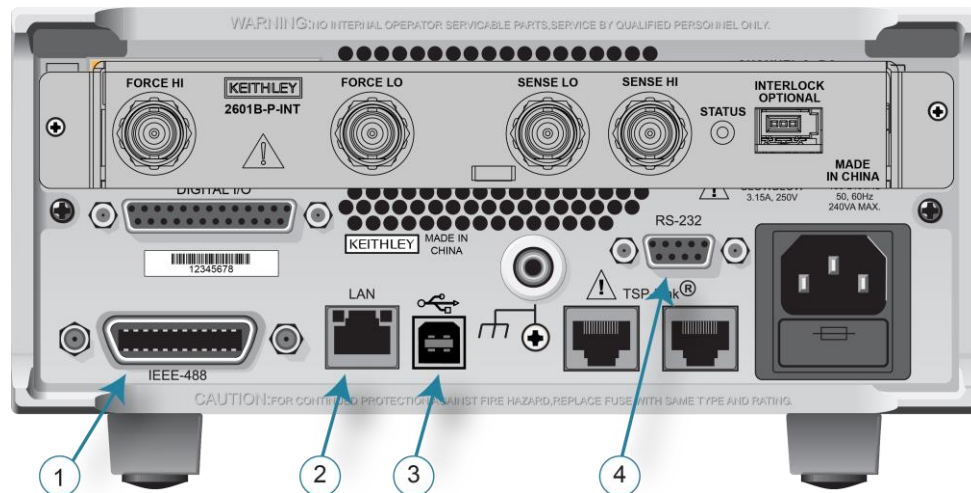

1 IEEE-488 connection
2 LAN connection
3 USB connection
4 RS-232 connection

Output queue

Response messages, such as those generated from print commands, are placed in the output queue. All remote command interfaces share the same output queue.

The output queue sets the message available (MAV) bit in the status model.

The data in the output queue is cleared by the *CLS command.

USB communications

To use the rear-panel USB port, you need a driver that communicates using the USBTMC protocol, such as NI-VISA, on the host computer.

When installed, the USBTMC protocol allows the Microsoft® Windows® operating system to recognize the instrument.

When you connect a USB device that implements the USBTMC or USBTMC-USB488 protocol to the computer, the driver automatically detects the device. Note that the driver does not recognize other USB devices, such as printers, scanners, and storage devices.

In this section, "USB instruments" refers to devices that implement the USBTMC or USBTMC-USB488 protocol.

See [How to install the Keithley I/O Layer](#) (on page 2-39) for more information on drivers.

Communicate with the instrument

When using Virtual Instrument Software Architecture (VISA) to communicate with the USB device, you need to use a VISA communication driver. VISA requires a resource string in the following format to connect to the correct USB instrument:

```
USB[board]::manufacturer ID::model code::serial number[::USB interface number] [::INSTR]
```

This requires that you determine the parameters. You can gather this information by running a utility that automatically detects all instruments connected to the computer. If you installed the Keithley I/O Layer, the Keithley Configuration Panel is available from the Microsoft® Windows® Start menu in the Keithley Instruments menu.

To use the Keithley Configuration Panel to determine the VISA resource string:

1. Start the Keithley Configuration Panel. The Keithley Configuration Wizard opens to the Select Operation dialog box.
2. Complete the wizard.
3. Save the configuration. From the Configuration Utility, select **File > Save**.
4. Open the Keithley Communicator.

5. Select **File > Open Instrument** to open the instrument you named in the wizard.

Figure 12: Keithley Communicator Open an Instrument

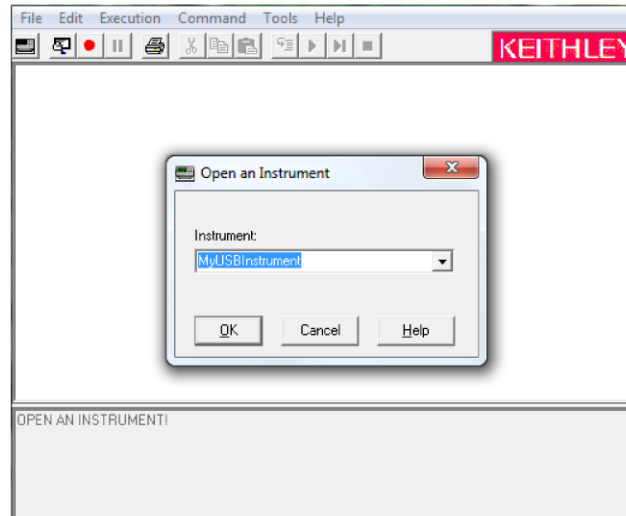

6. Select **OK**.
7. Send a command to the instrument and see if it responds.

NOTE

If you have a full version of NI-VISA on your system, you can run NI-MAX or the VISA Interactive Utility. See their documentation for information.

If you have the Keysight IO Libraries on your system, you can run Keysight Connection Expert to review your USB instruments. See their documentation for information.

Connecting multiple USB instruments to the computer

The most convenient way to connect USB instrumentation to the computer is to plug a USB cable directly from the instrument to the computer. If you have more than one USB instrument or have other USB devices, such as printers, keyboards, and mice, you might not have enough USB connectors on the computer.

To gain more ports, you can use a USB hub or add more USB controller cards if you have available PCI or PCI Express slots.

LAN communications

You can communicate with the instrument using a local area network (LAN). The 2601B-PULSE can connect directly to a host computer or interact with a DHCP or DNS server and other LXI-compliant instruments on a local area network (LAN). The LAN interface can be used to build flexible test systems that include web access. This section provides an overview of LAN communications for the 2601B-PULSE.

When you connect using a LAN, you can use a web browser to access the internal web page of the instrument and change some of the instrument settings.

There is one LAN port, which is on the rear panel of the instrument, that supports full connectivity on a 10 Mbps or 100 Mbps network. The 2601B-PULSE automatically detects the speed.

The 2601B-PULSE also supports Multicast DNS (mDNS) and DNS Service Discovery (DNS-SD), which are useful on a LAN with no central administration.

NOTE

Contact your network administrator to confirm your specific network requirements before setting up a LAN connection.

If you have problems setting up the LAN, refer to [LAN troubleshooting suggestions](#) (on page 2-25).

The 2601B-PULSE is a Version 1.5 LXI Device Specification 2016 compliant instrument that supports TCP/IP and complies with IEEE Std 802.3 (ethernet).

LAN cable connection

The 2601B-PULSE includes two LAN crossover cables. One cable is intended for use with the TSP-Link® network and the other cable is intended for use with the LAN.

However, you can use any standard LAN crossover cable (RJ-45, male-to-male) or straight-through cable to connect your equipment. The instrument automatically senses which cable you have connected.

The following figure shows the location of the LAN port on the rear panel of the instrument. Connect the LAN cable between this connection and the LAN port on the computer.

Figure 13: 2601B-PULSE ethernet connection

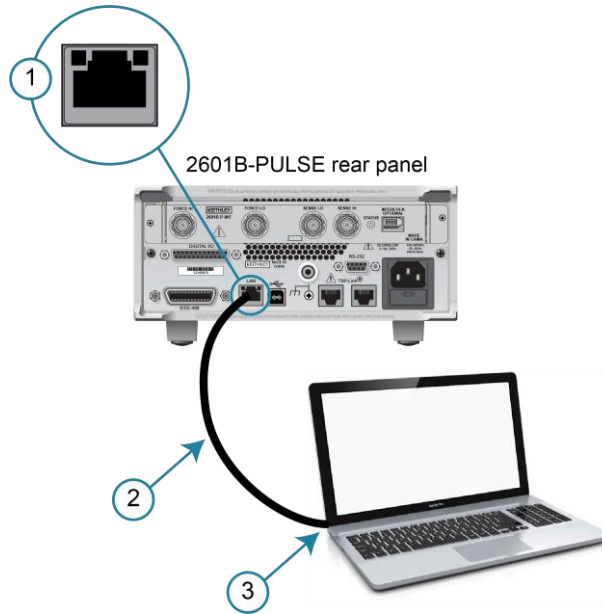

1 2601B-PULSE ethernet port (LAN)
2 Straight-through LAN cable or crossover LAN cable
3 Ethernet port (on the host computer)

You can connect the instrument to the LAN in a one-to-one, one-to-many, two network card, or enterprise configuration, as described in the following topics.

One-to-one connection

With most instruments, a one-to-one connection is done only when you are connecting a single instrument to a single network interface card.

A one-to-one connection using a network crossover cable connection is similar to a typical RS-232 system using a null modem cable. The crossover cable has its receive (RX) and transmit (TX) lines crossed to allow the receive line input to be connected to the transmit line output on the network interfaces.

Figure 14: One-to-one connection with a crossover cable

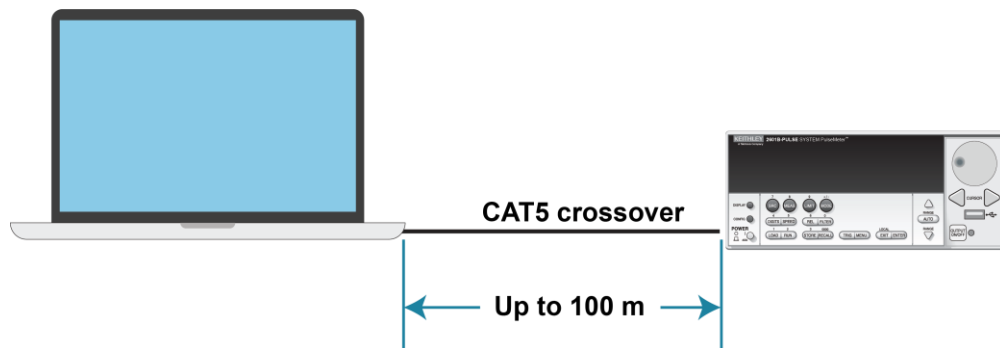

NOTE

The 2601B-PULSE supports Auto-MDIX and can use either normal LAN CAT-5 cables (patch) or crossover cables. The instrument automatically adjusts to support either cable.

One-to-many connection

With a LAN hub, a single network interface card can be connected to as many instruments as the hub can support. This requires straight-through network (not crossover) cables for hub connections.

The advantage of this method is easy expansion of measurement channels when the test requirements exceed the capacity of a single instrument. With only the instruments connected to the hub, this is an isolated instrumentation network. However, with a corporate network attached to the hub, the instruments become part of the larger network.

Figure 15: One-to-many connection using a network hub or switch

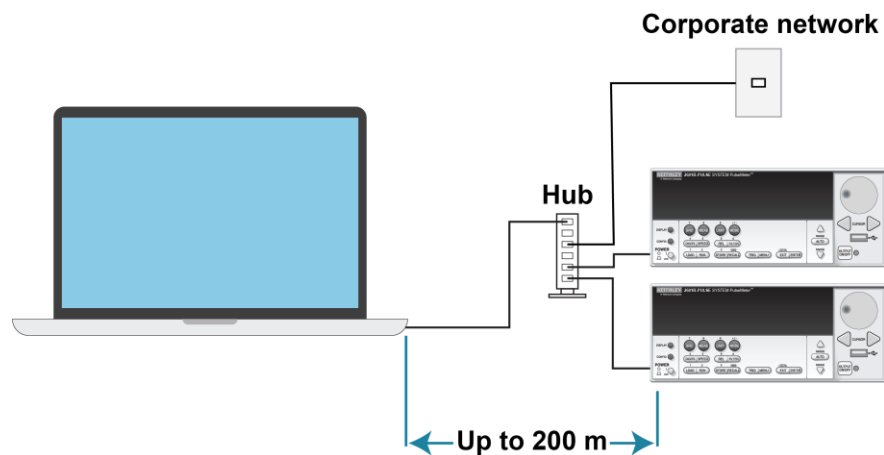

Two network card connection

If you need to connect independent corporate and instrumentation networks, two network interface cards are required in the computer controller. Though the two networks are independent, stations on the corporate network can access the instruments and the instruments can access the corporate network using the same computer.

This configuration resembles a GPIB setup in which the computer is connected to a corporate network, but also has a GPIB card in the computer to communicate with instruments.

Figure 16: Two network card connection

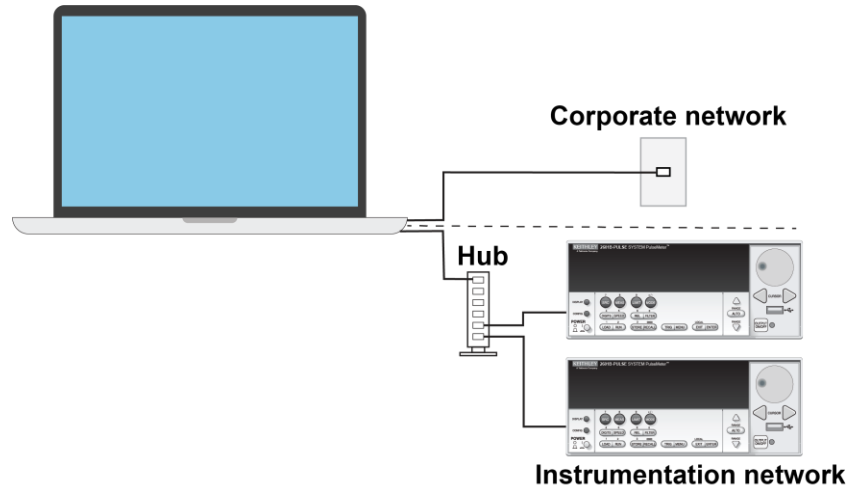

Instrumentation connection to enterprise routers or servers

This connection uses an existing network infrastructure to connect instruments to the computer controller. In this case, you must get the network resources from the network administrator.

Usually, the instruments are kept inside the corporate firewall, but the network administrator can assign resources that allow them to be outside the firewall. This allows instruments to be connected to the internet using appropriate security methods. Data collection and distribution can be controlled from virtually any location.

Figure 17: Instrumentation connection to enterprise routers or servers

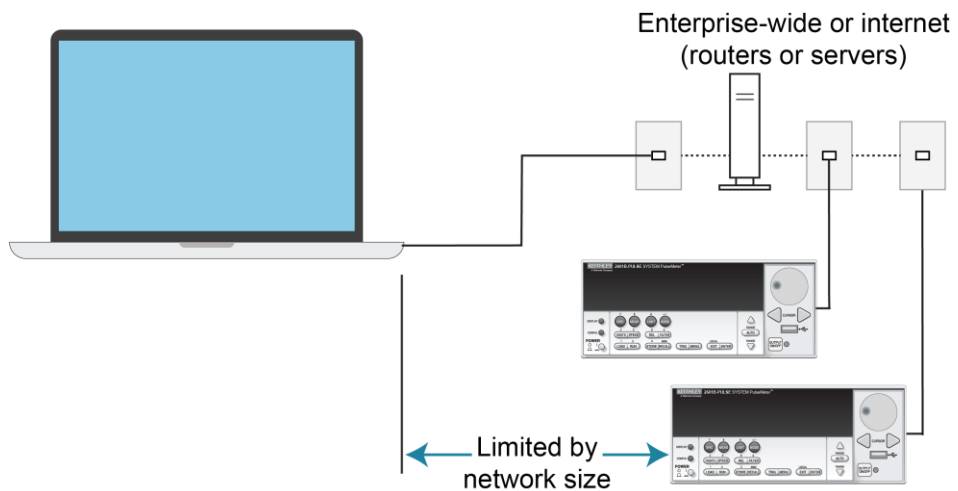

Set up LAN communications on the instrument

The following topics describe how to check the existing LAN communications settings and set up manual or automatic LAN communications.

Check communications settings

Before configuring the LAN, you can check the communications settings on the instrument without making any changes.

To view the active network settings:

1. From the front panel, press the **MENU** key, and then select **LAN > STATUS**.
2. Use the navigation wheel  to select one of the following network settings:
 - **IP-ADDRESS**
 - **GATEWAY**
 - **SUBNET-MASK**
 - **METHOD**
 - **DNS**
 - **MAC-ADDRESS**
3. Press the **ENTER** key to view the active setting.
4. Press the **EXIT (LOCAL)** key once to return to the STATUS menu.

Set up automatic LAN configuration

If you are connecting to a LAN that has a DHCP server or if you have a direct connection between the instrument and a host computer, you can use automatic IP address selection.

If you select Auto, the instrument attempts to get an IP address from a DHCP server. If this fails, it reverts to an IP address in the range of 169.254.1.0 through 169.254.254.255.

NOTE

Both the host computer and the instrument should be set to use automatic LAN configuration. Though it is possible to have one set to manual configuration, it is more complicated to set up.

To set up automatic IP address selection using the front panel:

1. From the front panel, press the **MENU** key, and then select **LAN > CONFIG > METHOD**.
2. Select **AUTO**.
3. Press the **ENTER** key.
4. Press the **EXIT (LOCAL)** key until you return to the LAN CONFIG menu.
5. Select **APPLY_SETTINGS > YES**, and then press the **ENTER** key.

Set up manual LAN configuration



NOTE

These steps assume that you are making all the settings in the order shown here. If you only change one or a few settings, be aware that you need to apply the settings before they will be in effect. To apply the settings, from the **LAN CONFIG** menu, select **APPLY_SETTINGS > YES**, and then press the **ENTER** key.

NOTE



Contact your corporate information technology (IT) department to secure a valid IP address for the instrument when placing the instrument on a corporate network.

To set up the LAN configuration manually using the front panel:

1. Press the **MENU** key to display the MAIN MENU.
2. Use the navigation wheel  to select **LAN**. The LAN CONFIG menu is displayed.
3. Select **CONFIG > METHOD > MANUAL** and then press the **ENTER** key.
4. Press the **EXIT (LOCAL)** key once to return to the LAN CONFIG menu.
5. Select **CONFIG > IP-ADDRESS**.
6. Turn the navigation wheel  to select and enter a valid IP address for the instrument.

NOTE

The IP address of the instrument can have leading zeros, but the IP address of the computer cannot.

7. Press the **ENTER** key to confirm the changes.
8. Press the **EXIT (LOCAL)** key twice to return to the LAN CONFIG menu.
9. Select **CONFIG > GATEWAY**.
10. Turn the navigation wheel  to select and enter a valid gateway address for the instrument.
11. Press the **ENTER** key to confirm the changes.
12. Press the **EXIT (LOCAL)** key twice to return to the LAN CONFIG menu.
13. Select **CONFIG > SUBNETMASK**.
14. Turn the navigation wheel  to select and enter a valid subnet mask for the instrument.
15. Press the **ENTER** key to confirm the changes.
16. Press the **EXIT (LOCAL)** key twice to return to the LAN CONFIG menu.
17. Select **APPLY_SETTINGS > YES**, and then press the **ENTER** key.

LAN speeds

Another characteristic of the LAN is speed. The 2601B-PULSE negotiates with the host computer and other LXI-compliant devices on the LAN to transmit data at the highest speed possible. LAN speeds must be configured to match the speed of the other instruments on the network.

To set the LAN speed:

1. From the front panel, press the **MENU** key and select **LAN > CONFIG > SPEED**.
2. Turn the navigation wheel  to select either **10 Mbps** or **100 Mbps**.
3. Press the **ENTER** key.
4. Press the **EXIT (LOCAL)** key once to return to the previous menu.
5. Select **APPLY_SETTINGS > YES**, and then press the **ENTER** key.

Configuring the domain name system (DNS)

The domain name system (DNS) lets you type a domain name in the address bar to connect to the instrument. If you use DNS, you can use a name instead of an IP address.

Example:

Model2601B-PULSE.XYZcompany.com

NOTE

Contact your corporate information technology (IT) department for information about DNS. If a DNS server is not part of the LAN infrastructure, do not use this setting.



To enable or disable DNS host name verification:

1. From the front panel, press the **MENU** key, and then select **LAN > CONFIG > DNS > VERIFY**.
2. Turn the navigation wheel  to select either **ENABLE** or **DISABLE**. When enabled, the instrument performs a DNS lookup to verify the DNS host name matches the value specified in the [lan.config.dns.hostname](#) (on page 11-113) attribute.
3. Press the **ENTER** key.
4. Press the **EXIT (LOCAL)** key twice to return to the LAN CONFIG menu.

To enable or disable DNS registration:

1. From the front panel, press the **MENU** key and select **LAN > CONFIG > DNS > DYNAMIC**.
2. Turn the navigation wheel  to select either **ENABLE** or **DISABLE**. DNS registration works with the DHCP to register the host name specified in the `lan.config.dns.hostname` attribute with the DNS server.
3. Press the **ENTER** key.
4. Press the **EXIT (LOCAL)** key twice to return to the LAN CONFIG menu.
5. Select **APPLY_SETTINGS > YES**, and then press the **ENTER** key.

To set the DNS server IP addresses:

1. From the front panel, press the **MENU** key and select **LAN > CONFIG > DNS**.
2. Turn the navigation wheel  to select either **DNS-ADDRESS1** or **DNS-ADDRESS2**.
3. Press the **ENTER** key.
4. Turn the navigation wheel  to select and enter a valid IP address for the DNS server.
5. Press the **ENTER** key.
6. Press the **EXIT (LOCAL)** key twice to return to the LAN CONFIG menu.
7. Select **APPLY_SETTINGS > YES**, and then press the **ENTER** key.

Confirming the active speed and duplex negotiation

The 2601B-PULSE automatically detects the speed and duplex negotiation active on the LAN. Once the speed and duplex negotiation is detected, the instrument automatically adjusts its own settings to match the LAN settings.

To confirm the active LAN speed and duplex mode:

1. From the front panel, press the **MENU** key.
2. Select **LAN > STATUS**.
3. Use the navigation wheel  to select one of the following:
 - **SPEED**
 - **DUPLEX**
4. Press the **ENTER** key to view the active setting.
5. Press the **EXIT (LOCAL)** key once to return to the STATUS menu.

To set the duplex mode:

1. From the front panel, press the **MENU** key and select **LAN > CONFIG > DUPLEX**.
2. Turn the navigation wheel  to select either **HALF** or **FULL**.
3. Press the **ENTER** key.
4. Press the **EXIT (LOCAL)** key once to return to the LAN CONFIG menu.
5. Select **APPLY_SETTINGS > YES**, and then press the **ENTER** key.

Use the LXI Discovery Tool

To find the IP address of the 2601B-PULSE from a computer, use the LXI Discovery Tool, a utility that is available from the Resources tab of the [LXI Consortium website \(lxistandard.org\)](http://lxistandard.org).

LAN status LEDs

The figure below illustrates the two status light emitting diodes (LEDs) that are on the LAN port of the instrument. The table below the figure provides explanations of the LED states. The LED labeled 1 indicates the LAN port is connected to a 100 Mbps network. The LED labeled 2 indicates the LAN port is connected to a 10 Mbps network.

Figure 18: LAN status

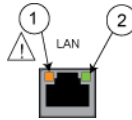

When an LED is:	The network:
Off	is not connected
On	is connected
Blinking	is sending or receiving data

Selecting a LAN interface protocol

You can use a remote interface protocol to connect to the 2601B-PULSE. The 2601B-PULSE provides Telnet, VXI-11, and raw socket LAN interfaces, with associated LAN protocols (each interface uses a different protocol). Select the interface based on the protocol needed.

You can also use a dead socket termination interface (DST) to troubleshoot connection problems.

NOTE

You can only use one remote interface at a time. Although multiple ethernet connections to the instrument can be opened, only one can be used to control the instrument at a time.

Telnet connection

The Telnet protocol is similar to raw socket and can be used when you need to interact directly with the instrument. Telnet is often used for debugging and troubleshooting. You will need a separate Telnet program to use this protocol.

The 2601B-PULSE supports the Telnet protocol, which you can use over a TCP/IP connection to send commands to the instrument. You can use a Telnet connection to interact with scripts or send real-time commands.

VXI-11 connection

This remote interface is similar to GPIB and supports message boundaries, serial poll, and service requests (SRQs). A VXI-11 driver or NI-VISA software is required. Test Script Builder (TSB) uses NI-VISA and can be used with the VXI-11 interface. You can expect a slower connection with this protocol.

Raw socket connection

All Keithley instruments that have LAN connections support raw socket communication, which means you can connect to the TCP/IP port on the instrument and send and receive commands. You can communicate with the instrument using the Winsock API on computers with the Microsoft® Windows® operating system or using the Berkeley Sockets API on Linux® or Apple® computers.

Raw socket is a basic ethernet connection that communicates in a manner similar to RS-232 without explicit message boundaries. The instrument always terminates messages with a line feed, but because binary data may include bytes that resemble line-feed characters, it may be difficult to distinguish between data and line-feed characters.

Use raw socket as an alternative to VXI-11. Raw socket offers a faster connection than VXI-11. However, raw socket does not support explicit message boundaries, serial poll, and service requests.

Dead socket connection

The dead socket termination (DST) port is used to terminate all existing ethernet connections. A dead socket is a socket that is held open by the instrument because it has not been properly closed. This most often happens when the host computer is turned off or restarted without first closing the socket. This port cannot be used for command and control functions.

Use the dead socket termination port to manually disconnect a dead session on any open socket. All existing ethernet connections will be terminated and closed when the connection to the dead socket termination port is closed.

Confirming port numbers

To view the port number assigned to each remote interface protocol:

1. From the front panel, press the **MENU** key, and then select **LAN > STATUS > PORT**.
2. Use the navigation wheel  to select one of the following:
 - **RAW-SOCKET**
 - **TELNET**
 - **VXI-11**
 - **DST**
3. Press the **ENTER** key to view the port number.
4. Press the **EXIT (LOCAL)** key once to return to the PORT menu.

The following table displays the remote interface protocols supported by the 2601B-PULSE and their assigned port numbers.

Port number

Command interface	Port number
Raw socket	5025
Telnet	23
VXI-11	1024
DST (dead socket termination)	5030

Reset LAN settings

To reset the LAN settings to the factory defaults from the front panel, select **MENU > LAN > RESET**.

LAN troubleshooting suggestions

If you are unable to connect to the web interface of the instrument, check the following items:

- The network cable is in the LAN port on the rear panel of the instrument, not one of the TSP-Link® ports.
- The network cable is in the correct port on the computer. The LAN port of a laptop may be disabled when the laptop is in a docking station.
- The setup procedure used the configuration information for the correct ethernet card.
- The network card of the computer is enabled.
- The IP address of the instrument is compatible with the IP address on the computer.
- The subnet mask address of the instrument is the same as the subnet mask address of the computer.

You can also try restarting the computer and the instrument.

To restart the instrument:

1. Turn the power to the instrument off, and then on.
2. Wait at least 60 seconds for the network configuration to be completed.

Access the instrument web page

To access the instrument web page:

1. Open a web browser on the host computer.
2. Enter the IP address of the instrument in the web browser address box. For example, if the instrument IP address is 192.168.1.101, enter 192.168.1.101 in the browser address box.
3. Press **Enter** on the computer keyboard to open the instrument web page.

NOTE

If the web page does not open in the browser, see [LAN troubleshooting suggestions](#) (on page 2-25).

Viewing LAN status messages

To view the LAN status messages:

1. From the front panel, press the **MENU** key and select **LAN > STATUS > CONFIG/FAULT**.
2. Press the **ENTER** key.

Figure 19: LAN CONFIG/FAULT



There are two types of LAN status messages:

- **LAN fault messages:** Communicate issues related to physical connectivity.
- **LAN configuration messages:** Communicate issues or events related to configuration.

The following table displays possible fault and configuration messages.

LAN CONFIG/FAULT messages

LAN message type	Possible messages
LAN fault	Could not acquire IP address
	Duplicate IP address detected
	DHCP lease lost
	Lan Cable Disconnected
LAN configuration	Starting DHCP Configuration
	DHCP Server Not Found
	DHCP configuration started on xxx.xxx.xxx.xxx
	Searching for DNS server(s)
	Starting DLLA Configuration
	DLLA Failed
	DLLA configuration started on xxx.xxx.xxx.xxx
	Starting Manual Configuration
	Manual configuration started on xxx.xxx.xxx.xxx
Closed	

Monitoring the LAN

The `lan.autoconnect` command configures the instrument to monitor the LAN for lost connections. All ethernet connections are disconnected if the LAN link is disconnected for longer than the time-out value specified in the `lan.linktimeout` attribute.

For detail on these commands, refer to the following command descriptions:

- [lan.autoconnect](#) (on page 11-110)
- [lan.linktimeout](#) (on page 11-118)

Logging LAN trigger events in the event log

You can use the event log to record all LXI triggers generated and received by the 2601B-PULSE. You can view the event log using any command interface or the embedded web interface. The following figure shows the view of the LXI event log from the embedded web interface.

Figure 20: LXI Event Log

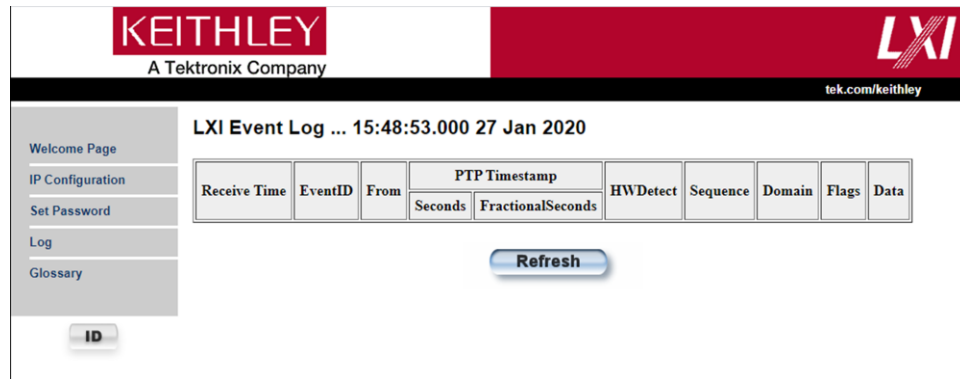

The timestamp, event identifier, IP address, and the domain name identify the incoming and outgoing LXI trigger packets. The following table provides detailed descriptions for the columns in the event log.

Event log descriptions

Column title	Description	Example
Receive Time	Displays the date and time that the LAN trigger occurred in UTC, 24-hour time	11:46:44.000 11 Mar 2020
Event ID	Identifies the <code>lan.trigger[N]</code> that generates an event	LAN0 = <code>lan.trigger[1]</code> LAN1 = <code>lan.trigger[2]</code> LAN2 = <code>lan.trigger[3]</code> LAN3 = <code>lan.trigger[4]</code> LAN4 = <code>lan.trigger[5]</code> LAN5 = <code>lan.trigger[6]</code> LAN6 = <code>lan.trigger[7]</code> LAN7 = <code>lan.trigger[8]</code>
From	Displays the IP address for the device that generates the LAN trigger	localhost 192.168.5.20
Timestamp	A timestamp that identifies the time the event occurred; the timestamp uses the following: <ul style="list-style-type: none"> ▪ PTP timestamp ▪ Seconds ▪ Fractional seconds; the 2601B-PULSE does not support the IEEE Std 1588 standard; the values in this field are always 0 (zero) 	
HWDetect	Identifies a valid LXI trigger packet	LXI
Sequence	Each instrument maintains independent sequence counters: <ul style="list-style-type: none"> ▪ One for each combination of UDP multicast network interface and UDP multicast destination port ▪ One for each TCP connection 	

Event log descriptions

Column title	Description	Example
Domain	Displays the LXI domain number; the default value is 0 (zero)	0
Flags	Contain data about the LXI trigger packet; values are: <ul style="list-style-type: none"> ■ 1 - Error ■ 2 - Retransmission ■ 4 - Hardware ■ 8 - Acknowledgments ■ 16 - Stateless bit 	16
Data	The values for this are always 0 (zero)	

Accessing the event log from the command interface

You can access the event log from any remote command interface. The event log must be enabled before LXI trigger events can be viewed. To enable the event log, send:

```
eventlog.enable = 1
```

To view the event log from a remote interface, send:

```
print(eventlog.all())
```

This command outputs one or more strings similar to the following:

```
14:14:02.000 17 Jun 2019, LAN0, 10.80.64.191, LXI, 0, 1560780842, not available, 0, 0x10,0x00
```

The string displays the same information as the web interface. Commas separate the fields. The fields output in the following order:

- Received time (UTC time)
- Event ID
- From (Sender)
- HWDetect / version
- Domain
- Sequence number
- Timestamp (PTP time)
- Epoch (from 1588)
- Flags
- Data

See the table in [Logging LAN trigger events in the event log](#) (on page 2-27) for detailed descriptions.

To generate log traffic, send the code:

```
local id = 1
lan.trigger[id].ipaddress = lan.status.ipaddress
lan.trigger[id].connect()
for domain = 1, 255 do
  print(domain)
  lan.lxidomain = domain
  lan.trigger[id].assert()
  delay(1)
end
```

GPIB operation

The following topics contain information about GPIB standards, bus connections, and primary address selection.

GPIB standards

The GPIB is the IEEE-488 instrumentation data bus, which uses hardware and programming standards originally adopted by the Institute of Electrical and Electronic Engineers (IEEE) in 1975. The instrument is IEEE Std 488.1 compliant and supports IEEE Std 488.2 common commands and status model topology.

Connect the GPIB cable

To connect an instrument to the GPIB bus, use a cable equipped with standard IEEE-488 connectors, as shown below.

Figure 21: GPIB connector

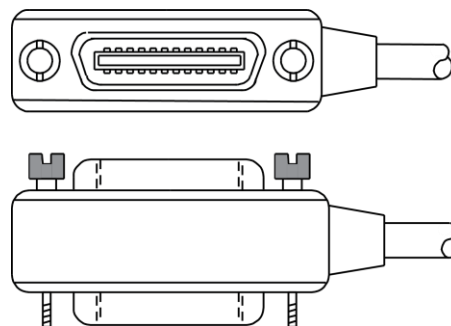

To allow many parallel connections to one instrument, stack the connectors. Each connector has two screws on it to ensure that connections remain secure. The figure below shows a typical connection diagram for a test system with multiple instruments.

CAUTION

To avoid possible mechanical damage, stack no more than three connectors on any one instrument. To minimize interference caused by electromagnetic radiation, use only shielded IEEE-488 cables. Contact Keithley Instruments for shielded cables.

To connect the instrument to the IEEE-488 bus, line up the cable connector with the connector on the rear panel. Install and tighten the screws securely, making sure not to overtighten them. The following figure shows the location of the connector.

Figure 22: IEEE-488 connector location

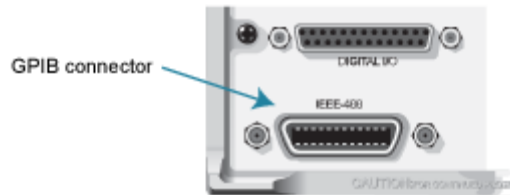





Connect any additional connectors from other instruments as required for your application. Make sure the other end of the cable is properly connected to the controller. You can only have 15 devices connected to an IEEE-488 bus, including the controller. The maximum cable length is either two meters (6.5 feet) multiplied by the number of devices or 20 meters (65.6 feet), whichever is less. Erratic bus operation may occur if you ignore these limits.

Primary address

The 2601B-PULSE ships from the factory with a GPIB primary address of 26. If the GPIB interface is enabled, it momentarily displays the primary address on power-up. You can set the address to a value from 0 to 30, but do not assign the same address to another device or to a controller that is on the same GPIB bus (controller addresses are usually 0 or 21).

To set or check the primary address from the front panel:

1. Press the **MENU** key, select **GPIB**, and then press the **ENTER** key or the navigation wheel .
2. Select **ADDRESS**, then press the **ENTER** key or the navigation wheel .
3. Use the navigation wheel  to set the primary address to the appropriate value, then press the **ENTER** key or the navigation wheel .
4. Press the **EXIT (LOCAL)** key twice to return to the normal display.

To set the primary address remotely:

```
gpiib.address = address
```

To set the primary address remotely to 20:

```
gpiib.address = 20
```

Note that changing the GPIB address takes effect when the command is processed. Any response messages generated after processing this command are sent with the new settings. If command messages are being queued (sent before this command has executed), the new settings may take effect in the middle of a subsequent command message, so be careful when setting this attribute from the GPIB interface.

Terminator

When receiving data over the GPIB, the instrument terminates messages on any line feed character or any data byte with EOI asserted (line feed with EOI asserted is also valid). When sending data, it appends a line feed character to all outgoing messages. The EOI line is asserted with the terminating line feed character.

Front-panel GPIB operation

This section describes aspects of the front panel that are part of GPIB operation, including messages, status indicators, and the LOCAL key.

Error and status messages

The front-panel display may show error and status messages (see [Displayed error and status messages](#) (on page 3-13)). See [Error summary list](#) (on page 12-2) for a list of status and error messages that are associated with IEEE-488 programming. The instrument can be programmed to generate a service request (SRQ), and command queries can be performed to check for specific error conditions.

Communication status indicators

The remote (REM), talk (TALK), listen (LSTN), and service request (SRQ) indicators show the communication bus status. Each of these indicators is described below.

Status indicator	Applies to
REM	GPIB, VXI-11, USB, RS-232
TALK	GPIB only
LSTN	GPIB only
SRQ	GPIB, VXI-11, USB

NOTE

The SRQ applies to all available communication buses, however, actual service requests only apply to GPIB, USB, and VXI-11 (see [Status byte and service request \(SRQ\)](#) (on page 15-15) for more information).

REM

This indicator is illuminated when the instrument is in the remote-control state. When the instrument is in the remote-control state, all front-panel keys, except for the EXIT (LOCAL) key and OUTPUT ON/OFF control, are locked out. When REM is off, the instrument is in the local-control state and front-panel operation is restored.

TALK

This indicator is on when the instrument is in the talker active state. Place the instrument in the talk state by addressing it to talk with the correct talk command. TALK is off when the instrument is in the talker idle state. Place the instrument in the talker idle state by sending a UNT (untalk) command, addressing it to listen, or by sending the IFC (interface clear) command.

LSTN

This indicator is on when the instrument is in the listener active state, which is activated by addressing the instrument to listen with the correct listen command. LSTN is off when the instrument is in the listener idle state. Place the instrument in the listener idle state by sending UNL (unlisten), addressing it to talk, or by sending the IFC (interface clear) command over the bus.

SRQ

You can program the instrument to generate a service request (SRQ) when one or more errors or conditions occur. When this indicator is on, a service request has been generated. This indicator stays on until all conditions that caused the SRQ are cleared.

Note that while the SRQ indicator turns on when a service request is generated, it reflects the state of the master summary status (MSS) bit and not the request for service (RQS) bit (see "Bit 6, Request Service (RQS)/Master Summary Status (MSS)" in the topic [Status Byte Register](#) (on page 15-16) for more detail). Therefore, performing a serial poll will not turn off the indicator. To turn off the indicator, you must clear all the conditions that caused the MSS bit to be set. Refer to [Clearing registers](#) (on page 15-13) for information.

LOCAL key

The EXIT (LOCAL) key cancels the remote state and restores local operation of the instrument. Pressing the EXIT (LOCAL) key turns off the REM indicator and returns the display to normal if a user-defined message was displayed. Pressing the EXIT (LOCAL) key or the OUTPUT ON/OFF control also aborts any commands or scripts that are being processed.

If the LLO (local lockout setting) command is in effect, the EXIT (LOCAL) key is inoperative. For safety reasons, the OUTPUT ON/OFF control can be used to turn the output off while in LLO.

RS-232 interface operation

The following topics contain information about configuring RS-232 communication parameters, sending or receiving command messages, and requesting or retrieving data. To control the 2601B-PULSE, connect a controller or personal computer to the 2601B-PULSE RS-232 interface. Alternatively, you can use the 2601B-PULSE to control another device over RS-232.

Setting RS-232 interface parameters

To set interface parameters from the front panel:

1. Press the **MENU** key, select **RS232**, and then press the **ENTER** key or the navigation wheel .
2. Select and enter the following interface parameters:
 - **BAUD:** Set baud rate (see [Baud rate](#) (on page 2-34))
 - **BITS:** Set number of bits (see [Data bits and parity](#) (on page 2-34))
 - **PARITY:** Set parity
 - **FLOW-CTRL:** Set [Flow control and signal handshaking](#) (on page 2-34)
 - **ENABLE:** Enable or disable the RS-232 interface
3. Press the **EXIT (LOCAL)** key twice to return to the normal display.

Remote RS-232 parameters

Commands to set RS-232 parameters are listed in the following table. See the [TSP command reference](#) (on page 11-1) for more information.

RS-232 interface commands

Command	Description
<code>serial.baud = baud</code>	Set baud rate (300, 600, 1200, 2400, 4800, 9600, 19200, 38400, 57600, 115200)
<code>serial.databits = bits</code>	Set number of bits (7 or 8)
<code>serial.flowcontrol = flow</code>	Set flow control: <code>serial.FLOW_NONE</code> (no flow control) <code>serial.FLOW_HARDWARE</code> (hardware flow control)
<code>serial.parity = parity</code>	Set parity: <code>serial.PARITY_NONE</code> (no parity) <code>serial.PARITY_EVEN</code> (even parity) <code>serial.PARITY_ODD</code> (odd parity)

Changes to a serial port setting take effect when the command is processed. Any response messages generated after the commands are processed will be sent with the new settings. If command messages are being queued (sent before the commands have executed), the new settings may take effect in the middle of a subsequent command message, so be careful when setting these attributes from the RS-232 interface.

RS-232 programming example

The programming example below illustrates how to set the baud rate to 9600 with no flow control:

```
serial.baud = 9600
serial.flowcontrol = serial.FLOW_NONE
```

Sending and receiving data

The RS-232 interface transfers data using 7 or 8 data bits; 1 stop bit; and no, even, or odd parity. Make sure the device you connect to the 2601B-PULSE also uses the same settings.

Terminator

When receiving data over the RS-232 interface, the command interface terminates on line feeds. A line feed is appended to all output messages when the RS-232 interface is being used as a command interface.

Sending data using the `serial.write()` function does not append a terminator. Be sure to append the appropriate terminator to the message before sending it.

Baud rate

The baud rate is the rate at which the 2601B-PULSE and the programming terminal communicate. Select one of the following available rates:

- 115200
- 57600
- 38400
- 19200
- 9600
- 4800
- 2400
- 1200
- 600
- 300

The factory-selected baud rate is 9600.

Both the 2601B-PULSE and the programming terminal must be configured for the same baud rate. Make sure the device connected to the 2601B-PULSE RS-232 port can support the selected baud rate.

Data bits and parity

The RS-232 interface can be configured to send/receive data that is 7 or 8 bits long using even, odd, or no parity.

Flow control and signal handshaking

Signal handshaking between the controller and the instrument allows the two devices to communicate to each other to determine if they are ready to receive data.

The RS-232 interface provides two control lines (RTS and CTS) for this purpose. The instrument will assert the RTS signal when it is admissible for the computer to transmit to the instrument. It will only send information to the computer when the clear to send (CTS) signal is asserted by the computer.

RS-232 connections

Connect the RS-232 serial port of the 2601B-PULSE to the serial port of a computer using a straight-through RS-232 cable terminated with DB-9 connectors. Do not use a null modem cable. The serial port uses the transmit (TXD), receive (RXD), CTS and RTS (if flow control is enabled), and signal ground (GND) lines of the RS-232 standard. The connector location is shown in [Remote communications interfaces](#) (on page 2-11).

If your computer uses a DB-25 connector for the RS-232 interface, you will need a standard cable or adapter with a DB-25 connector on one end and a DB-9 connector on the other.

Figure 23: RS-232 interface connector

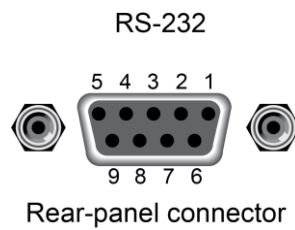

RS-232 connector pinout

Pin number	Description
1	Not used
2	TXD, transmit data
3	RXD, receive data
4	Not used
5	GND, signal ground
6	Not used
7	RTS, ready to send
8	CTS, clear to send
9	Not used

The following table provides pinout identification for the 9-pin (DB-9) or 25-pin (DB-25) serial port connector on the computer.

Computer serial port pinout

Signal*	DB-9 pin number	DB-25 pin number
DCD, data carrier detect	1	8
RXD, receive data	2	3
TXD, transmit data	3	2
DTR, data terminal ready	4	20
GND, signal ground	5	7
DSR, data set ready	6	6
RTS, request to send	7	4
CTS, clear to send	8	5
RI, ring indicator	9	22

* The 2601B-PULSE does not use all RS-232 signals. See the topic [Flow control and signal handshaking](#) (on page 2-34).

Software components for applications and instrument drivers

The majority of software applications and all instrument drivers from Keithley Instruments depend on some, or all, of the following software components:

- NI-VISA
- VISA shared components
- IVI shared components
- NI CVI runtime engine
- NI IVI compliance package
- Keithley instrument driver

These software components are available for download from the [Product Support web page \(tek.com/product-support\)](http://tek.com/product-support).

Instrument driver types

There are several different styles of instrument drivers. Keithley Instruments provides the following instrument drivers for the 2601B-PULSE:

- A native LabVIEW driver
- An IVI-C driver
- An IVI-COM driver

You need to pick the style that best suits the application development environment (ADE) that you are using. For example, if you are using LabVIEW, you would pick a native LabVIEW driver. If a native LabVIEW driver is not available, you can use an IVI-C driver because LabVIEW has the option of creating a wrapper for the IVI-C driver.

LabVIEW supports IVI-COM drivers, but they are not preferred. However, if they are the only driver types available for the instrument, they can be used.

If LabWindows/CVI or C/C++ is your programming language, an IVI-C driver is the best option. For Microsoft® Visual Basic® 6.0 and any .NET language (C#, VB.NET, and so on), an IVI-COM driver is the best option.

Sometimes instrument vendors do not provide all three driver types. Most languages can accommodate other driver types, but this is not optimal.

The following sections describe the different driver types in more detail.

VXIPnP drivers

VXI*plug&play* (VXIPnP) style drivers are Win32 DLLs that have some standard functions defined by the [IVI Foundation \(ivifoundation.org\)](http://ivifoundation.org), such as:

- init
- close
- error_message
- reset
- self_test
- read
- initiate
- fetch
- abort

The application programming interface (API) was defined so that users of instruments would have a familiar API from instrument to instrument. There are some basic guidelines when creating APIs for your instrument, such as using VISA data types and how to construct the CVI hierarchy.

LabVIEW drivers

Native LabVIEW drivers

A native LabVIEW™ driver is a LabVIEW driver that is created using entirely built-in LabVIEW VIs. It does not make any calls to external DLLs or Library files. This makes the driver portable to all the platforms and operating systems that LabVIEW and VISA supports (such as Linux® on x86, Mac OS® X, and Microsoft® Windows®).

National Instruments (NI™) maintains a native [LabVIEW driver style guide \(zone.ni.com/devzone/cda/tut/p/id/3271\)](http://zone.ni.com/devzone/cda/tut/p/id/3271).

LabVIEW driver wrappers

All IVI-C drivers have a function panel file (.fnp) that shows a hierarchy of the function calls into a DLL. It is a tool that guides a user to select the correct function call in the driver, since a DLL only has a flat API entry point scheme (unlike COM or .NET). Any CVI-generated .fnp file can be imported into LabVIEW and LabVIEW will generate a wrapper for the DLL. The drawback here is that the driver is dependent on the DLL, which is not portable and is therefore specific to the Windows operating system.

Getting instrument drivers

To see what drivers are available for your instrument:

1. Go to the [Product Support web page](http://tek.com/product-support) (tek.com/product-support).
2. Enter the model number of your instrument.
3. Select **Software** from the list.
4. Select and download the file.

For LabVIEW™, you can also go to the National Instruments website and search their instrument driver database.

Instrument driver examples

All Keithley drivers come with examples written in several programming languages that show you how to do common tasks with the instruments. The examples are available in the drivers and through Test Script Builder.

IVI shared components

The IVI shared components are similar in concept to the VISA shared components. The IVI Foundation provides class drivers for:

- All the supported instruments (DMM, Scope, Fgen, and so on)
- The configuration store

The IVI shared components also create the installation folders and registry keys that all IVI drivers and support files use for installation.

Interchangeable Virtual Instruments (IVI) style drivers

The [IVI Foundation](http://ivifoundation.org) (ivifoundation.org) defined a set of application programming interfaces (APIs) for instruments, including digital multimeters, arbitrary waveform/function generators, DC power supplies, AC power supplies, oscilloscopes, switches, spectrum analyzers, RF signal generators, and power meters.

There are two types of IVI drivers, IVI-COM and IVI-C. IVI-COM drivers use Microsoft® COM technology to expose driver functionality. IVI-C drivers use conventional Microsoft® Windows® DLLs to export simple C-based functions.

For more information about IVI drivers and the differences between the COM, C, and .NET interfaces, see [Understanding the Benefits of IVI](http://ivifoundation.org/docs/Understanding%20the%20Benefits%20of%20IVI[3].pdf) ([ivifoundation.org/docs/Understanding%20the%20Benefits%20of%20IVI\[3\].pdf](http://ivifoundation.org/docs/Understanding%20the%20Benefits%20of%20IVI[3].pdf)).

NI CVI runtime engine

IVI-C drivers that are created using the National Instruments (NI™) LabWindows/CVI environment depend on either the CVI runtime DLL (`cvirte.dll`) or the instrument support runtime DLL (`instrsup.dll`). These DLLs must be present on the system for them to run.

NI IVI Compliance Package

The National Instruments (NI™) IVI Compliance Package (ICP) is a software package that contains IVI class drivers and support libraries that are needed for the development and use of applications that leverage IVI instrument interchangeability. The IVI Compliance Package also is based on and is compliant with the latest version of the instrument programming specifications defined by the IVI Foundation.

The NI ICP installer installs the IVI shared components, CVI runtime engine, and the instrument support runtime engine.

Keithley I/O layer

The Keithley I/O Layer (KIOL) is a software package that contains several utilities and drivers. It is mainly used as a supplement to IVI drivers or application software like Test Script Builder (TSB).

For additional detail on the Keithley I/O layer, including computer requirements, see the tek.com/keithley website.

Keithley Configuration Panel

The Keithley Configuration Panel is a configuration utility for IVI drivers, similar to NI-MAX. It can also autodetect USBTMC instruments and LAN instruments that support the VXI-11 protocol.

Keithley Communicator

The Keithley Communicator is a dumb terminal program that uses VISA to communicate with the instrument.

How to install the Keithley I/O Layer

NOTE

Before installing, it is a good practice to check the [Product Support web page \(tek.com/product-support\)](http://tek.com/product-support) to see if a later version of the Keithley I/O Layer is available.

You can download the Keithley I/O Layer from the Keithley website.

To install the Keithley I/O Layer from the Keithley website:

1. Download the Keithley I/O Layer Software from the [Product Support web page \(tek.com/product-support\)](http://tek.com/product-support). The software is a single compressed file.
2. Run the downloaded file from the temporary directory.
3. Follow the instructions on the screen to install the software.
4. Reboot your computer to complete the installation.

General bus commands

General commands are commands that have the same general meaning, regardless of the instrument (for example, DCL). The following table lists the general bus commands.

General bus commands

Command	Effect on 2601B-PULSE
DCL	Returns the 2601B-PULSE and all devices on the GPIB to known conditions. See DCL (on page 2-40) for details.
GET	Initiates a trigger. See GET (on page 2-40) for details.
GTL	Cancel remote; restore 2601B-PULSE front-panel operation. See GTL (on page 2-40) for details.
IFC	Goes into talker and listener idle states. See IFC (on page 2-41) for details.
LLO	LOCAL key locked out. See LLO (on page 2-41) for details.
REN	Goes into remote operation when next addressed to listen. See REN (on page 2-41) for details.
SDC	Returns the 2601B-PULSE to known conditions. See SDC (on page 2-41) for details.
SPE, SPD	Serial polls the 2601B-PULSE. See SPE, SPD (on page 2-42) for details.

DCL

Use the device clear (DCL) command to clear the GPIB interface and return it to a known state. Note that the DCL command is not an addressed command, so all instruments equipped to implement DCL will do so simultaneously.

When the 2601B-PULSE receives a DCL command, it:

- Clears the input buffer, output queue, and command queue
- Cancels deferred commands
- Clears any command that prevents the processing of any other device command

A DCL does not affect instrument settings and stored data.

GET

The group execute trigger (GET) command is a GPIB trigger that triggers the instrument to take readings from a remote interface.

GTL

Use the go to local (GTL) command to put a remote-mode instrument into local mode. Leaving the remote state also restores operation of all front-panel controls.

IFC

The interface clear (IFC) command is sent by the controller to place the 2601B-PULSE in the talker idle state and the listener idle state. The instrument responds to the IFC command by canceling illumination of the front-panel TALK or LSTN lights if the instrument was previously placed in one of these states.

Transfer of command messages to the instrument and transfer of response messages from the instrument are not interrupted by the IFC command. If transfer of a response message from the instrument was suspended by IFC, transfer of the message resumes when the instrument is addressed to talk. If transfer of a command message to the instrument was suspended by the IFC command, the rest of the message can be sent when the instrument is addressed to listen.

LLO

When the instrument is in remote operation, all front-panel controls are disabled, except the LOCAL and OUTPUT OFF keys (and the POWER switch). The local lockout (LLO) command disables the LOCAL key, but does not affect the OUTPUT OFF switch, which cannot be disabled.

REN

The remote enable (REN) command is sent to the 2601B-PULSE by the controller to set up the instrument for remote operation. Generally, the instrument should be placed in the remote mode before you attempt to program it over the bus. Setting REN to true does not place the instrument in the remote state. You must address the instrument to listen after setting REN to true before it goes into remote operation.

SDC

The selective device clear (SDC) command is an addressed command that performs essentially the same function as the device clear (DCL) command. However, because each device must be individually addressed, the SDC command provides a method to clear only selected instruments, instead of clearing all instruments simultaneously with the DCL command.

When the 2601B-PULSE receives an SDC command, it:

- Clears the input buffer, output queue, and command queue
- Cancels deferred commands
- Clears any command that prevents the processing of any other device command

An SDC call does not affect instrument settings and stored data.

SPE, SPD

Use the serial polling sequence to obtain the 2601B-PULSE serial poll byte. The serial poll byte contains important information about internal functions (see [Status model](#) (on page 15-1)). Generally, the serial polling sequence is used by the controller to determine which of several instruments has requested service with the SRQ line. The serial polling sequence may be performed at any time to obtain the status byte from the 2601B-PULSE.

Using the interlock

You can set up an interlock for the 2601B-PULSE through the 2601B-P-INT Interlock and Cable Connector Box. When properly used, the output of the instrument turns OFF when the safety fixture switch opens.

The interlock requires a separate safety fixture switch that is wired to the interlock input on the 2601B-P-INT. For the interlock voltage, you can use the +5 V source pins of the 2601B-PULSE digital I/O port or an external +5 V source.

It also requires use of the Keithley Model CS-1616-3 Safety Interlock Mating Connector, which is supplied with the instrument. This part is also available from 3M, part number 37103-A165-00E.

See [DUT Test Connections](#) (on page 4-6) for important safety information when using a test fixture.

WARNING

When an interlock is required for safety, a separate circuit should be provided that meets the requirements of the application to reliably protect the operator from hazardous conditions. The digital I/O port is a suitable source for the 5 V required to power the physical interlock provided by the 2601B-P-INT. Failure to adhere to these guidelines could result in personal injury or death.

WARNING

The 2601B-PULSE with the 2601B-P-INT installed provides an optional interlock circuit. Once engaged, the interlock helps facilitate the safe operation of the instrument in a test system by prohibiting the output voltage and current when the interlock circuit is opened. Not using the interlock could expose the operator to hazardous conditions within the test circuit that could result in personal injury or death.

Interlock operation

You can set up the interlock using the +5 V supply pins on the digital I/O port on the rear panel of the instrument or by using an external 5 V source. Both methods use the Model 2601B-P-INT Interlock and Cable Connector Box to make connections.

With either method, relays in the 2601B-P-INT are in a de-energized state until a remote switch is closed. The de-energized state prevents current from passing to the device under test (DUT) by keeping the FORCE HI terminal shorted to the FORCE LO terminal. When the external safety switch closes, current is sourced from a +5 V pin on the digital I/O port or the external power supply, which energizes the relay and opens the shorting contacts. When the contacts are open, the 2601B-PULSE can source power to the DUT.

If the remote switch is part of a test fixture, if the lid of the test fixture opens, the relay is closed and the output of the 2601B-PULSE instrument turns off. When the lid is closed, the relay contacts open and the output can be turned on.

To use the interlock, you must set the jumper on the rear panel of the 2601B-P-INT to ENABLE. Refer to [Installing the 2601B-P-INT](#) (on page 2-6) for information on setting the jumper.

When the jumper is set to ENABLE, the safety interlock relay immediately requires 5 V to open. Depending on the availability of the 5 V signal, the short is applied to or removed from the Force HI and LO terminals on the 2601B-P-INT, regardless of the interlock setting made through the front panel or by using the remote commands.

To synchronize the operation of the 2601B-PULSE output with the jumper setting of the 2601B-P-INT, you must also enable the interlock through the front panel or by using the remote commands.

To enable the interlock through the front panel:

1. Press the **CONFIG** key.
2. Select the **OUTPUT** menu item.
3. Select **INTERLOCK**.
4. Select **DISABLE** to disable the interlock or **ENABLE** to enable it.

To enable the interlock using a remote command, send:

```
smua.interlock.enable = smua.ENABLE
```

To disable the interlock using a remote command, send:

```
smua.interlock.enable = smua.DISABLE
```

Interlock connections through digital I/O port

The following figure shows digital I/O port pin 20 as ground. You can also use pin 15, 16, 17, 18, 19, or 21 as ground.

The +5 V source is shown as digital I/O port pin 22. You can also use pin 23 or 25 as the +5 V source. Use a two-conductor low-voltage cable to connect the +5 V source to the low-voltage remote switch. The recommended cable is 22 AWG (20 AWG maximum) with 1.2 mm to 1.6 mm outer diameter.

Figure 24: Digital I/O port interlock connections

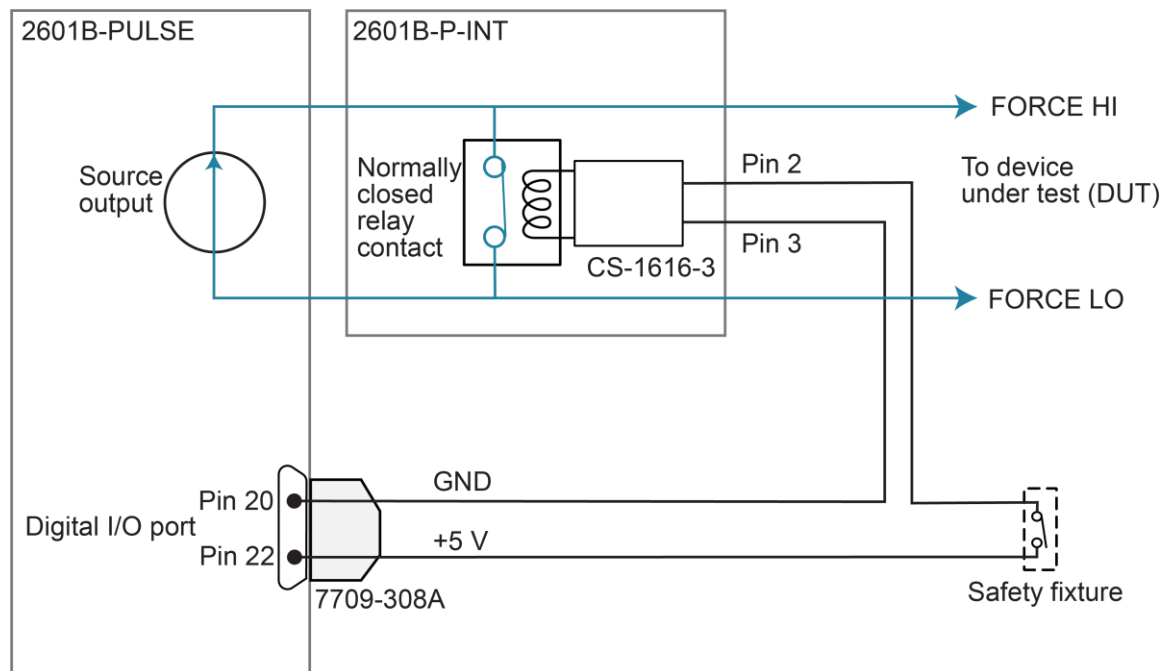

Interlock connections using external source

Use a +5 V external power supply with a $\pm 5\%$ tolerance. The 2601B-P-INT interlock requires approximately 125 mA to operate.

Use a two-conductor low-voltage cable to connect the +5 V source to the low-voltage remote switch. The recommended cable is 22 AWG (20 AWG maximum) with 1.2 mm to 1.6 mm outer diameter.

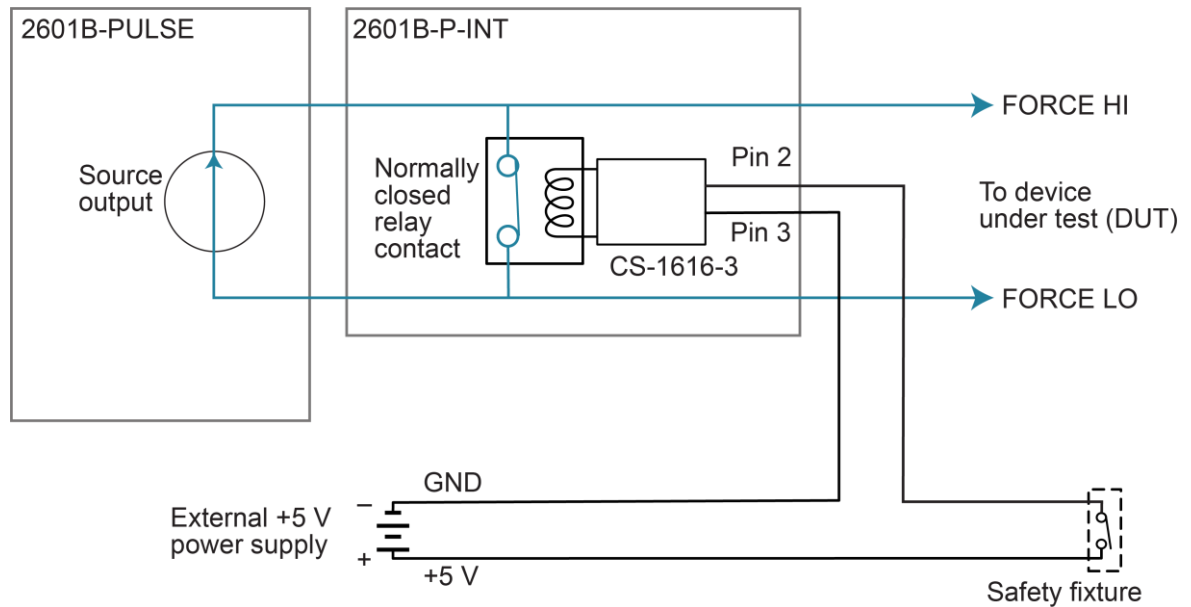
Figure 25: External source interlock connections

Wiring the interlock mating connector

Use the Keithley Instruments CS-1616-3 Safety Interlock Mating Connector supplied with the 2601B-PULSE to make the interlock connection to the 2601B-P-INT. You must supply connection wire. When using the CS-1616-3 interlock mating connector with a Keithley instrument, use the following recommendations for choosing a connection wire:

- Copper alloy
- 7 to 19 bare and tinned strands
- 0.25 mm² to 0.50 mm², 20 AWG to 24 AWG
- Flexible vinyl, semi-flexible vinyl, polyethylene, cross-linked polyethylene, or PTFE

To ensure proper interlock operation, the combined resistance of the external interlock switch and connection wires must be less than 10 Ω when the switch is closed.

To assemble the interlock:

1. Insert the wire into the CS-1616-3.
2. Use a pair of pliers to squeeze the connector sections together.

NOTE

You cannot disassemble and reuse the CS-1616-3.

The interlock pin locations and connections are shown in the following figure. The pins are:

- Pin 3: Earth and chassis ground
- Pin 2: Interlock
- Pin 1 (next to tab): +6 V dc out (current limited)

Figure 26: Interlock mating connector pins

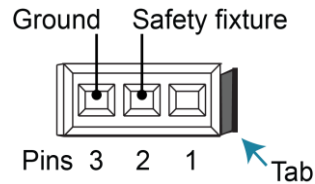

System information

You can retrieve serial number, firmware revision, calibration dates, and memory usage from the instrument.

To view the system information from the front panel:

1. Press the **MENU** key.
2. Select **SYSTEM-INFO**.
3. Select one of the following:
 - **FIRMWARE**
 - **SERIAL#**
 - **CAL**
 - **MEMORY-USAGE**

To retrieve system information from a remote interface:

To retrieve the firmware revision and serial number, send the `*IDN?` query (see [Identification query: *IDN?](#) (on page 14-3) for more information).

To determine memory usage, see the [meminfo\(\)](#) (on page 11-148) function.

To determine when calibration was last run, see [smua.cal.date](#) (on page 11-180).

To determine when calibration is due, see [smua.cal.due](#) (on page 11-181).

Instrument description

In this section:

Controls, indicators, and connectors	3-1
Menu overview	3-7
Beeper	3-13
Displayed error and status messages	3-13
Display operations.....	3-14
USB storage overview.....	3-28

Controls, indicators, and connectors

2601B-PULSE controls, indicators, and the USB port are on the [front panel](#) (on page 3-1). Make connections to the 2601B-PULSE through connectors on the [rear panel](#) (on page 3-5).



Front panel

The front panel of the 2601B-PULSE is shown below. The descriptions of the front-panel controls, USB port, and indicators follow the figure.

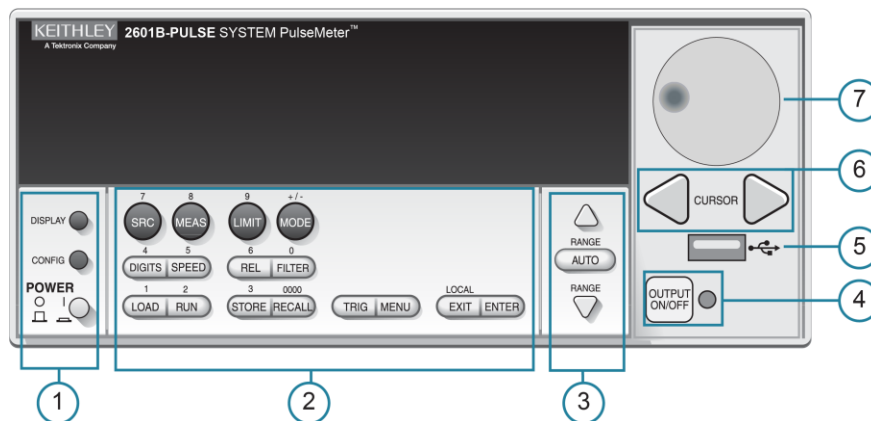
Figure 27: 2601B-PULSE front-panel controls



1. Power switch, display, and configuration keys

- 
POWER
 Power switch. The in position turns the 2601B-PULSE on (I); the out position turns it off (O).
- 
DISPLAY
 Toggles between the source-measure or pulser display and the user message display.
- 
CONFIG
 Configures a function or operation.

2. SMU setup, performance control, special operation, and numbers

SMU (source-measure unit) setup



SRC	When the pulser is disabled, selects the source function (voltage or current) and places the cursor in the source field for editing. When the pulser is enabled, this key has no action.
MEAS	Cycles through measure functions (voltage, current, resistance, or power).
LIMIT	When the pulser is disabled, places the cursor in the compliance limit field for editing. Also selects the limit value to edit (voltage, current, or power). When the pulser is enabled, switches the display between the source and sense protection levels.
MODE	Selects a meter mode (I-METER, V-METER, OHM-METER, or WATT-METER).

Performance control



DIGITS	Sets the display resolution (4½, 5½, or 6½ digits).
SPEED	Sets the measurement speed (FAST, MEdium, NORMAL, HI-ACCURACY, or OTHER). Speed and accuracy are set by controlling the measurement aperture. Also see Speed (on page 4-60).
REL	Controls relative measurements, which allows a baseline value to be subtracted from a reading.
FILTER	Enables or disables the digital filter. You can use this filter to reduce reading noise.

Special operation



LOAD	Loads a test for execution (FACTORY, USER, or SCRIPTS).
RUN	Runs the last selected factory or user-defined test.
STORE	Accesses reading buffers and makes readings: <ul style="list-style-type: none"> ▪ TAKE_READINGS: Use to make readings and store them in a reading buffer. ▪ SAVE: Use to save a reading buffer to nonvolatile memory or to a user-installed flash drive (USB1) in CSV or XML format. Readings can include measurements, source values, and timestamp values.
RECALL	Recalls information (DATA or STATISTICS) stored in a reading buffer: <ul style="list-style-type: none"> ▪ DATA includes stored readings, and if configured, source values and timestamp values. ▪ STATISTICS includes MEAN, STD DEV, SAMPLE SIZE, MINIMUM, MAXIMUM, PK-PK.
TRIG	Triggers readings.
MENU	Accesses the main menu (on page 3-8). The main menu can be used to configure many functions and features.
EXIT	Cancels the selection and returns to the previous menu or display. Also used as a LOCAL key to take the instrument out of remote operation.
ENTER	Accepts the selection and moves to the next choice or exits the menu.

Numbers

Number keys

When enabled and in EDIT mode, the number keys (0-9, +/-, 0000) allow direct numeric entry. Press the navigation wheel  to enter EDIT mode. For more information, see [Setting a value](#) (on page 3-11).

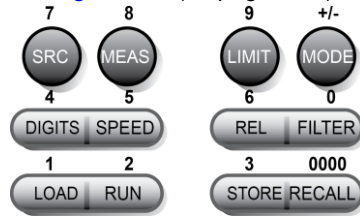

3. Range keys



The RANGE and AUTO keys are only active when the pulser is disabled. Selects the next higher source or measure range.



Enables or disables source or measure autorange.



Selects the next lower source or measure range.

In addition to selecting range functions, the up and down range keys change the format for non-range numbers, such as when editing the limit value.

4. Output control



Turn the source output on or off.

5. USB port



Use the USB port to connect a USB flash drive to the instrument. You can use the USB flash drive to store reading buffer data, scripts, and user setups. You can also use it to upgrade the firmware.

6. Cursor keys

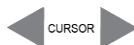

Use the CURSOR keys to move the cursor left or right. When the cursor is on the source or compliance value digit, press the navigation wheel  to enter edit mode, and turn the navigation wheel to edit the value. Press the navigation wheel again when you finish editing.

Use the CURSOR keys or the navigation wheel to move through menu items. To view a menu value, use the CURSOR keys for cursor control, and then press the navigation wheel to view the value or submenu item.

7. Navigation wheel

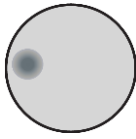

Turn the navigation wheel  to:

- Move the cursor to the left and the right (the cursor indicates the selected value or item)
- While in edit mode, increase or decrease a selected source or compliance value

Push the navigation wheel  to:

- Enable or disable edit mode for the selected source or compliance value
- Open menus and submenu items
- Select a menu option or a value

8. Display indicators (not shown)

The items listed below represent the possible display indicators and their meanings.

Indicator	Meaning
4W	Remote (4-wire) sense selected
AUTO	Source or measure autorange is selected
EDIT	Instrument is in editing mode
ERR	Questionable reading or invalid calibration step
FILT	Digital filter is enabled
LSTN	Instrument is addressed to listen
REL	Relative mode is enabled
REM	Instrument is in remote mode
SRQ	Service request is asserted
TALK	Instrument is addressed to talk
* (asterisk)	Readings are being stored in the buffer

Rear panel

The 2601B-PULSE rear panel with the 2601B-P-INT installed is shown below. The descriptions of the rear-panel components follow the figure.

Figure 28: Rear panel

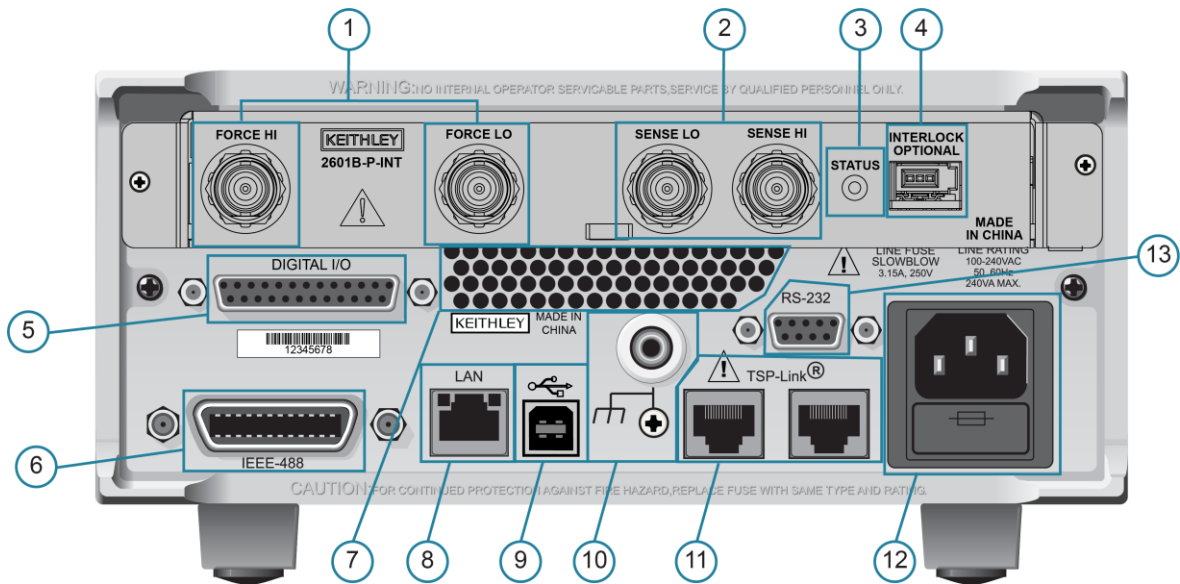

1. FORCE HI and FORCE LO connectors



These connectors provide connections for FORCE HI and FORCE LO. Refer to [FORCE and SENSE connectors](#) (on page 4-8) for additional information.

2. SENSE LO and SENSE HI connectors

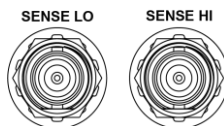

These connectors provide connections for SENSE LO and SENSE HI. Refer to [FORCE and SENSE connectors](#) (on page 4-8) for additional information.

3. STATUS indicator



This LED indicates the status of the interlock. When the interlock is not asserted, the indicator is off. When the interlock is asserted, the indicator is on.

4. INTERLOCK connector



This connector provides a connection for the optional interlock. Refer to [Using the interlock](#) (on page 2-42) for information on setting up and connecting the interlock.

5. Digital I/O



Female DB-25 connector. Use a cable equipped with a male DB-25 connector (Keithley Instruments part number CA-126-1A; L-com part number CSMN25MF-5).

Pins provided:

- Fourteen digital input or output pins
- Seven GND pins
- Three +5 V pins

6. IEEE-488

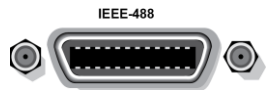

Connector for IEEE-488 (GPIB) operation. Use a shielded cable, such as the Keithley Instruments Model 7007-1 or Model 7007-2.

7. Cooling exhaust vents

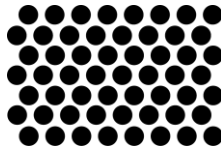

Exhaust vent for the internal cooling fan. Keep the vent free of obstructions to prevent overheating. Also see [Cooling vents](#) (on page 2-8).

8. LAN



RJ-45 connector for a local area network (LAN). The LAN interface supports Auto-MDIX, so either a CAT-5e crossover cable (provided), or a normal CAT-5e straight-through cable (not provided) can be used.

9. USB port



This USB-2.0 receptacle (Type B) located on the rear panel is used to connect the instrument to a computer. You can use this connection to send commands to the instrument.

10. Ground



Ground terminal for connecting output HI or LO to chassis ground.
Ground screw for connecting to chassis ground.

11. TSP-Link

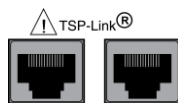

Expansion interface that allows a 2601B-PULSE and other TSP-enabled instruments to trigger and communicate with each other.

12. Power module

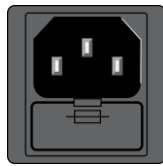

Contains the ac line receptacle and power line fuse. The instrument can operate on line voltages of 100 V ac to 240 V ac at line frequencies of 50 Hz or 60 Hz.

13. RS-232



Female DB-9 connector. For RS-232 operation, use a straight-through (not null modem) DB-9 shielded cable (Keithley Instruments Model 7009-5) for connection to the computer.

Menu overview



The following topics describe how to work with the front-panel menus.

Menu navigation



To navigate through the menus and submenus, the 2601B-PULSE must not be in edit mode (the EDIT indicator is not illuminated).

Selecting menu items

To navigate the Main and Configuration menus, use the editing keys as follows:

- Press either **CURSOR** arrow key to highlight an option.
- Rotate the navigation wheel  (clockwise or counterclockwise) to highlight an option.
- Press the **ENTER** key (or the navigation wheel ) to select an option.
- Use the **EXIT (LOCAL)** key to cancel changes or to return to the previous menu or display.

NOTE

For quick menu navigation, turn the navigation wheel  to highlight an option and then press the navigation wheel  to select the highlighted option.

Menu trees

You can configure instrument operation through the menus that are accessed from the front panel.



Main menu

The main menu structure is summarized in the following figure and table. For other menu items, see [Configuration menus](#) (on page 3-10).

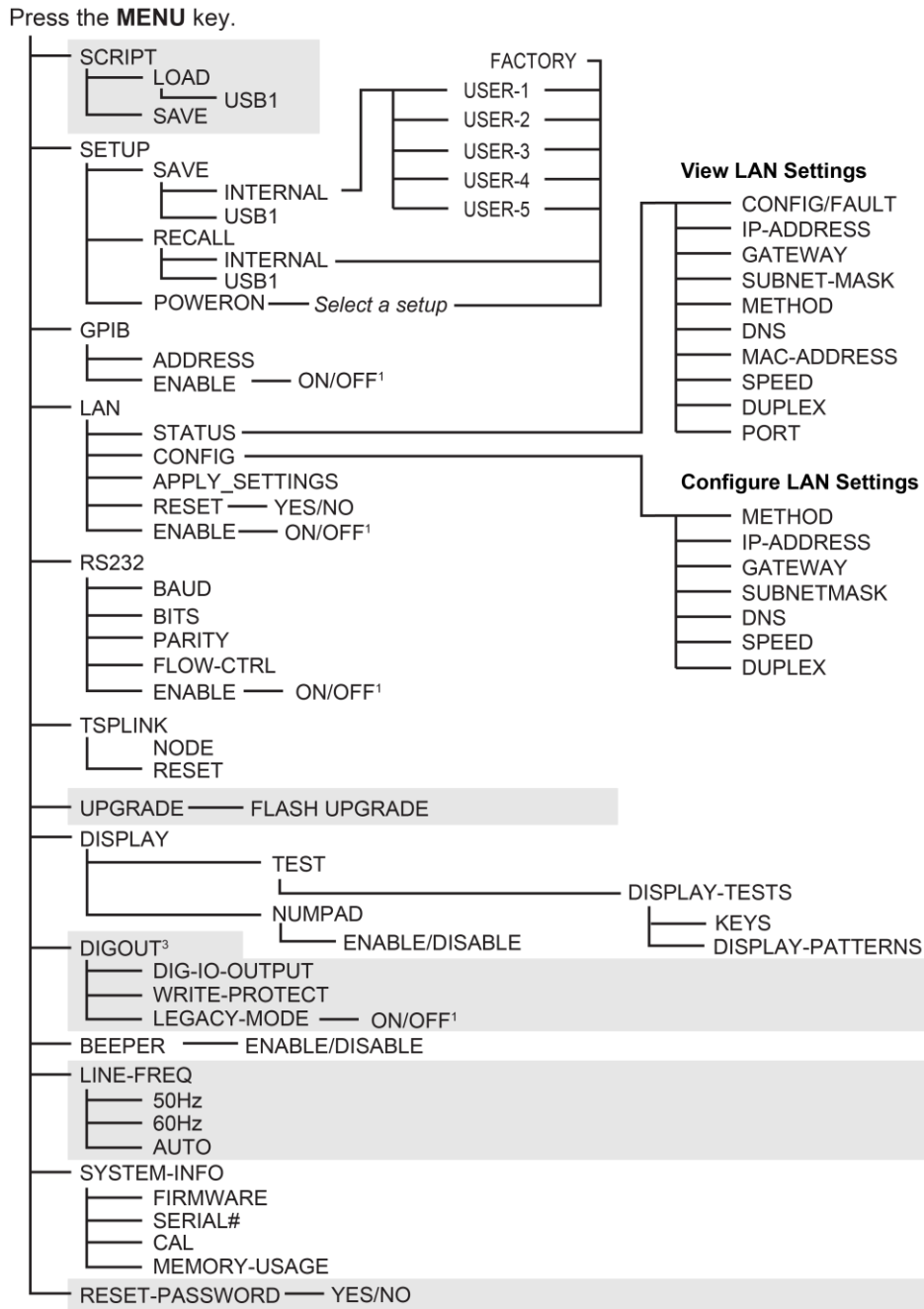
Figure 29: Main menu tree



1. Mutually exclusive

The following table contains descriptions of the main menu options and cross-references to related information. To access a menu option, press the **MENU** key, turn the navigation wheel  to move the cursor to select an item, and press the navigation wheel .

Menu selection	Description	For more information, see:
SCRIPT - LOAD - SAVE	Saves and recalls user scripts Loads scripts into nonvolatile memory Saves scripts	Manage scripts (on page 10-3)
SETUP - SAVE - RECALL - POWERON	Saves and recalls user and factory setup options Saves user setup options Recalls user setup options Sets the configuration used during startup	Saved setups (on page 4-51)
GPIB - ADDRESS - ENABLE	Configures the GPIB interface options Configures the address for the GPIB interface Enables and disables the GPIB interface	Remote communications interfaces (on page 2-11)
LAN - STATUS - CONFIG - APPLY_SETTINGS - RESET - ENABLE	Configures the local area network (LAN) Displays LAN connection status Configures the LAN IP address and gateway Applies changes made using the CONFIG menu Restores the default settings Enables and disables the LAN interface	LAN communications (on page 2-15)
RS232 - BAUD - BITS - PARITY - FLOW-CTRL - ENABLE	Controls the options for the RS-232 interface Sets the baud rate Configures the number of bits Sets the parity Configures the flow control Enables and disables the RS-232 interface	Remote communications interfaces (on page 2-11)
TSPLINK - NODE - RESET	Configure the instrument in a TSP-Link [®] network Selects the instrument node identifier Resets the TSP-Link network	TSP-Link system expansion interface (on page 10-45)
UPGRADE	Upgrades the firmware from a USB flash drive	Upgrading the firmware (on page 8-5)
DISPLAY - TEST - NUMPAD	Accesses display functions Runs the display test Enables and disables the numeric keypad	Front panel tests (on page 8-3) See Numeric entry method in Setting a value (on page 3-11)
DIGOUT - DIG-IO-OUTPUT - WRITE-PROTECT - LEGACY-MODE	Controls digital outputs Selects the digital I/O values Write-protects specific digital I/O lines Sets digital I/O to work like an older SourceMeter instrument	Digital I/O (on page 6-36)
BEEPER - ENABLE - DISABLE	Controls the key beeps Enables the key beeps Disables the key beeps	Beeper (on page 3-13)
LINE-FREQ - 50Hz - 60Hz - AUTO	Configures the line frequency Set the line frequency to 50 Hz Set the line frequency to 60 Hz Enables automatic line-frequency detection during start up	Line frequency configuration (on page 2-11)
SYSTEM-INFO - FIRMWARE - SERIAL# - CAL - MEMORY-USAGE	Displays the system information Displays the version of firmware installed Displays the serial number of the unit Displays the last calibration date Displays memory usage in percentage	System information (on page 2-46)
RESET-PASSWORD	Resets the system password	Password management (on page 10-34)

Configuration menus

The configuration menu structure is summarized in the following figure and table. For directions on navigating the menu, see [Menu navigation](#) (on page 3-7). For other menu items, see [Main menu](#) (on page 3-8).

Figure 30: CONFIG menu tree

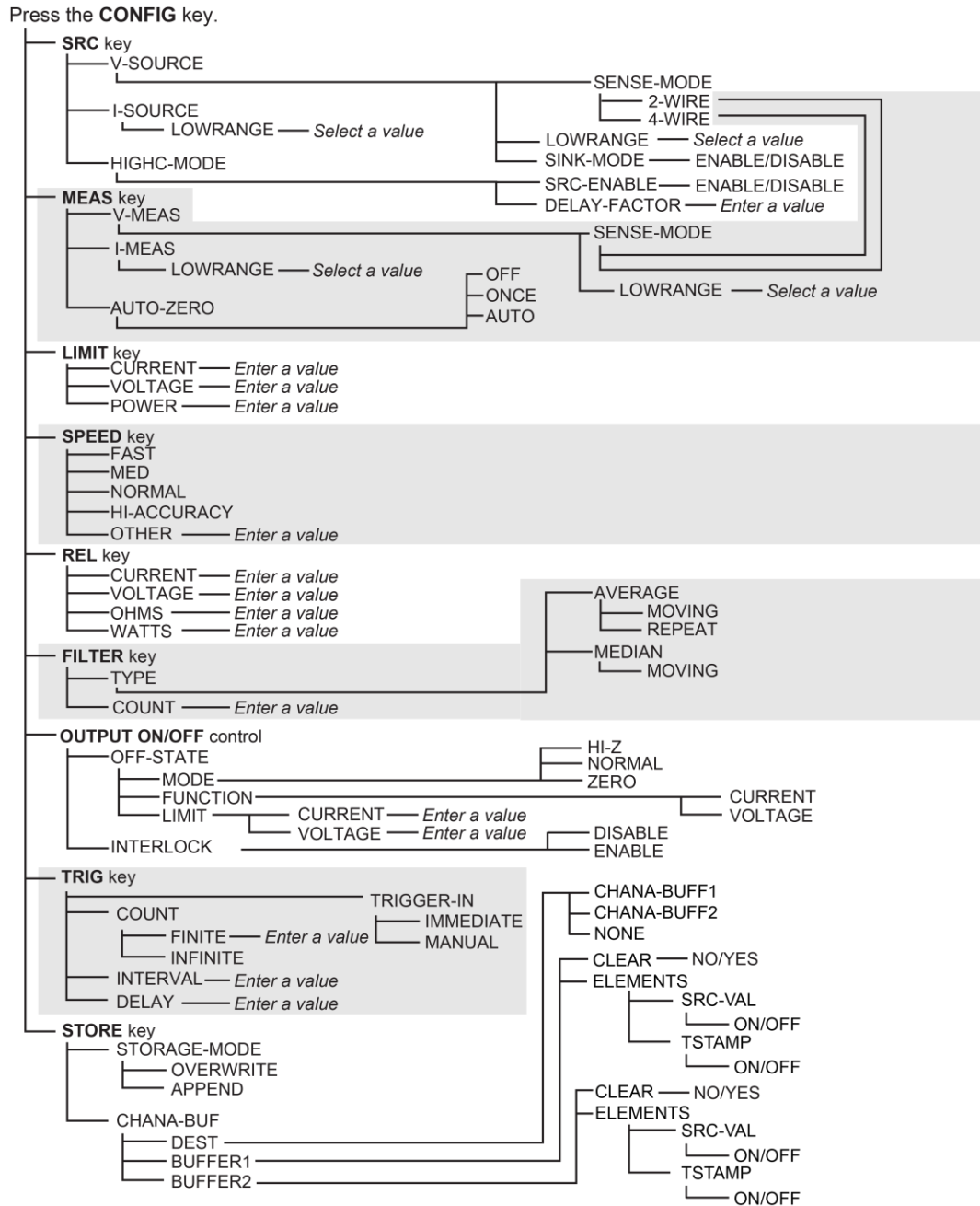

NOTE

Press the **EXIT** key to return to a previous menu.

Descriptions of the configuration menus

The following table contains descriptions of the configuration menus and cross-references to related information.

To access, press the CONFIG key and then:	Options	For more information, see:
SRC	V-source sense and low range; I-source low range; and high capacitance mode	Range (on page 4-54), Basic source-measure procedure (on page 4-30)
MEAS	V and I-measure range, V-measure sense, low range, and autozero	Range (on page 4-54), Basic source-measure procedure (on page 4-30)
LIMIT	V-source and I-source compliance limits	Limits (on page 4-2)
SPEED	Measurement speed (NPLC)	Speed (on page 4-60)
REL	Set relative values	Relative offset (on page 4-75)
FILTER	Control digital filter	Filters (on page 4-77)
OUTPUT ON/OFF	Set off-state, interlock	Output-off states (on page 4-26), Using the interlock (on page 2-42)
STORE	Set buffer count and destination	Source-measure concepts (on page 7-1)
TRIG	Set trigger in, count, interval, and delay	Triggering (on page 6-1)

Setting values



Through the front panel, you can adjust a value using either the **Navigation wheel method** or **Numeric entry method** (using the keypad).

NOTE



When the pulser is enabled, you cannot adjust values through the front panel.

Setting a value

Navigation wheel method:

1. Use the **CURSOR** arrow keys (or turn the navigation wheel ) to move the cursor to the digit that needs to be changed.
2. Press the navigation wheel  or the **ENTER** key to enter edit mode. The EDIT indicator is illuminated.
3. Rotate the navigation wheel  to set the appropriate value.
4. Press the **ENTER** key to select the value or press the **EXIT (LOCAL)** key to cancel the change.
5. To return to the main menu, press the **EXIT (LOCAL)** key.

Numeric entry method:

1. If the keypad is disabled, press the **MENU** key, then select **DISPLAY > NUMPAD > ENABLE**.
2. Use the **CURSOR** arrow keys (or turn the navigation wheel ) to move the cursor to the value that needs to be changed.
3. Press the navigation wheel  or the **ENTER** key to enter edit mode. The EDIT indicator is illuminated.
4. Press any of the number keys (0-9, +/-, 0000) (see [2. SMU setup, performance control, special operation, and numbers](#) (on page 3-3)). The cursor moves to the next digit on the right.
5. Repeat the above steps as required to set the values.
6. Press the **ENTER** key to select the value or press the **EXIT (LOCAL)** key to cancel the change.
7. To return to the main menu, press the **EXIT (LOCAL)** key.

NOTE

To set a value to zero, press the **0000** numeric entry key. To toggle the polarity of a value, press the **+/-** numeric entry key.



Setting source and compliance values

When the 2601B-PULSE is in the edit mode (EDIT indicator is on), the editing controls are used to set source and compliance values. Note that when you edit the source value, source autoranging is turned off and remains off until you turn it on again.

NOTE

To cancel source editing, press the **EXIT (LOCAL)** key.

To edit the source value:

1. Press the **SRC** key. The cursor flashes in the source value field.
2. Use the **CURSOR** keys (or turn the navigation wheel ) to move the cursor to the digit that needs to be changed.
3. Press the navigation wheel  or the **ENTER** key to edit the source value. The EDIT indicator is illuminated.
4. Change the source value (see [Setting a value](#) (on page 3-11)).

NOTE

The **+/-** key toggles the polarity. The **0000** key sets the value to 0.

5. When finished, press the **ENTER** key (the EDIT indicator is not illuminated).

To edit compliance limit values:

1. Press the **LIMIT** key.
2. Select the type of compliance.
3. Press the navigation wheel or the **ENTER** key to enter edit mode. The EDIT indicator is illuminated.
4. Change the compliance value (see [Setting a value](#) (on page 3-11)).
5. When finished, press the **ENTER** key (the EDIT indicator is not illuminated).

NOTE

The up and down range keys change the format of the limit value.

Beeper

The 2601B-PULSE includes a beeper. When it is enabled, a beep indicates one of the following actions have occurred:

- **A front-panel key was pressed:** A short beep, similar to a key click, is issued.
- **The navigation wheel  was turned or pressed:** A short beep is issued.
- **The output source was changed:** A longer beep is issued when you select the OUTPUT ON/OFF control (turn the output on or off).

To turn the beeper on or off from the front panel:

1. Press the **MENU** key, and then select **BEEPER**.
2. Select one of the following:
 - **ENABLE**
 - **DISABLE**

To turn the beeper on or off from the TSP command interface:

Set the `beeper.enable` attribute. For example, to enable the beeper, send:

```
beeper.enable = 1
```

Displayed error and status messages

During operation and programming, front-panel messages may be briefly displayed. Typical messages are either status or error notifications (refer to the [Error summary list](#) (on page 12-2) for a complete list of these messages and their meanings).

NOTE

Status and error messages are held in a queue. For information about retrieving messages from queues, refer to [Queues](#) (on page 15-2). For information about error messages, refer to the [Troubleshooting guide](#) (on page 12-1).

Display operations

This section describes methods for using the display and determining what is displayed.

Display mode

Use the DISPLAY key to scroll through the display modes shown in the figure below.

Figure 31: Display modes when the pulser is disabled

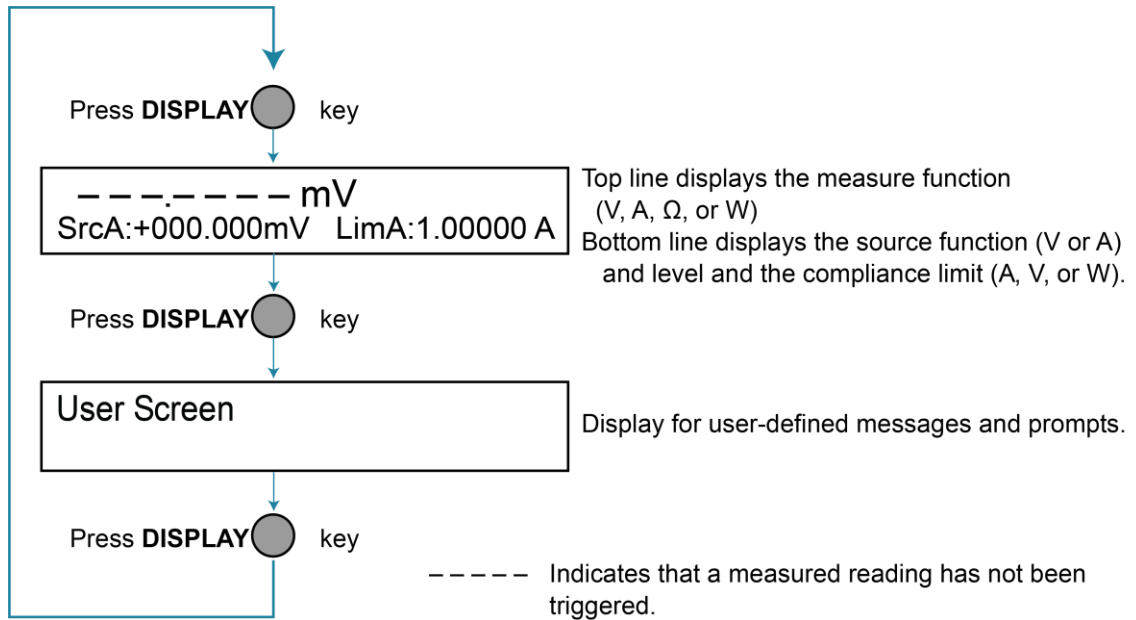
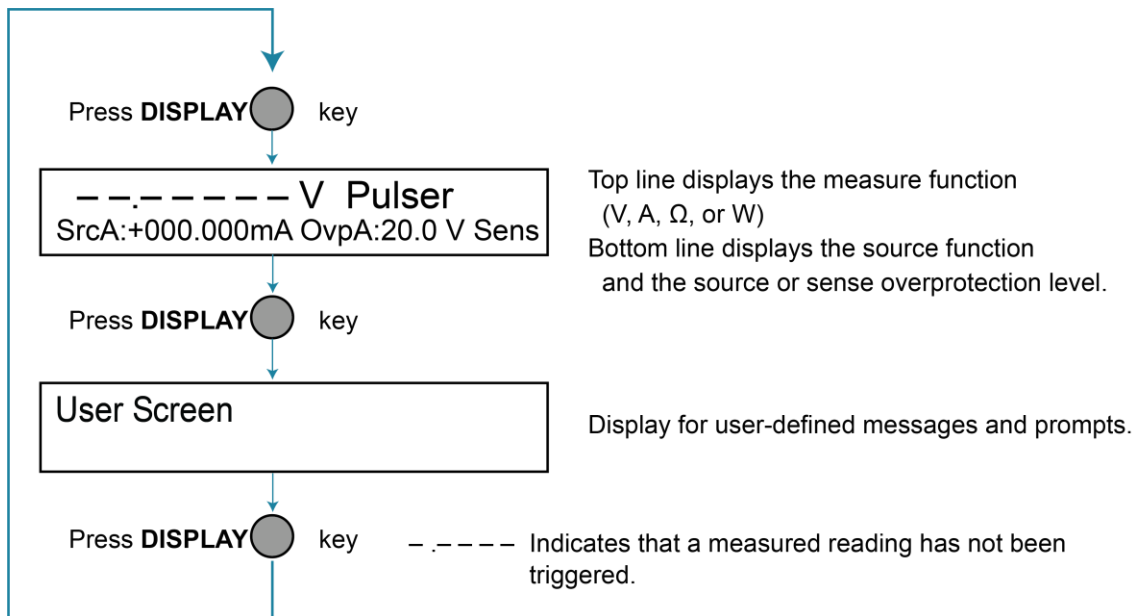

Figure 32: Display modes when the pulser is enabled



Display functions and attributes

The display functions and attributes for the front panel are described in this section. The following table lists each display function and attribute in alphabetical order and cross references it to the topic where the function or attribute is explained.

The [TSP command reference](#) (on page 11-1) provides additional information about the display functions and attributes.

Cross-referencing functions and attributes to section topics

Function or attribute	Section topic
<code>display.clear()</code>	Clearing the display (on page 3-17)
<code>display.getannunciators()</code>	Indicators (on page 3-23)
<code>display.getcursor()</code>	Cursor position (on page 3-18)
<code>display.getlastkey()</code>	Capturing key-press codes (on page 3-26)
<code>display.gettext()</code>	Displaying text messages (on page 3-19)
<code>display.inputvalue()</code>	Parameter value prompting (on page 3-21)
<code>display.loadmenu.add()</code> <code>display.loadmenu.catalog()</code> <code>display.loadmenu.delete()</code>	Load test menu (on page 3-24)
<code>display.locallockout</code>	LOCAL lockout (on page 3-24)
<code>display.menu()</code>	Menu (on page 3-21)
<code>display.numpad</code>	Setting a value (on page 3-11)
<code>display.prompt()</code>	Parameter value prompting (on page 3-21)
<code>display.screen</code>	Display screen (on page 3-16)
<code>display.sendkey()</code>	Sending key codes (on page 3-26)
<code>display.setcursor()</code>	Cursor position (on page 3-18)
<code>display.settext()</code>	Displaying text messages (on page 3-19)
<code>display.smua.digits</code>	Display resolution (on page 3-16)
<code>display.smua.limit.func</code>	Limit functions (on page 3-16)
<code>display.smua.measure.func</code>	Measurement functions (on page 3-16)
<code>display.trigger.clear()</code> <code>display.trigger.wait()</code>	Display trigger wait and clear (on page 3-16)
<code>display.waitkey()</code>	Capturing key-press codes (on page 3-26)

Display features

You can set the front-panel display to display the units of measure, number of digits, and customized text messages for your applications.

Display screen

The front panel displays source-measure values and readings or user-defined messages. The display screen options include:

- **Source-measure, compliance screens:** Display SMU source-measure readings and compliance values.
- **User screen:** Display user-defined messages and prompts.

Configure the type of source-measure and compliance displayed by setting the `display.screen` attribute. The following programming example illustrates how to display source-measure and compliance values, and measure readings for SMU A:

```
display.screen = display.SMUA
```

Measurement functions

With a source-measure screen selected, the measured reading can be displayed as volts, amperes, ohms, or watts. Configure the type of measured reading displayed by setting the `display.smua.measure.func` attribute. The following programming example illustrates how to display ohms measurements:

```
display.smua.measure.func = display.MEASURE_OHMS
```

Limit functions

When the pulser is disabled, the displayed limit value is either the primary limit value (current or voltage) or the power limit value. Configure the type of limit function that is displayed by setting the `display.smua.limit.func` attribute. The following programming example illustrates how to display the power limit setting:

```
display.smua.limit.func = display.LIMIT_P
```

When the pulser is enabled, the sense and source protection levels are displayed. Use the LIMIT key to switch between the sense and source protection level.

Display resolution

Display resolution for measured readings can be set to 4-1/2, 5-1/2 or 6-1/2. Configure the type of resolution displayed by setting the `display.smua.digits` attribute. The following programming example illustrates how to set 5-1/2 digit resolution for measured readings:

```
display.smua.digits = display.DIGITS_5_5
```

Display trigger wait and clear

To set the instrument to wait for the front-panel TRIG key to be pressed, send the `display.trigger.wait()` function. To clear the trigger event detector, send the `display.trigger.clear()` function.

Display messages

You can define text messages that can be displayed on the front panel of the instrument. Most of the display functions and attributes that are associated with display messaging will automatically select the user screen. The attribute for the display screen is explained in [Display screen](#) (on page 3-16).

For example, while a test is running, the following message can be displayed on the 2601B-PULSE front panel:

```
Test in Process
Do Not Disturb
```

The top line of the display can accommodate up to 20 characters (including spaces). The bottom line can display up to 32 characters (including spaces) at a time.

NOTE

The display functions `display.clear()`, `display.setcursor()`, and `display.settext()` are overlapped, nonblocking commands. The script will not wait for one of these commands to complete.

These nonblocking functions do not immediately update the display. For performance considerations, they write to a background file and update the display as soon as processing time becomes available.

The reset functions `reset()` and `smua.reset()` have no effect on the defined display message or its configuration, but will set the display mode back to the previous source-measure display mode.

Clearing the display

When sending a command to display a message, a previously defined user message is not cleared. The new message starts at the end of the old message on that line. It is good practice to routinely clear the display before defining a new message.

After displaying an input prompt, the message is displayed even after the operator performs the prescribed action. The `clear()` function must be sent to clear the display. To clear both lines of the display, but not affect any of the indicators, send the following function:

```
display.clear()
```

Cursor position

When displaying a message, the cursor position determines where the message will start. On power-up, the cursor is positioned at row 1, column 1 (see the following figure). At this cursor position, a user-defined message will be displayed on the top row (row 1).

Top line text does not wrap to the bottom line of the display automatically. Any text that does not fit on the current line is truncated. If the text is truncated, the cursor is left at the end of the line.

Figure 33: Row and column format for display messaging

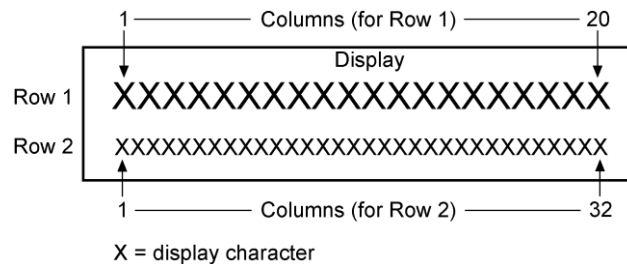

The function to set cursor position can be used two ways:

```
display.setcursor(row, column)
display.setcursor(row, column, style)
```

Where:

```
row          1 or 2
column       1 to 20 (row 1)
              1 to 32 (row 2)
style        0 (invisible)
              1 (blink)
```

When set to 0, the cursor is not visible. When set to 1, a display character blinks to indicate the cursor position.

The `display.getcursor()` function returns the present cursor position, and can be used in these ways:

```
row, column, style = display.getcursor()
row, column = display.getcursor()
row = display.getcursor()
```

The following programming example illustrates how to position the cursor on row 2, column 1, and then read the cursor position:

```
display.setcursor(2, 1)
row, column = display.getcursor()
print(row, column)
```

Output:

```
2.00000e+00 1.00000e+00
```

Displaying text messages

To define and display a message, use the `display.setText(text)` function, where `text` is the text string to be displayed. The message starts at the present cursor position. The following programming example illustrates how to display `Test in Process` on the top line, and `Do Not Disturb` on the bottom line:

```
display.clear()
display.setcursor(1, 1, 0)
display.setText("Test in Process")
display.setcursor(2, 6, 0)
display.setText("Do Not Disturb")
```

Character codes

These special codes can be embedded in the `text` string to configure and customize the message:

- `$N` Starts text on the next line (newline). If the cursor is already on line 2, text is ignored after the '`$N`' is received.
- `$R` Sets text to Normal.
- `$B` Sets text to Blink.
- `$D` Sets text to Dim intensity.
- `$F` Set text to background blink.
- `$$` Escape sequence to display a single "\$".

In addition to displaying alphanumeric characters, you can display other special characters. Refer to [Display character codes](#) (on page 16-1) for a list of special characters and their corresponding codes.

The following programming example illustrates how to display the Greek symbol omega (Ω):

```
display.clear()
c = string.char(18)
display.setText(c)
```

The following programming example illustrates how to use the `$N` and `$B` character codes to display the message `Test in Process` on the top line and the blinking message `Do Not Disturb` on the bottom line:

```
display.clear()
display.setText("Test in Process $N$BDo Not Disturb")
```

The following programming example illustrates how to use the `$$` character code to display the message `You owe me $8` on the top line:

```
display.clear()
display.setcursor(1, 1)
display.setText("You owe me $$8")
```

If the extra `$` character is not included, the `$8` is interpreted as an undefined character code and is ignored. The message `You owe me` is displayed.

NOTE

Be careful when embedding character codes in the text string. It is easy to forget that the character following the `$` is part of the code. For example, if you want to display `Hello` on the top line and `Nate` on the bottom line, send the following command:

```
display.setText("Hello$Nate")
```

The above command displays `Hello` on the top line and `ate` on the bottom line. The correct syntax for the command is as follows:

```
display.setText("Hello$NNate")
```

Returning a text message

The `display.getText()` function returns the displayed message (*text*) and can be used in the following ways:

```
text = display.getText()
text = display.getText(embellished)
text = display.getText(embellished, row)
text = display.getText(embellished, row, columnStart)
text = display.getText(embellished, row, columnStart, columnEnd)
```

Where:

<i>embellished</i>	Returns text as a simple character string (<code>false</code>) or includes character codes (<code>true</code>)
<i>row</i>	The row to read text from (1 or 2); if not included, text from both rows is read
<i>columnStart</i>	Starting column for reading text
<i>columnEnd</i>	Ending column for reading text

Sending the command without the *row* parameter returns both lines of the display. The `$N` character code is included to show where the top line ends and the bottom line begins. The `$N` character code is returned even if *embellished* is set to `false`.

With *embellished* set to `true`, all other character codes that were used in the creation of each message line are returned with the message. With *embellished* set to `false`, only the message is returned.

Sending the command without the *columnStart* parameter defaults to column 1. Sending the command without the *columnEnd* argument defaults to the last column (column 20 for row 1, column 32 for row 2).



Input prompting

You can use display messaging with front panel controls to make a user script interactive. In an interactive script, input prompts are displayed so that the operator can perform a prescribed action using the front panel controls. While displaying an input prompt, the test pauses and waits for the operator to perform the prescribed action.

Menu

You can present a user-defined menu on the display. The menu consists of the menu name on the top line and a selectable list of menu items on the bottom line. To define a menu, use the `display.menu(menu, items)` function, where:

menu The name of the menu; use a string of up to 20 characters (including spaces)
items A string is made up of one or more menu items; each item must be separated by white space

When the `display.menu()` function is sent, script execution waits for the operator to select one of the menu items. Rotate the navigation wheel  to place the blinking cursor on a menu item. Items that do not fit in the display area are displayed by rotating the navigation wheel  to the right. With the cursor on the menu item, press the navigation wheel  (or the **ENTER** key) to select it.

Pressing the EXIT (LOCAL) key does not abort the script while the menu is displayed, but it will return `nil`. The script can be aborted by calling the `exit()` function when `nil` is returned.

The following programming example illustrates how to present the operator with the choice of two menu items: `Test1` or `Test2`. If `Test1` is selected, the message `Running Test1` is displayed. If `Test2` is selected, the message `Running Test2` is displayed.

```
display.clear()
menu = display.menu("Sample Menu", "Test1 Test2")
if menu == "Test1" then
    display.settext("Running Test1")
else
    display.settext("Running Test2")
end
```

Parameter value prompting

You can use the `display.inputvalue()` and `display.prompt()` functions to create an editable input field on the user screen at the present cursor position.

The `display.inputvalue()` function uses the user screen at the present cursor position. Once the command is finished, it returns the user screen to its previous state. The `display.prompt()` function creates a new edit screen and does not use the user screen.

Each of these functions can be used in the following ways:

```
display.inputvalue(format)
display.inputvalue(format, default)
display.inputvalue(format, default, min)
display.inputvalue(format, default, min, max)
display.prompt(format, units, help)
display.prompt(format, units, help, default)
display.prompt(format, units, help, default, min)
display.prompt(format, units, help, default, min, max)
```

Where:

<i>format</i>	String that creates an editable input field on the user screen at the present cursor position (examples: +0.00 00, +00, 0.00000E+0) Value field: + = Include for positive/negative value entry; omitting the + prevents negative value entry 0 = Defines the digit positions for the value (up to six zeros (0)) Exponent field (optional): E = include for exponent entry + = Include for positive/negative exponent entry; omitting the + prevents negative value entry 0 = Defines the digit positions for the exponent
<i>default</i>	Option to set a default value for the parameter, which will be displayed when the command is sent
<i>min</i>	Option to specify minimum limits for the input field <ul style="list-style-type: none"> ■ When NOT using the "+" sign for the value field, the minimum limit cannot be set to less than zero ■ When using the "+" sign, the minimum limit can be set to less than zero (for example, -2)
<i>max</i>	Option to specify maximum limits for the input field
<i>units</i>	Text string to identify the units for the value (8 characters maximum), for example: Units text is "V" for volts and "A" for amperes
<i>help</i>	Informational text string to display on the bottom line (32 characters maximum)

Both the `display.inputvalue()` and `display.prompt()` functions display the editable input field, but the `display.inputvalue()` function does not include the text strings for *units* and *help*.

After one of the above functions is executed, command execution pauses and waits for the operator to input the source level. The program continues after the operator enters the value by pressing the navigation wheel  or the ENTER key.

The following programming example illustrates how to prompt the operator to enter a source voltage value for SMU A:

```
display.clear()
value = display.prompt("0.00", "v", "Enter source voltage")
display.screen = display.SMUA
smua.source.levelv = value
```

The script pauses after displaying the prompt message and waits for the operator to enter the voltage level. The display then toggles to the source-measure display and sets the source level to `value`.

NOTE

If the operator presses EXIT(LOCAL) instead of entering a source value, `value` will be set to `nil`.

The second line of the above code can be replaced using the other input field function:

```
value = display.inputvalue("0.00")
```

The only difference is that the display prompt will not include the “V” units designator and the Enter source value message.

Indicators

To determine which front-panel display indicators are turned on, use the `display.getannunciators()` function. For example, to determine which display indicators are turned on, send the following commands.

```
annun = display.getannunciators()
print(annun)
```

The 16-bit binary equivalent of the returned value is a bitmap. Each bit corresponds to an indicator. If the bit is set to 1, the indicator is turned on. If the bit is set to 0, the indicator is turned off.

The following table identifies the bit position for each indicator. The table also includes the weighted value of each bit. The returned value is the sum of all the weighted values for the bits that are set.

Bit identification for indicators

Bit	B16	B15	B14	B13	B12	B11	B10	B9
Annunciator	REL	REAR	SRQ	LSTN	TALK	REM	ERR	EDIT
Weighted value*	32768	16384	8192	4096	2048	1024	512	256
Binary value	0/1	0/1	0/1	0/1	0/1	0/1	0/1	0/1

Bit	B8	B7	B6	B5	B4	B3	B2	B1
Annunciator	SMPL	STAR	TRIG	ARM	AUTO	4W	MATH	FILT
Weighted value*	128	64	32	16	8	4	2	1
Binary value	0/1	0/1	0/1	0/1	0/1	0/1	0/1	0/1

* The weighted values are for bits that are set to 1. Bits set to 0 have no value.

Not all the indicators shown in above table may be used by the 2601B-PULSE.

For example, assume the returned bitmap value is 34061. The binary equivalent of this value is as follows:

```
1000010100001101
```

For the above binary number, the following bits are set to 1: 16, 11, 9, 4, 3, and 1. Using the table, the following indicators are on: REL, REM, EDIT, AUTO, 4W, and FILT.

Local lockout

You can use the front-panel EXIT (LOCAL) key to cancel remote operation and return control to the front panel. However, this key can be locked out to prevent a test from being interrupted. When locked, this key becomes a NO-OP (no operation). Configure the following attribute to lock or unlock the EXIT (LOCAL) key:

```
display.locallockout = lockout
```

Where *lockout* is set to one of the following values:

0 or `display.UNLOCK`

1 or `display.LOCK`

For example, to lock out the EXIT (LOCAL) key:

```
display.locallockout = display.LOCK
```

Load test menu

The LOAD TEST menu lists tests (USER, FACTORY, and SCRIPTS) that can be run from the front panel.

Factory tests are preloaded and saved in nonvolatile memory at the factory. They are available in the FACTORY TESTS submenu.

Named scripts that have been loaded into the runtime environment can be selected from the SCRIPTS submenu. Refer to [Manage scripts](#) (on page 10-3) for additional information.

User tests

User tests can be added to or deleted from the USER TESTS submenu.

Adding USER TESTS menu entries

You can use the following function in either of two ways to add an entry into the USER TESTS menu:

```
display.loadmenu.add(displayname, code)  
display.loadmenu.add(displayname, code, memory)
```

Where:

displayname

The name string that is added to the USER TESTS menu.

code

The code that is run from the USER TESTS menu when the RUN button is pressed. It can include any valid Lua code.

memory

A value that specifies if the *code* and *displayname* parameters are saved in nonvolatile memory. Set to one of the following values:

0 or `display.DONT_SAVE`

1 or `display.SAVE` (this is the default setting)

Scripts, functions, and variables that are used in the *code* are not saved when `display.SAVE` is used. Functions and variables need to be saved with the script (see [Manage scripts](#) (on page 10-3)). If the script is not saved in nonvolatile memory, it is lost when the 2601B-PULSE is turned off. See Example 1 below.

Example 1:

Assume a script with a function named `DUT1` has been loaded into the 2601B-PULSE, and the script has not been saved in nonvolatile memory.

Now assume you want to add a test named `Test` to the USER TESTS menu. You want the test to run the function named `DUT1` and sound the beeper. The following programming example illustrates how to add `Test` to the menu, define the *code*, and then save *displayname* and *code* in nonvolatile memory:

```
display.loadmenu.add("Test", "DUT1() beeper.beep(2, 500)", display.SAVE)
```

When `Test` is run from the front-panel USER TESTS menu, the function named `DUT1` executes and the beeper beeps for two seconds.

Now assume you turn the 2601B-PULSE power off and then on again. Because the script was not saved in nonvolatile memory, the function named `DUT1` is lost. When `Test` is again run from the front panel, the beeper beeps, but `DUT1` will not execute because it no longer exists in the runtime environment.

Example 2:

The following command adds an entry called `Part1` to the front-panel USER TESTS submenu for the code `testpart([[Part1]], 5.0)` and saves it in nonvolatile memory:

```
display.loadmenu.add("Part1", "testpart([[Part1]], 5.0)", display.SAVE)
```

Deleting USER TESTS menu entries

You can use the following function to delete an entry from the front-panel USER TESTS menu:

```
display.loadmenu.delete(displayname)
```

Where:

displayname Name to delete from the menu.

The following programming example removes the entry named `Part1` from the front-panel USER TESTS menu:



```
display.loadmenu.delete("Part1")
```

Running a test from the front panel

To run a user, factory, or script test from the front panel:

1. Press the **LOAD** key to display the LOAD TEST menu.
2. Select the **USER**, **FACTORY**, or **SCRIPTS** menu item.
3. Position the blinking cursor on the test to be run and press **ENTER** or the navigation wheel .
4. Press the **RUN** key to run the test.

Key-press codes

Key codes are provided to remotely simulate pressing a front-panel key or the navigation wheel . There are also key codes to simulate rotating the navigation wheel  to the left or right (one click at a time).

Sending key codes

Use the `display.sendkey()` function to remotely simulate pressing a front-panel key or the navigation wheel. The following programming examples illustrate how to simulate pressing the MENU key in two different ways:

```
display.sendkey(display.KEY_MENU)
display.sendkey(68)
```

Capturing key-press codes

A history of the key code for the last pressed front-panel key is maintained by the 2601B-PULSE. When the instrument is turned on (or when transitioning from local to remote operation), the key code is set to 0 (`display.KEY_NONE`).

When a front-panel key is pressed, the key code value for that key can be captured and returned. There are two functions associated with the capture of key-press codes: `display.getlastkey()` and `display.waitkey()`.

`display.getlastkey()`

The `display.getlastkey()` function immediately returns the key code for the last pressed key. The following programming example illustrates how to display the last key pressed:

```
key = display.getlastkey()
print(key)
```

The above code returns the key code value (see the following table). A value of 0 (`display.KEY_NONE`) indicates that the key code history had been cleared.

Key codes

Value	Key list	Value	Key list
0	display.KEY_NONE	82	display.KEY_ENTER
65	display.KEY_RANGEUP	85	display.KEY_RECALL
68	display.KEY_MENU	86	display.KEY_MEASA
69	display.KEY_MODEA	87	display.KEY_DIGITSA
70	display.KEY_RELA	92	display.KEY_TRIG
71	display.KEY_RUN	93	display.KEY_LIMITA
72	display.KEY_DISPLAY	94	display.KEY_SPEEDA
73	display.KEY_AUTO	95	display.KEY_LOAD
75	display.KEY_EXIT	97	display.WHEEL_ENTER
77	display.KEY_FILTERA	103	display.KEY_RIGHT
78	display.KEY_STORE	104	display.KEY_LEFT
79	display.KEY_SRCA	107	display.WHEEL_LEFT
80	display.KEY_CONFIG	114	display.WHEEL_RIGHT
81	display.KEY_RANGEDOWN		

NOTE

You cannot track the OUTPUT ON/OFF control for a source-measure unit (SMU) using this function.

display.waitkey()

The `display.waitkey()` function captures the key code value for the next key press:

```
key = display.waitkey()
```

After sending the `display.waitkey()` function, the script pauses and waits for the operator to press a front-panel key. For example, if the MENU key is pressed, the function returns the value 68, which is the key code for that key. The key code values are the same as listed in [display.getlastkey\(\)](#) (on page 11-57).

The following programming example illustrates how to prompt the user to press the EXIT (LOCAL) key to abort the script, or any other key to continue it:

```
display.clear()
display.setcursor(1, 1)
display.settext("Press EXIT to Abort")
display.setcursor(2, 1)
display.settext("or any key to continue")
key = display.waitkey()
display.clear()
display.setcursor(1, 1)
if key == 75 then
    display.settext("Test Aborted")
    exit()
else
    display.settext("Test Continuing")
end
```

The above code captures the key that is pressed by the operator. The key code value for the EXIT (LOCAL) key is 75. If the EXIT (LOCAL) key is pressed, the script aborts. If any other key is pressed, the script continues.

USB storage overview

The 2601B-PULSE includes a USB port on the front panel. To store scripts and to transfer files from the instrument to the host computer, you need a USB flash drive.

- For information about saving reading buffers to a USB flash drive, see [Saving reading buffers](#) (on page 5-4).
- For information about storing and loading scripts to and from a USB flash drive, see [Save a user script](#) (on page 10-10).
- For information about file I/O, see [File I/O](#) (on page 9-7).
- For information about saving user setups, see [Saved setups](#) (on page 4-51).

Connecting the USB flash drive

The 2601B-PULSE supports flash drives that comply with USB 2.0 standards and USB 1.0 and 1.1 standards. You can save data to the USB flash drive from the front panel, or you can create a script to save data to the USB flash drive.

To connect the USB flash drive, plug the USB flash drive into the USB port on the front panel of the instrument, shown in the figure below.

Figure 34: USB port

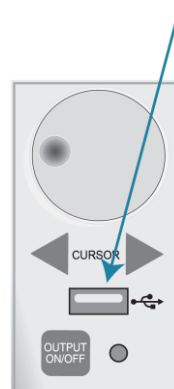

File system navigation

The 2601B-PULSE can use commands from the Lua `fs` library to navigate and list files that are available on a flash drive. These Lua commands are in the `fs` command group in the instrument.

The `fs` commands make the file system of any given node available to the entire TSP-Link® system. For example, you can use the command `node[5].fs.readdir(".")` to read the contents of the current working directory on node 5.

The root folder of the USB flash drive has the absolute path:

```
"/usb1/"
```

NOTE

You can use either the slash (/) or backslash (\) as a directory separator. However, the backslash is also used as an escape character, so if you use it as a directory separator, you will generally need to use a double backslash (\\) when you are creating scripts or sending commands to the instrument.

The instrument supports the following Lua `fs` commands:

[fs.chdir\(\)](#) (on page 11-92)

[fs.cwd\(\)](#) (on page 11-93)

[fs.is_dir\(\)](#) (on page 11-93)

[fs.is_file\(\)](#) (on page 11-94)

[fs.mkdir\(\)](#) (on page 11-95)

[fs.readdir\(\)](#) (on page 11-95)

[fs.rmdir\(\)](#) (on page 11-96)

The following Lua `fs` commands are not supported:

`fs.chmod()`

`fs.chown()`

`fs.stat()`

Sourcing and measuring

In this section:

Operation overview	4-1
DUT test connections	4-6
DUT connection settings	4-25
Basic source-measure procedure	4-30
Operation considerations for the ADC	4-41
Triggering in local mode	4-42
Configuring trigger attributes in local mode	4-44
Configuring for measure-only tests using the MODE key	4-45
Voltmeter and ammeter measurements	4-45
Ohms measurements	4-46
Power measurements	4-49
Saved setups	4-51
Range	4-54
Digits	4-59
Speed when the pulser is disabled	4-60
Sweep operation	4-61
Relative offset	4-75
Filters	4-77
High-capacitance mode	4-80

Operation overview

The 2601B-PULSE is a single channel source-measure instrument with the full SMU functionality of a Model 2601B SourceMeter® Instrument plus a high-speed current pulser.

The instrument operates as a SMU or as a current pulser. Internally, a solid-state switch routes the SMU or pulser to the output terminals, as shown in the following figure.

Figure 35: SMU and pulser operation

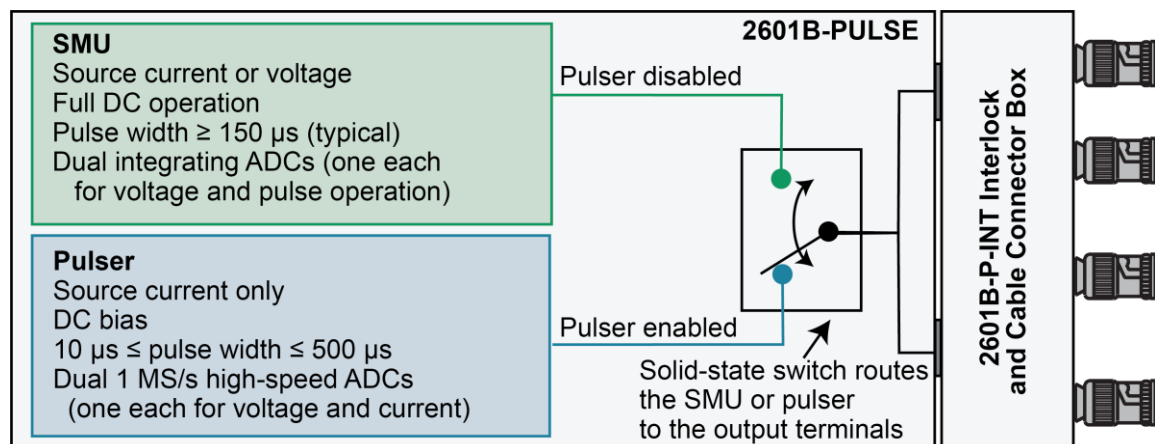

When the pulser is disabled, the instrument provides the full functionality of a 4-quadrant SMU. You can use the front panel or remote commands to configure the instrument to perform the following source-measure operations:

- **Source voltage:** Measure and display current, voltage, resistance, or power
- **Source current:** Measure and display voltage, current, resistance, or power
- **Measure resistance:** Display resistance calculated from voltage and current components of measurement (can optionally specify source voltage or source current value)
- **Measure power:** Display power calculated from voltage and current components of measurement (can optionally specify source voltage or source current value)
- **Measure only (V or I):** Display voltage or current measurement

When the pulser is enabled, the instrument generates fast-edge current pulses only. It measures current, voltage, resistance, or power. The pulser sourcing and measuring functionality is only available using remote commands. Pulser protection levels and some measurements are displayed on the front-panel interface.

Limits

Limits are only applied when the pulser is disabled. When the pulser is enabled, protection levels are applied. Refer to [Pulser operation](#) (on page 4-33) for more information.

When sourcing voltage, the 2601B-PULSE can be set to limit current or power. Conversely, when sourcing current, the 2601B-PULSE can be set to limit voltage or power. In steady-state conditions, the 2601B-PULSE output will not exceed the limit. The maximum limit is the same as the maximum values listed in the following table.

The limit circuit will limit in either polarity regardless of the polarity of the source or limit value. The accuracy of the limit opposite in polarity from the source is diminished unless the instrument is in [sink mode](#) (on page 4-5). The maximum limits are based on source range. For more information, see [Limit principles](#) (on page 7-2).

The limit operation of the instrument changes dependent on the source mode (current or voltage), load, and the configured limits (current, voltage, and power). It is important to distinguish both the current and voltage limits from the power limit. As the names imply, the current limit restricts the current for sourced voltage, and the voltage limit restricts the voltage for a sourced current. The power limit, however, restricts power by lowering the present limit in effect (voltage or current) as needed to restrict the SMU from exceeding the specified power limit. For additional details on using limits, including load considerations when specifying both a current (or a voltage) limit and a power limit, see [Operating boundaries](#) (on page 7-6).



NOTE

The only exception to the limit not being exceeded is the voltage limit when operating as a current source. To avoid excessive (and potentially destructive) currents from flowing, the voltage limit will source or sink up to 102 mA for current source ranges on or below 100 mA. For the ranges 1 A and above, the maximum current allowed is the current source setting.

Source range	Maximum limit
100 mV	3 A
1 V	3 A
6 V	3 A
40 V	1 A
100 nA	40 V
1 μ A	40 V
10 μ A	40 V
100 μ A	40 V
1 mA	40 V
10 mA	40 V
100 mA	40 V
1 A	40 V
3 A	6 V

Setting the limit

Set the limit from the front panel as follows:

1. Press the **LIMIT** key to directly access limit editing. Pressing the LIMIT key while in limit edit mode toggles the display between the complementary function limit and the power limit display.
2. Press the navigation wheel  and set the limit to the new value.
3. Press the **ENTER** key or the navigation wheel  to complete editing.
4. Press the **EXIT (LOCAL)** key to return to the main display.

Set the limit using remote commands as follows:

The table below summarizes basic commands to program a limit. For a more complete description of these commands, refer to the [TSP command reference](#) (on page 11-1).

Limit commands

Command	Description
<code>smua.source.limiti = limit</code>	Set current limit.
<code>smua.source.limitv = limit</code>	Set voltage limit.
<code>smua.source.limitp = limit</code>	Set power limit.
<code>compliance = smua.source.compliance</code>	Test if in limit (<code>true</code> = in limit; <code>false</code> = not in limit).

To set the limit, send the command with the limit value as the parameter. This programming example illustrates how to set the current, voltage, and power limit to 50 mA, 4 V, and 1 W, respectively:

```
smua.source.limiti = 50e-3
smua.source.limitv = 4
smua.source.limitp = 1
```

The following programming example illustrates how to print the limit state:

```
print(smua.source.compliance)
```

A returned value of `true` indicates one of the following things:

- If the instrument is configured as a current source, the voltage limit has been reached
- If the instrument is configured as a voltage source, the current limit has been reached

Pulser protection levels

The pulser has two protection levels, one for the sense terminals and one for the force terminals. Both are set using remote commands. When either of the protection levels are exceeded, the instrument generates the 5127 "Output protection level exceeded" error and the current pulse terminates within 3 μ s.

The sense terminals are monitored by the voltage protection level. If the voltage on the sense terminals goes above the protection level, the output is turned off. If the level was exceeded during a sweep, the output is shorted until all trigger counts are satisfied, then the output is turned off. The voltage protection level can be set from 5 percent to 200 percent of the pulser voltage range. For additional detail, refer to [smua.pulser.protect.sensev](#) (on page 11-216).

The force terminals are monitored by the absolute voltage protection level. If the voltage on the force terminals goes above the protection level, the 2601B-PULSE automatically turns off the output. The absolute voltage level can be set from 2 V to 40 V, independent of the range. This level ignores normal transients during pulse rise and fall times. For additional detail on the source level setting, refer to [smua.pulser.protect.sourcev](#) (on page 11-217).

CAUTION

Setting a protection level does not guarantee that the output will not go above the protection level. The 2601B-PULSE turns off the output as quickly as possible, but the voltage level can briefly exceed this level, potentially causing damage to the device under test (DUT).

Setting and checking the pulser protection levels

To set the voltage protection level using remote commands:

Send the command `smua.pulser.protect.sensev` with the level defined. For example, to set a protection level of 8 V, send:

```
smua.pulser.protect.sensev = 8
```

To set the absolute voltage protection level using remote commands:

Send the command `smua.pulser.protect.sourcev` with the level defined. For example, to set an absolute voltage level of 24 V, send:

```
smua.pulser.protect.sourcev = 24
```

To determine if a pulser level protection was tripped, send:

```
print(smua.pulser.protect.tripped)
```

A returned value of `true` indicates that the protection circuit was tripped. The following events can trip the protection circuit:

- A voltage greater than `smua.pulser.protect.sensev` was detected on the sense terminals.
- A voltage greater than `smua.pulser.protect.sourcev` was detected on the force terminals.
- The maximum pulse width was exceeded during trigger model operation.
- The maximum duty cycle was exceeded during trigger model operation.
- If the SMU cannot keep up with the pulse rate.
- If the SMU cannot keep up with the measurement rate.

The status is reset to `false` when the pulser is disabled or when the output is turned on.

Pulser measurement considerations

If the output exceeds a maximum pulse width, maximum duty cycle, or the specified protection level during a sweep, the 2601B-PULSE output is shorted, but the sweep continues with no source output until it is finished.

Sink operation

CAUTION

Carefully consider and configure the appropriate output-off state, source function, and compliance limits before connecting the 2601B-PULSE to a device that can deliver energy (for example, other voltage sources, batteries, capacitors, solar cells, or other 2601B-PULSE instruments). Configure recommended instrument settings before making connections to the device. Failure to consider the output-off state, source, and compliance limits may result in damage to the instrument or to the device under test (DUT).

When operating as a sink (V and I have opposite polarity), the instrument is dissipating power rather than sourcing it. An external source (for example, a battery) or an energy storage device (for example, a capacitor) can force operation into the sink region.

NOTE

When the pulser is disabled, the accuracy of the limit opposite in polarity from the source is diminished unless the instrument is in sink mode. Enabling sink mode reduces the source limit inaccuracy seen when operating in quadrants II and IV. Quadrants I and III will show this source limit inaccuracy. Also see [Limit principles](#) (on page 7-2).

For example, if a 12 V battery is connected to the voltage source (HI to battery +) that is programmed for +10 V, sink operation occurs in the second quadrant (source +V and measure -I).

CAUTION

When using the SMU current source as a sink, always set the voltage compliance to a level that is higher than the external voltage level. Failure to do so could result in excessive current flow into the instrument and incorrect measurements. See [Limits](#) (on page 4-2) for details about compliance limits.

The sink operating limits are shown in [Continuous power operating boundaries](#) (on page 7-7).

Setting the sink mode using the front panel

To enable or disable the sink mode from the front panel:

1. Press the **CONFIG** key and then the **SRC** key.
2. Select **V-SOURCE**.
3. Select **SINK-MODE**.
4. Select **ENABLE** or **DISABLE**.
5. Push the **ENTER** key. Sink mode is enabled or disabled, as applicable.
6. Press the **EXIT (LOCAL)** key twice to return to the main display.

Setting the sink mode from the remote interface

To enable sink mode from the remote interface, send:

```
smua.source.sink = smua.ENABLE
```

To disable sink mode, send:

```
smua.source.sink = smua.DISABLE
```

DUT test connections

WARNING

Hazardous voltages may be present in the test system. To prevent injury or death, remove power from the instrument or test system and discharge any energy storage components (for example, capacitors or cables) before changing any connections that might allow contact with an uninsulated conductor.

WARNING

SENSE LO and FORCE LO are not internally connected to the chassis. Do not allow them to float above 0 V. Failure to adhere to these guidelines can result in personal injury or death due to electric shock.

NOTE

On some sensitive or easily damaged devices under test (DUTs), the instrument power-up and power-down sequence can apply transient signals to the DUT that may affect or damage it. When testing this type of DUT, do not make final connections to it until the instrument has completed its power-up sequence and is in a known operating state. When testing this type of DUT, disconnect it from the instrument before turning the instrument off.

To prevent any human contact with a live conductor, connections to the DUT must be fully insulated and the final connections to the DUT must only use safety-rated safety-jack-socket connectors that do not allow bodily contact.

The fundamental source-measure configurations for the 2601B-PULSE are shown in the following figures. When the SMU is sourcing voltage, you can measure current or voltage, as shown in the following figure.

Figure 36: Fundamental source-measure configurations: Source V

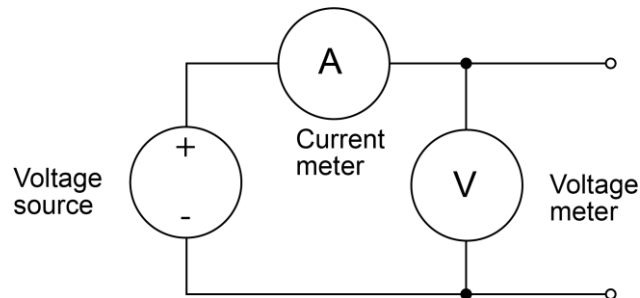

When the SMU or pulser is sourcing current, you can measure voltage or current, as shown in the following figure.

Figure 37: Fundamental source-measure configuration: Source I

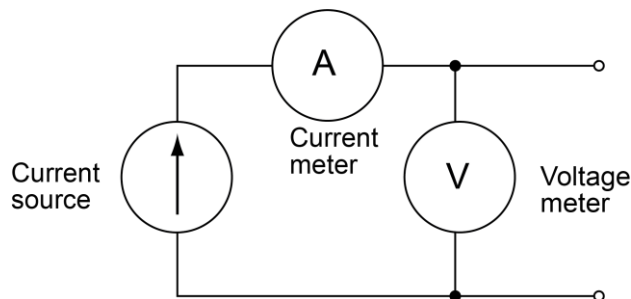

See [Basic circuit configurations](#) (on page 7-19) for detailed information.

FORCE and SENSE connectors

You make connections from the instrument to the device under test (DUT) using the BNC connections on the 2601B-P-INT.

The FORCE HI, FORCE LO, and SENSE HI connectors of the 2601B-P-INT have GUARD on the shell. The SENSE LO connector has FORCE LO on the shell. The FORCE LO shell connection is for shielding only and should not be used to carry signal; use the center pin of the FORCE LO connector instead.

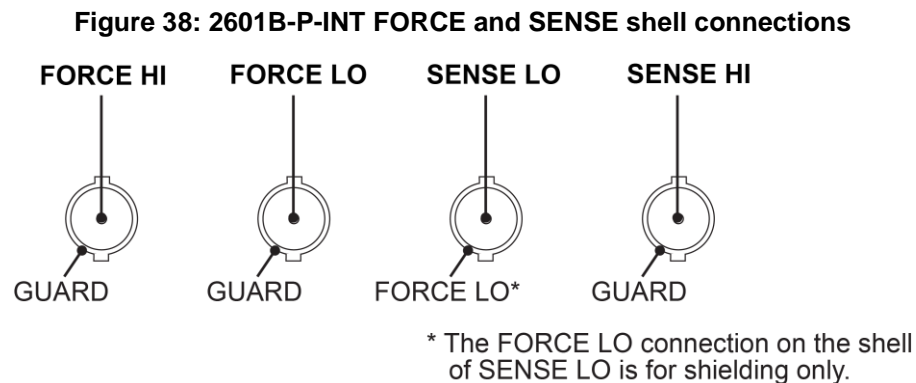
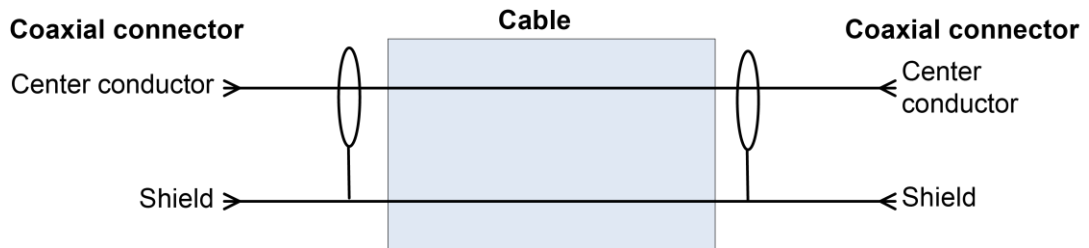

Figure 39: Coaxial connectors for 2601B-PULSE



All connections are electrically isolated from chassis ground.

The rear panel of the 2601B-PULSE provides a low-noise chassis ground banana jack that can be used as a common signal ground point for the SENSE and FORCE LOs. This low-noise signal ground banana jack is connected to the chassis through a frequency variable resistor (FVR). The FVR, shown in the figure below, is used to isolate the SMU from high frequencies that may be present on the chassis of the 2601B-PULSE. As frequencies on the chassis increase, the resistance of the FVR increases to dampen their effects. For dc to 60 Hz, the FVR is a virtual short (zero ohms).

The chassis screw terminal is connected to the metal chassis of the 2601B-PULSE.

Figure 40: Chassis ground banana jack

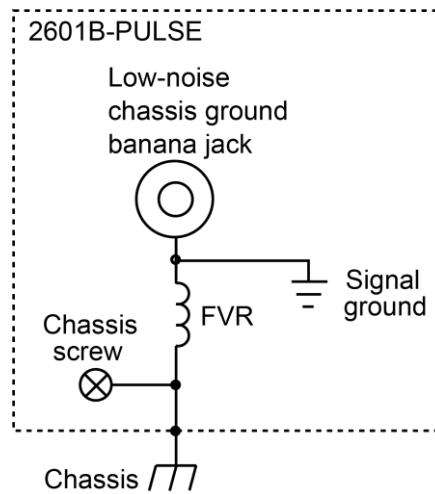

NOTE

Do not use the chassis as a ground point for signal connections. High frequencies on the chassis of the 2601B-PULSE may result in higher noise. The chassis should only be used as a safety shield. Use the chassis screw for connections to the chassis of the 2601B-PULSE.

⚠ WARNING

The **FORCE** and **SENSE** connectors of the 2601B-PULSE are rated for connection to circuits rated **Measurement Category I** only, with transients rated less than $1500 V_{PEAK}$. Do not connect the 2601B-PULSE terminals to **CAT II**, **CAT III**, or **CAT IV** circuits. Connections of the input/output connectors to circuits higher than **CAT I** can cause damage to the equipment or expose the operator to hazardous voltages.

To prevent electric shock and/or damage to the 2601B-PULSE, when connecting to a source with a greater current capability than the 2601B-PULSE, a user-supplied fuse, rated at no more than **20 A SLO-BLO**, should be installed in-line with the 2601B-PULSE input/output connectors.

2-wire local sensing connections

NOTE

Local voltage sensing is only available when the pulser is disabled.

You can use 2-wire local sensing measurements, shown in the following figure, for the following source-measure conditions:

- Sourcing and measuring current.
- Sourcing and measuring voltage in high impedance (more than 1 k Ω) test circuits.

Make sure to configure the 2601B-PULSE for 2-wire local sensing. Refer to [Sense mode selection](#) (on page 4-25) for information.

Figure 41: Two-wire local sensing 2601B-P-INT connections

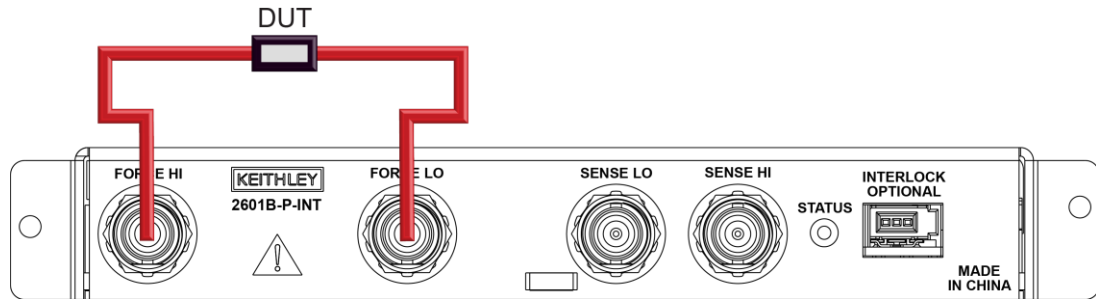

4-wire remote sensing connections

When sourcing or measuring voltage in a low-impedance test circuit, there can be errors associated with lead resistance. Voltage source and measure accuracy is optimized by using 4-wire remote sense connections. When sourcing voltage, 4-wire remote sensing ensures that the programmed voltage is delivered to the DUT. When measuring or limiting voltage, only the voltage drop across the DUT is measured.

When the pulser is enabled, you must use 4-wire remote sensing connections. The instrument uses remote sensing regardless of the sense setting.

When the pulser is disabled, the default sense setting is 2-wire local. If you need to use 4-wire remote sensing, you must change the sense. Refer to [Sense mode selection](#) (on page 4-25) for information.

When you are using 4-wire voltage sensing, it is critical that you establish and maintain the proper Kelvin connections between the corresponding force and sense leads to ensure the proper operation of the instrument and to make accurate voltage measurements. Sense HI must be connected to Force HI, and Sense LO must be connected to Force LO.

When sourcing voltage with remote sense, the instrument relies on the voltage detected with the sense lines to provide the proper closed-loop control of its output voltage and to properly limit the voltage across the device-under-test. If a sense line becomes disconnected from its corresponding force line, an erroneous voltage is sensed. The output voltage may be adjusted to a level that is radically different than the programmed voltage level. In addition, the voltage across the device may exceed the programmed source limit voltage, possibly causing damage to the device or test fixture.

In both cases, the voltage is not measured correctly if a sense lead becomes disconnected from its corresponding force lead.

You can use contact check to verify that the sense leads are connected before enabling remote sensing or before turning on the output. Refer to [Contact check measurements](#) (on page 4-12).

Use 4-wire remote sensing for the following source-measure conditions:

- When the pulser is enabled
- Sourcing or measuring voltage in low impedance (<1 k Ω) test circuits
- Enforcing voltage compliance limit directly at the DUT

Figure 42: Four-wire 2601B-P-INT connections (remote sensing)

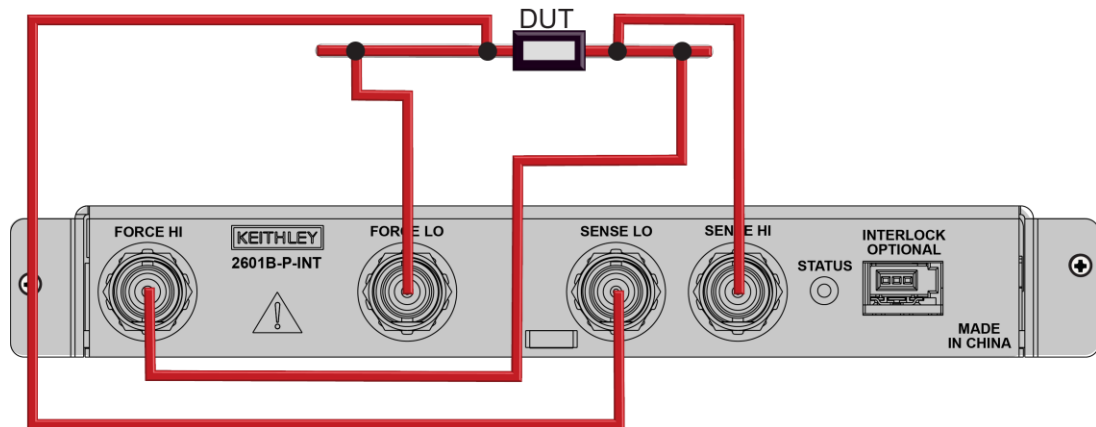

Connections for pulser operation

Pulser measurements must be made using 4-wire (Kelvin) connections. Refer to [4-wire remote sensing connections](#) (on page 4-10) for connection diagrams.

When making pulser measurements, the allowed maximum total inductance is 3 μH . The open areas between FORCE leads can introduce inductance. To minimize this inductance, jumper the FORCE connection shields at the device under test (DUT). The FORCE connection shields are jumpered inside the 2601B-P-INT, so external jumpers are not needed at the instrument.

NOTE

The signal present at the FORCE terminals is affected by the total inductance in the test circuit. The signal present at the SENSE terminals is only affected by the inductance beyond the Kelvin connection points. Take this into consideration when setting the voltage protection levels.

Keithley Instruments offers several low-inductance cable options that are optimized for pulser applications:

- **2601B-PULSE-CA1 50 Ω BNC-to-BNC cable kit:** A set of two 1.2 m BNC-to-BNC cables and one 1.2 m cable assembly. Use the cables to make the SENSE HI and SENSE LO connections. Use the cable assembly to make the FORCE HI and FORCE LO connections. On the end intended for connection to the device under test (DUT), the shields on the cable kit are jumpered to reduce loop inductance.
- **2601B-PULSE-CA2 50 Ω BNC-to-BNC coaxial cables:** A set of two 3 m cables that are used to make the SENSE HI and SENSE LO connections.
- **2601B-PULSE-CA3 15 Ω BNC-to-BNC cable kit:** A set of two 3 m cables that are used to make the FORCE HI and FORCE LO connections. On the end intended for connection to the DUT, the shields are jumpered to remove loop inductance. The 2601B-PULSE-CA2 must be used for the SENSE connections. This cable kit has lower inductance than the 2601B-PULSE-CA1.

Contact check connections

The contact check function prevents measurement errors due to excessive resistance in the force or sense leads when 4-wire remote sensing is used. Potential sources for this resistance include poor contact at the device under test (DUT), failing relay contacts on a switching card, and wires that are too long or thin. To use contact check, the current limit must be at least 1 mA (this allows enough current to flow when performing the test), and the source-measure unit (SMU) must not be in High-Z output-off mode.

The contact check function also detects open circuits that may occur when a four-point probe is misplaced or misaligned. This relationship is shown schematically in the figure below, where R_c is the resistance of the mechanical contact at the DUT, and R_s is the series resistance of relays and cables.

Contact check requires both force and sense connections. Refer to [4-wire remote sensing connections](#) (on page 4-10) for information.

Figure 43: Contact check measurement connections to 2601B-P-INT

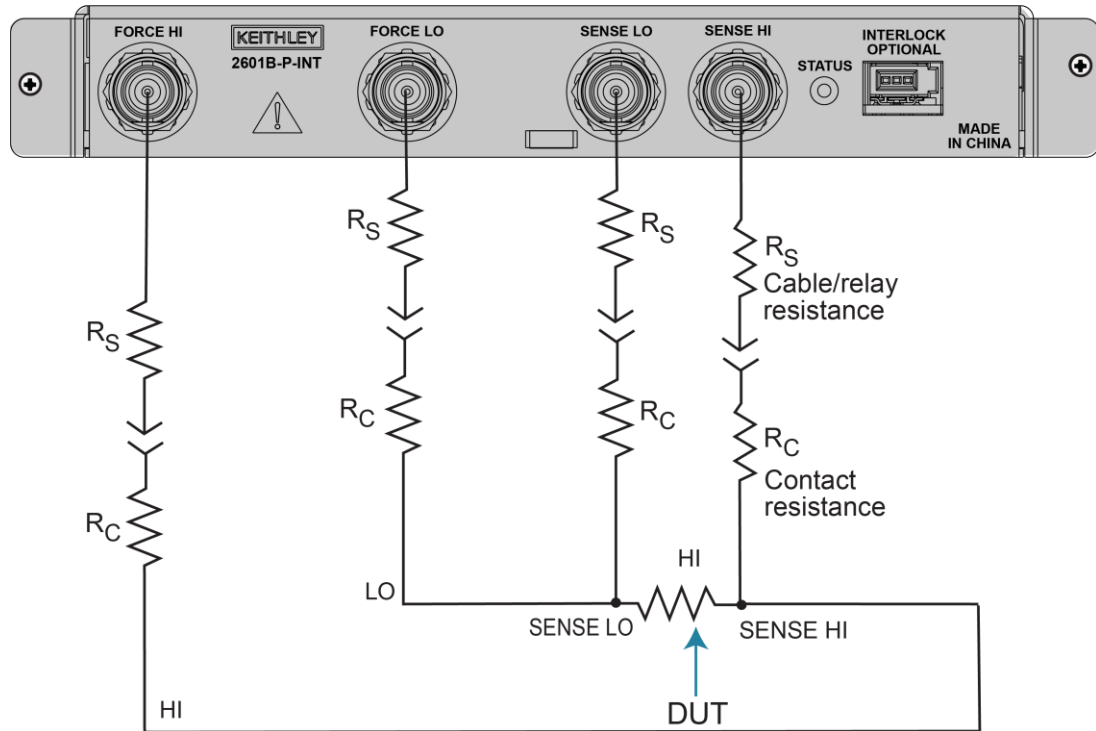

NOTE

The contact check function is not available if the pulser is enabled. If you need to use the contact check function in a pulser application, you can disable the pulser, run the contact check measurements, then enable the pulser. See [Example 1: Ten-point pulse sweep](#) (on page 4-37) for an example that shows how to run contact check before running a pulser application.

Contact check commands

The following table summarizes the contact check commands. For a more complete description of these commands, refer to the [TSP command reference](#) (on page 11-1).

Basic contact check commands

Command	Description
<code>flag = smua.contact.check()</code>	Determine if contact resistance is lower than threshold.
<code>rhi, rlo = smua.contact.r()</code>	Measure the aggregate contact resistance.
<code>smua.contact.speed = speedSetting</code>	Set <i>speedSetting</i> to one of the following: <ul style="list-style-type: none"> ▪ 0 or <code>smua.CONTACT_FAST</code> ▪ 1 or <code>smua.CONTACT_MEDIUM</code> ▪ 2 or <code>smua.CONTACT_SLOW</code>
<code>smua.contact.threshold = rvalue</code>	Set resistance threshold for the contact check function.

Contact check programming example

The following programming example illustrates the setup and command sequence for a typical contact check measurement. These commands set the contact check speed to fast and the threshold to 100 Ω . Then, a contact check measurement against the threshold is made. If it fails, a more accurate contact check measurement is made, and the test is aborted. Otherwise, the output is turned on, and the test continues.

```
-- Restore defaults.
smua.reset()
-- Set contact check speed to fast.
smua.contact.speed = smua.CONTACT_FAST
-- Set the contact check threshold to 100 ohms.
smua.contact.threshold = 100
-- Check contacts against threshold.
if not smua.contact.check() then
  -- Set speed to slow.
  smua.contact.speed = smua.CONTACT_SLOW
  -- Get aggregate resistance readings.
  rhi, rlo = smua.contact.r()
  -- Return contact resistances to the host.
  print(rhi, rlo)
  -- Terminate execution.
  exit()
end
-- Turn output on and continue.
smua.source.output = smua.OUTPUT_ON
```

Combining SMU outputs

The following information provides important considerations that need to be observed when combining SMU outputs.

Use care when combining SMUs. Whenever SMUs are combined, it is best to use instruments with identical current and voltage envelopes and ranges.

CAUTION

Carefully consider and configure the appropriate output-off state, source function, and compliance limits before connecting the 2601B-PULSE to a device that can deliver energy (for example, other voltage sources, batteries, capacitors, solar cells, or other 2601B-PULSE instruments). Configure recommended instrument settings before making connections to the device. Failure to consider the output-off state, source, and compliance limits may result in damage to the instrument or to the device under test (DUT).

The following figure and table illustrate the pulse regions for each SMU when used in combination with another SMU. The programmed current and voltage levels for both SMUs must fall within the same pulse region. Refer to the 2601B-PULSE specifications on tek.com/keithley for the latest pulse width and duty cycle information. Measurements are given priority over source and display operations, so make sure that the measurement time does not exceed the allowable pulse width and duty cycle in a particular pulse region.

Figure 44: Combining SMU outputs

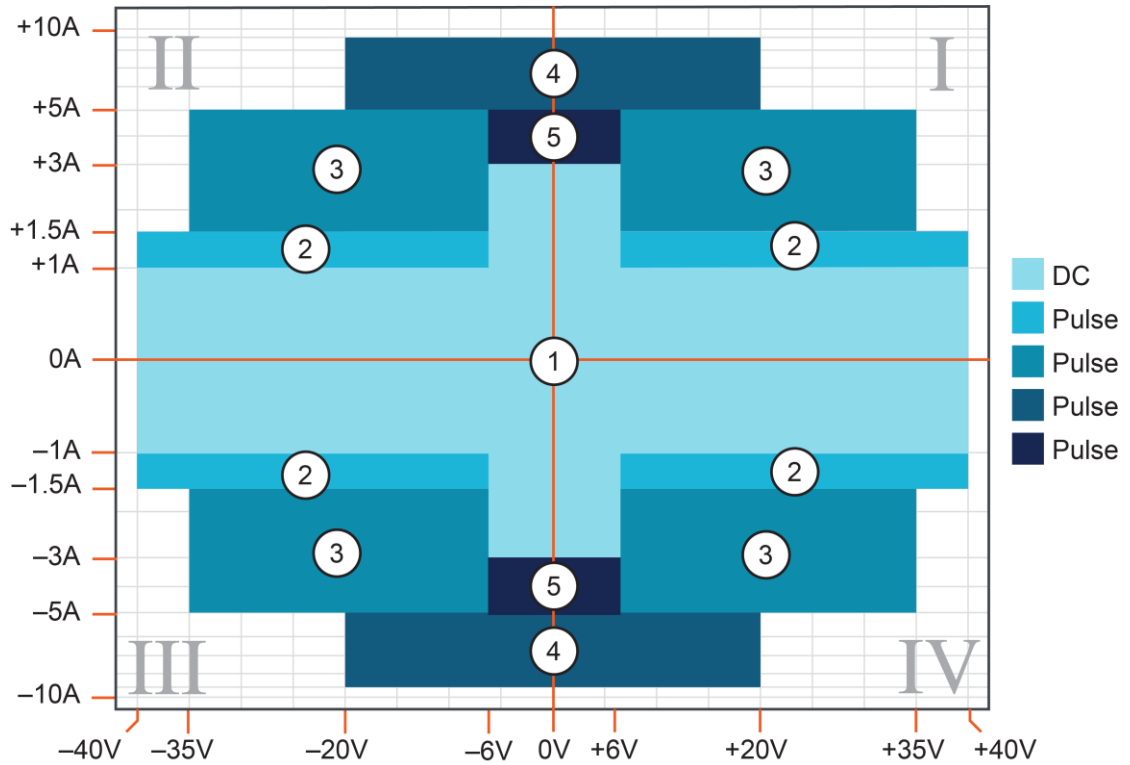

Pulse region specification (pulser disabled)

Region (quadrant diagram)	Region maximum	Maximum pulse width	Maximum duty cycle
1	1 A at 40 V	DC, no limit	100%
1	3 A at 6 V	DC, no limit	100%
2	1.5 A at 40 V	100 ms	25%
3	5 A at 35 V	4 ms	4%
4	10 A at 20 V	1.8 ms	1%
5	5 A at 6 V	10 ms	10%

Additional guidelines for combining SMU outputs:

- When combining the outputs of two 2601B-PULSE instruments, restrict operation to pulse only or limited duty cycle operations whenever possible. DC operation in Region 1 is possible if necessary.
- For comparable rise times, the source range and level of SMU 1 must match the source range and level of SMU 2.
- Do not place two voltage sources in parallel.
- Do not place two current sources in series.
- Think carefully about the appropriate output-off mode (`smua.source.offmode`) and output-off function (`smua.source.offfunc`) whenever changes are made to the source function. The alternative is to always use the high impedance output-off mode (`smua.source.offmode = smua.OUTPUT_HIGH_Z`).
- Additional configuration guidelines are presented in the following topics. Additional information, including examples on combining SMU instruments, is available in application notes on tek.com/keithley.

Source current using two 2601B-PULSE instruments in parallel

Figure 45: Source current using parallel SMU instruments

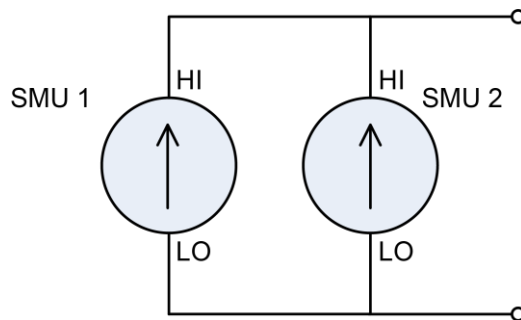

The following values are based on the current and voltage levels available in Region 4, as shown in the table in [Combining SMU outputs](#) (on page 4-14).

Set the pulser to disabled:

```
smua.pulser.enable = smua.DISABLE
```

Maximum pulsed signal levels for the 2601B-PULSE SMU:

20 A with 18 V compliance

SMU 1 configuration:

Output-off mode:

```
smua.source.offmode = smua.OUTPUT_NORMAL
```

Output-off function:

```
smua.source.offfunc = smua.OUTPUT_DCAMPS
```

Normal output-off voltage limit:

```
smua.source.offlimitv = 20
```

Voltage compliance must be 10% higher than the voltage compliance of SMU 2. Voltage compliance limit (maximum):

```
smua.trigger.source.limitv = 20
```

SMU 2 configuration:

Output-off mode:

```
smua.source.offmode = smua.OUTPUT_NORMAL
```

Output-off function:

```
smua.source.offfunc = smua.OUTPUT_DCVOLTS
```

Current limit for normal output-off mode (this is the maximum current that flows between the two SMUs when the output is off):

```
smua.source.offlimiti = 1e-3 (default)
```

Voltage compliance must be 10% lower than the voltage compliance of SMU 1. Therefore, this SMU controls the maximum voltage across the DUT. Voltage compliance limit (maximum):

```
smua.trigger.source.limitv = 18
```

Source voltage using two 2601B-PULSE instruments in series

Figure 46: Source voltage using 2601B-PULSE instruments in series

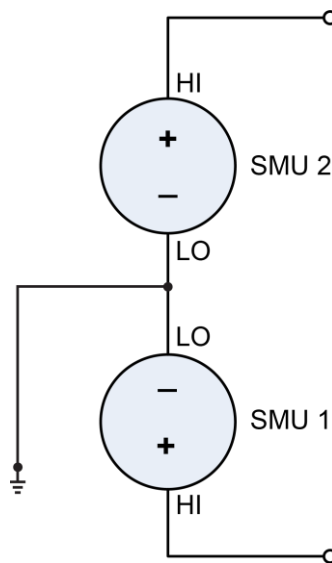

The following values are based on the current and voltage levels available in Region 4, as shown in the table in [Combining SMU outputs](#) (on page 4-14).

Set the pulser to disabled:

```
smua.pulser.enable = smua.DISABLE
```

Maximum pulsed signal levels for 2601B-PULSE:

40 V with 9 A compliance

SMU 1 configuration:

Output-off mode:

```
smua.source.offmode = smua.OUTPUT_NORMAL
```

Output-off function:

```
smua.source.offfunc = smua.OUTPUT_DCVOLTS
```

Normal output-off current limit:

```
smua.source.offlimiti = 1e-3 (default)
```

Current compliance must be 10% higher than the current compliance of SMU 2. Current compliance limit (maximum):

```
smua.trigger.source.limiti = 10
```

The polarity of SMU 1 is generally the opposite of the desired voltage polarity across the device. To achieve a positive voltage across the device, program SMU 1 to a negative voltage level. For example, to output 40 V across the device, program SMU 1 to -20 V and SMU 2 to +20 V. To achieve a negative voltage across the device, program SMU 1 to a positive voltage level and SMU 2 to a negative voltage level.

Source polarity changes incur a 100 μ s penalty. The number 0 is considered a positive value. For negative-going pulses with a 0 V bias level, avoid the time penalty by programming a negative number near zero, such as -1e-12 V.

SMU 2 configuration:

Output-off mode:

```
smua.source.offmode = smua.OUTPUT_NORMAL
```

Output-off function:

```
smua.source.offfunc = smua.OUTPUT_DCVOLTS
```

Normal output-off current limit (0.9 mA, which is 10% less than the SMU 1 output-off limit):

```
smua.source.offlimiti = 0.9e-3
```

Current compliance must be 10% lower than the current compliance of SMU 1. Therefore, this SMU controls the maximum current through the DUT. Current compliance limit (maximum):

```
smua.trigger.source.limiti = 9
```

Source voltage with extended current using two 2601B-PULSE instruments in parallel

Figure 47: Source voltage with extended current using parallel SMUs

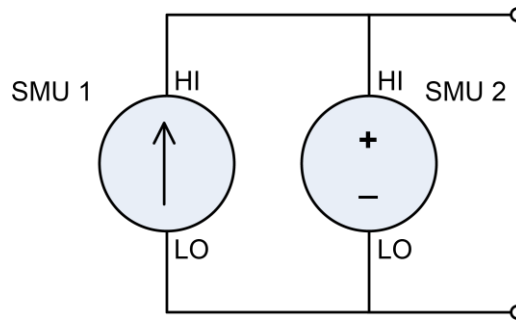

The following values are based on the current and voltage levels available in Region 4, as shown in the table in [Combining SMU outputs](#) (on page 4-14).

Set the pulser to disabled:

```
smua.pulser.enable = smua.DISABLE
```

Maximum pulsed signal levels for 2601B-PULSE:

18 V with 19 A compliance

SMU 1 configuration:

Output-off mode:

```
smua.source.offmode = smua.OUTPUT_NORMAL
```

Output-off function:

```
smua.source.offfunc = smua.OUTPUT_DCAMPS
```

Normal output-off voltage limit (40 V maximum):

```
smua.source.offlimitv = 20
```

The voltage compliance of SMU 1 (the current source) must be 10% greater than the maximum programmed voltage of SMU 2 (the voltage source).

Voltage compliance limit:

```
smua.trigger.source.limitv = 20
```

SMU 2 configuration:

Output-off mode:

```
smua.source.offmode = smua.OUTPUT_NORMAL
```

Output-off function:

```
smua.source.offfunc = smua.OUTPUT_DCVOLTS
```

Normal output-off current limit:

```
smua.source.offlimiti = 1e-3
```

The current compliance of SMU 2 (the voltage source) must be 10% greater than the maximum programmed current of SMU 1 (the current source).

Current compliance limit (maximum):

```
smua.trigger.source.limiti = 10
```

Guarding and shielding

You can optimize source-measure performance and safety with the effective use of guarding and shielding (noise and safety shields).

Safety shield

You can implement a safety shield to protect the operator from hazards that arise when testing devices under test (DUTs).

Guarding

A driven guard is always enabled and provides a buffered voltage that is at the same level as the input/output HI voltage. The purpose of guarding is to eliminate the effects of leakage current (and capacitance) that can exist between HI and LO. Without guarding, leakage and capacitance in the external high-impedance test circuit could be high enough to adversely affect the performance of the 2601B-PULSE.

Guarding (shown below) should be used when test circuit impedance is $>1 \text{ G}\Omega$.

NOTE

See [Guard](#) (on page 7-24) for details on the principles of guarding.

The guard shield can be the shield of a coaxial cable. It can also be an insulated foil that surrounds the conductor. Refer to [FORCE and SENSE connectors](#) (on page 4-8) for detail on the coaxial connections.

Figure 48: Connections for guarding

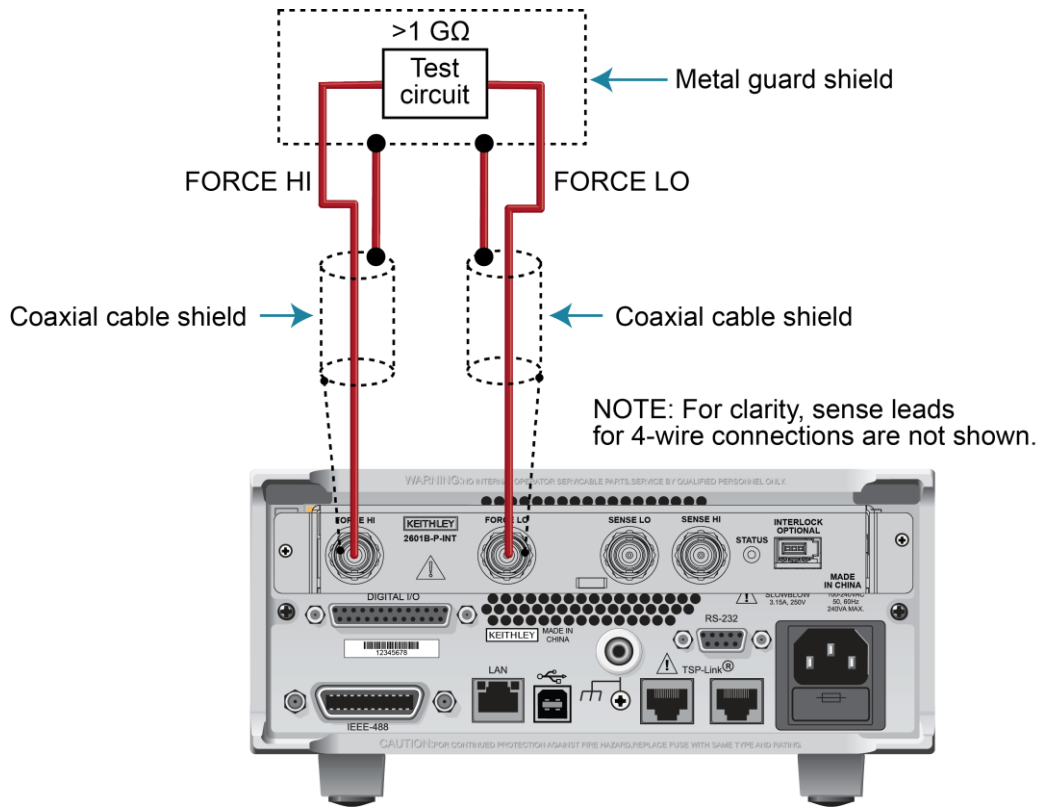

Noise shield

Use a noise shield (see following figure) to prevent unwanted signals from being introduced into the test circuit. Low-level signals may benefit from effective shielding. The metal noise shield surrounds the test circuit and should be connected to LO, as shown.

⚠ WARNING

Connect the enclosure of all metal test fixtures to protective earth (safety ground). See your specific test fixture for information. Nonconductive test fixtures must be rated to double the maximum capability of the test equipment in the system.

⚠ WARNING

Connections to LO on the 2601B-PULSE are not necessarily at 0 V. Hazardous voltages could exist between LO and chassis ground. Make sure that high-voltage precautions are taken throughout the test system. Alternatively, limit hazardous levels by adding external protection to limit the voltage between LO and chassis. Failure to make sure high-voltage precautions are used throughout the test system or a failure to limit hazardous levels could result in severe personal injury or death from electric shock.

Figure 49: Noise shield

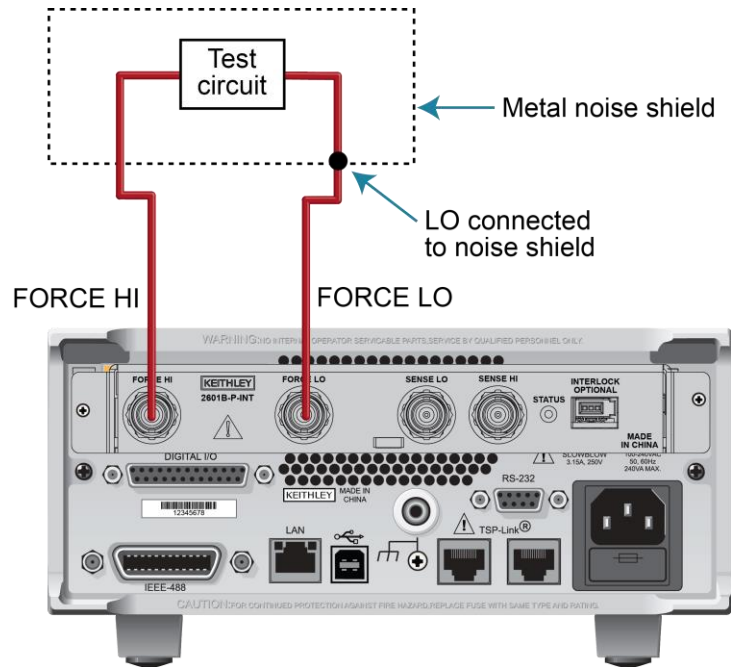

Using shielding and guarding together

The following figures show connections for a test system that uses a noise shield, a safety shield, and guarding. The guard shields are connected to the driven guard of the SMU. The noise shield is connected to LO. The safety shield is connected to the chassis and to protective earth (safety ground).

⚠ WARNING

Connect the enclosure of all metal test fixtures to protective earth (safety ground). See your specific test fixture for information. Nonconductive test fixtures must be rated to double the maximum capability of the test equipment in the system.

Figure 50: Using shielding and guarding together

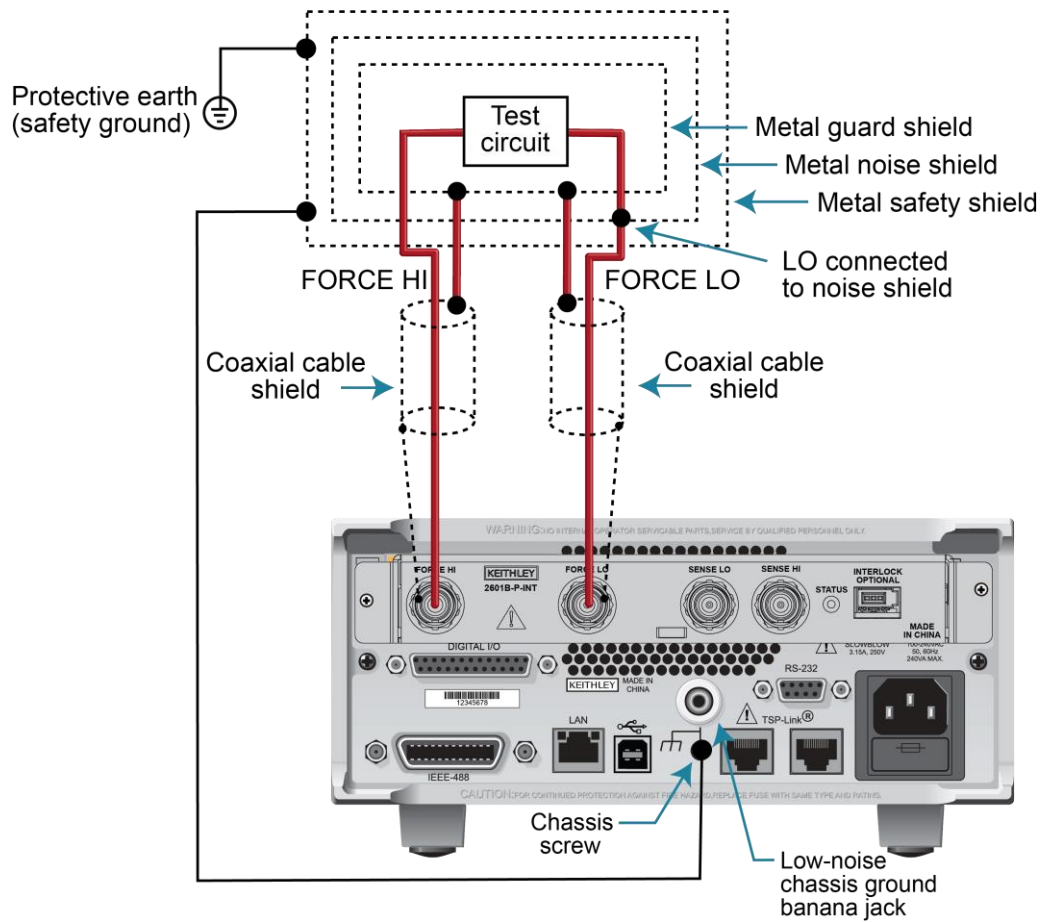

Test fixture

A test fixture can be used to house a device or test circuit. The test fixture can be a metal or nonconductive enclosure, and is typically equipped with a lid and an interlock switch. When properly used, the output of the 2601B-PULSE will turn off when the lid of the test fixture is opened. The test circuit is mounted inside the test fixture. When hazardous voltages ($>30 V_{RMS}$, $42 V_{PEAK}$) will be present, the test fixture must meet the following safety requirements.

⚠ WARNING

To provide protection from shock hazards, an enclosure should be provided that surrounds all live parts.

Nonconductive enclosures must be constructed of materials that are suitably rated for flammability and the voltage and temperature requirements of the test circuit. Connect the enclosure of all metal test fixtures to protective earth (safety ground). See your specific test fixture for information. Nonconductive test fixtures must be rated to double the maximum capability of the test equipment in the system.

For metallic enclosures, the test fixture chassis must be properly connected to protective earth (safety ground). A grounding wire (16 AWG or larger) must be attached securely to the test fixture at a screw terminal designed for safety grounding. The other end of the ground wire must be attached to a known protective earth (safety ground).

Construction material: A metal test fixture must be connected to a known protective earth (safety ground) as described in the above warning. A nonconductive test fixture must be constructed of materials that are suitable for flammability, voltage, and temperature conditions that may exist in the test circuit. The construction requirements for a nonconductive enclosure are also described in the warning above.

Test circuit isolation: With the lid closed, the test fixture must completely surround the test circuit. A metal test fixture must be electrically isolated from the test circuit. Input and output connectors mounted on a metal test fixture must be isolated from the test fixture. Internally, Teflon standoffs are typically used to insulate the internal printed circuit board or guard plate for the test circuit from a metal test fixture.

Interlock switch: The test fixture must have a normally-open interlock switch. The interlock switch must be installed so that when the lid of the test fixture is opened, the switch will open, and when the lid is closed, the switch will close.

The 2601B-P-INT Interlock and Cable Connector Box provides an interlock option. When properly used with a test fixture, when the lid of the test fixture is opened, the FORCE HI and FORCE LO terminals are shorted and the output of the 2601B-PULSE turns off.

See [Using the interlock](#) (on page 2-42) for information on setting up the interlock.

DUT connection settings

This section describes the sense mode and output-off state settings.



Sense mode selection

When the pulser is disabled, the voltage sense mode can be set to use [2-wire local sensing connections](#) (on page 4-10) or [4-wire remote sensing connections](#) (on page 4-10). The default sense setting is 2-wire local.

When the pulser is enabled, the sense mode is fixed at 4-wire remote sensing and the sense mode settings are ignored.

Front panel sense mode selection

To check or change the voltage sense mode from the front panel:

1. Press the **CONFIG** key.
2. Press the **SRC** or **MEAS** key. You can access and set the 2601B-PULSE sense mode from either the V-SOURCE or the V-MEAS menu items.
3. If you pressed the SRC key: select **V-SOURCE > SENSE-MODE**, and then press the **ENTER** key or the navigation wheel .
If you pressed the MEAS key: select **V-MEAS > SENSE-MODE**, and then press the **ENTER** key or the navigation wheel .
4. Select **2-WIRE** or **4-WIRE** as needed, and then press the **ENTER** key or the navigation wheel .

Selecting the sense mode from the remote interface

To select the voltage sense mode from the remote interface:

To configure the 2601B-PULSE SMU for 4-wire remote sensing, send the command:

```
smua.sense = smua.SENSE_REMOTE
```

The following table summarizes the commands to select the sense mode. See the [TSP command reference](#) (on page 11-1) for details on using these commands.

Commands to select sense mode

Command	Description
<code>smua.source.output = smua.OUTPUT_OFF</code>	Turns off the source-measure unit (SMU) output.
<code>smua.sense = smua.SENSE_LOCAL</code>	Select local (2-wire) sense.
<code>smua.sense = smua.SENSE_REMOTE</code>	Select remote (4-wire) sense.

Output-off modes

CAUTION

Carefully consider and configure the appropriate output-off state, source function, and compliance limits before connecting the 2601B-PULSE to a device that can deliver energy (for example, other voltage sources, batteries, capacitors, solar cells, or other 2601B-PULSE instruments). Configure recommended instrument settings before making connections to the device. Failure to consider the output-off state, source, and compliance limits may result in damage to the instrument or to the device under test (DUT).

Turning off the 2601B-PULSE output may not completely isolate the instrument from the external circuit. You can use the output-off mode to place the 2601B-PULSE in a known, safe, noninteractive state during idle periods. The available output-off modes are normal, high-impedance, and zero.

Normal output-off mode

The normal output-off mode is the default output-off mode setting.

When normal is selected and the pulser is disabled, the source function sources either 0 A or 0 V, as set by the `smua.source.offfunc` attribute. The output can be limited using the `smua.source.offlimitY` attribute. The default output-off function is DC voltage with a 40 V limit.

When normal is selected and the pulser is enabled, the output circuit is shorted.

High-impedance output-off mode

For the high-impedance output-off mode (HI-Z), the output relay opens when the output is turned off. This disconnects external circuitry from the input/output of the source-measure unit (SMU). To prevent excessive wear on the output relay, do not use this output-off mode for tests that turn the output off and on frequently.

Zero output-off mode

When the pulser is disabled and the zero output-off mode is selected, the programmed source remains on the display, but internally, the voltage source is selected and is set to 0 V. Measurements are made and displayed.

When the selected source is voltage, the current compliance setting remains the same as the output-on value and compliance detection remains active.

When the selected source is current, the current compliance setting is the programmed current source value or 10 percent full-scale of the present current range, whichever is greater.

You can use the 2601B-PULSE as a current meter when it is in zero output-off mode because it outputs 0 V but measures current.

When the pulser is enabled and the zero output-off mode is selected, the output circuit is shorted and measurements cannot be made.

To configure the output-off mode from the front panel:

1. Press the **CONFIG** key.
2. Press the **OUTPUT ON/OFF** control.
3. Select **OFF-STATE**.
4. Select **MODE**.
5. Select the output-off mode: **HI-Z** (high-impedance), **NORMAL**, or **ZERO**.
6. Press the **EXIT** key to return to the normal display.

To select the normal output-off mode over a remote interface:

```
smua.source.offmode = smua.OUTPUT_NORMAL
```

To select the high-impedance output-off mode over a remote interface:

```
smua.source.offmode = smua.OUTPUT_HIGH_Z
```

To select the zero output-off mode over a remote interface:

```
smua.source.offmode = smua.OUTPUT_ZERO
```

Output-off function

This setting is used only when the output is turned off and the 2601B-PULSE is in set to the normal output-off mode (`smua.source.offmode = smua.OUTPUT_NORMAL`).

You can set the output-off function to **CURRENT** or **VOLTAGE** through the **CONFIG** menu on the front panel, or by using the `smua.source.offfunc` attribute from a remote interface. **VOLTAGE** is the default output-off function.

When the output is turned off and the selected output-off function is **VOLTAGE** (`smua.source.offfunc = smua.OUTPUT_DCVOLTS`):

- The source-measure unit (SMU) sources 0 V.
- The current limit is set by the `smua.source.offlimiti` attribute (default 1 mA).

When the output is turned off and the selected output-off function is **CURRENT** (`smua.source.offfunc = smua.OUTPUT_DCAMPS`):

- The SMU sources 0 A.
- The voltage limit is set by the `smua.source.offlimitv` attribute (default 40 V).

When the output-off function is set to either voltage or current, the SMU may source or sink a very small amount of power. In most cases, this source or sink power level is insignificant.

Selecting the output-off function

NOTE

This setting is used only when the output is turned off and the source-measure unit (SMU) is in NORMAL output-off mode.

To configure the output-off function from the front panel:

1. Press the **CONFIG** key.
2. Press the **OUTPUT ON/OFF** control.
3. Select **OFF-STATE** and then select **FUNCTION**.
4. Select **CURRENT** or **VOLTAGE**.
5. Press the **EXIT** key to return to the normal display.

Remote configuration of the output-off function

To configure the output-off function remotely:

To set 0 V output with current limit set by the `smua.source.offlimiti` attribute:

```
smua.source.offfunc = smua.OUTPUT_DCVOLTS
```

To set 0 A output with voltage limit set by the `smua.source.offlimitv` attribute:

```
smua.source.offfunc = smua.OUTPUT_DCAMPS
```

Output-off limits (compliance)

You can set output-off limits (compliance) for the current and voltage output-off functions using the CONFIG menu on the 2601B-PULSE front panel, or by setting the `smua.source.offlimitY` attribute from a remote interface. The output-off limits only apply when the output-off mode is normal.

Setting output-off limits

Setting the output-off limit for CURRENT (`smua.source.offlimiti`) specifies the current limit for the voltage source; setting the output-off limit for VOLTAGE (`smua.source.offlimitv`) specifies the voltage limit for the current source.

To configure the output-off limits from the front panel:

1. Press the **CONFIG** key.
2. Press the **OUTPUT ON/OFF** control.
3. Select **OFF-STATE** and then select **LIMIT**.
4. Select **CURRENT** or **VOLTAGE**.
5. Set the limit value and then press the **ENTER** key or the navigation wheel  (for details, see [Setting a value](#) (on page 3-11)).
6. Press the **EXIT** key to return to the normal display.

Setting output-off limits using the remote interface

To set the current limit in NORMAL output-off mode remotely:

```
smua.source.offlimiti = iValue
```

To set the voltage limit in NORMAL output-off mode remotely:

```
smua.source.offlimitv = vValue
```

Remote programming output-off states quick reference

The content of the following table is a quick reference of commands for programming output-off states from a remote interface. For more detail, refer to the command descriptions:

- [smua.source.offfunc](#) (on page 11-231)
- [smua.source.offmode](#) (on page 11-233)
- [smua.source.offlimitY](#) (on page 11-232)

Output-off state programming quick reference

Command	Description
smua.source.offmode = smua.OUTPUT_NORMAL	Selects normal output-off mode.
smua.source.offmode = smua.OUTPUT_HIGH_Z	Selects high-impedance output-off mode.
smua.source.offmode = smua.OUTPUT_ZERO	Selects zero output-off mode.
smua.source.offfunc = smua.OUTPUT_DCVOLTS	Sets 0 V output with current limit specified by the smua.source.offlimiti attribute.
smua.source.offfunc = smua.OUTPUT_DCAMPS	Sets 0 A output with voltage limit specified by the smua.source.offlimitv attribute.
smua.source.offlimiti = iValue	Sets current limit in normal output-off mode.
smua.source.offlimitv = vValue	Sets voltage limit in normal output-off mode.

Basic source-measure procedure

Front-panel source-measure procedure



Use the following procedure to perform the basic source-measure operations of the 2601B-PULSE SMU using the front panel. The following procedure assumes that the 2601B-PULSE is already connected to the device under test (DUT), as explained in [DUT test connections](#) (on page 4-6).

WARNING

Hazardous voltages may be present on all output and guard terminals. To prevent electrical shock that could cause injury or death, never make or break connections to the 2601B-PULSE while the instrument is powered on. Turn off the equipment from the front panel or disconnect the main power cord from the rear of the 2601B-PULSE before handling cables. Putting the equipment into standby does not guarantee that the outputs are powered off if a hardware or software fault occurs.



Step 1: Select and set the source level

To select the source and edit the source value:

1. Press the **SRC** key as needed to select the voltage source or current source, as indicated by the units in the source field on the display. The flashing digit (cursor) indicates which value is presently selected for editing.
2. Move the cursor to the digit to change, then press the navigation wheel  to enter the EDIT mode.
3. Use the **RANGE** keys to select a range that will accommodate the value you want to set. See [Range](#) (on page 4-54) for more information. For best accuracy, use the lowest possible source range.
4. Enter the source value.
5. Press the **ENTER** key or the navigation wheel  to complete editing.

Step 2: Set the compliance limit

Perform the following steps to edit the compliance limit value:

1. Press the **LIMIT** key.
2. Move the cursor to the digit to change, then press the navigation wheel  to enter the EDIT mode, as indicated by the EDIT indicator.
3. Enter the limit value, then press the **ENTER** key or the navigation wheel  to complete editing.

Step 3: Select the measurement function and range

Select measurement function and range as follows:

1. Select the measurement function by pressing the **MEAS** key.
2. Set the measurement range with the **RANGE** keys, or enable **AUTO** range. When setting the range, consider the following points:
 - When measuring the source (such as when sourcing V and measuring V), you cannot select the measurement range using the RANGE keys. The selected source range determines the measurement range.
 - When not measuring the source (such as when sourcing V but measuring I), measurement range selection can be done manually or automatically. When using manual ranging, use the lowest possible range for best accuracy. When autorange is enabled, the 2601B-PULSE automatically goes to the most sensitive range to make the measurement.

Step 4: Turn the output on

Turn on the output by pressing the **OUTPUT ON/OFF** switch. The OUTPUT indicator light turns on.

Step 5: Observe readings on the display.

Press the **TRIG** key if necessary to trigger the instrument to begin taking readings. The readings are on the top line, and source and limit values are on the bottom line.

Step 6: Turn the output off

When finished, turn the output off by pressing the **OUTPUT ON/OFF** switch. The OUTPUT indicator light turns off.

Remote source-measure commands

Basic source-measurement procedures can also be performed through a remote interface. To do this, send the appropriate commands. The following table summarizes basic source-measure commands. See [Introduction to TSP operation](#) (on page 9-1) for more information on using these commands. Some source-measure commands are not available when the pulser is enabled. Refer to [Settings ignored when the pulser is enabled](#) (on page 4-36) for information on those commands.

Basic source-measure commands

Command	Description
<code>smua.measure.autorangei = smua.AUTORANGE_ON</code>	Enable current measure autorange
<code>smua.measure.autorangev = smua.AUTORANGE_ON</code>	Enable voltage measure autorange
<code>smua.measure.autorangei = smua.AUTORANGE_OFF</code>	Disable current measure autorange
<code>smua.measure.autorangev = smua.AUTORANGE_OFF</code>	Disable voltage measure autorange
<code>smua.measure.rangei = rangeval</code>	Set current measure range
<code>smua.measure.rangev = rangeval</code>	Set voltage measure range
<code>reading = smua.measure.i()</code>	Request a current reading
<code>reading = smua.measure.v()</code>	Request a voltage reading
<code>iReading, vReading = smua.measure.iv()</code>	Request a current and voltage reading
<code>reading = smua.measure.r()</code>	Request a resistance reading
<code>reading = smua.measure.p()</code>	Request a power reading
<code>smua.source.autorangei = smua.AUTORANGE_ON</code>	Enable current source autorange
<code>smua.source.autorangev = smua.AUTORANGE_ON</code>	Enable voltage source autorange
<code>smua.source.autorangei = smua.AUTORANGE_OFF</code>	Disable current source autorange
<code>smua.source.autorangev = smua.AUTORANGE_OFF</code>	Disable voltage source autorange
<code>smua.source.func = smua.OUTPUT_DCVOLTS</code>	Select voltage source function
<code>smua.source.func = smua.OUTPUT_DCAMPS</code>	Select current source function
<code>smua.source.leveli = sourceval</code>	Set current source value
<code>smua.source.levelv = sourceval</code>	Set voltage source value
<code>smua.source.limiti = level</code>	Set current limit
<code>smua.source.limitv = level</code>	Set voltage limit
<code>smua.source.limitp = level</code>	Set power limit
<code>smua.source.output = smua.OUTPUT_ON</code>	Turn on source output
<code>smua.source.output = smua.OUTPUT_OFF</code>	Turn off source output
<code>smua.source.rangei = rangeval</code>	Set current source range
<code>smua.source.rangev = rangeval</code>	Set voltage source range
<code>smua.sense = smua.SENSE_LOCAL</code>	Select local sense (2-wire)
<code>smua.sense = smua.SENSE_REMOTE</code>	Select remote sense (4-wire)

Requesting readings

You can request readings by including the appropriate measurement command as the argument for the `print()` command. The following programming example illustrates how to request a current reading:

```
print(smua.measure.i())
```

Source-measure programming example

The following SMU programming example illustrates the setup and command sequence of a basic source-measure procedure with the following parameters:

- Source function and range: Voltage, autorange
- Source output level: 5 V
- Current compliance limit: 10 mA
- Measure function and range: Current, 10 mA

```
-- Restore 2601B-PULSE defaults. This disables the pulser.
smua.reset()
-- Select voltage source function.
smua.source.func = smua.OUTPUT_DCVOLTS
-- Set source range to auto.
smua.source.autorangev = smua.AUTORANGE_ON
-- Set voltage source to 5 V.
smua.source.levelv = 5
-- Set current limit to 10 mA.
smua.source.limiti = 10e-3
-- Set current range to 10 mA.
smua.measure.rangei = 10 e-3
-- Turn on output.
smua.source.output = smua.OUTPUT_ON
-- Print and place the current reading in the reading buffer.
print(smua.measure.i(smua.nvbuffer1))
-- Turn off output.
smua.source.output = smua.OUTPUT_OFF
```

Pulser operation

This section contains information specific to using the pulser capabilities of the 2601B-PULSE. The pulser generates fast-edge current pulses and measures current and voltage.

Pulser operation must be set up using TSP commands through a remote communication interface. For information on setting up remote communications, refer to [Remote communication interfaces](#) (on page 2-11).

To use the pulser, you must configure a trigger model. Refer to [Using the trigger model](#) (on page 6-3) for detail.

When the pulser is enabled, there are the following differences in source-measure unit (SMU) functionality:

- You can only source current (not voltage).
- If the output exceeds a maximum pulse width, maximum duty cycle, or the specified protection level during a sweep, the 2601B-PULSE output is shorted, but the sweep continues with no source output until it is finished.

- Some SMU settings are ignored; see [Settings ignored when the pulser is enabled](#) (on page 4-36) for details.
- The `smua.trigger.source.pulsewidth` and `smua.pulser.measure.delay` attributes provide more precise timing than you can achieve using the `smua.trigger.endpulse.stimulus` and `smua.trigger.measure.stimulus` attributes.
- Some of the output-off modes behave differently:
 - **OUTPUT_NORMAL:** The output circuit is shorted when this output-off mode is selected.
 - **OUTPUT_ZERO:** The output circuit is shorted and measurements cannot be made when this output-off mode is selected.
- You cannot use contact check.
- You cannot make measurements when the output is off.
- Compliance limits (`smua.source.limitY`) are not used to control the output. Pulser protection levels are used instead. Refer to [Pulser protection levels](#) (on page 4-4) for information.

If the output is on and you enable or disable the pulser, the output is automatically turned off.

Pulser functional block diagram

The following figure shows a simplified block diagram that represents the function of the pulser circuit.

Figure 51: Functional block diagram of the pulser circuit

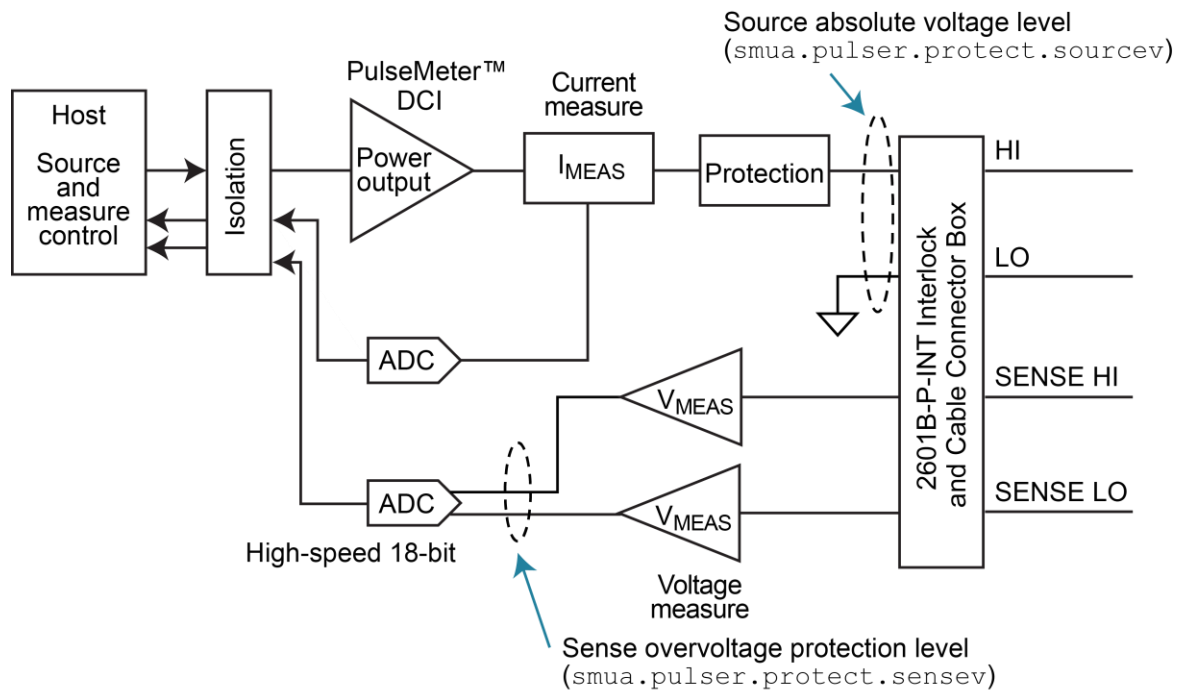

Enable and disable the pulser

To use the pulser of the 2601B-PULSE, you must enable it.

To enable the pulser, send the command:

```
smua.pulser.enable = smua.ENABLE
```

To disable the pulser, send the command:

```
smua.pulser.enable = smua.DISABLE
```

You can also disable the pulser by resetting the instrument through the front panel or a remote command.

TSP commands used with the pulser

You must use remote commands and the trigger model to generate fast-edge current pulses and measure current and voltage.

The following table lists attributes that are used to set up the pulser and measure the resulting current and voltage. You can use the links in the table to go to the full command descriptions.

TSP attributes for use with the 2601B-PULSE pulser

Command	Description
smua.pulser.enable (on page 11-212)	Enables or disables the 2601B-PULSE pulser
smua.pulser.measure.aperture (on page 11-213)	Specifies the pulse measurement aperture when the pulser is enabled
smua.pulser.measure.delay (on page 11-215)	Sets the measurement delay when the pulser is enabled
smua.pulser.protect.sensev (on page 11-216)	Sets a voltage protection level used to monitor the sense terminals when the pulser is enabled
smua.pulser.protect.sourcev (on page 11-217)	Sets an absolute voltage protection level used to monitor the force terminals when the pulser is enabled
smua.pulser.protect.tripped (on page 11-218)	Indicates if the protection circuit was tripped
smua.pulser.rangeY (on page 11-220)	Sets the source and measure ranges when the pulser is enabled
smua.trigger.source.pulsewidth (on page 11-258)	Sets the source pulse width when using a trigger model sweep

The following functions generate calibration constants for the pulser. Refer to [Calibration](#) (on page 13-1) for more information on calibration and adjustment of the 2601B-PULSE.

TSP calibration functions for use with the pulser

Command	Purpose
smua.pulser.measure.calibrateY() (on page 11-214)	Generates and activates new measurement calibration constants for the pulser
smua.pulser.source.calibratebiasi() (on page 11-219)	Adjusts the new bias source calibration constants for the pulser
smua.pulser.source.calibratei() (on page 11-221)	Generates and activates new source calibration constants for the pulser

Settings ignored when the pulser is enabled

The following source-measure unit (SMU) settings are ignored when the pulser is enabled:

- `display.smua.limit.func`
- `smua.measure.autorangeY`
- `smua.measure.autozero`
- `smua.measure.delay`
- `smua.measure.highcrangedelayfactor`
- `smua.measure.lowrangeY`
- `smua.measure.nplc`
- `smua.measure.rangeY`
- `smua.sense`
- `smua.source.autorangeY`
- `smua.source.delay`
- `smua.source.func`
- `smua.source.highc`
- `smua.source.limitY`
- `smua.source.lowrangeY`
- `smua.source.offflimitY`
- `smua.source.rangeY`
- `smua.source.settling`
- `smua.source.sink`
- `smua.trigger.endpulse.action`
- `smua.trigger.endsweep.action`

Settings ignored when the pulser is disabled

The following pulser settings do not affect source-measure unit (SMU) operation when the pulser is disabled:

- `smua.pulser.measure.aperture`
- `smua.pulser.measure.delay`
- `smua.pulser.protect.sensev`
- `smua.pulser.protect.sourcev`
- `smua.pulser.rangeY`

Examples

The following topics contain TSP programming examples for the 2601B-PULSE pulser. You can use these examples as a starting point for your own applications, editing them as needed.

Example 1: Ten-point pulse sweep

The code in this example uses the trigger model to program a 10-point pulse sweep of 10 μs pulses from 1 A to 10 A with a 1 ms pulse period. A 1 Ω resistor is used as the device under test (DUT). The following figure illustrates the pulse action in the example.

Figure 52: 10-point pulse sweep

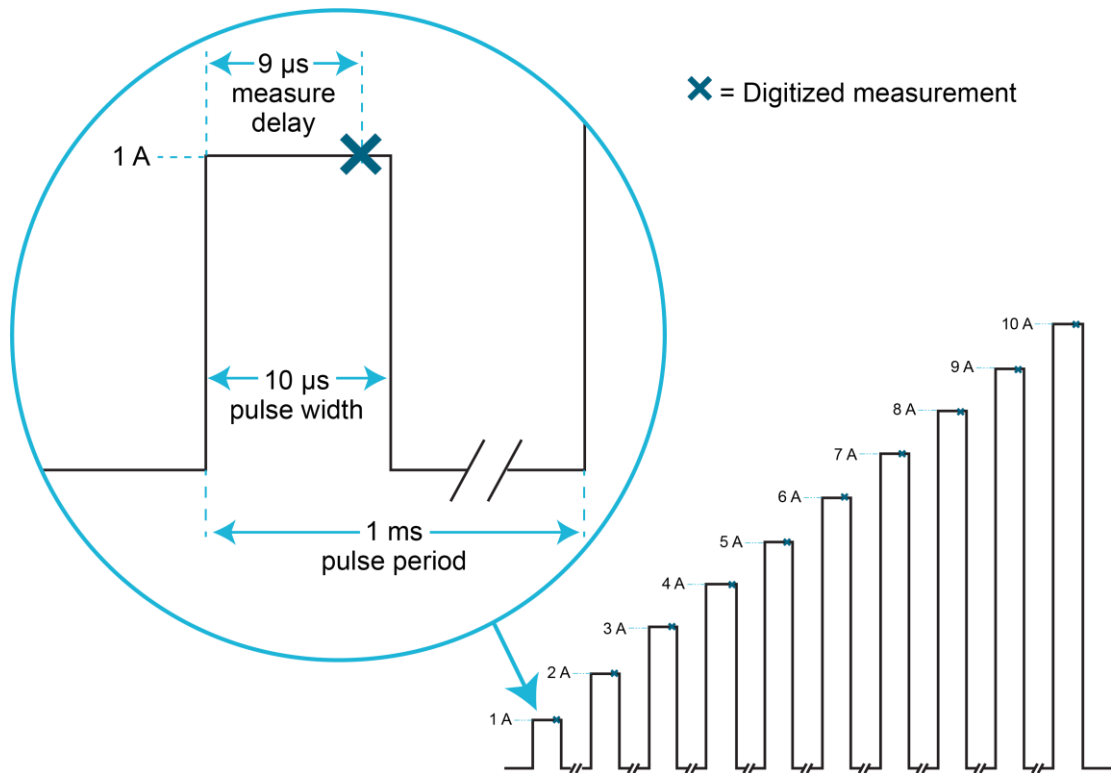

To program the example pulse sweep, send the following commands:

```
-- Restore instrument defaults and clear the measure buffer.
reset()
smua.nvbuffer1.clear()
-- Disable the pulser.
smua.pulser.enable = smua.DISABLE
-- Set contact check speed to fast.
smua.contact.speed = smua.CONTACT_FAST
-- Set the contact check threshold to 100 ohms.
smua.contact.threshold = 100
```

```
-- Check contacts against threshold.
if not smua.contact.check() then
  -- Set speed to slow.
  smua.contact.speed = smua.CONTACT_SLOW
  -- Get aggregate resistance readings.
  rhi, rlo = smua.contact.r()
  -- Return contact resistances to the host.
  print(rhi, rlo)
  -- Terminate execution.
  exit()
end
-- Set the number of pulses to 10.
smua.trigger.count = 10

-- Set trigger timer 1 to generate additional trigger events for the pulse sweep
-- corresponding to the 9 pulses that follow the first one.
trigger.timer[1].count = smua.trigger.count - 1

-- Set trigger timer 1 to delay for 1 ms between events, corresponding to the
-- pulse period.
trigger.timer[1].delay = 1e-3

-- Enable pass-through mode so that the first trigger passes through immediately
-- to generate the first pulse.
trigger.timer[1].passthrough = true

-- Specify which event starts the timer.
trigger.timer[1].stimulus = smua.trigger.ARMED_EVENT_ID

-- Enable source level changes during the sweep.
smua.trigger.source.action = smua.ENABLE

-- Specify a 10-point linear pulse sweep from 1 A to 10 A.
smua.trigger.source.lineari(1, 10, smua.trigger.count)

-- Set the source pulse width to 10 microseconds.
smua.trigger.source.pulsewidth = 10e-6

-- Configure the 2601B-PULSE to start the pulse when the trigger
-- timer event occurs.
smua.trigger.source.stimulus = trigger.timer[1].EVENT_ID

-- Enable measurements after a 9 microsecond pulse measure delay and save the result
-- in nvbuffer1. This applies for a 1 microsecond measure aperture.
smua.trigger.measure.action = smua.ENABLE
smua.pulser.measure.delay = 9e-6
smua.trigger.measure.v(smua.nvbuffer1)
-- Set the pulser ranges.
smua.pulser.rangei = 10
smua.pulser.rangev = 10
-- Enable pulser.
smua.pulser.enable = smua.ENABLE

-- Turn the source output on.
smua.source.output = smua.OUTPUT_ON
```

```
-- Initiate the trigger model.
smua.trigger.initiate()

-- Wait for pulse commands to complete.
waitcomplete()

-- Turn the source output off.
smua.source.output = smua.OUTPUT_OFF

-- Output the readings stored in the buffer as a comma-separated string.
printbuffer(1, smua.nvbuffer1.n, smua.nvbuffer1)
```

Example 2: Generate a pulse with a voltage protection level

This example demonstrates how to use the 2601B-PULSE pulser to generate a current pulse with a voltage protection level.

The code in this example generates a single 50 μs , 1 A pulse on the 1 A range, with an 8 V protection level. The measurement occurs 35 μs after the start of the pulse and has a 10 μs aperture. When the pulse is complete, it checks whether the pulse terminated early due to the voltage protection level. The following figure depicts the pulse action in the example.

Figure 53: Generating a single current pulse with a 35 μs delay and a 10 μs measure aperture

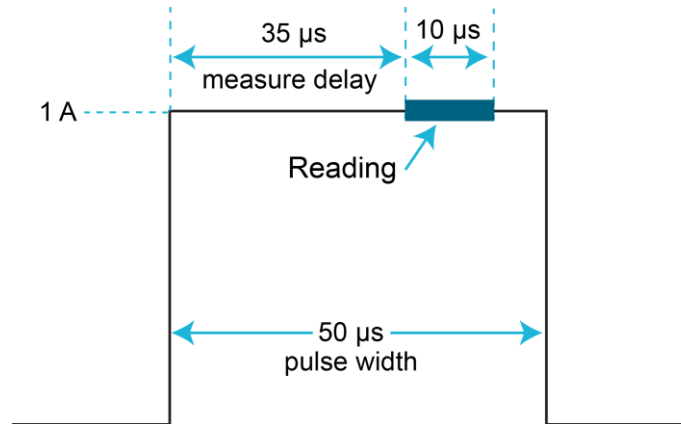

To program the example pulse, send the following commands:

```
-- Restore instrument defaults and clear measure buffer.
reset()
smua.nvbuffer1.clear()

-- Set the number of pulses to 1.
smua.trigger.count = 1

-- Enable source level changes.
smua.trigger.source.action = smua.ENABLE

-- Trigger the source action when the SMU moves
-- from the arm layer to the trigger layer.
smua.trigger.source.stimulus = smua.trigger.ARMED_EVENT_ID

-- Set the pulser source to the 1 A range.
smua.pulser.rangei = 1

-- Set the pulser to source a 1 A pulse.
smua.trigger.source.listi({1})

-- Set the pulser voltage protection limit to 8 V.
smua.pulser.protect.sensev = 8
-- Set the source pulse width to 50 microseconds.
smua.trigger.source.pulsewidth = 50e-6
-- Enable measurements.
smua.trigger.measure.action = smua.ENABLE

-- Specify a 35 microsecond pulser measure delay and a
-- 10 microsecond measurement aperture.
smua.pulser.measure.delay = 35e-6
smua.pulser.measure.aperture = 10e-6

-- Set to measure voltage and save the results in nvbuffer1.
smua.trigger.measure.v(smua.nvbuffer1)

-- Enable the pulser.
smua.pulser.enable = smua.ENABLE

-- Turn the source output on and initiate the trigger model.
smua.source.output = smua.OUTPUT_ON
smua.trigger.initiate()

-- Wait for pulser commands to complete.
waitcomplete()

-- Turn the source output off.
smua.source.output = smua.OUTPUT_OFF

-- Output the voltage reading stored in the buffer.
print(smua.nvbuffer1[1])

-- Check whether the pulse terminated early because of the voltage
-- protection limit and output the result.
print(smua.pulser.protect.tripped)
```

Operation considerations for the ADC

The following paragraphs discuss autozero and NPLC caching with the [analog-to-digital converter](#) (on page 7-1) (ADC).

Autozero

When the pulser is disabled, the ADC of the 2601B-PULSE uses a ratiometric A/D conversion technique. To ensure reading accuracy, the instrument must periodically obtain fresh measurements of its internal ground and voltage reference. Separate reference and zero measurements are used for each aperture.

You can set autozero to occur automatically or turn it off and run it manually.

By default, autozero is set to AUTO, which automatically checks the reference measurements whenever a signal measurement is made. If the reference measurements are out of date when a signal measurement is made, the instrument automatically makes two more A/D conversions, one for the reference and one for the zero, before returning the result. Thus, occasionally, a measurement takes longer than normal. This extra time can cause problems in sweeps and other test sequences in which measurement timing is critical.





To avoid the extra time for the reference measurements, you can select OFF. This setting disables the automatic reference measurements. Note that with automatic reference measurements disabled, the instrument may gradually drift out of specification. Select the autozero ONCE option to refresh the reference and zero measurements that are used for the current aperture setting.

To minimize the drift, a reference and zero measurement should be made immediately before critical test sequences.

When the pulser is enabled, two high-speed digitizing sampling ADCs are used to measure voltage and current. These ADCs do not use a ratiometric conversion technique, so the autozero settings are ignored when the pulser is enabled.

Front-panel autozero

To change autozero from the front panel:

1. Press the **CONFIG** key.
2. Press the **MEAS** key.
3. Turn the navigation wheel  to select **AUTO-ZERO**, and then press the **ENTER** key or the navigation wheel .
4. Turn the navigation wheel  to select the mode (**OFF**, **ONCE**, or **AUTO**), and then press the **ENTER** key or the navigation wheel .
5. Press the **EXIT (LOCAL)** key to return to the previous display.

Remote command autozero

To set autozero from a remote interface:

Use the autozero command with the appropriate option shown in the following table to set autozero through a remote interface. For additional detail, refer to [smua.measure.autozero](#) (on page 11-195)). For example, send the following command to enable automatic reference measurements:

```
smua.measure.autozero = smua.AUTOZERO_AUTO
```

Autozero command and options

Command	Description
<code>smua.measure.autozero = smua.AUTOZERO_OFF</code>	Disable autozero. Old NPLC cache values are used when autozero is disabled (see NPLC caching (on page 4-42)).
<code>smua.measure.autozero = smua.AUTOZERO_ONCE</code>	After immediately taking one reference and one zero measurement, turns automatic reference measurements off.
<code>smua.measure.autozero = smua.AUTOZERO_AUTO</code>	Automatically takes new acquisitions when the 2601B-PULSE determines reference and zero values are out-of-date.

NPLC caching

NPLC caching speeds up operation by caching A/D reference and zero values for up to the ten most recent measurement aperture settings. Whenever the integration rate is changed using the SPEED key, or a user setup is recalled, the NPLC cache is checked. If the integration rate is already stored in the cache, the stored reference and zero values are recalled and used. If the integration rate is not already stored in the cache, a reference and zero value is acquired and stored in the cache when the next measurement is made. If there are already ten NPLC values stored, the oldest one is overwritten by the newest one. When autozero is off, NPLC values stored in the cache are used regardless of age.

Triggering in local mode

It is not necessary to change any trigger settings to use the basic source and measurement procedures covered in this section.

NOTE

Press the **MENU** key, and then select **SETUP > RECALL > INTERNAL > FACTORY** to reset the factory default conditions.

The following figure shows the general sequence for SMU measurement triggering. The basic sequence is as follows:

- When the output is turned on, the programmed source value is immediately applied to the device under test (DUT).
- Through front panel only: If the immediate trigger source is selected, a measurement is triggered immediately. However, if the manual trigger source is selected, the front-panel TRIG key must be pressed.
- The instrument waits for the programmed delay period (if any).
- The instrument takes one measurement.
- If the number of measurements is less than the programmed trigger count, it cycles back to take another measurement (the measurement cycle will be repeated indefinitely if the infinite trigger count is selected).
- For multiple measurements, the instrument waits for the programmed trigger interval (if any) before taking the next measurement.

Figure 54: Local triggering

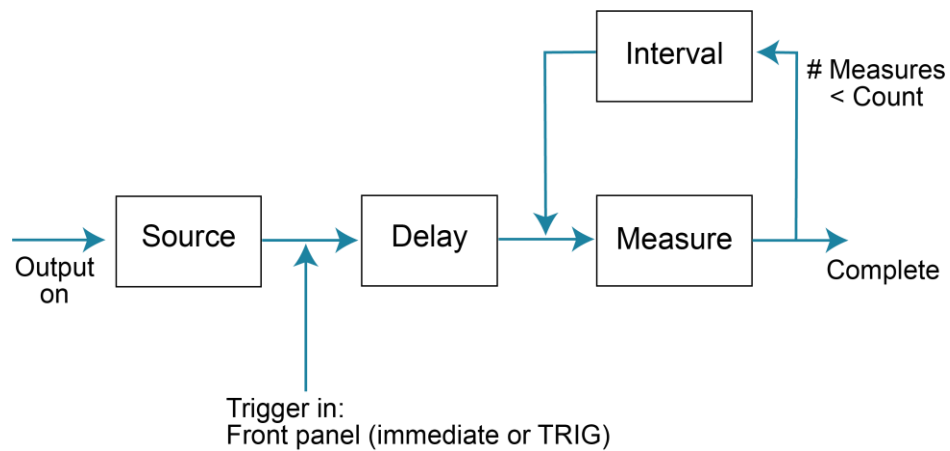

Configuring trigger attributes in local mode

From the front panel, press the **CONFIG** key and select **TRIG**. These menu items are available:





- **TRIGGER-IN:** Use these options to select the trigger-in source:
 - **IMMEDIATE:** Triggering occurs immediately and the instrument starts to make measurements when it is ready (for example, after the source output is turned on).
 - **MANUAL:** The front-panel TRIG key must be pressed to trigger the instrument to make readings.
- **COUNT:** Sets the trigger count (number of measurements) as follows:
 - **FINITE:** The instrument goes through measurement cycles for the programmed trigger count (1 to 99999).
 - **INFINITE:** The instrument goes through measurement cycles indefinitely until halted.
- **INTERVAL:** Sets the time interval between measurements (0 s to 999.999 s) when the count is greater than 1.
- **DELAY:** Sets the delay period between the trigger and the start of measurement (0 s to 999.999 s).

Front-panel triggering example

This example uses the front panel to configure the trigger parameters to meet the following requirements:

- Manual triggering (TRIG key)
- Infinite trigger count (cycle indefinitely through measurement cycles)
- Interval (time between measurements): 1 s
- Delay (time from trigger to measurement): 2 s

To configure the trigger parameters:

1. Press the **CONFIG** key, and then the **TRIG** key.
2. Select **TRIGGER-IN**, and then press the **ENTER** key or the navigation wheel .
3. Select **MANUAL**, and then press the **ENTER** key or the navigation wheel .
4. Select **COUNT**, then select **INFINITE**, and then press the **ENTER** key or the navigation wheel .
5. Select **INTERVAL**, set the interval to 1 s, and then press the **ENTER** key or the navigation wheel .
6. Choose **DELAY**, set the delay to 2 s, and then press the **ENTER** key.
7. Use the **EXIT (LOCAL)** to return to the normal display.
8. Press the **OUTPUT ON/OFF** control to turn the output on.
9. Press **TRIG**. A 2 s delay occurs before the first measurement. The instrument cycles through measurements indefinitely with a 1 s interval between measurements.
10. Press the **OUTPUT ON/OFF** control again to stop making readings.

Configuring for measure-only tests using the MODE key

In addition to being used for conventional source-measure operations, the 2601B-PULSE can also be used like a meter to measure current, voltage, resistance, or power.

NOTE

Measure-only tests are not available when the pulser is enabled.

To configure the 2601B-PULSE as a voltage meter, current meter, ohmmeter, or wattmeter:

1. Press the **MODE** key.
2. Turn the navigation wheel  to select the type of meter from the menu (**I-METER**, **V-METER**, **OHM-METER**, or **WATT-METER**).
3. Press the **ENTER** key to complete the configuration of the 2601B-PULSE as the selected meter.

To manually configure the settings, refer to the following topics:

- [Voltmeter and ammeter measurements](#) (on page 4-45)
- [Ohms measurements](#) (on page 4-46)
- [Power measurements](#) (on page 4-49)

Voltmeter and ammeter measurements

NOTE

Voltmeter and ammeter measurements are not available when the pulser is enabled.

To make voltmeter and ammeter measurements without using the MODE key (such as when configuring measure-only tests over the remote interface), follow the procedure below.

To use the 2601B-PULSE to measure voltage or current:

1. Select the source-measure functions:
 - **Voltmeter:** Press the **SRC** key to select the current source, and press the **MEAS** key to select the voltage measurement function.
 - **Ammeter:** Press the **SRC** key to select the voltage source, and press the **MEAS** key to select the current measurement function.
2. Set source and compliance levels. To edit the source level, use the procedure provided in [Step 1: Select and set the source level](#) (on page 4-30); to edit the compliance level, use the procedure provided in [Step 2: Set the compliance limit](#) (on page 4-30):
 - Select the lowest source range and set the source level to zero.
 - Set compliance to a level that is higher than the expected measurement.

CAUTION

When using the 2601B-PULSE as a voltmeter, the voltage compliance limit must be set higher than the voltage that is being measured. Failure to do this could result in excessive current flow into the 2601B-PULSE, incorrect measurements, and possible damage to the instrument.

3. Use the **RANGE** keys to select a fixed measurement range that will accommodate the expected reading. Use the lowest possible range for best accuracy. You can also select autorange, which automatically sets the 2601B-PULSE to the most sensitive range.
4. Connect the voltage or current to be measured. Make sure to use 2-wire connections from the 2601B-PULSE to the device under test (DUT) (see [DUT test connections](#) (on page 4-6)).
5. Press the **OUTPUT ON/OFF** control to turn the output on.
6. View the displayed reading (press the **TRIG** key if necessary).

When finished, press the **OUTPUT ON/OFF** control to turn the output off.

Ohms measurements

Resistance readings are calculated from the measured current and measured voltage as follows:

$$R = V/I$$

Where:

R is the calculated resistance

V is the measured voltage

I is the measured current

Ohms ranging

The front panel ohms function does not use ranging. The instrument formats a calculated resistance reading (V/I) to best fit the display. There may be leading zeros if the ohms reading is less than 1 m Ω .

Basic ohms measurement procedure

When you use the MODE key to select ohms measurement, the 2601B-PULSE is automatically configured as a current source with a level of 1 mA. To change the source function, source value, or compliance value (in other words, customize the standard ohmmeter configuration of the MODE key), then use the following steps to make ohms measurements. The following procedure assumes that the 2601B-PULSE is already connected to the device under test (see [DUT test connections](#) (on page 4-6)).

To make an ohms measurement:

1. Press the **SRC** key to select the source function.
2. Set the output source (current or voltage, dependent on which function is selected) to a value based on the expected resistance. See [Step 1: Select and set the source level](#) (on page 4-30).
3. Press the **LIMIT** key to edit the voltage or current limit. When programming a voltage limit, set the voltage limit above the maximum expected voltage across the resistor under test. When programming a current limit, set the current limit at or above the maximum expected current through the resistor under test. See [Step 2: Set the compliance limit](#) (on page 4-30).
4. Press the **MEAS** key to display voltage or current.
5. Make sure that AUTO measurement range is on (press the **AUTO** key if needed).
6. Press the **MEAS** key as many times as needed to display ohms.
7. Press the **OUTPUT ON/OFF** control to turn the output on.
8. View the displayed reading (press the **TRIG** key if necessary). When finished, press the **OUTPUT ON/OFF** control again to turn the output off.

Remote ohms command

Use the `smua.measure.r()` function to get a resistance reading. The programming example below illustrates how to get a resistance reading:

```
reading = smua.measure.r()
```

See [Remote source-measure commands](#) (on page 4-31) for more commands to set up source and measure functions, and [Introduction to TSP operation](#) (on page 9-1) for more details.

Ohms programming example

The following programming example illustrates the setup and command sequence of a typical ohms measurement procedure with the following parameters:

- Source function: current, 10 mA range, 10 mA output
- Voltage measure range: auto
- Voltage compliance: 10 V
- Sense mode: 4-wire

```
-- Restore 2601B-PULSE defaults.
smua.reset()
-- Select current source function.
smua.source.func = smua.OUTPUT_DCAMPS
-- Set source range to 10 mA.
smua.source.rangei = 10e-3
-- Set current source to 10 mA.
smua.source.leveli = 10e-3
-- Set voltage limit to 10 V.
smua.source.limitv = 10
-- Enable 4-wire ohms.
smua.sense = smua.SENSE_REMOTE
```

```

-- Set voltage range to auto.
smua.measure.autorangev = smua.AUTORANGE_ON
-- Turn on output.
smua.source.output = smua.OUTPUT_ON
-- Get resistance reading.
print(smua.measure.r())
-- Turn off output.
smua.source.output = smua.OUTPUT_OFF

```

Ohms sensing

Ohms measurements can be made using either 2-wire or 4-wire sensing. See [DUT test connections](#) (on page 4-6) for information on connections and sensing methods.

The 2-wire sensing method has the advantage of requiring only two test leads. However, as shown in the following figure (2-wire resistance sensing), test lead resistance can seriously affect the accuracy of 2-wire resistance measurements, particularly with lower resistance values.

Figure 55: Two-wire resistance sensing

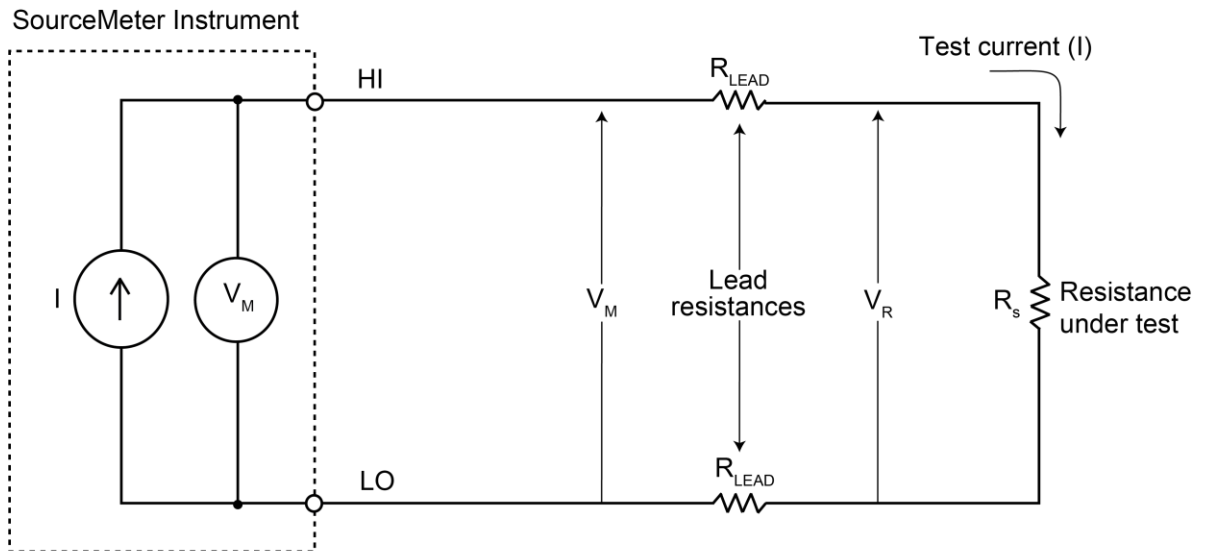

I = Current sourced

V_M = Voltage measured

V_R = Voltage across resistor

$$\text{Measured resistance} = \frac{V_M}{I} = R_s + (2 \times R_{LEAD})$$

$$\text{Actual resistance} = \frac{V_R}{I} = R_s$$

The 4-wire sensing method, as shown in the following figure (4-wire resistance sensing), minimizes or eliminates the effects of lead resistance by measuring the voltage across the resistor under test with a second set of test leads. Because of the high input impedance of the voltmeter, the current through the sense leads is negligible, and the measured voltage is essentially the same as the voltage across the resistor under test.

Figure 56: Four-wire resistance sensing

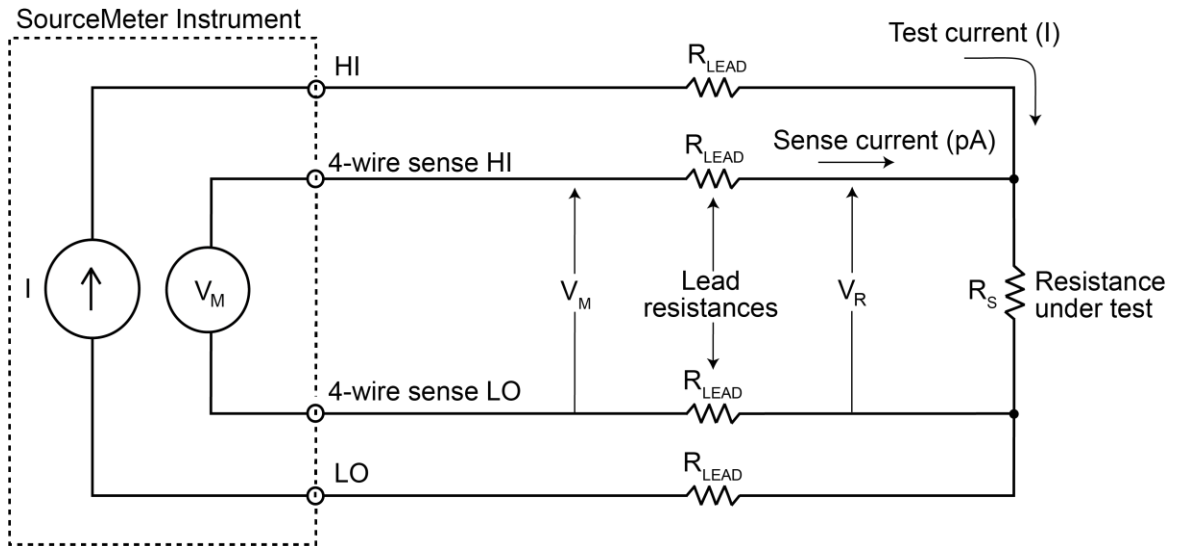

I = Current sourced by SourceMeter
 V_M = Voltage measured by SourceMeter
 V_R = Voltage across resistor

Because sense current is negligible, $V_M = V_R$
 and measured resistance = $\frac{V_M}{I} = \frac{V_R}{I} = R_S$

Power measurements

Power readings are calculated from the measured current and voltage as follows:

$$P = V \times I$$

Where:

P is the calculated power

V is the measured voltage

I is the measured current

Basic power measurement procedure

If you need to customize the standard wattmeter configuration of the MODE key, perform the following steps to make power measurements. The following procedure assumes that the 2601B-PULSE is already connected to the device under test (DUT) as explained in [DUT test connections](#) (on page 4-6).

WARNING

Hazardous voltages may be present on all output and guard terminals. To prevent electrical shock that could cause injury or death, never make or break connections to the 2601B-PULSE while the output is on. Turn off the equipment from the front panel or disconnect the main power cord from the rear of the 2601B-PULSE before handling cables. Putting the equipment into an output-off state does not guarantee that the outputs are powered off if a hardware or software fault occurs.

To perform power measurements from the front panel:

1. Set source function and value. Press the **SRC** key to select the voltage or current source function as required.
2. Set the output voltage or current to an appropriate value. See Step 1 of [Front-panel source-measure procedure](#) (on page 4-30).
3. Press the **LIMIT** key and set the voltage or current limit high enough for the expected voltage or current across the DUT to be measured. See Step 2 of [Front-panel source-measure procedure](#) (on page 4-30).
4. Press the **MEAS** key as many times as needed to display power.
5. Press the **OUTPUT ON/OFF** control to turn the output on.
6. View the displayed reading (press the **TRIG** key if necessary).
7. When finished, press the **OUTPUT ON/OFF** control again to turn the output off.

Power measurements using the remote interface

The following paragraphs summarize basic power measurement commands using the remote interface and also give a programming example for a typical power measurement situation.

Remote power reading command

The programming example below illustrates how to get a power reading:

```
reading = smua.measure.p()
```

See [Remote source-measure commands](#) (on page 4-31) for more commands necessary to set up source and measure functions and also [Introduction to TSP operation](#) (on page 9-1).

Power measurement programming example

The following SMU programming example illustrates the setup and command sequence for a typical power measurement procedure with the following parameters:

- Source function: Voltage, source autorange, 5 V output
- Current measure function and range: Current, autorange
- Current compliance: 50 mA

```
-- Restore 2601B-PULSE defaults. This disables the pulser.
smua.reset()
-- Select voltage source function.
smua.source.func = smua.OUTPUT_DCVOLTS
-- Enable source autoranging.
smua.source.autorangev = smua.AUTORANGE_ON
-- Set voltage source to 5 V.
smua.source.levelv = 5
-- Set current limit to 50 mA.
smua.source.limitei = 50e-3
-- Set current range to auto.
smua.measure.autorangei = smua.AUTORANGE_ON
-- Turn on output.
smua.source.output = smua.OUTPUT_ON
-- Get power reading.
print(smua.measure.p())
-- Turn off output.
smua.source.output = smua.OUTPUT_OFF
```

Saved setups

You can restore the 2601B-PULSE to one of six nonvolatile-memory setup configurations (five user setups and one factory default), or to a setup stored on an external USB flash drive. As shipped from the factory, the 2601B-PULSE powers up with the factory default settings, which cannot be overwritten. The default settings are also in the five user setup locations, but may be overwritten. The factory default settings are listed in the command descriptions in the [TSP command reference](#) (on page 11-1).

The setup configuration that is used when the instrument powers up can be changed.

Saving user setups

You can save the present 2601B-PULSE setup to internal nonvolatile memory or a USB flash drive.

To save a user setup to nonvolatile memory from the front panel:

1. Configure the 2601B-PULSE to the settings that you want to save.
2. Press the **MENU** key.
3. Select **SETUP** and then press the **ENTER** key.
4. Select the **SAVE** menu item and then press the **ENTER** key.
5. Select **INTERNAL** and then press the **ENTER** key.
6. Select the user number (1 through 5), and press the **ENTER** key.

To save a user setup to an external USB flash drive from the front panel:

1. Configure the 2601B-PULSE to the settings that you want to save.
2. Insert the USB flash drive into the USB port on the front panel of the 2601B-PULSE.
3. Press the **MENU** key.
4. Select **SETUP** and then press the **ENTER** key.
5. Select **SAVE** and then press the **ENTER** key.
6. Select **USB1**. The file name `setup000.set` is displayed.
7. Turn the navigation wheel  to change the last three digits of the file name and then press the **ENTER** key.

Recalling a saved setup

You can recall setups from internal nonvolatile memory or a USB flash drive at any time.

To recall a saved setup from the front panel:

1. Press the **MENU** key to access the main menu.
2. Select **SETUP**, and then press the **ENTER** key.
3. Select the **RECALL** menu item, and then press the **ENTER** key.
4. Select one of the following:
 - **INTERNAL**
 - **USB1**
5. **INTERNAL** only: Do one of the following:
 - Select **FACTORY** to restore factory defaults, then press the **ENTER** key.
 - Select the user number (1 through 5), then press the **ENTER** key.
 - **USB1** only: Select the appropriate file and then press the **ENTER** key.

Start-up configuration

You can specify the 2601B-PULSE start-up (power-on) configuration from the front panel. Set the start-up configuration to a previously stored setup (recalled from internal nonvolatile memory) or reset to the factory default setup.

To select the power-on setup:

1. Press the **MENU** key to access the main menu.
2. Select **SETUP**, and then press the **ENTER** key.
3. Select **POWERON**, and then press the **ENTER** key.
4. Select the configuration to use.
5. Press the **ENTER** key.
6. Use the **EXIT (LOCAL)** key to return to the main display.

Saving user setups from a remote interface

Use the `setup.save()` and `setup.recall()` functions to save and recall user setups.

To save and recall user setups using remote commands:

The following example saves the present setup as setup 1, and then recalls setup 1:

```
-- Save the present setup to nonvolatile memory.  
setup.save(1)  
-- Recall the saved user setup from nonvolatile memory.  
setup.recall(1)
```

Restoring the factory default setups

Use one of the reset functions to return the 2601B-PULSE to the original factory defaults. An example of each type of reset is shown in the following program examples.

Restore all factory defaults of all nodes on the TSP-Link® network:

```
reset()
```

Restore all factory defaults (note that you cannot use `*rst` in a script):

```
*rst
```

Restore all factory defaults:

```
setup.recall(0)
```

Restore SMU defaults:

```
smua.reset()
```

Reset only the local TSP-Link node:

```
localnode.reset()
```

Start-up (power-on) configuration

You can specify the 2601B-PULSE start-up (power-on) configuration. Use the `setup.poweron` attribute to select which setup to return to upon power-up. To set the `setup.poweron` configuration attribute:

```
setup.poweron = n      -- Select power-on setup.
```

Where n is:

- 0 (*RST or `reset()` factory defaults)
- 1 to 5 (user setup 1 to 5)

Range

The selected measurement range affects the accuracy of the measurements and the maximum signal that can be measured. If the range is changed, the front-panel display may contain dashes instead of a reading (for example, `--.---- mA`). This indicates that no measurement was made using the range that is presently selected. To update the displayed reading, trigger a measurement (if in local control, press the TRIG key).

Available ranges

The following table lists the available SMU source and measurement ranges.

Voltage ranges	Current ranges
100 mV	100 nA
1 V	1 μ A
6 V	10 μ A
40 V	100 μ A
	1 mA
	10 mA
	100 mA
	1 A
	3 A

The following table lists the pulser voltage and current ranges.

Voltage range	Source	Measure
5 V	Not applicable	5.1 V
10 V	Not applicable	10.2 V
Current ranges		
1 A	± 1.01 A	± 1.02 A
5 A	± 5.05 A	± 5.1 A
10 A	± 10.1 A	± 10.2 A
250 mA (DC bias)	± 250 mA	Selected pulse measure range

The 2601B-PULSE can sustain a measurement speed of 33,000, as determined by:

$$(\text{Pulse rate per second}) + (\text{Measurements per second} \times \text{Filter count}) < 33000$$

If this rate is exceeded, the instrument may not be able to sustain the sweep.

Maximum source values and readings

The full-scale output for each voltage and current source range is 101 percent of the selected range, but the full-scale measurement is 102 percent of the range. For example, ± 1.01 A is the full-scale source value for the 1 A range, and ± 102 mA is the full-scale reading for the 100 mA measurement range. Input levels that exceed the maximum levels cause the overflow message to be displayed. Note, however, that the instrument will autorange at 100 percent of the range.

Measure auto delay

When the pulser is disabled, the measure delay is a specific delay that is applied before each measurement is made. This delay is disabled by default (measurements are made immediately). You can change the default delay by setting the [smua.measure.delay](#) (on page 11-198) attribute either to a specific value or to an auto delay setting (set `smua.measure.delay = smua.DELAY_AUTO`). If the measure delay is set to the auto delay setting, a range-dependent delay is applied each time the instrument performs a current measurement. This delay also happens for the measurement that is taken after changing current ranges during an autoranged measurement.

You can increase or decrease the auto delay by changing the delay factor. For example, to reduce the delay across all ranges by half, set `smua.measure.delayfactor = 0.5`. For additional information, refer to [smua.measure.delayfactor](#) (on page 11-199).

Manual ranging

Use the range keys,  and , to select a fixed range:

- To set the source range, press the **SRC** key, and then use the **RANGE** keys to set the range.
- To set the measure range, select the display mode, and then use the **RANGE** keys to set the range.

If the instrument displays the overflow message on a particular range, select a higher range until an on-range reading is displayed. To ensure the best accuracy and resolution, use the lowest range possible that does not cause an overflow.

Ranging limitations

If the source and measure functions are different (such as source V and measure I, or source I and measure V), you can set source and measure ranges separately. If both the source and the measure functions are the same, the measure range is locked to the source range.

With the 40 V V-Source range selected, the highest current measurement range is 1 A. With the 3 A I-Source range selected, the highest voltage measurement range is 6 V. Refer to [Operating boundaries](#) (on page 7-6) for power derating information.

Autoranging

To use automatic source ranging, press **SRC** then the **AUTO** range key.

To use automatic measure ranging, press the **MEAS** key followed by the **AUTO** range key. The AUTO indicator turns on when source or measure autoranging is selected.

When autorange is selected, the instrument automatically sets the best range to source or measure the applied signal. The instrument will uprange at 100 percent of the present range.



NOTE

When you change a source value, source autoranging is automatically turned off and remains off until you re-enable it.

Low range limits

The low range limit sets the lowest range that the 2601B-PULSE will use when autoranging is enabled. This feature is useful for minimizing autorange settling times when measurements require numerous range changes.

To individually set low range limits for Source V, Source I, Measure V, and Measure I:

1. Press the **CONFIG** key, then press either the **SRC** key (for source) or the **MEAS** key (for measure).
2. Select voltage or current source, or measure, as appropriate, and then press the **ENTER** key or the navigation wheel .
3. Select **LOWRANGE**, and then press the **ENTER** key or the navigation wheel .
4. Set the low range to the appropriate setting, and then press the **ENTER** key or the navigation wheel .
5. Press the **EXIT (LOCAL)** key twice to return to the main display.

Range considerations

The source range and measure range settings can interact depending on the source function. Additionally, the output state (on/off) can affect how the range is set. The following table describes these interactions:

If...	Then...	Notes
The source function is the same as the measurement function (for example, sourcing voltage and measuring voltage)	The measurement range is locked to be the same as the source range.	The setting for the voltage measure range is retained and used when the source function is changed to current. 2601B-PULSE example: <pre>smua.source.func = smua.OUTPUT_DCVOLTS smua.source.rangev = 1 smua.measure.rangev = 10 -- will print 1, the source range print(smua.measure.rangev) smua.source.func = smua.OUTPUT_DCAMPS -- will print 10, the measure range print(smua.measure.rangev)</pre>
A source or measurement range for a function is explicitly set	Autoranging for that function is disabled.	Autoranging is controlled separately for each source and measurement function: source voltage, source current, measure voltage, and measure current. Autoranging is enabled for all four by default.
Source autoranging is enabled	The output level controls the range.	Querying the range after the level is set returns the range the instrument chose as appropriate.
You send a source level that is out of range while autorange is off	The instrument will not return an error until the output is turned on.	While the output is turned off, the display shows a series of question marks. For example, ????. ???mA is displayed for the 100 mA range. The display also shows a series of question marks when pulsing in the extended operating area on the 10 A range.
Measure autoranging is enabled	Measure range is changed only when measurement made.	Querying the range after the measurement is taken will return the range that the instrument chose.

Range commands

The following tables summarize the commands that control measure and source ranges.

For information on the measure, source, and pulser ranges, refer to [Available ranges](#) (on page 4-54).

See the [TSP command reference](#) (on page 11-1) for more details about these commands.

Measure range commands

Command	Description
<code>smua.measure.autorangei = smua.AUTORANGE_ON</code>	Enable current measure autorange.
<code>smua.measure.autorangei = smua.AUTORANGE_OFF</code>	Disable current measure autorange.
<code>smua.measure.autorangev = smua.AUTORANGE_ON</code>	Enable voltage measure autorange.
<code>smua.measure.autorangev = smua.AUTORANGE_OFF</code>	Disable voltage measure autorange.
<code>smua.measure.lowrangei = lowrange</code>	Set lowest I measure range for autorange.
<code>smua.measure.lowrangev = lowrange</code>	Set lowest V measure range for autorange.
<code>smua.measure.rangei = rangeval</code>	Select manual current measure range.
<code>smua.measure.rangev = rangeval</code>	Select manual voltage measure range.

Source range and limit commands

Command	Description
<code>smua.source.autorangei = smua.AUTORANGE_ON</code>	Enable current source autorange.
<code>smua.source.autorangei = smua.AUTORANGE_OFF</code>	Disable current source autorange.
<code>smua.source.autorangev = smua.AUTORANGE_ON</code>	Enable voltage source autorange.
<code>smua.source.autorangev = smua.AUTORANGE_OFF</code>	Disable voltage source autorange.
<code>smua.source.limiti = level</code>	Set voltage source current limit (compliance).
<code>smua.source.limitv = level</code>	Set current source voltage limit (compliance).
<code>smua.source.limitp = level</code>	Set source power limit (compliance).
<code>smua.source.lowrangei = lowrange</code>	Set lowest I source range for autorange.
<code>smua.source.lowrangev = lowrange</code>	Set lowest V source range for autorange.
<code>smua.source.rangei = rangeval</code>	Select manual current source range.
<code>smua.source.rangev = rangeval</code>	Select manual voltage source range.

Pulser range commands

Command	Description
<code>smua.pulser.rangei = rangeval</code>	Sets the source and measure current ranges.
<code>smua.pulser.rangev = rangeval</code>	Sets the voltage measure range.

Range programming example

The SMU programming example below illustrates how to control both source and measure ranges. The 2601B-PULSE is set up as follows:

- Voltage source range: Auto
- Current measure range: 10 mA
- Voltage source current limit: 10 mA

```
-- Restore 2601B-PULSE defaults. This disables the pulser.
smua.reset()
-- Set V source range to auto.
smua.source.autorangev = smua.AUTORANGE_ON
-- Select 10 mA measure range.
smua.measure.rangei = 10e-3
-- Set limit level to 10 mA.
smua.source.limiti = 10e-3
```

Digits

The display resolution of the measured reading depends on the DIGITS setting. The default display resolution setting is 6.5 digits. The DIGITS setting selects display resolution for all measurement functions.

The DIGITS setting has no effect on the format of readings returned by a `print()` command over a remote interface. For information to adjust the format of remote interface readings, see [format.asciiprecision](#) (on page 11-89).

The number of displayed digits does not affect accuracy or speed. Accuracy and speed are controlled by the SPEED setting (see [Speed](#) (on page 4-60)).

Setting display resolution from the front panel

To set the display resolution, press the **DIGITS** key until the correct number of digits is displayed. Available display resolutions are 4.5, 5.5, and 6.5 digits.

Setting display resolution from a remote interface

Digits commands

The following table summarizes use of the `display.smua.digits` command. See the [TSP command reference](#) (on page 11-1) for more information.

Digits commands

Command	Description
<code>display.smua.digits = display.DIGITS_4_5</code>	Set display to 4.5 digits.
<code>display.smua.digits = display.DIGITS_5_5</code>	Set display to 5.5 digits.
<code>display.smua.digits = display.DIGITS_6_5</code>	Set display to 6.5 digits.

Digits programming example

```
-- Select 5.5 digits.  
display.smua.digits = display.DIGITS_5_5
```

Speed when the pulser is disabled

The SPEED key sets the integration time, or measurement aperture, of the A/D converter (period the input signal is measured). The integration time affects the usable digits, the amount of reading noise, and the reading rate of the instrument. The integration time is specified in parameters based on the number of power line cycles (NPLC), where 1 PLC for 60 Hz is 16.67 ms (1/60) and 1 PLC for 50 Hz is 20 ms (1/50).

In general, the fastest integration time (0.001 PLC) results in the fastest reading rate, but also causes increased reading noise and fewer usable digits. The slowest integration time (25 PLC) provides the best common-mode and normal-mode noise rejection, but has the slowest reading rate. Settings between the fastest and slowest integration times are a compromise between speed and noise. The default power-on speed setting is NORMAL (1 PLC).

Setting speed

Speed is set from the SPEED configuration menu and is structured as follows.

Front-panel speed configuration

Press the **SPEED** key (or use the CONFIG menu) to display the following menu items:

- **FAST:** Sets the measurement speed to 0.01 PLC (fast performance, but accuracy is reduced)
- **MED:** Sets the measurement speed to 0.10 PLC (speed and accuracy are balanced)
- **NORMAL:** Sets the measurement speed to 1.00 PLC (speed and accuracy are balanced)
- **HI-ACCURACY:** Sets the measurement speed to 10.00 PLC (high accuracy, but speed is reduced)
- **OTHER:** Sets the measurement speed to any PLC value from 0.001 to 25

NOTE

The SPEED setting affects all measurement functions. After setting speed, display resolution can be changed using the DIGITS key.

Remote speed programming

Speed command

The following table shows the command that controls speed. See the [TSP command reference](#) (on page 11-1) for more information.

Speed command*

Command	Description
<code>nplcsmua.measure.nplc = nplc</code>	Sets the speed of the ADC (nplc = 0.001 to 25).

* The speed setting is global and affects all measurement functions.

Speed programming example

Use the NPLC command to set the speed of the integrating analog-to-digital converter (ADC). The programming example below illustrates how to set the speed to 10 PLC:

```
-- Set NPLC to 10.
smua.measure.nplc = 10
```

Sweep operation

The following topics describe how to use the 2601B-PULSE for sweeps.

The 2601B-PULSE can perform source-only sweeps, source-and-measure sweeps, or measure-only sweeps. The 2601B-PULSE SMU can generate both DC and pulsed sweeps. The 2601B-PULSE pulser can only generate pulsed sweeps.

The following topics describe the following types of sweeps:

- DC and pulsed linear staircase sweeps
- DC and pulsed logarithmic staircase sweeps
- DC and pulsed list sweeps

DC and pulsed linear staircase sweeps: With this type of sweep, the voltage or current increases or decreases in fixed steps, beginning with a start voltage or current and ending with a stop voltage or current. The figure below shows an increasing linear staircase sweep and a pulsed staircase sweep. Pulsed linear staircase sweeps function the same way that DC linear staircase sweeps function, except that pulsed linear staircase sweeps return to the idle level between pulses.

Figure 57: DC and pulsed linear staircase sweeps

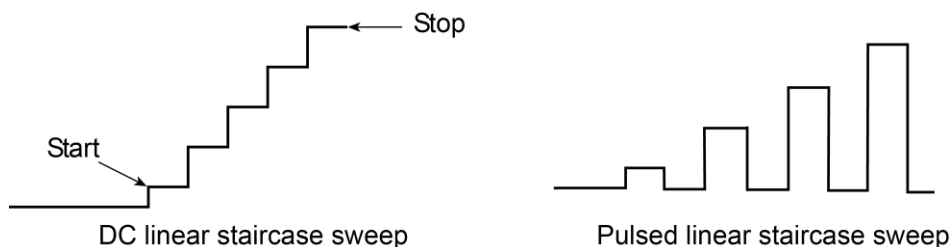

DC and pulsed logarithmic staircase sweeps: In this type of sweep, the current or voltage increases or decreases geometrically, beginning with a start voltage or current and ending with a stop voltage or current. The figure below shows an increasing logarithmic staircase sweep and a pulsed logarithmic staircase sweep. Pulsed logarithmic staircase sweeps function the same way that DC logarithmic staircase sweeps function, except that pulsed logarithmic staircase sweeps return to the idle level between pulses.

Figure 58: DC and pulsed logarithmic staircase sweeps

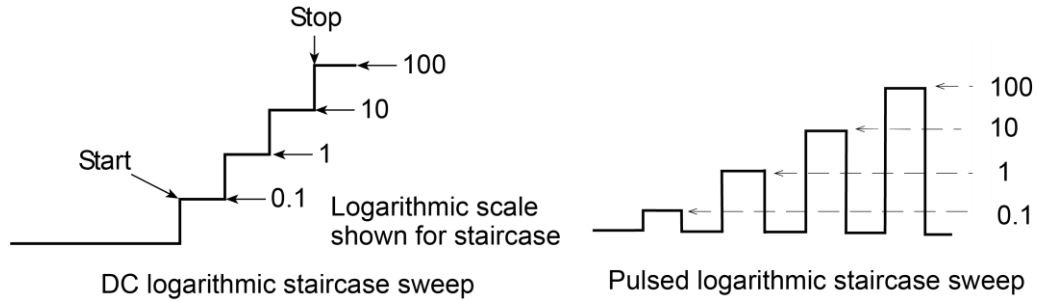

DC and pulsed list sweeps: The list sweep allows you to program arbitrary sweep steps anywhere within the output voltage or current range of the 2601B-PULSE. The following figure shows a list sweep with arbitrary steps and a pulsed list sweep. Pulsed list sweeps function the same way that DC list sweeps function, except that pulsed list sweeps return to the idle level between pulses.

Figure 59: DC and pulsed list sweeps

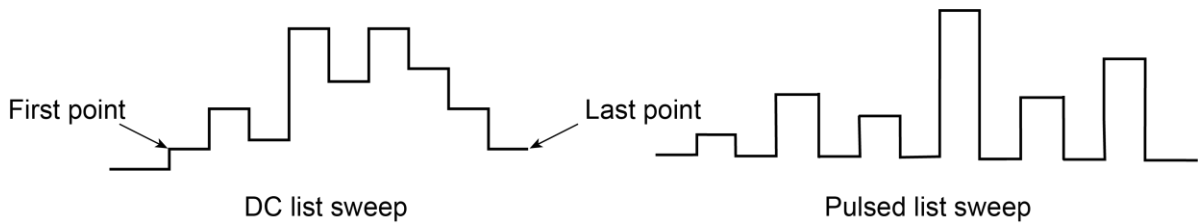

The 2601B-PULSE can generate DC and pulsed sweeps to perform source-only sweeps, source-and-measure sweeps, or measure-only sweeps. Three of the sweep types are described in the following: DC and pulsed linear staircase sweeps, DC and pulsed logarithmic staircase sweeps, and DC and pulsed list sweeps.

DC and pulsed linear staircase sweeps: With this type of sweep, the voltage or current increases or decreases in fixed steps, beginning with a start voltage or current and ending with a stop voltage or current. The figure below shows an increasing linear staircase sweep and a pulsed staircase sweep. Pulsed linear staircase sweeps function the same way that DC linear staircase sweeps function, except that pulsed linear staircase sweeps return to the idle level between pulses.

Figure 60: DC and pulsed linear staircase sweeps

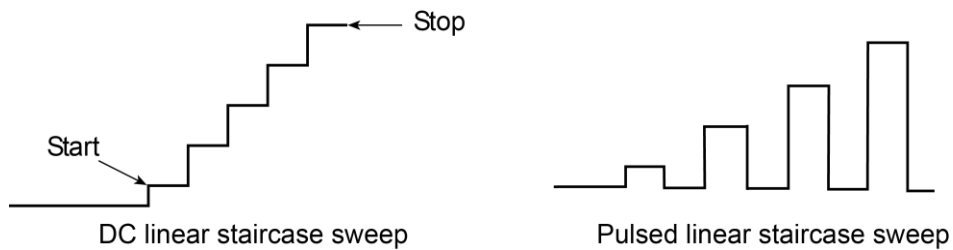

DC and pulsed logarithmic staircase sweeps: In this type of sweep, the current or voltage increases or decreases geometrically, beginning with a start voltage or current and ending with a stop voltage or current. The figure below shows an increasing logarithmic staircase sweep and a pulsed logarithmic staircase sweep. Pulsed logarithmic staircase sweeps function the same way that DC logarithmic staircase sweeps function, except that pulsed logarithmic staircase sweeps return to the idle level between pulses.

Figure 61: DC and pulsed logarithmic staircase sweeps

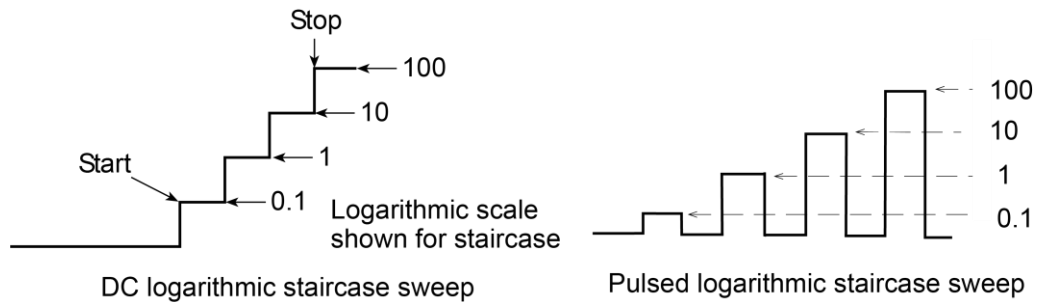

DC and pulsed list sweeps: The list sweep allows you to program arbitrary sweep steps anywhere within the output voltage or current range of the 2601B-PULSE. The following figure shows a list sweep with arbitrary steps and a pulsed list sweep. Pulsed list sweeps function the same way that DC list sweeps function, except that pulsed list sweeps return to the idle level between pulses.

Figure 62: DC and pulsed list sweeps

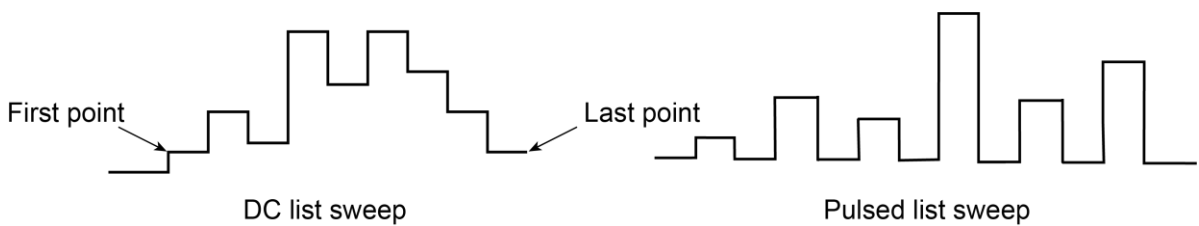

Linear staircase sweeps

As shown below, this sweep type steps from a start voltage or current value to an ending (stop) value. When enabled, a measurement is made at each point after the source and measurement settling time.

Figure 63: Linear staircase sweep

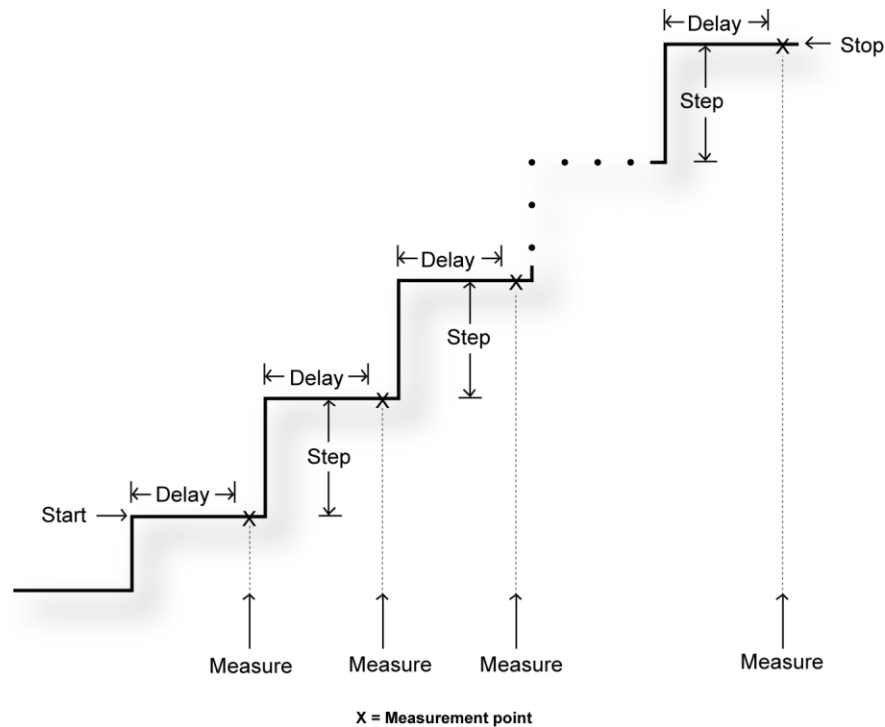

A linear staircase sweep is configured using a start level, a stop level, and the total number of points, including the start and stop points. The step size is determined by the start and stop levels, and the number of sweep points:

$$\text{step} = (\text{stop} - \text{start}) / (\text{points} - 1)$$

NOTE

The number of sweep steps actually performed is determined by the trigger count. Refer to [Triggering](#) (on page 6-1) for more information.

The sweep can be either positive-going or negative-going, depending on the relative values of the start and stop parameters. When the sweep starts, the output will go to the start source level. The output will then change in equal steps until the stop level is reached. If the trigger count is greater than the number of points specified, the SMU will start over at the beginning value.

To configure a linear staircase sweep, use `smua.trigger.source.linearY()`. This function configures the source values the SMU will output when performing a linear sweep. After configuring the sweep, you must also enable the source action by setting the following attribute:

```
smua.trigger.source.action
```

Example:

```
-- Configure a sweep from 0 to 10 V in 1 V steps.
smua.trigger.source.linearv(0, 10, 11)
-- Enable the source action.
smua.trigger.source.action = smua.ENABLE
```

For more information, see [smua.trigger.source.linearY\(\)](#) (on page 11-254).

Logarithmic staircase sweeps

This type of sweep is similar to the linear staircase sweep. The steps, however, are done on a logarithmic scale.

Like a linear staircase sweep, logarithmic sweeps are configured using a start level, a stop level, and the number of points. The step size is determined by the start and stop levels, and the number of sweep points. However, in a logarithmic sweep, the step size increases or decreases exponentially. To create an increasing logarithmic sweep, set the stop value to be greater than the start value. To create a decreasing logarithmic sweep, set the stop value to be less than the start value. When enabled, a measurement is made at each step after source and measurement settling time. An asymptote can also be used to control the inflection of a sweep.

NOTE

The number of sweep steps actually performed is determined by the trigger count. See [Triggering](#) (on page 6-1) for more information.

The formula for a logarithmic sweep is:

$$v_i = A + kb^i$$

Where:

- v_i = The source value at source point i
- i = The index of points in the sweep (ranges from 0 to $N-1$)
- N = The number of points in the sweep
- k = The initial source value as an offset from the asymptote
- b = The step size ratio
- A = The asymptote value

The asymptote is used to change the inflection of the sweep curve and allow it to sweep through zero. Both of the following figures depict the effect of the asymptote on the inflection of the sweep curve. The following two figures show sample sweeps.

Figure 64: Increasing logarithmic sweep

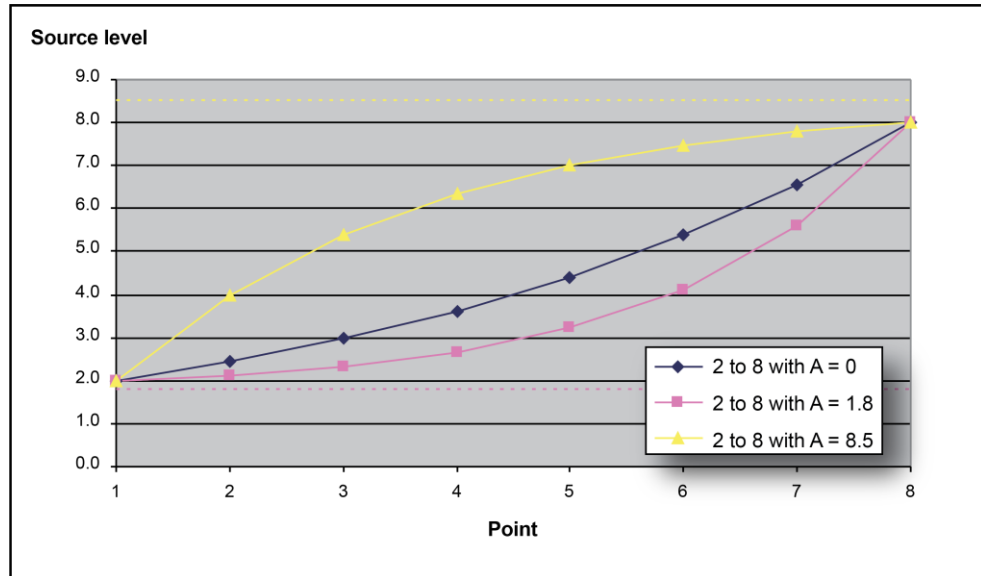
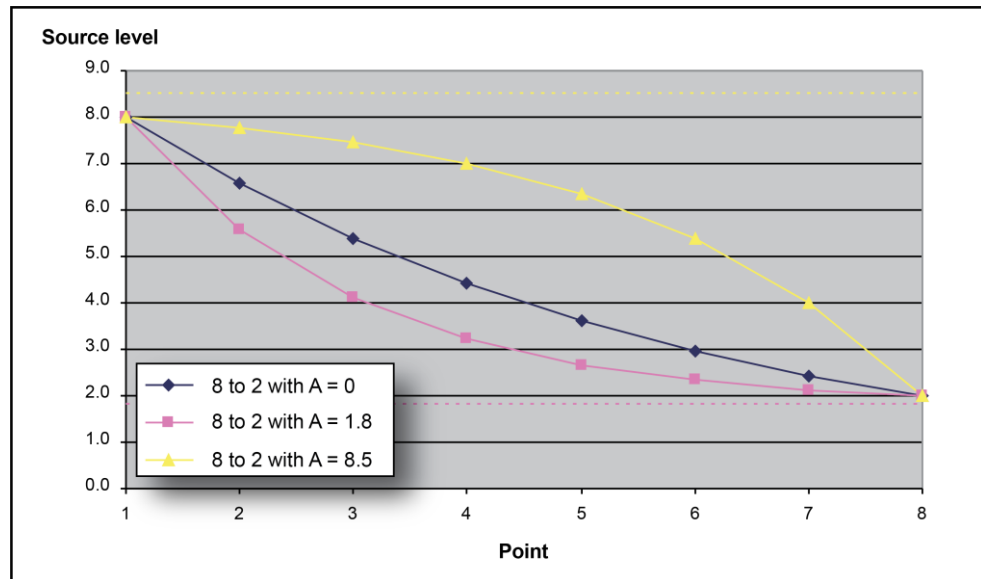

Figure 65: Decreasing logarithmic sweep



Solving for k and b provides the following formulas:

$$k = V_{\text{start}} - A$$

$$b = 10^{\left(\frac{\log_{10}(V_{\text{end}} - A) - \log_{10}(V_{\text{start}} - A)}{N - 1} \right)}$$

Where:

- V_{end} = The source value at the end point
- V_{start} = The source value at the start point
- N = The number of points in the sweep
- A = The asymptote value

NOTE

The number of points in a sweep is one greater than the number of steps in the sweep.

The following figure is an example of a five-point logarithmic sweep from 1 V to 10 V.

Figure 66: Logarithmic staircase sweep (1 V to 10 V, five steps)

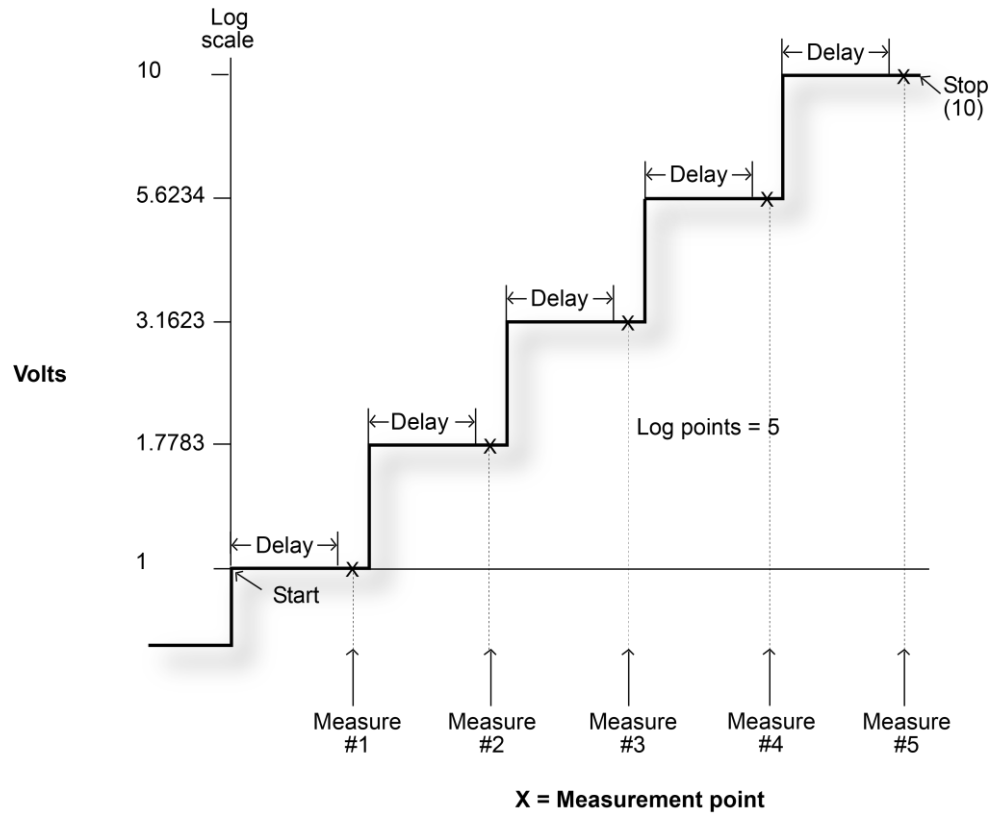

In this example:

$$A = 0, V_{\text{start}} = 1, V_{\text{end}} = 10, N = 5$$

Using the formula above, $k = 1$

Step size (b) for the sweep in the above figure is calculated as follows:

$$\begin{aligned} \text{Log step size} &= \frac{\log_{10}(\text{stop}) - \log_{10}(\text{start})}{\text{Points} - 1} \\ &= \frac{\log_{10}(10) - \log_{10}(1)}{5 - 1} \\ &= \frac{1 - 0}{4} \\ &= 0.25 \end{aligned}$$

$$\text{Therefore, } b = 10^{(\log \text{ step size})} = 1.7783$$

The log steps for this sweep are listed in the table below.

Logarithmic sweep points

Source point (<i>N</i>)	Source level (<i>V</i>)	Step number (<i>i</i>)
1	1	0
2	1.7783	1
3	3.1623	2
4	5.6234	3
5	10	4

When this sweep starts, the output will go to the start level (1 V) and sweep through the symmetrical log points.

To configure a logarithmic staircase sweep, use the `smua.trigger.source.logY()` function. This function configures the source values the source-measure unit (SMU) will output when performing a logarithmic sweep. After configuring the sweep, you must also enable the source action by setting the following attribute:

```
smua.trigger.source.action
```

Example:

```
-- Configure a sweep from 1 to 10 V in 10 steps with an asymptote of 0 V.
smua.trigger.source.logv(1, 10, 11, 0)
-- Enable the source action.
smua.trigger.source.action = smua.ENABLE
```

For more information, see [smua.trigger.source.logY\(\)](#) (on page 11-256).

List sweeps

Use a list sweep to configure a sweep with arbitrary steps. When enabled, a measurement is made at each point after source and measurement settling time.

To configure a list sweep, use the `smua.trigger.source.listY()` function. This function configures the source values that the source-measure unit (SMU) will output when performing a list sweep. After configuring the sweep, you must also enable the source action by setting the `smua.trigger.source.action` attribute.

Example:

```
-- Sweep through 3 V, 1 V, 4 V, 5 V, and 2 V.
smua.trigger.source.listv({3, 1, 4, 5, 2})
-- Enable the source action.
smua.trigger.source.action = smua.ENABLE
```

When the sweep is started, the output level goes to the first point in the sweep. The sweep will continue through the steps in the order that they were programmed.

The following figure shows a different example of a list sweep with six measurement points. When the sweep starts, the current or voltage goes to the first point in the sweep. The unit cycles through the sweep points in the programmed order.

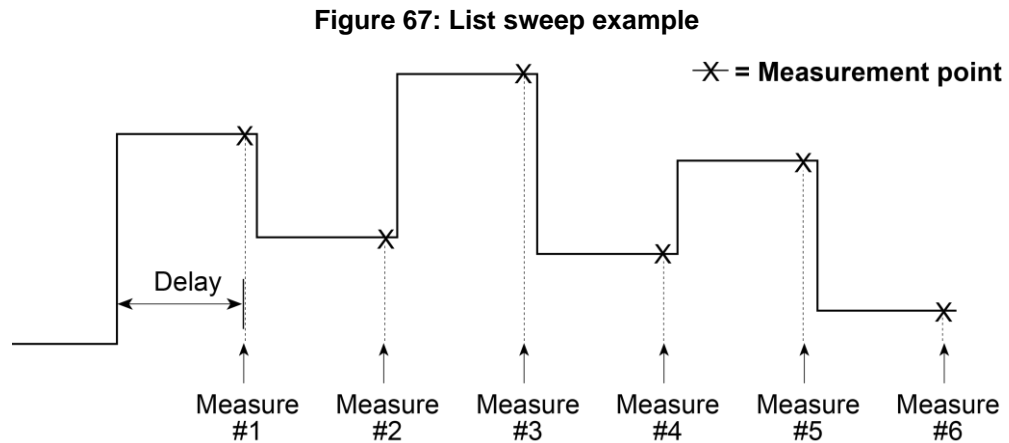

Pulse sweeps

NOTE

The pulse sweep described in the following is done with the pulser disabled. For information on pulse sweeps with the pulser enabled, see the examples in the [Pulser operation](#) (on page 4-33) section.

A pulse sweep can be created for any of the sweep types by configuring the end pulse action.

To configure a pulse sweep, send:

```
smua.trigger.endpulse.action = smua.SOURCE_IDLE
```

To configure a DC sweep, send:

```
smua.trigger.endpulse.action = smua.SOURCE_HOLD
```

Timers must be used to configure the pulse width and period. Refer to [Using timers to perform pulsed sweeps](#) (on page 6-15) for details.

The pulse width is managed by controlling the duration between the source stimulus event and the end pulse stimulus event. Note that a latency exists between these stimulus events and their resulting source level transitions. This trigger latency can vary based on factors such as the source range and the electrical characteristics of the device under test (DUT).

The figure below shows the source and end pulse stimulus events in relationship to the pulse (see [Triggering](#) (on page 6-1) for information on stimulus events). Any change in Δt will result in a corresponding change in the pulse width.

Figure 68: Pulse width control

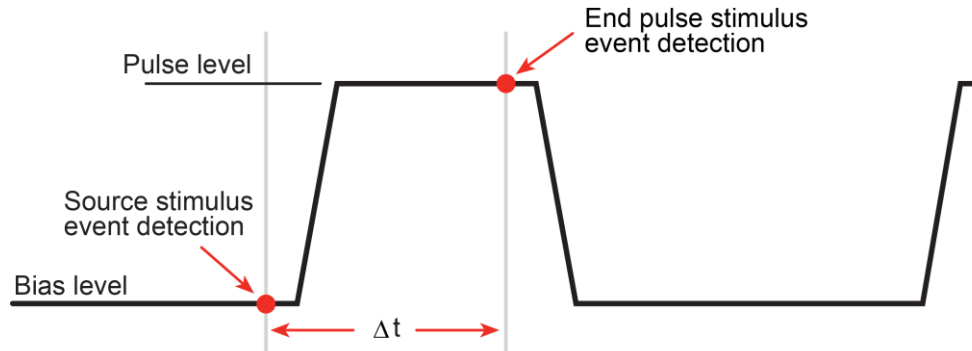

Pulse duty cycle

Duty cycle is the percentage of time during the pulse period that the output is on. It is calculated as follows:

$$\text{Duty cycle} = \text{Pulse width} / (\text{Pulse width} + \text{Off time})$$

For example, if the pulse width is 10 ms and the off time is 90 ms, the duty cycle is calculated as follows:

$$\begin{aligned} \text{Duty cycle} &= 10 \text{ ms} / (10 \text{ ms} + 90 \text{ ms}) \\ &= 10 \text{ ms} / 100 \text{ ms} \\ &= 0.10 \\ &= 10 \text{ percent} \end{aligned}$$

See [Maximum duty cycle equation](#) (on page 7-2) for additional information on calculating the maximum duty cycle for a SMU.

Pulsing in the extended operating area (EOA)

When the pulser is disabled, you can pulse in the extended operating area of the SMU.

Pulse sweeps can be performed outside of the standard operating area by setting the appropriate compliance level. Review the specifications for the 2601B-PULSE to determine the maximum current and voltage values available in pulse mode. When pulsing in the extended operating area (EOA), the source-measure unit (SMU) will force the pulse to end early if the pulse width exceeds the maximum value. It will also delay the next source action as necessary to stay within the duty cycle capabilities of the SMU. The following figure and table illustrate the pulse regions for a SMU when pulsing in the EOA. Refer to the 2601B-PULSE specifications on tek.com/keithley for the latest pulse width and duty cycle information.

Figure 69: Pulsing in the extended operating area (EOA)

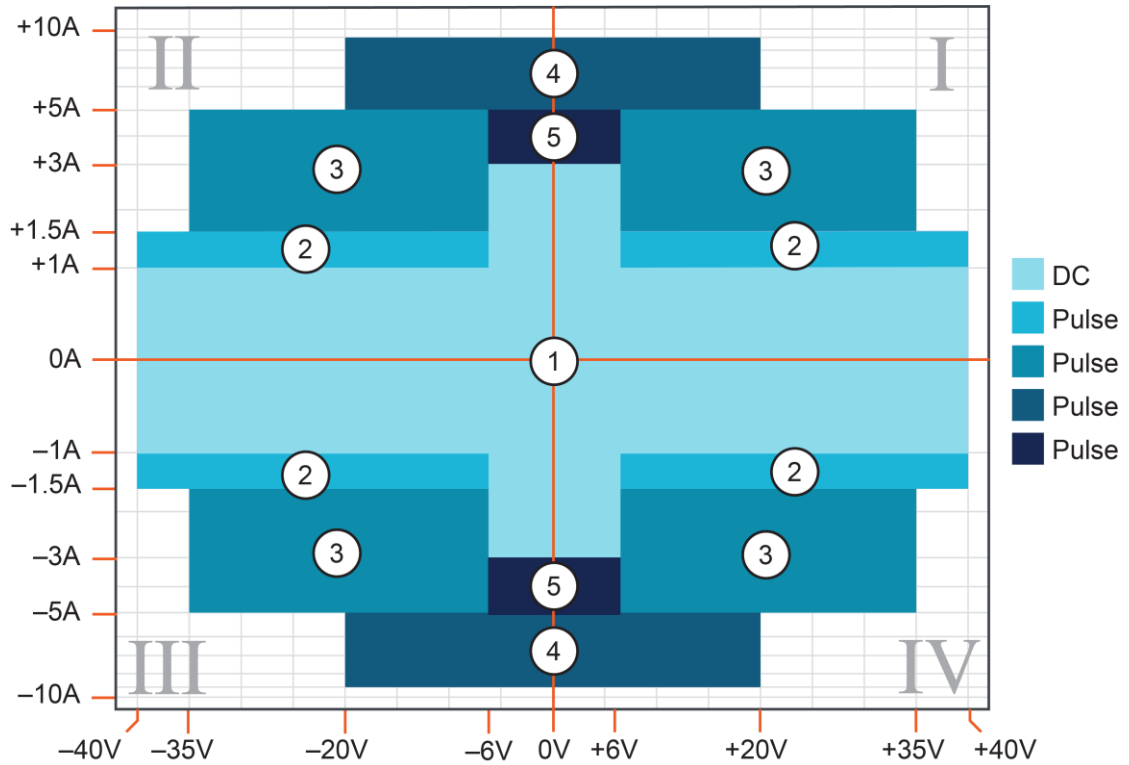

Pulse region specification

Region (quadrant diagram)	Region maximum	Maximum pulse width	Maximum duty cycle
1	1 A at 40 V	DC, no limit	100%
1	3 A at 6 V	DC, no limit	100%
2	1.5 A at 40 V	100 ms	25%
3	5 A at 35 V	4 ms	4%
4	10 A at 20 V	1.8 ms	1%
5	5 A at 6 V	10 ms	10%

Configuring and running sweeps

Use the following topics to configure and run a sweep.

Configuring compliance limits remotely

Voltage and current limits can be configured using the `smua.trigger.source.limitV` attribute, which sets the sweep source limits. For example, to set the SMU A sweep limit to 10 V, execute:

```
smua.trigger.source.limitV = 10
```

Configuring end sweep actions remotely

When the pulser is disabled, use the end sweep action to configure the source action at the end of the sweep. The source-measure unit (SMU) can be programmed to return to the idle source level or hold the last value of the sweep. Configure the end sweep action by setting the `smua.trigger.endsweep.action` attribute. For example, execute the following command to configure SMU A to return the source to the idle source level at the end of a sweep:

```
smua.trigger.endsweep.action = smua.SOURCE_IDLE
```



When the pulser is enabled, the instrument ignores the actual setting of `smua.trigger.endsweep.action` and behaves as if it is set to `smua.SOURCE_IDLE`.

Configuring measurements during a sweep

You can make measurements during a sweep using the `smua.trigger.measure.Y()` function. When sweeps are run, measurements are stored in the specified reading buffer for later recall. You can specify which reading buffer will store the readings. For example, to store the voltage readings made during the sweep, send the commands:

```
smua.trigger.measure.v(vbuffername)  
smua.trigger.measure.action = smua.ENABLE
```

To recall sweep data using the front panel:

1. Press the **RECALL** key.
2. Select **DATA** or **STATISTICS**.
3. If you selected **DATA**: Select the buffer, and then use the navigation wheel  or cursor keys to choose reading numbers to display .
4. If you selected **STATISTICS**: Select the buffer, and then use the navigation wheel  or cursor keys to choose **MEAN**, **STD DEV**, **SAMPLE SIZE**, **MINIMUM**, **MAXIMUM**, or **PK-PK**.

NOTE

Recalling readings from the reading buffer using the front panel can only be done if one of the dedicated reading buffers is used to store the sweep data.

To recall sweep data using remote commands:

- Use the `printbuffer()` function to request buffer readings.

See [Reading buffers](#) (on page 5-1) for details about recalling data from the buffer.

Source and measurement delays

NOTE

The source and measurement delays described here only apply when the pulser is disabled.

Whenever the source-measure unit (SMU) outputs a source value in a sweep, it also applies the programmed source delay. The default source delay is zero (0) seconds. Set an additional source delay using the `smua.source.delay` attribute.

Whenever the SMU makes a measurement in a sweep, it also applies any configured measurement delays. Use the `smua.measure.delay` attribute to program a specific measurement delay. The default measurement delay varies by measure range.

Initiating and running sweeps

To run a sweep, you must configure the number of sweep points to output and the number of sweeps to perform. See [Triggering](#) (on page 6-1) for more information.

Examples:

To start a sweep, use the `smua.trigger.initiate()` function. Sweeps are overlapped operations, so you can use the `waitcomplete()` function to suspend further operation until the sweep is complete.

To sweep 15 source points:

```
smua.trigger.count = 15
```

To perform eight sweeps:

```
smua.trigger.arm.count = 8
```

Aborting a sweep

You can use the `smua.abort()` function to terminate all overlapped operations on the 2601B-PULSE SMU or pulser, including sweeps. It returns the SMU or pulser to the idle state of the remote trigger model. See [Triggering](#) (on page 6-1) for more information.

Sweeping using factory scripts

Factory script functions that perform linear staircase, logarithmic staircase, and list sweeps are described in [Factory scripts](#) (on page 9-19). You can use the factory script functions to execute simple sweeps, or use them as examples for programming your own custom sweeps.

Front panel

To run a sweep from the front panel:

1. Press the **LOAD** key, and then select **FACTORY**.
2. Select the name of the test to run.
3. Press the **RUN** key, and then follow the display prompts to complete the test.

See [Factory scripts](#) (on page 9-19) for more information about using factory scripts.

Press the **RECALL** key to access sweep data stored in dedicated reading buffer 1. See [Reading buffers](#) (on page 5-1) for more details about the buffer.

Sweep programming examples

Procedures for programming and running a sweep are provided in the following topics. Each of these procedures includes commands for a typical sweep example. The following table summarizes parameters for each of these examples.

NOTE

You can retrieve the source code for the factory scripts by using the [scriptVar.list\(\)](#) (on page 11-164) or [scriptVar.source](#) (on page 11-167) commands.

Sweep example parameters

Sweep type	Parameters for sweep examples
Linear staircase sweep	Start current: 1 mA Stop current: 10 mA Settling time: 0.1 s Number of points: 10
List sweep	Points: 3 V, 1 V, 4 V, 5 V, 2 V Settling time 0.1 s Number of points: 5

Linear staircase sweep example

The SMU programming example below illustrates a staircase sweep.

```
-- Restore 2601B-PULSE defaults. This disables the pulser.
smua.reset()
-- Set compliance to 1 V.
smua.source.limitv = 1
-- Configure and execute the linear staircase sweep to
-- sweep current from 1 mA to 10 mA with a
-- 0.1 second settling time for 10 points.
SweepILinMeasureV(smua, 1e-3, 10e-3, 0.1, 10)
-- Request readings from buffer 1.
printbuffer(1, 10, smua.nvbuffer1.readings)
```

List sweep example

The SMU programming example below illustrates a list sweep.

```
-- Restore 2601B-PULSE defaults. This disables the pulser.
smua.reset()
-- Set compliance to 10 mA.
smua.source.limiti = 10e-3
-- Define voltage list.
vlist = {3, 1, 4, 5, 2}
-- Define list sweep with 3 V, 1 V, 4 V, 5 V, and 2 V steps
-- with a 0.1 s delay; 5 points.
SweepVListMeasureI(smua, vlist, 0.1, 5)
-- Request readings from buffer 1.
printbuffer(1, 5, smua.nvbuffer1.readings)
```

Relative offset

When making measurements, you may want to subtract an offset value from a measurement.

The relative offset feature subtracts a set value or a baseline reading from measurement readings. When you enable relative offset, all measurements are recorded as the difference between the actual measured value and the relative offset value. The formula to calculate the offset value is:

$$\text{Displayed value} = \text{Actual measured value} - \text{Relative offset value}$$

When a relative offset value is established for a measure function, the value is the same for all ranges for that measure function. For example, if 0.5 A is set as a relative offset value on the 1 A range, the relative offset value is also 0.5 A on the lower current ranges. Also, on the 1 A range, the 2601B-PULSE still overflows for a more than 1.02 A input.

When relative offset is enabled, the REL indicator turns on. Changing measurement functions changes the relative offset value to the established relative offset value and state for that measurement function.

Front panel relative offset



Enabling and disabling relative offset

The relative offset feature can be used to establish a zero (0) baseline. To enable and use this feature, press the **REL** key on the front panel. The reading (which becomes the relative offset value) is subtracted from itself, causing the meter to zero the display. The reading is then stored for use with subsequent measurements. Pressing the **REL** key a second time disables the relative offset.

Defining a relative offset value

A unique relative offset value can be established for the selected measurement function.

To establish a unique relative offset value from the front panel:

1. Press the **CONFIG** key and then the **REL** key.
2. Select the measurement function (**CURRENT**, **VOLTAGE**, **OHMS**, or **WATTS**), and then press **ENTER** or the navigation wheel . The present relative offset value is displayed.
3. Set the relative offset value.
4. With the relative offset value displayed, press the **ENTER** key or the navigation wheel , and then press the **EXIT (LOCAL)** key to back out of the menu structure.

Remote relative offset programming

Relative offset commands

Relative offset commands are summarized in the following table.

Relative offset commands

Command	Description
To set relative offset values:	
<code>smua.measure.rel.leveli = relval</code>	Set current relative offset value
<code>smua.measure.rel.levelp = relval</code>	Set power relative offset value
<code>smua.measure.rel.levelr = relval</code>	Set resistance relative offset value
<code>smua.measure.rel.levelv = relval</code>	Set voltage relative offset value
To enable/disable relative offset:	
<code>smua.measure.rel.enablei = smua.REL_OFF</code>	Disable current relative offset
<code>smua.measure.rel.enablep = smua.REL_OFF</code>	Disable power relative offset
<code>smua.measure.rel.enabler = smua.REL_OFF</code>	Disable resistance relative offset
<code>smua.measure.rel.enablev = smua.REL_OFF</code>	Disable voltage relative offset
<code>smua.measure.rel.enablei = smua.REL_ON</code>	Enable current relative offset
<code>smua.measure.rel.enablep = smua.REL_ON</code>	Enable power relative offset
<code>smua.measure.rel.enabler = smua.REL_ON</code>	Enable resistance relative offset
<code>smua.measure.rel.enablev = smua.REL_ON</code>	Enable voltage relative offset

Relative offset programming example

The programming example below performs a current measurement, uses it as the relative offset value, and enables current relative offset:

```
-- Measure and set present current value as the relative offset.
smua.measure.rel.leveli = smua.measure.i()
-- Enable current relative offset.
smua.measure.rel.enablei = smua.REL_ON
```

Filters

The filter feature lets you set the filter response to stabilize noisy measurements. The 2601B-PULSE uses a digital filter, which is based on reading conversions. The displayed, stored, or transmitted reading is calculated using one or more reading conversions (from 1 to 100).

Filter types

NOTE

If the pulser is enabled, the repeating filter is the only available filter.

The 2601B-PULSE provides two averaging filters and a median filter. The power-on default is the repeating filter.

The averaging filters are repeating and moving, as shown in the following figure. For the repeating filter, the stack (filter count) is filled, and the conversions are averaged to yield a reading. The stack is then cleared, and the process starts over.

Figure 70: Repeating and moving average filters

Repeating filter, readings = 10

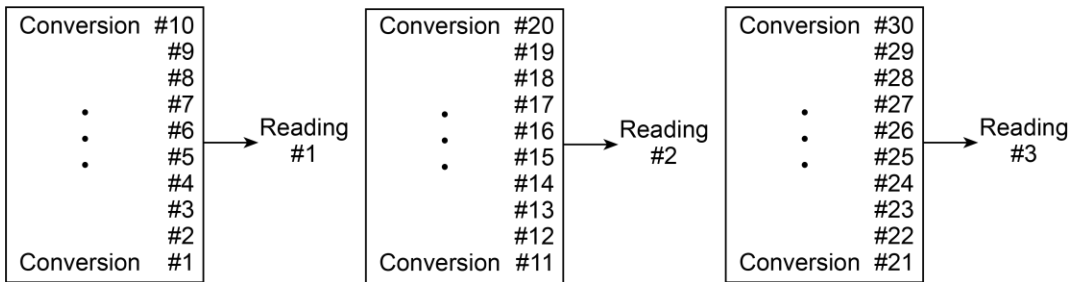

Moving filter, readings = 10

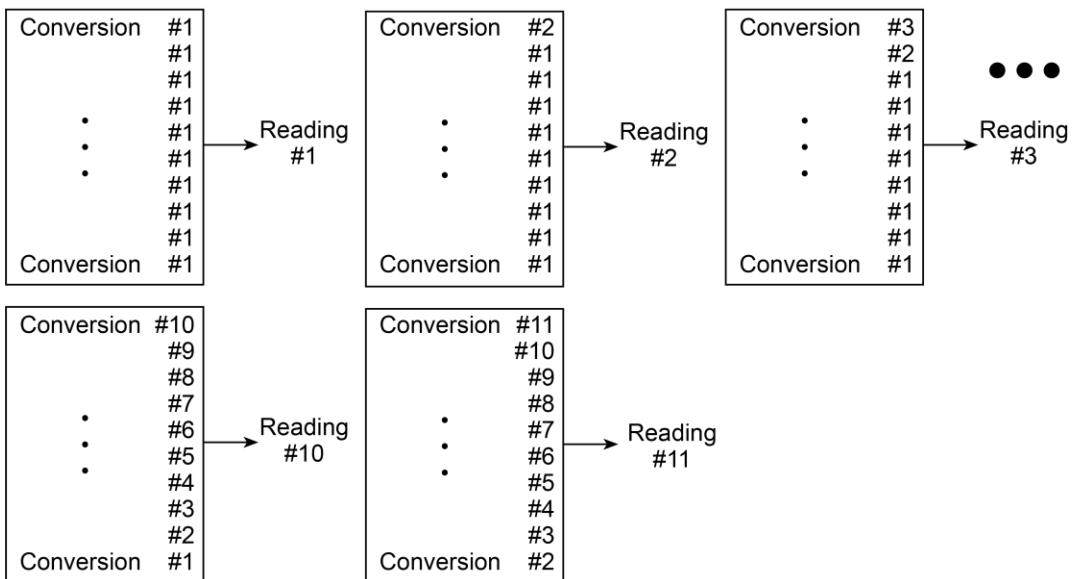

The moving filter uses a first-in, first-out stack. When the stack (filter count) becomes full, the measurement conversions are averaged, yielding a reading. For each subsequent conversion placed into the stack, the oldest conversion is discarded. The stack is averaged again, yielding a new reading.

The median filter is used to pass the reading that is nearest to the middle from a group of readings that are arranged according to size. The median filter uses a first-in, first-out stack similar to the moving filter. For each subsequent conversion placed into the stack, the oldest conversion is discarded. The median is then redetermined.

Figure 71: Median filter

Median filter, readings = 3

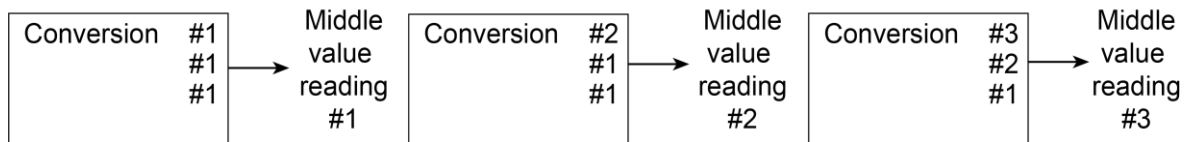

When a moving filter or a median filter is first enabled, the stack is empty. The first reading conversion is placed in the stack and is then copied to the other stack locations in order to fill it. Thus, the first filtered reading is the same as the first reading conversion. The normal moving filter process continues. Note that a true average or median reading is only yielded when the stack is filled with new reading conversions (no copies in the stack). For example, in the figure for the moving filter, it takes ten filtered readings to fill the stack with new reading conversions. The first nine filtered readings are calculated using copied reading conversions.

Response time

The filter parameters have speed and accuracy trade-offs for the time needed to display, store, or output a filtered reading. These affect the number of reading conversions for speed versus accuracy and response to input signal changes.

The filter type and count affect the overall reading speed. The moving average filter is much faster than the repeat average filter because the instrument does not have to refill the filter stack for each reading. Also, the number of readings averaged affects reading speed; as the number of readings averaged increases, the reading speed decreases.

Front panel filter control

Enabling the filter

The filter is enabled by pressing the **FILTER** key on the front panel. The **FILT** indicator is on while the filter is enabled. Pressing **FILTER** a second time disables filter.

Configuring the filter

Filter type and count are configured from the filter configuration menu on the front panel. The same filter configuration is used for all measurement functions.

To configure the filter:

1. Press the **CONFIG** key and then the **FILTER** key.
2. Select **TYPE**, and then select the filter type: **AVERAGE** or **MEDIAN**.
 - **AVERAGE**: Use this menu item to select an averaging filter, then select the averaging filter type: **MOVING** or **REPEAT**.
 - **MEDIAN**: Use this menu item to select a median filter. The **MOVING** filter type is the only option.
3. Select **COUNT**, and then specify the filter count (1 to 100 readings).

Remote filter programming

Filter commands

The following table summarizes the filter commands. See the [TSP command reference](#) (on page 11-1) for details about commands.

Filter commands

Command	Description
<code>smua.measure.filter.count = count</code>	Set filter count (1 to 100)
<code>smua.measure.filter.enable = smua.FILTER_ON</code>	Enable filter
<code>smua.measure.filter.enable = smua.FILTER_OFF</code>	Disable filter
<code>smua.measure.filter.type = smua.FILTER_MEDIAN</code>	Select median filter type
<code>smua.measure.filter.type = smua.FILTER_MOVING_AVG</code>	Select moving average filter type
<code>smua.measure.filter.type = smua.FILTER_REPEAT_AVG</code>	Select repeat average filter type

Filter programming example

The programming example below illustrates how to set the following filter options:

- **Filter type:** Moving average
- **Filter count:** 10
- **Filter state:** Enabled

```
-- Program count to 10.
smua.measure.filter.count = 10
-- Moving average filter type.
smua.measure.filter.type = smua.FILTER_MOVING_AVG
-- Enable filter.
smua.measure.filter.enable = smua.FILTER_ON
```

High-capacitance mode

The Keithley Instruments 2601B-PULSE has a high-capacitance mode.

Because the source-measure unit (SMU) can measure low current, issues can arise when driving a capacitive load. The pole formed by the load capacitance and the current range resistor can cause a phase shift in the SMU voltage control loop. This shift can lead to overshoot, ringing, and instability. Due to the large dynamic range of current measurement and wide range of internal resistors, the operating conditions for a given capacitive load can vary.

Based on the type, some test applications may require capacitors larger than 10 nF. While running test scripts, it may not be possible to disconnect the capacitor from the IC (integrated circuit) and extract accurate data. For this purpose, you can use the high-capacitance mode to minimize overshoot, ringing, and instability.

This section provides the details that you need to estimate performance based on load capacitance and measurement conditions.

NOTE

High-capacitance mode is not available when the pulser is enabled.

Understanding high-capacitance mode

The source-measure unit (SMU) in the 2601B-PULSE drives 10 nF of capacitance in normal operation. Typically, an internal capacitor across the current measuring element provides phase lead to compensate for the phase lag caused by the load capacitance on the output. This internal capacitance across the range resistance limits the speed for a specific measurement range.

The SMU in the 2601B-PULSE implements frequency compensation to achieve the highest throughput possible for a 10 nF or less load. In addition, you must consider the settling time, voltage range, measure delay, capacitor quality, the current measure range resistor, and the load resistor.

In normal operation, the SMU in the 2601B-PULSE can drive capacitive loads as large as 10 nF. In high-capacitance mode, the SMU can drive a maximum of 50 μ F of capacitance.

NOTE

When high-capacitance mode is enabled, a minimum load capacitance of 100 nF is recommended. In absence of this minimum load capacitance, overshoot and ringing may occur.

Highest throughput is achieved by using normal operation. In high-capacitance mode, the speed of the 2601B-PULSE SMU is reduced to compensate for the larger load capacitance. Stability is achieved by inserting an internal capacitance across the current measuring element of the SMU. This internal capacitor limits the speed for the source and measurement ranges. Therefore, when optimizing the speed of your test configuration in high-capacitance mode, you must consider the settling time, voltage, and current ranges, measure delay, quality of the load capacitor, and load resistance.

Understanding source settling times

Each 2601B-PULSE can drive up to 50 μF of a capacitance in high-capacitance mode. To accomplish this, the speed of the 2601B-PULSE SMU is reduced. Source settling times increase when high-capacitance mode is enabled. The following tables compare the source settling times in normal and high-capacitance modes.

Source settling times

Range	Normal mode	High capacitance mode ($C_{\text{LOAD}} = 4.7 \mu\text{F}$)
100 mV	< 50 μs	< 200 μs
1 V	< 50 μs	< 200 μs
6 V	< 110 μs	< 200 μs
40 V (Add 150 μs when measuring on the 1 A range)	< 150 μs	< 7000 μs

In high-capacitance mode, the frequency compensation capacitance across the measure range resistors increases. This increase leads to longer settling times on some current measure ranges. The same range elements that are used to measure current are used to source current. Therefore, the current limit response times will respond in a similar manner.

Current measure and source settling times

Current measure range	Normal mode (typical)	High capacitance mode (typical)
1 μA	< 2 ms	< 230 ms
10 μA	< 500 μs	< 230 ms
100 μA	< 150 μs	< 3 ms
1 mA	< 100 μs	< 3 ms
10 mA	80 μs ($R_{\text{LOAD}} > 6 \Omega$)	100 μs
100 mA	80 μs ($R_{\text{LOAD}} > 6 \Omega$)	100 μs
1 A	80 μs ($R_{\text{LOAD}} > 6 \Omega$)	120 μs ($R_{\text{LOAD}} > 2 \Omega$)
3 A	< 80 μs (current < 2.5 A, $R_{\text{LOAD}} > 2 \Omega$)	120 μs ($R_{\text{LOAD}} > 2 \Omega$)

When high-capacitance mode is enabled, the amount of time to change the current measure range increases for each SMU. The current measure range and the current limit range are locked together. Setting the current limit automatically updates the measure range.

Adjusting the voltage source

When driving large capacitive loads with high-capacitance mode enabled, the response time may be lengthened by the current limit. For example, see the table titled "Current measure and source settling times" in the [Understanding source settling times](#) (on page 4-81) topic. If a 1 μF capacitor charges to 10 V in 10 μs with a 1 A limit and the limit is set to 100 nA, the charging time will be 100 seconds (see the following equation).

$$i = C \frac{\Delta V}{\Delta t}$$

The total response times while in high-capacitance mode are a combination of the time spent charging the capacitor (current limit) or the response time, whichever is greater. There is a direct

relationship between the current limit and the charging time. As the current limit decreases, the amount of time required to charge the capacitor increases.

Understanding the capacitor

Based on the capacitor dielectric absorption, the settling time may change and the values in the "Current measure and source settling times" table in [Understanding source settling times](#) (on page 4-81) may differ.

NOTE

Tantalum or electrolytic capacitors are well known for long dielectric absorption settling times. Film capacitors and ceramics perform better, with NPO/COG dielectric ceramics yielding the best settling response.

Charging the capacitor and making readings

The following steps outline the procedure to charge and read a capacitor in high-capacitance mode:

1. Set the current limit to a value that is higher than will be used for the measurement (for example, if measuring at 10 μ A, the initial current limit can be set for 1 A).
2. After the capacitor charges, lower the current limit and measure range to obtain the current measurement.

Enabling high-capacitance mode

Before enabling high-capacitance mode, note the following:

- It is important to read [High-capacitance mode](#) (on page 4-80) to understand the impact of high-capacitance mode.
- Test the device under test (DUT) and the capacitor to determine the best current limit and range of output voltages.
- The settling times can vary based on the DUT. It is important to test the limits of the DUT before you use high-capacitance mode.
- Failure to test the DUT for the appropriate current limit and output voltages can result in damage to or destruction of the DUT.
- For optimal performance, do not continuously switch between normal mode and high-capacitance mode.
- Before you charge the capacitor, start with 0 (zero) voltage across the capacitor.

Front panel

To enable high-capacitance mode from the front panel:

1. Press the **CONFIG** key.
2. Press the **SRC** key and then select **HIGHC-MODE**.
3. Select **SRC-ENABLE** and then press the navigation wheel \odot (or the **ENTER** key).
4. Select **ENABLE** and then press the navigation wheel \odot (or the **ENTER** key).
5. Press the **EXIT (LOCAL)** key to back out of the menu structure.

Command interface

Turning on high-capacitance mode has the following effects on the SMU settings:

- `smua.measure.autorangei` is set to `smua.AUTORANGE_FOLLOW_LIMIT` and cannot be changed.
- Current ranges below 1 μA are not accessible.
- If `smua.source.limiti` is less than 1 μA , it is raised to 1 μA .
- If `smua.source.rangei` is less than 1 μA , it is raised to 1 μA .
- If `smua.source.lowrangei` is less than 1 μA , it is raised to 1 μA .
- If `smua.measure.lowrangei` is less than 1 μA , it is raised to 1 μA .

Measuring current

The following inputs are required to test leakage using the factory leakage script, as shown in the script example below.

- **SMU:** Sets the 2601B-PULSE source-measure unit to use
- **levelv:** Sets the output voltage level
- **limiti:** Sets the current limit for discharging or charging the capacitor
- **sourcedelay:** Solve the following equation to determine the amount of time before making a current reading:

$$i = C \frac{\Delta V}{\Delta t}$$

Where: i is the `limiti` setting (current limit)

- **measurei:** Sets the current measure range
- **measuredelay:** Defines the delay to wait after lowering the current limit before taking the measurement

Script example

Use the `smua.source.highc` attribute to set and control the options for high-capacitance mode.

The programming examples and figure below illustrate how to enable high-capacitance mode.

1. To enable high-capacitance mode, send:

```
-- Enables high-capacitance mode.
smua.source.highc = smua.ENABLE
```

2. To run the `i_leakage_measure()` function in the `KIHighC` factory script, send:

```
-- Charges the capacitor.
smua.source.levelv = 5
smua.source.output = smua.OUTPUT_ON
delay(1)
imeas = i_leakage_measure(smua, 0, 1, 300e-3, 10e-6, 100e-3)
-- The parameters in the i_leakage_measure() function represent
-- the following:
-- smu = smua
-- levelv = 0 V
-- limiti = 1 A
-- sourcedelay = 300 ms
-- measurei = 10 uA range
-- measuredelay = 100 ms
```

NOTE

Adjust the voltage level and source delays based on the value and type of capacitor along with the magnitude of the voltage step and the current measure range.

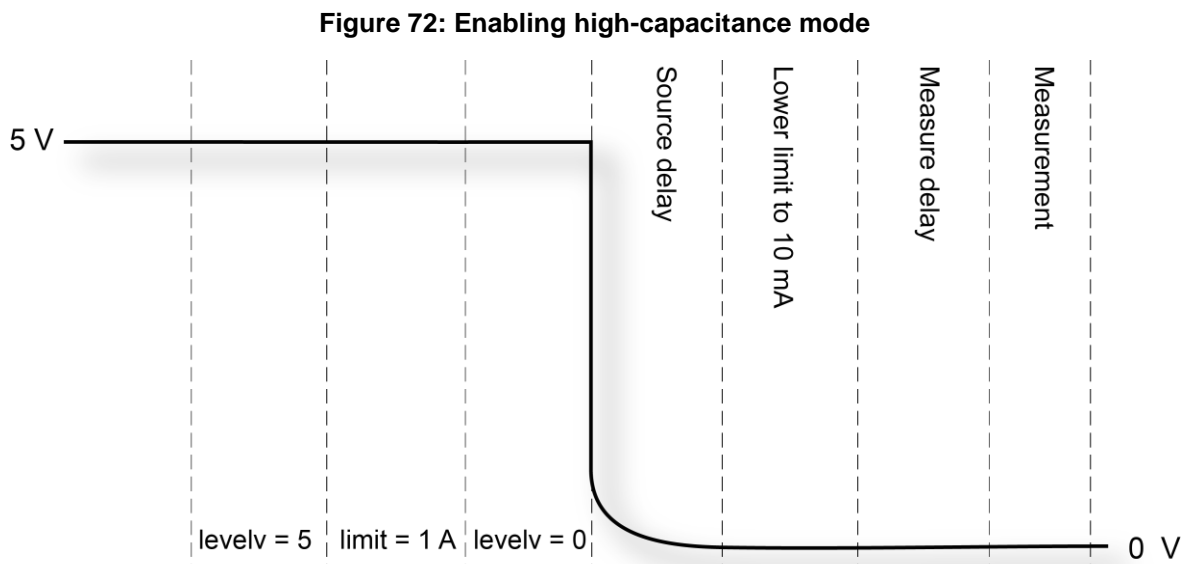

Reading buffers

In this section:

Overview	5-1
Front-panel reading buffer control	5-1
Remote reading buffer programming	5-6

Overview

Reading buffers capture measurements, ranges, instrument status, and output state of the Keithley Instruments 2601B-PULSE. The 2601B-PULSE has two default reading buffers. In addition to the default buffers, you can create user-defined reading buffers. You can use the reading buffers to acquire readings.

You can access reading buffers from the front panel or over the remote command interface.

The default reading buffers can store over 60,000 readings if you enable the options for timestamps and source values. To store over 140,000 readings internally, you can disable the timestamps and source values.

You can save reading buffers to internal nonvolatile memory in the instrument or to a USB flash drive.

Once you save the reading buffers to a USB flash drive, insert the USB flash drive into the USB port on your computer to view the data in any compatible data analysis application or to transfer the data from the USB flash drive to your computer.

Front-panel reading buffer control

The dedicated reading buffers can be configured, stored, and recalled when in local mode operation. Use the front panel to navigate and configure the reading buffers options and to save and recall stored readings.

Reading buffer options

The following listing outlines the menu structure and menu items associated with front panel reading buffer control. This section provides a description for each reading buffer option. Use the procedure in [Configuring reading buffers](#) (on page 5-2) as a guideline to configure these reading buffer options.

CHANA-BUFF: Configures Channel A buffer.

- DEST: Sets data storage destination (buffer 1, buffer 2, or none).

- **BUFFER1: Configure Buffer 1.**
 - **CLEAR:** Clear buffer (YES or NO).
 - **ELEMENTS:** Enable (ON) or disable (OFF) data storage elements.
 - **SRC-VAL:** Enable or disable source values.
 - **TSTAMP:** Enable or disable timestamps.
- **BUFFER2: Configure Buffer 2.**
 - **CLEAR:** Clear buffer (YES or NO).
 - **ELEMENTS:** Enable (ON) or disable (OFF) data storage elements.
 - **SRC-VAL:** Enable or disable source values.
 - **TSTAMP:** Enable or disable timestamps.

Configuring reading buffers

In the following example, enabling or disabling the source value or the timestamp is optional.

To configure reading buffers from the front panel:

1. Press the **CONFIG** key.
2. Press the **STORE** key.
3. Select **CHANA-BUFF**.
4. To select a storage destination, select the **DEST** option, and then choose one of the following:
 - **CHANA-BUFF1**
 - **CHANA-BUFF2**
 - **NONE**
5. Select **BUFFER1** or **BUFFER2**.
6. Clear the buffer by turning the navigation wheel  to select **CLEAR > YES**.

NOTE

You must clear the reading buffer before you can enable or disable the source value or the timestamp options.

7. Select **ELEMENTS**.
8. Configure the timestamp elements of the reading buffer:
 - a. Select **TSTAMP**.
 - b. Select **OFF** or **ON**.
9. Configure the source value elements of the reading buffer:
 - a. Select **SRC-VAL**.
 - b. Select **OFF** or **ON**.
10. Press the **EXIT (LOCAL)** key as needed to return to the main menu.

Appending or overwriting existing reading buffers

When storing data to a reading buffer that already holds data, the new data can be appended to the reading buffer data, or it can overwrite the old data.

To configure the instrument to append or overwrite measurements the next time data is acquired:

1. Press the **CONFIG** key.
2. Select **STORE**, and then select **STORAGE-MODE**. The Storage Mode menu is shown.
3. Select one of the following:
 - **APPEND**
 - **OVERWRITE**
4. Press the **EXIT (LOCAL)** key to return to the main menu.





Storage operation

Use this option to initiate a storage operation and to configure the number of readings to acquire during the storage operation. The reading count can be over 60,000 if timestamps and source values are enabled. The count can be over 140,000 if timestamps and source values are disabled.

NOTE

To store the maximum number of readings in a reading buffer, disable the source values and timestamps for that reading buffer.

To specify the number of readings and initiate the storing operation:

1. From the front panel, press the **STORE** key, and then select **TAKE_READINGS**.
2. Use the navigation wheel  to select the number of readings.
3. Push the navigation wheel  to switch to edit mode.
4. Turn the navigation wheel  to change the numeric value, and then push the navigation wheel  to save the numeric value.
5. Press the **ENTER** key to save the count.
6. Press the **OUTPUT ON/OFF** control to start taking readings.

NOTE

If the output-off mode is ZERO or the output is already on, the instrument starts acquiring readings when the ENTER key is pressed (see step 5 of the preceding procedure). Otherwise the instrument starts acquiring readings when the output is turned on (step 6).

Saving reading buffers

You can save the dedicated reading buffers to nonvolatile memory, or you can save them to a USB flash drive. Note that the instrument restores the dedicated reading buffers from internal nonvolatile memory when the unit is turned off and back on.

Saving the reading buffers to nonvolatile memory

After the measurements are complete, you can save the reading buffer data to the nonvolatile memory in the instrument.





To save the reading buffer data:

1. From the front panel, press the **STORE** key, and then select **SAVE**.
2. Select **INTERNAL** to save to internal nonvolatile memory.
3. Select one of the following:
 - **SMUA_BUFFER1**
 - **SMUA_BUFFER2**
4. The front panel displays *Saving...* This may take awhile.
5. Press the **EXIT (LOCAL)** key to return to the main menu.

Saving the reading buffer to a USB flash drive

After the measurements are complete, you can save the reading buffer data to a USB flash drive.

To save the reading buffer data to a USB flash drive:

1. Insert the USB flash drive into the USB port.
2. Press the **STORE** key and use the navigation wheel  to select **SAVE**.
3. Select **USB1**.
4. Select one of the following file formats:
 - **CSV**
 - **XML**
5. Use the navigation wheel  to select the reading buffer.
6. Use the navigation wheel  to change the file name.
7. Press the navigation wheel  or the **ENTER** key to save the file.
8. Press the **EXIT (LOCAL)** key to return to the main menu.

Recalling readings

To recall the data stored in a reading buffer:

1. Press the **RECALL** key.
2. Select **DATA** or **STATISTICS**.
3. Select the buffer to display **CHANA-BUFF1** or **CHANA-BUFF2**. The data or statistics are displayed.
 - If recalling data, the reading display is on the top left, and the buffer location number is on the right. The source values are on the lower left side of the display (if enabled); the timestamp (if used) is on the lower right side.
 - If recalling statistics, the information includes values for MEAN, STD DEV, SAMPLE SIZE, MINIMUM, MAXIMUM, and PK-PK.
 - The source display field identifies the buffer: SrcA1 (buffer 1) or SrcA2 (buffer 2).

Buffer location number





The buffer location number indicates the memory location of the source-measure reading. For example, location #000001 indicates that the displayed source-measure reading is stored at the first memory location.

Timestamp

If the timestamp is enabled, the first source-measure reading stored in the buffer (#0000001) is timestamped at 0.000 seconds. Subsequent readings are timestamped relative to when the first measurement was made. The interval between readings depends on the reading rate.

Displaying other buffer readings and statistics

To display other readings and statistics in the reading buffer:

1. While still in the buffer recall mode:
 - If viewing the data stored in the buffer, turn the navigation wheel  to increment and decrement the selected digit of the location number by one. Press the navigation wheel  and then turn it or use the **CURSOR** keys to move to the next digit that the navigation wheel  will change.
 - If viewing the statistics stored in the buffer, turn the navigation wheel  or use the **CURSOR** keys to scroll between MEAN, STD DEV, SAMPLE SIZE, MINIMUM, MAXIMUM, and PK-PK.
2. To exit from the reading buffer recall mode, press the **EXIT (LOCAL)** key.

Remote reading buffer programming

You can get readings by making overlapped or sequential measurements. Overlapped commands do not finish executing before the next command starts. Sequential commands complete execution before the next command starts executing.

The measured value is not the only component of a reading. The measurement status (for example, “In Compliance” or “Overranged”) is also an element of data associated with a particular reading.

All routines that return measurements can store the measurements in the reading buffers. Overlapped measurements always return readings in a reading buffer. Nonoverlapped measurement functions can return single-point measurement values or store multiple values in a reading buffer.

A reading buffer is based on a Lua table. The measurements are accessed by ordinary array accesses. If `rb` is a reading buffer, the first measurement is accessed as `rb[1]` and the ninth measurement as `rb[9]`. The additional information in the table is accessed as additional members of the table.

The load, save, and write operations for reading buffers function differently in the remote state. From a remote command interface, you can extract data from reading buffers as the instrument acquires the data.

Dedicated reading buffer designations

The 2601B-PULSE contains two dedicated reading buffers:

- `smua.nvbuffer1` (buffer 1)
- `smua.nvbuffer2` (buffer 2)

To access a reading buffer, include the name of the buffer in the command. For example, the following command stores readings into buffer 1:

```
smua.measure.overlappedi(smua.nvbuffer1)
```

Reading buffer commands

The following tables summarize commands associated with the reading buffers. See [TSP command reference](#) (on page 11-1) for detailed reading buffer command information.

Command	Description
Commands to save or clear readings:	
<code>smua.savebuffer(smua.nvbufferY)</code>	Saves the reading buffer to the nonvolatile memory on the 2601B-PULSE.
<code>smua.nvbuffer1.clear()</code>	Clears buffer 1.
<code>smua.nvbuffer2.clear()</code>	Clears buffer 2.
<code>mybuffer = smua.makebuffer(n)</code>	Creates a dynamically allocated buffer for <i>n</i> readings.
<code>mybuffer = nil</code>	Deletes the dynamically allocated buffer.
<code>savebuffer(smua.nvbuffer1,"csv", "/usb1/mybuffer.csv")</code>	Saves the reading buffer to the USB flash drive.

Commands to store readings	
<code>smua.measure.count = count</code>	The number of measurements to acquire.
<code>smua.measure.overlappedi (rbuffer)</code>	Makes current measurements; stores readings in <i>rbuffer</i> .
<code>smua.measure.overlappediv (ibuffer, vbuffer)</code>	Makes both current and voltage measurements; stores current readings in <i>ibuffer</i> and stores voltage readings in <i>vbuffer</i> .
<code>smua.measure.overlappedp (rbuffer)</code>	Makes power measurements; stores readings in <i>rbuffer</i> .
<code>smua.measure.overlappedr (rbuffer)</code>	Makes resistance measurements; stores readings in <i>rbuffer</i> .
<code>smua.measure.overlappedv (rbuffer)</code>	Makes voltage measurements; stores readings in <i>rbuffer</i> .
<code>smua.measure.v (rbuffer)</code>	Makes voltage measurements; stores readings in <i>rbuffer</i> .
<code>smua.measure.i (rbuffer)</code>	Makes current measurements; stores readings in <i>rbuffer</i> .
<code>smua.measure.iv (ibuffer, vbuffer)</code>	Makes both current and voltage measurements; stores current readings in <i>ibuffer</i> and stores voltage readings in <i>vbuffer</i> .
<code>smua.measure.r (rbuffer)</code>	Makes resistance measurements; stores readings in <i>rbuffer</i> .
<code>smua.measure.p (rbuffer)</code>	Makes power measurements; stores readings in <i>rbuffer</i> .
<code>smua.trigger.measure.v (rbuffer)</code>	Configures voltage measurements to be made during a sweep, including where readings are stored (<i>rbuffer</i>).
<code>smua.trigger.measure.i (rbuffer)</code>	Configures current measurements to be made during a sweep, including where readings are stored (<i>rbuffer</i>).
<code>smua.trigger.measure.r (rbuffer)</code>	Configures resistance measurements to be made during a sweep, including where readings are stored (<i>rbuffer</i>).
<code>smua.trigger.measure.p (rbuffer)</code>	Configures power measurements to be made during a sweep, including where readings are stored (<i>rbuffer</i>).
<code>smua.trigger.measure.iv (ibuffer, vbuffer)</code>	Configures both current and voltage measurements to be made during a sweep, including where readings are stored; current readings are stored in <i>ibuffer</i> and voltage readings are stored in <i>vbuffer</i> .
Commands to access readings:	
<code>printbuffer(start_index, end_index, st_1, st_2, ... st_n)</code>	Prints data from buffer subtables: <i>start_index</i> (starting index of values to print). <i>end_index</i> (ending index of values to print). <i>st_1, st_2, ... st_n</i> (subtables from which to print, each separated by a comma).

Buffer storage control attributes

The following table contains buffer storage control attributes.

NOTE

Before changing the `collectsourcevalues`, `collecttimestamps`, or `timestampresolution` attributes, you must clear the buffer using the `smua.nvbuffer1.clear()` or `smua.nvbuffer2.clear()` command.

Buffer storage control attributes

Storage attribute	Description
<code>appendmode</code>	The append mode is either off or on. When the append mode is off, a new measurement to this buffer overwrites the previous contents. When the append mode is on, the first new measurement is stored at the end of the existing data. This attribute is off when the buffer is created.
<code>cachemode</code>	When this attribute is on, the reading buffer cache improves access speed to reading buffer data. When running successive operations that overwrite reading buffer data without running any commands that automatically invalidate the cache, the reading buffer may return stale cache data. This attribute is initialized to on when the buffer is created.
<code>collectsourcevalues</code>	When this attribute is on, source values are stored with readings in the buffer. This value, off or on, can be changed only when the buffer is empty. When the buffer is created, this attribute is initialized to off.
<code>collecttimestamps</code>	When this attribute is on, timestamps are stored with readings in the buffer. This value, off or on, can be changed only when the buffer is empty. When the buffer is created, this attribute is initialized to off.
<code>fillcount</code>	The reading buffer fill count sets the number of readings to store before restarting at index 1. If the value is 0, then the capacity of the buffer is used. This attribute is only used when the <code>fillmode</code> attribute is set to <code>FILL_WINDOW</code> .
<code>fillmode</code>	The reading buffer fill mode controls how new data is added to the reading buffer. When this attribute is set to <code>FILL_ONCE</code> , the reading buffer does not overwrite readings. If the buffer fills up, new readings are discarded. When this attribute is set to <code>FILL_WINDOW</code> , new readings are added after existing data until the buffer holds <code>fillcount</code> elements. Once there are <code>fillcount</code> elements, new data starts overwriting data starting at index 1.
<code>timestampresolution</code>	The timestamp resolution, in seconds. When the buffer is created, its initial resolution is 0.000001 seconds. At this resolution, the reading buffer can store unique timestamps for up to 71 minutes. You can increase this value for long tests.

Buffer read-only attributes

The following table contains buffer read-only attributes.

Buffer read-only attributes: Read-only attributes used to access buffer parameters

Storage attribute	Description
basetimestamp	The timestamp of when the reading at <code>rb[1]</code> was stored, in seconds from midnight January 1, 1970 GMT. See Time and date values (on page 11-2) for additional details.
capacity	The total number of readings that can be stored in the reading buffer.
n	The number of readings in the reading buffer.
next	This attribute indicates where the next element that is added to the reading buffer is stored.

Buffer storage control programming examples

The programming examples below illustrate the use of buffer storage control attributes.

Buffer control programming examples

Command	Description
<code>smua.nvbuffer1.collectsourcevalues = 1</code>	Enable source value storage.
<code>smua.nvbuffer1.appendmode = 1</code>	Enable buffer append mode.
<code>smua.nvbuffer1.collecttimestamps = 0</code>	Disable timestamp storage.
<code>smua.nvbuffer1.timestampresolution = 0.001</code>	Set timestamp resolution to 0.001024 s.
<code>smua.nvbuffer1.fillcount = 50</code>	Set 50 as the number of readings the buffer stores before restarting at index 1.
<code>smua.nvbuffer1.fillmode = 0</code>	Set the reading buffer to fill once (do not overwrite old data).

Buffer read-only attribute programming examples

The follow programming examples illustrate use of buffer read-only attributes.

Buffer read-only attribute programming examples:

Command	Description
<code>number = smua.nvbuffer1.n</code>	Request the number of readings in the buffer.
<code>buffer_size = smua.nvbuffer1.capacity</code>	Request buffer size.

Statistic attributes

Use the `smua.buffer.getstats()` function to access the reading buffer data statistics. The table below displays the attributes that you can use to access the reading buffer statistics.

The returned parameter has the attributes described in the following table.

Attributes for accessing reading buffer data

Attribute	When returned	Description
<code>n</code>	Always	The number of data points on which the statistics are based.
<code>mean</code>	When <code>n > 0</code>	The average of all readings added to the buffer.
<code>stddev</code>	When <code>n > 1</code>	The standard deviation of all readings added to the buffer.
<code>min</code>	When <code>n > 0</code>	A table that contains data about the minimum reading value added to the buffer.
<code>max</code>	When <code>n > 0</code>	A table that contains data about the maximum reading value added to the buffer.

If `n` equals zero (0), all other attributes is `nil` because there is no data to base any statistics on. If `n` equals 1, the `stddev` attribute is `nil` because the standard deviation of a sample size of 1 is undefined.

The `min` and `max` entries have the attributes described in the following table. `bufferVar` is the name of the buffer. See [smua.buffer.getstats\(\)](#) (on page 11-177) for additional information.

Min and max entry attributes

Attribute	Description
<code>measurefunction</code>	String indicating the function measured for the reading (current, voltage, ohms, or watts).
<code>measurerange</code>	The full-scale range value for the measure range used when the measurement was made.
<code>reading</code>	The reading value.
<code>sourcefunction</code>	String indicating the source function at the time of the measurement (current or voltage).
<code>sourceoutputstate</code>	String indicating the state of the source (off or on).
<code>sourcerange</code>	Full-scale range value for the source range used when the measurement was made.
<code>sourcevalue</code>	If <code>bufferVar.collectsourcevalues</code> is enabled, the sourced value in effect at the time of the reading.
<code>status</code>	Status value for the reading; the status value is a floating-point number that encodes the status value into a floating-point value.
<code>timestamp</code>	If <code>bufferVar.collecttimestamps</code> is enabled, the timestamp, in seconds, between when the reading was acquired and when the first reading in the buffer was acquired; adding this value to the base timestamp gives the actual time when the measurement was acquired.

Example:

The following programming example illustrates how to output mean and standard deviation statistics from buffer 1:

```
statistics = smua.buffer.getstats(smua.nvbuffer1)
print(statistics.mean, statistics.stddev)
```

Reading buffer attributes

Use the reading buffer attributes to access the reading buffer data. The table below displays the attributes that you can use to access the reading buffer data.

Recall attributes

Recall attribute*	Description
measurefunctions	An array (a Lua table) of strings indicating the function measured for the reading (current, voltage, ohms, or watts).
measureranges	An array (a Lua table) of full-scale range values for the measure range used when the measurement was made.
readings	An array (a Lua table) of the readings stored in the reading buffer. This array holds the same data that is returned when the reading buffer is accessed directly; that is, <code>rb[2]</code> and <code>rb.readings[2]</code> access the same value.
sourcefunctions	An array (a Lua table) of strings indicating the source function at the time of the measurement (current or voltage).
sourceoutputstates	An array (a Lua table) of strings indicating the state of the source (off or on).
sourceranges	An array (a Lua table) of full-scale range values for the source range used when the measurement was made.
sourcevalues	If enabled, an array (a Lua table) of the sourced values in effect at the time of the reading.
statuses	An array (a Lua table) of status values for all the readings in the buffer. The status values are floating-point numbers that encode the status value into a floating-point value. See Buffer status (on page 5-12).
timestamps	If enabled, an array (a Lua table) of timestamps, in seconds, of when each reading occurred. These are relative to the <code>basetimestamp</code> for the buffer. See Reading buffer commands (on page 5-6).

* The default attribute is `readings`, which can be omitted.

Examples:

The following programming example illustrates how to output 100 readings from buffer 1:

```
printbuffer(1, 100, smua.nvbuffer1.readings)
```

The default reading attribute is `readings` and can be omitted. Thus, the following would also output 100 readings from buffer 1:

```
printbuffer(1, 100, smua.nvbuffer1)
```

Similarly, the following outputs 100 corresponding source values from buffer 1:

```
printbuffer(1, 100, smua.nvbuffer1.sourcevalues)
```

Buffer status

The buffer reading status attribute includes the status information as a numeric value; see the following table for values. For example, to access status information for the second element of SMU buffer 1, use the following command:

```
stat_info = smua.nvbuffer1.statuses[2]
```

Buffer status bits

Bit	Name	Hex value	Description
B0	Pulser	0x01	The pulser was enabled
B1	Overtemp	0x02	Over temperature condition
B2	AutoRangeMeas	0x04	Measure range was autoranged
B3	AutoRangeSrc	0x08	Source range was autoranged
B4	4Wire	0x10	4-wire (remote) sense mode enabled
B5	Rel	0x20	Rel applied to reading
B6	Compliance	0x40	Source function in compliance
B7	Filtered	0x80	Reading was filtered

Dynamic reading buffers

Reading buffers can also be allocated dynamically. Dynamic reading buffers are created and allocated with the `smua.makebuffer(n)` command, where *n* is the number of readings the buffer can store. For example, the following command allocates a reading buffer named `mybuffer` that can store 100 readings:

```
mybuffer = smua.makebuffer(100)
```

Allocated reading buffers can be deleted as follows:

```
mybuffer = nil
```

Dynamically allocated reading buffers can be used interchangeably with the `smua.nvbufferY` buffers that are described in [Dedicated reading buffer designations](#) (on page 5-6).

Buffer examples

Dedicated reading buffer example

The following programming example illustrates how to store data using dedicated reading buffer 1. In the example, the 2601B-PULSE loops for voltages from 0.01 V to 1 V with 0.01 V steps (essentially performing a staircase sweep), stores 100 current readings and source values in buffer 1, and then recalls all 100 readings and source values.

```

-- Restore 2601B-PULSE defaults.
smua.reset()
-- Select channel A display.
display.screen = display.SMUA
-- Display current.
display.smua.measure.func = display.MEASURE_DCAMPS
-- Select measure I autorange.
smua.measure.autorangei = smua.AUTORANGE_ON
-- Select ASCII data format.
format.data = format.ASCII
-- Clear buffer 1.
smua.nvbuffer1.clear()
-- Enable append buffer mode.
smua.nvbuffer1.appendmode = 1
-- Enable source value storage.
smua.nvbuffer1.collectsourcevalues = 1
-- Set count to 1.
smua.measure.count = 1
-- Select source voltage function.
smua.source.func = smua.OUTPUT_DCVOLTS
-- Set bias voltage to 0 V.
smua.source.levelv = 0.0
-- Turn on output.
smua.source.output = smua.OUTPUT_ON
-- Loop for voltages from 0.01 V to 1 V.
for v = 1, 100 do
  -- Set source voltage.
  smua.source.levelv = v * 0.01
  -- Measure current and store in nvbuffer1.
  smua.measure.i(smua.nvbuffer1)
end
-- Turn off output.
smua.source.output = smua.OUTPUT_OFF
-- Output readings 1 to 100.
printbuffer(1, smua.nvbuffer1.n, smua.nvbuffer1.readings)
-- Output source values 1 to 100.
printbuffer(1, smua.nvbuffer1.n, smua.nvbuffer1.sourcevalues)

```

Dual buffer example

The programming example below shows a script that stores current and voltage readings using buffer 1 for current and buffer 2 for voltage readings. The 2601B-PULSE stores 100 current and voltage readings and then recalls all 100 sets of readings.

```

-- Restore 2601B-PULSE defaults.
smua.reset()
-- Select measure I autorange.
smua.measure.autorangei = smua.AUTORANGE_ON
-- Select measure V autorange.
smua.measure.autorangev = smua.AUTORANGE_ON
-- Select ASCII data format.
format.data = format.ASCII
-- Clear buffer 1.
smua.nvbuffer1.clear()
-- Clear buffer 2.
smua.nvbuffer2.clear()

```

```

-- Set buffer count to 100.
smua.measure.count = 100
-- Set measure interval to 0.1 s.
smua.measure.interval = 0.1
-- Select source voltage function.
smua.source.func = smua.OUTPUT_DCVOLTS
-- Output 1 V.
smua.source.levelv = 1
-- Turn on output.
smua.source.output = smua.OUTPUT_ON
-- Store current readings in buffer 1, voltage readings in buffer 2.
smua.measure.overlappediv(smua.nvbuffer1, smua.nvbuffer2)
-- Wait for buffer to fill.
waitcomplete()
-- Turn off output.
smua.source.output = smua.OUTPUT_OFF
-- Output buffer 1 readings 1 to 100.
printbuffer(1, 100, smua.nvbuffer1)
-- Output buffer 2 readings 1 to 100.
printbuffer(1, 100, smua.nvbuffer2)

```

Dynamically allocated buffer example

The programming example below illustrates how to store data to an allocated buffer called `mybuffer`. The 2601B-PULSE stores 100 current readings in `mybuffer` and then recalls all the readings.

```

-- Restore 2601B-PULSE defaults.
smua.reset()
-- Select measure I autorange.
smua.measure.autorangei = smua.AUTORANGE_ON
-- Select measure V autorange.
smua.measure.autorangev = smua.AUTORANGE_ON
-- Select ASCII data format.
format.data = format.ASCII
-- Set buffer count to 100.
smua.measure.count = 100
-- Set measure interval to 0.1 s.
smua.measure.interval = 0.1
-- Select source voltage function.
smua.source.func = smua.OUTPUT_DCVOLTS
-- Output 1 V.
smua.source.levelv = 1
-- Turn on output.
smua.source.output = smua.OUTPUT_ON
-- Create a temporary reading buffer.
mybuffer = smua.makebuffer(smua.measure.count)
-- Store current readings in mybuffer.
smua.measure.overlappedi(mybuffer)
-- Wait for buffer to fill.
waitcomplete()
-- Turn off output.
smua.source.output = smua.OUTPUT_OFF
-- Output readings 1 to 100 from mybuffer.
printbuffer(1, 100, mybuffer)
-- Delete mybuffer.
mybuffer = nil

```

In this section:

Triggering.....	6-1
Remote triggering overview.....	6-1
SMU event detectors.....	6-8
Using trigger events to start actions on trigger objects.....	6-10
Digital I/O port and TSP-Link synchronization lines	6-11
Timers	6-13
Event blenders	6-19
LAN triggering overview	6-20
Command interface triggering	6-22
Trigger generator	6-23
Manual triggering	6-23
Interactive triggering.....	6-23
Hardware trigger modes.....	6-28
Understanding synchronous triggering modes	6-32
Digital I/O	6-36

Triggering

Triggering allows you to source signals and capture measurements when an input signal or combination of input signals meet a set of conditions that you set. Triggering controls the timing of when source and measure operations happen during a sweep. See [Sweep operation](#) (on page 4-61) for details on sweeping.

Remote triggering overview

There are two programming methods for triggering:

- Using the trigger model
- Interactive triggering

You can obtain very precise timing and synchronization between channels of multiple instruments using the trigger model to control the actions of the source-measure unit (SMU). To achieve such precise timing, use a static trigger configuration. When a static trigger configuration is not possible, you can use the interactive triggering method to control the timing and actions of the SMU.

Both programming methods use trigger objects. Trigger objects generate and monitor trigger events. External triggers are possible using digital I/O, TSP-Link® synchronization lines, LAN, command interface, and the manual trigger (the TRIG key).

The following figure graphically represents all the trigger objects of the 2601B-PULSE instrument.

Figure 73: Triggering overview

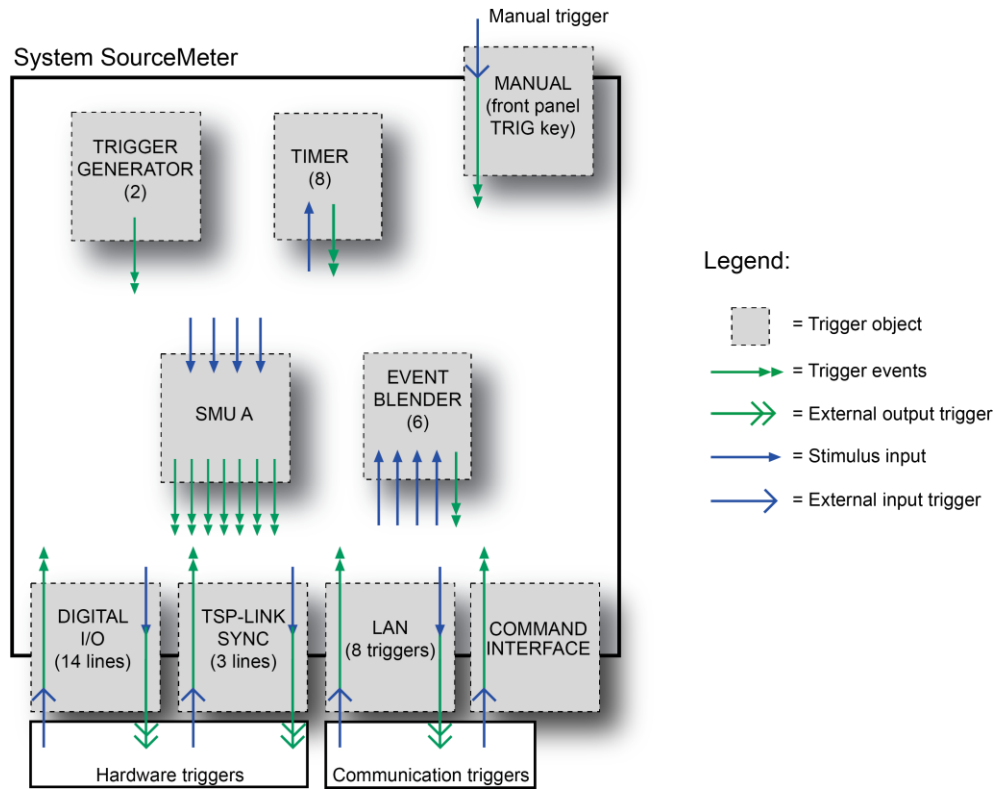

Trigger events are identified by means of an event ID. The following table describes the trigger event IDs.

Trigger event IDs*	
Event ID	Event description
smua.trigger.SWEEPING_EVENT_ID	Occurs when the source-measure unit (SMU) transitions from the idle state to the arm layer of the trigger model
smua.trigger.ARMED_EVENT_ID	Occurs when the SMU moves from the arm layer to the trigger layer of the trigger model
smua.trigger.SOURCE_COMPLETE_EVENT_ID	Occurs when the SMU completes a source action
smua.trigger.MEASURE_COMPLETE_EVENT_ID	Occurs when the SMU completes a measure action
smua.trigger.PULSE_COMPLETE_EVENT_ID	Occurs when the SMU completes a pulse
smua.trigger.SWEEP_COMPLETE_EVENT_ID	Occurs when the SMU completes a sweep
smua.trigger.IDLE_EVENT_ID	Occurs when the SMU returns to the idle state
digio.trigger[N].EVENT_ID	Occurs when an edge is detected on a digital I/O line
tsplink.trigger[N].EVENT_ID	Occurs when an edge is detected on a TSP-Link line
lan.trigger[N].EVENT_ID	Occurs when the appropriate LXI trigger packet is received on LAN trigger object <i>N</i>
display.trigger.EVENT_ID	Occurs when the TRIG key on the front panel is pressed

Trigger event IDs*	
Event ID	Event description
<code>trigger.EVENT_ID</code>	Occurs when a *TRG command is received on the remote interface GPIB only: Occurs when a GET bus command is received USB only: Occurs when a USBTMC TRIGGER message is received VXI-11 only: Occurs with the VXI-11 command <code>device_trigger</code> ; reference the VXI-11 standard for additional details on the device trigger operation
<code>trigger.blender[N].EVENT_ID</code>	Occurs after a collection of events is detected
<code>trigger.timer[N].EVENT_ID</code>	Occurs when a delay expires
<code>trigger.generator[N].EVENT_ID</code>	Occurs when the <code>trigger.generator[N].assert()</code> function is executed

* Use the name of the trigger event ID to set a stimulus value rather than the numeric value. Using the name makes the code compatible for future upgrades (for example, if the numeric values must change when enhancements are added to the instrument).

Using the trigger model

The source-measure unit (SMU) in the 2601B-PULSE has a remote trigger model that supports a wide range of triggering features for source sweeps, triggered measurements, and pulse actions.

Measurements using the trigger model can be made synchronously with sourcing actions or they can be made asynchronously. The following figures graphically illustrate both modes of the remote trigger model.

When the `smua.trigger.measure.action` attribute is set to `smua.DISABLE` or `smua.ENABLE`, the trigger model operates in synchronous measurement mode. When it is set to `smua.ASYNC`, it operates in asynchronous mode.

Figure 74: Trigger model: Synchronous mode

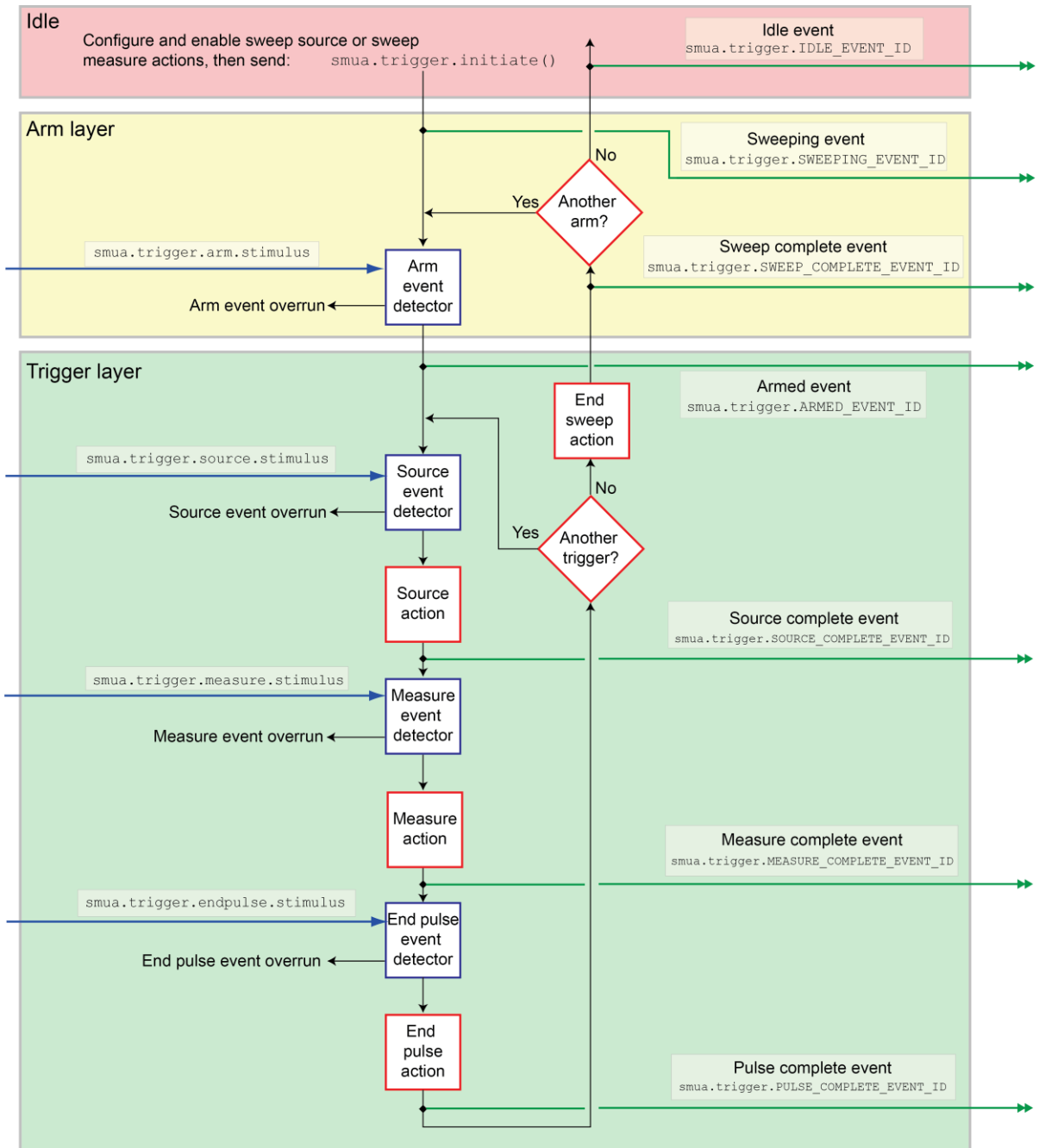
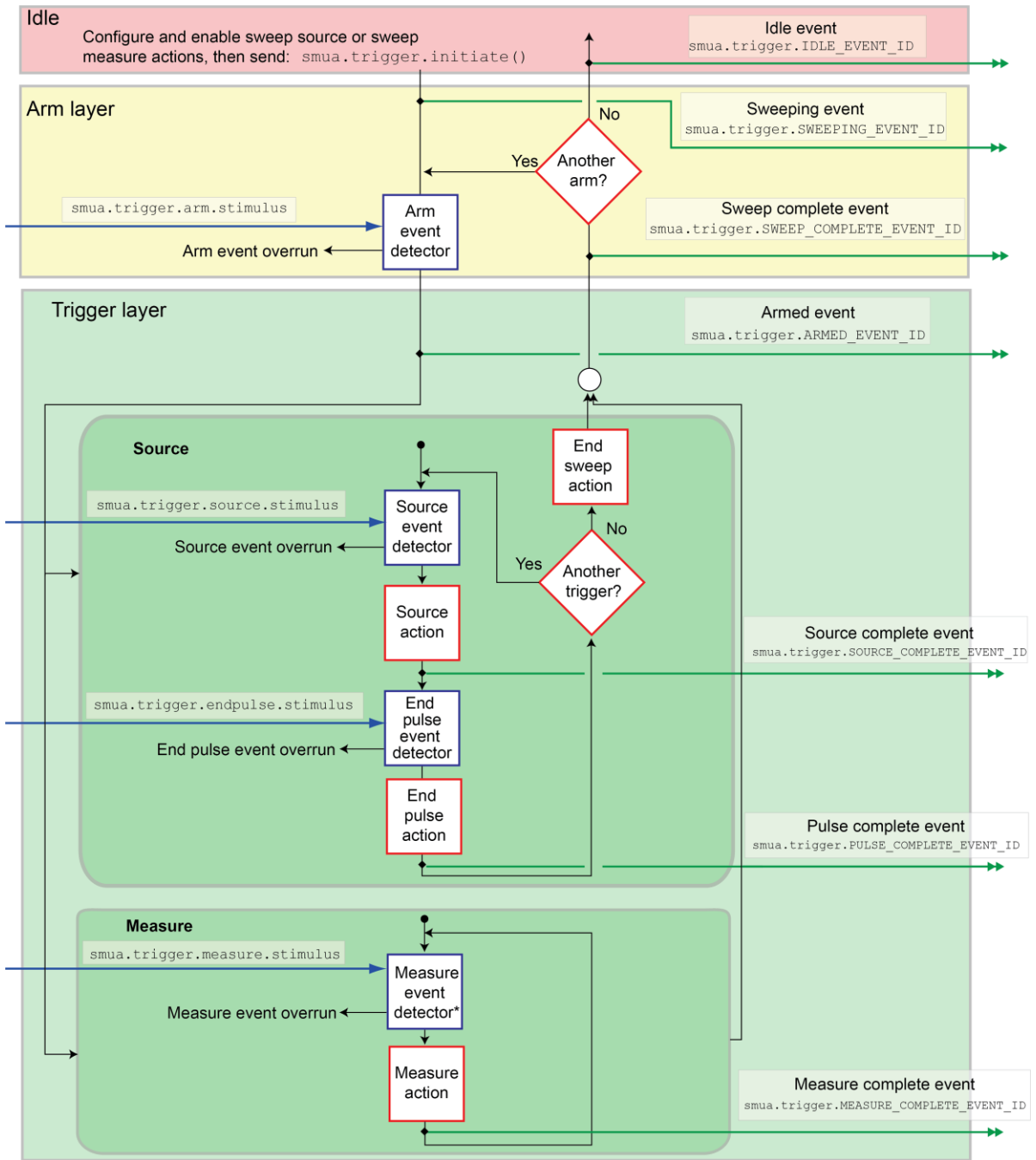

Figure 75: Trigger model: Asynchronous mode



Trigger model sections

As shown in the previous figures, the trigger model consists of the sections idle, arm layer, and trigger layer.

The SMU is in the idle state if a sweep is not in process. Use the `smua.trigger.initiate()` function to move the SMU from the idle state to the arm layer.

Each sweep starts and ends in the arm layer.

All source, measurement, and pulse actions occur in the trigger layer. The source outputs the programmed voltage or current source value. Measurements can be current, voltage, resistance, or power. The end pulse action sources the idle (or bias) level when the instrument generates pulses.

The trigger model dictates the sequence of operation for the SMU when it is configured to perform a sweep. When the SMU comes to an event detector, it suspends operation and waits for the event you assigned to the stimulus input. If no event is assigned, the SMU continues uninterrupted past the event detector and through the trigger model. When the SMU comes to an action block, it performs the appropriate action, if enabled. The SMU loops through the arm and trigger layers until the programmed arm and trigger counts are satisfied.

Configuring source and measure actions

You can configure the source action using any of the following functions:

```
smua.trigger.source.linearY()  
smua.trigger.source.logY()  
smua.trigger.source.listY()
```

Where:

Y = Source function (v = voltage, i = current)

Source functions cannot be changed within a sweep. See [Sweep operation](#) (on page 4-61) for more details about the sweep functions.

To enable the source action, set the `smua.trigger.source.action` attribute to `smua.ENABLE`.

The source-measure unit (SMU) can be configured to perform any or all available measurements during a sweep using the `smua.trigger.measure.Y()` function. To enable the measure action for a simple synchronous sweep, set the `smua.trigger.measure.action` attribute to `smua.ENABLE`. To enable the measure action for an asynchronous sweep, set the `smua.trigger.measure.action` attribute to `smua.ASYNC`.

NOTE

In asynchronous mode, trigger your measurements before the source completes the sweep (before the end sweep action occurs). If the source loop has completed its end sweep action, the measure loop terminates unless the measure action block is actively measuring. If this is the case, the active measurement is allowed to complete before returning to the arm layer.

When the pulser is disabled, configured source and measure delays are imposed when the SMU executes the source and measure action blocks.

Regardless of the pulser state, if the measure count setting is greater than one, the measure count is satisfied each time the measure action is performed. Refer to [Sweep operation](#) (on page 4-61) for information about configuring source and measure sweeps.

The arm and trigger counts must be set to control how many times the SMU executes the source and measure actions. The arm count indicates the number of times to execute the complete sweep. The trigger count sets the number of loops in the trigger layer. Typically, you set the trigger count to be equal to the number of points in the configured sweep. If the trigger count is not equal to the number of points configured in the sweep, then one of the following occurs:

- If the trigger count is greater than the number of points in a sweep as configured by `smua.trigger.source.linearY()`, `smua.trigger.source.logY()`, or `smua.trigger.source.listY()`, then the SMU will satisfy the trigger count by restarting the sweep values from the beginning.
- If the trigger count is less than the number of source values configured, then the SMU will satisfy the trigger count and ignore the remaining source values.

For example, configure a three-point linear voltage sweep from 1 to 3 V, with the trigger count set to 2. The SMU will output 1 V, 2 V. If the trigger count is set to 6, then the SMU will output the values 1 V, 2 V, 3 V, 1 V, 2 V, 3 V, repeating the source values twice in a single sweep.

Enabling pulse sweeps using the end pulse action

When the pulser is disabled, you can enable pulse sweeps by using the end pulse action. When the pulser is enabled, the instrument always behaves as if the endpulse action is set to `smua.SOURCE_IDLE`.

The command below illustrates how to configure pulse mode sweeps by setting the end pulse action:

```
smua.trigger.endpulse.action = smua.SOURCE_IDLE
```

You can use timers to configure the pulse width and period. Refer to [Timers](#) (on page 6-13) for more information.

To disable pulse sweeps, set the `smua.trigger.endpulse.action` attribute to `smua.SOURCE_HOLD`.

When the pulser is enabled, you can use the `smua.trigger.source.pulsewidth` attribute to control the pulse width. The `smua.trigger.source.pulsewidth` and `smua.pulser.measure.delay` attributes provide more precise timing than you can achieve using the `smua.trigger.endpulse.action` attribute.

SMU event detectors

As shown in the [Using the remote trigger model](#) (on page 6-3) topic, the source-measure unit (SMU) has multiple event detectors (see the table below) in order to control the timing of various actions. Each event detector monitors for the trigger event assigned to the associated stimulus input. Operation through the trigger model is delayed at the event detector until the programmed trigger event occurs.

If the stimulus input is set to zero (0), then the SMU continues uninterrupted through the remote trigger model.

Event detectors

Event detector	Function
Arm	Controls entry into the trigger layer of the trigger model.
Source	Controls execution of the source action.
Measure	Controls execution of the measurement action.
End pulse	Controls execution of the end pulse action.

For the SMU, action overruns occur when a new trigger is detected before the previous trigger has been acted upon. When the trigger model is configured for asynchronous measurements, a measurement trigger generates an overrun if the SMU is not ready to start a new measurement.

Clearing SMU event detectors

When an event detector is cleared, the event detector discards previously detected trigger events. This prevents the source-measure unit (SMU) from using trigger events that were detected during the last sweep or while it is in the arm layer, and allows it to start monitoring for new trigger events.

SMU event detectors are automatically cleared when:

- A sweep is initiated using the `smua.trigger.initiate()` function.
- The SMU moves from the arm layer into the trigger layer and the `smua.trigger.autoclear` attribute is enabled.

Using the TRIG key to trigger a sweep

The source-measure unit (SMU) can be configured to perform a sweep where each source step is triggered by the front-panel TRIG key. The source action is preceded by the source event detector. The SMU pauses operation at an event detector until a programmed event occurs. The SMU can be programmed to wait at the source event detector (that is, not start the source action) until the TRIG key is pressed.

To configure the front panel TRIG key to trigger the source action, assign the trigger event created by the TRIG key (`display.trigger.EVENT_ID`) to the source stimulus input (`smua.trigger.source.stimulus`).

The programming example below illustrates how to configure a 10-point linear voltage sweep on SMU A, where each step is triggered by the TRIG key:



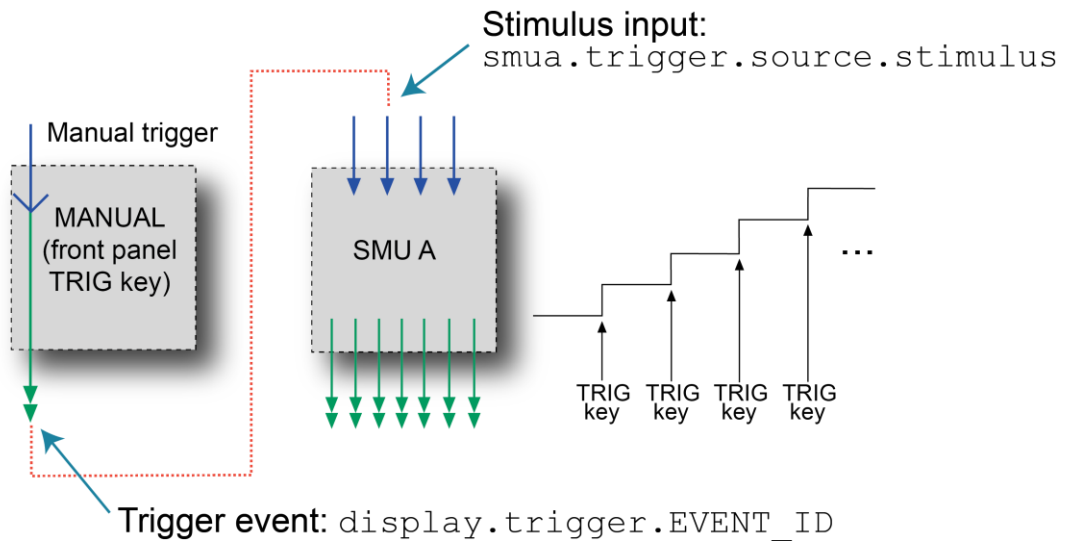

```
-- Configure a 10-point source voltage sweep.
smua.trigger.source.linearv(1, 10, 10)
smua.trigger.source.action = smua.ENABLE
-- Configure TRIG key press as input trigger for source action.
smua.trigger.source.stimulus = display.trigger.EVENT_ID
-- Command SMU to execute a single 10-point sweep.
smua.trigger.count = 10
smua.trigger.arm.count = 1
-- Turn on the output in preparation for the sweep
smua.source.output = smua.OUTPUT_ON
-- Start the sweep and clear the event detectors.
smua.trigger.initiate()
-- The SMU will wait for the front panel TRIG key press before executing
-- each source action.
-- Wait for the sweep to complete.
waitcomplete()
```

The following figure graphically illustrates this example. See [Sweep operation](#) (on page 4-61) for more information about sweep operation.

Figure 76: Front panel TRIG key triggering



Legend:

-  = Trigger object
-  = Trigger events
-  = Stimulus input
-  = External input trigger

Using trigger events to start actions on trigger objects

Trigger objects can be configured to respond to events generated by other trigger objects, such as using a digital I/O trigger to initiate a sweep. To configure a trigger object to monitor for an event, assign the event ID of the trigger event to the stimulus input. When the specified trigger event occurs, the trigger object performs an action. The programming example below illustrates how to generate a digital I/O line 2 output trigger pulse for each SMU A source complete event:

```
-- Configure digio line 2 to generate an output trigger pulse each
-- time SMU A generates a source complete event.
digio.trigger[2].stimulus = smua.trigger.SOURCE_COMPLETE_EVENT_ID
```

The following figure illustrates this example.

Figure 77: Using trigger events to start actions

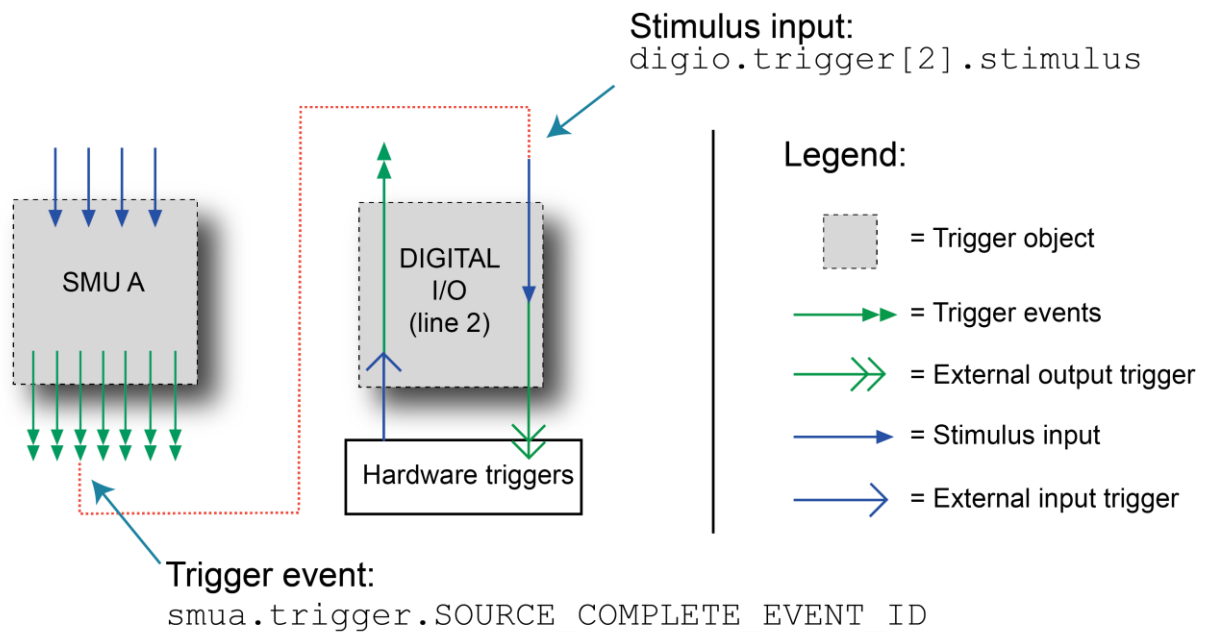

A stimulus input can be configured to monitor for only one trigger event ID at a time. To monitor more than one event, use an event blender. See [Event blenders](#) (on page 6-19) for more information.

Action overruns

An action overrun occurs when a trigger object receives a trigger event and is not ready to act on it. The action overruns of all trigger objects are reported in the operation event registers of the status model. Please refer to [Status model](#) (on page 15-1) and the appropriate sections on each trigger object for further details on conditions under which an object generates an action overrun.

Digital I/O port and TSP-Link synchronization lines

The 2601B-PULSE has two sets of hardware lines that can be used for triggering: 14 digital I/O lines and three TSP-Link® synchronization lines. These trigger objects can be configured and controlled in the same way.

See [Digital I/O](#) (on page 6-36, on page 9-6) for more information about connections and direct control of the digital I/O and TSP-Link synchronization lines.

Mode

The mode indicates the type of edge the hardware lines detect as an external input trigger. Mode also indicates the type of signal generated as an external output trigger. The following table describes the hardware trigger modes for the hardware trigger lines. The hardware trigger modes are described in more detail in [Hardware trigger modes](#) (on page 6-28).

NOTE

To disable triggering on the hardware trigger lines, set the mode to bypass. This allows direct control of the line.

Hardware trigger mode summary

Trigger mode	Output		Input
	Unasserted	Asserted	Detects
Bypass	N/A	N/A	N/A
Either Edge	High	Low	Either
Falling Edge	High	Low	Falling
Rising Edge	The programmed state of the line determines if the behavior is similar to RisingA or RisingM: <ul style="list-style-type: none"> ▪ High similar to RisingA ▪ Low similar to RisingM 		
RisingA	High	Low	Rising
RisingM	Low	High	None
Synchronous	High latching	Low	Falling
SynchronousA	High latching	High	Falling
SynchronousM	High	Low	Rising

Pulsewidth

Specifies the pulse width of the output trigger signal when the hardware line is asserted.

Trigger configuration on hardware lines

You can configure the 2601B-PULSE to send digital signals to trigger external instruments. The output triggers can be linked to the completion of certain source-measure actions to enable hardware handshaking. The following programming example illustrates this.

```



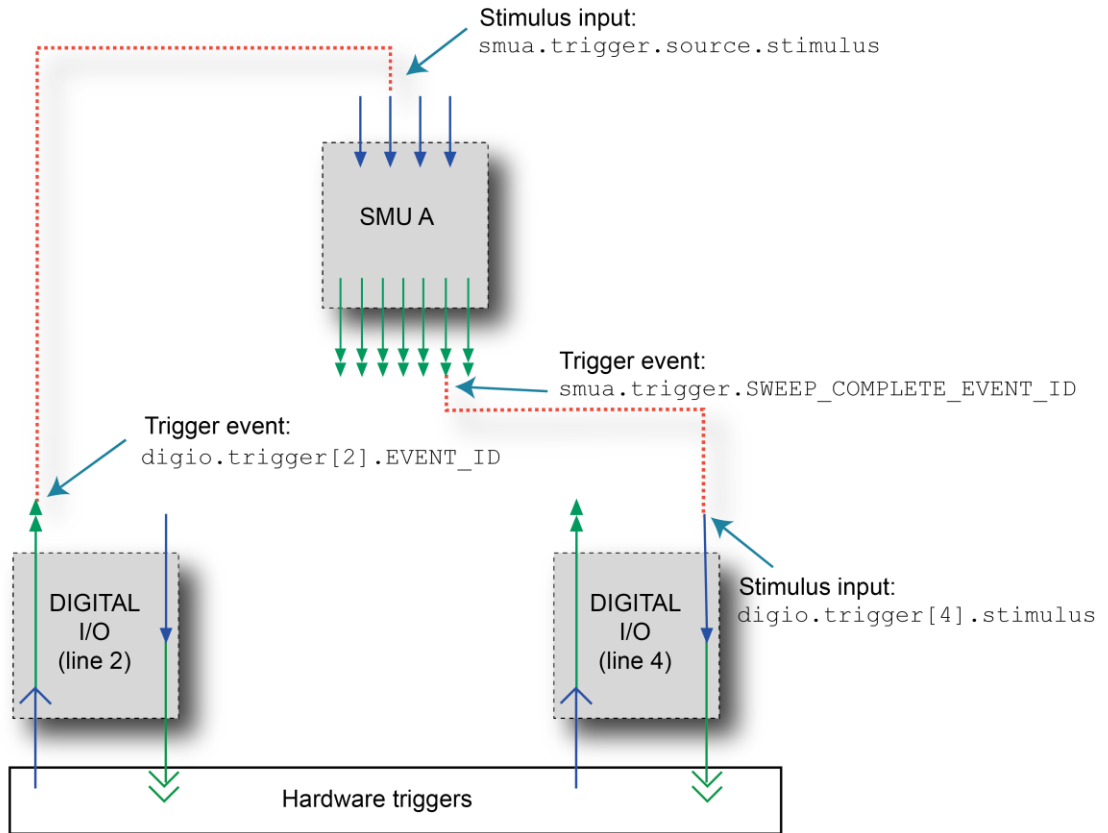

-- Configure the 2601B-PULSE to detect a rising
-- edge on digital I/O line 2.
digio.trigger[2].mode = digio.TRIG_RISINGA
digio.trigger[2].clear()
-- Configure SMU A to start its source action when a
-- trigger event occurs on digital I/O line 2.
smua.trigger.source.stimulus = digio.trigger[2].EVENT_ID
-- Configure digital I/O line 4 to output a 1 ms
-- rising-edge trigger pulse at the completion of
-- SMU sweep.
digio.trigger[4].mode = digio.TRIG_RISINGM
digio.trigger[4].pulsewidth = 0.001
digio.trigger[4].stimulus = smua.trigger.SWEEP_COMPLETE_EVENT_ID
    
```

The triggering setup for this example is shown in the following figure.

Figure 78: External instrument triggering



Legend:

-  = Trigger object
-  = Trigger events
-  = External output trigger
-  = Stimulus input
-  = External input trigger

Action overruns on hardware lines

An action overrun occurs when a trigger event is received before the digital I/O or TSP-Link® line is ready to process it. The generation of an action overrun is dependent upon the trigger mode selected for that line. For more details on the causes of action overruns, see [Hardware trigger modes](#) (on page 6-28). Use the status model to monitor for the occurrence of action overruns. For details, see the [Status model](#) (on page 15-1).

Timers

A timer is a trigger object that performs a delay when triggered. Timers can be used to create delays and to start measurements and step the source value at timed intervals. When a delay expires, the timer generates a trigger event. The 2601B-PULSE has eight independent timers.

Timer attributes

Each timer has attributes that you can configure. These attributes are described in the following sections.

Count

The count sets the number of events to generate each time the timer generates a trigger event. Each event is separated by the delay set by the `trigger.timer[N].delay` command.

To configure the count, use the command `trigger.timer[N].count`.

Set the count number to 0 (zero) to cause the timer to generate trigger events indefinitely.

Timer delays

Timers can be configured to perform the same delay each time or configured with a delay list that allows the timer to sequence through an array of delay values. All delay values are specified in seconds.

A delay is the period after the timer is triggered and before the timer generates a trigger event. The programming example below illustrates how to configure timer 3 for a 10 s delay:

```
trigger.timer[3].delay = 10
```

You can configure a custom delay list to allow the timer to use a different interval each time it performs a delay. Each time the timer generates a trigger event, it uses the next delay in the list. The timer repeats the delay list after all the elements in the delay list have been used. The programming example below illustrates how to configure timer 3 for delays of 2, 10, 15, and 7 s:

```
-- Configure timer 3 to complete delays of 2 s, 10 s,  
-- 15 s, and 7 s.  
trigger.timer[3].delaylist = {2, 10, 15, 7}
```

NOTE

Assigning a value to the delay attribute is the same as configuring it with a one-element delay list.

Pass-through mode

When enabled, the timer generates a trigger event immediately when it is triggered. The timer generates additional trigger events each time a delay expires. If the pass-through attribute is disabled, the timer does not generate a trigger event until after the first delay elapses. The programming example below illustrates how to configure timer 3 by enabling pass-through mode:

```
trigger.timer[3].passthrough = true
```

Triggering a timer

A timer can be configured to start a delay when a trigger object generates a trigger event. Timers cannot be started with a command. A trigger event from a trigger object must be used to initiate a delay.

Assigning the stimulus attribute

Assign an event ID to the `trigger.timer[N].stimulus` attribute to configure the timer to start a delay when a specific trigger event occurs. The programming example below illustrates how to configure a source-delay-measure (SDM) cycle.

```
-- Configure the timer to begin when source action completes.
trigger.timer[1].stimulus = smua.trigger.SOURCE_COMPLETE_EVENT_ID
-- SMUA delay before a measurement begins.
smua.trigger.measure.stimulus = trigger.timer[1].EVENT_ID
```

Figure 79: Using a timer for an SDM cycle

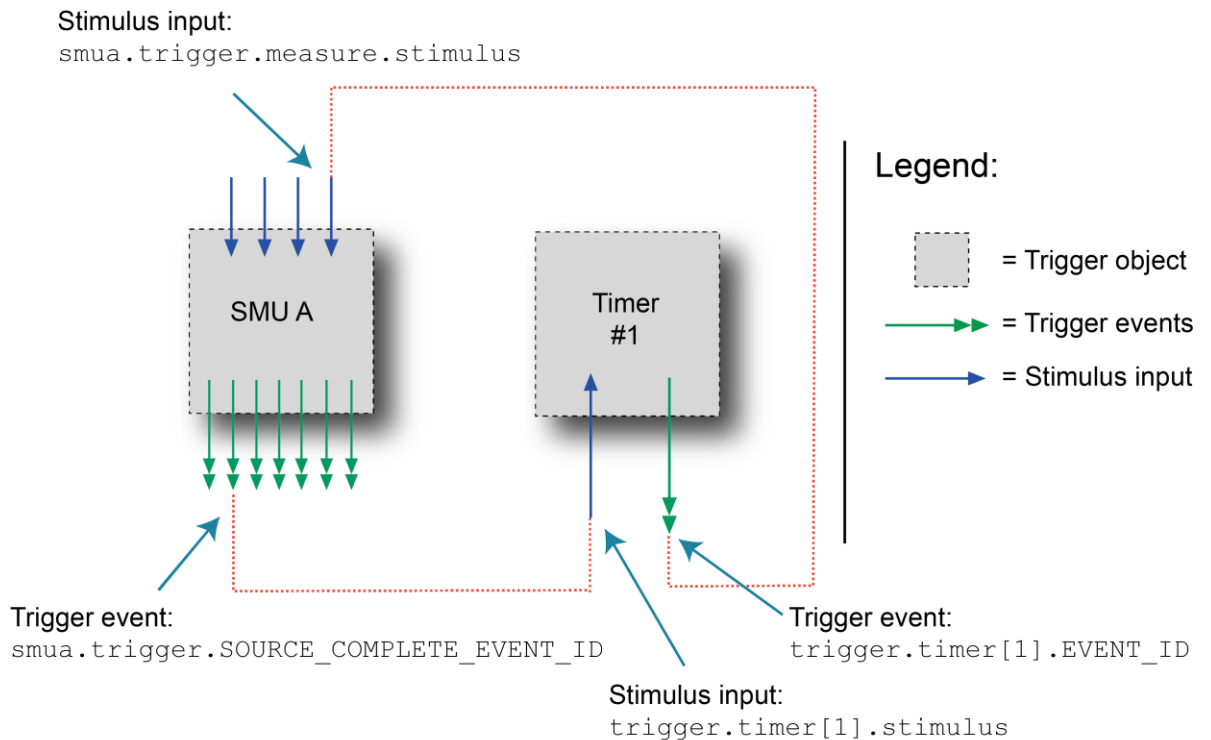

Timer action overruns

The timer receives an action overrun when it generates a trigger event while a timer delay is still in progress. Use the status model to monitor for the occurrence of action overruns. For details, see the [Status model](#) (on page 15-1).

Using timers to perform pulsed sweeps

When the pulser is disabled, you can use timers used to control the pulse width during a pulsed sweep. To create a pulse train, a second timer must be used to configure the pulse period. The examples below show a single pulse output and a pulse train output.

NOTE

The SMU end pulse action `smua.trigger.endpulse.action` must be set to `smua.SOURCE_IDLE` in order to create a pulse.

NOTE

When the pulser is enabled, configure pulsed sweeps using the `smua.trigger.source.pulsewidth` and the `smua.pulser.measure.delay` attributes. Refer to [Pulser operation](#) (on page 4-33) for information on setting up pulsed sweeps with the pulser enabled.

Single pulse example

The SMU programming example below illustrates how to use a single timer to control the pulse width of a single-shot pulse measurement. The programming example configures the timer and SMU as follows:

Timer 1: Pulse width timer

- Set the delay attribute of a timer equal to the appropriate pulse width.
- Configure the timer to trigger when the SMU moves out of the arm layer of the trigger model.
- Assign the trigger event generated by the timer to the stimulus input of the SMU end pulse event detector.

SMU

- Configure the source action to start immediately by setting the stimulus input of the source event detector to 0.
- Set the end pulse action to `SOURCE_IDLE`.

The following figure shows the trigger setup for this example.

Figure 80: Single pulse triggering

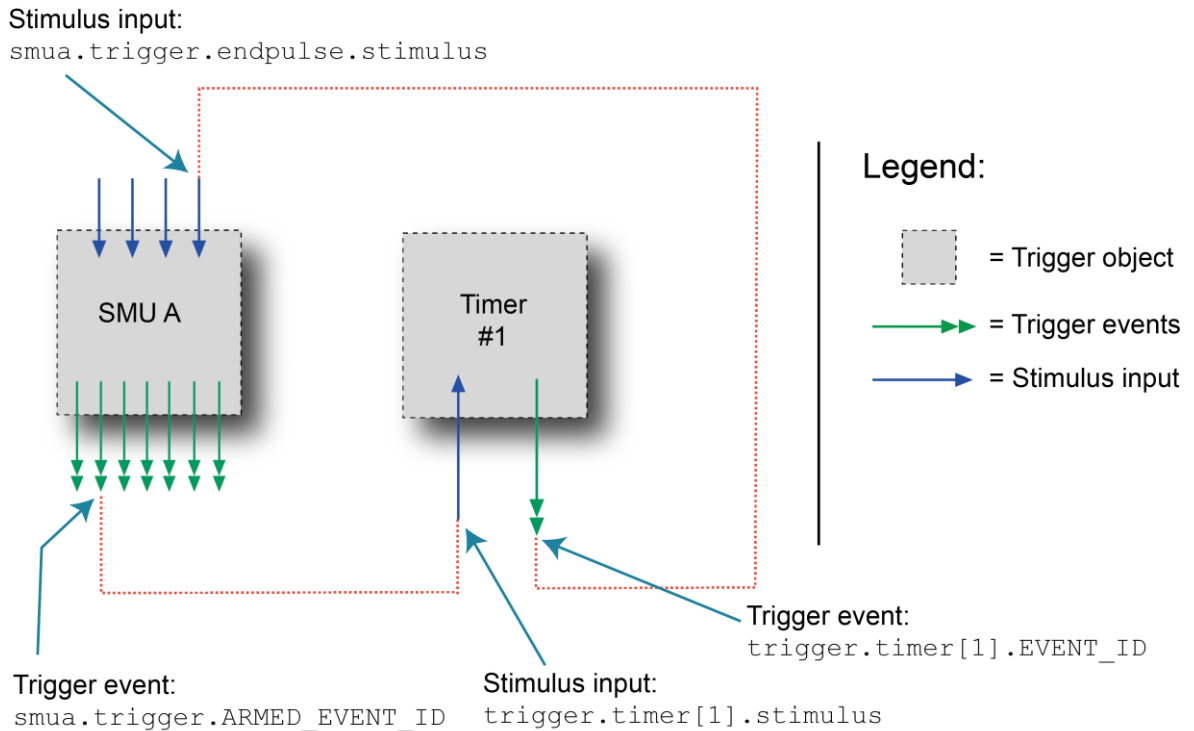

Single pulse example code

```
-- Generate a single 500 us, 5 V pulse.
-- Configure a single-point voltage list sweep.
smua.trigger.source.listv({5})
smua.trigger.source.action = smua.ENABLE
smua.trigger.measure.action = smua.DISABLE
-- Configure other source parameters for best timing possible.
smua.trigger.source.limiti = 0.1
smua.source.rangev = 5
-- Configure timer parameters to output a single 500 us pulse.
trigger.timer[1].delay = 0.0005
trigger.timer[1].count = 1
trigger.timer[1].passthrough = false
-- Trigger timer when the SMU passes through the ARM layer.
trigger.timer[1].stimulus = smua.trigger.ARMED_EVENT_ID
-- Configure source action to start immediately.
smua.trigger.source.stimulus = 0
-- Configure endpulse action to achieve a pulse.
smua.trigger.endpulse.action = smua.SOURCE_IDLE
smua.trigger.endpulse.stimulus = trigger.timer[1].EVENT_ID
-- Set appropriate counts of trigger model.
smua.trigger.count = 1
smua.trigger.arm.count = 1
-- Turn on output and trigger SMU to output a single pulse.
smua.source.output = smua.OUTPUT_ON
smua.trigger.initiate()
-- Wait for the sweep to complete.
waitcomplete()
```

Pulse train example

The SMU programming example below illustrates how to use two timers: One to control the pulse period, a second to control the pulse width. The example configures the timers and SMU as follows:

Timer 1: Pulse period timer

- Set the delay attribute to the appropriate pulse period (see the following figure).
- Configure the timer to start when the sweep is initiated.
- Enable the pass-through attribute so that the timer generates a trigger event at the start of the first delay.
- Set the count equal to one less than the total number of pulses to output.

Figure 81: Pulse train

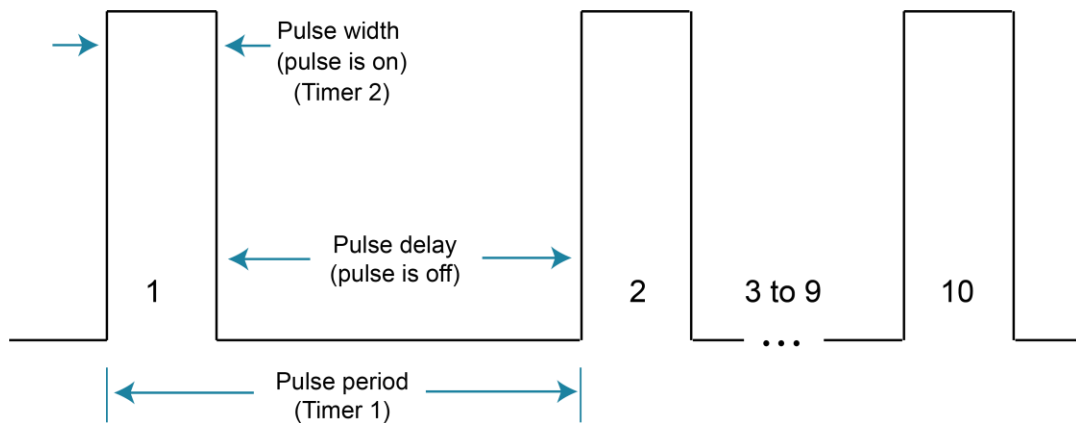

Timer 2: Pulse width timer

- Set the delay attribute to an appropriate pulse width (see the following figure).
- Set the stimulus input to the event ID of Timer 1 (the start of each pulse is the start of the pulse period).
- Set the count equal to 1 so that only one pulse is issued per period.

SMU A

- Set the source stimulus input to the event ID of Timer 1 so that the source action starts when the period starts.
- Set the end pulse action to `smua.SOURCE_IDLE` so that the output is returned to the idle level after the pulse completes.
- Set the end pulse stimulus input to the event ID of Timer 2 so that the end pulse action executes when the pulse width timer expires.
- Set the trigger count equal to 1.
- Set the arm count equal to the total number of pulses to output.

The following figure shows the trigger setup for this example.

Figure 82: Pulse train triggering

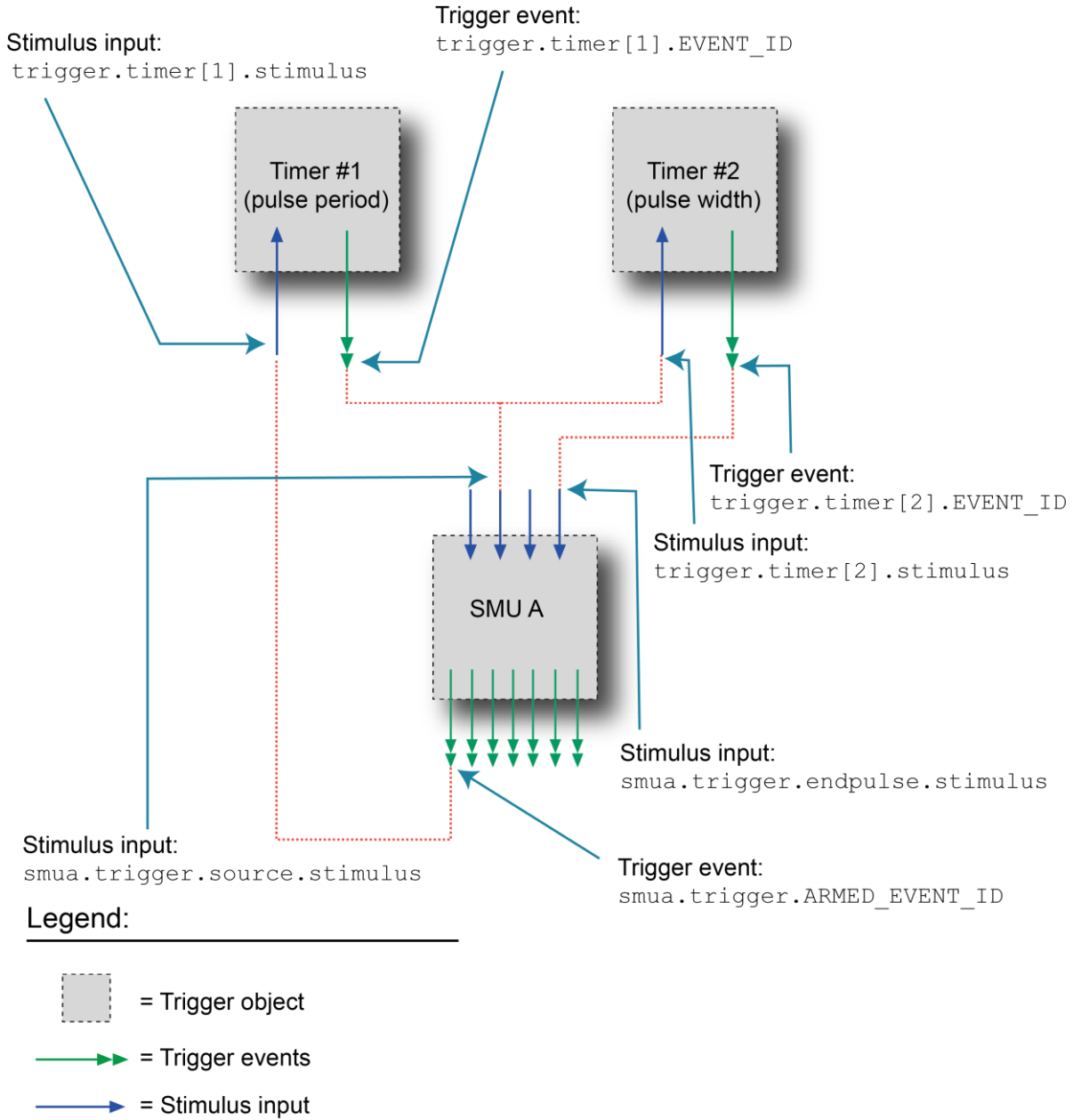

Pulse train example code

```
-- Generate a 10-point pulse train where each pulse has a width of 600
-- microseconds and a pulse period of 5 milliseconds.
-- Alias the trigger timers to use for pulse width and period.
period_timer = trigger.timer[1]
pulse_timer = trigger.timer[2]
-- Create a fixed level voltage sweep.
smua.trigger.source.listv({5})
smua.trigger.source.action = smua.ENABLE
smua.source.rangev = 5
smua.trigger.measure.action = smua.DISABLE
-- Set pulse width.
pulse_timer.delay = 0.0006
-- Trigger pulse width timer with period timer.
pulse_timer.stimulus = period_timer.EVENT_ID
-- Output one pulse per period.
pulse_timer.count = 1
-- Set the pulse period.
period_timer.delay = 0.005
-- Set pulse period count to generate 10 pulses.
period_timer.count = 9
-- Trigger pulse period timer when a sweep is initiated.
period_timer.stimulus = smua.trigger.SWEEPING_EVENT_ID
-- Configure the timer to output a trigger event when it
-- starts the first delay.
period_timer.passthrough = true
-- Trigger SMU source action using pulse period timer.
smua.trigger.source.stimulus = period_timer.EVENT_ID
-- Trigger SMU end pulse action using pulse width timer.
smua.trigger.endpulse.action = smua.SOURCE_IDLE
smua.trigger.endpulse.stimulus = pulse_timer.EVENT_ID
-- Set trigger model counts.
smua.trigger.count = 1
-- Configure the SMU to execute a 10-point pulse train.
smua.trigger.arm.count = 10
-- Prepare SMU to output pulse train.
smua.source.output = smua.OUTPUT_ON
smua.trigger.initiate()
-- Wait for the sweep to complete.
waitcomplete()
```

Event blenders

The ability to combine trigger events is called event blending. You can use an event blender to wait for up to four input trigger events to occur before responding with an output event.

You set the event blender operation using remote commands. You cannot set them up through the front panel.

You can program up to six event blenders for the 2601B-PULSE.

Event blender modes

Event blenders can be used to perform logical AND and logical OR functions on trigger events. For example, trigger events can be triggered when either a manual trigger or external input trigger is detected.

- **Or:** Generates an event when an event is detected on *any* one of the four stimulus inputs
- **And:** Generates an event when an event is detected on *all* of the assigned stimulus inputs

Set the `trigger.blender[N].orenable` attribute to configure the event blender mode. Setting the attribute to `true` enables OR mode; setting the attribute to `false` enables AND mode.

Assigning input trigger events

Each event blender has four stimulus inputs. A different trigger event ID can be assigned to each stimulus input. The programming example below illustrates how to assign the source complete event to stimulus inputs 1 and 2 of event blender 1:

```
trigger.blender[1].stimulus[1] = smua.SOURCE_COMPLETE_EVENT_ID
```

Action overruns

Action overruns are generated by event blenders depending on the mode, as shown in the following table. Use the status model to monitor for the occurrence of action overruns. For details, see the [Status model](#) (on page 15-1).

Action overruns

Mode	Action overrun
And	Generates an overrun when a second event on any of its inputs is detected before generating an output event.
Or	Generates an overrun when two events are detected simultaneously.

LAN triggering overview

Triggers can be sent and received over the LAN interface. The 2601B-PULSE supports LAN extensions for instrumentation (LXI) and has eight LAN triggers that generate and respond to LXI trigger packets.

Understanding hardware value and pseudo line state

LAN triggering is similar to hardware synchronization except that LXI trigger packets are used instead of hardware signals. A bit in the LXI trigger packet called the hardware value simulates the state of a hardware trigger line. The 2601B-PULSE stores the hardware value of the last LXI trigger packet that was sent or received as the pseudo line state.

The stateless event flag is a bit in the LXI trigger packet that indicates if the hardware value should be ignored. If it is set, the 2601B-PULSE ignores the hardware value of the packet and generates a trigger event. The 2601B-PULSE always sets the stateless flag for outgoing LXI trigger packets. If the stateless event flag is not set, the hardware value indicates the state of the signal.

Changes in the hardware value of consecutive LXI trigger packets are interpreted as edge transitions. Edge transitions generate trigger events. If the hardware value does not change between successive LXI trigger packets, the 2601B-PULSE assumes an edge transition was missed and generates a trigger event. The following table illustrates edge detection in LAN triggering.

LXI trigger edge detection

Stateless event flag	Hardware value	Pseudo line state	Falling edge	Rising edge
0	0	0	Detected	Detected
0	1	0	-	Detected
0	0	1	Detected	-
0	1	1	Detected	Detected
1	-	-	Detected	Detected

Set the LAN trigger mode to configure the edge detection method in incoming LXI trigger packets. The mode that is selected also determines the hardware value in outgoing LXI trigger packets. The following table lists the LAN trigger modes.

LAN trigger modes

Trigger mode	Input detected	Output generated	Notes
Either edge	Either	Negative	
Falling edge	Falling	Negative	
Rising edge	Rising	Positive	
RisingA	Rising	Positive	Same as Rising
RisingM	Rising	Positive	Same as Rising
Synchronous	Falling	Positive	Same as SynchronousA
SynchronousA	Falling	Positive	
SynchronousM	Rising	Negative	

The programming example below illustrates how to configure the LAN trigger mode.

```
-- Set LAN trigger 2 to have falling-edge mode.
lan.trigger[2].mode = lan.TRIG_FALLING
```

Understanding LXI trigger event designations

LAN trigger objects generate LXI trigger events, which are LAN0 to LAN7 (zero based). In the command table, the LXI trigger events can be accessed using `lan.trigger[1]` through `lan.trigger[8]`.

`lan.trigger[1]` corresponds to LXI trigger event LAN0 and `lan.trigger[8]` corresponds to LXI trigger event LAN7.

Generating LXI trigger packets

You can configure the 2601B-PULSE to output an LXI trigger packet to other LXI instruments.

To generate LXI trigger packets:

1. Call the `lan.trigger[N].connect()` function.
2. Select the event that triggers the outgoing LXI trigger packet by assigning the specific event ID to the LAN stimulus input.

Make sure to use the same LXI domain on both the 2601B-PULSE instrument and the other instrument. If the 2601B-PULSE has a different LXI domain than the instrument at the other end of the trigger connection, the LXI trigger packets will be ignored by both instruments.

Command interface triggering

A command interface trigger occurs when:

- A GPIB GET command is detected (GPIB only)
- A VXI-11 `device_trigger` method is invoked (VXI-11 only)
- A *TRG message is received
- A USBTMC TRIGGER message is received (USB only)

Use `trigger.EVENT_ID` to monitor for command interface triggers. To ensure that commands and triggers issued over the command interface are processed in the correct order, a trigger event is not generated until:

- The trigger command is executed
- `trigger.wait()` retrieves the trigger command from the command queue before it would normally be executed

Command interface triggering does not generate action overruns. The triggers are processed in the order that they are received in the 2601B-PULSE command queue. The 2601B-PULSE only processes incoming commands when no commands are running. Unprocessed input triggers can cause an overflow in the command queue. It is important to make sure a script processes triggers while it is running.

NOTE

The command queue can fill up with trigger entries if too many *TRG messages are received while a test script is running, even if the script is processing triggers. You can avoid this by using the `localnode.prompts4882` attribute (see [TSP command reference](#) (on page 11-1) for more information), and by using `trigger.wait()` calls that remove the *TRG messages from the command queue. If the command queue fills with too many trigger entries, messages like `abort` will not be processed.

Trigger generator

The 2601B-PULSE has two trigger generators that you can use to generate trigger events. Use the `trigger.generator[N].assert()` function to directly trigger events from the command interface or a script (for example, you can trigger a sweep while the instrument is under script control).

The `trigger.generator[N].EVENT_ID` constant is an identification number that identifies events generated by this generator. To have another trigger object respond to trigger events generated by this generator, set the other object's `stimulus` attribute to the value of this constant.

Manual triggering

The TRIG key is used for manual triggering. Each time the TRIG key is pressed, a trigger event is generated. You can monitor for a manual trigger event using the event ID `display.trigger.EVENT_ID`. See [Using the TRIG key to trigger a sweep](#) (on page 6-8) for an example of how to use a manual trigger.

There are no action overruns for manual triggering.

Interactive triggering

The complexity of some test system configurations may not allow a static trigger setup. These configurations require more dynamic control of triggering than the static trigger setup provides. For such cases, a setup providing interactive trigger programming allows the generation and detection of trigger events that can be controlled on demand under remote control. For example, interactive triggering can be used when you need to make multiple source function changes or implement conditional branching to other test setups based on recent measurements.

Detecting trigger events using the wait() function

All the 2601B-PULSE trigger objects (except for SMUs) have built-in event detectors that monitor for trigger events. The event detector only monitors events generated by that object and cannot be configured to monitor events generated by any other trigger object. Using the `wait()` function of the trigger object causes the 2601B-PULSE instrument to suspend command execution until a trigger event occurs or until the specified timeout period elapses.

For example, use `trigger.blender[N].wait(Y)` to suspend command execution until an event blender generates an event, where *N* is the specific event blender and *Y* is the timeout period. After executing the `wait()` function, the event detector of the trigger object is cleared.

The following programming example illustrates how to suspend command execution while waiting for various events to occur:

```
-- Wait up to 10 seconds for a front-panel TRIG key press.
display.trigger.wait(10)
-- Wait up to 60 seconds for timer 1 to complete its delay.
trigger.timer[1].wait(60)
-- Wait up to 30 seconds for input trigger to digital I/O line 10.
digio.trigger[10].wait(30)
```

Using the assert function to generate output triggers

Certain trigger objects can be used to generate output triggers on demand. These trigger objects are the digital I/O lines, TSP-Link synchronization lines and the LAN.

The programming example below illustrates how to generate an output trigger using the `assert` function of the trigger object.

```
-- Generate a falling-edge trigger on digital I/O line 3.
digio.trigger[3].mode = digio.TRIG_FALLING
digio.trigger[3].assert()
-- Generate a rising edge trigger on TSP-Link sync line 1.
tsplink.trigger[1].mode = tsplink.TRIG_RISINGM
tsplink.trigger[1].assert()
-- Generate a LAN trigger on LAN pseudo line 6.
-- Note that connection parameters and commands that
-- establish a connection are not shown.
lan.trigger[6].mode = lan.TRIG_EITHER
lan.trigger[6].assert()
```

Using the release function of the hardware lines

Use the release function to allow the hardware line to output another external trigger when the pulse width is set to 0.

Setting the pulse width to 0 results in an indefinite length pulse when the assert function is used to output an external trigger. When an indefinite length pulse is used, the release function must be used to release the line before another external trigger can be output.

The release function can also be used to release latched input triggers when the hardware line mode is set to Synchronous. In Synchronous mode, the receipt of a falling edge trigger latches the line low. The release function releases this line high in preparation for another input trigger.

The programming example below illustrates how to output an indefinite external trigger.

```
-- Set digio line 1 to output an indefinite external trigger.
digio.trigger[1].mode = digio.TRIG_FALLING
digio.trigger[1].pulsewidth = 0
digio.trigger[1].assert()
-- Release digio line 1.
digio.trigger[1].release()
-- Output another external trigger.
digio.trigger[1].assert()
```

For information about hardware lines, see [Digital I/O port and TSP-Link synchronization lines](#) (on page 6-11).

Using the set function to bypass SMU event detectors

The set function is useful whenever you want the source-measure unit (SMU) to continue operation without waiting for a programmed trigger event.

There is a set function for each SMU event detector. When called, the function immediately satisfies the event detector, allowing the SMU to continue through the trigger model.

An example of when the set function can be used is when you want the SMU to immediately perform an action the first time through the trigger model, even if a programmed trigger event does not occur. The set function can be used to start actions on the SMU if there is a missed trigger event.

The programming example below illustrates how to have the SMU immediately perform an action the first time through the trigger model, even if a programmed trigger event does not occur.

```
-- Immediately sets the arm event detector of SMU A
-- to the detected state.
smua.trigger.arm.set()
-- Sets the measure event detector of SMU A.
smua.trigger.measure.set()
```

Event detector overruns

If a second trigger event is generated before an event detector clears, the trigger object generates a detector overrun. You can check for detector overruns by reading the `overrun` attribute of the trigger object. The attribute is set to `true` when an overrun occurs. The `clear()` function can be used to immediately clear the event detector, discarding any history of previous trigger events. The `clear()` function also clears any detector overruns.

NOTE

Detector overruns are not the same as the action overruns that are reported in the status model.

The programming example below illustrates how to check and respond to detector overruns.

```
testOver = digio.trigger[4].overrun
if testOver == true then
    print("Digital I/O overrun occurred.")
end
```

Examples using interactive triggering

Command interface interactive trigger example

The programming example below illustrates how to clear triggers, turn on the SMU output, and then enable a 30-second timeout to wait for a command interface trigger. When the trigger is received, the 2601B-PULSE performs a voltage reading.

```
-- Clear any previously detected command interface triggers.
trigger.clear()
-- Turn on output.
smua.source.output = smua.OUTPUT_ON
-- Wait 30 seconds for a command interface trigger.
triggered = trigger.wait(30)
-- Get voltage reading.
reading = smua.measure.v()
-- Send command interface trigger to trigger the measurement.
*TRG
```

NOTE

*TRG cannot be used in a script.

Manual triggering example

The programming example below illustrates how to pause a script and prompt the operator to press the TRIG key when they are ready to continue. If the TRIG key is not pressed, the test will continue after waiting 10 minutes (600 seconds).

```
display.clear()
display.trigger.clear()
display.setcursor(1, 1)
display.settext("Take a Break")
display.setcursor(2, 1)
display.settext("Press TRIG to continue")
display.trigger.wait(600)
display.clear()
```

Digital I/O triggering interactive example

The programming example below illustrates how to configure digital I/O line 2 as an input trigger and digital I/O line 14 as an output trigger. It commands the 2601B-PULSE to wait for an external input trigger on digital I/O line 2. If a trigger event occurs, the 2601B-PULSE outputs an external trigger on digital I/O line 14. If no trigger event is received on digital I/O line 2, the test is aborted.

```
-- Configure digital I/O lines 2 and 14 for input trigger detection
-- and output trigger generation, respectively.
digio.trigger[2].mode = digio.TRIG_RISINGA
digio.trigger[2].clear()
digio.trigger[14].mode = digio.TRIG_FALLING
digio.trigger[14].pulsewidth = 0.0001
-- Wait 15 seconds for a trigger event to occur on digital I/O line 2.
trigInput = digio.trigger[2].wait(15)
-- If a trigger event occurs on digital I/O line 2, assert an output
-- trigger on digital I/O line 14. If a trigger event does
-- not occur, then turn off the output of smua and issue a message
-- on the front-panel display.
if trigInput == true then
    digio.trigger[14].assert()
else
    smua.source.output = smua.OUTPUT_OFF
    display.screen = display.USER
    display.clear()
    display.setcursor(1, 1)
    display.settext("No trigger received. Test aborted.")
    exit()
end
```

Hardware trigger modes

Different hardware trigger modes can be used for digital I/O and TSP-Link® synchronization. Use hardware triggers to integrate Keithley instruments and non-Keithley instruments in a test system. The 2601B-PULSE supports 14 digital I/O lines and three TSP-Link synchronization lines that can be used for input or output triggering. For additional information about the hardware trigger modes, see [TSP command reference](#) (on page 11-1).

NOTE

For direct control of the line state, use the bypass trigger mode.

Falling edge trigger mode

The falling edge trigger mode generates low pulses and detects all falling edges. The figure titled "Falling edge input trigger" shows the characteristics of the falling edge input trigger; the figure titled "Falling edge output trigger" shows the falling edge output trigger.

Input characteristics:

- Detects all falling edges as input triggers.

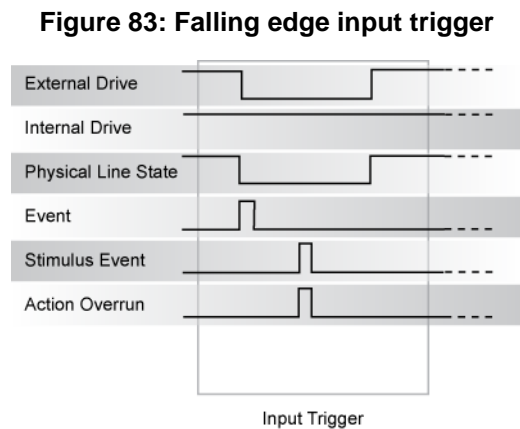

Output characteristics:

- In addition to trigger events from other trigger objects, the `digio.trigger[N].assert()` and `tsplink.trigger[N].assert()` commands generate a low pulse for the programmed pulse duration.
- An action overrun occurs if the physical line state is low and a source event occurs.

Figure 84: Falling edge output trigger

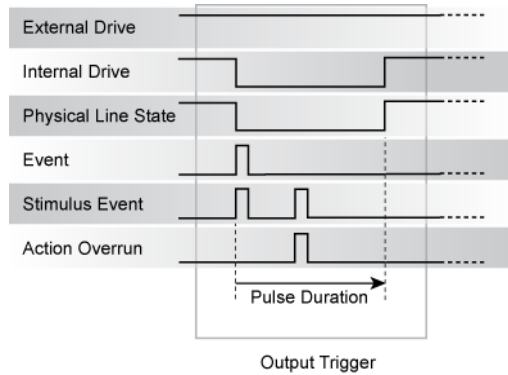

Rising edge master trigger mode

Use the rising edge master (RisingM) trigger mode (see the figure titled "RisingM output trigger") to synchronize with non-Keithley instruments that require a high pulse. Input trigger detection is not available in this trigger mode. You can use the RisingM trigger mode to generate rising edge pulses.

NOTE

The RisingM trigger mode does not function properly if the line is driven low by an external drive.

Output characteristics:

- Configured trigger events, as well as the `digio.trigger[N].assert()` and `tsplink.trigger[N].assert()` commands, cause the physical line state to float high during the trigger pulse duration.
- An action overrun occurs if the physical line state is high while a stimulus event occurs.

Figure 85: RisingM output trigger

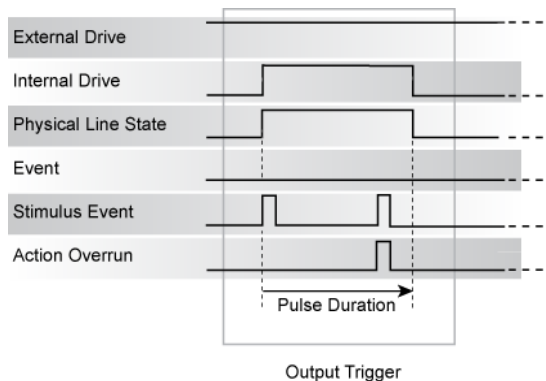

Rising edge acceptor trigger mode

The rising edge acceptor trigger mode (RisingA) generates a low pulse and detects rising edge pulses. Refer to the following figures.

Input characteristics:

- All rising edges generate an input event.

Figure 86: RisingA input trigger

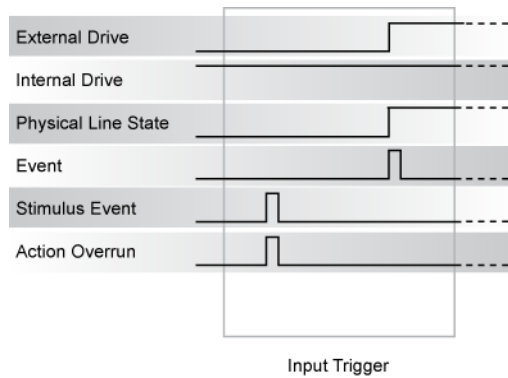

Output characteristics:

- In addition to trigger events from other trigger objects, the `digio.trigger[N].assert()` and `tsplink.trigger[N].assert()` commands generate a low pulse that is similar to the falling edge trigger mode.

Figure 87: RisingA output trigger

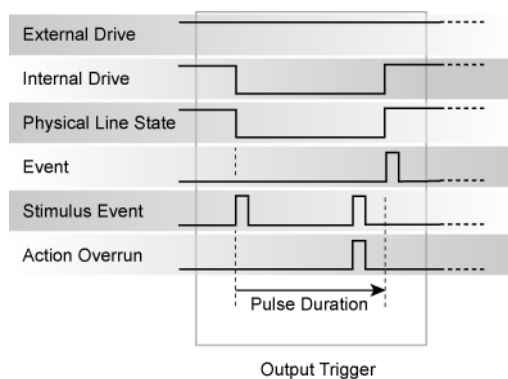

Either edge trigger mode

The either edge trigger mode generates a low pulse and detects both rising and falling edges.

Input characteristics:

- All rising or falling edges generate an input trigger event.

Figure 88: Either edge input trigger

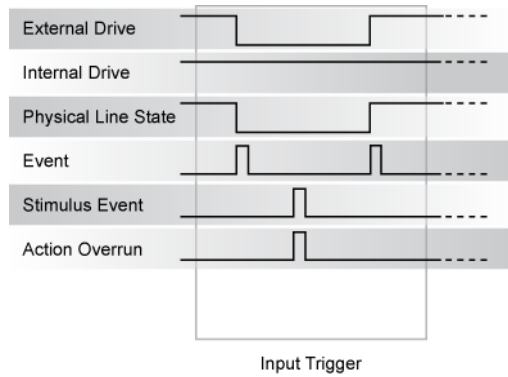

Output characteristics:

- In addition to trigger events from other trigger objects, the `digio.trigger[N].assert()` and `tsplink.trigger[N].assert()` commands generate a low pulse that is similar to the falling edge trigger mode.
- An action overrun occurs if the physical line state is low while a stimulus event occurs.

Figure 89: Either edge output trigger

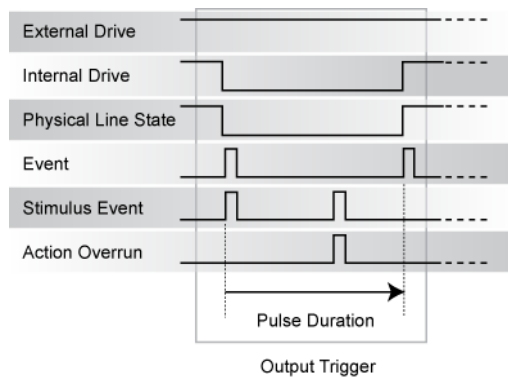

Understanding synchronous triggering modes

Use the synchronous triggering modes to implement bidirectional triggering, to wait for one node, or to wait for a collection of nodes to complete all triggered actions.

All non-Keithley instrumentation must have a trigger mode that functions similar to the SynchronousA or SynchronousM trigger modes.

To use synchronous triggering, configure the triggering master to SynchronousM trigger mode or the non-Keithley equivalent. Configure all other nodes in the test system to SynchronousA trigger mode or a non-Keithley equivalent.

Synchronous master trigger mode (SynchronousM)

Use the synchronous master trigger mode (SynchronousM) to generate falling edge output triggers, to detect the rising edge input triggers, and to initiate an action on one or more external nodes with the same trigger line.

In this mode, the output trigger consists of a low pulse. All non-Keithley instruments attached to the synchronization line in a trigger mode equivalent to SynchronousA must latch the line low during the pulse duration.

To use the SynchronousM trigger mode, configure the triggering master as SynchronousM and then configure all other nodes in the test system as Synchronous, SynchronousA, or to the non-Keithley Instruments equivalent.

NOTE

Use the SynchronousM trigger mode to receive notification when the triggered action on all nodes is complete.

Input characteristics:

- All rising edges are input triggers.
- When all external drives release the physical line, the rising edge is detected as an input trigger.
- A rising edge is not detected until all external drives release the line and the line floats high.

Figure 90: Synchronous master input trigger

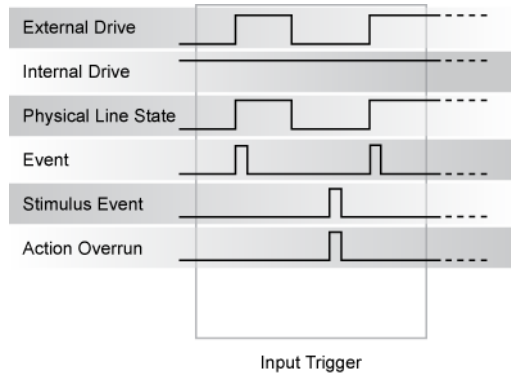

Output characteristics:

- In addition to trigger events from other trigger objects, the `digio.trigger[N].assert()` and `tsplink.trigger[N].assert()` functions generate a low pulse that is similar to the falling edge trigger mode.
- An action overrun occurs if the physical line state is low while a stimulus event occurs.

Figure 91: Synchronous master output trigger

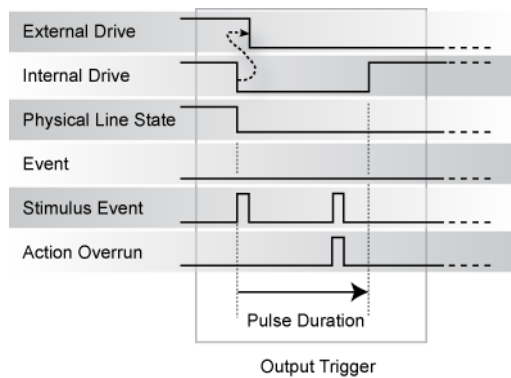

Synchronous acceptor trigger mode (SynchronousA)

Use the synchronous acceptor trigger mode (SynchronousA) on a trigger subordinate that operates with a trigger master configured for the SynchronousM trigger mode. The roles of the internal and external drives are reversed in the SynchronousA trigger mode.

Input characteristics:

- The falling edge is detected as the external drive pulses the line low, and the internal drive latches the line low.

Figure 92: Synchronous acceptor input trigger

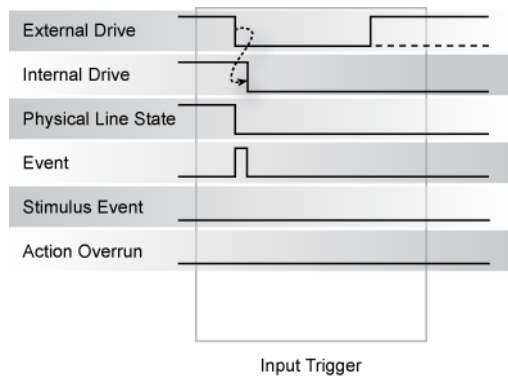

Output characteristics:

- In addition to trigger events from other trigger objects, the `digio.trigger[N].assert()` and `tsplink.trigger[N].assert()` functions release the line if the line is latched low. The pulse width is not used.
- The physical line state does not change until all drives (internal and external) release the line.
- Action overruns occur if the internal drive is not latched low and a source event is received.

Figure 93: Synchronous acceptor output trigger

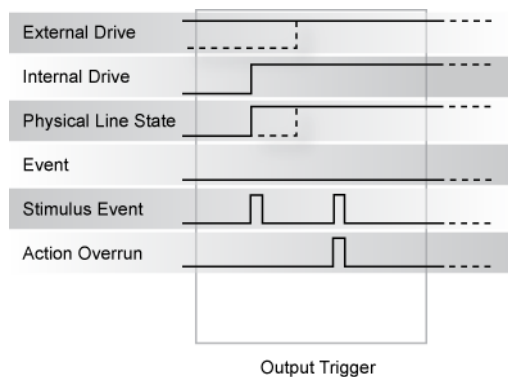

Synchronous trigger mode

The synchronous trigger mode is a combination of SynchronousA and SynchronousM trigger modes. Use the Synchronous trigger mode for compatibility with older Keithley Instruments products.

NOTE

Keithley Instruments recommends using SynchronousA and SynchronousM modes only.

Input characteristics:

- The falling edge generates an input event and latches the internal drive low.

Figure 94: Synchronous input trigger

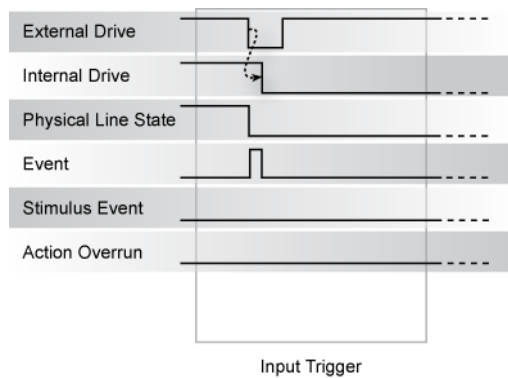

Output characteristics:

- In addition to trigger events from other trigger objects, the `digio.trigger[N].assert()` and `tsplink.trigger[N].assert()` functions generate a low pulse for the programmed pulse duration if the line is latched low, a falling edge does not occur.
- A normal falling edge pulse generates when the internal drive is not latched low and the `digio.trigger[N].assert()` and `tsplink.trigger[N].assert()` functions are issued.
- To mirror the SynchronousA trigger mode, set the pulse width to 1 μ s or any small nonzero value.
- Action overruns are disabled.

Figure 95: Synchronous output trigger

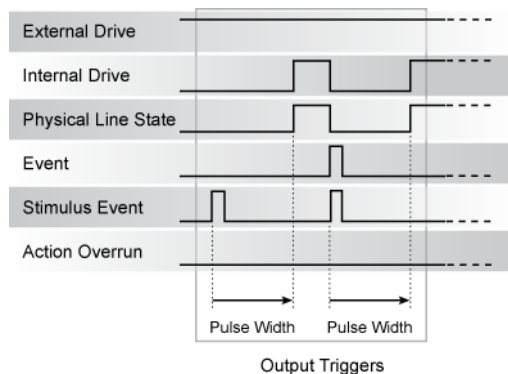

Digital I/O

The 2601B-PULSE has a digital input/output port that can be used to control external digital circuitry. For example, you can use a handler that is used to perform binning operations with a digital I/O port.

Port configuration

The digital I/O port, a standard female DB-25 connector (shown below), is on the rear panel.

Figure 96: Digital I/O port pin assignments

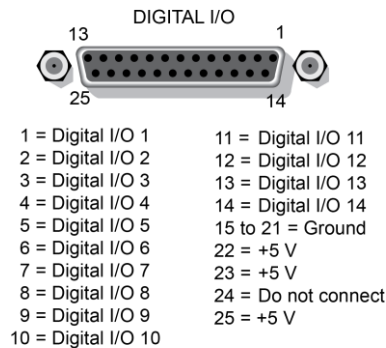

NOTE

For a schematic diagram of the digital I/O hardware, refer to [Digital I/O configuration](#). (on page 6-37)

NOTE

For information on using the digital I/O port as part of an interlock setup, refer to [Using the interlock](#) (on page 2-42).

Connecting cables for Trigger Link

Use a cable equipped with a male DB-25 connector (Keithley Instruments part number CA-126-1A; L-com part number CSMN25MF-5) to connect the digital I/O port to other Keithley Instruments models equipped with a Trigger Link (TLINK).

Digital I/O lines

The port provides 14 digital I/O lines. Each output is set high (+5 V) or low (0 V) and can read high or low logic levels. Each digital I/O line is an open-drain signal.

+5 V output

The digital I/O port provides three +5 V dc output lines that you can use to drive external logic circuitry. Maximum combined current output for all lines is 250 mA. These lines are protected by a self-resetting fuse with a one hour recovery time.

Digital I/O configuration

The following figure shows the basic configuration of the digital I/O port. Writing a 1 to a line sets that line high ($\sim +5$ V). Writing a 0 to a line sets that line low (~ 0 V). Note that an external device pulls an I/O line low by shorting it to ground, so that a device must be able to sink at least $960 \mu\text{A}$ per I/O line.

Figure 97: Digital I/O interface schematic

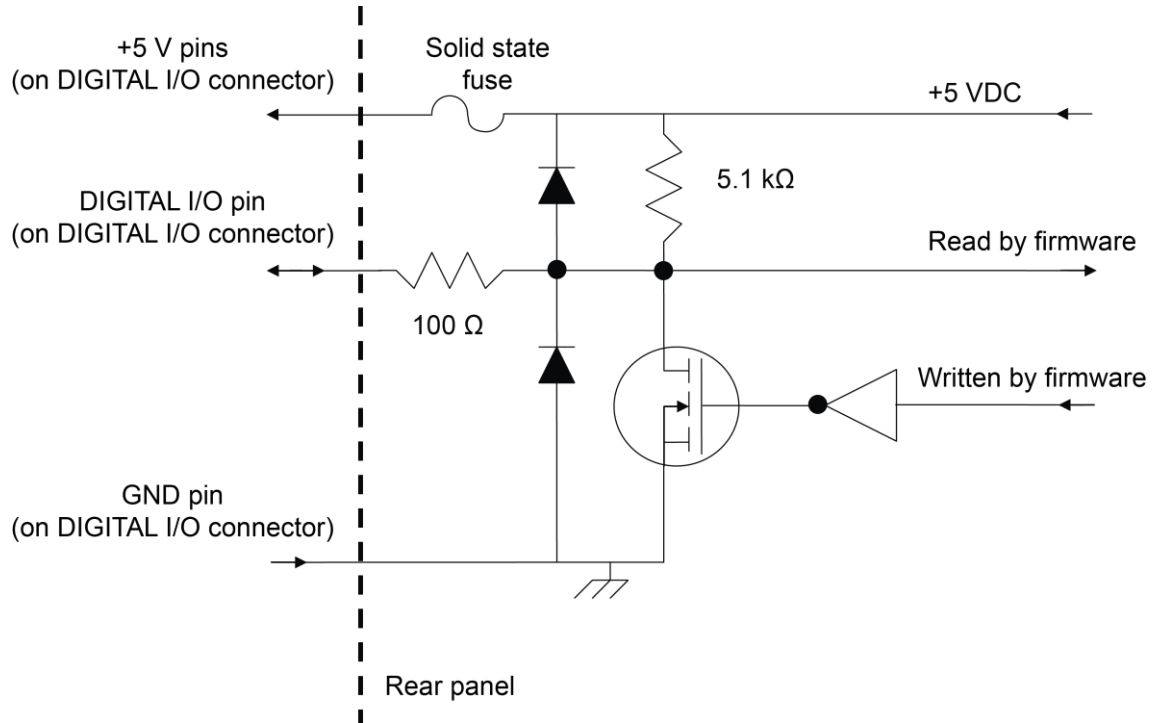



Controlling digital I/O lines

Although the digital I/O lines are primarily intended for use with a device handler for limit testing, they can also be used for other purposes, such as controlling external logic circuits. You can control lines either from the front panel or over a remote interface.

To set digital I/O values from the front panel:

1. Press the **MENU** key, select **DIGOUT**, and then press the **ENTER** key or press the navigation wheel \odot .
2. Select **DIG-IO-OUTPUT**, and then press the **ENTER** key or the navigation wheel \odot .
3. Set the decimal value as required to set digital I/O lines in the range of 0 to 16,383 (see the table in [Digital I/O bit weighting](#) (on page 6-38)), and then press the **ENTER** key or the navigation wheel \odot .
For example, to set digital I/O lines 3 and 8, set the value to 132.
4. Press the **EXIT (LOCAL)** key as needed to return to the main menu.

To write-protect specific digital I/O lines to prevent their values from being changed:

1. Press the **MENU** key, then select **DIGOUT**, and then press the **ENTER** key or the navigation wheel .
 2. Select **WRITE-PROTECT**, and then press the **ENTER** key or the navigation wheel .
 3. Set the decimal value as required to write-protect digital I/O lines within the range of 0 to 16,383 (see [Digital I/O bit weighting](#) (on page 6-38)), and then press the **ENTER** key or the navigation wheel .
- For example, to write-protect digital I/O lines 4 and 10, set the value to 520.
4. Press the **EXIT (LOCAL)** key as needed to return to the main menu.

To remove write protection, reset the decimal value to include only the lines that you want to write protect. To remove write protection from all lines, set the value to 0.

Digital I/O bit weighting

Bit weighting for the digital I/O lines is shown in the following table.

Digital bit weight

Line #	Bit	Decimal weighting	Hexadecimal weighting
1	B1	1	0x0001
2	B2	2	0x0002
3	B3	4	0x0004
4	B4	8	0x0008
5	B5	16	0x0010
6	B6	32	0x0020
7	B7	64	0x0040
8	B8	128	0x0080
9	B9	256	0x0100
10	B10	512	0x0200
11	B11	1,024	0x0400
12	B12	2,048	0x0800
13	B13	4,096	0x1000
14	B14	8,192	0x2000

Remote digital I/O commands

Commands that control and access the digital I/O port are summarized in the following table. See the [TSP command reference](#) (on page 11-1) for complete details on these commands. See the following table for decimal and hexadecimal values used to control and access the digital I/O port and individual lines. Use these commands to trigger the 2601B-PULSE using external trigger pulses applied to the digital I/O port, or to provide trigger pulses to external devices.

Use these commands to perform basic steady-state digital I/O operations such as reading and writing to individual I/O lines or reading and writing to the entire port.

NOTE

The digital I/O lines can be used for both input and output. You must write a 1 to all digital I/O lines that are to be used as inputs.

Remote digital I/O commands

Command	Description
<code>digio.readbit(<i>bit</i>)</code>	Read one digital I/O input line
<code>digio.readport()</code>	Read digital I/O port
<code>digio.writebit(<i>bit</i>, <i>data</i>)</code>	Write data to one digital I/O output line
<code>digio.writeport(<i>data</i>)</code>	Write data to digital I/O port
<code>digio.writeprotect = <i>mask</i></code>	Write protect mask to digital I/O port

Digital I/O programming example

The programming commands below illustrate how to set bit B1 of the digital I/O port high, and then read the entire port value.

```
digio.trigger[1].mode = digio.TRIG_BYPASS
-- Set Bit B1 high.
digio.writebit(1,1)
-- Read digital I/O port.
data = digio.readport()
```

TSP-Link trigger lines

The 2601B-PULSE has three trigger lines that you can use for triggering, digital I/O, and to synchronize multiple instruments on a TSP-Link® network.

Connecting to the TSP-Link system

The TSP-Link® trigger lines are built into the TSP-Link connection. Use the TSP-Link connectors on the back of the 2601B-PULSE. If you are using a TSP-Link network, you do not have to modify any connections. See [TSP-Link system expansion interface](#) (on page 10-45) for detailed information about connecting to the TSP-Link system.

Using TSP-Link trigger lines for digital I/O

Each trigger line is an open-drain signal. When using the TSP-Link® trigger lines for digital I/O, any node that sets the programmed line state to zero (0) causes all nodes to read 0 from the line state. This occurs regardless of the programmed line state of any other node. Refer to the table in the [Digital I/O bit weighting](#) (on page 6-38) topic for digital bit weight values.

Remote TSP-Link trigger line commands

Commands that control and access the TSP-Link® trigger line port are summarized in the following table. See the [TSP command reference](#) (on page 11-1) for complete details on these commands. See the table in [Digital I/O bit weighting](#) (on page 6-38) for the decimal and hexadecimal values used to control and access the digital I/O port and individual lines.

Use the commands in following table to perform basic steady-state digital I/O operations; for example, you can program the 2601B-PULSE to read and write to a specific TSP-Link trigger line or to the entire port.

NOTE

The TSP-Link trigger lines can be used for both input and output. You must write a 1 to all TSP-Link trigger lines that are used as inputs.

Remote trigger line commands

Command	Description
<code>tsplink.readbit(<i>bit</i>)</code>	Reads one digital I/O input line.
<code>tsplink.readport()</code>	Reads the digital I/O port.
<code>tsplink.writebit(<i>bit</i>, <i>data</i>)</code>	Writes data to one digital I/O line.
<code>tsplink.writeport(<i>data</i>)</code>	Writes data to the digital I/O port.
<code>tsplink.writeprotect = <i>mask</i></code>	Sets write-protect mask of the digital I/O port.

Programming example

The programming example below illustrates how to set bit B1 of the TSP-Link digital I/O port high, and then read the entire port value:

```
tsplink.trigger[1].mode = tsplink.TRIG_BYPASS
-- Set bit B1 high.
tsplink.writebit(1, 1)
-- Read I/O port.
data = tsplink.readport()
```

Theory of operation

In this section:

Analog-to-digital converters.....	7-1
Source-measure concepts	7-1
Measurement settling time considerations	7-26
Effects of load on current source settling time.....	7-27
Creating pulses with the 2601B-PULSE SMU.....	7-28

Analog-to-digital converters

The 2601B-PULSE uses analog-to-digital converters (ADCs) in the SMU and pulser circuits.

The SMU circuit uses two integrating ADCs. The integrating ADCs use a ratiometric analog-to-digital conversion technique. Depending on the configuration of the integrating ADCs, periodic fresh reference measurements are required to minimize drift. The measurement aperture is used to determine the time interval between these measurement updates. For additional information, see [Autozero](#) (on page 4-41). To optimize operation of these ADCs, the instrument caches the reference and zero values for the ten most recent power-line cycles. For additional information, see [NPLC caching](#) (on page 4-42).

When the pulser is enabled, the 2601B-PULSE uses two high-speed analog-to-digital converters that sample simultaneously. The measurement aperture determines how many individually sampled results are averaged to produce the requested reading. These ADCs do not use the autozero function.

Source-measure concepts

This section provides detailed information about source-measure concepts, including:

- [Limit principles](#) (on page 7-2)
- [Power equations](#) (on page 7-2)
- [Reading limits for the 1 MS/s sample rate](#) (on page 7-5)
- [Operating boundaries](#) (on page 7-6)
- [Basic circuit configurations](#) (on page 7-19)
- [Guard](#) (on page 7-24)

Limit principles

A limit acts as a clamp. If the output reaches the limit value, the 2601B-PULSE SMU attempts to prevent the output from exceeding that value. This action switches the source from a voltage source to a current source (or from a current source to a voltage source) when a limit is reached.

As an example, assume the following:

- 2601B-PULSE instrument: $V_{\text{SRC}} = 10 \text{ V}$; $I_{\text{LIMIT}} = 10 \text{ mA}$
- Device-under-test (DUT) resistance: 10Ω

With a source voltage of 10 V and a DUT resistance of 10Ω , the current through the DUT should be $10 \text{ V} / 10 \Omega = 1 \text{ A}$. However, because the limit is set to 10 mA, the current will not exceed that value, and the voltage across the resistance is limited to 100 mV. In effect, the 10 V voltage source is transformed into a 10 mA current source.

The 2601B-PULSE SMU output does not exceed the compliance limit, except for the compliance limit conditions described in [Source-measure capabilities](#) (on page 4-1).

Power equations

Proper ventilation is required to keep the 2601B-PULSE from overheating. Even with proper ventilation, the instrument can overheat if the ambient temperature is too high or the 2601B-PULSE is operated in sink mode for long periods. The instrument has an overtemperature protection circuit that turns the output off if the instrument overheats. When the overtemperature protection circuit turns the output off, a message indicating this condition is displayed. You cannot turn the output on until the instrument cools down.

Duty cycle with the pulser disabled

When the pulser is disabled, overheating can occur if the instrument exceeds the maximum duty cycle. Factors such as ambient temperature, quadrant of operation, and high-power pulse levels affect the maximum duty cycle. Exceeding the calculated maximum duty cycle may cause the temperature-protection mechanism to engage. When this happens, an error message displays and the instrument output is disabled until the internal temperature of the instrument is reduced to an acceptable level.

You do not have to be concerned about overheating if the following are true:

- The instrument is used as a power source and not a power sink.
- The ambient temperature is $\leq 30 \text{ }^\circ\text{C}$.
- Pulsing is not occurring in the extended operating area (EOA).

To calculate the maximum duty cycle (DC_{MAX}), use the general power equation shown below. The general power equation describes how much power an instrument can source and sink before the total power cannot be fully dissipated by the cooling system of the instrument. This equation incorporates all the factors that can influence the power dissipated by the instrument.

$$|(V_{OA} - V_P)(I_P)|\sqrt{DC_{MAX}} + |(V_{OA} - V_B)(I_B)| \leq (P_{CS} - P_{DER})$$

- V_{OA} The instrument output amplifier voltage. This constant can be found in the table below.
- V_P The voltage level the instrument is attempting to force while at the pulse level.
When operating in quadrants 1 or 3 (sourcing power), the sign of this voltage must be positive when used in the power equations.
When operating in quadrants 2 or 4 (sinking power), the sign of this voltage must be negative when used in the power equations.
- I_P The current flowing through the instrument channel while at the pulse level.
- V_B The voltage level the instrument is attempting to force while at the bias level.
When operating in quadrants 1 or 3 (sourcing power), the sign of this voltage must be positive when used in the power equations.
When operating in quadrants 2 or 4 (sinking power), the sign of this voltage must be negative when used in the power equations.
- I_B The current flowing through the instrument channel while at the bias level.
- P_{CS} The maximum power generated in an instrument channel that can be properly dissipated by the instrument cooling system measured in watts. For the 2601B-PULSE, this constant equals 56.
- $P_{DER} = T_{AMB} - 30$
This factor represents the number of watts the instrument is derated when operating in environments above 30 °C. The maximum output power is reduced by 1 W per degree C above 30 °C.
 P_{DER} is 0 when the ambient temperature is below 30 °C.
- T_{AMB} The ambient temperature of the instrument operating environment.

The following equation applies to sinking and sourcing power simultaneously. If a duty cycle less than 100% is required to avoid overheating, the maximum on-time must be less than 10 seconds.

$$DC_{MAX} \leq \left[\frac{(P_{CS} - P_{DER}) - |(V_{OA} - V_B)(I_B)|}{|(V_{OA} - V_P)(I_P)|} \right]^2 \times 100$$

NOTE

When attempting to determine the maximum duty cycle, where the off state will be 0 V or 0 A:

- I_B is 0
- I_P and V_P are the current and voltage levels when the instrument is on

Maximum duty cycle equation constants

Constant	100 mV range	1 V range	6 V range	40 V range
V_{OA}	18	18	18	55

Duty cycle with the pulser enabled

When the pulser is enabled, the instrument limits the duty cycle using the formula shown below. If a trigger model attempts to exceed this duty cycle, the output is turned off and an error is generated. To avoid this, use the following formula to calculate the maximum allowed duty cycle for your pulser operating conditions.

$$\frac{0.3125 - |I_{BIAS}|}{|I_{PULSE}| - |I_{BIAS}|} * 100\%$$

Figure 98: Pulser enabled duty cycle for a current bias less than or equal to 10 mA

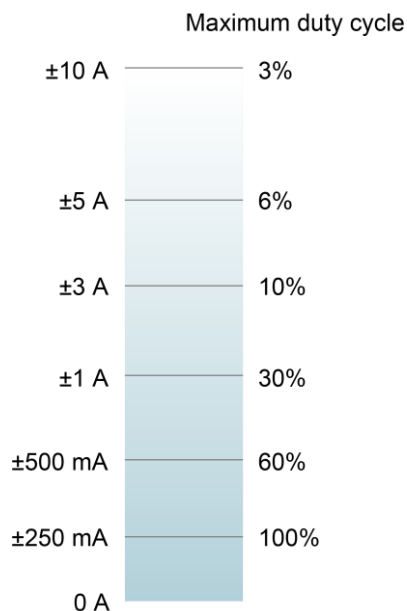

Pulser power limit and maximum power duty cycle equations

When the pulser is enabled and the instrument is operating at an elevated temperature or in sinking conditions, the duty cycle may be limited further than the values given above. You can use the following equation to calculate the maximum duty cycle.

$$DC_{MAX} = \frac{36 \text{ W} - P_D - |(120 \text{ V} - V_{BIAS})(I_{BIAS})|}{|(120 \text{ V} - V_{PULSE})(I_{PULSE})| - |(120 \text{ V} - V_{BIAS})(I_{BIAS})|} * 100\%$$

The extended maximum duty cycle equation is:

$$|(120 \text{ V} - V_{PULSE})(I_{PULSE})| \cdot DC + |(120 \text{ V} - V_{PULSE})(I_{PULSE})| \cdot (1 - DC) \leq 35 \text{ W} - P_D$$

In both equations, P_D is 1.5 W per °C above 28 °C when the instrument is operating in environments above 28 °C. DC is the duty cycle.

Optimizing apertures and filters for the 1 MS/s sample rate

When the pulser is enabled, a measurement request or measurement trigger generates a burst of readings. Each burst is equal to the measure count times the filter count. A burst is limited to a maximum of 3500 readings. The maximum is determined by the size of the hardware buffer that stores data before it is processed and stored in the reading buffer.

Once the burst is acquired, data needs to move from the hardware buffer into the reading buffer. When the instrument generates fast pulses or fast measurements, it can get into a situation where it cannot keep up with both the pulses and the measurements. If the instrument cannot maintain the pulse rate, an error is generated that indicates that the pulse data rate was exceeded. If measurements cannot be moved out of the hardware buffer before they fill up, an error is generated that indicates that the measurement rate was exceeded. If you are trying to generate fast pulses at a high measurement rate, either of these errors can occur.

Apertures and filters

To make a measurement with a given aperture, multiple conversions are averaged together to make one reading.

The filter for the pulser is a repeating-average filter and is applied when the reading moves from the hardware buffer to the reading buffer. The instrument waits to process the final reading until the number of readings specified by the filter count are made.

For example, if the aperture is 10 μs and the filter count is five, 10 conversions from the 1 MS/s ADC are averaged and sent to the hardware buffer as one ADC reading. This collection of 10 conversions per aperture happens five times. When five readings have occurred, they are averaged by the filter and one averaged measurement is stored in the reading buffer as a final measurement. In this example, the final measurement contains 50 μs of averaged measurement data.

You can achieve the same results if you set the aperture to 50 μs and set the filter count to 1, or if you set the aperture to 1 μs with a filter count of 50. The only difference in the three settings is the number of entries in the burst and how much of the hardware buffer space is used:

- Aperture = 1, filter = 50: The burst count is 50
- Aperture = 10, filter = 5: The burst count is 5
- Aperture = 50, filter = 1: the burst count is 1

Any one of these puts one reading into the reading buffer. Using the aperture setting instead of the filter setting can reduce the amount of space in the hardware buffers needed for a burst.

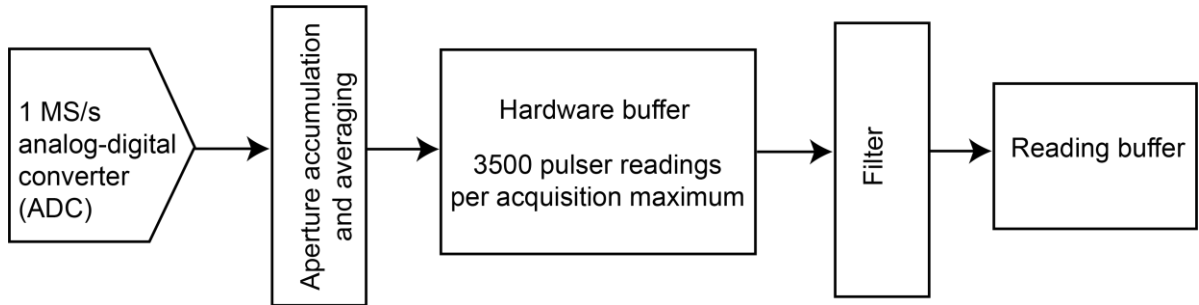
Figure 99: Data acquisition to reading buffer flow

Operating boundaries

Source or sink

Depending on how it is programmed and what is connected to the output (load or source), the instrument can operate in any of the four quadrants. The four quadrants of operation are shown in the continuous operating boundaries figures. When operating in the first (I) or third (III) quadrant, the instrument is operating as a source (V and I have the same polarity). As a source, the instrument is delivering power to a load.

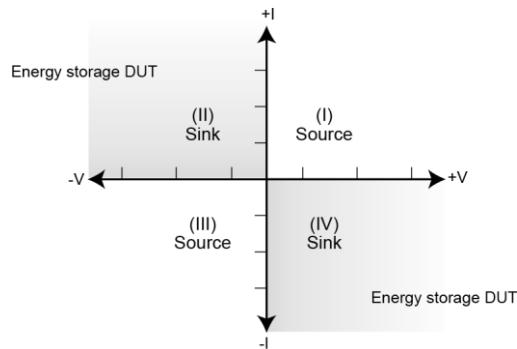
Figure 100: Four quadrants of operation

When operating in the second (II) or fourth (IV) quadrant, the instrument is operating as a sink (V and I have opposite polarity). As a sink, it is dissipating power rather than sourcing it. An external source or an energy storage device, such as a capacitor or battery, can force operation in the sink region.

Continuous power operating boundaries

The general operating boundaries for continuous power output are shown in the following figure (for derating factors, see [General power and maximum duty cycle equations](#) (on page 7-2)). In this drawing, the current (600 mA, 1 A, 2.2 A, and 3 A) and the voltage (6 V and 40 V) magnitudes are nominal values.

NOTE

The boundaries are not drawn to scale.

Figure 101: Continuous power operating boundaries when the pulser is disabled

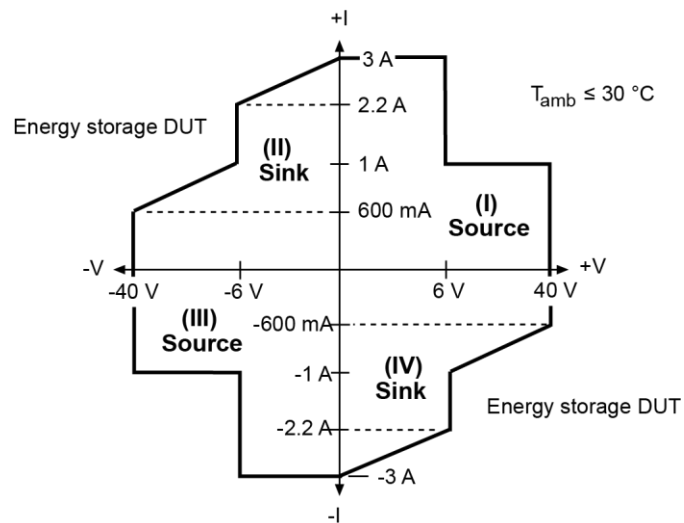

Operation as a sink

When the 2601B-PULSE is operating in the second quadrant or fourth quadrant, the SMU operates as a load that sinks and dissipates power internally. The ability of the SMU to dissipate power is defined by the boundaries shown in the previous figure. When the SMU is operating in the second or fourth quadrant, the DUT is a power source (such as a battery, solar cell, or a power supply).

CAUTION

Use care when connecting a source to the 2601B-PULSE that can exceed the voltage or current limit. Using the 2601B-PULSE to sink more than 3 A dc can damage the instrument and invalidate your warranty.

Voltage source operating boundaries

The following figure shows the operating boundaries for the V-source when the pulser is disabled. Only the first quadrant of operation is shown. Operation in the other three quadrants is similar.

The following graph shows the output characteristics for the V-source. As shown, the 2601B-PULSE can output up to 6.06 V at 3 A, or 40.4 V at 1 A. Note that when sourcing more than 6.06 V, current is limited to 1 A.

Figure 102: Output characteristics

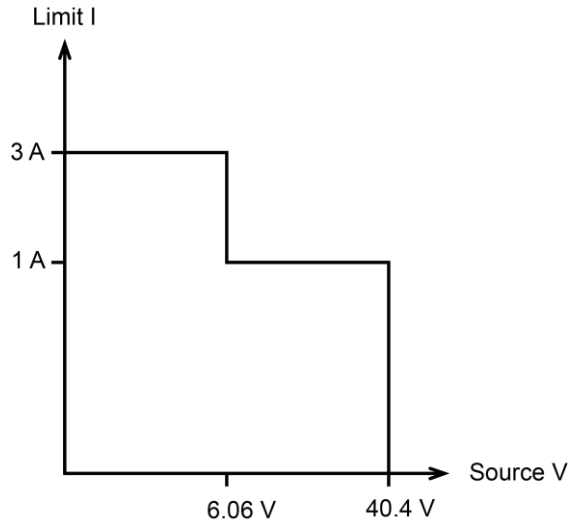

The following graph shows the limit lines for the V-source. The voltage source limit line represents the maximum source value possible for the presently selected voltage source range. For example, if you are using the 6 V source range, the voltage source limit line is at 6.3 V. The current compliance limit line represents the actual compliance in effect (see [Compliance limit principles](#) (on page 7-2)). These limit lines are boundaries that represent the operating limits of the instrument for this quadrant of operation. The operating point can be anywhere inside (or on) these limit lines. The limit line boundaries for the other quadrants are similar.

Figure 103: Limit lines

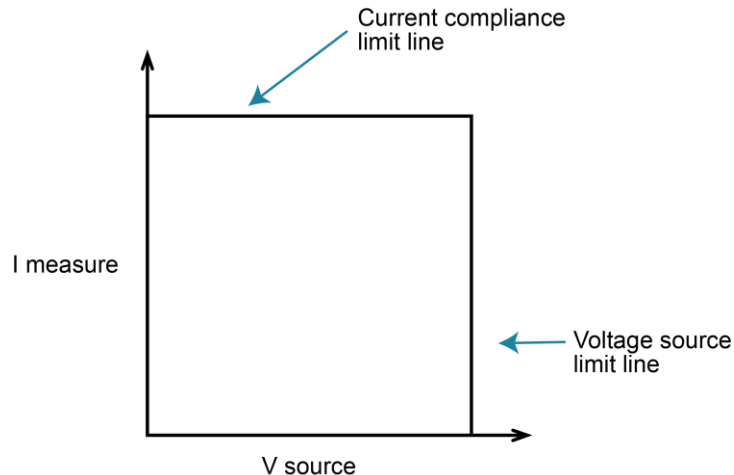

Load considerations for voltage source

The boundaries within which the 2601B-PULSE operates depend on the load of the device-under-test (DUT) that is connected to the output. The following topics show operation examples for resistive loads that are 2 kΩ and 800 Ω, respectively. For these examples, the 2601B-PULSE is programmed to source 10 V and limit current (10 mA). In addition, the 2601B-PULSE is programmed to limit power (60 mW) for the [Normal voltage source operation](#) (on page 7-9) example and the [Voltage source operation in power compliance](#) (on page 7-10) example.

Normal voltage source operation

In the following figure, the 2601B-PULSE is sourcing 10 V to the 2 kΩ load and subsequently measures 5 mA. The instrument is programmed to limit power (60 mW). As shown, the load line for 2 kΩ intersects the 10 V voltage source line at 5 mA. The current compliance limit and the power compliance limit are not reached, so the instrument is not limited through its compliance settings.

Figure 104: Normal voltage source operation

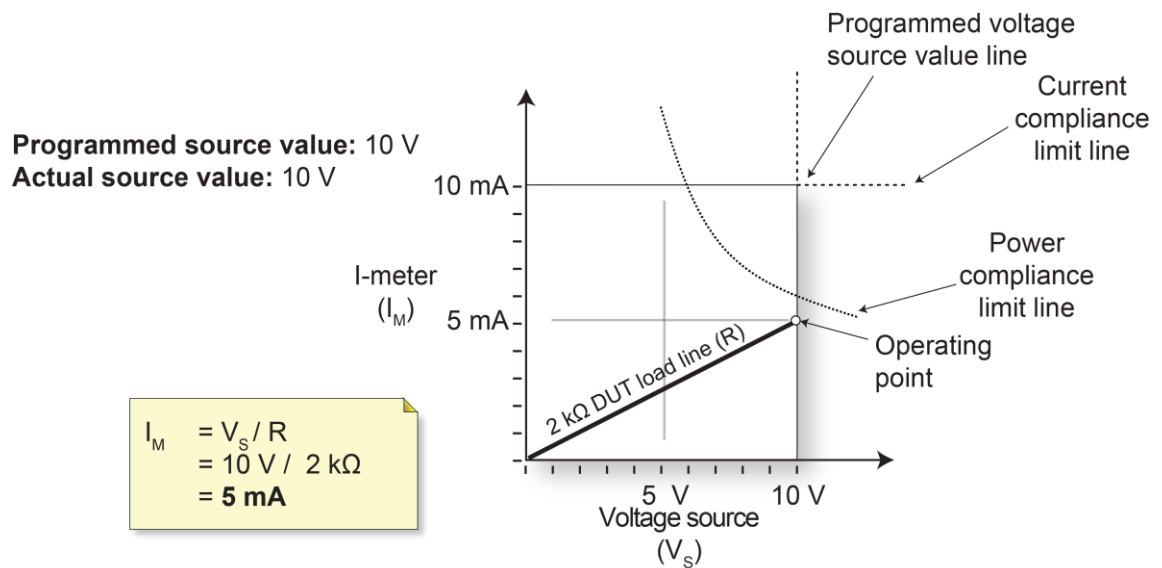

Voltage source operation in current compliance

In the following figure, the resistance of the load is decreased to 800 Ω. The DUT load line for 800 Ω intersects the current compliance limit line, placing the 2601B-PULSE in compliance. When it is in compliance, the 2601B-PULSE cannot source its programmed voltage (10 V). For the 800 Ω DUT, the 2601B-PULSE only outputs 8 V (at the 10 mA limit).

Notice that as resistance decreases, the slope of the DUT load line increases. At zero resistance (shorted output), the 2601B-PULSE sources virtually 0 V at 10 mA. Conversely, as resistance increases, the slope of the DUT load line decreases. As resistance approaches infinity (open output), the 2601B-PULSE sources virtually 10 V at 0 mA.

Figure 105: Voltage source operation in current compliance

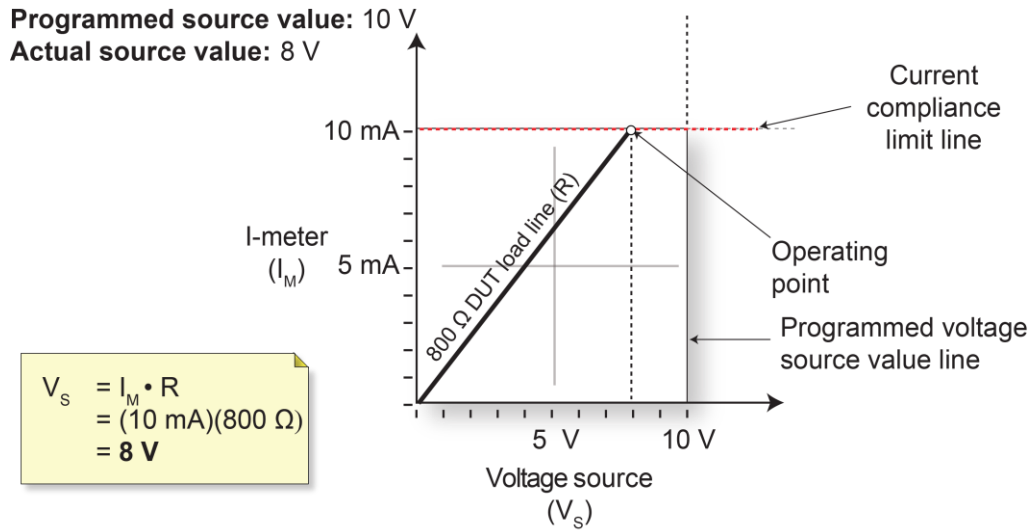

Voltage source operation in power compliance

The figure below shows what happens if a power limit of 60 mW is applied. As the instrument attempts to output the programmed source value of 10 V, the power compliance limit line is reached, placing the 2601B-PULSE in power compliance. The 2601B-PULSE enforces the power compliance limit by setting the current compliance limit line to the new power limited current compliance limit line setting, which in this case is 8.66 mA. In compliance, the 2601B-PULSE cannot source its programmed voltage (10 V). For the 800 Ω DUT, the 2601B-PULSE only outputs 6.928 V (at the 60 mW limit). In this example, current never exceeds the programmed compliance of 10 mA, or the programmed power compliance of 60 mW, under any load.

Figure 106: Voltage source operation in power compliance

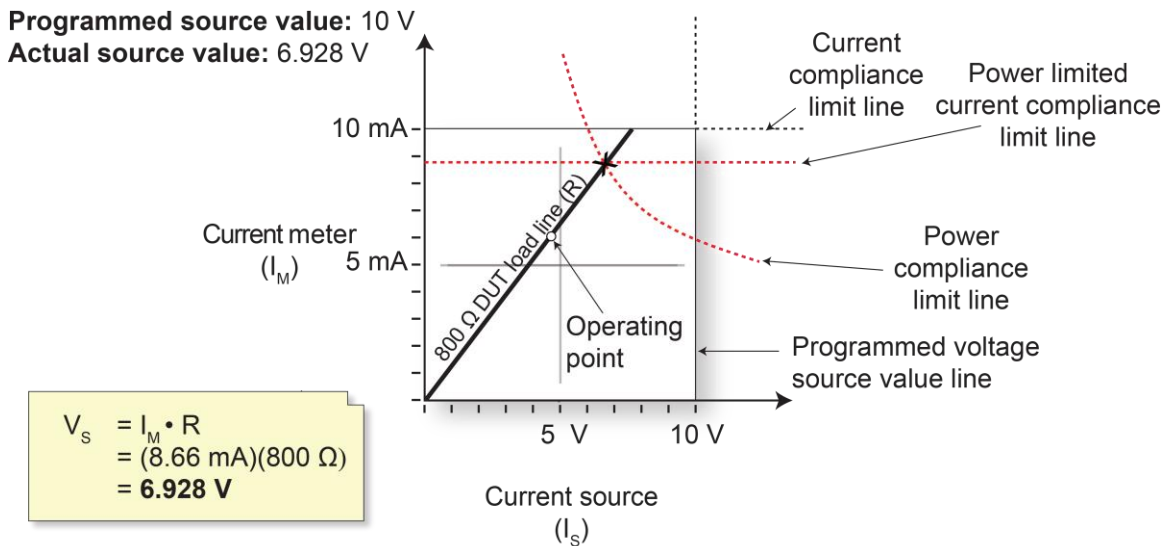

Voltage source sweep operation in current and power compliance

The following figure shows a voltage sweep on a resistive load of 800 Ω. For this example, the 2601B-PULSE is programmed to sweep voltage to 10 V, limit current (6 mA) and limit power (50 mW). When sweeping, the actual source output varies according to the programmed source value until the current limit is reached. As the figure shows, the output sources the programmed value until placed in current compliance at the 6 mA limit. The sweep then continues. Programmed current source values increase along the green sweep points line, but the output remains at the value it was at when the instrument went into voltage compliance. This continues until the programmed source value sweeps to a high enough level that the power limit line is reached (50 mW). At this point, the current and voltage start to decrease, lowering the current and voltage values along the DUT load line. When the last point is swept (10 V), the actual output is 10 V (at 5 mA).

Figure 107: Programmed voltage source sweep operation in current and power compliance

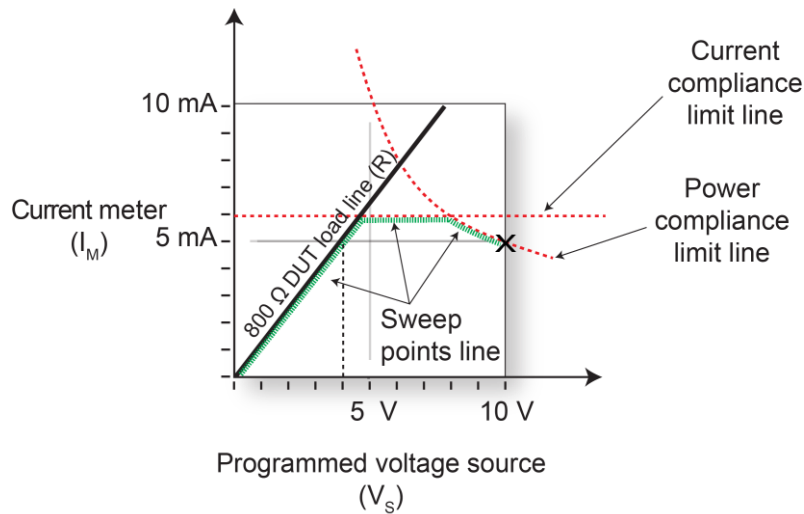

V-source sink operating boundaries

The quadrant within which the 2601B-PULSE operates depends on the device-under-test (DUT) that is connected to the 2601B-PULSE output. The following example illustrates this operation using the 2601B-PULSE configured as a voltage source to discharge a 12 V power source (a battery).

Figure 108: Sourcing voltage while sinking current

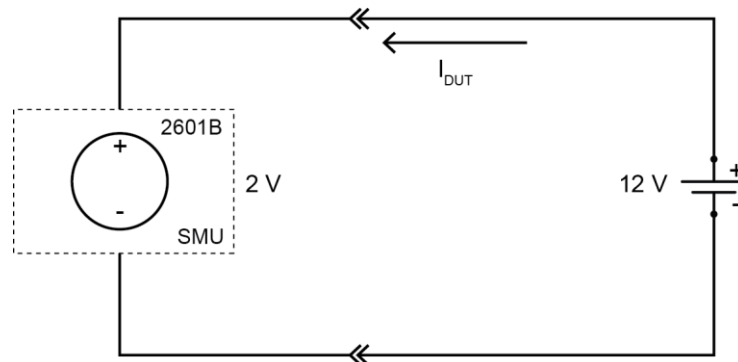

NOTE

The current compliance limit applies both to positive and negative currents. For example, if you set the current compliance limit to 50 mA, the current limit applies to ± 50 mA.

For this example, the 2601B-PULSE is programmed to source 2 V and to limit current to 50 mA. When the SMU turns on, the battery voltage is higher than the programmed voltage source value. Since the SMU is unable to deliver the programmed voltage, the SMU is placed in current compliance and begins to sink current. Sink operation continues until the battery voltage equals the programmed voltage source level and the current in the circuit drops to nearly 0 A.

In the following figure, as the battery drains, the battery voltage is lowered (shown by the green arrow in the figure). Operation will continue in this direction until the SMU is able to deliver the programmed voltage source value.

NOTE

Since the battery is a power source, initial operation can occur anywhere along the initial battery voltage line. This voltage is only limited by the capability of the battery (see the following figure).

Figure 109: Considerations when sourcing voltage and sinking power

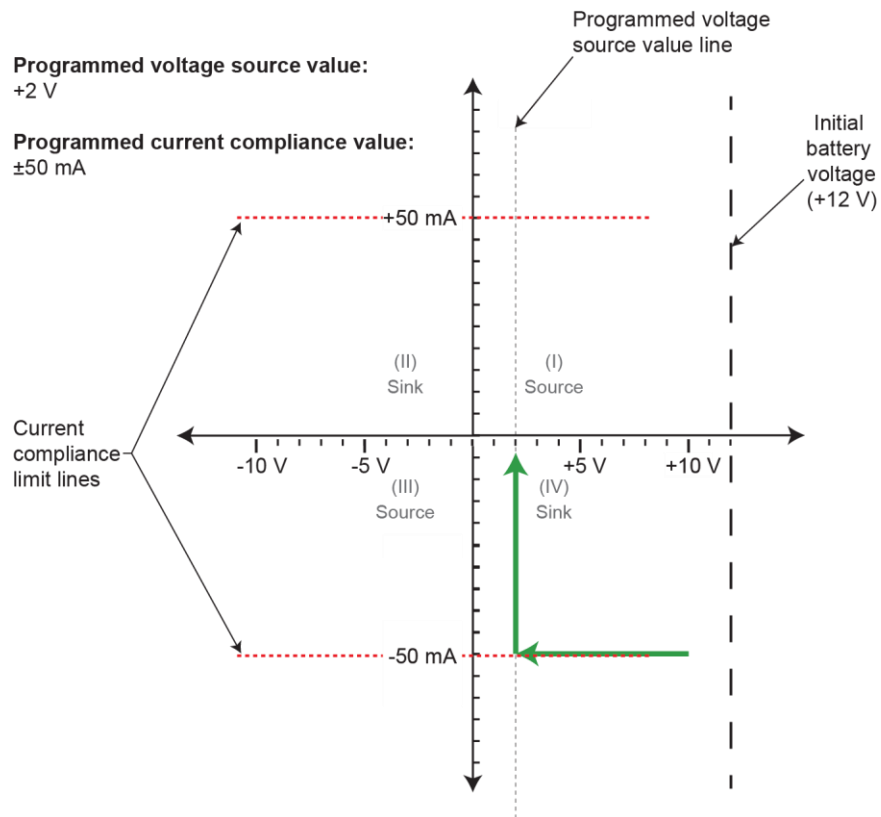

Source-measure capabilities

The following table lists the source and measure limits for the voltage and current functions.

The maximum power is 40.4 W per channel.

Source-measure capabilities

Voltage range	Source	Measure
100 mV	±101 mV	±102 mV
1 V	±1.01 V	±1.02 V
6 V	±6.06 V	±6.12 V
40 V	±40.4 V	±40.8 V
Current ranges		
100 nA	±101 nA	±102 nA
1 µA	±1.01 µA	±1.02 µA
10 µA	±10.1 µA	±10.2 µA
100 µA	±101 µA	±102 µA
1 mA	±1.01 mA	±1.02 mA
10 mA	±10.1 mA	±10.2 mA
100 mA	±101 mA	±102 mA
1 A	±1.01 A	±1.02 A
3 A	±3.03 A	±3.06 A
10 A (only available in pulse mode)	±10.1 A	±10 A

Pulser capabilities

The following table lists the pulser voltage and current ranges.

Voltage range	Source	Measure
5 V	Not applicable	5.1 V
10 V	Not applicable	10.2 V
Current ranges		
1 A	±1.01 A	±1.02 A
5 A	±5.05 A	±5.1 A
10 A	±10.1 A	±10.2 A
250 mA (DC bias)	±250 mA	Selected pulse measure range

The 2601B-PULSE can sustain a measurement speed of 33,000, as determined by:

$$(\text{Pulse rate per second}) + (\text{Measurements per second} \times \text{Filter count}) < 33000$$

If this rate is exceeded, the instrument may not be able to sustain the sweep.

Current source operating boundaries

The following figures show the operating boundaries for the current source when the pulser is disabled. Only the first quadrant of operation is shown; operation in the other quadrants is similar.

The first figure shows the output characteristics for the current source. As shown, the 2601B-PULSE can output up to 1.01 A at 20 V or 3.03 A at 6 V. Note that when sourcing more than 1.01 A, voltage is limited to 6 V.

Figure 110: I-source output characteristics

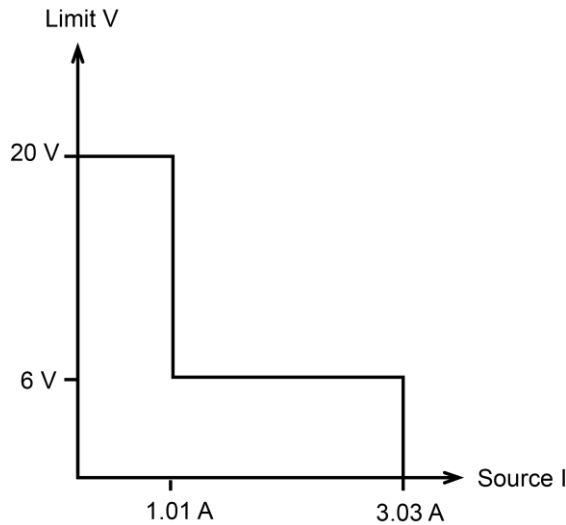

The following figure shows the limit lines for the I-source. The current source limit line represents the maximum source value possible for the presently selected current source range. The voltage compliance limit line represents the actual compliance that is in effect (see [Limits](#) (on page 4-2)). These limit lines are boundaries that represent the operating limits of the instrument for this quadrant of operation. The operating point can be anywhere inside (or on) these limit lines. The limit line boundaries for the other quadrants is similar.

Figure 111: I-source limit lines

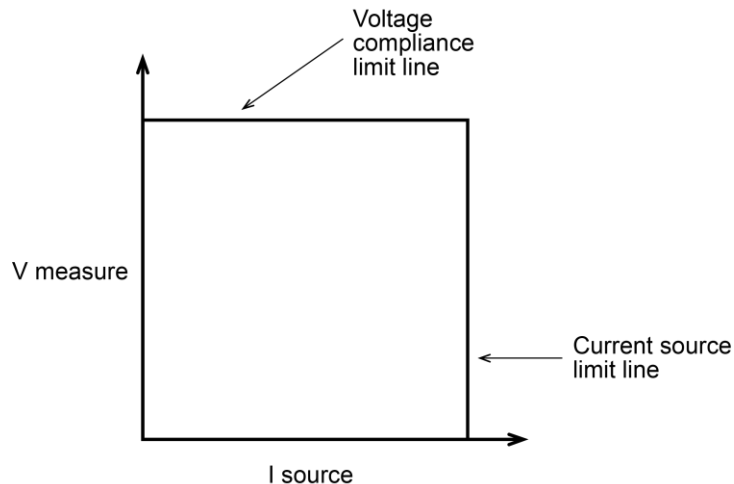

Load considerations for current source

The boundaries within which the 2601B-PULSE operates depend on the load (device-under-test (DUT)) that is connected to its output. The following topics show operation examples for resistive loads that are 50 Ω and 200 Ω, respectively. For these examples, the 2601B-PULSE is programmed to source 100 mA and limit voltage (10 V). In addition, for normal current source operation and current source operation in power compliance, the 2601B-PULSE is programmed to limit power (600 mW).

Normal current source operation

In normal current source operation, the instrument is sourcing 100 mA to the 50 Ω load and subsequently measures 5 V. As shown in the following figure, the load line for 50 Ω intersects the 100 mA current source line at 5 V. The voltage compliance limit and the power compliance limit are not reached (the instrument is not limited through its compliance settings).

Figure 112: Normal current source operation

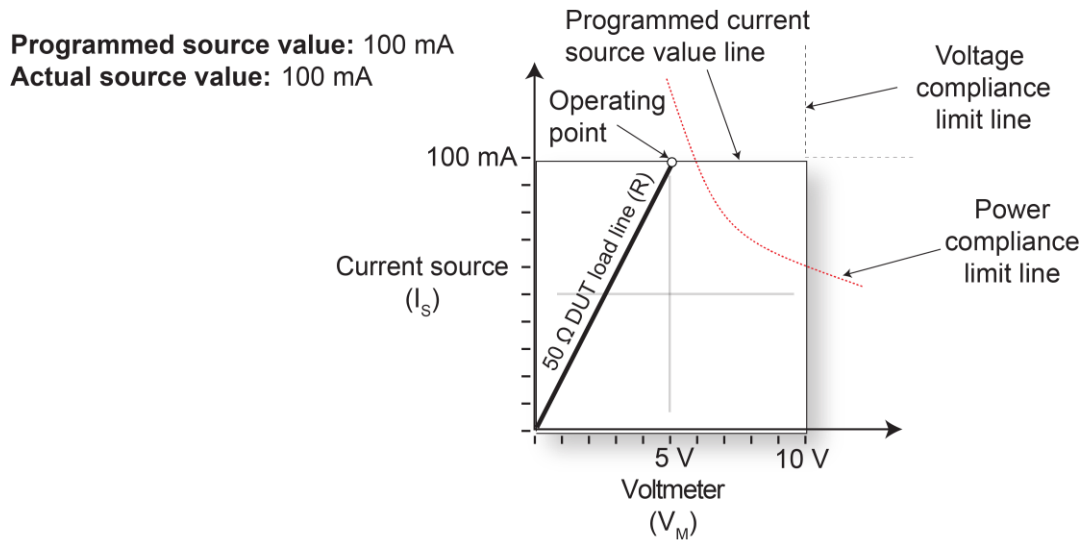

Current source operation in voltage compliance

The following figure shows what happens if the resistance of the load is increased to 200 Ω. The DUT load line for 200 Ω intersects the voltage compliance limit line, placing the instrument in voltage compliance. In voltage compliance, the instrument cannot source its programmed current (100 mA). For the 200 Ω DUT, the instrument only outputs 50 mA (at the 10 V limit).

As resistance increases, the slope of the DUT load line increases. As resistance increases and approaches infinity (open output), the 2601B-PULSE sources virtually 0 mA at 10 V. Conversely, as resistance decreases, the slope of the DUT load line decreases. At zero resistance (shorted output), the 2601B-PULSE sources 100 mA at virtually 0 V.

Figure 113: Current source operation in voltage compliance

Programmed source value: 100 mA
Actual source value: 50 mA

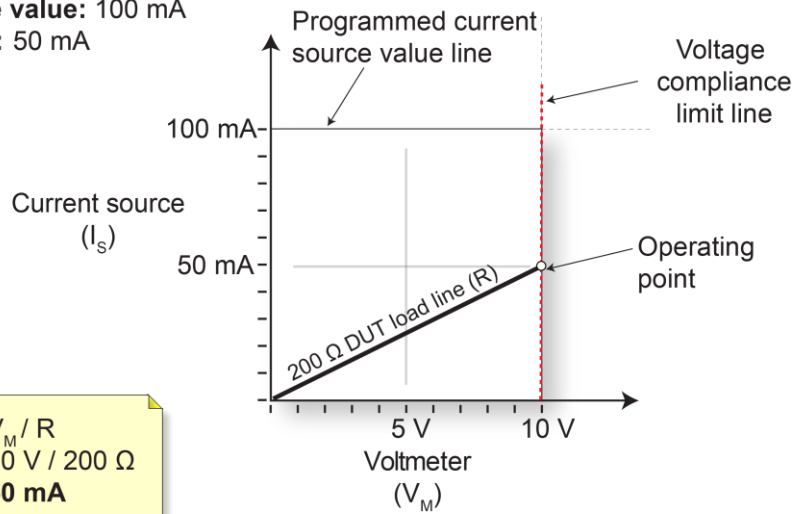

$$\begin{aligned}
 I_s &= V_M / R \\
 &= 10 \text{ V} / 200 \Omega \\
 &= 50 \text{ mA}
 \end{aligned}$$

Current source operation in power compliance

The following figure shows the results when a power limit of 600 mW is applied. As the instrument attempts to output the programmed source value of 100 mA, the power limited voltage compliance limit line is reached, placing the instrument in power compliance. The instrument enforces the power compliance limit by setting the voltage compliance limit line to the new power limited voltage compliance limit line setting (in this case, 6 V). In compliance, the instrument cannot source its programmed current (100 mA). For a 200 Ω DUT, the instrument only outputs 30 mA (at the 6 V limit). In this example, voltage will never exceed the programmed compliance of 10 V or the programmed power compliance of 600 mW under any load.

Figure 114: Current source operation in power compliance

Programmed source value: 100 mA
Actual source value: 30 mA

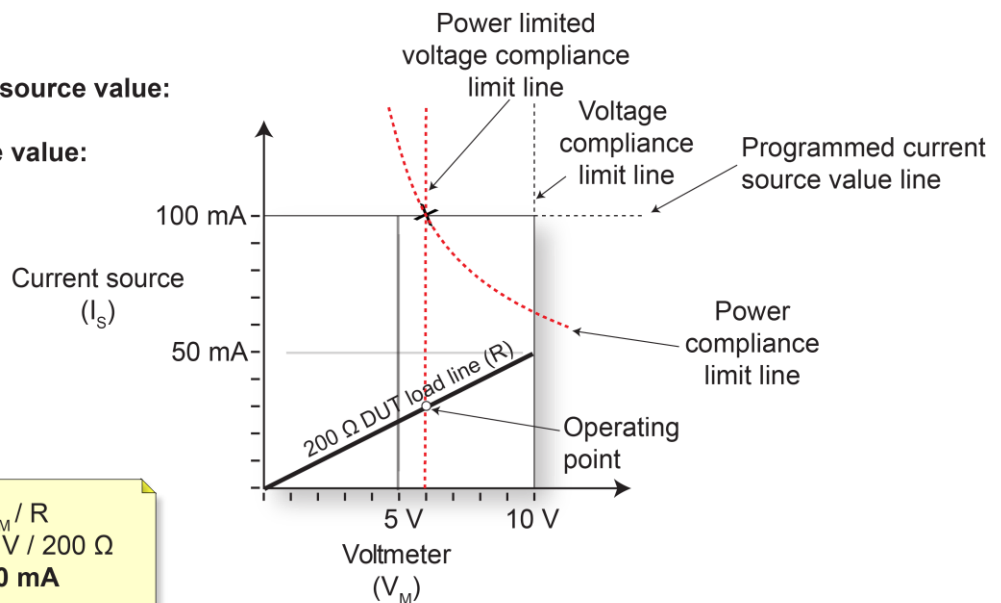

$$\begin{aligned}
 I_s &= V_M / R \\
 &= 6 \text{ V} / 200 \Omega \\
 &= 30 \text{ mA}
 \end{aligned}$$

The following figure shows a current sweep on a resistive load of $200\ \Omega$. For this example, the instrument is programmed to sweep current to $100\ \text{mA}$, limit voltage ($6\ \text{V}$), and limit power ($500\ \text{mW}$). When sweeping, the actual source output varies according to the programmed source value until the voltage limit is reached. As the figure shows, the output sources the programmed value until placed in voltage compliance at the $6\ \text{V}$ limit. The sweep then continues (programmed current source values increase along the green sweep points line), but the output remains at the same value as when the instrument went into voltage compliance. This continues until the programmed source value sweeps to a high enough level that the power limit line is reached ($500\ \text{mW}$). At this point, the voltage and the current start to decrease, lowering the current and voltage values along the DUT load line. When the last point is swept ($100\ \text{mA}$), the actual output is $25\ \text{mA}$ (at $5\ \text{V}$).

Figure 115: Current source sweep operation in voltage and power compliance

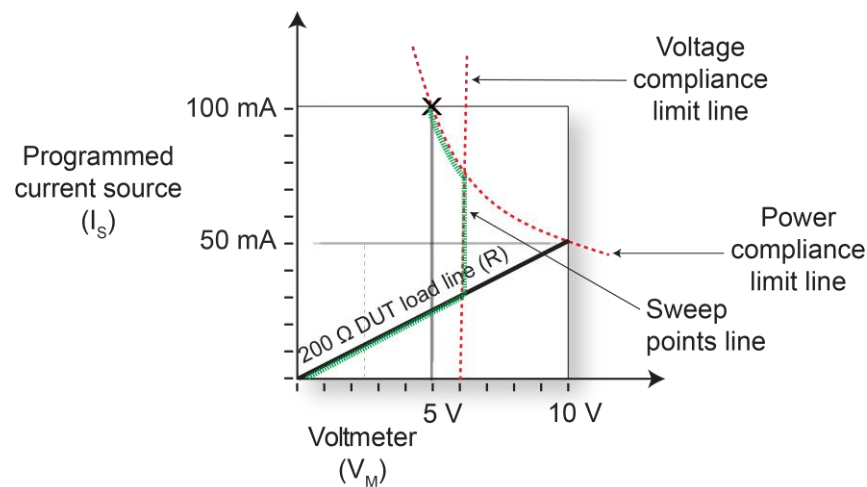

I-source sink operating boundaries

The quadrant within which the 2601B-PULSE operates depends on the device-under-test (DUT) connected to the 2601B-PULSE output. The following example illustrates this operation by using the 2601B-PULSE configured to provide a constant current to discharge a $12\ \text{V}$ power source (a battery).

CAUTION

When using the current source as a sink, always set the voltage compliance limit to levels that are higher than the external voltage level. Using the 2601B to sink more than $3\ \text{A}$ can damage the instrument and invalidate your warranty.

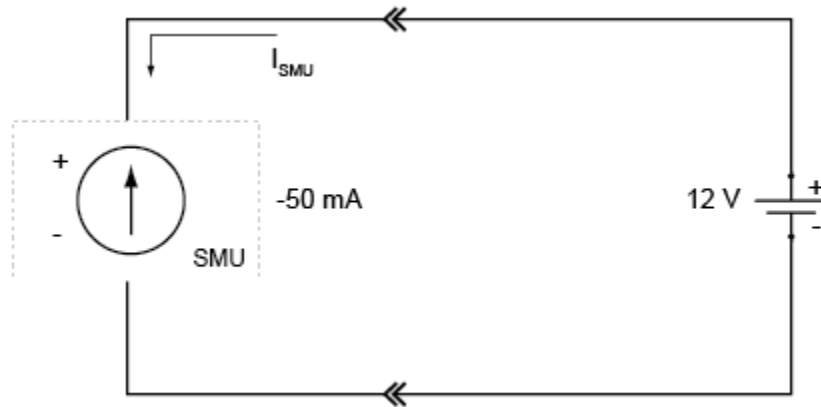
Figure 116: Sourcing current sink operation example**NOTE**

The voltage compliance limit applies both to positive and negative voltages. For example, if you set the voltage compliance limit to 15 V, the voltage limit applies to ± 15 V.

For this example, the 2601B-PULSE is programmed to source -50 mA (the constant current) and to limit voltage to 15 V. When the SMU turns on, it begins sinking current as determined by the programmed current source level (-50 mA), causing a decrease in battery voltage. If the battery were ideal and could be charged negatively, its voltage would continue to decrease until it is negatively charged at -15 V (shown by the green arrow in the following figure), at which point the SMU would be in voltage compliance.

Make sure to take into account that reversing the polarity may destroy some power sources. To prevent a negative charge, monitor the SMU's measurement of the battery voltage and stop the discharge before the 2601B-PULSE starts to operate in quadrant III (negative voltage). You can stop the discharge by changing the programmed current source level or by disconnecting the SMU from the device.

In the following figure, as the battery drains, the battery voltage is lowered as shown by the green arrow. Operation will continue in this direction until the user stops operation or the voltage reaches the voltage compliance limit line.

NOTE

Since the battery is a power source, operation in this example is limited by the capability of the battery to deliver 50 mA (see the following figure).

Figure 117: Considerations when sourcing current and sinking power

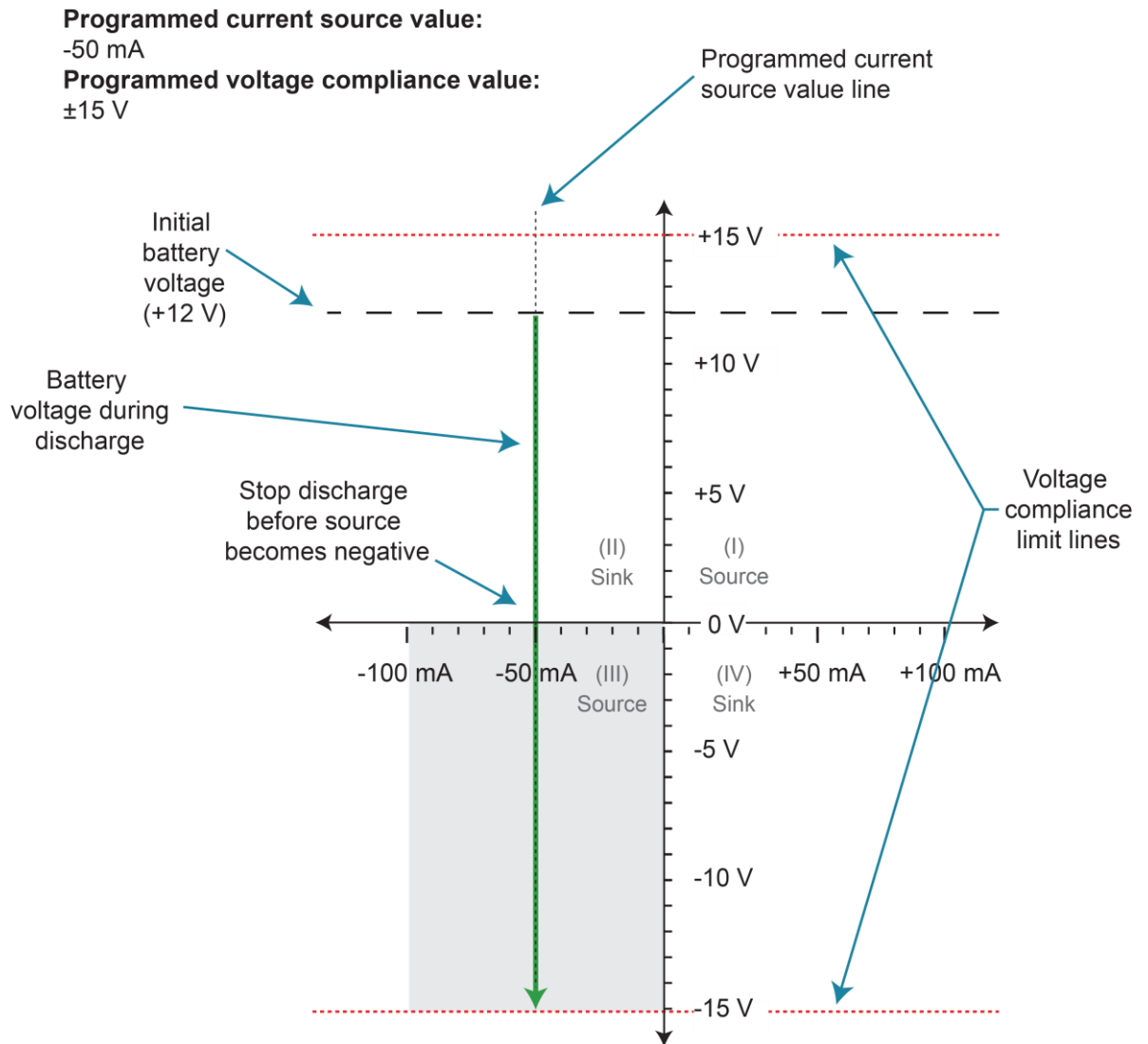

Basic circuit configurations

The following topics describe the source, measure, and contact check circuit configurations when the pulser is disabled.

Source V

When configured to source voltage (V-source) as shown in the figure below, the 2601B-PULSE functions as a low-impedance voltage source with current limit capability and can measure current (I-meter) or voltage (V-meter).

Sense circuitry is used to monitor the output voltage continuously and make adjustments to the V-source as needed. The V-meter senses the voltage at the HI / LO terminals (2-wire local sense) or at the device-under-test (DUT) (4-wire remote sense using the sense terminals) and compares it to the programmed voltage level. If the sensed level and the programmed value are not the same, the V-source is adjusted accordingly. Remote sense eliminates the effect of voltage drops in the test leads, ensuring that the exact programmed voltage appears at the DUT. With 4-wire sensing enabled, both remote sense leads must be connected or incorrect operation will occur. Use contact check to verify that the sense leads are connected (see [Contact check measurements](#) (on page 4-12)).

Figure 118: Source V configuration

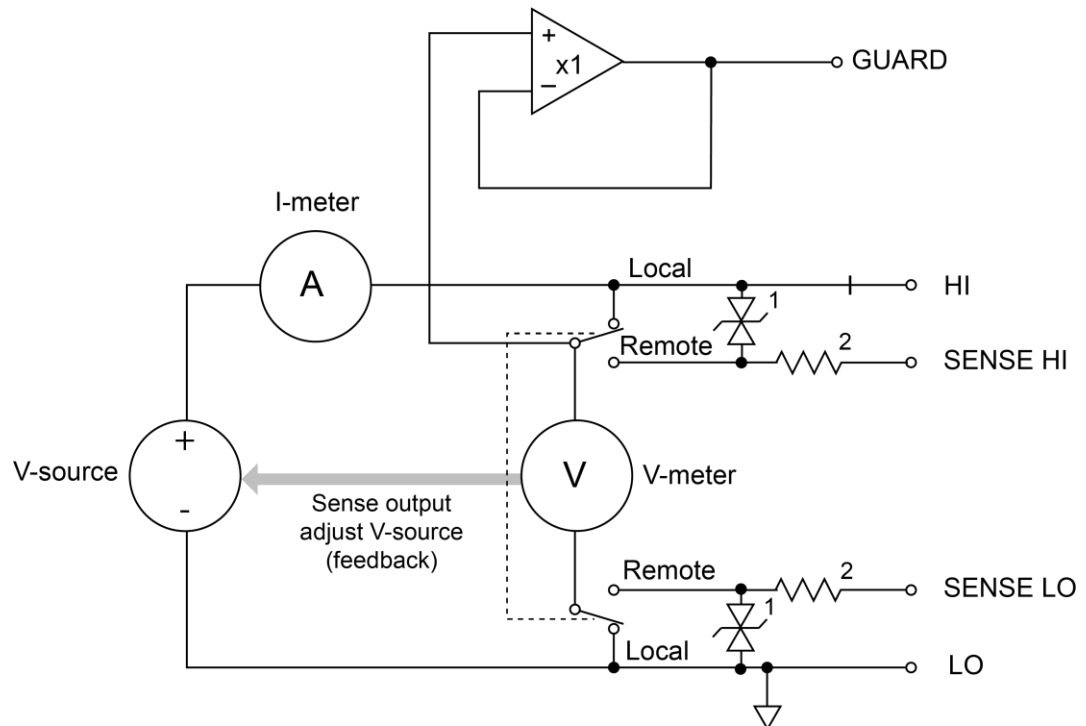

- NOTES: 1. This represents a protection circuit that is very high impedance until the voltage across it exceeds approximately 3 V. Above 3 V, the protection turns on and allows current to flow through it.
2. Approximately 13 k Ω .

Source I

When the instrument is configured to source current (I-source), as shown in the figure below, the instrument functions as a high-impedance current source with voltage limit capability and can measure current (I-meter) or voltage (V-meter).

For 2-wire local sensing, voltage is measured at the HI / LO terminals of the instrument. For 4-wire remote sensing, voltage is measured directly at the device-under-test (DUT) using the sense terminals. This eliminates any voltage drops that may be in the test leads or connections between the instrument and the DUT.

The current source does not require or use the sense leads to enhance current source accuracy. However, if the instrument is in 4-wire remote sense mode, the instrument may reach limit levels if the sense leads are disconnected. With 4-wire remote sensing selected, the sense leads must be connected or incorrect operation will result.

Figure 119: Source I configuration

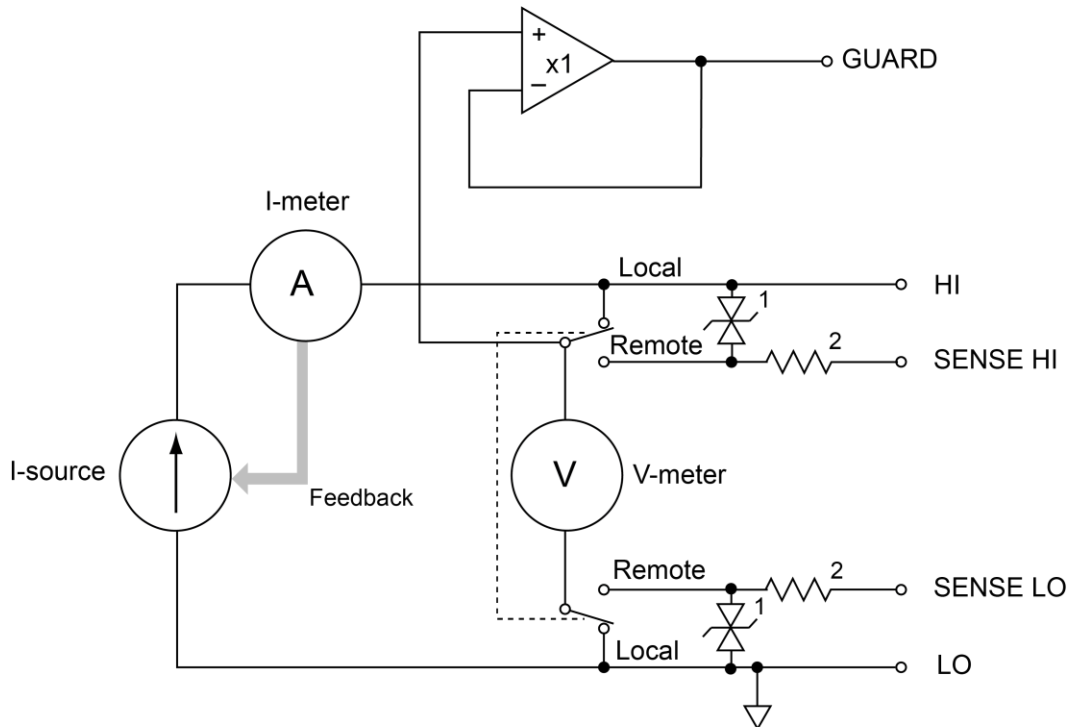

- NOTES: 1. This represents a protection circuit that is very high impedance until the voltage across it exceeds approximately 3 V. Above 3 V, the protection turns on and allows current to flow through it.
 2. Approximately 13 kΩ.

Source I measure I, source V measure V

The System SourceMeter® Instrument can measure the same function that it is sourcing. For example, when sourcing a voltage, you can measure voltage. Conversely, if you are sourcing current, you can measure the output current. For these operations, the measure range is the same as the source range.

This feature is valuable when operating with the source in compliance. When in compliance, the programmed source value is not reached, so measuring the source lets you measure the actual output level.

Measure only (voltage or current)

The figures below show the configurations for using the instrument exclusively as a voltmeter or ammeter.

As shown in the following figure, to configure the instrument to measure voltage only, set it to source 0 A and measure voltage.

Figure 120: 2601B-PULSE measure voltage only

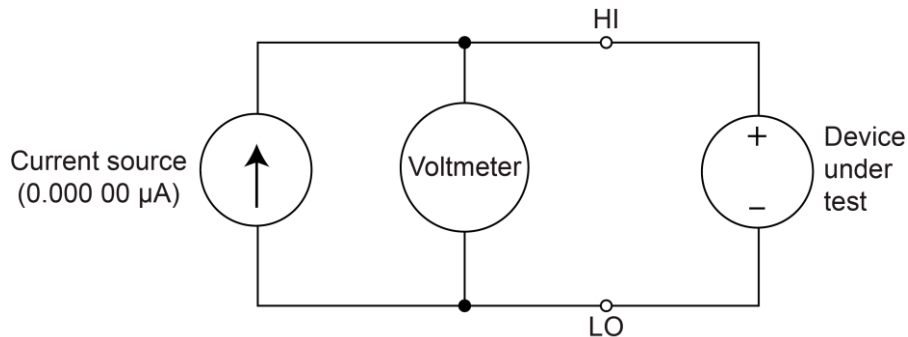

CAUTION

Set the voltage limit to a level that is higher than the measured voltage. If the voltage limit is set to a level that is lower than the measured voltage, excessive current will flow into the instrument. This current could damage the instrument. Also, when connecting an external energy source to the instrument when it is configured as a current source, set the output off state to the high-impedance mode. See [Output-off states](#) (on page 4-26) for more information on the output-off states. See [Limits](#) (on page 4-2) for details on compliance limit.

In the following figure, the instrument uses a 2-wire local sensing configuration and is set to measure current only by setting it to source 0 V and measure current. Note that to obtain positive (+) readings, conventional current must flow from HI to LO.

Figure 121: 2601B-PULSE measure current only

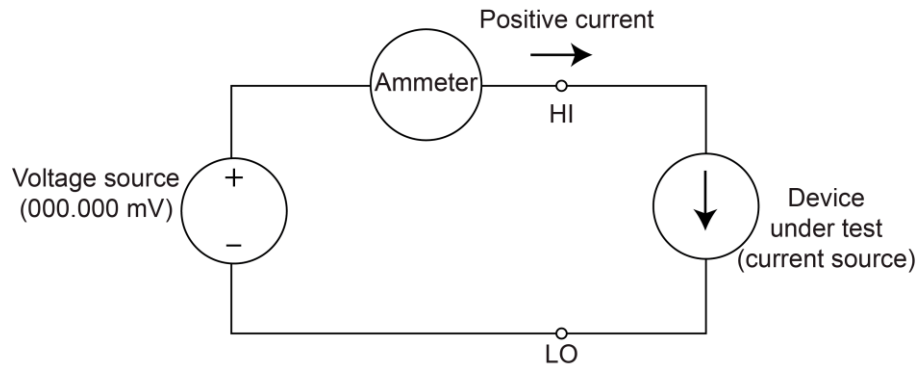

Contact check

NOTE

Contact check is not available if pulse mode is enabled.

When a contact check measurement is being performed, two small current sources are switched in between the HI and SENSE HI terminals and the LO and SENSE LO terminals. By controlling the switches illustrated in the following figure, the current from these sources flows through the test leads and through the contact resistance, as shown. To accurately measure the resulting contact resistance, the differential amplifier outputs are measured once with the current sources connected, and again with the current sources disconnected. This allows for compensation of offset voltages that can occur.

Figure 122: Contact check circuit

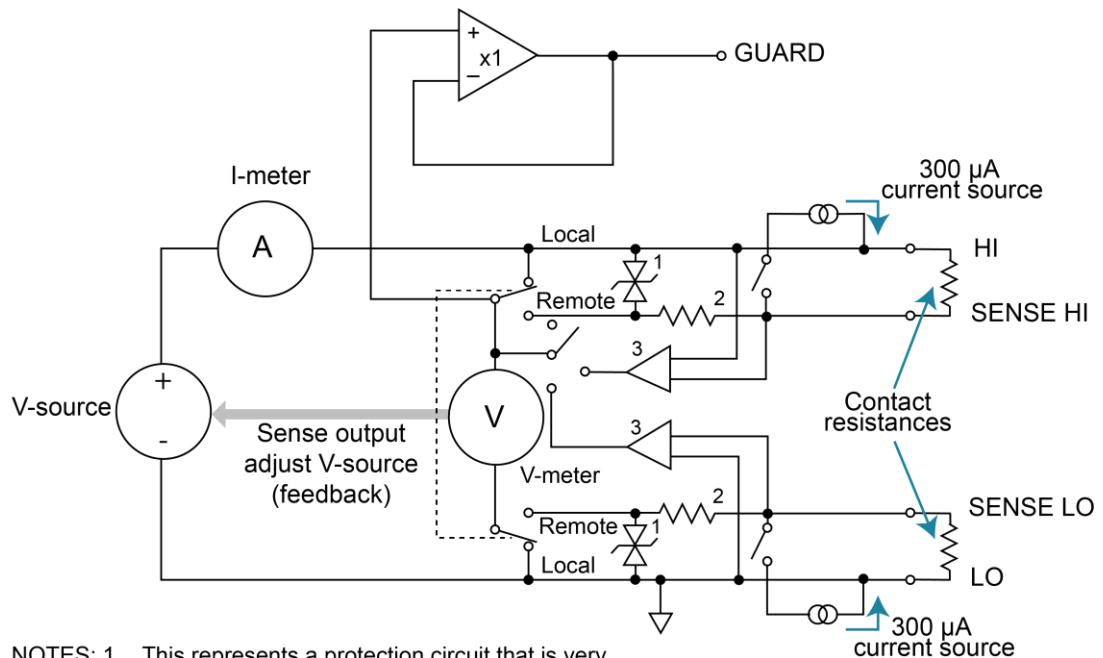

- NOTES: 1. This represents a protection circuit that is very high impedance until the voltage across it exceeds approximately 3 V. Above 3 V, the protection turns on and allows current to flow through it.
2. Approximately 13 k Ω .
3. High impedance differential amplifier.

Guard

⚠ WARNING

GUARD is at the same potential as output HI. Thus, if hazardous voltages are present at output HI, they are also present at the GUARD terminal.

The rear-panel GUARD terminals are always enabled and provide a buffered voltage that is at the same level as the HI (or SENSE HI for remote sense) voltage. The purpose of guarding is to eliminate the effects of leakage current (and capacitance) that can exist between HI and LO. In the absence of a driven guard, leakage in the external test circuit could be high enough to adversely affect the performance of the System SourceMeter® Instrument.

Leakage current can occur through parasitic or nonparasitic leakage paths. An example of parasitic resistance is the leakage path across the insulator in a coaxial or triaxial cable. An example of nonparasitic resistance is the leakage path through a resistor that is connected in parallel to the device-under-test (DUT).

Guard connections

Guard is typically used to drive the guard shields of cables and test fixtures. Guard is extended to a test fixture from the cable guard shield. Inside the test fixture, the guard can be connected to a guard plate or shield that surrounds the device-under-test (DUT).

⚠ WARNING

A safety shield must be used whenever hazardous voltages (>30 V_{RMS}, 42 V_{PEAK}) will be present in the test circuit. To prevent electrical shock that could cause injury or death, never use the 2601B-PULSE in a test circuit that may contain hazardous voltages without a properly installed and configured safety shield. The figure in this topic shows the metal case of a test fixture being used as a safety shield.

NOTE

See [Guarding and shielding](#) (on page 4-20) for details about guarded test connections.

Inside the test fixture, a triaxial cable can be used to extend guard to the DUT. The center conductor of the cable is used for HI, and the inner shield is used for guard.

The figures below show how cable guard can eliminate leakage current through the insulators in a test fixture. In this figure, leakage current (I_L) flows through the insulators (R_{L1} and R_{L2}) to LO, adversely affecting the low-current (or high-resistance) measurement of the DUT.

Also in the figures below, the driven guard is connected to the cable shield and extended to the metal guard plate for the insulators. Since the voltage on either end of R_{L1} is the same (0 V drop), no current can flow through the leakage resistance path, so the instrument only measures the current through the DUT.

Figure 123: Unguarded measurements

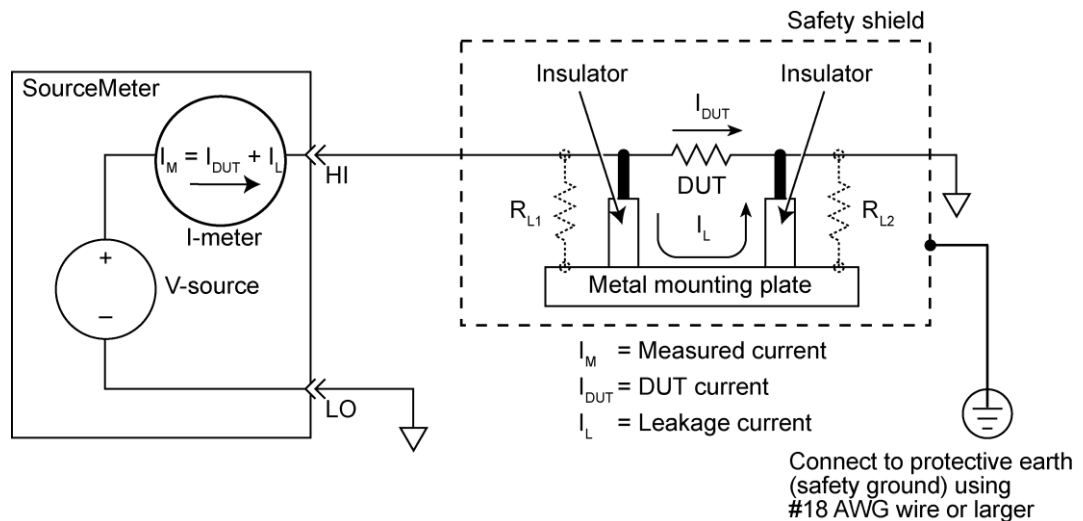
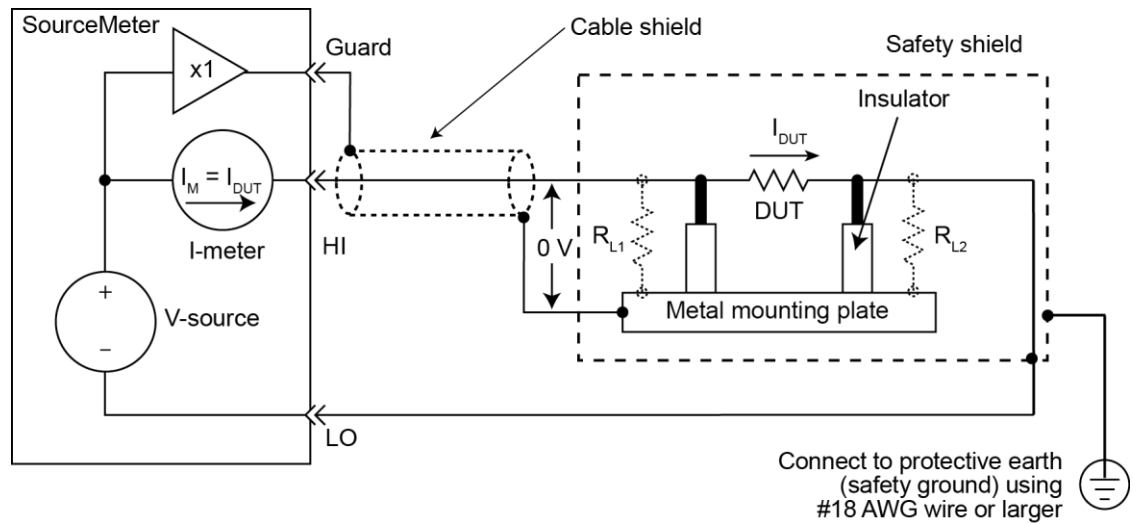

Figure 124: Guarded measurements



Measurement settling time considerations

This information applies when the pulser is disabled.

Several outside factors can influence measurement settling times. Effects such as dielectric absorption, cable leakages, and noise can all extend the times required to make stable measurements. Be sure to use appropriate shielding, guarding, and aperture selections when making low-current measurements.

Each current measurement range has a combination of a range resistor and a compensating capacitor that must settle out to allow a stable measurement. By default (when power is turned on or after a `smua.reset()` command), delays are enforced to account for approximately 6τ or 6 time constants of a given range (to reach 0.1 percent of the final value, assuming 2.3τ per decade). The table below lists the current ranges and associated default delays.

Current measure settling time after a voltage step

Time required to reach 0.1% of final value after source level command is processed on a fixed range with a delay factor set to 1 and compliance set to 100 mA. Values below for $V_{OUT} = 2\text{ V}$ unless otherwise noted.

Current range	Settling time
1.5 A to 1 A	<120 μs (typical) ($R_{LOAD} > 6\ \Omega$)
100 mA to 10 mA	<80 μs (typical)
1 mA	<100 μs (typical)
100 μA	<150 μs (typical)
10 μA	<500 μs (typical)
1 μA	<2.5 ms (typical)
100 nA	<15 ms (typical)

You can manipulate both the analog filter and the default delays to produce faster response times. Turn off the analog filter to yield faster settling times. Control the default delays by using the delay factor multiplier. The default value for delay factor multiplier is 1.0, but adjusting it to other values results in either a faster or slower response. For example, increasing the delay factor to 1.3 accounts for settling to 0.01 percent of the final value. The commands to manipulate the delay factor and analog filter are shown in the following programming example.

Programming example for controlling settling time delay

The following code provides measure delay examples for controlling settling time delay:

```
-- Turn off measure delay (default setting is smua.DELAY_AUTO).
smua.measure.delay = 0

-- Set measure delay for all ranges to Y in seconds.
smua.measure.delay = Y

-- Adjust the delay factor.
smua.measure.delayfactor = 1.0
```

The delay factor is used to multiply the default delays. Setting this value above 1.0 increases the delays; a value below 1.0 decreases the delay. Setting this value to 0.0 essentially turns off measurement delays. This attribute is only used when `smua.measure.delay` is set to `smua.DELAY_AUTO`.

Effects of load on current source settling time

When the pulser is disabled, the settling time of the source-measure unit (SMU) can be influenced by the impedance of the device-under-test (DUT) in several ways. One influence is caused by an interaction between the impedances of the SMU current source feedback element and the DUT. This interaction can cause a reduction in the bandwidth of the SMU. This reduction results in an increase in the settling time of the current source.

There is a maximum DUT impedance for each current source range for which the specified current settling times are maintained. The following table lists the DUT impedances for each of these current source ranges. For the latest specifications, go to tek.com/keithley. The settling time on a current source range can increase significantly when measuring DUTs that have an impedance that is higher than the maximum DUT impedance listed below.

Maximum DUT impedances for specified settling time performance

Range	SMU feedback impedance	Maximum DUT impedance
1 nA	1 G Ω	2 G Ω
10 nA	120 M Ω	60 M Ω
100 nA	40 M Ω	20 M Ω
1 μ A	1.2 M Ω	600 k Ω
10 μ A	400 k Ω	200 k Ω
100 μ A	12 k Ω	6 k Ω
1 mA	4 k Ω	2 k Ω
10 mA	120 Ω	60 Ω
100 mA	40 Ω	20 Ω
1 A	1 Ω	6 Ω
1.5 A	1 Ω	6 Ω
3 A	0.3 Ω	1.5 Ω

When the pulser is enabled, the SMU can meet its settling time for any load up to ± 10 V and 3 μ H.

Creating pulses with the 2601B-PULSE SMU

Although the 2601B-PULSE SMU is not a pulse generator, you can create pulses by programming the SMU to output a DC value and then return to an idle level. For information on how to create pulses, refer to [Sweep operation](#) (on page 4-61) and [Using the remote trigger model](#) (on page 6-3).

Pulse rise and fall times

NOTE

The pulse rise times are not programmable.

When the pulser is disabled, the pulse rise time is the time it takes a pulse to go from 10% to 90% of the maximum value of the pulse. Pulse fall time is similar but on the trailing edge of the pulse. For the 2601B-PULSE SMU, pulse rise and fall times can vary depending on the following factors:

- [Range and pulse settling](#) (on page 7-29)
- [Load and operating mode](#) (on page 7-29)
- Compliance limit settings (for details, see [Limits](#) (on page 4-2))

Figure 125: Pulse rise and fall times

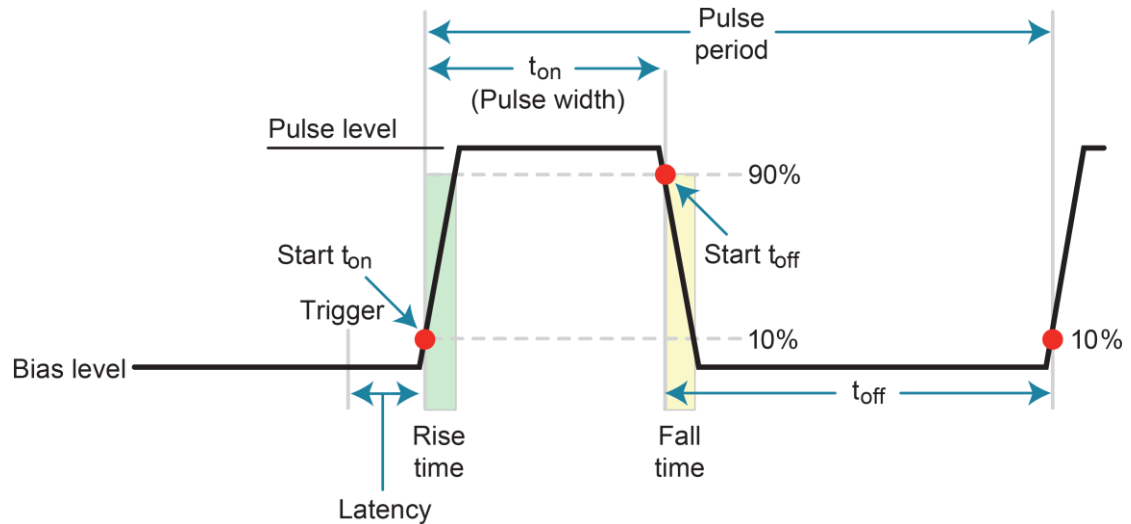

When the pulser is enabled, pulse rise and fall times are largely independent of range, load (within the specified limits of ± 10 V and < 3 μ H), or protection limit settings.

Refer to the 2601B-PULSE SMU specifications for details on source settling times. For the latest specifications, go to tek.com/keithley.

Range and pulse settling

Each SMU range has different specifications for source settling times. This causes different rise and fall time characteristics depending on the set range.

In addition, pulse performance is dependent on the pulse setting as a percent of full scale. For example, a 100 mA pulse on the 1 A range (which is 10%) will perform differently than a 1 A pulse on the 1 A range (which is full scale). Refer to the 2601B-PULSE specifications for details. For the latest specifications, go to tek.com/keithley.

SMU load and operating mode

Settling times for the current source will vary with the resistive load applied. In addition to the load, the times will vary dependent on whether the source-measure unit (SMU) is configured as a voltage source or a current source, and also with the voltage source range selected.

SMU pulse width

The pulse width is the interval between 10% on the rising (leading) edge to 90% on the falling (trailing) edge. In the extended operating area, the SMU automatically limits the pulse width to the maximum value allowed for the region in which the SMU is operating, even if you have configured a longer pulse width. Exceeding the specified pulse width limits can result in short pulses. The pulse width jitter can vary due to the pulse width (this is especially important for short pulse widths).

NOTE

With respect to pulse width, jitter is the short-term instability of the trailing edge relative to the leading edge.

Review the 2601B-PULSE SMU specifications for information on source settling time. For the latest specifications, go to tek.com/keithley.

In this section:

Introduction	8-1
Displaying the serial number	8-1
Line fuse replacement.....	8-2
Front-panel tests	8-3
Upgrading the firmware.....	8-5

Introduction

The information in this section describes routine maintenance of the instrument that the operator can perform. It also contains information on how to optimize your measurements.

Displaying the serial number

The instrument serial number is on a label on the rear panel of the instrument. You can also access the serial number from the front panel using the front-panel keys and menus.

To display the serial number on the front panel:

1. If the 2601B-PULSE is in remote operation, press the **EXIT (LOCAL)** key once to place the instrument in local operation.
2. Press the **MENU** key.
3. Use the navigation wheel  to scroll to the **SYSTEM-INFO** menu item.
4. Press the **ENTER** key. The SYSTEM INFORMATION menu is displayed.
5. Scroll to the **SERIAL#** menu item.
6. Press the **ENTER** key. The 2601B-PULSE serial number is displayed.

Line fuse replacement

A fuse on the 2601B-PULSE rear panel protects the power line input of the instrument. See the following instructions to replace the fuse. You do not need to return your instrument for service if the fuse is damaged.

⚠ WARNING

Disconnect the line cord at the rear panel and remove all test leads connected to the instrument before replacing a line fuse. Failure to do so could expose the operator to hazardous voltages that could result in personal injury or death.

⚠ WARNING

To prevent injury, death, or instrument damage, use only the correct fuse type, as shown in the following table.

Line fuse

Line voltage	Rating	Keithley part number
100 V to 240 V	250 V, 3.15 A, slow blow 5 × 20 mm	FU-106-3.15

To replace the line fuse:

1. Power off the instrument and remove the line cord.
2. The fuse drawer (item 1 in the following figure) is below the AC receptacle. A small tab is on the top of the fuse drawer (item 2). Use a thin-bladed knife or a screwdriver to pry this tab away from the AC receptacle.

Figure 126: Fuse replacement

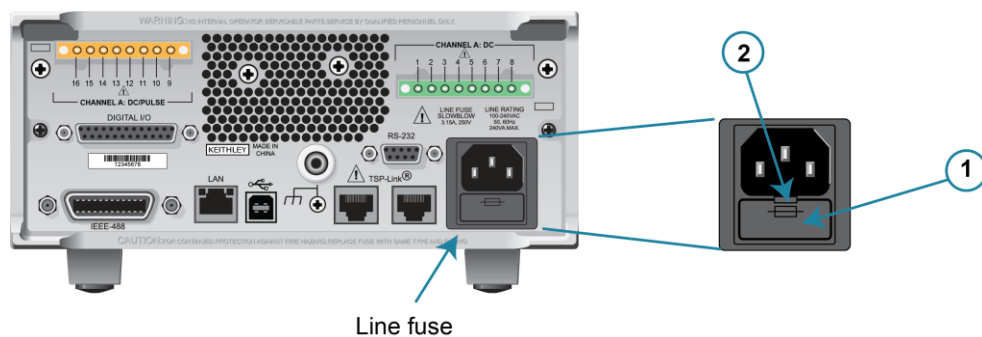

3. Slide the fuse drawer out to gain access to the fuse. The fuse drawer does not pull completely out of the power module.
4. Snap the fuse out of the drawer and replace it with the same type.
5. Push the fuse drawer back into the module.

If a fuse continues to become damaged, a circuit malfunction exists and must be corrected. Return the instrument to Keithley Instruments for repair.

Front-panel tests

The front-panel tests test the functionality of the front-panel keys and the display.



NOTE

In the following procedures, highlight the menu item and press the **ENTER** key to select it. You can also select a menu item by pressing the navigation wheel .

Keys test

This test lets you check the functionality of each front-panel key.



Perform the following steps to run the KEYS test:

1. If the 2601B-PULSE instrument is in remote mode, press the **EXIT (LOCAL)** key once to place the instrument in local mode.
2. Press the **MENU** key.
3. Navigate through the menus by turning the navigation wheel . Press the **ENTER** key to select the menu items as follows: **DISPLAY > TEST > DISPLAY-TESTS**.
4. Turn the navigation wheel  until the **KEYS** menu item is highlighted.
5. To start the test, press the **ENTER** key. When you press a key while the test is active, the label name for that key is displayed to indicate that it is functioning properly. When you release the key, the message `No keys pressed` is displayed.
6. To test the **EXIT (LOCAL)** key, press the **EXIT (LOCAL)** key once.
7. To exit the test, press the **EXIT (LOCAL)** key twice consecutively. You will exit the test and the instrument returns to the **FRONT PANEL TESTS** menu.
8. Press the **EXIT (LOCAL)** key multiple times to exit out of the menu structure.

Display patterns test

This test lets you verify that each pixel and indicator in the vacuum fluorescent display is working properly.

Perform the following steps to run the display test:

1. If the 2601B-PULSE instrument is in remote mode, press the **EXIT (LOCAL)** key once to place the instrument in local mode.
2. Press the **MENU** key.
3. Navigate through the menus by turning the navigation wheel , and then pressing the **ENTER** key to select the items as follows: **DISPLAY > TEST > DISPLAY-TESTS**.
4. Turn the navigation wheel  until the **DISPLAY-PATTERNS** menu item is highlighted.
5. To start the display test, press the **ENTER** key. There are three parts to the display test. Each time the **ENTER** key or the navigation wheel  is pressed, the next part of the test sequence is selected. The three parts of the test sequence are as follows:
 - Checkerboard pattern and the indicators that are on during normal operation
 - Checkerboard pattern (alternate pixels on) and all the numeric indicators (which are not used) are illuminated
 - Each digit and adjacent indicators are sequenced; all the pixels of the selected digit are on
6. When finished, abort the display test by pressing the **EXIT (LOCAL)** key. The instrument returns to the FRONT PANEL TESTS menu. Continue pressing the **EXIT (LOCAL)** key to exit out of the menu structure.

Upgrading the firmware

You can upgrade or downgrade the firmware using the front-panel USB port or Test Script Builder (TSB). The process should take less than five minutes.

The upgrade file has a name such as 2600B-P-850SVn.n.n.x, where n.n.n is the firmware version.

Upgrade files are available for download from the [Product Support web page \(tek.com/product-support\)](http://tek.com/product-support).

CAUTION



Disconnect the input terminals before you upgrade or downgrade.

Do not remove power from the 2601B-PULSE or remove the USB flash drive while an upgrade or downgrade is in progress. Wait until the instrument completes the procedure and shows the opening display.

Do not initialize or reset TSP-Link before starting the upgrade.

Before starting the upgrade, turn the instrument power off, wait a few seconds, then turn the instrument power on.

To upgrade the firmware using the front panel:

1. Copy the firmware upgrade file to a USB flash drive.
2. Disconnect the input and output terminals to and from the instrument.
3. Turn the instrument power off. Wait a few seconds.
4. Turn the instrument power on.
5. If the instrument is in remote mode, press the **EXIT (LOCAL)** key once to place the instrument in local mode.
6. Insert the flash drive into the USB port on the front panel of the 2601B-PULSE.
7. From the front panel, press the **MENU** key
8. Turn the navigation wheel  to go to the **UPGRADE** menu item, and then press the **ENTER** key.
9. Turn the navigation wheel  to select the file on the USB flash drive that contains the appropriate version of firmware. **UPGRADE** is displayed.
10. Press the **ENTER** key to select **Yes**. The status of the upgrade is displayed.

The instrument reboots automatically when the upgrade is complete.

Using TSB to upgrade the firmware

After downloading the new flash file from tek.com/keithley, you can use Test Script Builder (TSB) to upgrade the firmware of your 2601B-PULSE.

To upgrade the firmware using Test Script Builder:

1. Start Test Script Builder.
2. On the Instrument Console toolbar, click the **Open Instrument** icon.

Figure 127: Open Instrument icon

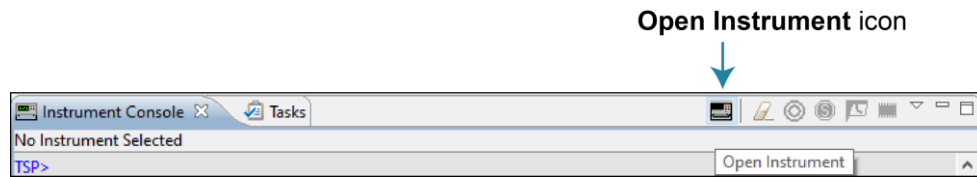

3. Select your instrument from the **Select Instrument** dialog box.
4. On the Instrument Console toolbar, select the down arrow and select **Instrument > Flash**.

Figure 128: Flash menu option

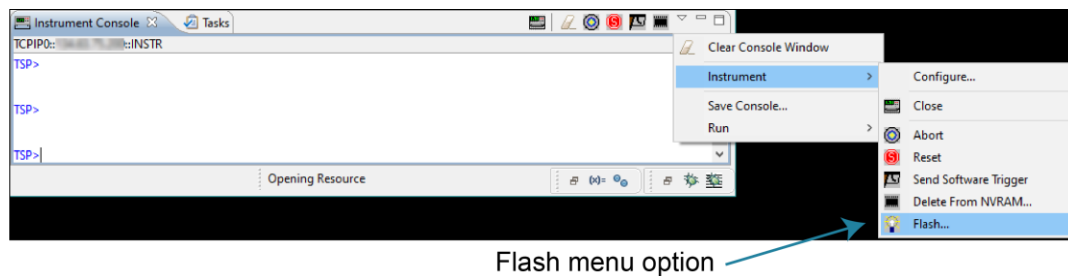

5. For **Select or enter a firmware image file**, use the browser to select the new firmware.
6. For **Select a replacement mode**, select **Upgrade** to install a later version of firmware or **Downgrade** to install an earlier version of firmware.
7. Wait until the upgrade or downgrade is complete and the instrument shows the opening display.

Introduction to TSP operation

In this section:

Introduction to TSP operation.....	9-1
About TSP commands	9-3
Factory scripts.....	9-19

Introduction to TSP operation

Instruments that are enabled for Test Script Processor (TSP®) operate like conventional instruments by responding to a sequence of commands sent by the controller. You can send individual commands to the TSP-enabled instrument the same way you would when using any other instrument.

Unlike conventional instruments, TSP-enabled instruments can execute automated test sequences independently, without an external controller. You can load a series of TSP commands into the instrument. You can store these commands as a script that can be run later by sending a single command message to the instrument.

You do not have to choose between using conventional control or script control. You can combine these forms of instrument control in the way that works best for your test application.

Controlling the instrument by sending individual command messages

The simplest method of controlling an instrument through the communication interface is to send it a message that contains remote commands. You can use a test program that resides on a computer (the controller) to sequence the actions of the instrument.

TSP commands can be function-based or attribute-based. Function-based commands are commands that control actions or activities. Attribute-based commands define characteristics of an instrument feature or operation.

Constants represent fixed values.

Functions

Function-based commands control actions or activities. A function-based command performs an immediate action on the instrument.

Each function consists of a function name followed by a set of parentheses (). You should only include information in the parentheses if the function takes a parameter. If the function takes one or more parameters, they are placed between the parentheses and separated by commas.

Example 1

```
beeper.beep(0.5, 2400)
delay(0.250)
beeper.beep(0.5, 2400)
```

Emit a double-beep at 2400 Hz. The sequence is 0.5 s on, 0.25 s off, 0.5 s on.

Example 2

You can use the results of a function-based command directly or assign the results to variables for later access. The following code defines `x` and prints it.

```
x = math.abs(-100)
print(x)
```

Output:
100

Attributes

Attribute-based commands are commands that set the characteristics of an instrument feature or operation. For example, a characteristic of TSP-enabled instruments is the model number (`localnode.model`).

Attributes can be read-only, read-write, or write-only. They can be used as a parameter of a function or assigned to another variable.

To set the characteristics, attribute-based commands define a value. For many attributes, the value is in the form of a number or a predefined constant.

Example 1: Set an attribute using a number

```
beeper.enable = 0
```

This attribute controls the beeps that occur when front-panel controls are selected. Setting this attribute to 0 turns off the beeper.

Example 2: Set an attribute using a constant

```
format.data = format.REAL64
```

Using the constant `REAL64` sets the print format to double precision floating-point format.

To read an attribute, you can use the attribute as the parameter of a function, or assign it to another variable.

Example 3: Read an attribute using a function

```
print(format.data)
```

Reads the data format by passing the attribute to the print function. If the data format is set to 3, the output is:
3.00000e+00

This shows that the data format is set to double precision floating point.

Example 4: Read an attribute using a variable

```
fd = format.data
```

This reads the data format by assigning the attribute to a variable named `fd`.

Queries

Test Script Processor (TSP®) enabled instruments do not have inherent query commands. Like any other scripting environment, the `print()` and `printnumber()` commands generate output in the form of response messages. Each `print()` command creates one response message.

Example

```
x = 10  
print(x)
```

Example of an output response message:

10

Note that your output may be different if you set your ASCII precision setting to a different value.

Information on scripting and programming

If you need information about using scripts with your TSP-enabled instrument, see [Fundamentals of scripting for TSP](#) (on page 10-1).

If you need information about using the Lua programming language with the instrument, see [Fundamentals of programming for TSP](#) (on page 10-13).

About TSP commands

This section contains an overview of the TSP commands for the instrument. The commands are organized into groups, with a brief description of each group. Each section contains links to the detailed descriptions for each command in the TSP command reference section of this documentation (see [TSP commands](#) (on page 11-8)).

Beeper control

The beeper commands allow you to enable or disable and sound the instrument beeper.

[beeper.beep\(\)](#) (on page 11-8)

[beeper.enable](#) (on page 11-8)

Bit manipulation and logic operations

The bit functions perform bitwise logic operations on two given numbers, and bit operations on one given number. Logic and bit operations truncate the fractional part of given numbers to make them integers.

Logic operations

The `bit.bitand()`, `bit.bitor()`, and `bit.bitxor()` functions in this group perform bitwise logic operations on two numbers. The Test Script Processor (TSP®) scripting engine performs the indicated logic operation on the binary equivalents of the two integers. This bitwise logic operation is performed on all corresponding bits of the two numbers. The result of a logic operation is returned as an integer.

Bit operations

The rest of the functions in this group are used for operations on the bits of a given number. These functions can be used to:

- Clear a bit
- Toggle a bit
- Test a bit
- Set a bit or bit field
- Retrieve the weighted value of a bit or field value

All these functions use an index parameter to specify the bit position of the given number. The least significant bit of a given number has an index of 1, and the most significant bit has an index of 32.

NOTE

The Test Script Processor (TSP) scripting engine stores all numbers internally as IEEE Std 754 double-precision floating-point values. The logical operations work on 32-bit integers. Any fractional bits are truncated. For numbers larger than 4294967295, only the lower 32 bits are used.

[bit.bitand\(\)](#) (on page 11-9)

[bit.bitor\(\)](#) (on page 11-10)

[bit.bitxor\(\)](#) (on page 11-10)

[bit.clear\(\)](#) (on page 11-11)

[bit.get\(\)](#) (on page 11-12)

[bit.getfield\(\)](#) (on page 11-13)

[bit.set\(\)](#) (on page 11-14)

[bit.setfield\(\)](#) (on page 11-15)

[bit.test\(\)](#) (on page 11-16)

[bit.toggle\(\)](#) (on page 11-17)

Calibration

[smua.cal.adjustdate](#) (on page 11-179)
[smua.cal.date](#) (on page 11-180)
[smua.cal.due](#) (on page 11-181)
[smua.cal.lock\(\)](#) (on page 11-182)
[smua.cal.password](#) (on page 11-182)
[smua.cal.polarity](#) (on page 11-183)
[smua.cal.restore\(\)](#) (on page 11-184)
[smua.cal.save\(\)](#) (on page 11-184)
[smua.cal.state](#) (on page 11-185)
[smua.cal.unlock\(\)](#) (on page 11-186)
[smua.contact.calibratehi\(\)](#) (on page 11-186)
[smua.contact.calibratelo\(\)](#) (on page 11-187)
[smua.measure.calibrateY\(\)](#) (on page 11-196)
[smua.pulser.measure.calibrateY\(\)](#) (on page 11-214)
[smua.pulser.source.calibratebiasi\(\)](#) (on page 11-219)
[smua.pulser.source.calibratei\(\)](#) (on page 11-221)
[smua.source.calibrateY\(\)](#) (on page 11-225)

Data queue

Use the data queue commands to:

- Share data between test scripts running in parallel
- Access data from a remote group or a local node on a TSP-Link® network at any time

The data queue in the Test Script Processor (TSP®) scripting engine is first-in, first-out (FIFO).

You can access data from the data queue even if a remote group or a node has overlapped operations in process.

[dataqueue.add\(\)](#) (on page 11-38)
[dataqueue.CAPACITY](#) (on page 11-39)
[dataqueue.clear\(\)](#) (on page 11-39)
[dataqueue.count](#) (on page 11-40)
[dataqueue.next\(\)](#) (on page 11-41)

Digital I/O

The digital I/O port of the instrument can control external circuitry (such as a component handler for binning operations).

The I/O port has 14 lines. Each line can be at TTL logic state 1 (high) or 0 (low). See the pinout diagram in [Digital I/O port](#) (on page 6-36) for additional information.

There are commands to read and write to each individual bit, and commands to read and write to the entire port.

- [digio.readbit\(\)](#) (on page 11-42)
- [digio.readport\(\)](#) (on page 11-43)
- [digio.trigger\[N\].assert\(\)](#) (on page 11-44)
- [digio.trigger\[N\].clear\(\)](#) (on page 11-44)
- [digio.trigger\[N\].EVENT_ID](#) (on page 11-45)
- [digio.trigger\[N\].mode](#) (on page 11-45)
- [digio.trigger\[N\].overrun](#) (on page 11-47)
- [digio.trigger\[N\].pulsewidth](#) (on page 11-47)
- [digio.trigger\[N\].release\(\)](#) (on page 11-48)
- [digio.trigger\[N\].reset\(\)](#) (on page 11-49)
- [digio.trigger\[N\].stimulus](#) (on page 11-50)
- [digio.trigger\[N\].wait\(\)](#) (on page 11-51)
- [digio.writebit\(\)](#) (on page 11-52)
- [digio.writeport\(\)](#) (on page 11-52)
- [digio.writeprotect](#) (on page 11-53)

Display

- [display.clear\(\)](#) (on page 11-54)
- [display.getannunciators\(\)](#) (on page 11-54)
- [display.getcursor\(\)](#) (on page 11-56)
- [display.getlastkey\(\)](#) (on page 11-57)
- [display.gettext\(\)](#) (on page 11-58)
- [display.inputvalue\(\)](#) (on page 11-59)
- [display.loadmenu.add\(\)](#) (on page 11-61)
- [display.loadmenu.catalog\(\)](#) (on page 11-62)
- [display.loadmenu.delete\(\)](#) (on page 11-63)
- [display.locallockout](#) (on page 11-63)
- [display.menu\(\)](#) (on page 11-64)
- [display.numpad](#) (on page 11-65)
- [display.prompt\(\)](#) (on page 11-65)
- [display.screen](#) (on page 11-67)
- [display.sendkey\(\)](#) (on page 11-67)
- [display.setcursor\(\)](#) (on page 11-69)
- [display.settext\(\)](#) (on page 11-70)
- [display.smua.digits](#) (on page 11-68)
- [display.smua.limit.func](#) (on page 11-71)
- [display.smua.measure.func](#) (on page 11-71)

[display.trigger.clear\(\)](#) (on page 11-72)
[display.trigger.EVENT_ID](#) (on page 11-73)
[display.trigger.overrun](#) (on page 11-73)
[display.trigger.wait\(\)](#) (on page 11-74)
[display.waitkey\(\)](#) (on page 11-74)

Error queue

When errors and events occur, the error and status messages are placed in the error queue. Use the error queue commands to request error and status message information.

[errorqueue.clear\(\)](#) (on page 11-76)
[errorqueue.count](#) (on page 11-76)
[errorqueue.next\(\)](#) (on page 11-77)

Event log

You can use the event log to view specific details about LAN triggering events.

[eventlog.all\(\)](#) (on page 11-78)
[eventlog.clear\(\)](#) (on page 11-79)
[eventlog.count](#) (on page 11-79)
[eventlog.enable](#) (on page 11-80)
[eventlog.next\(\)](#) (on page 11-81)
[eventlog.overwritemethod](#) (on page 11-82)

File I/O

You can use the file I/O commands to open and close directories and files, write data, or to read a file on an installed USB flash drive. File I/O commands are organized into two groups:

- Commands that reside in the `fs` and `io` table, for example: `io.open()`, `io.close()`, `io.input()`, and `io.output()`. Use these commands to manage file system directories; open and close file descriptors; and perform basic I/O operations on a pair of default files (one input and one output).
- Commands that reside in the file descriptors (for example: `fileVar.seek()`, `fileVar.write()`, and `fileVar.read()`) operate exclusively on the file with which they are associated.

The root folder of the USB flash drive has the absolute path:

```
"/usb1/"
```

NOTE

You can use either the slash (/) or backslash (\) as a directory separator. However, the backslash is also used as an escape character, so if you use it as a directory separator, you will generally need to use a double backslash (\\) when you are creating scripts or sending commands to the instrument.

For basic information about navigation and directory listing of files on a flash drive, see [File system navigation](#) (on page 3-29).

File descriptor commands for file I/O use a colon (:) to separate the command parts rather than a period (.), like the `io` commands.

File descriptors cannot be passed between nodes in a TSP-Link® system, so the `io.open()`, `fileVar::read()`, and `fileVar::write` commands are not accessible to the TSP-Link system. However, the default input and output files mentioned above allow for the execution of many file I/O operations without any reference to a file descriptor.

[fileVar.close\(\)](#) (on page 11-83)

[fileVar.flush\(\)](#) (on page 11-84)

[fileVar.read\(\)](#) (on page 11-85)

[fileVar.seek\(\)](#) (on page 11-86)

[fileVar.write\(\)](#) (on page 11-88)

[fs.chdir\(\)](#) (on page 11-92)

[fs.cwd\(\)](#) (on page 11-93)

[fs.is_dir\(\)](#) (on page 11-93)

[fs.is_file\(\)](#) (on page 11-94)

[fs.mkdir\(\)](#) (on page 11-95)

[fs.readdir\(\)](#) (on page 11-95)

[fs.rmdir\(\)](#) (on page 11-96)

[io.close\(\)](#) (on page 11-102)

[io.flush\(\)](#) (on page 11-103)

[io.input\(\)](#) (on page 11-104)

[io.open\(\)](#) (on page 11-104)

[io.output\(\)](#) (on page 11-105)

[io.read\(\)](#) (on page 11-106)

[io.type\(\)](#) (on page 11-107)

[io.write\(\)](#) (on page 11-108)

[os.remove\(\)](#) (on page 11-151)

[os.rename\(\)](#) (on page 11-151)

The following standard I/O commands are not supported:

File	I/O
<ul style="list-style-type: none"> ▪ <code>fileVar:lines()</code> ▪ <code>fileVar:setvbuf()</code> 	<ul style="list-style-type: none"> ▪ <code>io.lines()</code> ▪ <code>io.popen()</code>

GPIB

This attribute stores the GPIB address.

[gpib.address](#) (on page 11-99)

Instrument identification

These commands store strings that describe the instrument.

[localnode.description](#) (on page 11-139)

[localnode.model](#) (on page 11-140)

[localnode.revision](#) (on page 11-145)

[localnode.serialno](#) (on page 11-145)

LAN and LXI

The LAN commands have options that allow you to review and configure network settings.

The `lan.config.*` commands allow you to configure LAN settings over the remote interface. Note that you must send `lan.applysettings()` for the configuration settings to take effect.

The `lan.status.*` commands help you determine the status of the LAN.

The `lan.trigger[N].*` commands allow you to set up and assert trigger events that are sent over the LAN.

Other LAN commands allow you to reset the LAN, restore defaults, check LXI domain information, and enable or disable the Nagle algorithm.

[lan.applysettings\(\)](#) (on page 11-109)

[lan.autoconnect](#) (on page 11-110)

[lan.config.dns.address\[N\]](#) (on page 11-111)

[lan.config.dns.domain](#) (on page 11-112)

[lan.config.dns.dynamic](#) (on page 11-112)

[lan.config.dns.hostname](#) (on page 11-113)

[lan.config.dns.verify](#) (on page 11-114)

[lan.config.duplex](#) (on page 11-114)

[lan.config.gateway](#) (on page 11-115)

[lan.config.ipaddress](#) (on page 11-116)

[lan.config.method](#) (on page 11-116)

[lan.config.speed](#) (on page 11-117)

[lan.config.subnetmask](#) (on page 11-118)

[lan.linktimeout](#) (on page 11-118)

[lan.lxidomain](#) (on page 11-119)

[lan.nagle](#) (on page 11-120)

[lan.reset\(\)](#) (on page 11-120)

[lan.restoredefaults\(\)](#) (on page 11-121)

[lan.status.dns.address\[N\]](#) (on page 11-122)

[lan.status.dns.name](#) (on page 11-122)

[lan.status.duplex](#) (on page 11-123)

[lan.status.gateway](#) (on page 11-124)

[lan.status.ipaddress](#) (on page 11-124)

[lan.status.macaddress](#) (on page 11-125)

[lan.status.port.dst](#) (on page 11-125)
[lan.status.port.rawsocket](#) (on page 11-126)
[lan.status.port.telnet](#) (on page 11-126)
[lan.status.port.vxi11](#) (on page 11-127)
[lan.status.speed](#) (on page 11-127)
[lan.status.subnetmask](#) (on page 11-128)
[lan.timedwait](#) (on page 11-128)
[lan.trigger\[N\].assert\(\)](#) (on page 11-129)
[lan.trigger\[N\].clear\(\)](#) (on page 11-129)
[lan.trigger\[N\].connect\(\)](#) (on page 11-130)
[lan.trigger\[N\].connected](#) (on page 11-131)
[lan.trigger\[N\].disconnect\(\)](#) (on page 11-131)
[lan.trigger\[N\].EVENT_ID](#) (on page 11-132)
[lan.trigger\[N\].ipaddress](#) (on page 11-132)
[lan.trigger\[N\].mode](#) (on page 11-133)
[lan.trigger\[N\].overrun](#) (on page 11-134)
[lan.trigger\[N\].protocol](#) (on page 11-135)
[lan.trigger\[N\].pseudostate](#) (on page 11-135)
[lan.trigger\[N\].stimulus](#) (on page 11-136)
[lan.trigger\[N\].wait\(\)](#) (on page 11-137)
[localnode.description](#) (on page 11-139)
[localnode.password](#) (on page 11-141)
[localnode.passwordmode](#) (on page 11-141)

Miscellaneous

[delay\(\)](#) (on page 11-42)
[exit\(\)](#) (on page 11-82)
[localnode.autolinefreq](#) (on page 11-138)
[localnode.linefreq](#) (on page 11-140)
[makegetter\(\)](#) (on page 11-146)
[makesetter\(\)](#) (on page 11-147)
[meminfo\(\)](#) (on page 11-148)
[opc\(\)](#) (on page 11-150)
[waitcomplete\(\)](#) (on page 11-393)

Parallel script execution

[dataqueue.add\(\)](#) (on page 11-38)
[dataqueue.CAPACITY](#) (on page 11-39)
[dataqueue.clear\(\)](#) (on page 11-39)
[dataqueue.count](#) (on page 11-40)
[dataqueue.next\(\)](#) (on page 11-41)
[node\[N\].execute\(\)](#) (on page 11-148)
[node\[N\].getglobal\(\)](#) (on page 11-149)
[node\[N\].setglobal\(\)](#) (on page 11-150)
[tsplink.group](#) (on page 11-365)
[tsplink.master](#) (on page 11-366)
[tsplink.node](#) (on page 11-366)

Queries and response messages

You can use the `print()`, `printbuffer()`, and `printnumber()` functions to query the instrument and generate response messages. The format attributes control how the data is formatted for the print functions used.

The `localnode` commands determine if generated errors are automatically sent and if prompts are generated.

[format.asciiprecision](#) (on page 11-89)

[format.byteorder](#) (on page 11-89)

[format.data](#) (on page 11-91)

[localnode.prompts](#) (on page 11-142)

[localnode.prompts4882](#) (on page 11-143)

[localnode.showerrors](#) (on page 11-146)

[print\(\)](#) (on page 11-153)

[printbuffer\(\)](#) (on page 11-154)

[printnumber\(\)](#) (on page 11-155)

Reading buffer

Reading buffers capture measurements, ranges, instrument status, and output states of the instrument.

[bufferVar.appendmode](#) (on page 11-17)

[bufferVar.basetimestamp](#) (on page 11-18)

[bufferVar.cachemode](#) (on page 11-19)

[bufferVar.capacity](#) (on page 11-20)

[bufferVar.clear\(\)](#) (on page 11-21)

[bufferVar.clearcache\(\)](#) (on page 11-22)

[bufferVar.collectsourcevalues](#) (on page 11-23)

[bufferVar.collecttimestamps](#) (on page 11-24)

[bufferVar.fillcount](#) (on page 11-25)

[bufferVar.fillmode](#) (on page 11-25)

[bufferVar.measurefunctions](#) (on page 11-26)

[bufferVar.measureranges](#) (on page 11-27)

[bufferVar.n](#) (on page 11-28)

[bufferVar.readings](#) (on page 11-29)

[bufferVar.sourcefunctions](#) (on page 11-30)

[bufferVar.sourceoutputstates](#) (on page 11-31)

[bufferVar.sourceranges](#) (on page 11-32)

[bufferVar.sourcevalues](#) (on page 11-33)

[bufferVar.statuses](#) (on page 11-34)

[bufferVar.timestampresolution](#) (on page 11-36)

[bufferVar.timestamps](#) (on page 11-37)

[savebuffer\(\)](#) (on page 11-156)

[smua.buffer.getstats\(\)](#) (on page 11-177)

[smua.buffer.recalculatestats\(\)](#) (on page 11-179)

[smua.makebuffer\(\)](#) (on page 11-193)

[smua.nvbufferY](#) (on page 11-211)

[smua.savebuffer\(\)](#) (on page 11-222)

Reset

Resets settings to their default settings.

- [digio.trigger\[N\].reset\(\)](#) (on page 11-49)
- [lan.reset\(\)](#) (on page 11-120)
- [localnode.reset\(\)](#) (on page 11-144)
- [reset\(\)](#) (on page 11-156)
- [smua.reset\(\)](#) (on page 11-222)
- [timer.reset\(\)](#) (on page 11-349)
- [trigger.blender\[N\].reset\(\)](#) (on page 11-352)
- [trigger.timer\[N\].reset\(\)](#) (on page 11-361)
- [tsplink.trigger\[N\].reset\(\)](#) (on page 11-374)

RS-232

- [serial.baud](#) (on page 11-168)
- [serial.databits](#) (on page 11-169)
- [serial.flowcontrol](#) (on page 11-170)
- [serial.parity](#) (on page 11-170)
- [serial.read\(\)](#) (on page 11-171)
- [serial.write\(\)](#) (on page 11-172)

Saved setups

Use the saved setups commands to save or restore the configurations to or from the nonvolatile memory of the instrument or an installed USB flash drive. You can use the `setup.poweron` attribute to specify which setup is recalled when the instrument is turned on.

- [setup.poweron](#) (on page 11-174)
- [setup.recall\(\)](#) (on page 11-175)
- [setup.save\(\)](#) (on page 11-176)

Scripting

Scripting helps you combine commands into a block of code that the instrument can run. Scripts help you communicate with the instrument efficiently. These commands describe how to create, load, modify, run, and exit scripts.

For detail on using scripts, see [Fundamentals of scripting for TSP](#) (on page 10-1).

- [exit\(\)](#) (on page 11-82)
- [makegetter\(\)](#) (on page 11-146)
- [makesetter\(\)](#) (on page 11-147)
- [script.anonymous](#) (on page 11-157)
- [script.delete\(\)](#) (on page 11-158)
- [script.factory.catalog\(\)](#) (on page 11-158)
- [script.load\(\)](#) (on page 11-159)

[script.new\(\)](#) (on page 11-160)
[script.newautorun\(\)](#) (on page 11-161)
[script.restore\(\)](#) (on page 11-162)
[script.run\(\)](#) (on page 11-162)
[script.user.catalog\(\)](#) (on page 11-163)
[scriptVar.autorun](#) (on page 11-163)
[scriptVar.list\(\)](#) (on page 11-164)
[scriptVar.name](#) (on page 11-165)
[scriptVar.run\(\)](#) (on page 11-166)
[scriptVar.save\(\)](#) (on page 11-166)
[scriptVar.source](#) (on page 11-167)

SMU

[localnode.linefreq](#) (on page 11-140)
[smua.abort\(\)](#) (on page 11-176)
[smua.buffer.getstats\(\)](#) (on page 11-177)
[smua.buffer.recalculatestats\(\)](#) (on page 11-179)
[smua.contact.check\(\)](#) (on page 11-188)
[smua.contact.r\(\)](#) (on page 11-190)
[smua.contact.speed](#) (on page 11-191)
[smua.contact.threshold](#) (on page 11-192)
[smua.makebuffer\(\)](#) (on page 11-193)
[smua.measure.autorangeY](#) (on page 11-194)
[smua.measure.autozero](#) (on page 11-195)
[smua.measure.count](#) (on page 11-197)
[smua.measure.delay](#) (on page 11-198)
[smua.measure.delayfactor](#) (on page 11-199)
[smua.measure.filter.count](#) (on page 11-199)
[smua.measure.filter.enable](#) (on page 11-200)
[smua.measure.filter.type](#) (on page 11-201)
[smua.measure.highcrangedelayfactor](#) (on page 11-202)
[smua.measure.interval](#) (on page 11-202)
[smua.measure.lowrangeY](#) (on page 11-203)
[smua.measure.nplc](#) (on page 11-204)
[smua.measure.overlappedY\(\)](#) (on page 11-205)
[smua.measure.rangeY](#) (on page 11-206)
[smua.measure.rel.enableY](#) (on page 11-207)
[smua.measure.rel.levelY](#) (on page 11-208)
[smua.measure.Y\(\)](#) (on page 11-209)
[smua.measureYandstep\(\)](#) (on page 11-210)
[smua.nvbufferY](#) (on page 11-211)
[smua.pulser.enable](#) (on page 11-212)
[smua.pulser.measure.aperture](#) (on page 11-213)
[smua.pulser.measure.delay](#) (on page 11-215)
[smua.pulser.protect.sensev](#) (on page 11-216)
[smua.pulser.protect.sourcev](#) (on page 11-217)
[smua.pulser.protect.tripped](#) (on page 11-218)
[smua.pulser.rangeY](#) (on page 11-220)

[smua.reset\(\)](#) (on page 11-222)
[smua.savebuffer\(\)](#) (on page 11-222)
[smua.sense](#) (on page 11-223)
[smua.source.autorangeY](#) (on page 11-224)
[smua.source.compliance](#) (on page 11-226)
[smua.source.delay](#) (on page 11-226)
[smua.source.func](#) (on page 11-227)
[smua.source.highc](#) (on page 11-228)
[smua.source.levelY](#) (on page 11-229)
[smua.source.limitY](#) (on page 11-230)
[smua.source.lowlrangeY](#) (on page 11-231)
[smua.source.offlimitY](#) (on page 11-232)
[smua.source.offmode](#) (on page 11-233)
[smua.source.output](#) (on page 11-234)
[smua.source.rangeY](#) (on page 11-235)
[smua.source.settling](#) (on page 11-236)
[smua.trigger.arm.count](#) (on page 11-237)
[smua.trigger.arm.set\(\)](#) (on page 11-238)
[smua.trigger.arm.stimulus](#) (on page 11-239)
[smua.trigger.ARMED_EVENT_ID](#) (on page 11-240)
[smua.trigger.autoclear](#) (on page 11-240)
[smua.trigger.count](#) (on page 11-241)
[smua.trigger.endpulse.action](#) (on page 11-243)
[smua.trigger.endpulse.set\(\)](#) (on page 11-243)
[smua.trigger.endpulse.stimulus](#) (on page 11-245)
[smua.trigger.endsweep.action](#) (on page 11-246)
[smua.trigger.IDLE_EVENT_ID](#) (on page 11-246)
[smua.trigger.initiate\(\)](#) (on page 11-247)
[smua.trigger.measure.action](#) (on page 11-248)
[smua.trigger.measure.set\(\)](#) (on page 11-249)
[smua.trigger.measure.stimulus](#) (on page 11-250)
[smua.trigger.measure.Y\(\)](#) (on page 11-251)
[smua.trigger.MEASURE_COMPLETE_EVENT_ID](#) (on page 11-252)
[smua.trigger.PULSE_COMPLETE_EVENT_ID](#) (on page 11-252)
[smua.trigger.source.action](#) (on page 11-253)
[smua.trigger.source.limitY](#) (on page 11-253)
[smua.trigger.source.linearY\(\)](#) (on page 11-254)
[smua.trigger.source.listY\(\)](#) (on page 11-255)
[smua.trigger.source.logY\(\)](#) (on page 11-256)
[smua.trigger.source.pulsewidth](#) (on page 11-258)
[smua.trigger.source.set\(\)](#) (on page 11-258)
[smua.trigger.source.stimulus](#) (on page 11-259)
[smua.trigger.SOURCE_COMPLETE_EVENT_ID](#) (on page 11-261)
[smua.trigger.SWEEP_COMPLETE_EVENT_ID](#) (on page 11-261)
[smua.trigger.SWEEPING_EVENT_ID](#) (on page 11-262)

Status model

The status model is a set of status registers and queues. You can use the following commands to manipulate and monitor these registers and queues to view and control various instrument events.

[status.condition](#) (on page 11-263)
[status.measurement.*](#) (on page 11-265)
[status.measurement.buffer_available.*](#) (on page 11-267)
[status.measurement.current_limit.*](#) (on page 11-268)
[status.measurement.instrument.*](#) (on page 11-270)
[status.measurement.instrument.smua.*](#) (on page 11-271)
[status.measurement.reading_overflow.*](#) (on page 11-274)
[status.measurement.voltage_limit.*](#) (on page 11-276)
[status.node_enable](#) (on page 11-277)
[status.node_event](#) (on page 11-279)
[status.operation.*](#) (on page 11-281)
[status.operation.calibrating.*](#) (on page 11-283)
[status.operation.instrument.*](#) (on page 11-284)
[status.operation.instrument.digio.*](#) (on page 11-286)
[status.operation.instrument.digio.trigger_overrun.*](#) (on page 11-288)
[status.operation.instrument.lan.*](#) (on page 11-290)
[status.operation.instrument.lan.trigger_overrun.*](#) (on page 11-292)
[status.operation.instrument.smua.*](#) (on page 11-294)
[status.operation.instrument.smua.trigger_overrun.*](#) (on page 11-296)
[status.operation.instrument.trigger_blender.*](#) (on page 11-298)
[status.operation.instrument.trigger_blender.trigger_overrun.*](#) (on page 11-299)
[status.operation.instrument.trigger_timer.*](#) (on page 11-301)
[status.operation.instrument.trigger_timer.trigger_overrun.*](#) (on page 11-302)
[status.operation.instrument.tsplink.*](#) (on page 11-304)
[status.operation.instrument.tsplink.trigger_overrun.*](#) (on page 11-305)
[status.operation.measuring.*](#) (on page 11-307)
[status.operation.remote.*](#) (on page 11-308)
[status.operation.sweeping.*](#) (on page 11-310)
[status.operation.trigger_overrun.*](#) (on page 11-311)
[status.operation.user.*](#) (on page 11-313)
[status.questionable.*](#) (on page 11-316)
[status.questionable.calibration.*](#) (on page 11-318)
[status.questionable.instrument.*](#) (on page 11-319)
[status.questionable.instrument.smua.*](#) (on page 11-320)
[status.questionable.over_temperature.*](#) (on page 11-322)
[status.questionable.unstable_output.*](#) (on page 11-323)
[status.request_enable](#) (on page 11-324)
[status.request_event](#) (on page 11-326)
[status.reset\(\)](#) (on page 11-328)
[status.standard.*](#) (on page 11-329)
[status.system.*](#) (on page 11-331)
[status.system2.*](#) (on page 11-333)
[status.system3.*](#) (on page 11-335)
[status.system4.*](#) (on page 11-338)
[status.system5.*](#) (on page 11-340)

Time

[bufferVar.basetimestamp](#) (on page 11-18)
[bufferVar.collecttimestamps](#) (on page 11-24)
[bufferVar.timestampresolution](#) (on page 11-36)
[bufferVar.timestamps](#) (on page 11-37)
[delay\(\)](#) (on page 11-42)
[gettimezone\(\)](#) (on page 11-97)
[os.time\(\)](#) (on page 11-152)
[settime\(\)](#) (on page 11-172)
[settimezone\(\)](#) (on page 11-173)
[timer.measure.t\(\)](#) (on page 11-349)
[timer.reset\(\)](#) (on page 11-349)

Triggering

Triggering allows you to source signals and capture measurements when an input signal or combination of input signals meet a set of conditions that you set. Triggering controls the timing of when source and measure operations happen during a sweep. See [Sweep operation](#) (on page 4-61) for details on sweeping.

[digio.trigger\[N\].assert\(\)](#) (on page 11-44)
[digio.trigger\[N\].clear\(\)](#) (on page 11-44)
[digio.trigger\[N\].EVENT_ID](#) (on page 11-45)
[digio.trigger\[N\].mode](#) (on page 11-45)
[digio.trigger\[N\].overrun](#) (on page 11-47)
[digio.trigger\[N\].pulsewidth](#) (on page 11-47)
[digio.trigger\[N\].release\(\)](#) (on page 11-48)
[digio.trigger\[N\].reset\(\)](#) (on page 11-49)
[digio.trigger\[N\].stimulus](#) (on page 11-50)
[digio.trigger\[N\].wait\(\)](#) (on page 11-51)
[display.trigger.clear\(\)](#) (on page 11-72)
[display.trigger.EVENT_ID](#) (on page 11-73)
[display.trigger.overrun](#) (on page 11-73)
[display.trigger.wait\(\)](#) (on page 11-74)
[lan.trigger\[N\].assert\(\)](#) (on page 11-129)
[lan.trigger\[N\].clear\(\)](#) (on page 11-129)
[lan.trigger\[N\].connect\(\)](#) (on page 11-130)
[lan.trigger\[N\].connected](#) (on page 11-131)
[lan.trigger\[N\].disconnect\(\)](#) (on page 11-131)
[lan.trigger\[N\].EVENT_ID](#) (on page 11-132)
[lan.trigger\[N\].ipaddress](#) (on page 11-132)
[lan.trigger\[N\].mode](#) (on page 11-133)
[lan.trigger\[N\].overrun](#) (on page 11-134)
[lan.trigger\[N\].protocol](#) (on page 11-135)
[lan.trigger\[N\].pseudostate](#) (on page 11-135)
[lan.trigger\[N\].stimulus](#) (on page 11-136)
[lan.trigger\[N\].wait\(\)](#) (on page 11-137)
[smua.pulser.measure.delay](#) (on page 11-215)

[smua.trigger.arm.count](#) (on page 11-237)
[smua.trigger.arm.set\(\)](#) (on page 11-238)
[smua.trigger.arm.stimulus](#) (on page 11-239)
[smua.trigger.ARMED_EVENT_ID](#) (on page 11-240)
[smua.trigger.autoclear](#) (on page 11-240)
[smua.trigger.count](#) (on page 11-241)
[smua.trigger.endpulse.action](#) (on page 11-243)
[smua.trigger.endpulse.set\(\)](#) (on page 11-243)
[smua.trigger.endpulse.stimulus](#) (on page 11-245)
[smua.trigger.endsweep.action](#) (on page 11-246)
[smua.trigger.IDLE_EVENT_ID](#) (on page 11-246)
[smua.trigger.initiate\(\)](#) (on page 11-247)
[smua.trigger.measure.action](#) (on page 11-248)
[smua.trigger.measure.set\(\)](#) (on page 11-249)
[smua.trigger.measure.stimulus](#) (on page 11-250)
[smua.trigger.measure.Y\(\)](#) (on page 11-251)
[smua.trigger.MEASURE_COMPLETE_EVENT_ID](#) (on page 11-252)
[smua.trigger.PULSE_COMPLETE_EVENT_ID](#) (on page 11-252)
[smua.trigger.source.action](#) (on page 11-253)
[smua.trigger.source.limitY](#) (on page 11-253)
[smua.trigger.source.linearY\(\)](#) (on page 11-254)
[smua.trigger.source.listY\(\)](#) (on page 11-255)
[smua.trigger.source.logY\(\)](#) (on page 11-256)
[smua.trigger.source.pulsewidth](#) (on page 11-258)
[smua.trigger.source.set\(\)](#) (on page 11-258)
[smua.trigger.source.stimulus](#) (on page 11-259)
[smua.trigger.SOURCE_COMPLETE_EVENT_ID](#) (on page 11-261)
[smua.trigger.SWEEP_COMPLETE_EVENT_ID](#) (on page 11-261)
[smua.trigger.SWEEPING_EVENT_ID](#) (on page 11-262)
[trigger.blender\[N\].clear\(\)](#) (on page 11-350)
[trigger.blender\[N\].EVENT_ID](#) (on page 11-350)
[trigger.blender\[N\].orenable](#) (on page 11-351)
[trigger.blender\[N\].overrun](#) (on page 11-352)
[trigger.blender\[N\].reset\(\)](#) (on page 11-352)
[trigger.blender\[N\].stimulus\[M\]](#) (on page 11-353)
[trigger.blender\[N\].wait\(\)](#) (on page 11-354)
[trigger.clear\(\)](#) (on page 11-355)
[trigger.EVENT_ID](#) (on page 11-355)
[trigger.generator\[N\].assert\(\)](#) (on page 11-356)
[trigger.generator\[N\].EVENT_ID](#) (on page 11-356)
[trigger.timer\[N\].clear\(\)](#) (on page 11-357)
[trigger.timer\[N\].count](#) (on page 11-357)
[trigger.timer\[N\].delay](#) (on page 11-358)
[trigger.timer\[N\].delaylist](#) (on page 11-359)
[trigger.timer\[N\].EVENT_ID](#) (on page 11-360)
[trigger.timer\[N\].overrun](#) (on page 11-360)
[trigger.timer\[N\].passthrough](#) (on page 11-361)
[trigger.timer\[N\].reset\(\)](#) (on page 11-361)
[trigger.timer\[N\].stimulus](#) (on page 11-362)

[trigger.timer\[N\].wait\(\)](#) (on page 11-364)
[trigger.wait\(\)](#) (on page 11-364)
[tsplink.trigger\[N\].assert\(\)](#) (on page 11-369)
[tsplink.trigger\[N\].clear\(\)](#) (on page 11-370)
[tsplink.trigger\[N\].EVENT_ID](#) (on page 11-370)
[tsplink.trigger\[N\].mode](#) (on page 11-371)
[tsplink.trigger\[N\].overrun](#) (on page 11-372)
[tsplink.trigger\[N\].pulsewidth](#) (on page 11-373)
[tsplink.trigger\[N\].release\(\)](#) (on page 11-374)
[tsplink.trigger\[N\].reset\(\)](#) (on page 11-374)
[tsplink.trigger\[N\].stimulus](#) (on page 11-375)
[tsplink.trigger\[N\].wait\(\)](#) (on page 11-376)

TSP-Link

These functions and attributes allow you to set up and work with a system that is connected by a TSP-Link® network.

[tsplink.group](#) (on page 11-365)
[tsplink.master](#) (on page 11-366)
[tsplink.node](#) (on page 11-366)
[tsplink.readbit\(\)](#) (on page 11-367)
[tsplink.readport\(\)](#) (on page 11-367)
[tsplink.reset\(\)](#) (on page 11-368)
[tsplink.state](#) (on page 11-369)
[tsplink.trigger\[N\].assert\(\)](#) (on page 11-369)
[tsplink.trigger\[N\].clear\(\)](#) (on page 11-370)
[tsplink.trigger\[N\].EVENT_ID](#) (on page 11-370)
[tsplink.trigger\[N\].mode](#) (on page 11-371)
[tsplink.trigger\[N\].overrun](#) (on page 11-372)
[tsplink.trigger\[N\].pulsewidth](#) (on page 11-373)
[tsplink.trigger\[N\].release\(\)](#) (on page 11-374)
[tsplink.trigger\[N\].reset\(\)](#) (on page 11-374)
[tsplink.trigger\[N\].stimulus](#) (on page 11-375)
[tsplink.trigger\[N\].wait\(\)](#) (on page 11-376)
[tsplink.writebit\(\)](#) (on page 11-377)
[tsplink.writeport\(\)](#) (on page 11-378)
[tsplink.writeprotect](#) (on page 11-378)

TSP-Net

The TSP-Net module provides a simple socket-like programming interface to Test Script Processor (TSP®) enabled instruments.

[tspnet.clear\(\)](#) (on page 11-379)
[tspnet.connect\(\)](#) (on page 11-380)
[tspnet.disconnect\(\)](#) (on page 11-381)
[tspnet.execute\(\)](#) (on page 11-382)
[tspnet.idn\(\)](#) (on page 11-383)

[tspnet.read\(\)](#) (on page 11-383)
[tspnet.readavailable\(\)](#) (on page 11-384)
[tspnet.reset\(\)](#) (on page 11-385)
[tspnet.termination\(\)](#) (on page 11-385)
[tspnet.timeout](#) (on page 11-386)
[tspnet.tsp.abort\(\)](#) (on page 11-387)
[tspnet.tsp.abortonconnect](#) (on page 11-387)
[tspnet.tsp.rtablecopy\(\)](#) (on page 11-388)
[tspnet.tsp.runscript\(\)](#) (on page 11-389)
[tspnet.write\(\)](#) (on page 11-390)

Userstrings

Use the functions in this group to store and retrieve user-defined strings in nonvolatile memory. These strings are stored as key-value pairs. The key is a unique identifier such as a part number or identification string.

You can use the `userstring` functions to store custom, instrument-specific information in the instrument, such as department number, asset number, or manufacturing plant location.

[userstring.add\(\)](#) (on page 11-390)
[userstring.catalog\(\)](#) (on page 11-391)
[userstring.delete\(\)](#) (on page 11-392)
[userstring.get\(\)](#) (on page 11-393)

Factory scripts

The Keithley Instruments 2601B-PULSE System SourceMeter® Instrument is shipped with one or more factory scripts saved in its flash firmware memory. A factory script is made up of a number of functions. Some of them can be called from the front-panel LOAD TEST menu. All of them can be called using remote programming.

As Keithley Instruments develops additional factory scripts, they will be made available on tek.com/keithley as a flash firmware upgrade for the 2601B-PULSE. See [Upgrading the firmware](#) (on page 8-5) for instructions on upgrading the flash firmware of your 2601B-PULSE instrument.

A factory script is similar to a user script, except a factory script is created by Keithley Instruments at the factory and is permanently stored in nonvolatile memory. The differences between a user script and a factory script include the following:

- A factory script cannot be deleted from nonvolatile memory.
- The script listing for a factory script can be retrieved and modified, but it is then treated as a user script. A user script cannot be saved as a factory script.
- Factory scripts are not stored in global variables. The only references to factory scripts are in the `script.factory.scripts` attribute.
- The `script.factory.catalog()` function returns an iterator that can be used in a `for` loop to iterate over all the factory scripts.

Example

To retrieve the catalog listing for factory scripts, send:

```
for name in script.factory.catalog() do print(name) end
```

Running a factory script

Use either of the following commands to run a factory script:

```
script.factory.scripts.name()  
script.factory.scripts.name.run()
```

Where: *name* is the name of the factory script.

Example:

Run the factory script named `KISweep`.

```
script.factory.scripts.KISweep()
```

Running a factory script function from the front-panel controls

1. Press the **LOAD** key.
2. Select **FACTORY**.
3. Select the function to run and press the **ENTER** key or navigation wheel .
4. Press the **RUN** key.
5. Follow the prompts on the front panel to run the script.

Retrieving and modifying a factory script listing

The script listing for a factory script can be retrieved and modified. However, it cannot be saved as a factory script. The modified script can be saved as a user script using the same name or a new name.

An imported factory script can only be loaded back into the 2601B-PULSE as a user script.

The following function retrieves a script listing. The script code is output with the shell keywords (`loadscript` or `loadandrunscript` and `endscript`):

```
script.factory.scripts.name.list()
```

Where: *name* is the name of the factory script.

An example that retrieves the script listing for a factory script named `KISweep`:

```
script.factory.scripts.KISweep.list()
```

KISweep factory script

The KISweep factory script provides simple sweep test programming and shows how to use the sweeping function.

This script is made up of the following functions. Access these functions from the front panel or the remote interfaces. The following functions make up the KISweep factory script:

[SweepLinMeasureV\(\)](#) (on page 11-342)

[SweepListMeasureV\(\)](#) (on page 11-343)

[SweepLogMeasureV\(\)](#) (on page 11-344)

[SweepVLinMeasureI\(\)](#) (on page 11-345)

[SweepVListMeasureI\(\)](#) (on page 11-346)

[SweepVLogMeasureI\(\)](#) (on page 11-347)

KIHighC factory script

The KIHighC factory script is made up of two functions: `i_leakage_measure()` and `i_leakage_threshold()`. These functions are intended to be used when high capacitance mode is active. Output is generally at a nonzero voltage before calling these functions. These functions can also be used to step the voltage to zero volts in order to measure the leakage current.

[i_leakage_measure\(\)](#) (on page 11-100)

[i_leakage_threshold\(\)](#) (on page 11-101)

KIParlib factory script

The KIParlib factory script is made up of two functions: `gm_vsweep()` and `gm_ismweep()`.

[gm_vsweep\(\)](#) (on page 11-98)

[gm_ismweep\(\)](#) (on page 11-97)

KISavebuffer factory script

The KISavebuffer script has one function: `savebuffer()`.

[savebuffer\(\)](#) (on page 11-156)

Instrument programming

In this section:

Fundamentals of scripting for TSP	10-1
Fundamentals of programming for TSP	10-13
Test Script Builder	10-30
Password management	10-34
Advanced scripting for TSP	10-36
TSP-Link system expansion interface	10-45
TSP-Net	10-58

Fundamentals of scripting for TSP

NOTE

Though it can improve your process to use scripts, you do not have to create scripts to use the instrument. Most of the examples in the documentation can be run by sending individual command messages. The next few sections of the documentation describe scripting and programming features of the instrument. You only need to review this information if you are using scripting and programming.

Scripting helps you combine commands into a block of code that the instrument can run. Scripts help you communicate with the instrument more efficiently.

Scripts offer several advantages compared to sending individual commands from the host controller (computer):

- Scripts are easier to save, refine, and implement than individual commands.
- The instrument performs more quickly and efficiently when it processes scripts than it does when it processes individual commands.
- You can incorporate features such as looping and branching into scripts.
- Scripts allow the controller to perform other tasks while the instrument is running a script, enabling some parallel operation.
- Scripts eliminate repeated data transfer times from the controller.

In the instrument, the Test Script Processor (TSP®) scripting engine processes and runs scripts.

This section describes how to create, load, modify, and run scripts.

What is a script?

A script is a collection of instrument control commands and programming statements. Scripts that you create are referred to as **user scripts**.

Your scripts can be interactive. Interactive scripts display messages on the front panel of the instrument that prompt the operator to enter parameters.

Runtime and nonvolatile memory storage of scripts

Scripts are loaded into the runtime environment of the instrument. From there, they can be stored in nonvolatile memory in the instrument.

The runtime environment is a collection of global variables, which include scripts, that the user has defined. A global variable can be used to store a value while the instrument is turned on. When you create a script, the instrument creates a global variable with the same name so that you can reference the script more conveniently. After scripts are loaded into the runtime environment, you can run and manage them from the front panel of the instrument or from a computer. Information in the runtime environment is lost when the instrument is turned off.

Nonvolatile memory is where information is stored even when the instrument is turned off. Save scripts to nonvolatile memory to save them even if the power is cycled. The scripts that are in nonvolatile memory are loaded into the runtime environment when the instrument is turned on.

Scripts are placed in the runtime environment when:

- The instrument is turned on. All scripts that are saved to nonvolatile memory are copied to the runtime environment when the instrument is turned on.
- Loaded over a remote command interface.

For detail on the amount of memory available in the runtime environment, see [Memory considerations for the runtime environment](#) (on page 10-44).

NOTE

If you make changes to a script in the runtime environment, the changes are lost when the instrument is turned off. To save the changes, you must save them to nonvolatile memory. See [Working with scripts in nonvolatile memory](#) (on page 10-10).

What can be included in scripts?

Scripts can include combinations of Test Script Processor (TSP®) commands and Lua code. TSP commands instruct the instrument to do one thing and are described in the command reference (see [TSP commands](#) (on page 11-8)). Lua is a scripting language that is described in [Fundamentals of programming for TSP](#) (on page 10-13).

Commands that cannot be used in scripts

Though the instrument accepts the following commands, you cannot use these commands in scripts.

Commands that cannot be used in scripts

General commands	IEEE Std 488.2 common commands	
abort	*CLS	*RST
endflash	*ESE	*SRE
endscript	*ESE?	*SRE?
flash	*ESR?	*STB?
loadscript	*IDN?	*TRG
loadandrunscript	*OPC	*TST?
password	*OPC?	*WAI
restoreglobals		

Manage scripts

This section describes how to create scripts by sending commands over the remote interface.

Tools for managing scripts

To manage scripts, you can send messages to the instrument, use your own development tool or program, or use Keithley Instruments Test Script Builder (TSB) software. TSB software is a programming tool that you can download from the [Product Support web page \(tek.com/product-support\)](http://tek.com/product-support). You can use it to create, modify, debug, and store Test Script Processor (TSP®) scripting engine scripts. For more information about using the TSB software, see [Using Test Script Builder \(TSB\)](#) (on page 10-31).

NOTE

If you are using TSB to create scripts, you do not need to use the commands `loadscript` or `loadandrunscript` and `endscript`.

Create and load a script

You create scripts by loading them into the runtime environment of the instrument. You can load a script as a named script or as the anonymous script.

Once a script is loaded into the instrument, you can execute it remotely or from the front panel.

Anonymous scripts

If a script is created with the `loadscript` or `loadandrunscript` command with no name defined, it is called the anonymous script. There can only be one anonymous script in the runtime environment. If another anonymous script is loaded into the runtime environment, it replaces the existing anonymous script.

Named scripts

A named script is a script with a unique name. You can have as many named scripts as needed in the instrument (within the limits of the memory available to the runtime environment). When a named script is loaded into the runtime environment with the `loadscript` or `loadandrunscript` commands, a global variable with the same name is created to reference the script.

Key points regarding named scripts:

- If you load a new script with the same name as an existing script, the existing script becomes an unnamed script, which in effect removes the existing script if there are no variables that reference it.
- Sending revised scripts with different names will not remove previously loaded scripts.
- Named scripts can be saved to internal nonvolatile memory. Saving a named script to nonvolatile memory allows the instrument to be turned off without losing the script. See [Working with scripts in nonvolatile memory](#) (on page 10-10).

Load a script by sending commands over the remote interface

To load a script over the remote interface, you can use the `loadscript`, `loadandrunscript`, and `endscript` commands.

The `loadscript` and `loadandrunscript` commands start the collection of messages that make up the script. When the instrument receives either of these commands, it starts collecting all subsequent messages. Without these commands, the instrument would run them immediately as individual commands.

The `endscript` command tells the instrument to compile the collection of messages. It compiles the messages into one group of commands. This group of commands is loaded into the runtime environment.

The following figure shows an example of how to load a script named “test.” The first command tells the instrument to start collecting the messages for the script named “test.” The last command marks the end of the script. When this script is run, the message `This is a test` is displayed on the instrument and sent to the computer.

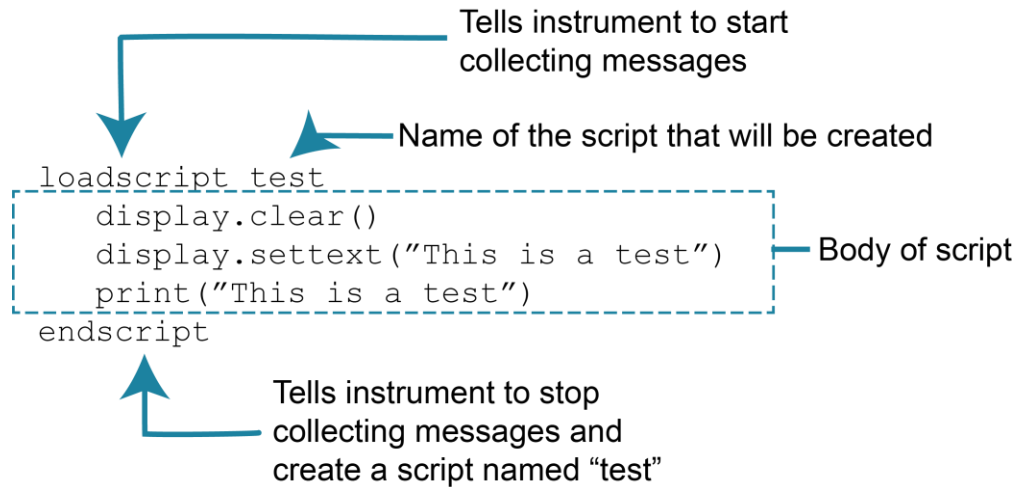
Figure 129: Loadscript and endscript example**To load a named script by sending commands:**

1. Send the command `loadscript scriptName`, where *scriptName* is the name of the script. The name must be a legal Lua variable name.
2. Send the commands that need to be included in the script.
3. Send the command `endscript`.
4. You can now run the script. See [Run scripts](#) (on page 10-7).

NOTE

To run the script immediately, use `loadandruncscript scriptName` instead of `loadscript`.

Load a script from the instrument front panel

You can also load scripts from a USB flash drive to the runtime environment of the instrument. Depending on the content of the TSP file on the drive, the script can be loaded either as an anonymous script without a designated name, or as a named script with a user-defined name. Only named scripts can be saved to internal nonvolatile memory. Only one anonymous script can exist in the runtime environment.

To load a script into the instrument with a specific name, the TSP file must include the shell keywords `loadscript` and `endscript`, along with the specified script name, as shown in the example file `MyScript1.tsp`, which contains the script:

```

loadscript Beeper
reset()
beeper.enable = beeper.ON
beeper.beep(2, 2400)
endscript

```

When you load the file `MyScript1.tsp` from the flash drive, a script named `Beeper` is created in the runtime environment. Note that the script is named using the name that follows the `loadscript` keyword, not the name of the TSP file on the flash drive. After the script is loaded, you can choose to save it to nonvolatile memory.

If the loaded file does not contain `loadscript` and `endscript` keywords, or if no name is included after the `loadscript` keyword, the code is loaded as the anonymous script. Loading an unnamed script overwrites the existing anonymous script. For example, if a file named `MyScript2.tsp` contains only the following code, the script is loaded as the anonymous script:

```
reset ()
beeper.enable = beeper.ON
beeper.beep(2, 2400)
```

The file must be a valid script file. If not, an error message is posted and no further action is taken. You can view the errors on the front panel of the instrument.

To load a script from a USB flash drive:

1. Insert the flash drive into the USB port on the instrument.
2. Select the **MENU** key.
3. Select the **SCRIPT** option.
4. Select the **LOAD** option.
5. Select the **USB1** option. A menu is displayed that lists the TSP files and directories on the flash drive.
6. If the files are in a directory, use the navigation wheel to select the directory. A new menu is displayed that lists the TSP files and directories in that directory.
7. Use the navigation wheel to select the TSP file you want to load.
8. If the script has the same name as a script that is already in memory, you are prompted to overwrite the script.
 - Select **Yes** to continue.
 - Select **No** to return to the list of files. You must select a file to continue.
9. The **SCRIPT ACTION** menu is displayed. You can select:
 - **SAVE-INTERNAL:** Save the file to nonvolatile memory. This is the same as sending `scriptVar.save()` with no parameters.
 - **ACTIVE-FOR-RUN:** Set the script to run from the **RUN** button.
10. Loading is complete. To return to the **MAIN** menu, press **EXIT (LOCAL)** until the **MAIN** menu is displayed.
11. If you selected **ACTIVE-FOR-RUN**, you can select **RUN** to run the script.

NOTE

The entries in the **SCRIPT ACTION** menu depend on whether the script that was loaded is a named script or the anonymous script. If it is a named script, both **SAVE-INTERNAL** and **ACTIVE-FOR-RUN** appear in the menu. If it is the anonymous script, then only **ACTIVE-FOR-RUN** appears in the menu.

Run scripts

This section describes how to run the anonymous and named scripts.

On the front panel, items are available through the USER menu if you explicitly add them to the menu. The items the menu selections represent can be scripts, function calls, or instrument commands. Items in the menus are referred to as scripts in this section.

The SCRIPTS menu lists the names of scripts in nonvolatile memory or scripts that have been added to the runtime environment. The anonymous script also appears in this menu.

NOTE

If the instrument is in local control when the script is started, it switches to remote control (`REM` is displayed) while the script is running. The instrument is returned to local control when the script completes. If you press the front-panel **EXIT (LOCAL)** key while the script is running, the script is stopped.

Run the anonymous script

The anonymous script can be run many times without reloading it. It remains in the runtime environment until a new anonymous script is created or until the instrument is turned off.

To run the anonymous script, use any one of these commands:

- `run()`
- `script.run()`
- `script.anonymous()`
- `script.anonymous.run()`

Run a named script

You can run any named script that is in the runtime environment using one of the following commands:

- `scriptVar()`
- `scriptVar.run()`

Where `scriptVar` is the user-defined name of the script.

When a script is named, it can be accessed using the global variable `scriptVar`.

Example: Run a named script

```
test3()
```

If the script `test3` is loaded into the runtime environment, the instrument executes `test3`.

Run a user script from the instrument front panel

From the front panel, you can load and run a script that was previously added to the USER menu.

To run the code from the front panel and add it to the USER menu:

1. Select the **LOAD** key.
2. Select **USER**.
3. Select the script from list and press the **ENTER** key. The script is loaded into the runtime environment.

NOTE

If you are used to using `print` in Test Script Builder, note that the output of the print commands using this procedure will not function the same as when you are in Test Script Builder. You may find that it makes more sense to use Test Script Builder to get the output you need.

4. Press the **RUN** key to execute.

To run a script directly without adding it to the USER menu:

1. Select the **LOAD** key.
2. Select **SCRIPTS** and select the **ENTER** key. There may be a short pause before a menu is displayed that represents the scripts in the instrument.
3. Select the script from the list and select the **ENTER** key. The script is now loaded for front-panel execution.
4. Press the **RUN** key to execute.

NOTE

If you are used to using `print` in Test Script Builder, note that the output of the prints using this procedure will not function the same as when you are in Test Script Builder. You may find that it makes more sense to use Test Script Builder to get the output you need.

Scripts that run automatically

You can set up scripts to run automatically when you power on the instrument. To do this, either set the `autorun` attribute for the script to `yes` (see [Autorun scripts](#) (on page 10-9)), or create a script with the script name `autoexec` (see [Autoexec script](#) (on page 10-9)).

Autorun scripts

Autorun scripts run automatically when the instrument is turned on. You can set any number of scripts to autorun. The run order for autorun scripts is arbitrary, so make sure the run order is not important.

As shown in the example below, you can set a script to run automatically by setting the `.autorun` attribute of the script to `"yes"` and then saving the script.

Example:

```
scriptVar.autorun = "yes"
scriptVar.save()
```

Where: `scriptVar` is the user-defined name of the script.

To disable autorun, set the `.autorun` attribute of the script to `no` and then save the script.

NOTE

The `scriptVar.save()` command saves the script to nonvolatile memory, which makes the change persistent through a power cycle. See [Save a user script to nonvolatile memory](#) (on page 10-10) for more detail.

Example: Set a script to run automatically

```
test5.autorun = "yes"
test5.save()
```

Assume a script named `test5` is in the runtime environment. The next time the instrument is turned on, `test5` script automatically loads and runs.

Autoexec script

The autoexec script runs automatically when the instrument is turned on. It runs after all the scripts have loaded and any scripts defined as autorun have run.

To create a script that executes automatically, create and load a new script and name it `autoexec`. See [Create and load a script](#) (on page 10-3).

NOTE

You must save the `autoexec` script to nonvolatile memory if you want to use it after instrument power has been turned off and then turned on again. See [Save a user script to nonvolatile memory](#) (on page 10-10) for more detail.

Example: Creating an autoexec script with the loadscript command

```
loadscript autoexec
display.clear()
display.settext("Hello from autoexec")
endscript
autoexec.save()
```

Creates the script `autoexec`. Saves the `autoexec` script to nonvolatile memory. The next time the instrument is turned on, `Hello from autoexec` is displayed.

Working with scripts in nonvolatile memory

The [Fundamentals of scripting for TSP](#) (on page 10-1) section in this manual describes working with scripts, primarily in the runtime environment. You can also work with scripts in nonvolatile memory.

The runtime environment and nonvolatile memory are separate storage areas in the instrument. The information in the runtime environment is lost when the instrument is turned off. The nonvolatile memory remains intact when the instrument is turned off. When the instrument is turned on, information in nonvolatile memory is loaded into the runtime environment.

Save a user script

You can save scripts to nonvolatile memory using commands.

Only named scripts can be saved to nonvolatile memory. The anonymous script must be named before it can be saved to nonvolatile memory.

NOTE

If a script is not saved to nonvolatile memory, the script is lost when the instrument is turned off.

To save a script to nonvolatile memory:

1. Create and load a named script (see [Create and load a script](#) (on page 10-3)).
2. Send the command `scriptVar.save()`, where `scriptVar` is the name of the script.

Example: Save a user script to nonvolatile memory

```
test1.save()
```

Assume a script named `test1` has been loaded. `test1` is saved into nonvolatile memory.

To save a script to an external USB flash drive:

NOTE

When you save a script to a USB flash drive, you do not need to specify a file extension. The extension `.tsp` is automatically added. If you do specify a file extension, it must be `.tsp`. An error will occur if you use any other file extension.

1. Load a script (see [Create and load a script](#) (on page 10-3)).
2. Send the command `scriptVar.save("/usb1/filename.tsp")`, where `scriptVar` is the variable referencing the script and `filename.tsp` is the name of the file.

Save the anonymous script as a named script

To save the anonymous script to nonvolatile memory, you must name it first.

To save the anonymous script as a named script:

1. To name the script, send the command `script.anonymous.name = "myTest"` (where *myTest* is the name of the script).
2. Send the `script.anonymous.save()` command to save *myTest* to nonvolatile memory.

Save a script from the instrument front panel

You can save scripts from the runtime environment to nonvolatile memory or the USB port on the instrument front panel.

NOTE

If you want to save the anonymous script to nonvolatile memory, you must name it first. See [Save the anonymous script as a named script](#) (on page 10-11).

To save a script to nonvolatile memory from the front panel:

1. Select the **MENU** key.
2. Select the **SCRIPT** option.
3. Select the **SAVE** option.
A list of the scripts available to save is displayed. It may take a few seconds to display. The displayed list is from the `script.user.scripts` table in the instrument.
4. Turn the navigation wheel to select the script that you want to save.
5. Select **INTERNAL**. Press the navigation wheel. The script is saved to nonvolatile memory using the name attribute of the script.
6. Press **EXIT (LOCAL)** several times to return to the Main Menu.

Delete user scripts

NOTE

These steps remove a script from nonvolatile memory. To completely remove a script from the instrument, there are additional steps you must take. See [Delete user scripts from the instrument](#) (on page 10-43).

To delete a script from nonvolatile memory using a remote interface:

You can delete the script from nonvolatile memory by sending either of the following commands:

- `script.delete("name")`
- `script.user.delete("name")`

Where: *name* is the user-defined name of the script.

Example: Delete a user script from nonvolatile memory

```
script.delete("test8")
```

Delete a user script named `test8` from nonvolatile memory.

Interactive script example

An interactive script prompts the operator to input values using front panel controls. The following example script uses display messages to prompt the operator to:

- Enter the voltage level to source
- Enable or disable measurements
- Set the number of readings if measurements are enabled

After the operator completes entering values, the output turns on and sources the specified value. If measurements were enabled, a message indicates that measurements are in progress. Another message is displayed when the source-measure operation is complete. If measurements were not enabled, the message indicates that the source operation is complete.

When an input prompt is displayed, the script waits until the operator inputs the parameter or presses the ENTER key. The example shown here assumes that you are using TSB. If you are using a remote interface, you need to add the `loadscript` and `endscript` commands to the example code. See [Load a script by sending commands over the remote interface](#) (on page 10-4) for details.

```
reset()
-- Clear the display.
display.clear()

-- Prompt the user for a voltage value to source.
srcVoltage = display.prompt("+000.00", " V", "Enter source voltage", 5, -20, 20)

-- Prompt the user to enable measurements.
measEnable = display.menu("Measurements?", "ENABLE DISABLE")
if measEnable == "ENABLE" then
    -- Prompt the user for the number of measurements.
    numMeas = display.prompt("0000", " Rdgs", "Enter the number of readings", 10,
        0, 9999)
    smua.measure.count = numMeas
    smua.nvbuffer1.clear()
end

-- Convert user input to the source level.
smua.source.levelv = tonumber(srcVoltage)
smua.source.output = smua.OUTPUT_ON
```

```
if measEnable == "ENABLE" then
    -- Inform the user that measurements are in progress
    display.setCursor(1, 1)
    display.setText("$BPlease wait.$R$NMeasure operation in progress.")
    smua.measure.i(smua.nvbuffer1)
    display.clear()
    -- Inform the user that the Source Measure operation has finished
    display.setText("Operation Finished$NSource-Measure Complete")
else
    -- Inform the user that the Source operation has finished
    display.setText("Operation Finished$NSource Complete")
end

-- Wait 5 seconds then return to the main screen.
delay(5)
display.screen = display.SMUA
```

Fundamentals of programming for TSP

To conduct a test, a computer (controller) is programmed to send sequences of commands to an instrument. The controller orchestrates the actions of the instrumentation. The controller is typically programmed to request measurement results from the instrumentation and make test sequence decisions based on those measurements.

To take advantage of the advanced features of the instrument, you can add programming commands to your scripts. Programming commands control script execution and provide tools such as variables, functions, branching, and loop control.

The Test Script Processor (TSP[®]) scripting engine is a Lua interpreter. In TSP-enabled instruments, the Lua programming language has been extended with Keithley-specific instrument control commands.

What is Lua?

Lua is a programming language that can be used with TSP-enabled instruments. Lua is an efficient language with simple syntax that is easy to learn.

Lua is also a scripting language, which means that scripts are compiled and run when they are sent to the instrument. You do not compile them before sending them to the instrument.

Lua basics

This section contains the basics about the Lua programming language to allow you to start adding Lua programming commands to your scripts quickly.

For more information about Lua, see the [Lua website \(lua.org\)](http://lua.org). Another source of useful information is the [Lua users group \(lua-users.org\)](http://lua-users.org), created for and by users of Lua programming language.

Comments

You can start a comment anywhere outside a string by typing a double hyphen (--). If the text immediately after -- is anything other than double left brackets ([[), the comment is a short comment, which continues until the end of the line.

If -- is followed by [[, the following characters are a long comment, which continues until double right brackets (]] close the comment. Long comments may continue for several lines and may contain nested [[...]] pairs. The example below shows how to use code comments.

An example of a short comment is:

```
-- Turn off the front-panel display.
```

An example of a long comment is:

```
--[[Display a menu with three menu items. If the second menu item is selected,
the selection will be given the value Test2.]]
```

Function and variable name restrictions

You cannot use factory script names, functions created by factory scripts, Lua reserved words and top-level command names for function or variable names.

For information on factory script names, see [Factory scripts](#) (on page 9-19).

You cannot use the following Lua reserved words for function or variable names.

Lua reserved words		
and	for	or
break	function	repeat
do	if	return
else	in	then
elseif	local	true
end	nil	until
false	not	while

You also cannot use top-level command names as variable names. If you use these names, it will result in the loss of use of the commands. For example, if you send the command `digio = 5`, you cannot access the `digio.*` commands until you turn the instrument power off and then turn it on again. These names include:

Top level command names			
beeper	gcinfo	os	status
bit	gettimezone	print	string
collectgarbage	gpib	printbuffer	timer
dataqueue	io	printnumber	tonumber
delay	lan	reset	tostring
digio	localnode	savebuffer	trigger
display	makegetter	script	tsplink
errorqueue	makesetter	serial	tspnet
eventlog	math	settime	type
exit	meminfo	settimezone	userstring
format	node	setup	waitcomplete
fs	opc	smua	

Values and variable types

In Lua, you use variables to store values in the runtime environment for later use.

Lua is a dynamically-typed language; the type of the variable is determined by the value that is assigned to the variable.

Variables in Lua are assumed to be global unless they are explicitly declared to be local. A global variable is accessible by all commands. Global variables do not exist until they have been assigned a value.

Variable types

Variables can be one of the following types.

Variable types and values

Variable type returned	Value	Notes
"nil"	not declared	The type of the value <code>nil</code> , whose main property is to be different from any other value; usually it represents the absence of a useful value.
"boolean"	true or false	Boolean is the type of the values <code>false</code> and <code>true</code> . In Lua, both <code>nil</code> and <code>false</code> make a condition <code>false</code> ; any other value makes it <code>true</code> .
"number"	number	All numbers are real numbers; there is no distinction between integers and floating-point numbers.
"string"	sequence of words or characters	
"function"	a block of code	Functions perform a task or compute and return values.
"table"	an array	New tables are created with <code>{ }</code> braces. For example: <code>{1, 2, 3.00e0}</code>
"userdata"	variables	Allows arbitrary program data to be stored in Lua variables.
"thread"	line of execution	

To determine the type of a variable, you can call the `type()` function, as shown in the examples below.

NOTE

The output you get from these examples may vary depending on the data format that is set.

Example: Nil

```
x = nil
print(x, type(x))
```

nil nil

Example: Boolean

```
y = false
print(y, type(y))
```

false boolean

Example: String and number

```
x = "123"
print(x, type(x))

x = x + 7
print(x, type(x))
```

123 string

Adding a number to x forces its type to number.
130 number

Example: Function

```
function add_two(first_value,
  second_value)
  return first_value + second_value
end
print(add_two(3, 4), type(add_two))
```

7 function

Example: Table

```
atable = {1, 2, 3, 4}
print(atable, type(atable))
print(atable[1])
print(atable[4])
```

Defines a table with four numeric elements.
Note that the "table" value (shown here as a096cd30) will vary.

table: a096cd30 table
1
4

Delete a global variable

To delete a global variable, assign `nil` to the global variable. This removes the global variable from the runtime environment.

Functions

With Lua, you can group commands and statements using the `function` keyword. Functions can take zero, one, or multiple parameters, and they return zero, one, or multiple values.

You can use functions to form expressions that calculate and return a value. Functions can also act as statements that execute specific tasks.

Functions are first-class values in Lua. That means that functions can be stored in variables, passed as arguments to other functions, and returned as results. They can also be stored in tables.

Note that when a function is defined, it is stored in the runtime environment. Like all data that is stored in the runtime environment, the function persists until it is removed from the runtime environment, is overwritten, or the instrument is turned off.

Create functions using the function keyword

Functions are created with a message or in Lua code in either of the following forms:

```
function myFunction(parameterX) functionBody end
myFunction = function (parameterX) functionBody end
```

Where:

- *myFunction*: The name of the function.
- *parameterX*: Parameter names. To use multiple parameters, separate the names with commas.
- *functionBody*: The code that is executed when the function is called.

To execute a function, substitute appropriate values for *parameterX* and insert them into a message formatted as:

```
myFunction(valueForParameterX, valueForParameterY)
```

Where *valueForParameterX* and *valueForParameterY* represent the values to be passed to the function call for the given parameters.

NOTE

The output you get from these examples may vary depending on the data format settings of the instrument.

Example 1

```
function add_two(first_value, second_value)
  return first_value + second_value
end
print(add_two(3, 4))
```

Creates a variable named `add_two` that has a variable type of function.
Output:
7

Example 2

```
add_three = function(first_value,
    second_value, third_value)
    return first_value + second_value +
        third_value
end
print(add_three(3, 4, 5))
```

Creates a variable named `add_three` that has a variable type of function.

Output:
12

Example 3

```
function sum_diff_ratio(first_value,
    second_value)
    psum = first_value + second_value
    pdif = first_value - second_value
    prat = first_value / second_value
    return psum, pdif, prat
end
sum, diff, ratio = sum_diff_ratio(2, 3)
print(sum)
print(diff)
print(ratio)
```

Returns multiple parameters (sum, difference, and ratio of the two numbers passed to it).

Output:
5
-1
0.6666666666666667

Create functions using scripts

You can use scripts to define functions. Scripts that define a function are like any other script: They do not cause any action to be performed on the instrument until they are executed. The global variable of the function does not exist until the script that created the function is executed.

A script can consist of one or more functions. Once a script has been run, the computer can call functions that are in the script directly.

Group commands using the function keyword

The following script contains instrument commands that display the name of the person that is using the script on the front panel of the instrument. It takes one parameter to represent this name. When this script is run, the function is loaded in memory. Once loaded into memory, you can call the function outside of the script to execute it.

When calling the function, you must specify a string for the *name* argument of the function. For example, to set the name to **John**, call the function as follows:

```
myDisplay("John")
```

Example: User script

User script created in Test Script Builder	User script created in user's own program
<pre>function myDisplay(name) display.clear() display.settext(name .. "\$N is here!") end</pre>	<pre>loadscript function myDisplay(name) display.clear() display.settext(name .. " \$N is here!") end endscript</pre>

Operators

You can compare and manipulate Lua variables and constants using operators.

Arithmetic operators

Operator	Description
+	addition
-	subtraction
*	multiplication
/	division
-	negation (for example, $c = -a$)
^	exponentiation

Relational operators

Operator	Description
<	less than
>	greater than
<=	less than or equal
>=	greater than or equal
~=	not equal
==	equal

Logical operators

The logical operators in Lua are `and`, `or`, and `not`. All logical operators consider both `false` and `nil` as false and anything else as true.

The operator `not` always returns `false` or `true`.

The conjunction operator `and` returns its first argument if the first argument is `false` or `nil`; otherwise, `and` returns its second argument. The disjunction operator `or` returns its first argument if this value is different from `nil` and `false`; otherwise, `or` returns its second argument. Both `and` and `or` use shortcut evaluation, that is, the second operand is evaluated only if necessary.

NOTE

The example output you get may vary depending on the data format settings of the instrument.

Example

<code>print(10 or errorqueue.next())</code>	1.00000e+01
<code>print(nil or "a")</code>	a
<code>print(nil and 10)</code>	nil
<code>print(false and errorqueue.next())</code>	false
<code>print(false and nil)</code>	false
<code>print(false or nil)</code>	nil
<code>print(10 and 20)</code>	2.00000e+01

String concatenation

String operators

Operator	Description
..	Concatenates two strings. If either argument is a number, it is coerced to a string (in a reasonable format) before concatenation.

Example: Concatenation

```
print(2 .. 3)
print("Hello " .. "World")
```

Output:
23
Hello World

Operator precedence

Operator precedence in Lua follows the order below (from higher to lower priority):

- ^ (exponentiation)
- not, - (unary)
- *, /
- +, -
- .. (concatenation)
- <, >, <=, >=, ~=, ==
- and
- or

You can use parentheses to change the precedences in an expression. The concatenation ("..") and exponentiation ("^") operators are right associative. All other binary operators are left associative. The examples below show equivalent expressions.

Equivalent expressions

reading + offset < testValue/2+0.5	=	(reading + offset) < ((testValue/2)+0.5)
3+reading^2*4	=	3+((reading^2)*4)
Rdg < maxRdg and lastRdg <= expectedRdg	=	(Rdg < maxRdg) and (lastRdg <= expectedRdg)
-reading^2	=	-(reading^2)
reading^testAdjustment^2	=	reading^(testAdjustment^2)

Conditional branching

Lua uses the `if`, `else`, `elseif`, `then`, and `end` keywords to do conditional branching.

Note that in Lua, `nil` and `false` are `false` and everything else is `true`. Zero (0) is `true` in Lua.

The syntax of a conditional block is as follows:

```
if expression then
  block
elseif expression then
  block
else
  block
end
```

Where:

- *expression* is Lua code that evaluates to either `true` or `false`
- *block* consists of one or more Lua statements

Example: If

```
if 0 then
  print("Zero is true!")
else
  print("Zero is false.")
end
```

Output:
Zero is true!

Example: Comparison

```
x = 1
y = 2
if x and y then
  print("Both x and y are true")
end
```

Output:
Both x and y are true

Example: If and else

```
x = 2
if not x then
  print("This is from the if block")
else
  print("This is from the else block")
end
```

Output:
This is from the else block

Example: Else and elseif

```
x = 1
y = 2
if x and y then
    print("'if' expression 2 was not false.")
end

if x or y then
    print("'if' expression 3 was not false.")
end

if not x then
    print("'if' expression 4 was not false.")
else
    print("'if' expression 4 was false.")
end

if x == 10 then
    print("x = 10")
elseif y > 2 then
    print("y > 2")
else
    print("x is not equal to 10, and y is not greater than 2.")
end
```

Output:

```
'if' expression 2 was not false.
'if' expression 3 was not false.
'if' expression 4 was false.
x is not equal to 10, and y is not greater than 2.
```

Loop control

If you need to repeat code execution, you can use the Lua `while`, `repeat`, and `for` control structures. To exit a loop, you can use the `break` keyword.

While loops

To use conditional expressions to determine whether to execute or end a loop, you use `while` loops. These loops are similar to [Conditional branching](#) (on page 10-21) statements.

```
while expression do
    block
end
```

Where:

- *expression* is Lua code that evaluates to either `true` or `false`
- *block* consists of one or more Lua statements

NOTE

The output you get from this example may vary depending on the data format settings of the instrument.

Example: While

<pre>list = { "One", "Two", "Three", "Four", "Five", "Six"} print("Count list elements on numeric index:") element = 1 while list[element] do print(element, list[element]) element = element + 1 end</pre>	<p>This loop exits when <code>list[element] = nil</code>.</p> <p>Output: Count list elements on numeric index: 1 One 2 Two 3 Three 4 Four 5 Five 6 Six</p>
---	---

Repeat until loops

To repeat a command, you use the `repeat ... until` statement. The body of a `repeat` statement always executes at least once. It stops repeating when the conditions of the `until` clause are met.

```
repeat
    block
until expression
```

Where:

- *block* consists of one or more Lua statements
- *expression* is Lua code that evaluates to either `true` or `false`

NOTE

The output you get from this example may vary depending on the data format settings of the instrument.

Example: Repeat until

```
list = {"One", "Two", "Three", "Four", "Five", "Six"}
print("Count elements in list using repeat:")
element = 1
repeat
    print(element, list[element])
    element = element + 1
until not list[element]
```

Output:
Count elements in list using repeat:
1 One
2 Two
3 Three
4 Four
5 Five
6 Six

For loops

There are two variations of `for` statements supported in Lua: Numeric and generic.

NOTE

In a `for` loop, the loop expressions are evaluated once, before the loop starts.

The output you get from these examples may vary depending on the data format settings of the instrument.

Example: Numeric for

```
list = {"One", "Two", "Three", "Four", "Five", "Six"}
----- For loop -----
print("Counting from one to three:")
for element = 1, 3 do
    print(element, list[element])
end
print("Counting from one to four, in steps of two:")
for element = 1, 4, 2 do
    print(element, list[element])
end
```

The numeric `for` loop repeats a block of code while a control variable runs through an arithmetic progression.

Output:

```
Counting from one to three:
1  One
2  Two
3  Three
Counting from one to four, in steps of two:
1  One
3  Three
```

Example: Generic for

```
days = {"Sunday",
        "Monday",   "Tuesday",
        "Wednesday", "Thursday",
        "Friday",   "Saturday"}

for i, v in ipairs(days) do
    print(days[i], i, v)
end
```

The generic `for` statement works by using functions called iterators. On each iteration, the iterator function is called to produce a new value, stopping when this new value is nil.

Output:

```
Sunday    1    Sunday
Monday    2    Monday
Tuesday   3    Tuesday
Wednesday 4    Wednesday
Thursday  5    Thursday
Friday    6    Friday
Saturday  7    Saturday
```

Break

The `break` statement can be used to terminate the execution of a `while`, `repeat`, or `for` loop, skipping to the next statement after the loop. A `break` ends the innermost enclosing loop.

Return and `break` statements can only be written as the last statement of a block. If it is necessary to return or `break` in the middle of a block, an explicit inner block can be used.

NOTE

The output you get from these examples may vary depending on the data format settings of the instrument.

Example: Break with while statement

```
local numTable = {5, 4, 3, 2, 1}
local k = table.getn(numTable)
local breakValue = 3
while k > 0 do
    if numTable[k] == breakValue then
        print("Going to break and k = ", k)
        break
    end
    k = k - 1
end
if k == 0 then
    print("Break value not found")
end
```

This example defines a `break` value (`breakValue`) so that the `break` statement is used to exit the `while` loop before the value of `k` reaches 0.

Output:
Going to break and k = 3

Example: Break with while statement enclosed by comment delimiters

```
local numTable = {5, 4, 3, 2, 1}
local k = table.getn(numTable)
-- local breakValue = 3
while k > 0 do
    if numTable[k] == breakValue then
        print("Going to break and k = ", k)
        break
    end
    k = k - 1
end
if k == 0 then
    print("Break value not found")
end
```

This example defines a `break` value (`breakValue`), but the `break` value line is preceded by comment delimiters so that the `break` value is not assigned, and the code reaches the value 0 to exit the `while` loop.

Output:
Break value not found

Example: Break with infinite loop

```

a, b = 0, 1
while true do
  print(a, b)
  a, b = b, a + b
  if a > 500 then
    break
  end
end
end

```

This example uses a `break` statement that causes the while loop to exit if the value of `a` becomes greater than 500.

Output:

```

0 1
1 1
1 2
2 3
3 5
5 8
8 13
13 21
21 34
34 55
55 89
89 144
144 233
233 377
377 610

```

Tables and arrays

Lua makes extensive use of the data type table, which is a flexible array-like data type. Table indices start with 1. Tables can be indexed not only with numbers, but with any value except `nil`. Tables can be heterogeneous, which means that they can contain values of all types except `nil`.

Tables are the sole data structuring mechanism in Lua. They may be used to represent ordinary arrays, symbol tables, sets, records, graphs, trees, and so on. To represent records, Lua uses the field `name` as an index. The language supports this representation by providing `a.name` as an easier way to express `a["name"]`.

NOTE

The output you get from this example may vary depending on the data format settings of the instrument.

Example: Loop array

```

atable = {1, 2, 3, 4}
i = 1
while atable[i] do
  print(atable[i])
  i = i + 1
end

```

Defines a table with four numeric elements. Loops through the array and prints each element. The Boolean value of `atable[index]` evaluates to `true` if there is an element at that index. If there is no element at that index, `nil` is returned (`nil` is considered to be `false`).

Output:

```

1
2
3
4

```

Standard libraries

In addition to the standard programming constructs described in this document, Lua includes standard libraries that contain useful functions for string manipulation, mathematics, and related functions. Test Script Processor (TSP®) scripting engine instruments also include instrument control extension libraries, which provide programming interfaces to the instrumentation that can be accessed by the TSP scripting engine. These libraries are automatically loaded when the TSP scripting engine starts and do not need to be managed by the programmer.

The following topics provide information on some of the basic Lua standard libraries. For additional information, see the [Lua website \(lua.org\)](http://lua.org).

NOTE

When referring to the Lua website, please be aware that the TSP scripting engine uses Lua 5.0.2.

Base library functions

Base library functions

Function	Description
<code>collectgarbage()</code> <code>collectgarbage(<i>limit</i>)</code>	Sets the garbage-collection threshold to the given limit (in kilobytes) and checks it against the byte counter. If the new threshold is smaller than the byte counter, Lua immediately runs the garbage collector. If there is no limit parameter, it defaults to zero (0), which forces a garbage-collection cycle. See Lua memory management (on page 10-27) for more information.
<code>gcinfo()</code>	Returns the number of kilobytes of dynamic memory that the Test Script Processor (TSP®) scripting engine is using and returns the present garbage collector threshold (also in kilobytes). See Lua memory management (on page 10-27) for more information.
<code>tonumber(<i>x</i>)</code> <code>tonumber(<i>x</i>, <i>base</i>)</code>	Returns <i>x</i> converted to a number. If <i>x</i> is already a number, or a convertible string, the number is returned; otherwise, it returns <code>nil</code> . An optional argument specifies the base to use when interpreting the numeral. The base may be any integer from 2 to 36, inclusive. In bases above 10, the letter <code>A</code> (in either upper or lower case) represents 10, <code>B</code> represents 11, and so forth, with <code>Z</code> representing 35. In base 10, the default, the number may have a decimal part and an optional exponent. In other bases, only unsigned integers are accepted.
<code>tostring(<i>x</i>)</code>	Receives an argument of any type and converts it to a string in a reasonable format.
<code>type(<i>v</i>)</code>	Returns (as a string) the type of its only argument. The possible results of this function are "nil" (a string, not the value <code>nil</code>), "number", "string", "boolean", "table", "function", "thread", and "userdata".

Lua memory management

Lua automatically manages memory, which means you do not have to allocate memory for new objects and free it when the objects are no longer needed. Lua occasionally runs a garbage collector to collect all objects that are no longer accessible from Lua. All objects in Lua are subject to automatic management, including tables, variables, functions, threads, and strings.

Lua uses two numbers to control its garbage-collection cycles. One number counts how many bytes of dynamic memory Lua is using; the other is a threshold. When the number of bytes crosses the threshold, Lua runs the garbage collector, which reclaims the memory of all inaccessible objects. The byte counter is adjusted, and the threshold is reset to twice the new value of the byte counter.

String library functions

This library provides generic functions for string manipulation, such as finding and extracting substrings. When indexing a string in Lua, the first character is at position 1 (not 0, as in ANSI C). Indices may be negative and are interpreted as indexing backward from the end of the string. Thus, the last character is at position -1 , and so on.

String library functions

Function	Description
<code>string.byte(s)</code> <code>string.byte(s, i)</code> <code>string.byte(s, i, j)</code>	Returns the internal numeric codes of the characters <code>s[i]</code> , <code>s[i+1]</code> , ..., <code>s[j]</code> . The default value for <code>i</code> is 1; the default value for <code>j</code> is <code>i</code> .
<code>string.char(...)</code>	Receives zero or more integers separated by commas. Returns a string with length equal to the number of arguments, in which each character has the internal numeric code equal to its corresponding argument.
<code>string.format(formatstring, ...)</code>	Returns a formatted version of its variable number of arguments following the description given in its first argument, which must be a string. The format string follows the same rules as the <code>printf</code> family of standard C functions. The only differences are that the modifiers <code>*</code> , <code>l</code> , <code>L</code> , <code>n</code> , <code>p</code> , and <code>h</code> are not supported and there is an extra option, <code>q</code> . The <code>q</code> option formats a string in a form suitable to be safely read back by the Lua interpreter; the string is written between double quotes, and all double quotes, newlines, embedded zeros, and backslashes in the string are correctly escaped when written. For example, the call: <code>string.format('%q', 'a string with "quotes" and \n new line')</code> will produce the string: <code>"a string with \"quotes\" and \n new line"</code> The options <code>c</code> , <code>d</code> , <code>E</code> , <code>e</code> , <code>f</code> , <code>g</code> , <code>G</code> , <code>i</code> , <code>o</code> , <code>u</code> , <code>X</code> , and <code>x</code> all expect a number as argument. <code>q</code> and <code>s</code> expect a string. This function does not accept string values containing embedded zeros, except as arguments to the <code>q</code> option.
<code>string.len(s)</code>	Receives a string and returns its length. The empty string <code>""</code> has length 0. Embedded zeros are counted, so <code>"a\000bc\000"</code> has length 5.
<code>string.lower(s)</code>	Receives a string and returns a copy of this string with all uppercase letters changed to lowercase. All other characters are left unchanged.
<code>string.rep(s, n)</code>	Returns a string that is the concatenation of <code>n</code> copies of the string <code>s</code> .
<code>string.sub(s, i)</code> <code>string.sub(s, i, j)</code>	Returns the substring of <code>s</code> that starts at <code>i</code> and continues until <code>j</code> ; <code>i</code> and <code>j</code> can be negative. If <code>j</code> is absent, it is assumed to be equal to -1 (which is the same as the string length). In particular, the call <code>string.sub(s, 1, j)</code> returns a prefix of <code>s</code> with length <code>j</code> , and <code>string.sub(s, -i)</code> returns a suffix of <code>s</code> with length <code>i</code> .
<code>string.upper(s)</code>	Receives a string and returns a copy of this string with all lowercase letters changed to uppercase. All other characters are left unchanged.

Math library functions

This library is an interface to most of the functions of the ANSI C math library. All trigonometric functions work in radians. The functions `math.deg()` and `math.rad()` convert between radians and degrees.

Math library functions

Function	Description
<code>math.abs(x)</code>	Returns the absolute value of x .
<code>math.acos(x)</code>	Returns the arc cosine of x .
<code>math.asin(x)</code>	Returns the arc sine of x .
<code>math.atan(x)</code>	Returns the arc tangent of x .
<code>math.atan2(y, x)</code>	Returns the arc tangent of y/x but uses the signs of both parameters to find the quadrant of the result (it also handles correctly the case of x being zero).
<code>math.ceil(x)</code>	Returns the smallest integer larger than or equal to x .
<code>math.cos(x)</code>	Returns the cosine of x .
<code>math.deg(x)</code>	Returns the angle x (given in radians) in degrees.
<code>math.exp(x)</code>	Returns the value e^x .
<code>math.floor(x)</code>	Returns the largest integer smaller than or equal to x .
<code>math.frexp(x)</code>	Returns m and e such that $x = m2^e$, where e is an integer and the absolute value of m is in the range $[0.5, 1]$ (or zero when x is zero).
<code>math.ldexp(m, e)</code>	Returns $m2^e$ (e should be an integer).
<code>math.log(x)</code>	Returns the natural logarithm of x .
<code>math.log10(x)</code>	Returns the base-10 logarithm of x .
<code>math.max(x, ...)</code>	Returns the maximum value among its arguments.
<code>math.min(x, ...)</code>	Returns the minimum value among its arguments.
<code>math.pi</code>	The value of π (3.141592654).
<code>math.pow(x, y)</code>	Returns x^y (you can also use the expression x^y to compute this value).
<code>math.rad(x)</code>	Returns the angle x (given in degrees) in radians.
<code>math.random()</code> <code>math.random(m)</code> <code>math.random(m, n)</code>	This function is an interface to the simple pseudorandom generator function <code>rand</code> provided by ANSI C. When called without arguments, returns a uniform pseudorandom real number in the range $[0, 1]$. When called with an integer number m , <code>math.random()</code> returns a uniform pseudorandom integer in the range $[1, m]$. When called with two integer numbers m and n , <code>math.random()</code> returns a uniform pseudorandom integer in the range $[m, n]$.
<code>math.randomseed(x)</code>	Sets x as the seed for the pseudorandom generator; equal seeds produce equal sequences of numbers.
<code>math.sin(x)</code>	Returns the sine of x .
<code>math.sqrt(x)</code>	Returns the square root of x . You can also use the expression $x^{0.5}$ to compute this value.
<code>math.tan(x)</code>	Returns the tangent of x .

Programming example

The following script puts a message on the front-panel display slowly, one character at a time. This example demonstrates:

- The use of a `for` loop
- Simple display remote commands
- Simple Lua string manipulation

Example: User script

```
loadscript
display.clear()
myMessage = "Hello World!"
for k = 1, string.len(myMessage) do
    x = string.sub(myMessage, k, k)
    display.setText(x)
    print(x)
    delay(1)
end
endscript
```

Test Script Builder

Keithley Instruments Test Script Builder (TSB) is a software tool you can use to develop scripts for TSP-enabled instruments.

Installing the TSB software

The installation files for the TSB software are available at tek.com/keithley.

To install the TSB software:

1. Close all programs.
2. Download the installer to your computer and double-click the `.exe` file to start the installation.
3. Follow the on-screen instructions.

Using Test Script Builder (TSB)

Keithley Instruments Test Script Builder (TSB) is a software tool that simplifies building test scripts. You can use TSB to perform the following operations:

- Send remote commands and Lua statements
- Receive responses (data) from commands and scripts
- Upgrade instrument firmware
- Create, manage, and run user scripts
- Debug scripts
- Import factory scripts to view or edit and convert to user scripts

The Keithley Instruments Test Script Processor (TSP®) scripting engine is a Lua interpreter. In TSP-enabled instruments, the Lua programming language has been extended with Keithley-specific instrument control commands. For more information about using the Lua scripting language with Keithley TSP-enabled instruments, refer to the [Fundamentals of programming for TSP](#) (on page 10-13).

Keithley has created a collection of remote commands specifically for use with Keithley TSP-enabled instruments; for detailed information about those commands, refer to the "Command reference" section of the documentation for your specific instrument. You can build scripts from a combination of these commands and Lua programming statements. Scripts that you create are referred to as "user scripts." Also, some TSP-enabled instruments include built-in factory scripts.

The following figure shows an example of the Test Script Builder. As shown, the workspace is divided into these areas:

- Project navigator
- Script editor
- Outline view
- Programming interaction
- Help files

Figure 130: Example of the Test Script Builder workspace

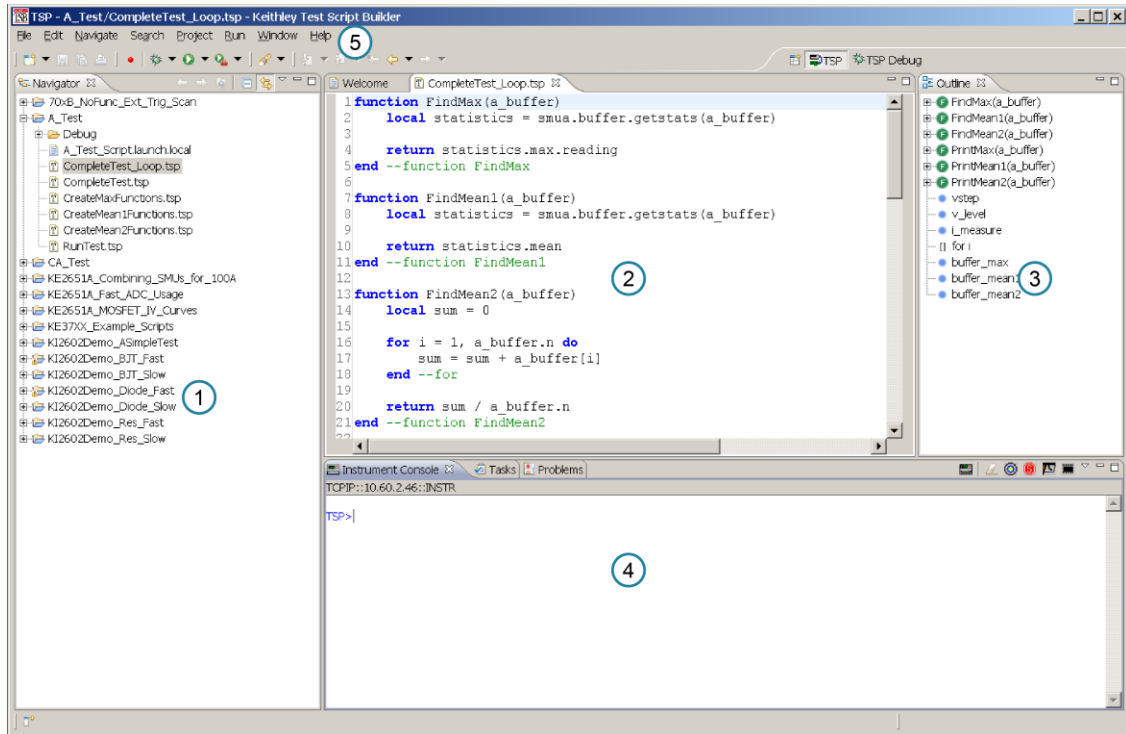

Item	Description
1	Project navigator
2	Script editor; right-click to run the script that is displayed
3	Outline view
4	Programming interaction
5	Help; includes detailed information on using Test Script Builder

Project navigator

The project navigator consists of project folders and the script files (.tsp) created for each project. Each project folder can have one or more script files.

To view the script files in a project folder, select the plus (+) symbol next to the project folder. To hide the folder contents, select the minus (-) symbol next to the project folder.

You can download a TSP project to the instrument and run it, or you can run it from the TSB interface.

Script editor

The script editor is where you write, modify, and debug scripts.

To open and display a script file, double-click the file name in the project navigator. You can have multiple script files open in the script editor at the same time. Each open script file is displayed on a separate tab.

To display another script file that is already open, select the tab that contains the script in the script editor area.

Outline view

The outline view allows you to navigate through the structure of the active script in the script editor. Double-clicking a variable name or icon causes the first instance of the variable in the active script to be highlighted.

This view shows:

- Names of local and global variables
- Functions referenced by the active script in the script editor
- Parameters
- Loop control variables
- Table variables
- Simple assignments to table fields

The Outline tab is visible by default in the TSP perspective.

Icon	Name	Examples
	Global function variable	<code>function gFunction() end</code>
	Local function variable	<code>local function lFunction() end</code>
	Anonymous function	<code>myTest(function() return 1 end)</code>
	Global table variable	<code>gTable = { }</code>
	Local table variable	<code>local lTable = { }</code>
	Other table field	<code>testTable.unit1 = "This is unit 1" testTable.unit2 = "This is unit 2"</code>
	Global variable	<code>gVariable = 3</code>
	Local variable	<code>local lVariable = 5</code>
	Table method	<code>gTable = { function gTable:testmethod() end</code>
[]	Nonfunction block statement (example 1)	<code>if true == true then local var end</code>
	Nonfunction block statement (example 2)	<code>for index = 1, 10 do end</code>

Programming interaction

This part of the workspace is where you interact with the scripts that you are building in Test Script Builder (TSB). The actual contents of the programming interaction area of the workspace can vary.

You can send commands from the Instrument Console command line, retrieve data, view variables and errors, and view and set breakpoints when using the debug feature.

Password management

The 2601B-PULSE has password capabilities that let you decide how to password protect the instrument. You can enable password policies to lock the instrument. Locking the instrument prevents unauthorized access to any remote interface and reserves the instrument exclusively for your use.

When password usage is enabled, you must supply a password to change the configuration or to control an instrument from a web page or other remote command interface.

If the password feature is enabled, a password is required to view and modify the following web pages:

- IP configuration
- Set password

NOTE

Passwords can contain up to 255 characters.

Setting the password from a command or web interface

The attribute `localnode.passwordmode` enables passwords and sets the mode. The password mode identifies which interface to password protect.

Use one of the following attributes to set the password mode:

- `localnode.PASSWORD_WEB`. Passwords are only required for the web interface.
- `localnode.PASSWORD_LAN`. Enables passwords on all ethernet and web interfaces.
- `localnode.PASSWORD_ALL`. Protects the LAN and all command and web interfaces.
- `localnode.PASSWORD_NONE`. Disables all passwords.

The password lock feature on 2601B-PULSE is similar to the lock feature on your computer.

NOTE

You must enable passwords to use this feature.

To enable the password from a command interface:

To lock the instrument when you are away from the testing area, send the following command:

```
password
```

The remote interface is locked. The 2601B-PULSE does not respond to commands issued from the command interface until you unlock the interface. This reserves the instrument and protects the test script running on the instrument.

To set the password for the web interface:

1. From the web interface, click **Set Password**.
The LXI - Keithley Instruments - 2601B-PULSE - Administration page is displayed.
2. In **Current Password**, type the existing password. The default is `admin`.
3. In **New Password**, type the new password.
4. Retype the new password in **Confirm New Password**.
5. Click **Submit**.

The LXI Welcome page is displayed.

Unlocking the remote interface

If the remote interface is locked, you must enter the password before the 2601B-PULSE responds to any command issued over a remote interface.

NOTE

The password for the example below is `Keithley`.

To unlock the remote interface, send the following command:

```
password Keithley
```

The 2601B-PULSE is unlocked and communicates with any remote interface.

Resetting the password

If you forget the password, you can reset the password from the front panel. Once you enable the password feature, the 2601B-PULSE stores this password until the LAN configuration is reset or until you reset the password.

To reset the password:

1. From the front panel, press the **MENU** key.
2. Select **RESET-PASSWORD**.

NOTE

If you reset the LAN settings, you must re-enable the password feature.

Advanced scripting for TSP

The following topics describe advanced information that can help you understand how the Test Script Processor (TSP®) scripting engine works.

Global variables and the `script.user.scripts` table

When working with script commands, it is helpful to understand how scripts are handled in the instrument.

Scripts are loaded into the runtime environment from nonvolatile memory when you turn the instrument on. They are also added to the runtime environment when you load them into the instrument.

A script in the runtime environment can be:

- A named script
- An unnamed script
- The anonymous script (which is a special unnamed script)

Script names can be assigned by using the `loadscript` command or by defining the `scriptVar` parameter of the `script.new()` function. When a named script is loaded into the runtime environment:

- A global variable with the same name is created so that you can reference the script more conveniently.
- An entry for the script is added to the `script.user.scripts` table.

When you create a script using the `script.new()` function without providing a name, the script is added to the runtime environment as an unnamed script. The `script.new()` function returns the script, but the script is not added to the `script.user.scripts` table.

When the anonymous script is loaded, it does not have a global variable or an entry in the `script.user.scripts` table. If there is an existing anonymous script, it is replaced by the new one.

When the instrument is turned off, everything in the runtime environment is deleted, including the scripts and global variables.

See the figure below to see how the scripts, global variables, and `script.user.scripts` table interrelate.

Figure 131: Global variables and scripts in the runtime environment

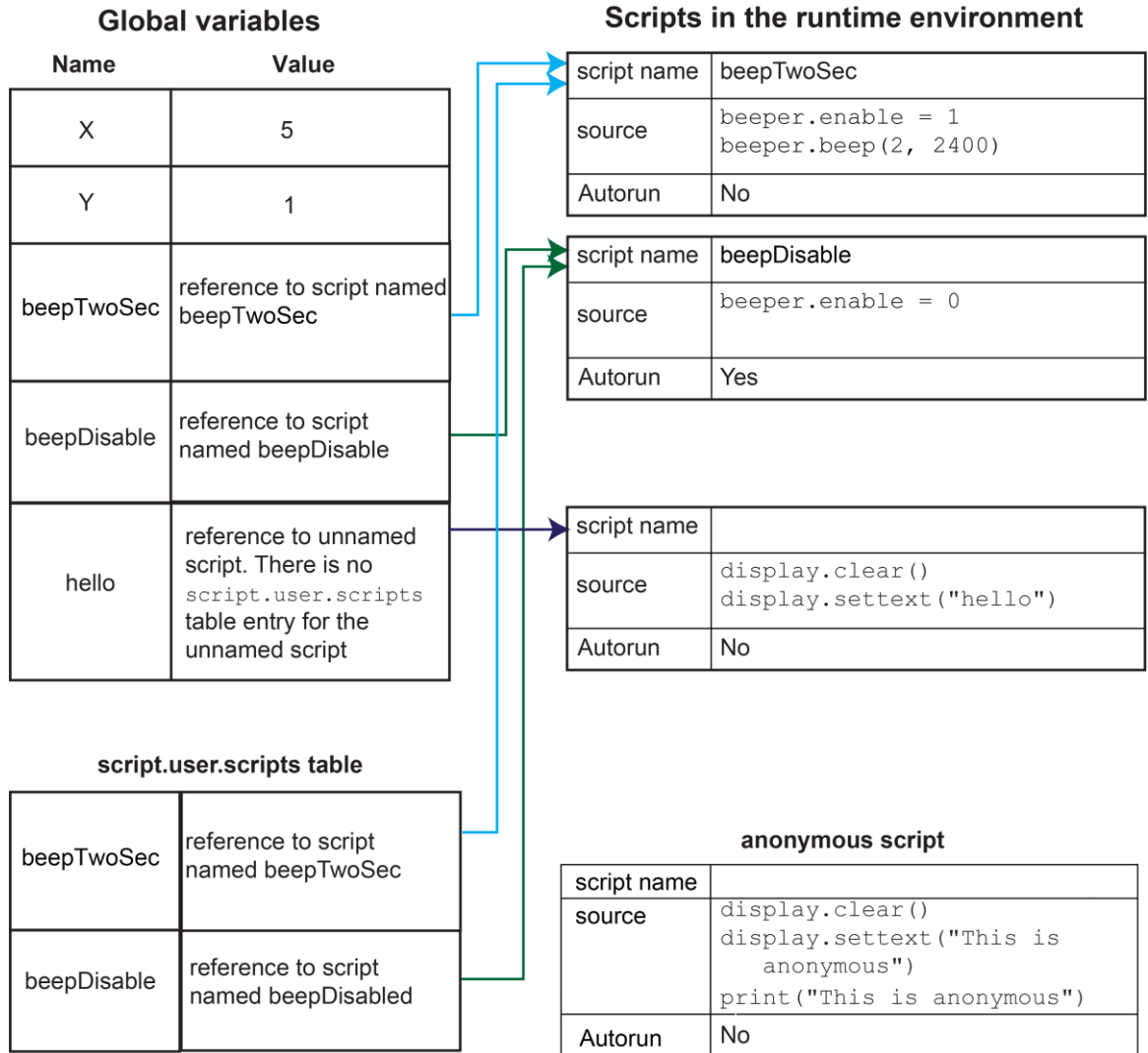

Create a script using the script.new() command

Use the `script.new()` function to copy an existing script from the local node to a remote node. This enables parallel script execution.

You can create a script with the `script.new()` function using the command:

```
scriptVar = script.new(code, name)
```

Where:

- `scriptVar` = Name of the variable created when the script is loaded into the runtime environment
- `code` = Content of the script
- `name` = Name that is added to the `script.user.scripts` table

For example, to set up a two-second beep, you can send the command:

```
beepTwoSec = script.new("beeper.enable = 1 beeper.beep(2, 2400)", "beepTwoSec")
```

To run the new script, send the command:

```
beepTwoSec()
```

When you add `beepTwoSec`, the global variable and `script.user.scripts` table entries are made to the runtime environment, as shown in the following figure.

Figure 132: Runtime environment after creating a script

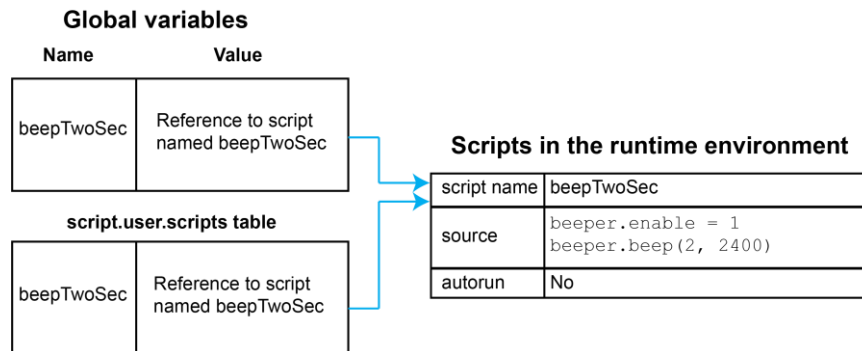

Create an unnamed script using `script.new()`

NOTE

Unnamed scripts are not available from the front-panel display of the instrument. Only the anonymous script and named scripts are available from the front-panel display.

When you create a script using `script.new()`, if you do not include `name`, the script is added to the runtime environment as an unnamed script. The `script.new()` function returns the script. You can assign it to a global variable, a local variable, or ignore the return value. A global variable is not automatically created.

For example, send the following command:

```
hello = script.new('display.clear() display.settext("hello")')
```

A script is created in the runtime environment and a global variable is created that references the script.

To run the script, send the command:

```
hello()
```

Figure 133: Create an unnamed script

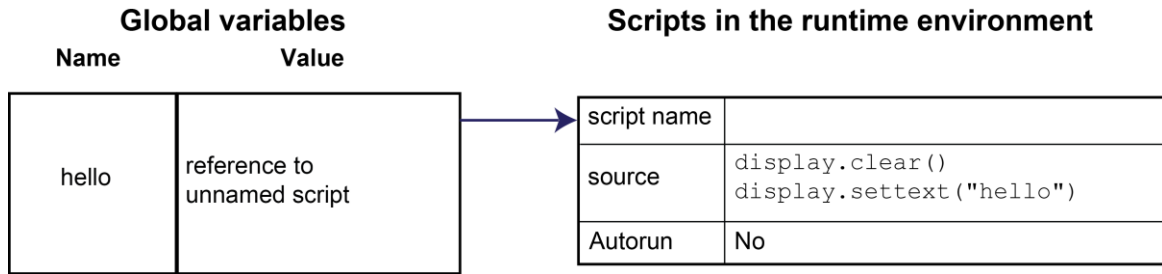

A script becomes unnamed if you create a new script with the same name. In this circumstance, the name of the script in the `script.user.scripts` table is set to an empty string before it is replaced by the new script.

For example, if `beepTwoSec` already exists in the `script.user.scripts` table and you sent:

```
beepTwoSec1200 = script.new("beeper.enable = 1 beeper.beep(2, 1200)", "beepTwoSec")
```

The following actions occur:

- `beepTwoSec1200` is added as a global variable.
- The script that was in the runtime environment as `beepTwoSec` is changed to an unnamed script (the name attribute is set to an empty string).
- The global variable `beepTwoSec` remains in the runtime environment unchanged (it points to the now unnamed script).
- A new script named `beepTwoSec` is added to the runtime environment.

In this example, you can access the new script by sending either of the following commands:

```
beepTwoSec1200 ()
script.user.scripts.beepTwoSec ()
```

To access the unnamed script, you can send the command:

```
beepTwoSec ()
```

Figure 134: Create a new script with the name of an existing script

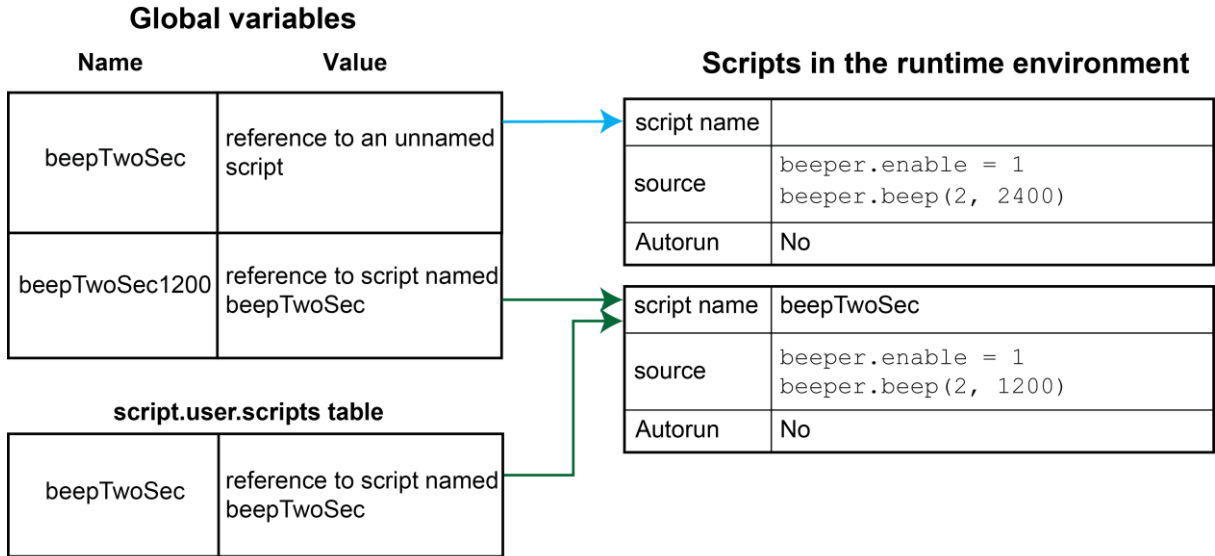

Note that the `script.user.scripts` table entry referencing `beepTwoSec` was removed and a new entry for `beepTwoSec` has been added

Rename a script

You can rename a script. You might want to rename a script if you need to name another script the same name as the existing script. You could also rename an existing script to be the autoexec script.

To change the name of a script, use the command:

```
scriptVar.name = "renamedScript"
```

Where:

```
scriptVar           = The global variable name
"renamedScript"    = The new name of the user script that was referenced by the
                    scriptVar global variable
```

After changing the name, you need to save the original script to save the change to the name attribute.

For example:

```
beepTwoSec.name = "beep2sec"
beepTwoSec.save()
```

Run the `beep2sec` script using the following command:

```
script.user.scripts.beep2sec()
```

NOTE

If the new name is the same as a name that is already used for a script, the name of the existing script is removed and that script becomes unnamed. This removes the existing script if there are no other variables that reference the previous script. If variables do reference the existing script, the references remain intact.

Changing the name of a script does not change the name of any variables that reference that script. After changing the name, the script is in the `script.user.scripts` table under its new name.

Figure 135: Rename script

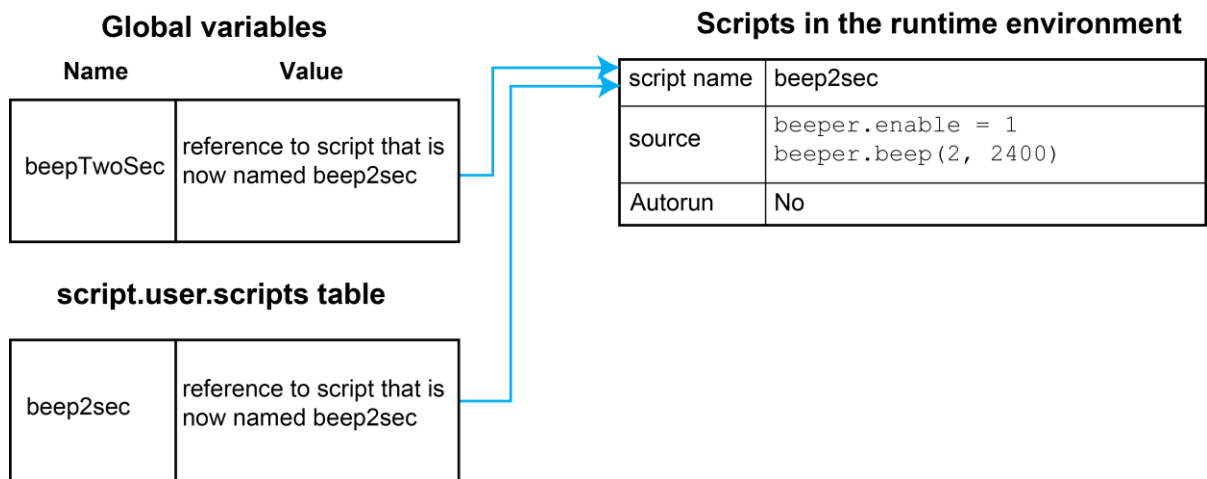

For example, to change the name of the script named `test2` to be `autoexec`:

```
test2.name = "autoexec"
test2.save()
```

The `autoexec` script runs automatically when the instrument is turned on. It runs after all the scripts have loaded and any scripts marked as `autorun` have run.

NOTE

You can also use the `script.new()` and the `scriptVar.source` attribute commands to create a script with a new name. For example, if you had an existing script named `test1`, you could create a new script named `test2` by sending the command:

```
test2 = script.new(test1.source, "test2")
```

See [script.new\(\)](#) (on page 11-160).

Retrieve a user script

There are several ways to retrieve the source code of a user script:

- One line at a time: Use `scriptVar.list()` to retrieve the source code one line at a time
- Entire script: Use the `print(scriptVar.source)` command to retrieve the script source code as a single string

See [Create and load a script](#) (on page 10-3) for information about recreating the script and loading it back into the instrument.

NOTE

To get a list of scripts that are in nonvolatile memory, use the [script.user.catalog\(\)](#) (on page 11-163) function.

Retrieve source code one line at a time

To retrieve the source code one line at a time, send the `scriptVar.list()` command. When this command is received, the instrument sends the entire script. Each line of the script is sent as a separate response message. The output includes the `loadscript` or `loadandrunscript` and `endscript` keywords.

After retrieving the source code, you can modify and save the command lines as a user script under the same name or a new name.

To retrieve the source code of a script one line at a time, send the command:

```
scriptVar.list()
```

Where `scriptVar` is the name of the script.

NOTE

To retrieve the commands in the anonymous script, use `script.anonymous.list()`.

Example: Retrieve source code one line at a time

```
test.list()
```

Retrieve the source of a script named "test".

The output will look similar to:

```
loadscript test
display.clear()
display.settext("This is a test")
print("This is a test")
endscript
```

Retrieve a script as a single string

To retrieve the entire user script source code as a single string, use the `scriptVar.source` attribute. The `loadscript` or `loadandrunscript` and `endscript` keywords are not included.

To retrieve the source code as a single string, send the command:

```
print(scriptVar.source)
```

Where `scriptVar` is the name of the script.

Example: Retrieve the source code as a single string

```
print(test.source)
```

Retrieve the source of a script named "test".

Output looks similar to:

```
display.clear() display.settext("This is a test") print("This  
is a test")
```

Delete user scripts from the instrument

In most circumstances, you can delete a script using `script.delete()` (as described in [Delete user scripts](#) (on page 10-11)), and then turn the instrument off and back on again. However, if you cannot turn the instrument off, you can use the following steps to completely remove a script from the instrument.

When you completely remove a script, you delete all references to the script from the runtime environment, the `script.user.scripts` table, and nonvolatile memory.

To completely remove a script:

1. **Remove the script from the runtime environment.** Set any variables that refer to the script to `nil` or assign the variables a different value. For example, to remove the script "beepTwoSec" from the runtime environment, send the following code:

```
beepTwoSec = nil
```
2. **Remove the script from the `script.user.scripts` table.** Set the `name` attribute to an empty string (""). This makes the script nameless, but does not make the script become the anonymous script. For example, to remove the script named "beepTwoSec", send the following code:

```
script.user.scripts.beepTwoSec.name = ""
```
3. **Remove the script from nonvolatile memory.** To delete the script from nonvolatile memory, send the command:

```
script.delete("name")
```

Where `name` is the name that the script was saved as. For example, to delete "beepTwoSec", you would send:

```
script.delete("beepTwoSec")
```

Restore a script to the runtime environment

You can retrieve a script that was removed from the runtime environment but is still saved in nonvolatile memory.

To restore a script from nonvolatile memory into the runtime environment, you can use `script.restore("scriptName")`, where `scriptName` is the user-defined name of the script to be restored.

For example, to restore a user script named "test9" from nonvolatile memory:

```
script.restore("test9")
```

Memory considerations for the runtime environment

The 2601B-PULSE reserves 32 MB of memory for dynamic runtime use. Approximate allocation of this memory is shown below:

5 MB	Firmware general operation
1 MB	Reserve for instrument internal operation
2 MB	Reserve for future firmware updates
24 MB	Runtime environment, user-created reading buffers, and active sweep configuration

Note that the runtime environment, user-created reading buffers, and active sweep configuration must fit in the 24 MB of memory that is available. The amount of memory used by a reading buffer is approximately 15 bytes for each entry requested.

Reading buffers also use a small amount of memory for reading buffer management, which is not significant when making memory utilization calculations. For example, assume two reading buffers were created. One of them was created to store up to 1,000 readings and the other to store up to 2,500 readings. The memory reserved for the reading buffers is calculated as follows:

$$(1000 * 15) + (2500 * 15) = 52,500 \text{ bytes or } 52.5 \text{ kilobytes}$$

Note that the dedicated reading buffers do not consume memory that is needed by the runtime environment; do not include them in your memory consumption calculations. Also, reading buffers for remote nodes consume memory on the remote node, not the local node. You should be sure the total reading buffer memory for any particular remote node does not exceed 24 MB, but do not include that amount in your local memory consumption calculations.

The amount of memory used by a sweep configuration is based on the number of source points. The actual memory consumption can vary greatly depending on the source-measure unit (SMU) settings, but as a general rule, each source point can be expected to consume at least 24 bytes.

It is possible for the memory used for the runtime environment, sweep configuration and reading buffers to exceed 24 MB. When this occurs, there is a risk that memory allocation errors will occur and commands will not be executed as expected.

CAUTION

If the instrument encounters memory allocation errors when the memory used is above 95 percent, the state of the instrument cannot be guaranteed. After attempting to save any important data, turn off power to the instrument and turn it back on to reset the runtime environment and return the instrument to a known state. Unsaved scripts and data in reading buffers will be lost.

The amount of memory in use can be checked using the `meminfo()` function. The first value returned by `meminfo()` is the number of kilobytes of memory in use.

If the amount of memory used is over 95 percent, or if you receive out-of-memory errors, you should reduce the amount of memory that is used.

Some suggestions for increasing the available memory:

- Turn the instrument off and on. This deletes scripts that have not been saved and reloads only scripts that have been stored in nonvolatile memory.
- Remove unneeded scripts from nonvolatile memory. Scripts are loaded from nonvolatile memory into the runtime environment when the instrument is turned on. See [Delete user scripts from the instrument](#) (on page 10-43).
- Reduce the number of TSP-Link® nodes.
- Delete unneeded global variables from the runtime environment by setting them to `nil`.
- Set the source attribute of all scripts to `nil`.
- Adjust the `collectgarbage()` settings in Lua. See [Lua memory management](#) (on page 10-27) for more information.
- Review scripts to optimize their memory usage. In particular, you can see memory gains by changing string concatenation lines into a Lua table of string entries. You can then use the `table.concat()` function to create the final string concatenation.

TSP-Link system expansion interface

The TSP-Link® expansion interface allows the 2601B-PULSE instrument to communicate with other Test Script Processor (TSP®) enabled instruments. The test system can be expanded to include up to 32 TSP-Link enabled instruments.

CAUTION

Combining two modules to achieve greater currents in both source voltage and source current applications requires specific precautions, including configuration settings. Make sure that you adequately understand the risks involved and the measures needed to accommodate the combination of two modules. To prevent damage to the 2601B-PULSE, connected instruments, and the device under test, make sure proper procedures are used. For further information, visit the Keithley website at tek.com/keithley for application notes on combining channels from two modules.

Master and subordinates

In a TSP-Link® system, one of the nodes (instruments) is the master node and the other nodes are the subordinate nodes. The master node in a TSP-Link® system can control the other nodes (subordinates) in the system.

When any node transitions from local operation to remote operation, it becomes the master of the system. All other nodes also transition to remote operation and become its subordinates. When any node transitions from remote operation to local, all other nodes also transition to local operation, and the master/subordinate relationship between nodes is dissolved.

The expanded system can be stand-alone or computer-based.

Stand-alone system: You can run a script from the front panel of any instrument (node) connected to the system. When a script is run, all nodes in the system go into remote operation (REM indicators turn on). The node running the script becomes the master and can control all other nodes, which become its subordinates. When the script is finished running, all the nodes in the system return to local operation (REM indicators turn off), and the master/subordinate relationship between nodes is dissolved.

Computer-based system: You can use a computer and a remote communications interface to any single node in the system. This node becomes the interface to the entire system. When a command is sent through this node, all nodes go into remote operation (REM indicators turn on). The node that receives the command becomes the master and can control all other nodes, which become its subordinates. In a computer-based system, the master/subordinate relationship between nodes can only be dissolved by performing an abort operation.

TSP-Link nodes

Each instrument (node) attached to the TSP-Link® network must be identified by assigning it a unique TSP-Link node number.

Commands for remote nodes are stored in the `node` table. An individual node is accessed as `node [N]`, where `N` is the node number assigned to the node.

All TSP-accessible remote commands can be accessed as elements of the specific node. The following attributes are examples of items you can access:

- `node [N].model`: The product model number string of the node.
- `node [N].revision`: The product revision string of the node.
- `node [N].serialno`: The product serial number string of the node.

You do not need to know the node number of the node that is running a script. The variable `localnode` is an alias for the node entry of the node where the script is running. For example, if a script is running on node 5, you can use the global variable `localnode` as an alias for `node [5]`. To access the product model number for this example, use `localnode.model`.

Connections

Connections for an expanded system are shown in the following figure. As shown, one instrument is optionally connected to the computer using the GPIB, LAN, USB, or RS-232 interface. Details about these computer communication connections are described in [Remote communications interfaces](#) (on page 2-11).

All the instruments in the system are connected in a sequence (daisy-chained) using LAN crossover cables.

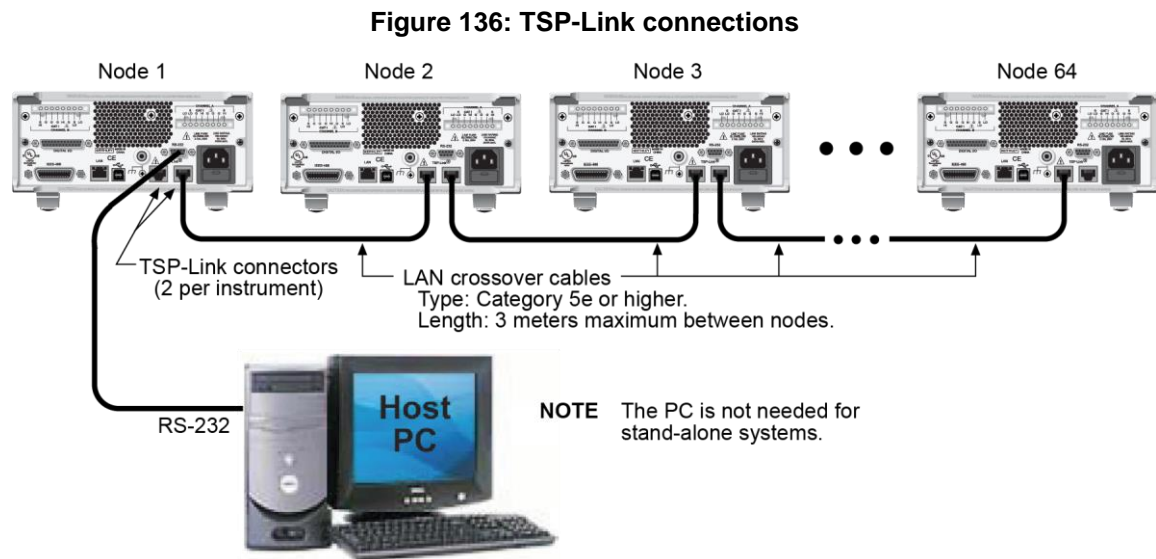

Initialization

Before a TSP-Link® system can be used, it must be initialized. For initialization to succeed, each instrument in a TSP-Link system must be assigned a different node number.

Assigning node numbers

At the factory, each 2601B-PULSE instrument is assigned as node 1. The node number is stored in nonvolatile memory and remains in storage when the instrument is turned off. You can assign a node number to a 2601B-PULSE using the front panel or by using a remote command. Note that there can only be 32 physical nodes, but you can assign node numbers from 1 to 64.

To assign a node number from the front panel of the instrument:

1. Press the **MENU** key, then select **TSPLINK > NODE**.
2. Press the navigation wheel  and select the node number.
3. Press the **ENTER** key to save the number.

To assign a node number using a remote command:

Set the `tsplink.node` attribute of the instrument:

```
tsplink.node = N
```

Where $N = 1$ to 64

To determine the node number of an instrument, you can read the `tsplink.node` attribute by sending the following command:

```
print(tsplink.node)
```

The above `print` command outputs the node number. For example, if the node number is 1, a 1 is displayed.

Resetting the TSP-Link network

After all the node numbers are set, you must initialize the system by performing a TSP-Link® network reset.

NOTE

If you change the system configuration after initialization, you must reinitialize the system by performing a TSP-Link network reset. Changes that require that you reinitialize the TSP-Link network include turning off power or rebooting any instrument in the system, or rearranging or disconnecting the TSP-Link cable connections between instruments.

Front-panel operation

To reset the TSP-Link® network from the front panel:

1. Power on all instruments connected to the TSP-Link network.
2. Press the **MENU** key, select **TSPLINK**, and then press the **ENTER** key.
3. Turn the navigation wheel  to select **RESET**, and then press the **ENTER** key.

Remote programming

The commands associated with the TSP-Link® system reset are listed in the following table.

TSP-Link reset commands

Command	Description
<code>tsplink.reset()</code>	Initializes the TSP-Link network
<code>tsplink.state</code>	Reads the state of the TSP-Link network: <ul style="list-style-type: none"> ▪ “online” if the most recent TSP-Link reset was successful ▪ “offline” if the reset operation failed

An attempted TSP-Link reset operation will fail if any of the following conditions are true:

- Two or more instruments in the system have the same node number
- There are no other instruments connected to the instrument performing the reset (only if the expected number of nodes was not provided in the reset call)
- One or more of the instruments in the system is turned off
- If the actual number of nodes is less than the expected number

The programming example below illustrates a TSP-Link reset operation and displays its state:

```
tsplink.reset()  
print(tsplink.state)
```

If the reset operation is successful, `online` is output to indicate that communications with all nodes have been established.

Using the expanded system

Accessing nodes

A TSP-Link® reset command populates the node table. Each instrument in the system corresponds to an entry in this table. Each entry is indexed by the node number of the instrument. The variable `node[N]` (where N is the node number) is used to access any node in the system. For example, node 1 is represented as entry `node[1]` in the node table.

You can access all the remote commands for a specific node by adding `node[N].` to the beginning of the remote command, where N is the node number. For example, to set the NPLC value for the source-measure unit (SMU) A on node 1 to 0.1, you could send this command:

```
node[1].smua.measure.nplc = 0.1
```

The variable `localnode` is an alias for `node[N]`, where N is the node number of the node on which the code is running. For example, if node 1 is running the code, `localnode` can be used instead of `node[1]`.

The following programming examples illustrate how to access instruments in the TSP-Link system (shown in TSP-Link connections):

- You can use any one of the following three commands to reset SMU A of node 1 (which, in this example, is the master). The other nodes in the system are not affected.
 - `smua.reset()`
 - `localnode.smua.reset()`
 - `node[1].smua.reset()`
- The following command will reset SMU A of node 4, which is a subordinate. The other nodes are not affected.
 - `node[4].smua.reset()`

Using the reset() command

Most TSP-Link® system operations target a single node in the system, but the `reset()` command affects the system as a whole by resetting all nodes to their default settings:

```
-- Reset all nodes in a TSP-Link system to their default state.
reset()
```

NOTE

Using the `reset()` command in a TSP-Link network differs from using the `tsplink.reset()` command. The `tsplink.reset()` command reinitializes the TSP-Link network and will turn off the output of any TSP-linked instrument; it may change the state of individual nodes in the system.

Use `node[N].reset()` or `localnode.reset()` to reset only one of the nodes. The other nodes are not affected. The following programming example shows this type of reset operation with code that is run on node 1.

```
-- Reset node 1 only.
node[1].reset()
-- Reset the node you are connected to (in this case, node 1).
localnode.reset()
-- Reset node 4 only.
node[4].reset()
```

Using the abort command

An `abort` command terminates an executing script and returns all nodes to local operation (REM indicators turn off). This dissolves the master/subordinate relationships between nodes. To invoke an abort operation, either send an `abort` command to a specific node or press the EXIT (LOCAL) key on any node in the system.

You can also perform an abort operation by pressing the OUTPUT ON/OFF control on any node. The results are the same as above, with the addition that all source-measure unit (SMU) outputs in the system are turned off.

Triggering with TSP-Link

The TSP-Link® expansion interface has three trigger lines that function similarly to the digital I/O synchronization lines. See [Digital I/O](#) (on page 6-36) and [Triggering](#) (on page 6-1) for more information.

TSP advanced features

Use the Test Script Processor (TSP®) scripting engine's advanced features to:

- Run test scripts simultaneously
- Manage resources allocated to test scripts that are running simultaneously
- Use the data queue to facilitate real-time communication between nodes on the TSP-Link® network

When test scripts are run simultaneously, it improves functional testing, provides higher throughput, and expands system flexibility.

There are two methods you can use to run test scripts simultaneously:

- Create multiple TSP-Link networks
- Use a single TSP-Link network with groups

The following figure displays the first method, which consists of multiple TSP-Link networks. Each TSP-Link network has a master node and a remote connection to the computer.

Figure 137: Multiple TSP-Link networks

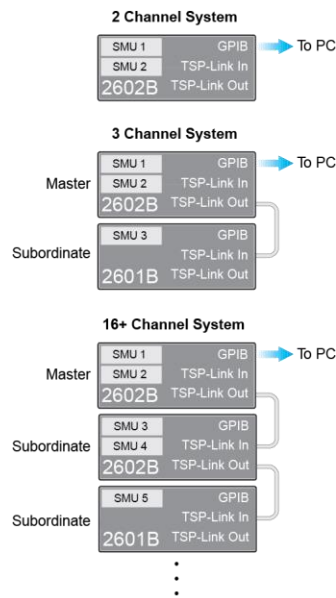

Another method you can use to run simultaneous test scripts is to use groups with a single TSP-Link network. Each group on the TSP-Link network can run a test while other groups are running different tests.

A group consists of one or more nodes with the same group number. The following figure displays a single TSP-Link network with groups. This method requires one TSP-Link network and a single GPIB connection to the computer.

Figure 138: Single TSP-Link network with groups

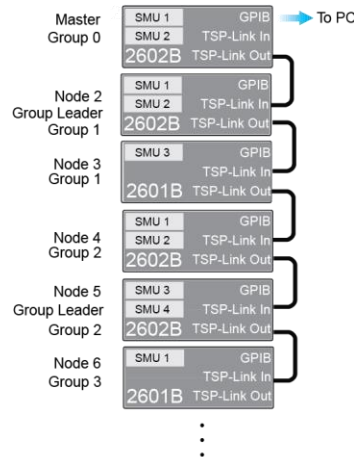

The following table shows an example of the functions of a single TSP-Link network. Each group in this example runs a different test script than the other groups, which allows the system to run multiple tests simultaneously.

The following table shows an example of the functions of a single TSP-Link network. Each group in this example runs a different test script than the other groups, which allows the system to run multiple tests simultaneously.

TSP-Link network group functions

Group number	Group members	Present function
0	Master node 1	Initiates and runs a test script on node 2 Initiates and runs a test script on node 5 Initiates and runs a test script on node 6
1	Group leader Node 2	Runs the test script initiated by the master node Initiates remote operations on node 3
	Node 3	Performs remote operations initiated by node 2
2	Group leader Node 5	Runs the test script initiated by the master node Initiates remote operations on node 4
	Node 4	Performs remote operations initiated by node 5
3	Group leader Node 6	Runs the test script initiated by the master node

Using groups to manage nodes on TSP-Link network

The primary purpose of groups is to allow each group to run a different test script simultaneously.

A group can consist of one or more nodes. You must assign group numbers to each node using remote commands. If you do not assign a node to a group, it defaults to group 0, which will always be grouped with the master node (regardless of the group to which the master node is assigned).

Master node overview

You can assign the master node to any group. You can also include other nodes in the group that includes the master. Note that any nodes that are set to group 0 are automatically included in the group that contains the master node, regardless of the group that is assigned to the master node.

The master node is always the node that coordinates activity on the TSP-Link network.

The master node:

- Is the only node that can use the `execute()` command on a remote node
- Cannot initiate remote operations on any node in a remote group if any node in that remote group is performing an overlapped operation (a command that continues to operate after the command that initiated it has finished running)
- Can execute the `waitcomplete()` command to wait for the group to which the master node belongs; to wait for another group; or to wait for all nodes on the TSP-Link network to complete overlapped operations (overlapped commands allow the execution of subsequent commands while device operations of the overlapped command are still in progress)

Group leader overview

Each group has a dynamic group leader. The last node in a group that performs any operation initiated by the master node is the group leader.

The group leader:

- Performs operations initiated by the master node
- Initiates remote operations on any node with the same group number
- Cannot initiate remote operations on any node with a different group number
- Can use the `waitcomplete()` command without a parameter to wait for all overlapped operations running on nodes in the same group

Assigning groups

Group numbers can range from zero (0) to 64. The default group number is 0. You can change the group number at any time. You can also add or remove a node to or from a group at any time.

Each time the power for a node is turned off, the group number for that node changes to 0.

The following example code dynamically assigns a node to a group:

```
-- Assign node 3 to group 1.  
node[3].tsplink.group = 1
```

Running simultaneous test scripts

You can send the `execute()` command from the master node to initiate a test script and Lua code on a remote node. The `execute()` command places the remote node in the overlapped operation state. As a test script runs on the remote node, the master node continues to process other commands simultaneously.

Use the following code to send the `execute()` command for a remote node. The *N* parameter represents the node number that runs the test script (replace *N* with the node number).

To set the global variable "setpoint" on node N to 2.5:

```
node[N].execute("setpoint = 2.5")
```

The following code demonstrates how to run a test script that is defined on the local node. For this example, `scriptVar` is defined on the local node, which is the node that initiates the code to run on the remote node. The local node must be the master node.

To run scriptVar on node N:

```
node[N].execute(scriptVar.source)
```

The programming example below demonstrates how to run a test script that is defined on a remote node. For this example, `scriptVar` is defined on the remote node.

To run a script defined on the remote node:

```
node[N].execute("scriptVar()")
```

It is recommended that you copy large scripts to a remote node to improve system performance. See [Copying test scripts across the TSP-Link network](#) (on page 10-56) for more information.

Coordinating overlapped operations in remote groups

All overlapped operations on all nodes in a group must have completed before the master node can send a command to the group. If you send a command to a node in a remote group when an overlapped operation is running on any node in that group, errors will occur.

You can execute the `waitcomplete()` command on the master node or group leader to wait for overlapped operations. The action of `waitcomplete()` depends on the parameters specified.

If you want to wait for completion of overlapped operations for:

- **All nodes in the local group:** Use `waitcomplete()` without a parameter from the master node or group leader.
- **A specific group:** Use `waitcomplete(N)` with a group number as the parameter from the master node. This option is not available for group leaders.
- **All nodes in the system:** Use `waitcomplete(0)` from the master node. This option is not available for group leaders.

For additional information, refer to [waitcomplete\(\)](#) (on page 11-393).

The following code shows two examples of using the `waitcomplete()` command from the master node:

```
-- Wait for each node in group N to complete all overlapped operations.
waitcomplete(N)
-- Wait for all groups on the TSP-Link network to complete overlapped operations.
waitcomplete(0)
```

A group leader can issue the `waitcomplete()` command to wait for the local group to complete all overlapped operations.

The following code is an example of how to use the `waitcomplete()` command from a group leader:

```
-- Wait for all nodes in the local group to complete all overlapped operations.
waitcomplete()
```

Using the data queue for real-time communication

Nodes that are running test scripts at the same time can store data in the data queue for real-time communication. Each instrument has an internal data queue that uses the first-in, first-out (FIFO) structure to store data. You can use the data queue to post numeric values, strings, and tables.

Use the data queue commands to:

- Share data between test scripts running in parallel
- Access data from a remote group or a local node on a TSP-Link® network at any time

You cannot access the reading buffers or global variables from any node in a remote group while a node in that group is performing an overlapped operation. However, you can use the data queue to retrieve data from any node in a group that is performing an overlapped operation. In addition, the master node and the group leaders can use the data queue to coordinate activities.

Tables in the data queue consume one entry. When a node stores a table in the data queue, a copy of the data in the table is made. When the data is retrieved from the data queue, a new table is created on the node that is retrieving the data. The new table contains a separate copy of the data in the original table, with no references to the original table or any subtables.

You can access data from the data queue even if a remote group or a node has overlapped operations in process. See the `dataqueue` commands in the [TSP command reference](#) (on page 11-1) for more information.

Copying test scripts across the TSP-Link network

To run a large script on a remote node, copy the test script to the remote node to increase the speed of test script initiation.

The code in the example below copies a test script across the TSP-Link® network, creating a copy of the script on the remote node with the same name.

```
-- Add the source code from the script
-- testScript to the data queue.
node[2].dataqueue.add(testScript.source)
-- Create a new script on the remote node
-- using the source code from testScript.
node[2].execute(testScript.name ..
    "= script.new(dataqueue.next(), [\" .. testScript.name .. \"])" )
```

Removing stale values from the reading buffer cache

The node that acquires the data also stores the data for the reading buffer. To optimize data access, all nodes can cache data from the node that stores the reading buffer data.

When you run Lua code remotely, it can cause reading buffer data that is held in the cache to become stale. If the values in the reading buffer change while the Lua code runs remotely, another node can hold stale values. Use the `clearcache()` command to clear the cache. For additional detail on the reading buffer cache commands, see [bufferVar.cachemode](#) (on page 11-19) and [bufferVar.clearcache\(\)](#) (on page 11-22).

The following example code demonstrates how stale values occur and how to use the `clearcache()` command to clear the cache on node 2, which is part of group 7.

```
-- Create a reading buffer on a node in a remote group.
node[2].tsplink.group = 7
node[2].execute("rbremote = smua.makebuffer(20)" ..
               "smua.measure.count = 20 " ..
               "smua.measure.v(rbremote)")
-- Create a variable on the local node to
-- access the reading buffer.
rblocal = node[2].getglobal("rbremote")
-- Access data from the reading buffer.
print(rblocal[1])
-- Run code on the remote node that updates the reading buffer.
node[2].execute("smua.measure.v(rbremote)")
-- Use the clearcache command if the reading buffer contains cached data.
rblocal.clearcache()
-- If you do not use the clearcache command, the data buffer
-- values will never update. Every time the print command is
-- issued after the first print command, the same data buffer
-- values will print.
print(rblocal[1])
```

TSP-Net

The TSP-Net® library allows the 2601B-PULSE to control LAN-enabled devices directly through its LAN port. This enables the 2601B-PULSE to communicate directly with a device that is not TSP® enabled without the use of a controlling computer.

TSP-Net capabilities

The TSP-Net library permits the 2601B-PULSE to control a remote instrument through the LAN port for both Test Script Processor (TSP®) and non-TSP instruments. Using TSP-Net library methods, you can transfer string data to and from a remote instrument, transfer and format data into Lua variables, and clear input buffers. The TSP-Net library is only accessible using commands from a remote command interface.

You can use TSP-Net commands to communicate with any ethernet-enabled instrument. However, specific TSP-Net commands exist for TSP-enabled instruments to allow for support of features unique to the TSP scripting engine. These features include script downloads, reading buffer access, wait completion, and handling of TSP scripting engine prompts.

Using TSP-Net commands with TSP-enabled instruments, a 2601B-PULSE can download a script to another TSP-enabled instrument and have both instruments run scripts independently. The 2601B-PULSE can read the data from the remote instrument and either manipulate the data or send the data to a different remote instrument on the LAN. You can simultaneously connect to a maximum of 32 devices using standard TCP/IP networking techniques through the LAN port of the 2601B-PULSE.

Using TSP-Net with any ethernet-enabled instrument

NOTE

Refer to [TSP command reference](#) (on page 11-1) for details about the commands presented in this section.

The 2601B-PULSE LAN port is auto-sensing (Auto-MDIX), so you can use either a LAN crossover cable or a LAN straight-through cable to connect directly from the 2601B-PULSE to an ethernet device or to a hub.

To set up communication to a remote ethernet-enabled instrument that is TSP® enabled:

1. Send the following command to configure TSP-Net to send an abort command when a connection to a TSP instrument is established:

```
tspnet.tsp.abortonconnect = 1
```

If the scripts are allowed to run, the connection is made, but the remote instrument may be busy.

2. Send the command:

```
connectionID = tspnet.connect(ipAddress)
```

Where:

- *connectionID* is the connection ID that will be used as a handle in all other TSP-Net function calls.
- *ipAddress* is the IP address, entered as a string, of the remote instrument.

See [tspnet.connect\(\)](#) (on page 11-380) for additional detail.

To set up communication to a remote ethernet-enabled device that is not TSP enabled:

Send the command:

```
connectionID = tspnet.connect(ipAddress, portNumber, initString)
```

Where:

- *connectionID* is the connection ID that will be used as a handle in all other `tspnet` function calls.
- *ipAddress* is the IP address, entered as a string, of the remote device.
- *portNumber* is the port number of the remote device.
- *initString* is the initialization string that is to be sent to *ipAddress*.

See [tspnet.connect\(\)](#) (on page 11-380) for additional detail.

To communicate to a remote ethernet device from the 2601B-PULSE:

1. Connect to the remote device using one of the above procedures. If the 2601B-PULSE cannot make a connection to the remote device, it generates a timeout event. Use `tspnet.timeout` to set the timeout value. The default timeout value is 20 s.
2. Use `tspnet.write()` or `tspnet.execute()` to send strings to a remote device. If you use:
 - `tspnet.write()`: Strings are sent to the device exactly as indicated, and you must supply any needed termination characters.
 - `tspnet.execute()`: The 2601B-PULSE appends termination characters to all strings that are sent. Use `tspnet.termination()` to specify the termination character.
3. To retrieve responses from the remote instrument, use `tspnet.read()`. The 2601B-PULSE suspends operation until the remote device responds or a timeout event is generated. To check if data is available from the remote instrument, use `tspnet.readavailable()`.
4. Disconnect from the remote device using the `tspnet.disconnect()` function. Terminate all remote connections using `tspnet.reset()`.

Example script

The following example demonstrates how to connect to a remote device that is not TSP® enabled, and send and receive data from this device:

```
-- Set tspnet timeout to 5 s.
tspnet.timeout = 5
-- Establish connection to another device with IP address 192.168.1.51
-- at port 1394.
id_instr = tspnet.connect("192.168.1.51", 1394, "*rst\r\n")
-- Print the device ID from connect string.
print("ID is: ", id_instr)
-- Set the termination character to CRLF. You must do this
-- for each connection after the connection has been made.
tspnet.termination(id_instr, tspnet.TERM_CRLF)
-- Send the command string to the connected device.
tspnet.write(id_instr, "login admin\r\n")
-- Read the data available, then print it.
tspnet.write(id_instr, "*idn?\r\n")
print("instrument write/read returns: ", tspnet.read(id_instr))
-- Disconnect all existing TSP-Net sessions.
tspnet.reset()
```

This example produces a return such as:

```
ID is:      1
instrument write/read returns:      SUCCESS: Logged in
instrument write/read returns:      KEITHLEY INSTRUMENTS,MODEL
                                     2601B-PULSE,04089762,1.6.3d
```

TSP-Net compared to TSP-Link to communicate with TSP-enabled devices

The TSP-Link® network interface is the preferred communication method for most applications where communication occurs between the 2601B-PULSE and another TSP-enabled instrument.

One of the advantages of using the TSP-Link network interface is that TSP-Link connections have three trigger lines that are available to each device on the TSP-Link network. You can use any one of the trigger lines to perform hardware triggering between devices on the TSP-Link network. Refer to [Hardware trigger modes](#) (on page 6-28) for details.

However, if the distance between the 2601B-PULSE and the TSP-enabled device is longer than 15 feet, use TSP-Net commands.

TSP-Net instrument commands: General device control

The following instrument commands provide general device control:

[tspnet.clear\(\)](#) (on page 11-379)
[tspnet.connect\(\)](#) (on page 11-380)
[tspnet.disconnect\(\)](#) (on page 11-381)
[tspnet.execute\(\)](#) (on page 11-382)
[tspnet.idn\(\)](#) (on page 11-383)
[tspnet.read\(\)](#) (on page 11-383)
[tspnet.readavailable\(\)](#) (on page 11-384)
[tspnet.reset\(\)](#) (on page 11-385)
[tspnet.termination\(\)](#) (on page 11-385)
[tspnet.timeout](#) (on page 11-386)
[tspnet.write\(\)](#) (on page 11-390)

TSP-Net instrument commands: TSP-enabled device control

The following instrument commands provide TSP-enabled device control:

[tspnet.tsp.abort\(\)](#) (on page 11-387)
[tspnet.tsp.abortonconnect](#) (on page 11-387)
[tspnet.tsp.rtablecopy\(\)](#) (on page 11-388)
[tspnet.tsp.runscript\(\)](#) (on page 11-389)

Example: Using tspnet commands

```

function telnetConnect(ipAddress, userName, password)
    -- Connect through Telnet to a computer.
    id = tspnet.connect(ipAddress, 23, "")
    -- Read the title and login prompt from the computer.
    print(string.format("from computer--> (%s)", tspnet.read(id, "%n")))
    print(string.format("from computer--> (%s)", tspnet.read(id, "%s")))
    -- Send the login name.
    tspnet.write(id, userName .. "\r\n")
    -- Read the login echo and password prompt from the computer.
    print(string.format("from computer--> (%s)", tspnet.read(id, "%s")))
    -- Send the password information.
    tspnet.write(id, password .. "\r\n")
    -- Read the telnet banner from the computer.
    print(string.format("from computer--> (%s)", tspnet.read(id, "%n")))
    print(string.format("from computer--> (%s)", tspnet.read(id, "%n")))
    print(string.format("from computer--> (%s)", tspnet.read(id, "%n")))
    print(string.format("from computer--> (%s)", tspnet.read(id, "%n")))
end

function test_tspnet()
    tspnet.reset()
    -- Connect to a computer using Telnet.
    telnetConnect("192.0.2.1", "my_username", "my_password")
    -- Read the prompt back from the computer.
    print(string.format("from computer--> (%s)", tspnet.read(id, "%n")))
    -- Change directory and read the prompt back from the computer.
    tspnet.write(id, "cd c:\\\r\n")
    print(string.format("from computer--> (%s)", tspnet.read(id, "%s")))
    -- Make a directory and read the prompt back from the computer.
    tspnet.write(id, "mkdir TEST_TSP\r\n")
    print(string.format("from computer--> (%s)", tspnet.read(id, "%s")))
    -- Change to the newly created directory.
    tspnet.write(id, "cd c:\\TEST_TSP\r\n")
    print(string.format("from computer--> (%s)", tspnet.read(id, "%s")))
    -- if you have data print it to the file.
    -- 11.2 is an example of data collected.
    cmd = "echo " .. string.format("%g", 11.2) .. " >> datafile.dat\r\n"
    tspnet.write(id, cmd)
    print(string.format("from computer--> (%s)", tspnet.read(id, "%s")))
    tspnet.disconnect(id)
end

test_tspnet()

```

TSP command reference

In this section:

TSP command programming notes.....	11-1
Using the TSP command reference	11-4
TSP commands.....	11-8

TSP command programming notes

This section contains general information about using TSP commands.

Placeholder text

This manual uses italicized text to represent the parts of remote commands that must be replaced by user-specified values. The following examples show typical uses of italicized text:

Example 1:

```
beeper.enable = state
```

Where *state* can be a value (`beeper.ON` or `beeper.OFF`) or an integer (1 or 0) that you specify. For example, to set this attribute on, you would send one of the following commands:

```
beeper.enable = beeper.ON
```

```
beeper.enable = 1
```

Example 2:

```
digio.trigger[N].assert()
```

Where *N* is an integer (1 to 14) that you specify. For example, to assert trigger line 7 you would send:

```
digio.trigger[7].assert()
```

To assert a trigger line with a variable as the integer, you would send:

```
triggerline = 7
```

```
digio.trigger[triggerline].assert()
```

Example 3:

```
smua.trigger.measure.Y(rbuffer)
```

Where:

- *Y* is the measurement type that you specify (*v*, *i*, *r*, or *p*).
- *rbuffer* is the reading buffer object where the readings will be stored.

For example, to make voltage measurements and store them in buffer *vbuffername*, you would send:

```
smua.trigger.measure.v(vbuffername)
```

Syntax rules

Use these syntax requirements to build well-formed instrument control commands.

Instrument commands are case sensitive. Refer to the command reference descriptions for the correct case.

The white space in lists of parameters in functions is optional. For example, the following functions are equivalent:

```
digio.writebit(3,0)
digio.writebit (3, 0)
```

All functions must have a set of parentheses () immediately following the function, even if there are no parameters specified. For example:

```
waitcomplete(G)
timezone = localtime.gettimezone()
```

If there are multiple parameters, they must be separated by commas (,). For example:

```
beeper.beep(0.5, 2400)
```

Time and date values

Time and date values are represented as the number of seconds since some base. Representing time as a number of seconds is referred to as “standard time format.” There are three time bases:

- **UTC 12:00 am Jan 1, 1970.** Some examples of UTC time are reading buffer base timestamps, adjustment dates, and the value returned by `os.time()`.
- **Instrument on.** References time to when the instrument was turned on. The value returned by `os.clock()` is referenced to the turn-on time.
- **Event.** Time referenced to an event, such as the first reading stored in a reading buffer.

Settings ignored when the pulser is enabled

The following source-measure unit (SMU) settings are ignored when the pulser is enabled:

- `display.smua.limit.func`
- `smua.measure.autorangeY`
- `smua.measure.autozero`
- `smua.measure.delay`
- `smua.measure.highcrangedelayfactor`
- `smua.measure.lowrangeY`
- `smua.measure.nplc`
- `smua.measure.rangeY`
- `smua.sense`
- `smua.source.autorangeY`
- `smua.source.delay`
- `smua.source.func`
- `smua.source.highc`
- `smua.source.limitY`
- `smua.source.lowrangeY`
- `smua.source.offlimitY`
- `smua.source.rangeY`
- `smua.source.settling`
- `smua.source.sink`
- `smua.trigger.endpulse.action`
- `smua.trigger.endsweep.action`

Settings ignored when the pulser is disabled

The following pulser settings do not affect source-measure unit (SMU) operation when the pulser is disabled:

- `smua.pulser.measure.aperture`
- `smua.pulser.measure.delay`
- `smua.pulser.protect.sensev`
- `smua.pulser.protect.sourcev`
- `smua.pulser.rangeY`

Using the TSP command reference

The Test Script Processor (TSP®) command reference contains detailed descriptions of each of the TSP commands that you can use to control your instrument. Each command description is broken into subsections. The figure below shows an example of a command description.

Figure 139: Example instrument command description

beeper.enable

This attribute allows you to turn the beeper on or off.

Type	TSP-Link accessible	Affected by	Where saved	Default value
Attribute (RW)	Yes	Recall setup Instrument reset	Recall setup Create configuration script	1 (beeper.ON)

Usage

```
state = beeper.enable
beeper.enable = state
```

state	beeper.OFF or 0: Beeper disabled beeper.ON or 1: Beeper enabled
-------	--

Details

Disabling the beeper also disables front panel key clicks.

Example

beeper.enable = beeper.ON beeper.beep (2, 2400)	Enables the beeper and generates a two-second, 2400 Hz tone
--	---

Also see

[beeper.beep\(\)](#) (on page 8-10)

The subsections contain information about the command. The subsections are:

- Command name and summary table
- Usage
- Details
- Example
- Also see

The content of each of these subsections is described in the following topics.

Command name and summary table

Each instrument command description starts with the command name, followed by a brief description and a table with relevant information for each command. Definitions for the numbered items in the figure below are listed following the figure.

Figure 140: TSP command name and summary table

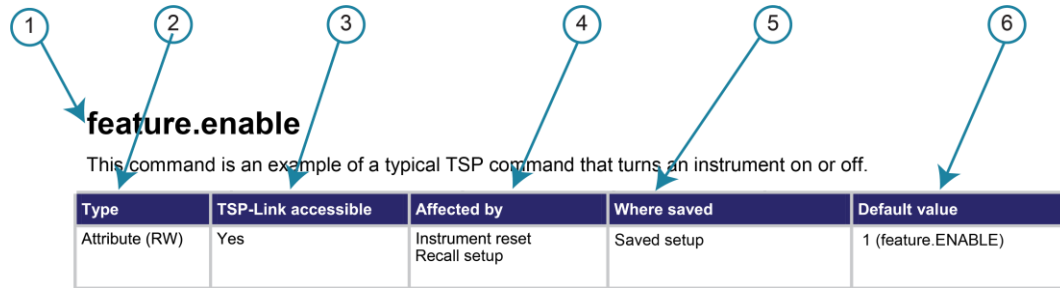

1. **Instrument command name.** Indicates the beginning of the command description. It is followed by a brief description of what the command does.
2. **Type of command.** Commands can be functions, attributes, or constants. If the command is an attribute, it can be read-only (R), read-write (RW), or write-only (W). For detail on commands, see [Introduction to TSP operation](#) (on page 9-1).
3. **TSP-Link accessible. Yes or No;** indicates whether or not the command can be accessed through a TSP-Link network.
4. **Affected by.** Commands or actions that may change the setting of this command.
 - **LAN restore defaults:** This command is reset to the default value when `lan.restoredefaults()` is sent.
 - **Digital I/O trigger N reset:** This command is reset to the default value when `digio.trigger[N].reset()` is sent.
 - **Recall setup:** This command is stored as part of the saved setup and is changed to the value stored in the saved setup when the setup is recalled.
 - **Instrument reset:** This command is reset to the default value when `reset()`, `localnode.reset()`, or `*RST` is sent.
 - **SMU reset:** This command is reset to the default value when `smua.reset()` is sent.
 - **Power cycle:** This command is set to the default value when the instrument power is cycled.
5. **Where saved.** Indicates where the command settings reside once they are used on an instrument. Options include:
 - **Not saved:** Command is not saved anywhere and must be typed each time you use it.
 - **Nonvolatile memory:** Storage area in the instrument where information is saved when the instrument is turned off.
 - **Saved setup:** Command is saved as part of the saved setup.
6. **Default value:** Lists the default value or constant for the command. The parameter values are defined in the Usage or Details sections of the command description.

Command usage

The Usage section of the remote command listing shows how to properly structure the command. Each line in the Usage section is a separate variation of the command usage. All possible command usage options are shown.

Figure 141: TSP usage description

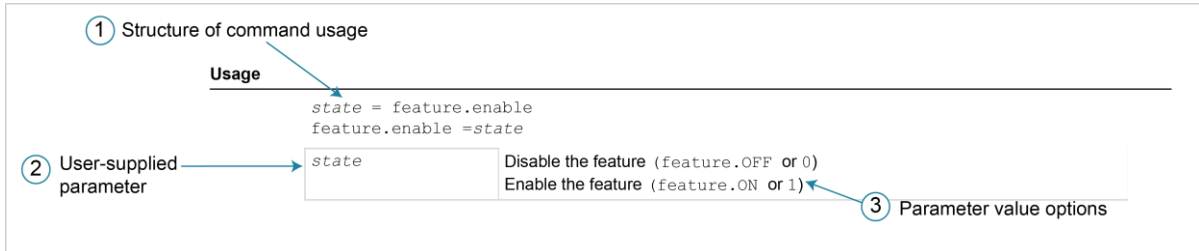

- 1 Structure of command usage:** Shows how the parts of the command should be organized. If a parameter is shown to the left of the command, it is the return when you print the command. Information to the right is the parameters or other items you need to enter when setting the command.
- 2 User-supplied parameters:** Indicated by italics. For example, for the function `beeper.beep(duration, frequency)`, replace *duration* with the number of seconds and *frequency* with the frequency of the tone. Send `beeper.beep(2, 2400)` to generate a two-second, 2400 Hz tone.

Some commands have optional parameters. If there are optional parameters, they must be entered in the order presented in the Usage section. You cannot leave out any parameters that precede the optional parameter. Optional parameters are shown as separate lines in usage, presented in the required order with each valid permutation of the optional parameters.

For example:

```
printbuffer(startIndex, endIndex, buffer1)
printbuffer(startIndex, endIndex, buffer1, buffer2)
```

- 3 Parameter value options:** Descriptions of the options that are available for the user-defined parameter.

Command details

This section lists additional information you need to know to successfully use the remote command.

Figure 142: TSP Details description

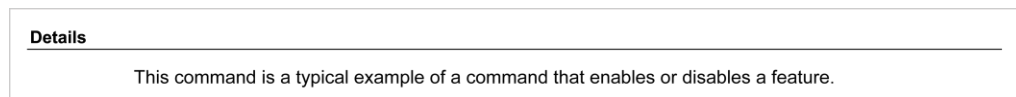

Example section

The Example section of the remote command description shows examples of how you can use the command.

Figure 143: TSP example code



- 1 Actual example code that you can copy from this table and paste into your own programming application.
- 2 Description of the code and what it does. This may also contain example output of the code.

Related commands and information

The Also see section of the remote command description lists additional commands or sections that are related to the command.

Figure 144: TSP Also see description

Also see
exampleUnit.enable() (on page 7-8)

TSP commands

The TSP commands available for the instrument are listed in alphabetic order.

beeper.beep()

This function generates an audible tone.

Type	TSP-Link accessible	Affected by	Where saved	Default value
Function	Yes			

Usage

```
beeper.beep(duration, frequency)
```

<i>duration</i>	The amount of time to play the tone (0.001 s to 100 s)
<i>frequency</i>	The frequency of the tone in Hertz (Hz)

Details

You can use the beeper of the 2601B-PULSE to provide an audible signal at a specified frequency and time duration. For example, you can use the beeper to signal the end of a lengthy sweep.

The beeper will not sound if it is disabled. It can be disabled or enabled with the beeper enable command, or through the front panel.

Example

```
beeper.enable = beeper.ON
beeper.beep(2, 2400)
```

Enables the beeper and generates a two-second, 2400 Hz tone.

Also see

[beeper.enable](#) (on page 11-8)

beeper.enable

This command allows you to turn the beeper on or off.

Type	TSP-Link accessible	Affected by	Where saved	Default value
Attribute (RW)	Yes	Recall setup Instrument reset	Saved setup	1 (beeper.ON)

Usage

```
state = beeper.enable
beeper.enable = state
```

<i>state</i>	Disable the beeper: <code>beeper.OFF</code> or <code>0</code> Enable the beeper: <code>beeper.ON</code> or <code>1</code>
--------------	--

Details

This command enables or disables the beeper. When enabled, a beep signals that a front-panel key has been pressed. Disabling the beeper also disables front-panel key clicks.

Example

<pre>beeper.enable = beeper.ON beeper.beep(2, 2400)</pre>	Enables the beeper and generates a two-second, 2400 Hz tone.
---	--

Also see

[beeper.beep\(\)](#) (on page 11-8)

bit.bitand()

This function performs a bitwise logical AND operation on two numbers.

Type	TSP-Link accessible	Affected by	Where saved	Default value
Function	No			

Usage

```
result = bit.bitand(value1, value2)
```

<i>result</i>	Result of the logical AND operation
<i>value1</i>	Operand for the logical AND operation
<i>value2</i>	Operand for the logical AND operation

Details

Any fractional parts of *value1* and *value2* are truncated to form integers. The returned *result* is also an integer.

Example

<pre>testResult = bit.bitand(10, 9) print(testResult)</pre>	Performs a logical AND operation on decimal 10 (binary 1010) with decimal 9 (binary 1001), which returns a value of decimal 8 (binary 1000). Output: 8.00000e+00
---	--

Also see

[Bit manipulation and logic operations](#) (on page 9-4)

[bit.bitor\(\)](#) (on page 11-10)

[bit.bitxor\(\)](#) (on page 11-10)

bit.bitor()

This function performs a bitwise logical OR operation on two numbers.

Type	TSP-Link accessible	Affected by	Where saved	Default value
Function	No			

Usage

```
result = bit.bitor(value1, value2)
```

<i>result</i>	Result of the logical OR operation
<i>value1</i>	Operand for the logical OR operation
<i>value2</i>	Operand for the logical OR operation

Details

Any fractional parts of *value1* and *value2* are truncated to make them integers. The returned *result* is also an integer.

Example

```
testResult = bit.bitor(10, 9)
print(testResult)
```

Performs a bitwise logical OR operation on decimal 10 (binary 1010) with decimal 9 (binary 1001), which returns a value of decimal 11 (binary 1011).

Output:
1.10000e+01

Also see

[Bit manipulation and logic operations](#) (on page 9-4)

[bit.bitand\(\)](#) (on page 11-9)

[bit.bitxor\(\)](#) (on page 11-10)

bit.bitxor()

This function performs a bitwise logical XOR (exclusive OR) operation on two numbers.

Type	TSP-Link accessible	Affected by	Where saved	Default value
Function	No			

Usage

```
result = bit.bitxor(value1, value2)
```

<i>result</i>	Result of the logical XOR operation
<i>value1</i>	Operand for the logical XOR operation
<i>value2</i>	Operand for the logical XOR operation

Details

Any fractional parts of *value1* and *value2* are truncated to make them integers. The returned *result* is also an integer.

Example

<pre>testResult = bit.bitxor(10, 9) print(testResult)</pre>	<p>Performs a logical XOR operation on decimal 10 (binary 1010) with decimal 9 (binary 1001), which returns a value of decimal 3 (binary 0011). Output: 3.00000e+00</p>
--	---

Also see

- [Bit manipulation and logic operations](#) (on page 9-4)
- [bit.bitand\(\)](#) (on page 11-9)
- [bit.bitor\(\)](#) (on page 11-10)

bit.clear()

This function clears a bit at a specified index position.

Type	TSP-Link accessible	Affected by	Where saved	Default value
Function	No			

Usage

```
result = bit.clear(value, index)
```

<i>result</i>	Result of the bit manipulation
<i>value</i>	Specified number
<i>index</i>	One-based bit position within value to clear (1 to 32)

Details

Any fractional part of *value* is truncated to make it an integer. The returned *result* is also an integer.

The least significant bit of *value* is at *index* position 1; the most significant bit is at *index* position 32.

Example

<pre>testResult = bit.clear(15, 2) print(testResult)</pre>	<p>The binary equivalent of decimal 15 is 1111. If you clear the bit at <i>index</i> position 2, the returned decimal value is 13 (binary 1101). Output: 1.30000e+01</p>
---	--

Also see

- [Bit manipulation and logic operations](#) (on page 9-4)
- [bit.get\(\)](#) (on page 11-12)
- [bit.set\(\)](#) (on page 11-14)
- [bit.test\(\)](#) (on page 11-16)
- [bit.toggle\(\)](#) (on page 11-17)

bit.get()

This function retrieves the weighted value of a bit at a specified index position.

Type	TSP-Link accessible	Affected by	Where saved	Default value
Function	No			

Usage

```
result = bit.get(value, index)
```

<i>result</i>	Result of the bit manipulation
<i>value</i>	Specified number
<i>index</i>	One-based bit position within <i>value</i> to get (1 to 32)

Details

This function returns the value of the bit in *value* at *index*. This is the same as returning *value* with all other bits set to zero (0).

The least significant bit of *value* is at *index* position 1; the most significant bit is at *index* position 32.

If the indexed bit for the number is set to zero (0), the result will be zero (0).

Example

```
testResult = bit.get(10, 4)
print(testResult)
```

The binary equivalent of decimal 10 is 1010. If you get the bit at index position 4, the returned decimal value is 8.
Output:
8.00000e+00

Also see

[Bit manipulation and logic operations](#) (on page 9-4)

[bit.clear\(\)](#) (on page 11-11)

[bit.set\(\)](#) (on page 11-14)

[bit.test\(\)](#) (on page 11-16)

[bit.toggle\(\)](#) (on page 11-17)

bit.getfield()

This function returns a field of bits from the value starting at the specified index position.

Type	TSP-Link accessible	Affected by	Where saved	Default value
Function	No			

Usage

```
result = bit.getfield(value, index, width)
```

<i>result</i>	Result of the bit manipulation
<i>value</i>	Specified number
<i>index</i>	One-based bit position within <i>value</i> to get (1 to 32)
<i>width</i>	The number of bits to include in the field (1 to 32)

Details

A field of bits is a contiguous group of bits. This function retrieves a field of bits from *value* starting at *index*.

The *index* position is the least significant bit of the retrieved field. The number of bits to return is specified by *width*.

The least significant bit of *value* is at *index* position 1; the most significant bit is at *index* position 32.

Example

```
myResult = bit.getfield(13, 2, 3)

print(myResult)
```

The binary equivalent of decimal 13 is 1101.
The field at *index* position 2 and *width* 3 consists of the binary bits 110. The returned value is decimal 6 (binary 110).
Output:
6.00000e+00

Also see

- [Bit manipulation and logic operations](#) (on page 9-4)
- [bit.get\(\)](#) (on page 11-12)
- [bit.set\(\)](#) (on page 11-14)
- [bit.setfield\(\)](#) (on page 11-15)

bit.set()

This function sets a bit at the specified index position.

Type	TSP-Link accessible	Affected by	Where saved	Default value
Function	No			

Usage

```
result = bit.set(value, index)
```

<i>result</i>	Result of the bit manipulation
<i>value</i>	Specified number
<i>index</i>	One-based bit position within <i>value</i> to set (1 to 32)

Details

This function returns *result*, which is *value* with the indexed bit set. The *index* must be between 1 and 32.

The least significant bit of *value* is at *index* position 1; the most significant bit is at *index* position 32.

Any fractional part of *value* is truncated to make it an integer.

Example

```
testResult = bit.set(8, 3)
print(testResult)
```

The binary equivalent of decimal 8 is 1000. If the bit at *index* position 3 is set to 1, the returned value is decimal 12 (binary 1100).
Output:
1.20000e+01

Also see

- [Bit manipulation and logic operations](#) (on page 9-4)
- [bit.clear\(\)](#) (on page 11-11)
- [bit.get\(\)](#) (on page 11-12)
- [bit.getfield\(\)](#) (on page 11-13)
- [bit.setfield\(\)](#) (on page 11-15)
- [bit.test\(\)](#) (on page 11-16)
- [bit.toggle\(\)](#) (on page 11-17)

bit.setfield()

This function overwrites a bit field at a specified index position.

Type	TSP-Link accessible	Affected by	Where saved	Default value
Function	No			

Usage

```
result = bit.setfield(value, index, width, fieldValue)
```

<i>result</i>	Result of the bit manipulation
<i>value</i>	Specified number
<i>index</i>	One-based bit position in <i>value</i> to set (1 to 32)
<i>width</i>	The number of bits to include in the field (1 to 32)
<i>fieldValue</i>	Value to write to the field

Details

This function returns *result*, which is *value* with a field of bits overwritten, starting at *index*. The *index* specifies the position of the least significant bit of *value*. The *width* bits starting at *index* are set to *fieldValue*.

The least significant bit of *value* is at *index* position 1; the most significant bit is at *index* position 32.

Before setting the field of bits, any fractional parts of *value* and *fieldValue* are truncated to form integers.

If *fieldValue* is wider than *width*, the most significant bits of the *fieldValue* that exceed the width are truncated. For example, if *width* is 4 bits and the binary value for *fieldValue* is 11110 (5 bits), the most significant bit of *fieldValue* is truncated and a binary value of 1110 is used.

Example

```
testResult = bit.setfield(15, 2, 3, 5)

print(testResult)
```

The binary equivalent of decimal 15 is 1111. After overwriting it with a decimal 5 (binary 101) at *index* position 2, the returned value is decimal 11 (binary 1011).
Output:
1.10000e+01

Also see

- [Bit manipulation and logic operations](#) (on page 9-4)
- [bit.get\(\)](#) (on page 11-12)
- [bit.set\(\)](#) (on page 11-14)
- [bit.getfield\(\)](#) (on page 11-13)

bit.test()

This function returns the Boolean value (`true` or `false`) of a bit at the specified index position.

Type	TSP-Link accessible	Affected by	Where saved	Default value
Function	No			

Usage

```
result = bit.test(value, index)
```

<i>result</i>	Result of the bit manipulation
<i>value</i>	Specified number
<i>index</i>	One-based bit position within value to test (1 to 32)

Details

This function returns *result*, which is the result of the tested bit.

The least significant bit of *value* is at *index* position 1; the most significant bit is at *index* position 32.

If the indexed bit for *value* is 0, *result* is `false`. If the bit of *value* at *index* is 1, the returned value is `true`.

If *index* is bigger than the number of bits in *value*, the result is `false`.

Example

```
testResult = bit.test(10, 4)
print(testResult)
```

The binary equivalent of decimal 10 is 1010. Testing the bit at *index* position 4 returns a Boolean value of `true`.

Output:
`true`

Also see

[Bit manipulation and logic operations](#) (on page 9-4)

[bit.clear\(\)](#) (on page 11-11)

[bit.get\(\)](#) (on page 11-12)

[bit.set\(\)](#) (on page 11-14)

[bit.toggle\(\)](#) (on page 11-17)

bit.toggle()

This function toggles the value of a bit at a specified index position.

Type	TSP-Link accessible	Affected by	Where saved	Default value
Function	No			

Usage

```
result = bit.toggle(value, index)
```

<i>result</i>	Result of the bit manipulation
<i>value</i>	Specified number
<i>index</i>	One-based bit position within <i>value</i> to toggle (1 to 32)

Details

This function returns *result*, which is the result of toggling the bit *index* in *value*.

Any fractional part of *value* is truncated to make it an integer. The returned value is also an integer.

The least significant bit of *value* is at *index* position 1; the most significant bit is at *index* position 32.

The indexed bit for *value* is toggled from 0 to 1, or 1 to 0.

Example

```
testResult = bit.toggle(10, 3)
print(testResult)
```

The binary equivalent of decimal 10 is 1010. Toggling the bit at *index* position 3 returns a decimal value of 14 (binary 1110).
Output:
1.40000e+01

Also see

[Bit manipulation and logic operations](#) (on page 9-4)

[bit.clear\(\)](#) (on page 11-11)

[bit.get\(\)](#) (on page 11-12)

[bit.set\(\)](#) (on page 11-14)

[bit.test\(\)](#) (on page 11-16)

bufferVar.appendmode

This attribute sets the state of the append mode of the reading buffer.

Type	TSP-Link accessible	Affected by	Where saved	Default value
Attribute (RW)	Yes	Not applicable	See Details	0 (disabled)

Usage

```
state = bufferVar.appendmode
bufferVar.appendmode = state
```

<i>state</i>	The reading buffer append mode; set to one of the following: <ul style="list-style-type: none"> ▪ 0: Append mode off; new measurement data overwrites the previous buffer content ▪ 1: Append mode on; appends new measurement data to the present buffer content
<i>bufferVar</i>	The reading buffer; can be a dynamically allocated user-defined buffer or a dedicated reading buffer

Details

Assigning a value to this attribute enables or disables the buffer append mode. This value can only be changed with an empty buffer. Use `bufferVar.clear()` to empty the buffer.

For dedicated reading buffers, all buffer attributes are saved to nonvolatile memory only when the reading buffer is saved to nonvolatile memory.

If the append mode is set to 0, any stored readings in the buffer are cleared before new ones are stored. If append mode is set to 1, any stored readings remain in the buffer and new readings are added to the buffer after the stored readings.

With append mode on, the first new measurement is stored at `rb[n+1]`, where *n* is the number of readings stored in buffer `rb`.

Example

```
buffer1.appendmode = 1
```

Append new readings to contents of the reading buffer named `buffer1`.

Also see

[bufferVar.clear\(\)](#) (on page 11-21)

[Reading buffers](#) (on page 5-1)

bufferVar.basetimestamp

This attribute contains the timestamp that indicates when the first reading was stored in the buffer.

Type	TSP-Link accessible	Affected by	Where saved	Default value
Attribute (R)	Yes	Not applicable	See Details	0

Usage

```
basetime = bufferVar.basetimestamp
```

<i>basetime</i>	The timestamp of the first stored reading
<i>bufferVar</i>	The reading buffer; can be a dynamically allocated buffer (user-defined), or a dedicated reading buffer (such as <code>smua.nvbuffer1</code>)

Details

This read-only attribute contains the timestamp (in seconds) of the first reading stored in a buffer (`rb[1]` stored in reading buffer `rb`). The timestamp is the number of seconds since 12:00 am January 1, 1970 (UTC) that the measurement was performed and stored.

For dedicated reading buffers, all buffer attributes are saved to nonvolatile memory only when the reading buffer is saved to nonvolatile memory.

See the `smua.nvbufferY` attribute for details on accessing dedicated reading buffers.

Example

```
basetime = smua.nvbuffer1.basetimestamp
print(basetime)
```

Read the timestamp for the first reading stored in dedicated reading buffer 1.

Output:

1.57020e+09

This output indicates that the timestamp is 1,570,200,000 seconds (which is Friday, October, 4, 2019 at 14:40:00 pm).

Also see

- [Reading buffers](#) (on page 5-1)
- [smua.measure.overlappedY\(\)](#) (on page 11-205)
- [smua.measure.Y\(\)](#) (on page 11-209)
- [smua.nvbufferY](#) (on page 11-211)
- [smua.trigger.measure.Y\(\)](#) (on page 11-251)

bufferVar.cachemode

This attribute enables or disables the reading buffer cache (on or off).

Type	TSP-Link accessible	Affected by	Where saved	Default value
Attribute (RW)	Yes	Not applicable	Not saved	1 (enabled)

Usage

```
cacheMode = bufferVar.cachemode
bufferVar.cachemode = cacheMode
```

<code>cacheMode</code>	The reading buffer cache mode; set to one of the following: <ul style="list-style-type: none"> ▪ 0: Cache mode disabled (off) ▪ 1: Cache mode enabled (on)
<code>bufferVar</code>	The reading buffer; can be a dynamically allocated user-defined buffer or a dedicated reading buffer

Details

Assigning a value to this attribute enables or disables the reading buffer cache. When enabled, the reading buffer cache improves access speed to reading buffer data.

If you run successive operations that overwrite reading buffer data, the reading buffer may return stale cache data. This can happen when initiating successive sweeps without reconfiguring the sweep measurements or when overwriting data in the reading buffer by setting the `bufferVar.fillmode` attribute to `smua.FILL_WINDOW`. To avoid this, make sure that you include commands that automatically invalidate the cache as needed (for example, explicit calls to the `bufferVar.clearcache()` function) or disable the cache using this attribute (`bufferVar.cachemode`).

Example

```
smua.nvbuffer1.cachemode = 1
```

Enables reading buffer cache of dedicated reading buffer 1 (source-measure unit (SMU) channel A).

Also see

[bufferVar.clearcache\(\)](#) (on page 11-22)
[bufferVar.fillmode](#) (on page 11-25)
[Reading buffers](#) (on page 5-1)

bufferVar.capacity

This attribute sets the number of readings a buffer can store.

Type	TSP-Link accessible	Affected by	Where saved	Default value
Attribute (R)	Yes	Not applicable	See Details	Not applicable

Usage

```
bufferCapacity = bufferVar.capacity
```

<code>bufferCapacity</code>	The maximum number of readings the buffer can store
<code>bufferVar</code>	The reading buffer; can be a dynamically allocated user-defined buffer or a dedicated reading buffer

Details

This read-only attribute reads the number of readings that can be stored in the buffer.

For dedicated reading buffers, all buffer attributes are saved to nonvolatile memory only when the reading buffer is saved to nonvolatile memory.

The capacity of the buffer does not change as readings fill the buffer. A dedicated reading buffer that only collects basic items can store over 140,000 readings. Turning on additional collection items, such as timestamps and source values, decreases the capacity of a dedicated reading buffer (for example, `smua.nvbuffer1`), but does not change the capacity of a user-defined dynamically allocated buffer. A user-defined dynamically allocated buffer has a fixed capacity that is set when the buffer is created.

See the `smua.nvbufferY` attribute for details on accessing dedicated reading buffers. See the `smua.makebuffer()` function for information on creating user-defined dynamically allocated reading buffers.

Example

<pre>bufferCapacity = smua.nvbuffer1.capacity print (bufferCapacity)</pre>	<p>Reads the capacity of dedicated reading buffer 1 (source-measure unit (SMU) channel A). Output: 1.49789e+05 The above output indicates that the buffer can hold 149789 readings.</p>
--	---

Also see

- [Reading buffers](#) (on page 5-1)
- [smua.makebuffer\(\)](#) (on page 11-193)
- [smua.measure.overlappedY\(\)](#) (on page 11-205)
- [smua.measure.Y\(\)](#) (on page 11-209)
- [smua.nvbufferY](#) (on page 11-211)
- [smua.trigger.measure.Y\(\)](#) (on page 11-251)

bufferVar.clear()

This function empties the buffer.

Type	TSP-Link accessible	Affected by	Where saved	Default value
Function	Yes			

Usage

<pre>bufferVar.clear()</pre>	<p><i>bufferVar</i> The reading buffer; can be a dynamically allocated user-defined buffer or a dedicated reading buffer</p>
------------------------------	--

Details

This function clears all readings and related recall attributes from the buffer (for example, *bufferVar.timestamps* and *bufferVar.statuses*) from the specified buffer.

Example

<pre>smua.nvbuffer1.clear()</pre>	<p>Clears dedicated reading buffer 1 (source-measure unit (SMU) channel A).</p>
-----------------------------------	---

Also see

- [Reading buffers](#) (on page 5-1)
- [smua.nvbufferY](#) (on page 11-211)

bufferVar.clearcache()

This function clears the cache.

Type	TSP-Link accessible	Affected by	Where saved	Default value
Function	Yes			

Usage

```
bufferVar.clearcache()
```

<code>bufferVar</code>	The reading buffer; can be a dynamically allocated user-defined buffer or a dedicated reading buffer
------------------------	--

Details

This function clears all readings from the specified cache.

If you run successive operations that overwrite reading buffer data, the reading buffer may return stale cache data. This can happen when you:

- Initiate successive sweeps without reconfiguring the sweep measurements. Watch for this when running Lua code remotely on more than one node, because values in the reading buffer cache may change while the Lua code is running.
- Overwrite data in the reading buffer by setting the `bufferVar.fillmode` attribute to `smua.FILL_WINDOW`.

To avoid this, you can include explicit calls to the `bufferVar.clearcache()` function to remove stale values from the reading buffer cache.

Example

<code>smua.nvbuffer1.clearcache()</code>	Clears the reading buffer cache for dedicated reading buffer 1.
--	---

Also see

- [bufferVar.fillmode](#) (on page 11-25)
- [Reading buffers](#) (on page 5-1)
- [Removing stale values from the reading buffer cache](#) (on page 10-57)
- [smua.nvbufferY](#) (on page 11-211)

bufferVar.collectsourcevalues

This attribute sets whether or not source values are stored with the readings in the buffer.

Type	TSP-Link accessible	Affected by	Where saved	Default value
Attribute (RW)	Yes	Not applicable	See Details	0 (disabled)

Usage

```
state = bufferVar.collectsourcevalues
bufferVar.collectsourcevalues = state
```

<i>state</i>	Source value collection status; set to one of the following: <ul style="list-style-type: none"> ▪ 0: Source value collection disabled (off) ▪ 1: Source value collection enabled (on)
<i>bufferVar</i>	The reading buffer; can be a dynamically allocated buffer (user-defined), or a dedicated reading buffer (such as <code>smua.nvbuffer1</code>)

Details

Assigning a value to this attribute enables or disables the storage of source values. Reading this attribute returns the state of source value collection. This value can only be changed with an empty buffer. Empty the buffer using the `bufferVar.clear()` function.

For dedicated reading buffers, all buffer attributes are saved to nonvolatile memory only when the reading buffer is saved to nonvolatile memory.

When on, source values are stored with readings in the buffer. This requires four extra bytes of storage for each reading. Turning on additional collection items, such as source values (this attribute) and timestamps, decreases the capacity of a dedicated reading buffer, but does not change the capacity of a user-defined dynamically allocated buffer.

You cannot collect source values when `smua.trigger.measure.action` is set to `smua.ASYNC`, so `bufferVar.collectsourcevalues` must be set to 0 when the measurement action is set to be asynchronous.

Example

```
smua.nvbuffer1.collectsourcevalues = 1
```

Include source values with readings for dedicated reading buffer 1.

Also see

[bufferVar.clear\(\)](#) (on page 11-21)
[Reading buffers](#) (on page 5-1)
[smua.measure.overlappedY\(\)](#) (on page 11-205)
[smua.measure.Y\(\)](#) (on page 11-209)
[smua.nvbufferY](#) (on page 11-211)
[smua.trigger.measure.action](#) (on page 11-248)
[smua.trigger.measure.Y\(\)](#) (on page 11-251)

bufferVar.collecttimestamps

This attribute sets whether or not timestamp values are stored with the readings in the buffer.

Type	TSP-Link accessible	Affected by	Where saved	Default value
Attribute (RW)	Yes	Not applicable	See Details	0 (disabled)

Usage

```
state = bufferVar.collecttimestamps
bufferVar.collecttimestamps = state
```

<i>state</i>	Timestamp value collection status; set to one of the following: <ul style="list-style-type: none"> ▪ 0: Timestamp value collection disabled (off) ▪ 1: Timestamp value collection enabled (on)
<i>bufferVar</i>	The reading buffer; can be a dynamically allocated user-defined buffer or a dedicated reading buffer

Details

Assigning a value to this attribute enables or disables the storage of timestamps. Reading this attribute returns the state of timestamp collection.

For dedicated reading buffers, all buffer attributes are saved to nonvolatile memory only when the reading buffer is saved to nonvolatile memory.

When on, timestamp values are stored with readings in the buffer. This requires four extra bytes of storage for each reading. Turning on additional collection items, such as timestamps (this attribute) and source values, decreases the capacity of a dedicated reading buffer (for example, `smua.nvbuffer1`), but does not change the capacity of a user-defined dynamically allocated buffer.

This value, off (0) or on (1), can only be changed when the buffer is empty. Empty the buffer using the `bufferVar.clear()` function.

Example

```
smua.nvbuffer1.collecttimestamps = 1
```

Include timestamps with readings for dedicated reading buffer 1.

Also see

- [bufferVar.clear\(\)](#) (on page 11-21)
- [Reading buffers](#) (on page 5-1)
- [smua.measure.overlappedY\(\)](#) (on page 11-205)
- [smua.measure.Y\(\)](#) (on page 11-209)
- [smua.nvbufferY](#) (on page 11-211)
- [smua.trigger.measure.Y\(\)](#) (on page 11-251)

bufferVar.fillcount

This attribute sets the reading buffer fill count.

Type	TSP-Link accessible	Affected by	Where saved	Default value
Attribute (RW)	Yes	Not applicable	See Details	0

Usage

```
fillCount = bufferVar.fillcount
bufferVar.fillcount = fillCount
```

<i>fillCount</i>	The reading buffer fill count
<i>bufferVar</i>	The reading buffer; can be a dynamically allocated buffer (user-defined), or a dedicated reading buffer (such as <code>smua.nvbuffer1</code>)

Details

The reading buffer fill count sets the number of readings to store before restarting at index 1. If the value is zero (0), then the capacity of the buffer is used. Use this attribute to control when the SMU restarts filling the buffer at index 1, rather than having it restart when the buffer is full.

If the `bufferVar.fillcount` attribute is set to a value higher than the capacity of the buffer, after storing the element at the end of the buffer, the SMU will overwrite the reading at index 1, the reading after that will overwrite the reading at index 2, and so on.

This attribute is only used when the `bufferVar.fillmode` attribute is set to `smua.FILL_WINDOW`.

For dedicated reading buffers, all buffer attributes are saved to nonvolatile memory only when the reading buffer is saved to nonvolatile memory.

Example

```
smua.nvbuffer1.fillcount = 50
```

Sets fill count of dedicated reading buffer 1 to 50.

Also see

[bufferVar.fillmode](#) (on page 11-25)

bufferVar.fillmode

This attribute sets the reading buffer fill mode.

Type	TSP-Link accessible	Affected by	Where saved	Default value
Attribute (RW)	Yes	Not applicable	See Details	0 (<code>smua.FILL_ONCE</code>)

Usage

```
fillMode = bufferVar.fillmode
bufferVar.fillmode = fillMode
```

<i>fillMode</i>	The reading buffer fill mode; set to one of the following: <ul style="list-style-type: none"> 0 or <code>smua.FILL_ONCE</code>: Do not overwrite old data 1 or <code>smua.FILL_WINDOW</code>: New readings restart at index 1 after acquiring reading at index <code>bufferVar.fillcount</code>
<i>bufferVar</i>	The reading buffer; can be a dynamically allocated buffer (user-defined), or a dedicated reading buffer (such as <code>smua.nvbuffer1</code>)

Details

When this attribute is set to `smua.FILL_ONCE`, the reading buffer will not overwrite readings. If the buffer fills up, new readings will be discarded.

When this attribute is set to `smua.FILL_WINDOW`, new readings will be added after existing data until the buffer holds `bufferVar.fillcount` elements. Continuing the sequence, the next reading will overwrite the reading at index 1, the reading after that will overwrite the reading at index 2, and so on.

For dedicated reading buffers, all buffer attributes are saved to nonvolatile memory only when the reading buffer is saved to nonvolatile memory.

Example

```
smua.nvbuffer1.fillmode = smua.FILL_ONCE
Sets fill mode of dedicated reading buffer 1 to fill once (do not overwrite old data).
```

Also see

[bufferVar.fillcount](#) (on page 11-25)

[Reading buffers](#) (on page 5-1)

bufferVar.measurefunctions

This attribute contains the measurement function that was used to acquire a reading stored in a specified reading buffer.

Type	TSP-Link accessible	Affected by	Where saved	Default value
Attribute (R)	Yes	Clearing the buffer	See Details	Not applicable

Usage

```
measurefunction = bufferVar.measurefunctions[N]
```

<i>measurefunction</i>	The measurement function used (Current, Voltage, Ohms, or Watts) to acquire reading number <i>N</i> in the specified buffer
<i>bufferVar</i>	The reading buffer; can be a dynamically allocated buffer (user-defined), or a dedicated reading buffer (such as <code>smua.nvbuffer1</code>)
<i>N</i>	The reading number (1 to <code>bufferVar.n</code>)

Details

The `measurefunctions` buffer recall attribute is like an array (a Lua table) of strings indicating the function measured for the reading.

For dedicated reading buffers, all buffer attributes are saved to nonvolatile memory only when the reading buffer is saved to nonvolatile memory.

Example 1

```
measurefunction = smua.nvbuffer1.measurefunctions[5]
Store the measure function used to make reading number 5.
```

Example 2

```
printbuffer(1, 5, smua.nvbuffer1.measurefunctions)
Print the measurement function that was used to measure the first five readings saved in dedicated reading buffer 1.
Example output:
Current, Current, Current, Current, Current
```

Also see

- [bufferVar.measureranges](#) (on page 11-27)
- [bufferVar.n](#) (on page 11-28)
- [bufferVar.readings](#) (on page 11-29)
- [bufferVar.sourcefunctions](#) (on page 11-30)
- [bufferVar.sourceoutputstates](#) (on page 11-31)
- [bufferVar.sourceranges](#) (on page 11-32)
- [bufferVar.sourcevalues](#) (on page 11-33)
- [bufferVar.statuses](#) (on page 11-34)
- [bufferVar.timestamps](#) (on page 11-37)
- [Reading buffers](#) (on page 5-1)

bufferVar.measureranges

This attribute contains the measurement range values that were used for readings stored in a specified buffer.

Type	TSP-Link accessible	Affected by	Where saved	Default value
Attribute (R)	Yes	Clearing the buffer	See Details	Not applicable

Usage

```
measurerange = bufferVar.measureranges[N]
```

<i>measurerange</i>	The measurement range used to acquire reading number <i>N</i> in the specified buffer
<i>bufferVar</i>	The reading buffer; can be a dynamically allocated buffer (user-defined), or a dedicated reading buffer (such as <code>smua.nvbuffer1</code>)
<i>N</i>	The reading number (1 to <code>bufferVar.n</code>)

Details

The `measurangeranges` buffer recall attribute is like an array (a Lua table) of full-scale range values for the measure range used when the measurement was made.

For dedicated reading buffers, all buffer attributes are saved to nonvolatile memory only when the reading buffer is saved to nonvolatile memory.

Example 1

```
measurangerange = smua.nvbuffer1.measurangeranges[1]
```

Store the measure range that was used to make reading number 1.

Example 2

```
printbuffer(1, 10, smua.nvbuffer1.measurangeranges)
```

Print the range values that were used for the first 10 readings saved in dedicated reading buffer 1.

Example output:

```
1.00000e-07, 1.00000e-07,
1.00000e-07, 1.00000e-07,
1.00000e-07, 1.00000e-07,
1.00000e-07, 1.00000e-07,
1.00000e-07, 1.00000e-07
```

Also see

[bufferVar.measurefunctions](#) (on page 11-26)
[bufferVar.n](#) (on page 11-28)
[bufferVar.readings](#) (on page 11-29)
[bufferVar.sourcefunctions](#) (on page 11-30)
[bufferVar.sourceoutputstates](#) (on page 11-31)
[bufferVar.sourceranges](#) (on page 11-32)
[bufferVar.sourcevalues](#) (on page 11-33)
[bufferVar.statuses](#) (on page 11-34)
[bufferVar.timestamps](#) (on page 11-37)
[Reading buffers](#) (on page 5-1)

bufferVar.n

This attribute contains the number of readings in the buffer.

Type	TSP-Link accessible	Affected by	Where saved	Default value
Attribute (R)	Yes	Clearing the buffer	See Details	Not applicable

Usage

```
numberOfReadings = bufferVar.n
```

<code>numberOfReadings</code>	The number of readings stored in the buffer
<code>bufferVar</code>	The reading buffer; can be a dynamically allocated user-defined buffer or a dedicated reading buffer

Details

This read-only attribute contains the number of readings presently stored in the buffer.

For dedicated reading buffers, all buffer attributes are saved to nonvolatile memory only when the reading buffer is saved to nonvolatile memory.

Example

```
numberOfReadings = smua.nvbuffer1.n
print(numberOfReadings)
```

Reads the number of readings stored in dedicated reading buffer 1 (source-measure unit (SMU) channel A).

Output:
1.25000+02

The above output indicates that there are 125 readings stored in the buffer.

Also see

- [bufferVar.measurefunctions](#) (on page 11-26)
- [bufferVar.measureranges](#) (on page 11-27)
- [bufferVar.readings](#) (on page 11-29)
- [bufferVar.sourcefunctions](#) (on page 11-30)
- [bufferVar.sourceoutputstates](#) (on page 11-31)
- [bufferVar.sourceranges](#) (on page 11-32)
- [bufferVar.sourcevalues](#) (on page 11-33)
- [bufferVar.statuses](#) (on page 11-34)
- [bufferVar.timestamps](#) (on page 11-37)
- [Reading buffers](#) (on page 5-1)
- [smua.measure.overlappedY\(\)](#) (on page 11-205)
- [smua.measure.Y\(\)](#) (on page 11-209)
- [smua.nvbufferY](#) (on page 11-211)
- [smua.trigger.measure.Y\(\)](#) (on page 11-251)

bufferVar.readings

This attribute contains the readings stored in a specified reading buffer.

Type	TSP-Link accessible	Affected by	Where saved	Default value
Attribute (R)	Yes	Clearing the buffer	See Details	Not applicable

Usage

```
reading = bufferVar.readings[N]
```

<i>reading</i>	The value of the reading in the specified reading buffer
<i>bufferVar</i>	The reading buffer; can be a dynamically allocated user-defined buffer or a dedicated reading buffer
<i>N</i>	The reading number <i>N</i> ; can be any value from 1 to the number of readings in the buffer; use the <i>bufferVar.n</i> command to determine the number of readings in the buffer

Details

The *bufferVar.readings* buffer recall attribute is like an array (a Lua table) of the readings stored in the reading buffer. This array holds the same data that is returned when the reading buffer is accessed directly; that is, *rb[2]* and *rb.readings[2]* access the same value.

For dedicated reading buffers, all buffer attributes are saved to nonvolatile memory only when the reading buffer is saved to nonvolatile memory.

Example

```
print(smua.nvbuffer1.readings[1])
```

Output the first reading saved in source-measure unit (SMU) channel A, dedicated reading buffer 1.

Output:
8.81658e-08

Also see

[bufferVar.measurefunctions](#) (on page 11-26)
[bufferVar.measureranges](#) (on page 11-27)
[bufferVar.n](#) (on page 11-28)
[bufferVar.sourcefunctions](#) (on page 11-30)
[bufferVar.sourceoutputstates](#) (on page 11-31)
[bufferVar.sourceranges](#) (on page 11-32)
[bufferVar.sourcevalues](#) (on page 11-33)
[bufferVar.statuses](#) (on page 11-34)
[bufferVar.timestamps](#) (on page 11-37)
[Reading buffers](#) (on page 5-1)

bufferVar.sourcefunctions

This attribute contains the source function that was being used when the readings were stored in a specified reading buffer.

Type	TSP-Link accessible	Affected by	Where saved	Default value
Attribute (R)	Yes	Clearing the buffer	See Details	Not applicable

Usage

```
sourcefunction = bufferVar.sourcefunctions[N]
```

<i>sourcefunction</i>	The source function used (Current or Voltage) to acquire reading number <i>N</i> in the specified buffer
<i>bufferVar</i>	The reading buffer; can be a dynamically allocated buffer (user-defined), or a dedicated reading buffer (such as <code>smua.nvbuffer1</code>)
<i>N</i>	The reading number (1 to <code>bufferVar.n</code>)

Details

The `bufferVar.sourcefunctions` buffer recall attribute is like an array (a Lua table) of strings indicating the source function at the time of the measurement.

For dedicated reading buffers, all buffer attributes are saved to nonvolatile memory only when the reading buffer is saved to nonvolatile memory.

Example 1

```
sourcefunction = smua.nvbuffer1.sourcefunctions[3]
print(sourcefunction)
```

Store the source function used to make reading number 3 and output the value.

Example 2

```
printbuffer(1, 10, smua.nvbuffer1.sourcefunctions)
```

Print the source function used for 10 readings stored in dedicated reading buffer 1.
 Example output:
 Voltage, Voltage, Voltage,
 Voltage, Voltage, Voltage,
 Voltage, Voltage, Voltage,
 Voltage

Also see

- [bufferVar.measurefunctions](#) (on page 11-26)
- [bufferVar.measureranges](#) (on page 11-27)
- [bufferVar.n](#) (on page 11-28)
- [bufferVar.readings](#) (on page 11-29)
- [bufferVar.sourceoutputstates](#) (on page 11-31)
- [bufferVar.sourceranges](#) (on page 11-32)
- [bufferVar.sourcevalues](#) (on page 11-33)
- [bufferVar.statUSES](#) (on page 11-34)
- [bufferVar.timestamps](#) (on page 11-37)
- [Reading buffers](#) (on page 5-1)

bufferVar.sourceoutputstates

This attribute indicates the state of the source output for readings that are stored in a specified buffer.

Type	TSP-Link accessible	Affected by	Where saved	Default value
Attribute (R)	Yes	Clearing the buffer	See Details	Not applicable

Usage

```
state = bufferVar.sourceoutputstates[N]
```

<i>state</i>	The output state (<i>Off</i> or <i>On</i>) when reading <i>N</i> of the specified buffer was acquired
<i>bufferVar</i>	The reading buffer; can be a dynamically allocated buffer (user-defined), or a dedicated reading buffer (such as <i>smua.nvbuffer1</i>)
<i>N</i>	The reading number (1 to <i>bufferVar.n</i>)

Details

The *bufferVar.sourceoutputstates* buffer recall attribute is similar to an array (a Lua table) of strings. This array indicates the state of the source output (*Off* or *On*) at the time of the measurement.

For dedicated reading buffers, all buffer attributes are saved to nonvolatile memory only when the reading buffer is saved to nonvolatile memory.

Example

```
printbuffer(1, 1, smua.nvbuffer1.sourceoutputstates)
```

Print the source output for the first reading stored in dedicated reading buffer 1.
Example output:
On

Also see

[bufferVar.measurefunctions](#) (on page 11-26)

[bufferVar.measureranges](#) (on page 11-27)

[bufferVar.n](#) (on page 11-28)

[bufferVar.readings](#) (on page 11-29)

[bufferVar.sourcefunctions](#) (on page 11-30)

[bufferVar.sourceranges](#) (on page 11-32)

[bufferVar.sourcevalues](#) (on page 11-33)

[bufferVar.statuses](#) (on page 11-34)

[bufferVar.timestamps](#) (on page 11-37)

[Reading buffers](#) (on page 5-1)

bufferVar.sourceranges

This attribute contains the source range that was used for readings stored in a specified reading buffer.

Type	TSP-Link accessible	Affected by	Where saved	Default value
Attribute (R)	Yes	Clearing the buffer	See Details	Not applicable

Usage

```
sourcerange = bufferVar.sourceranges[N]
```

<i>sourcerange</i>	The source range used to acquire reading number <i>N</i> in the specified buffer
<i>bufferVar</i>	The reading buffer; can be a dynamically allocated buffer (user-defined), or a dedicated reading buffer (such as <code>smua.nvbuffer1</code>)
<i>N</i>	The reading number (1 to <i>bufferVar.n</i>)

Details

The `bufferVar.sourceranges` buffer recall attribute is like an array (a Lua table) of full-scale range values for the source range used when the measurement was made.

For dedicated reading buffers, all buffer attributes are saved to nonvolatile memory only when the reading buffer is saved to nonvolatile memory.

Example 1

```
sourcerange = smua.nvbuffer1.sourceranges[1]
```

Store the source range that was used for the first reading stored in dedicated reading buffer 1.

Example 2

<pre>printbuffer(1, 6, smua.nvbuffer1.sourceranges)</pre>	<p>Print the source ranges that were used for the first 6 readings stored in source-measure unit (SMU) A, buffer 1.</p> <p>Example output:</p> <pre>1.00000e-04, 1.00000e-04, 1.00000e-04, 1.00000e-04, 1.00000e-04, 1.00000e-04</pre>
---	--

Also see

- [bufferVar.measurefunctions](#) (on page 11-26)
- [bufferVar.measureranges](#) (on page 11-27)
- [bufferVar.n](#) (on page 11-28)
- [bufferVar.readings](#) (on page 11-29)
- [bufferVar.sourcefunctions](#) (on page 11-30)
- [bufferVar.sourceoutputstates](#) (on page 11-31)
- [bufferVar.sourcevalues](#) (on page 11-33)
- [bufferVar.statuses](#) (on page 11-34)
- [bufferVar.timestamps](#) (on page 11-37)
- [Reading buffers](#) (on page 5-1)

bufferVar.sourcevalues

When enabled by the `bufferVar.collectsourcevalues` attribute, this attribute contains the source levels being output when readings in the reading buffer were acquired.

Type	TSP-Link accessible	Affected by	Where saved	Default value
Attribute (R)	Yes	Clearing the buffer	See Details	Not applicable

Usage

```
sourcevalue = bufferVar.sourcevalues[N]
```

<code>sourcevalue</code>	The output value of the source when reading <i>N</i> of the specified buffer was acquired
<code>bufferVar</code>	The reading buffer; can be a dynamically allocated buffer (user-defined), or a dedicated reading buffer (such as <code>smua.nvbuffer1</code>)
<i>N</i>	The reading number (1 to <code>bufferVar.n</code>)

Details

If the `bufferVar.collectsourcevalues` attribute is enabled before readings are taken, the `bufferVar.sourcevalues` buffer recall attribute is like an array (a Lua table) of the sourced value in effect at the time of the reading. Note that you can set the `bufferVar.collectsourcevalues` attribute only if the affected reading buffer is empty. See [bufferVar.collectsourcevalues](#) (on page 11-23) for more detailed information.

For dedicated reading buffers, all buffer attributes are saved to nonvolatile memory only when the reading buffer is saved to nonvolatile memory.

Example 1

```
sourcevalue = smua.nvbuffer1.sourcevalues[1]
```

Get the sourced value of the first reading stored in dedicated reading buffer 1.

Example 2

```
printbuffer(1, 6, smua.nvbuffer1.sourcevalues)
```

Print the sourced value of the first 6 readings stored in source-measure unit (SMU) A, buffer 1.

Example output:

```
1.00000e-04, 1.00000e-04,
1.00000e-04, 1.00000e-04,
1.00000e-04, 1.00000e-04
```

Also see

[bufferVar.measurefunctions](#) (on page 11-26)

[bufferVar.measureranges](#) (on page 11-27)

[bufferVar.n](#) (on page 11-28)

[bufferVar.readings](#) (on page 11-29)

[bufferVar.sourcefunctions](#) (on page 11-30)

[bufferVar.sourceoutputstates](#) (on page 11-31)

[bufferVar.sourceranges](#) (on page 11-32)

[bufferVar.statuses](#) (on page 11-34)

[bufferVar.timestamps](#) (on page 11-37)

[Reading buffers](#) (on page 5-1)

bufferVar.statuses

This attribute contains the status values of readings in the reading buffer.

Type	TSP-Link accessible	Affected by	Where saved	Default value
Attribute (R)	Yes	Clearing the buffer	See Details	Not applicable

Usage

```
statusInformation = bufferVar.statuses[N]
```

<i>statusInformation</i>	The status value when reading <i>N</i> of the specified buffer was acquired
<i>bufferVar</i>	The reading buffer; can be a dynamically allocated user-defined buffer or a dedicated reading buffer
<i>N</i>	The reading number <i>N</i> ; can be any value from 1 to the number of readings in the buffer; use the <i>bufferVar.n</i> command to determine the number of readings in the buffer

Details

This read-only buffer recall attribute is like an array (a Lua table) of the status values for all the readings in the buffer. The status values are floating-point numbers that encode the status value; see the following table for values.

For dedicated reading buffers, all buffer attributes are saved to nonvolatile memory only when the reading buffer is saved to nonvolatile memory.

Buffer status bits			
Bit	Name	Hex	Description when bit is true
B0	Pulser	0x01	Pulser is enabled
B1	Overtemp	0x02	Overtemperature condition
B2	AutoRangeMeas	0x04	Measure range was autoranged
B3	AutoRangeSrc	0x08	Source range was autoranged
B4	4Wire	0x10	4-wire (remote) sense mode enabled
B5	Rel	0x20	Relative offset applied to reading
B6	Compliance	0x40	Source function was limited because the complementary function would be over the compliance limit
B7	Filtered	0x80	Reading was filtered

Example

```

reset ()
smua.source.func = smua.OUTPUT_DCVOLTS
smua.source.autorangev = smua.AUTORANGE_ON
smua.source.levelv = 5
smua.source.limiti = 10e-3
smua.measure.rangei = 10e-3
smua.source.output = smua.OUTPUT_ON
print(smua.measure.i(smua.nvbuffer1))
smua.source.output = smua.OUTPUT_OFF
print(smua.nvbuffer1.statuses[1])

```

Reset the instrument.
Set the voltage source function to DC volts.
Set the range to auto.
Set the voltage source to 5 V.
Set current measure limit to 10 mA.
Set the current measure range to 10 mA.
Turn on the output.
Print and place the current reading in the reading buffer.
Turn off the output.
Output status value of the first measurement in the reading buffer.
Output example:
3.99470e-06
4.00000e+00

Also see

[bufferVar.measurefunctions](#) (on page 11-26)
[bufferVar.measureranges](#) (on page 11-27)
[bufferVar.n](#) (on page 11-28)
[bufferVar.readings](#) (on page 11-29)
[bufferVar.sourcefunctions](#) (on page 11-30)
[bufferVar.sourceoutputstates](#) (on page 11-31)
[bufferVar.sourceranges](#) (on page 11-32)
[bufferVar.sourcevalues](#) (on page 11-33)
[bufferVar.timestamps](#) (on page 11-37)
[Reading buffers](#) (on page 5-1)

bufferVar.timestampresolution

This attribute contains the resolution of the timestamp.

Type	TSP-Link accessible	Affected by	Where saved	Default value
Attribute (RW)	Yes	Not applicable	See Details	1e-6 (1 μ s)

Usage

```
resolution = bufferVar.timestampresolution
```

<i>resolution</i>	Timestamp resolution in seconds (minimum 1 μ s)
<i>bufferVar</i>	The reading buffer; can be a dynamically allocated user-defined buffer or a dedicated reading buffer

Details

Assigning a value to this attribute sets the resolution for the timestamps. Reading this attribute returns the timestamp resolution value. This value can only be changed with an empty buffer. Empty the buffer using the `bufferVar.clear()` function.

The finest timestamp resolution is 0.000001 seconds (1 μ s). At this resolution, the reading buffer can store unique timestamps for up to 71 minutes. This value can be increased for very long tests.

The value specified when setting this attribute will be rounded to an even power of 2 μ s.

For dedicated reading buffers, all buffer attributes are saved to nonvolatile memory only when the reading buffer is saved to nonvolatile memory.

Example

```
smua.nvbuffer1.timestampresolution = 0.000008
```

Sets the timestamp resolution of dedicated reading buffer 1 to 8 μ s.

Also see

- [bufferVar.clear\(\)](#) (on page 11-21)
- [bufferVar.collecttimestamps](#) (on page 11-24)
- [bufferVar.timestamps](#) (on page 11-37)
- [Reading buffers](#) (on page 5-1)
- [smua.measure.overlappedY\(\)](#) (on page 11-205)
- [smua.measure.Y\(\)](#) (on page 11-209)
- [smua.nvbufferY](#) (on page 11-211)
- [smua.trigger.measure.Y\(\)](#) (on page 11-251)

bufferVar.timestamps

When enabled by the `bufferVar.collecttimestamps` attribute, this attribute contains the timestamp when each reading saved in the specified reading buffer occurred.

Type	TSP-Link accessible	Affected by	Where saved	Default value
Attribute (R)	Yes	Clearing the buffer	See Details	Not applicable

Usage

```
timestamp = bufferVar.timestamps[N]
```

<code>timestamp</code>	The complete timestamp (including date, time, and fractional seconds) of reading number <code>N</code> in the specified reading buffer when the reading was acquired
<code>bufferVar</code>	The reading buffer; can be a dynamically allocated user-defined buffer or a dedicated reading buffer
<code>N</code>	The reading number (1 to <code>bufferVar.n</code>)

Details

The `bufferVar.timestamps` information from a reading buffer is only available if the `bufferVar.collecttimestamps` attribute is set to 1 (default setting). If it is set to 0, you cannot access any time information from a reading buffer.

If enabled, this buffer recall attribute is like an array (a Lua table) that contains timestamps, in seconds, of when each reading occurred. These are relative to the `bufferVar.basetimestamp` for the buffer.

For dedicated reading buffers, all buffer attributes are saved to nonvolatile memory only when the reading buffer is saved to nonvolatile memory.

Example

```
timestamp = smua.nvbuffer1.timestamps[1]
```

Get the timestamp of the first reading stored in source-measure unit (SMU) A, buffer 1.

Also see

- [bufferVar.clear\(\)](#) (on page 11-21)
- [bufferVar.collecttimestamps](#) (on page 11-24)
- [bufferVar.measurefunctions](#) (on page 11-26)
- [bufferVar.measureranges](#) (on page 11-27)
- [bufferVar.n](#) (on page 11-28)
- [bufferVar.readings](#) (on page 11-29)
- [bufferVar.sourcefunctions](#) (on page 11-30)
- [bufferVar.sourceoutputstates](#) (on page 11-31)
- [bufferVar.sourceranges](#) (on page 11-32)
- [bufferVar.sourcevalues](#) (on page 11-33)
- [bufferVar.statuses](#) (on page 11-34)
- [Reading buffers](#) (on page 5-1)

dataqueue.add()

This function adds an entry to the data queue.

Type	TSP-Link accessible	Affected by	Where saved	Default value
Function	Yes			

Usage

```
result = dataqueue.add(value)
result = dataqueue.add(value, timeout)
```

<i>result</i>	The resulting value of <code>true</code> or <code>false</code> based on the success of the function
<i>value</i>	The data item to add; <i>value</i> can be of any type
<i>timeout</i>	The maximum number of seconds to wait for space in the data queue

Details

You cannot use the *timeout* value when accessing the data queue from a remote node (you can only use the *timeout* value while adding data to the local data queue).

The *timeout* value is ignored if the data queue is not full.

The `dataqueue.add()` function returns `false`:

- If the timeout expires before space is available in the data queue
- If the data queue is full and a *timeout* value is not specified

If the value is a table, a duplicate of the table and any subtables is made. The duplicate table does not contain any references to the original table or to any subtables.

Example

<pre>dataqueue.clear() dataqueue.add(10) dataqueue.add(11, 2) result = dataqueue.add(12, 3) if result == false then print("Failed to add 12 to the dataqueue") end print("The dataqueue contains:") while dataqueue.count > 0 do print(dataqueue.next()) end</pre>	<p>Clear the data queue. Each line adds one item to the data queue. Output: The dataqueue contains: 10 11 12</p>
---	--

Also see

- [dataqueue.CAPACITY](#) (on page 11-39)
- [dataqueue.clear\(\)](#) (on page 11-39)
- [dataqueue.count](#) (on page 11-40)
- [dataqueue.next\(\)](#) (on page 11-41)
- [Using the data queue for real-time communication](#) (on page 10-56)

dataqueue.CAPACITY

This constant is the maximum number of entries that you can store in the data queue.

Type	TSP-Link accessible	Affected by	Where saved	Default value
Constant	Yes			

Usage

```
count = dataqueue.CAPACITY
```

`count`

The variable that is assigned the value of `dataqueue.CAPACITY`

Details

This constant always returns the maximum number of entries that can be stored in the data queue.

Example

```
MaxCount = dataqueue.CAPACITY
while dataqueue.count < MaxCount do
  dataqueue.add(1)
end
print("There are " .. dataqueue.count
  .. " items in the data queue")
```

This example fills the data queue until it is full and prints the number of items in the queue.
Output:
There are 128 items in the data queue

Also see

- [dataqueue.add\(\)](#) (on page 11-38)
- [dataqueue.clear\(\)](#) (on page 11-39)
- [dataqueue.count](#) (on page 11-40)
- [dataqueue.next\(\)](#) (on page 11-41)
- [Using the data queue for real-time communication](#) (on page 10-56)

dataqueue.clear()

This function clears the data queue.

Type	TSP-Link accessible	Affected by	Where saved	Default value
Function	Yes			

Usage

```
dataqueue.clear()
```

Details

This function forces all `dataqueue.add()` commands that are in progress to time out and deletes all data from the data queue.

Example

```
MaxCount = dataqueue.CAPACITY
while dataqueue.count < MaxCount do
  dataqueue.add(1)
end
print("There are " .. dataqueue.count
  .. " items in the data queue")
dataqueue.clear()
print("There are " .. dataqueue.count
  .. " items in the data queue")
```

This example fills the data queue and prints the number of items in the queue. It then clears the queue and prints the number of items again.

Output:

```
There are 128 items in the data
  queue
There are 0 items in the data queue
```

Also see

[dataqueue.add\(\)](#) (on page 11-38)

[dataqueue.CAPACITY](#) (on page 11-39)

[dataqueue.count](#) (on page 11-40)

[dataqueue.next\(\)](#) (on page 11-41)

[Using the data queue for real-time communication](#) (on page 10-56)

dataqueue.count

This attribute contains the number of items in the data queue.

Type	TSP-Link accessible	Affected by	Where saved	Default value
Attribute (R)	Yes	Not applicable	Not applicable	Not applicable

Usage

```
count = dataqueue.count
```

<i>count</i>	The number of items in the data queue
--------------	---------------------------------------

Details

The count is updated as entries are added with `dataqueue.add()` and read from the data queue with `dataqueue.next()`. It is also updated when the data queue is cleared with `dataqueue.clear()`.

A maximum of `dataqueue.CAPACITY` items can be stored at any one time in the data queue.

Example

```
MaxCount = dataqueue.CAPACITY
while dataqueue.count < MaxCount do
  dataqueue.add(1)
end
print("There are " .. dataqueue.count
  .. " items in the data queue")
dataqueue.clear()
print("There are " .. dataqueue.count
  .. " items in the data queue")
```

This example fills the data queue and prints the number of items in the queue. It then clears the queue and prints the number of items again.

Output:

```
There are 128 items in the data queue
There are 0 items in the data queue
```

Also see

- [dataqueue.add\(\)](#) (on page 11-38)
- [dataqueue.CAPACITY](#) (on page 11-39)
- [dataqueue.clear\(\)](#) (on page 11-39)
- [dataqueue.next\(\)](#) (on page 11-41)
- [Using the data queue for real-time communication](#) (on page 10-56)

dataqueue.next()

This function removes the next entry from the data queue.

Type	TSP-Link accessible	Affected by	Where saved	Default value
Function	Yes			

Usage

```
value = dataqueue.next()
value = dataqueue.next(timeout)
```

<i>value</i>	The next entry in the data queue
<i>timeout</i>	The number of seconds to wait for data in the queue

Details

If the data queue is empty, the function waits up to the *timeout* value.

If data is not available in the data queue before the *timeout* expires, the return value is `nil`.

The entries in the data queue are removed in first-in, first-out (FIFO) order.

If the value is a table, a duplicate of the original table and any subtables is made. The duplicate table does not contain any references to the original table or to any subtables.

Example

<pre>dataqueue.clear() for i = 1, 10 do dataqueue.add(i) end print("There are " .. dataqueue.count .. " items in the data queue") while dataqueue.count > 0 do x = dataqueue.next() print(x) end print("There are " .. dataqueue.count .. " items in the data queue")</pre>	<p>Clears the data queue, adds ten entries, then reads the entries from the data queue. Note that your output may differ depending on the setting of <code>format.asciiprecision</code>.</p> <p>Output:</p> <pre>There are 10 items in the data queue 1 2 3 4 5 6 7 8 9 10 There are 0 items in the data queue</pre>
---	---

Also see

[dataqueue.add\(\)](#) (on page 11-38)
[dataqueue.CAPACITY](#) (on page 11-39)
[dataqueue.clear\(\)](#) (on page 11-39)
[dataqueue.count](#) (on page 11-40)
[format.asciiprecision](#) (on page 11-89)
[Using the data queue for real-time communication](#) (on page 10-56)

delay()

This function delays the execution of the commands that follow it.

Type	TSP-Link accessible	Affected by	Where saved	Default value
Function	No			

Usage

`delay(seconds)`

<code>seconds</code>	The number of seconds to delay (0 to 100 ks)
----------------------	--

Details

The instrument delays execution of the commands for at least the specified number of seconds and fractional seconds. However, the processing time may cause the instrument to delay 5 μ s to 10 μ s (typical) more than the requested delay.

Example

<pre>beeper.beep(0.5, 2400) delay(0.250) beeper.beep(0.5, 2400)</pre>	Emit a double-beep at 2400 Hz. The sequence is 0.5 s on, 0.25 s off, 0.5 s on.
---	--

Also see

None

digio.readbit()

This function reads one digital I/O line.

Type	TSP-Link accessible	Affected by	Where saved	Default value
Function	Yes			

Usage

`data = digio.readbit(N)`

<code>data</code>	The state of the I/O line
<code>N</code>	Digital I/O line number to be read (1 to 14)

Details

A returned value of zero (0) indicates that the line is low. A returned value of one (1) indicates that the line is high.

Example

<pre>print(digio.readbit(4))</pre>	Assume line 4 is set high, and it is then read. Output: 1.00000e+00
------------------------------------	---

Also see

- [digio.readport\(\)](#) (on page 11-43)
- [digio.writebit\(\)](#) (on page 11-52)
- [digio.writeport\(\)](#) (on page 11-52)
- [Digital I/O port](#) (on page 6-36)

digio.readport()

This function reads the digital I/O port.

Type	TSP-Link accessible	Affected by	Where saved	Default value
Function	Yes			

Usage

```
data = digio.readport()
```

<i>data</i>	The present value of the input lines on the digital I/O port
-------------	--

Details

The binary equivalent of the returned value indicates the value of the input lines on the I/O port. The least significant bit (bit B1) of the binary number corresponds to line 1; bit B14 corresponds to line 14. For example, a returned value of 170 has a binary equivalent of 000000010101010, which indicates that lines 2, 4, 6, and 8 are high (1), and the other 10 lines are low (0).

Example

<pre>data = digio.readport() print(data)</pre>	Assume lines 2, 4, 6, and 8 are set high when the I/O port is read. Output: 1.70000e+02 This is binary 10101010
--	--

Also see

- [digio.readbit\(\)](#) (on page 11-42)
- [digio.writebit\(\)](#) (on page 11-52)
- [digio.writeport\(\)](#) (on page 11-52)
- [Digital I/O port](#) (on page 6-36)

digio.trigger[N].assert()

This function asserts a trigger pulse on one of the digital I/O lines.

Type	TSP-Link accessible	Affected by	Where saved	Default value
Function	Yes			

Usage

```
digio.trigger[N].assert()
```

<i>N</i>	Digital I/O trigger line (1 to 14)
----------	------------------------------------

Details

The pulse width that is set determines how long the instrument asserts the trigger.

Example

<code>digio.trigger[2].assert()</code>	Asserts a trigger on digital I/O line 2.
--	--

Also see

[digio.trigger\[N\].pulsewidth](#) (on page 11-47)

digio.trigger[N].clear()

This function clears the trigger event on a digital I/O line.

Type	TSP-Link accessible	Affected by	Where saved	Default value
Function	Yes			

Usage

```
digio.trigger[N].clear()
```

<i>N</i>	Digital I/O trigger line (1 to 14)
----------	------------------------------------

Details

The event detector of a trigger enters the detected state when an event is detected. It is cleared when `digio.trigger[N].wait()` or `digio.trigger[N].clear()` is called.

`digio.trigger[N].clear()` clears the event detector of the specified trigger line, discards the history of the trigger line, and clears the `digio.trigger[N].overrun` attribute.

Example

<code>digio.trigger[2].clear()</code>	Clears the trigger event detector on I/O line 2.
---------------------------------------	--

Also see

[digio.trigger\[N\].overrun](#) (on page 11-47)

[digio.trigger\[N\].wait\(\)](#) (on page 11-51)

digio.trigger[N].EVENT_ID

This constant identifies the trigger event generated by the digital I/O line *N*.

Type	TSP-Link accessible	Affected by	Where saved	Default value
Constant	Yes			

Usage

```
eventID = digio.trigger[N].EVENT_ID
```

<i>eventID</i>	The trigger event number
<i>N</i>	Digital I/O trigger line (1 to 14)

Details

To have another trigger object respond to trigger events generated by the trigger line, set the stimulus attribute of the other object to the value of this constant.

Example

```
digio.trigger[5].stimulus = digio.trigger[3].EVENT_ID
```

Uses a trigger event on digital I/O trigger line 3 to be the stimulus for digital I/O trigger line 5.

Also see

None

digio.trigger[N].mode

This attribute sets the mode in which the trigger event detector and the output trigger generator operate on the given trigger line.

Type	TSP-Link accessible	Affected by	Where saved	Default value
Attribute (RW)	Yes	Instrument reset Digital I/O trigger <i>N</i> reset Recall setup	Not saved	0 (digio.TRIG_BYPASS)

Usage

```
triggerMode = digio.trigger[N].mode
digio.trigger[N].mode = triggerMode
```

<i>triggerMode</i>	The trigger mode; see Details for values
<i>N</i>	Digital I/O trigger line (1 to 14)

Details

Set `triggerMode` to one of the following values:

Trigger mode values

<code>triggerMode</code>	Description
<code>digio.TRIG_BYPASS</code> or 0	Allows direct control of the line.
<code>digio.TRIG_FALLING</code> or 1	Detects falling-edge triggers as input; asserts a TTL-low pulse for output.
<code>digio.TRIG_RISING</code> or 2	If the programmed state of the line is high, the <code>digio.TRIG_RISING</code> mode behavior is similar to <code>digio.TRIG_RISINGA</code> . If the programmed state of the line is low, the <code>digio.TRIG_RISING</code> mode behavior is similar to <code>digio.TRIG_RISINGM</code> . This setting should only be used if necessary for compatibility with other Keithley Instruments products.
<code>digio.TRIG_EITHER</code> or 3	Detects rising- or falling-edge triggers as input. Asserts a TTL-low pulse for output.
<code>digio.TRIG_SYNCHRONOUSA</code> or 4	Detects the falling-edge input triggers and automatically latches and drives the trigger line low. Asserting the output trigger releases the latched line.
<code>digio.TRIG_SYNCHRONOUS</code> or 5	Detects the falling-edge input triggers and automatically latches and drives the trigger line low. Asserts a TTL-low pulse as an output trigger.
<code>digio.TRIG_SYNCHRONOUM</code> or 6	Detects rising-edge triggers as input. Asserts a TTL-low pulse for output.
<code>digio.TRIG_RISINGA</code> or 7	Detects rising-edge triggers as input. Asserts a TTL-low pulse for output.
<code>digio.TRIG_RISINGM</code> or 8	Asserts a TTL-high pulse for output. Input edge detection is not possible in this mode.

When programmed to any mode except `digio.TRIG_BYPASS`, the output state of the I/O line is controlled by the trigger logic, and the user-specified output state of the line is ignored.

Use of either `digio.TRIG_SYNCHRONOUSA` or `digio.TRIG_SYNCHRONOUM` is preferred over `digio.TRIG_SYNCHRONOUS`, because `digio.TRIG_SYNCHRONOUS` is provided for compatibility with the digital I/O and TSP-Link triggering on older firmware.

To control the line state, set the mode to `digio.TRIG_BYPASS` and use the `digio.writebit()` and `digio.writeport()` commands.

Example

<code>digio.trigger[4].mode = 2</code>	Sets the trigger mode for I/O line 4 to <code>digio.TRIG_RISING</code> .
--	--

Also see

[digio.trigger\[N\].clear\(\)](#) (on page 11-44)

[digio.trigger\[N\].reset\(\)](#) (on page 11-49)

[digio.writebit\(\)](#) (on page 11-52)

[digio.writeport\(\)](#) (on page 11-52)

[Sweep operation](#) (on page 4-61)

digio.trigger[N].overrun

This attribute returns the event detector overrun status.

Type	TSP-Link accessible	Affected by	Where saved	Default value
Attribute (R)	Yes	Instrument reset Digital I/O trigger <i>N</i> clear Digital I/O trigger <i>N</i> reset Recall setup	Not saved	Not applicable

Usage

```
overrun = digio.trigger[N].overrun
```

<i>overrun</i>	Trigger overrun state (true or false)
<i>N</i>	Digital I/O trigger line (1 to 14)

Details

If this is `true`, an event was ignored because the event detector was already in the detected state when the event occurred.

This is an indication of the state of the event detector built into the line itself. It does not indicate if an overrun occurred in any other part of the trigger model or in any other detector that is monitoring the event.

Example

```
overrun = digio.trigger[1].overrun
print(overrun)
```

If there is no trigger overrun, the following text is output:
`false`

Also see

[digio.trigger\[N\].clear\(\)](#) (on page 11-44)

[digio.trigger\[N\].reset\(\)](#) (on page 11-49)

digio.trigger[N].pulsewidth

This attribute describes the length of time that the trigger line is asserted for output triggers.

Type	TSP-Link accessible	Affected by	Where saved	Default value
Attribute (RW)	Yes	Instrument reset Digital I/O trigger <i>N</i> reset Recall setup	Not saved	10e-6 (10 μ s)

Usage

```
width = digio.trigger[N].pulsewidth
digio.trigger[N].pulsewidth = width
```

<i>width</i>	The pulse width (seconds)
<i>N</i>	Digital I/O trigger line (1 to 14)

Details

Setting the pulse width to zero (0) seconds asserts the trigger indefinitely. To release the trigger line, use `digio.trigger[N].release()`.

Example

<code>digio.trigger[4].pulsewidth = 20e-6</code>	Sets the pulse width for trigger line 4 to 20 μ s.
--	--

Also see

[digio.trigger\[N\].assert\(\)](#) (on page 11-44)

[digio.trigger\[N\].release\(\)](#) (on page 11-48)

[digio.trigger\[N\].reset\(\)](#) (on page 11-49)

digio.trigger[N].release()

This function releases an indefinite length or latched trigger.

Type	TSP-Link accessible	Affected by	Where saved	Default value
Function	Yes			

Usage

```
digio.trigger[N].release()
```

<i>N</i>	Digital I/O trigger line (1 to 14)
----------	------------------------------------

Details

Releases a trigger that was asserted with an indefinite pulsewidth time. It also releases a trigger that was latched in response to receiving a synchronous mode trigger. Only the specified trigger line is affected.

Example

<code>digio.trigger[4].release()</code>	Releases digital I/O trigger line 4.
---	--------------------------------------

Also see

[digio.trigger\[N\].assert\(\)](#) (on page 11-44)

[digio.trigger\[N\].pulsewidth](#) (on page 11-47)

digio.trigger[N].reset()

This function resets trigger values to their factory defaults.

Type	TSP-Link accessible	Affected by	Where saved	Default value
Function	Yes			

Usage

```
digio.trigger[N].reset()
```

<i>N</i>	Digital I/O trigger line (1 to 14)
----------	------------------------------------

Details

This function resets the following attributes to factory default settings:

- `digio.trigger[N].mode`
- `digio.trigger[N].pulsewidth`
- `digio.trigger[N].stimulus`

It also clears `digio.trigger[N].overrun`.

Example

```
digio.trigger[3].mode = 2
digio.trigger[3].pulsewidth = 50e-6
digio.trigger[3].stimulus = digio.trigger[5].EVENT_ID
print(digio.trigger[3].mode, digio.trigger[3].pulsewidth,
      digio.trigger[3].stimulus)
digio.trigger[3].reset()
print(digio.trigger[3].mode, digio.trigger[3].pulsewidth,
      digio.trigger[3].stimulus)
```

Set the digital I/O trigger line 3 for a falling edge with a pulsewidth of 50 μ s.
Use digital I/O line 5 to trigger the event on line 3.
Reset the line back to factory default values.

Output before reset:

```
2.00000e+00      5.00000e-05      5.00000e+00
```

Output after reset:

```
0.00000e+00      1.00000e-05      0.00000e+00
```

Also see

[digio.trigger\[N\].mode](#) (on page 11-45)

[digio.trigger\[N\].overrun](#) (on page 11-47)

[digio.trigger\[N\].pulsewidth](#) (on page 11-47)

[digio.trigger\[N\].stimulus](#) (on page 11-50)

digio.trigger[N].stimulus

This attribute selects the event that causes a trigger to be asserted on the digital output line.

Type	TSP-Link accessible	Affected by	Where saved	Default value
Attribute (RW)	Yes	Instrument reset Digital I/O trigger N reset Recall setup	Not saved	0

Usage

```
triggerStimulus = digio.trigger[N].stimulus
digio.trigger[N].stimulus = triggerStimulus
```

<i>triggerStimulus</i>	The event identifier for the triggering event
<i>N</i>	Digital I/O trigger line (1 to 14)

Details

Set this attribute to zero (0) to disable the automatic trigger output.

Do not use this attribute to generate output triggers under script control. Use

`digio.trigger[N].assert()` instead.

The trigger stimulus for a digital I/O line may be set to one of the existing trigger event IDs described in the following table.

Trigger event IDs*	
Event ID	Event description
<code>smua.trigger.SWEEPING_EVENT_ID</code>	Occurs when the source-measure unit (SMU) transitions from the idle state to the arm layer of the trigger model
<code>smua.trigger.ARMED_EVENT_ID</code>	Occurs when the SMU moves from the arm layer to the trigger layer of the trigger model
<code>smua.trigger.SOURCE_COMPLETE_EVENT_ID</code>	Occurs when the SMU completes a source action
<code>smua.trigger.MEASURE_COMPLETE_EVENT_ID</code>	Occurs when the SMU completes a measurement action
<code>smua.trigger.PULSE_COMPLETE_EVENT_ID</code>	Occurs when the SMU completes a pulse
<code>smua.trigger.SWEEP_COMPLETE_EVENT_ID</code>	Occurs when the SMU completes a sweep
<code>smua.trigger.IDLE_EVENT_ID</code>	Occurs when the SMU returns to the idle state
<code>digio.trigger[N].EVENT_ID</code>	Occurs when an edge is detected on a digital I/O line
<code>tsplink.trigger[N].EVENT_ID</code>	Occurs when an edge is detected on a TSP-Link line
<code>lan.trigger[N].EVENT_ID</code>	Occurs when the appropriate LXI trigger packet is received on LAN trigger object <i>N</i>
<code>display.trigger.EVENT_ID</code>	Occurs when the TRIG key on the front panel is pressed
<code>trigger.EVENT_ID</code>	Occurs when a *TRG command is received on the remote interface GPIB only: Occurs when a GET bus command is received USB only: Occurs when a USBTMC TRIGGER message is received VXI-11 only: Occurs with the VXI-11 command <code>device_trigger</code> ; reference the VXI-11 standard for additional details on the device trigger operation
<code>trigger.blender[N].EVENT_ID</code>	Occurs after a collection of events is detected
<code>trigger.timer[N].EVENT_ID</code>	Occurs when a delay expires
<code>trigger.generator[N].EVENT_ID</code>	Occurs when the <code>trigger.generator[N].assert()</code> function is executed

* Use the name of the trigger event ID to set the stimulus value rather than the numeric value. Using the name makes the code compatible for future upgrades (for example, if the numeric values change if enhancements are added to instrument).

Example 1

```
digio.trigger[3].stimulus = 0
Clear the trigger stimulus of digital I/O line 3.
```

Example 2

```
digio.trigger[3].stimulus = smua.trigger.SOURCE_COMPLETE_EVENT_ID
Set the trigger stimulus of digital I/O line 3 to be the source complete event.
```

Also see

- [digio.trigger\[N\].assert\(\)](#) (on page 11-44)
- [digio.trigger\[N\].clear\(\)](#) (on page 11-44)
- [digio.trigger\[N\].reset\(\)](#) (on page 11-49)

digio.trigger[N].wait()

This function waits for a trigger.

Type	TSP-Link accessible	Affected by	Where saved	Default value
Function	Yes			

Usage

```
triggered = digio.trigger[N].wait(timeout)
```

<i>triggered</i>	The value is <code>true</code> if a trigger is detected, or <code>false</code> if no triggers are detected during the timeout period
<i>N</i>	Digital I/O trigger line (1 to 14)
<i>timeout</i>	Timeout in seconds

Details

This function pauses for up to *timeout* seconds for an input trigger. If one or more trigger events are detected since the last time `digio.trigger[N].wait()` or `digio.trigger[N].clear()` was called, this function returns a value immediately. After waiting for a trigger with this function, the event detector is automatically reset and ready to detect the next trigger. This is true regardless of the number of events detected.

Example

```
triggered = digio.trigger[4].wait(3)
print(triggered)
```

Waits up to three seconds for a trigger to be detected on trigger line 4, then outputs the results.
 Output if no trigger is detected:
 false
 Output if a trigger is detected:
 true

Also see

- [digio.trigger\[N\].clear\(\)](#) (on page 11-44)

digio.writebit()

This function sets a digital I/O line high or low.

Type	TSP-Link accessible	Affected by	Where saved	Default value
Function	Yes			

Usage

```
digio.writebit(N, data)
```

<i>N</i>	Digital I/O trigger line (1 to 14)
<i>data</i>	The value to write to the bit: <ul style="list-style-type: none"> ▪ 0 (low) ▪ Non-zero (high)

Details

If the output line is write-protected using the `digio.writeprotect` attribute, the command is ignored.

The `reset()` function does not affect the present state of the digital I/O lines.

Use the `digio.writebit()` and `digio.writeport()` commands to control the output state of the synchronization line when trigger operation is set to `digio.TRIG_BYPASS`.

The data must be zero (0) to clear the bit. Any value other than zero (0) sets the bit.

Example

```
digio.writebit(4, 0)      Sets digital I/O line 4 low (0).
```

Also see

[digio.readbit\(\)](#) (on page 11-42)
[digio.readport\(\)](#) (on page 11-43)
[digio.trigger\[N\].mode](#) (on page 11-45)
[digio.writeport\(\)](#) (on page 11-52)
[digio.writeprotect](#) (on page 11-53)

digio.writeport()

This function writes to all digital I/O lines.

Type	TSP-Link accessible	Affected by	Where saved	Default value
Function	Yes			

Usage

```
digio.writeport(data)
```

<i>data</i>	Value to write to the port (0 to 16383)
-------------	---

Details

The binary representation of *data* indicates the output pattern to be written to the I/O port. For example, a *data* value of 170 has a binary equivalent of 00000010101010. Lines 2, 4, 6, and 8 are set high (1), and the other 10 lines are set low (0).

Write-protected lines are not changed.

The `reset()` function does not affect the present states of the digital I/O lines.

Use the `digio.writebit()` and `digio.writeport()` commands to control the output state of the synchronization line when trigger operation is set to `digio.TRIG_BYPASS`.

Example

<code>digio.writeport(255)</code>	Sets digital I/O Lines 1 through 8 high (binary 00000011111111).
-----------------------------------	--

Also see

- [digio.readbit\(\)](#) (on page 11-42)
- [digio.readport\(\)](#) (on page 11-43)
- [digio.writebit\(\)](#) (on page 11-52)
- [digio.writeprotect](#) (on page 11-53)

digio.writeprotect

This attribute contains the write-protect mask that protects bits from changes from the `digio.writebit()` and `digio.writeport()` functions.

Type	TSP-Link accessible	Affected by	Where saved	Default value
Attribute (RW)	Yes	Instrument reset Recall setup	Saved setup	0

Usage

```
mask = digio.writeprotect
digio.writeprotect = mask
```

<code>mask</code>	Sets the value that specifies the bit pattern for write-protect
-------------------	---

Details

Bits that are set to one cause the corresponding line to be write-protected.

The binary equivalent of *mask* indicates the mask to be set for the I/O port. For example, a mask value of 7 has a binary equivalent of 00000000000111. This mask write-protects lines 1, 2, and 3.

Example

<code>digio.writeprotect = 15</code>	Write-protects lines 1, 2, 3, and 4.
--------------------------------------	--------------------------------------

Also see

- [digio.writebit\(\)](#) (on page 11-52)
- [digio.writeport\(\)](#) (on page 11-52)

display.clear()

This function clears all lines of the front-panel display.

Type	TSP-Link accessible	Affected by	Where saved	Default value
Function	Yes			

Usage

```
display.clear()
```

Details

This function switches to the user screen and then clears the front-panel display.

The `display.clear()`, `display.setcursor()`, and `display.settext()` functions are overlapped commands. That is, the script does not wait for one of these commands to complete. These functions do not immediately update the display. For performance considerations, they update the display as soon as processing time becomes available.

Also see

[display.setcursor\(\)](#) (on page 11-69)

[display.settext\(\)](#) (on page 11-70)

display.getannunciators()

This function reads the annunciators (indicators) that are presently turned on.

Type	TSP-Link accessible	Affected by	Where saved	Default value
Function	Yes			

Usage

```
annunciators = display.getannunciators()
```

<code>annunciators</code>	The bitmasked value that shows which indicators are turned on
---------------------------	---

Details

This function returns a bitmasked value showing which indicators are turned on. The 16-bit binary equivalent of the returned value is the bitmask. The return value is a sum of set annunciators, based on the weighted value, as shown in the following table.

Annunciator (indicator) bitmasked values and equivalent constants			
Indicator	Bit	Weighted value	Equivalent constant
FILT	1	1	display.ANNUNCIATOR_FILTER
MATH	2	2	display.ANNUNCIATOR_MATH
4W	3	4	display.ANNUNCIATOR_4_WIRE
AUTO	4	8	display.ANNUNCIATOR_AUTO
ARM	5	16	display.ANNUNCIATOR_ARM
TRIG	6	32	display.ANNUNCIATOR_TRIGGER
* (asterisk)	7	64	display.ANNUNCIATOR_STAR
SMPL	8	128	display.ANNUNCIATOR_SAMPLE
EDIT	9	256	display.ANNUNCIATOR_EDIT
ERR	10	512	display.ANNUNCIATOR_ERROR
REM	11	1024	display.ANNUNCIATOR_REMOTE
TALK	12	2048	display.ANNUNCIATOR_TALK
LSTN	13	4096	display.ANNUNCIATOR_LISTEN
SRQ	14	8192	display.ANNUNCIATOR_SRQ
REAR	15	16384	display.ANNUNCIATOR_REAR
REL	16	32768	display.ANNUNCIATOR_REL

Example 1

```
testAnnunciators = display.getannunciators()
print(testAnnunciators)

rem = bit.bitand(testAnnunciators, 1024)
if rem > 0 then
    print("REM is on")
else
    print("REM is off")
end
```

REM indicator is turned on.

Output:

```
1.28000e+03
REM is on
```

Example 2

```
print(display.ANNUNCIATOR_EDIT)

print(display.ANNUNCIATOR_TRIGGER)

print(display.ANNUNCIATOR_AUTO)
```

Output:

```
2.56000e+02
3.20000e+01
8.00000e+00
```

Also see

[bit.bitand\(\)](#) (on page 11-9)

display.getcursor()

This function reads the present position of the cursor on the front-panel display.

Type	TSP-Link accessible	Affected by	Where saved	Default value
Function	Yes			

Usage

```
row, column, style = display.getcursor()
```

<i>row</i>	The row where the cursor is: 1 (top row); 2 (bottom row)
<i>column</i>	The column where the cursor is: <ul style="list-style-type: none"> ▪ If the cursor is in the top row: 1 to 20 ▪ If the cursor is in the bottom row: 1 to 32
<i>style</i>	Visibility of the cursor: <ul style="list-style-type: none"> ▪ Invisible: 0 ▪ Blinking: 1

Details

This function switches the front-panel display to the user screen (the text set by `display.settext()`), and then returns values to indicate the cursor's row and column position and cursor style.

Columns are numbered from left to right on the display.

Example 1

```
testRow, testColumn = display.getcursor()
print(testRow, testColumn)
```

This example reads the cursor position into local variables and prints them. Example output:

```
1.00000e+00    1.00000e+00
```

Example 2

```
print(display.getcursor())
```

This example prints the cursor position directly. In this example, the cursor is in row 1 at column 3, with an invisible cursor:

```
1.00000e+00    3.00000e+00
0.00000e+00
```

Also see

[display.gettext\(\)](#) (on page 11-58)

[display.screen](#) (on page 11-67)

[display.setcursor\(\)](#) (on page 11-69)

[display.settext\(\)](#) (on page 11-70)

display.getlastkey()

This function retrieves the key code for the last pressed key.

Type	TSP-Link accessible	Affected by	Where saved	Default value
Function	Yes			

Usage

```
keyCode = display.getlastkey()
```

<i>keyCode</i>	A returned value that represents the last front-panel key pressed; see Details for more information
----------------	--

Details

A history of the key code for the last pressed front-panel key is maintained by the instrument. When the instrument is turned on, or when it is transitioning from local to remote operation, the key code is set to 0 (`display.KEY_NONE`).

Pressing the EXIT (LOCAL) key normally aborts a script. To use this function with the EXIT (LOCAL) key, you must set `display.locallockout` to `display.LOCK`.

The table below lists the *keyCode* value for each front-panel action.

Key codes			
Value	Key list	Value	Key list
0	<code>display.KEY_NONE</code>	82	<code>display.KEY_ENTER</code>
65	<code>display.KEY_RANGEUP</code>	85	<code>display.KEY_RECALL</code>
68	<code>display.KEY_MENU</code>	86	<code>display.KEY_MEASA</code>
69	<code>display.KEY_MODEA</code>	87	<code>display.KEY_DIGITSA</code>
70	<code>display.KEY_RELA</code>	92	<code>display.KEY_TRIG</code>
71	<code>display.KEY_RUN</code>	93	<code>display.KEY_LIMITA</code>
72	<code>display.KEY_DISPLAY</code>	94	<code>display.KEY_SPEEDA</code>
73	<code>display.KEY_AUTO</code>	95	<code>display.KEY_LOAD</code>
75	<code>display.KEY_EXIT</code>	97	<code>display.WHEEL_ENTER</code>
77	<code>display.KEY_FILTERA</code>	103	<code>display.KEY_RIGHT</code>
78	<code>display.KEY_STORE</code>	104	<code>display.KEY_LEFT</code>
79	<code>display.KEY_SRCA</code>	107	<code>display.WHEEL_LEFT</code>
80	<code>display.KEY_CONFIG</code>	114	<code>display.WHEEL_RIGHT</code>
81	<code>display.KEY_RANGEDOWN</code>		

NOTE

When using this function, use built-in constants such as `display.KEY_RIGHT` (rather than the numeric value of 103). This will allow for better forward compatibility with firmware revisions.

You cannot use this function to track the OUTPUT ON/OFF control.

Example

```
key = display.getlastkey()
print(key)
```

On the front panel, press the **MENU** key and then send the code shown here. This retrieves the key code for the last pressed key.

Output:
6.80000e+01

Also see

[display.locallockout](#) (on page 11-63)

[display.sendkey\(\)](#) (on page 11-67)

display.gettext()

This function reads the text displayed on the front panel.

Type	TSP-Link accessible	Affected by	Where saved	Default value
Function	Yes			

Usage

```
text = display.gettext()
text = display.gettext(embellished)
text = display.gettext(embellished, row)
text = display.gettext(embellished, row, columnStart)
text = display.gettext(embellished, row, columnStart, columnEnd)
```

<i>text</i>	The returned value, which contains the text that is presently displayed
<i>embellished</i>	Indicates type of returned text: <i>false</i> (simple text); <i>true</i> (text with embedded character codes)
<i>row</i>	Selects the row from which to read the text: 1 (row 1); 2 (row 2). If <i>row</i> is not included, both rows of text are read
<i>columnStart</i>	Selects the first column from which to read text; for row 1, the valid column numbers are 1 to 20; for row 2, the valid column numbers are 1 to 32; if nothing is selected, 1 is used
<i>columnEnd</i>	Selects the last column from which to read text; for row 1, the valid column numbers are 1 to 20; for row 2, the valid column numbers are 1 to 32; the default is 20 for row 1, and 32 for row 2

Details

Using the command without any parameters returns both lines of the front-panel display.

The $\$N$ character code is included in the returned value to show where the top line ends and the bottom line begins. This is not affected by the value of *embellished*.

When *embellished* is set to *true*, all other character codes are returned along with the message. When *embellished* is set to *false*, only the message and the $\$N$ character code is returned. For information on the embedded character codes, see [display.settext\(\)](#) (on page 11-70).

The display is not switched to the user screen (the screen set using `display.settext()`). Text is read from the active screen.

Example 1

```
display.clear()
display.setcursor(1, 1)
display.settext("ABCDEFGH IJ$DKLMNOPQRST")
display.setcursor(2, 1)
display.settext("abcdefghijklmnopqrstu vxyz$F123456")
print(display.gettext())
print(display.gettext(true))
print(display.gettext(false, 2))
print(display.gettext(true, 2, 9))
print(display.gettext(false, 2, 9, 10))
```

This example shows how to retrieve the display text in multiple ways. The output is:

```
ABCDEFGHIJKLMNOPQRST$Nabcdefghijklmnopqrstu vxyz123456
$RABCDEFGHIJKLMNOPQRST$N$Rabcdefghijklmnopqrstu vxyz$F123456
abcdefghijklmnopqrstu vxyz123456
$Rijklm$Bnopqrstu vxyz$F123456
ij
```

Example 2

```
display.clear()
display.settext("User Screen")
text = display.gettext()
print(text)
```

This outputs all text in both lines of the display:

```
User Screen      $N
```

This indicates that the message "User Screen" is on the top line. The bottom line is blank.

Also see

- [display.clear\(\)](#) (on page 11-54)
- [display.getcursor\(\)](#) (on page 11-56)
- [display.setcursor\(\)](#) (on page 11-69)
- [display.settext\(\)](#) (on page 11-70)

display.inputvalue()

This function displays a formatted input field on the front-panel display that the operator can edit.

Type	TSP-Link accessible	Affected by	Where saved	Default value
Function	Yes			

Usage

```
display.inputvalue("format")
display.inputvalue("format", default)
display.inputvalue("format", default, minimum)
display.inputvalue("format", default, minimum, maximum)
```

<i>format</i>	A string that defines how the input field is formatted; see Details for more information
<i>default</i>	The default value for the input value
<i>minimum</i>	The minimum input value
<i>maximum</i>	The maximum input value

Details

The *format* parameter uses zeros (0), the decimal point, polarity sign, and exponents to define how the input field is formatted. The *format* parameter can include the options shown in the following table.

Option	Description	Examples
E	Include the E to display the value exponentially	0.00000e+0
+	Allows operators to enter positive or negative values; if the "+" sign is not included, the operator cannot enter a negative value	+0.00
0	Defines the digit positions for the value; you can use up to six zeros (0)	+00.0000e+00
.	Include to have a decimal point appear in the value	+0.00



The *default* parameter is the value shown when the value is first displayed.

The *minimum* and *maximum* parameters can be used to limit the values that can be entered. When + is not selected for *format*, the minimum limit must be more than or equal to zero (0). When limits are used, you cannot enter values above or below these limits.

The input value is limited to $\pm 1e37$.

Before calling `display.inputvalue()`, you should send a message prompt to the operator using `display.prompt()`. Make sure to position the cursor where the edit field should appear.

After this command is sent, script execution pauses until you enter a value and press the **ENTER** key.

For positive and negative entry (plus sign (+) used for the value field and/or the exponent field), polarity of a nonzero value or exponent can be toggled by positioning the cursor on the polarity sign and turning the navigation wheel . Polarity will also toggle when using the navigation wheel  to decrease or increase the value or exponent past zero. A zero (0) value or exponent (for example, +00) is always positive and cannot be toggled to negative polarity.

After executing this command and pressing the EXIT (LOCAL) key, the function returns `nil`.

Example

```
display.clear()
display.setText("Enter value between$N -0.10 and 2.00: ")
value = display.inputvalue("+0.00", 0.5, -0.1, 2.0)
print("Value entered = ", value)
```

Displays an editable field (+0.50) for operator input. The valid input range is -0.10 to +2.00, with a default of 0.50.

Output:

```
Value entered = 1.35000e+00
```

Also see

[display.prompt\(\)](#) (on page 11-65)

[display.setcursor\(\)](#) (on page 11-69)

[display.setText\(\)](#) (on page 11-70)

display.loadmenu.add()

This function adds an entry to the USER menu, which can be accessed by pressing the **LOAD** key on the front panel.

Type	TSP-Link accessible	Affected by	Where saved	Default value
Function	Yes			

Usage

```
display.loadmenu.add("displayName", "code")
display.loadmenu.add("displayName", "code", memory)
```

<i>displayName</i>	The name that is added to the USER menu
<i>code</i>	The code that is run from the USER menu
<i>memory</i>	Determines if code is saved to nonvolatile memory: <ul style="list-style-type: none"> ▪ 0 or <code>display.DONT_SAVE</code>: Does not save the code to nonvolatile memory ▪ 1 or <code>display.SAVE</code>: Saves the code to nonvolatile memory (default)

Details

After adding code to the load menu, you can run it from the front panel by pressing the **LOAD** key, then selecting **USER** to select from the available code to load. Pressing the **RUN** key will then run the script.

You can add items in any order. They are always displayed in alphabetic order when the menu is selected.

Any Lua code can be included in the *code* parameter. If *memory* is set to `display.SAVE`, the entry (name and code) is saved in nonvolatile memory. Scripts, functions, and variables used in the code are not saved by `display.SAVE`. Functions and variables need to be saved with the code. If the code is not saved in nonvolatile memory, it is lost when the 2601B-PULSE is turned off. See **Example 2** below.

If you do not make a selection for *memory*, the code is automatically saved to nonvolatile memory.

NOTE

You can create a script that defines several functions, and then use the `display.loadmenu.add()` command to add items that call those individual functions. This allows the operator to run tests from the front panel.

Example 1

```
display.loadmenu.add("Test9", "Test9()")
```

Assume a user script named "Test9" has been loaded into the runtime environment. Adds the menu entry to the USER menu to run the script after loading.

Example 2

```
display.loadmenu.add("Test", "DUT1() beeper.beep(2, 500)", display.SAVE)
```

Assume a script with a function named “DUT1” has already been loaded into the instrument, and the script has not been saved in nonvolatile memory.

Now assume you want to add a test named “Test” to the USER menu. You want the test to run the function named “DUT1” and sound the beeper. This example adds “Test” to the menu, defines the code, and then saves the `displayName` and code in nonvolatile memory.

When “Test” is run from the front panel USER menu, the function named “DUT1” executes and the beeper beeps for two seconds.

Now assume you turn off instrument power. Because the script was not saved in nonvolatile memory, the function named “DUT1” is lost when you turn the instrument on. When “Test” is again run from the front panel, an error is generated because DUT1 no longer exists in the instrument as a function.

Example 3

```
display.loadmenu.add("Part1", "testpart([[Part1]], 5.0)", display.SAVE)
```

Adds an entry called “Part1” to the front panel USER load menu for the code `testpart([[Part1]], 5.0)`, and saves it in nonvolatile memory.

Also see

[display.loadmenu.delete\(\)](#) (on page 11-63)

display.loadmenu.catalog()

This function creates an iterator for the user menu items accessed using the LOAD key on the front panel.

Type	TSP-Link accessible	Affected by	Where saved	Default value
Function	No			

Usage

```
for displayName in display.loadmenu.catalog() do body end
for displayName, code in display.loadmenu.catalog() do body end
```

<code>displayName</code>	The name displayed in the menu
<code>code</code>	The code associated with the <code>displayName</code>
<code>body</code>	The body of the code to process the entries in the loop

Details

Each time through the loop, `displayName` and `code` will take on the values in the USER menu.

The instrument goes through the list in random order.

Example

```
for displayName, code in
  display.loadmenu.catalog() do
  print(displayName, code)
end
```

Output:
 Test DUT1() beeper.beep(2, 500)
 Part1 testpart([[Part1]], 5.0)
 Test9 Test9()

Also see

[display.loadmenu.add\(\)](#) (on page 11-61)

[display.loadmenu.delete\(\)](#) (on page 11-63)

display.loadmenu.delete()

This function removes an entry from the USER menu, which can be accessed using the **LOAD** key on the front panel.

Type	TSP-Link accessible	Affected by	Where saved	Default value
Function	Yes			

Usage

```
display.loadmenu.delete("displayName")
```

<i>displayName</i>	The name to be deleted from the USER menu
--------------------	---

Details

If you delete an entry from the USER menu, you can no longer run it by pressing the **LOAD** key.

Example

```
display.loadmenu.delete("Test9")
for displayName, code in
  display.loadmenu.catalog() do
  print(displayName, code)
end
```

Deletes the entry named Test9.

Output:

```
Test  DUT1() beeper.beep(2, 500)
Part1 testpart([[Part1]], 5.0)
```

Also see

[display.loadmenu.add\(\)](#) (on page 11-61)

[display.loadmenu.catalog\(\)](#) (on page 11-62)

display.locallockout

This attribute describes whether or not the EXIT (LOCAL) key on the instrument front panel is enabled.

Type	TSP-Link accessible	Affected by	Where saved	Default value
Attribute (RW)	Yes	Power cycle	Not saved	0 (display.UNLOCK)

Usage

```
lockout = display.locallockout
display.locallockout = lockout
```

<i>lockout</i>	0 or display.UNLOCK: Unlocks EXIT (LOCAL) key 1 or display.LOCK: Locks out EXIT (LOCAL) key
----------------	--

Details

Set `display.locallockout` to `display.LOCK` to prevent the user from interrupting remote operation by pressing the EXIT (LOCAL) key.

Set this attribute to `display.UNLOCK` to allow the EXIT (LOCAL) key to interrupt script or remote operation.

Example

```
display.locallockout = display.LOCK
```

Disables the front-panel EXIT (LOCAL) key.

Also see

None

display.menu()

This function presents a menu on the front-panel display.

Type	TSP-Link accessible	Affected by	Where saved	Default value
Function	Yes			



Usage

```
selection = display.menu("name", "items")
```

<i>selection</i>	Name of the variable that holds the selected menu item
<i>name</i>	Menu name to display on the top line
<i>items</i>	Menu items to display on the bottom line

Details

The menu consists of the menu name string on the top line, and a selectable list of items on the bottom line. The menu items must be a single string with each item separated by whitespace. The name for the top line is limited to 20 characters.

After sending this command, script execution pauses for the operator to select a menu item. An item is selected by rotating the navigation wheel  to place the blinking cursor on the item, and then pressing the navigation wheel  (or the ENTER key). When an item is selected, the text of that selection is returned.

Pressing the EXIT (LOCAL) key will not abort the script while the menu is displayed, but it will return `nil`. The script can be aborted by calling the `exit` function when `nil` is returned.

Example

```
selection = display.menu("Menu", "Test1 Test2 Test3")
print(selection)
```

Displays a menu with three menu items. If the second menu item is selected, `selection` is given the value `Test2`.

Output:
Test2

Also see

None

display.numpad

This attribute controls whether the front panel keys act as a numeric keypad during value entry.

Type	TSP-Link accessible	Affected by	Where saved	Default value
Attribute (RW)	Yes	Instrument reset Recall setup	Saved setup	1 (display.ENABLE)

Usage

```
numericKeypad = display.numpad
display.numpad = numericKeypad
```

<i>numericKeypad</i>	Enable the numeric keypad feature (1 or <code>display.ENABLE</code>) Disable the numeric keypad feature (0 or <code>display.DISABLE</code>)
----------------------	--

Details

The numeric keypad feature is only available when editing a numeric value at the same time that the EDIT indicator is lit.

Example

```
display.numpad = display.ENABLE
```

Turn on the numeric keypad feature.

Also see

[Setting a value](#) (on page 3-11)

display.prompt()

This function prompts the user to enter a parameter from the front panel of the instrument.

Type	TSP-Link accessible	Affected by	Where saved	Default value
Function	Yes			

Usage

```
display.prompt("format", "units", "help")
display.prompt("format", "units", "help", default)
display.prompt("format", "units", "help", default, minimum)
display.prompt("format", "units", "help", default, minimum, maximum)
```

<i>format</i>	A string that defines how the input field is formatted; see Details for more information
<i>units</i>	Set the units text string for the top line (eight characters maximum); this indicates the units (for example, "V" or "A") for the value
<i>help</i>	Text string to display on the bottom line (32 characters maximum)
<i>default</i>	The value that is shown when the value is first displayed
<i>minimum</i>	The minimum input value that can be entered
<i>maximum</i>	The maximum input value that can be entered (must be more than minimum)

Details

This function creates an editable input field at the present cursor position, and an input prompt message on the bottom line. Example of a displayed input field and prompt:

```
0.00V
```

```
Input 0 to +2V
```

The *format* parameter uses zeros (0), the decimal point, polarity sign, and exponents to define how the input field is formatted.



The *format* parameter can include the options shown in the following table.

Option	Description	Examples
E	Include the E to display the value exponentially. Include a plus sign (+) for positive/negative exponent entry. Do not include the plus sign (+) to prevent negative value entry. 0 defines the digit positions for the exponent.	0.00000E+0
+	Allows operators to enter positive or negative values. If the plus sign (+) is not included, the operator cannot enter a negative value.	+0.00
0	Defines the digit positions for the value. You can use up to six zeros (0).	+00.00000E+00
.	The decimal point where needed for the value.	+0.00

You can use the *minimum* and *maximum* parameters to limit the values that can be entered. When a plus sign (+) is not selected for *format*, the minimum limit must be greater than or equal to zero (0). When limits are used, the operator cannot enter values above or below these limits.

The input value is limited to $\pm 1e37$.

After sending this command, script execution pauses for the operator to enter a value and press **ENTER**.

For positive and negative entry (plus sign (+) used for the value field and the exponent field), polarity of a nonzero value or exponent can be toggled by positioning the cursor on the polarity sign and turning the navigation wheel . Polarity will also toggle when using the navigation wheel  to decrease or increase the value or exponent past zero. A zero value or exponent (for example, +00) is always positive and cannot be toggled to negative polarity.

After executing this command and pressing the **EXIT (LOCAL)** key, the value returns `nil`.

Example

```
value = display.prompt("0.00", "V", "Input 0 to +2V", 0.5, 0, 2)
print(value)
```

The above command prompts the operator to enter a voltage value. The valid input range is 0 to +2.00, with a default of 0.50:

```
0.50V
```

```
Input 0 to +2V
```

If the operator enters 0.70, the output is:

```
7.00000e-01
```

Also see

[display.inputvalue\(\)](#) (on page 11-59)

display.screen

This attribute contains the selected display screen.

Type	TSP-Link accessible	Affected by	Where saved	Default value
Attribute (RW)	Yes	Instrument reset Recall setup	Saved setup	0 (display.SMUA)

Usage

```
displayID = display.screen
display.screen = displayID
```

displayID

One of the following values:

- 0 or `display.SMUA`: Displays source-measure and compliance values
- 3 or `display.USER`: Displays the user screen

Details

Setting this attribute selects the display screen for the front panel. This performs the same action as pressing the DISPLAY key on the front panel. The text for the display screen is set by `display.settext()`.

Read this attribute to determine which of the available display screens was last selected.

Example

```
display.screen = display.SMUA
```

Selects the source-measure and compliance limit display.

Also see

[display.settext\(\)](#) (on page 11-70)

display.sendkey()

This function sends a code that simulates the action of a front-panel control.

Type	TSP-Link accessible	Affected by	Where saved	Default value
Function	Yes			

Usage

```
display.sendkey(keyCode)
```

keyCode

A parameter that specifies the key press to simulate; see **Details** for more information

Details

This command simulates pressing a front-panel key or navigation wheel, or turning the navigation wheel one click to the left or right.

Key codes			
Value	Key list	Value	Key list
65	display.KEY_RANGEUP	85	display.KEY_RECALL
68	display.KEY_MENU	86	display.KEY_MEASA
69	display.KEY_MODEA	87	display.KEY_DIGITSA
70	display.KEY_RELA	88	display.KEY_OUTPUTA
71	display.KEY_RUN	92	display.KEY_TRIG
72	display.KEY_DISPLAY	93	display.KEY_LIMITA
73	display.KEY_AUTO	94	display.KEY_SPEEDA
75	display.KEY_EXIT	95	display.KEY_LOAD
77	display.KEY_FILTERA	97	display.WHEEL_ENTER
78	display.KEY_STORE	103	display.KEY_RIGHT
79	display.KEY_SRCA	104	display.KEY_LEFT
80	display.KEY_CONFIG	107	display.WHEEL_LEFT
81	display.KEY_RANGEDOWN	114	display.WHEEL_RIGHT
82	display.KEY_ENTER		

NOTE

When using this function, send built-in constants, such as `display.KEY_RIGHT`, rather than the numeric value, such as 103. This allows for better forward compatibility with firmware revisions.

Example

```
display.sendkey(display.KEY_RUN) Simulates pressing the RUN key.
```

Also see

[Front panel](#) (on page 3-1)

display.smua.digits

This attribute sets the front-panel display resolution of the selected measurement.

Type	TSP-Link accessible	Affected by	Where saved	Default value
Attribute (RW)	Yes	Instrument reset Recall setup	Saved setup	5 (display.DIGITS_5_5)

Usage

```
digits = display.smua.digits
display.smua.digits = digits
```

<i>digits</i>	Set digits to one of the following values: <ul style="list-style-type: none"> ▪ Select 4-1/2 digit resolution (4 or <code>display.DIGITS_4_5</code>) ▪ Select 5-1/2 digit resolution (5 or <code>display.DIGITS_5_5</code>) ▪ Select 6-1/2 digit resolution (6 or <code>display.DIGITS_6_5</code>)
---------------	---

Details

This attribute sets the display resolution.

Example

```
display.smua.digits = display.DIGITS_5_5
```

Select 5-1/2 digit resolution.

Also see

[Display resolution](#) (on page 3-16)

display.setcursor()

This function sets the position of the cursor.

Type	TSP-Link accessible	Affected by	Where saved	Default value
Function	Yes			

Usage

```
display.setcursor(row, column)
display.setcursor(row, column, style)
```

<i>row</i>	The row number for the cursor (1 or 2)
<i>column</i>	The active column position to set; row 1 has columns 1 to 20, row 2 has columns 1 to 32
<i>style</i>	Set the cursor to invisible (0, default) or blinking (1)

Details

Sending this command selects the user screen and then moves the cursor to the given location.

The `display.clear()`, `display.setcursor()`, and `display.settext()` functions are overlapped commands. That is, the script does not wait for one of these commands to complete. These functions do not immediately update the display. For performance considerations, they update the display as soon as processing time becomes available.

An out-of-range parameter for *row* sets the cursor to row 2. An out-of-range parameter for *column* sets the cursor to column 20 for row 1, or 32 for row 2.

An out-of-range parameter for *style* sets it to 0 (invisible).

A blinking cursor is only visible when it is positioned over displayed text. It cannot be seen when positioned over a space character.

Example

```
display.clear()
display.setcursor(1, 8)
display.settext("Hello")
display.setcursor(2, 14)
display.settext("World")
```

This example displays a message on the front panel, approximately center. Note that the top line of text is larger than the bottom line of text.

The front panel of the instrument displays "Hello" on the top line and "World" on the second line.

Also see

- [display.clear\(\)](#) (on page 11-54)
- [display.getcursor\(\)](#) (on page 11-56)
- [display.gettext\(\)](#) (on page 11-58)
- [display.screen](#) (on page 11-67)
- [display.settext\(\)](#) (on page 11-70)

display.settext()

This function displays text on the front-panel user screen.

Type	TSP-Link accessible	Affected by	Where saved	Default value
Function	Yes			

Usage

```
display.settext("text")
```

<i>text</i>	Text message to be displayed, with optional character codes
-------------	---

Details

This function selects the user display screen and displays the given text.

After the instrument is turned on, the first time you use a display command to write to the display, the message "User Screen" is cleared. After the first write, you need to use `display.clear()` to clear the message.

The `display.clear()`, `display.setcursor()`, and `display.settext()` functions are overlapped commands. That is, the script does not wait for one of these commands to complete. These functions do not immediately update the display. For performance considerations, they update the display as soon as processing time becomes available.

The text starts at the present cursor position. After the text is displayed, the cursor is after the last character in the display message.

Top line text does not wrap to the bottom line of the display automatically. Any text that does not fit on the current line is truncated. If the text is truncated, the cursor remains at the end of the line.

The text remains on the display until replaced or cleared.

The character codes described in the following table can be also be included in the text string.

Character Code	Description
\$N	Newline, starts text on the next line; if the cursor is already on line 2, text will be ignored after the \$N is received
\$R	Sets text to normal intensity, nonblinking
\$B	Sets text to blink
\$D	Sets text to dim intensity
\$F	Sets the text to background blink
\$\$	Escape sequence to display a single dollar symbol (\$)

Example

```
display.clear()
display.settext("Normal $Bblinking$N")
display.settext("$DDim $FBackgroundBlink$R $$$ $ 2 dollars")
```

This example sets the display to:

```
Normal Blinking
Dim BackgroundBlink $$ 2 dollars
with the named effect on each word.
```

Also see

- [display.clear\(\)](#) (on page 11-54)
- [display.getcursor\(\)](#) (on page 11-56)
- [display.gettext\(\)](#) (on page 11-58)
- [display.screen](#) (on page 11-67)
- [display.setcursor\(\)](#) (on page 11-69)

display.smua.limit.func

This attribute specifies the type of limit value setting displayed for the SMU.

Type	TSP-Link accessible	Affected by	Where saved	Default value
Attribute (RW)	Yes	Instrument reset Recall setup	Saved setup	0 (display.LIMIT_IV)

Usage

```
func = display.smua.limit.func
display.smua.limit.func = func
```

func

One of the following values:

- 0 or `display.LIMIT_IV`: Displays the primary limit setting
- 1 or `display.LIMIT_P`: Displays the power limit setting

Details

Selects the displayed limit function for the SMU: primary (IV) or power (P).

Example

```
display.smua.limit.func = display.LIMIT_P
```

Specifies that the power limit value is displayed.

Also see

- [display.smua.measure.func](#) (on page 11-71)
- [Display mode](#) (on page 3-14)

display.smua.measure.func

This attribute specifies the type of measurement that is being displayed.

Type	TSP-Link accessible	Affected by	Where saved	Default value
Attribute (RW)	Yes	Instrument reset Recall setup	Saved setup	1 (display.MEASURE_DCVOLTS)

Usage

```
func = display.smua.measure.func
display.smua.measure.func = func
```

<i>func</i>	<p>The type of measurement:</p> <ul style="list-style-type: none"> ▪ 0 or <code>display.MEASURE_DCAMPS</code>: Current measurement function ▪ 1 or <code>display.MEASURE_DCVOLTS</code>: Voltage measurement function ▪ 2 or <code>display.MEASURE_OHMS</code>: Resistance measurement function ▪ 3 or <code>display.MEASURE_WATTS</code>: Power measurement function
-------------	---

Details

Selects the measurement function that is displayed on the front panel: Amps, volts, ohms, or watts.

Example

```
display.smua.measure.func = display.MEASURE_DCAMPS
```

Selects the current measure function.

Also see

[display.smua.limit.func](#) (on page 11-71)

display.trigger.clear()

This function clears the front-panel trigger event detector.

Type	TSP-Link accessible	Affected by	Where saved	Default value
Function	Yes			

Usage

```
display.trigger.clear()
```

Details

The trigger event detector remembers if an event has been detected since the last `display.trigger.wait()` call. This function clears the trigger event detector and discards the previous history of TRIG key presses.

This attribute also clears the `display.trigger.overrun` attribute.

Also see

[display.trigger.overrun](#) (on page 11-73)

[display.trigger.wait\(\)](#) (on page 11-74)

display.trigger.EVENT_ID

This constant is the event ID of the event generated when the front-panel TRIG key is pressed.

Type	TSP-Link accessible	Affected by	Where saved	Default value
Constant	Yes			

Usage

```
eventID = display.trigger.EVENT_ID
```

<code>eventID</code>	The trigger event number
----------------------	--------------------------

Details

Set the stimulus of any trigger event detector to the value of this constant to have it respond to front-panel trigger key events.

Also see

None

display.trigger.overrun

This attribute contains the event detector overrun status.

Type	TSP-Link accessible	Affected by	Where saved	Default value
Attribute (R)	Yes	Display trigger clear Instrument reset Recall setup	Not saved	false

Usage

```
overrun = display.trigger.overrun
```

<code>overrun</code>	The trigger overrun state (true or false)
----------------------	---

Details

Indicates if a trigger event was ignored because the event detector was already in the detected state when the TRIG button was pressed.

Indicates the overrun state of the event detector built into the display.

This attribute does not indicate whether an overrun occurred in any other part of the trigger model or in any other detector that is monitoring the event.

Example

```
overrun = display.trigger.overrun
```

Sets the variable `overrun` equal to the present state of the event detector built into the display.

Also see

[display.trigger.clear\(\)](#) (on page 11-72)

display.trigger.wait()

This function waits for the TRIG key on the front panel to be pressed.

Type	TSP-Link accessible	Affected by	Where saved	Default value
Function	Yes			

Usage

```
triggered = display.trigger.wait(timeout)
```

<i>triggered</i>	true: Trigger was detected false: The operation timed out
<i>timeout</i>	Timeout in seconds

Details

If the trigger key was previously pressed and one or more trigger events were detected, this function returns immediately.

After waiting for a trigger with this function, the event detector is automatically reset and rearmed. This is true regardless of the number of events detected.

Use the `display.trigger.clear()` call to clear the trigger event detector.

Example

```
triggered = display.trigger.wait(5)
print(triggered)
```

Waits up to five seconds for the TRIG key to be pressed. If TRIG is pressed within five seconds, the output is `true`. If not, the output is `false`.

Also see

[display.trigger.clear\(\)](#) (on page 11-72)

display.waitkey()

This function captures the key code value for the next front-panel action.



Type	TSP-Link accessible	Affected by	Where saved	Default value
Function	Yes			

Usage

```
keyCode = display.waitkey()
```

<i>keyCode</i>	See Details for more information
----------------	---

Details

After you send this function, script execution pauses until a front-panel action (for example, pressing a key or the navigation wheel , or turning the navigation wheel ). After the action, the value of the key (or action) is returned.

If the EXIT (LOCAL) key is pressed while this function is waiting for a front-panel action, the script is not aborted.

A typical use for this function is to prompt the user to press the EXIT (LOCAL) key to abort the script or press any other key to continue. For example, if the `keyCode` value 75 is returned (the EXIT (LOCAL) key was pressed), you can call the `exit()` function to abort the script.

The table below lists the `keyCode` values for each front panel action.

Key codes			
Value	Key list	Value	Key list
65	<code>display.KEY_RANGEUP</code>	85	<code>display.KEY_RECALL</code>
68	<code>display.KEY_MENU</code>	86	<code>display.KEY_MEASA</code>
69	<code>display.KEY_MODEA</code>	87	<code>display.KEY_DIGITSA</code>
70	<code>display.KEY_RELA</code>	88	<code>display.KEY_OUTPUTA</code>
71	<code>display.KEY_RUN</code>	92	<code>display.KEY_TRIG</code>
72	<code>display.KEY_DISPLAY</code>	93	<code>display.KEY_LIMITA</code>
73	<code>display.KEY_AUTO</code>	94	<code>display.KEY_SPEEDA</code>
75	<code>display.KEY_EXIT</code>	95	<code>display.KEY_LOAD</code>
77	<code>display.KEY_FILTERA</code>	97	<code>display.WHEEL_ENTER</code>
78	<code>display.KEY_STORE</code>	103	<code>display.KEY_RIGHT</code>
79	<code>display.KEY_SRCA</code>	104	<code>display.KEY_LEFT</code>
80	<code>display.KEY_CONFIG</code>	107	<code>display.WHEEL_LEFT</code>
81	<code>display.KEY_RANGEDOWN</code>	114	<code>display.WHEEL_RIGHT</code>
82	<code>display.KEY_ENTER</code>		

NOTE

When using this function, send built-in constants, such as `display.KEY_RIGHT`, rather than the numeric value, such as 103. This allows for better forward compatibility with firmware revisions.

Example

```
key = display.waitkey()
print(key)
```

Pause script execution until the operator presses a key or the navigation wheel , or rotates the navigation wheel.

If the output is:

```
8.60000e+01
```

It indicates that the MEAS(A) key was pressed.

Also see

[Capturing key-press codes](#) (on page 3-26)

[display.getlastkey\(\)](#) (on page 11-57)

[display.sendkey\(\)](#) (on page 11-67)

[display.settext\(\)](#) (on page 11-70)

errorqueue.clear()

This function clears all entries out of the error queue.

Type	TSP-Link accessible	Affected by	Where saved	Default value
Function	Yes			

Usage

```
errorqueue.clear()
```

Details

See the [Error queue](#) (on page 15-3) topic for additional information about the error queue.

Also see

[errorqueue.count](#) (on page 11-76)

[errorqueue.next\(\)](#) (on page 11-77)

errorqueue.count

This attribute gets the number of entries in the error queue.

Type	TSP-Link accessible	Affected by	Where saved	Default value
Attribute (R)	Yes	Power cycle Clearing error queue Reading error messages	Not applicable	Not applicable

Usage

```
count = errorqueue.count
```

<code>count</code>	The number of entries in the error queue
--------------------	--

Example

```
count = errorqueue.count
print(count)
```

Returns the number of entries in the error queue. The output below indicates that there are four entries in the error queue:

```
4.00000e+00
```

Also see

[Error queue](#) (on page 15-3)

[errorqueue.clear\(\)](#) (on page 11-76)

[errorqueue.next\(\)](#) (on page 11-77)

errorqueue.next()

This function reads the oldest entry from the error queue and removes it from the queue.

Type	TSP-Link accessible	Affected by	Where saved	Default value
Function	Yes			

Usage

```
errorCode, message, severity, errorNode = errorqueue.next()
```

<i>errorCode</i>	The error code number for the entry
<i>message</i>	The message that describes the error code
<i>severity</i>	The severity level (0, 10, 20, 30, or 40); see Details for more information
<i>errorNode</i>	The node number where the error originated

Details

Entries are stored in a first-in, first-out (FIFO) queue. This function reads the oldest entry and removes it from the queue.

Error codes and messages are listed in the [Error summary list](#) (on page 12-2).

If there are no entries in the queue, code 0, "Queue is Empty" is returned.

Returned severity levels are described in the following table.

Number	Error level	Description
0	NO_SEVERITY	The message is information only. This level is used when the Error Queue is empty; the message does not represent an error.
10	INFORMATIONAL	The message is information only. This level is used to indicate status changes; the message does not represent an error.
20	RECOVERABLE	The error was caused by improper use of the instrument or by conditions that can be corrected. This message indicates that an error occurred. The instrument is still operating normally.
30	SERIOUS	There is a condition that prevents the instrument from functioning properly. The message indicates that the instrument is presently operating in an error condition. If the condition is corrected, the instrument will return to normal operation.
40	FATAL	There is a condition that cannot be corrected that prevents the instrument from functioning properly. Disconnect the DUT and turn the power off and then on again. If the error is a hardware fault that persists after cycling the power, the instrument must be repaired.

In an expanded system, each TSP-Link enabled instrument is assigned a node number. The variable *errorNode* stores the node number where the error originated.

Example

```
errorcode, message = errorqueue.next()
print(errorcode, message)
```

Reads the oldest entry in the error queue. The output below indicates that the queue is empty.
Output:
0.00000e+00 Queue Is Empty

Also see

- [Error queue](#) (on page 15-3)
- [errorqueue.clear\(\)](#) (on page 11-76)
- [errorqueue.count](#) (on page 11-76)
- [Error summary list](#) (on page 12-2)

eventlog.all()

This function returns all entries from the event log as a single string and removes them from the event log.

Type	TSP-Link accessible	Affected by	Where saved	Default value
Function	Yes			

Usage

```
logString = eventlog.all()
```

<i>logString</i>	A listing of all event log entries
------------------	------------------------------------

Details

This function returns all events in the event log. Logged items are shown from oldest to newest. The response is a string that has the messages delimited with a new line character.

This function also clears the event log.

If there are no entries in the event log, this function returns the value `nil`.

Example

```
print(eventlog.all())
```

Get and print all entries from the event log and remove the entries from the log.

Output:

```
17:26:35.690 10 Oct 2019, LAN0, 192.168.1.102, LXI, 0, 1570728395,
1192037155.733269000, 0, 0x0
17:26:39.009 10 Oct 2019, LAN5, 192.168.1.102, LXI, 0, 1570728399,
1192037159.052777000, 0, 0x0
```

Also see

- [eventlog.clear\(\)](#) (on page 11-79)
- [eventlog.count](#) (on page 11-79)
- [eventlog.enable](#) (on page 11-80)
- [eventlog.next\(\)](#) (on page 11-81)
- [eventlog.overwritemethod](#) (on page 11-82)

eventlog.clear()

This function clears the event log.

Type	TSP-Link accessible	Affected by	Where saved	Default value
Function	Yes			

Usage

```
eventlog.clear()
```

Details

This command removes all messages from the event log.

Also see

- [eventlog.all\(\)](#) (on page 11-78)
- [eventlog.count](#) (on page 11-79)
- [eventlog.enable](#) (on page 11-80)
- [eventlog.next\(\)](#) (on page 11-81)
- [eventlog.overwritemethod](#) (on page 11-82)

eventlog.count

This attribute returns the number of unread events in the event log.

Type	TSP-Link accessible	Affected by	Where saved	Default value
Attribute (R)	Yes	Instrument reset Clearing event log Reading event log	Not applicable	Not applicable

Usage

```
N = eventlog.count
```

N	The number of events in the event log
---	---------------------------------------

Example

```
print(eventlog.count)
```

Displays the present number of events in the instrument event log.
Output looks similar to:
3.00000e+00

Also see

- [eventlog.all\(\)](#) (on page 11-78)
- [eventlog.clear\(\)](#) (on page 11-79)
- [eventlog.enable](#) (on page 11-80)
- [eventlog.next\(\)](#) (on page 11-81)
- [eventlog.overwritemethod](#) (on page 11-82)

eventlog.enable

This attribute enables or disables the event log.

Type	TSP-Link accessible	Affected by	Where saved	Default value
Attribute (RW)	Yes	Instrument reset Recall setup	Not saved	1 (eventlog.ENABLE)

Usage

```
status = eventlog.enable
eventlog.enable = status
```

<i>status</i>	The enable status of the event log: 1 or eventlog.ENABLE: Event log enable 0 or eventlog.DISABLE: Event log disable
---------------	---

Details

When the event log is disabled (eventlog.DISABLE or 0), no new events are added to the event log. You can, however, read and remove existing events.

When the event log is enabled, new events are logged.

Example

<pre>print(eventlog.enable) eventlog.enable = eventlog.DISABLE print(eventlog.enable)</pre>	Displays the present status of the 2601B-PULSE event log. Output: 1.00000e+00 0.00000e+00
---	---

Also see

- [eventlog.all\(\)](#) (on page 11-78)
- [eventlog.clear\(\)](#) (on page 11-79)
- [eventlog.count](#) (on page 11-79)
- [eventlog.next\(\)](#) (on page 11-81)
- [eventlog.overwritemethod](#) (on page 11-82)

eventlog.next()

This function returns the oldest unread event message from the event log and removes it from the event log.

Type	TSP-Link accessible	Affected by	Where saved	Default value
Function	Yes			

Usage

```
logString = eventlog.next()
```

<i>logString</i>	The next log entry
------------------	--------------------

Details

Returns the next entry from the event log and removes it from the log.

If there are no entries in the event log, returns the value `nil`.

Example 1

```
print(eventlog.next())
```

Get the oldest message in the event log and remove that entry from the log.

Output:

```
17:28:22.085 10 Oct 2019, LAN2, 192.168.1.102, LXI, 0, 1570728502, <no time>, 0, 0x0
```

Example 2

```
print(eventlog.next())
```

If you send this command when there is nothing in the event log, you will get the following output:

```
nil
```

Also see

- [eventlog.all\(\)](#) (on page 11-78)
- [eventlog.clear\(\)](#) (on page 11-79)
- [eventlog.count](#) (on page 11-79)
- [eventlog.enable](#) (on page 11-80)
- [eventlog.overwritemethod](#) (on page 11-82)

eventlog.overwritemethod

This attribute controls how the event log processes events if the event log is full.

Type	TSP-Link accessible	Affected by	Where saved	Default value
Attribute (RW)	Yes	Instrument reset Recall setup	Not saved	1 (eventlog.DISCARD_OLDEST)

Usage

```
method = eventlog.overwritemethod
eventlog.overwritemethod = method
```

method

Set to one of the following values:

- 0 or `eventlog.DISCARD_NEWEST`: New entries are not logged
- 1 or `eventlog.DISCARD_OLDEST`: Old entries are deleted as new events are logged

Details

When this attribute is set to `eventlog.DISCARD_NEWEST`, new entries are not logged.

When this attribute is set to `eventlog.DISCARD_OLDEST`, the oldest entry is discarded when a new entry is added.

Example

```
eventlog.overwritemethod = 0
```

When the log is full, the event log will ignore new entries.

Also see

- [eventlog.all\(\)](#) (on page 11-78)
- [eventlog.clear\(\)](#) (on page 11-79)
- [eventlog.count](#) (on page 11-79)
- [eventlog.enable](#) (on page 11-80)
- [eventlog.next\(\)](#) (on page 11-81)

exit()

This function stops a script that is presently running.

Type	TSP-Link accessible	Affected by	Where saved	Default value
Function	No			

Usage

```
exit()
```

Details

Terminates script execution when called from a script that is being executed.

This command does not wait for overlapped commands to complete before terminating script execution. If overlapped commands are required to finish, use the `waitcomplete()` function before calling `exit()`.

Also see

[waitcomplete\(\)](#) (on page 11-393)

fileVar:close()

This function closes the file that is represented by the *fileVar* variable.

Type	TSP-Link accessible	Affected by	Where saved	Default value
Function	No			

Usage

```
fileVar:close()
```

<i>fileVar</i>	The file descriptor variable to close
----------------	---------------------------------------

Details

This command is equivalent to `io.close(fileVar)`.

Note that files are automatically closed when the file descriptors are garbage collected.

Example

```
local fileName = "/usb1/myfile.txt"

if fs.is_file(fileName) then
    os.remove(fileName)
    print("Removing file")
else
    print("Nothing removed")
end

print("\n*** fileVar:close")
do
myfile, myfile_err, myfile_errnum = io.open(fileName, "w")
myfile:write("Line 1")
myfile:close()
end
myfile, myfile_err, myfile_errnum = io.open(fileName, "r")
myfile:close()
os.remove(fileName)

Opens file myfile.txt for writing. If no errors were found while opening, writes Removing file and closes the file.
```

Also see

- [fileVar:flush\(\)](#) (on page 11-84)
- [fileVar:read\(\)](#) (on page 11-85)
- [fileVar:seek\(\)](#) (on page 11-86)
- [fileVar:write\(\)](#) (on page 11-88)
- [io.close\(\)](#) (on page 11-102)
- [io.open\(\)](#) (on page 11-104)

fileVar:flush()

This function writes buffered data to a file.

Type	TSP-Link accessible	Affected by	Where saved	Default value
Function	No			

Usage

```
fileVar:flush()
```

<i>fileVar</i>	The file descriptor variable to flush
----------------	---------------------------------------

Details

The `fileVar:write()` or `io.write()` functions buffer data, which may not be written immediately to the USB flash drive. Use `fileVar:flush()` to flush this data. Using this function removes the need to close a file after writing to it, allowing the file to be left open to write more data. Data may be lost if the file is not closed or flushed before a script ends.

If there is going to be a time delay before more data is written to a file, and you want to keep the file open, flush the file after you write to it to prevent loss of data.

Example

```
local fileName = "/usb1/myfile.txt"

if fs.is_file(fileName) then
  os.remove(fileName)
  print("Removing file")
else
  print("Nothing removed")
end

errorqueue.clear()
print("\n*** io.read")
myfile, myfile_err, myfile_errnum = io.open(fileName, "w")
myfile:write("Line 1\n")
myfile:flush()
myfile:close()
do
  fileHandle = io.input(fileName)
  value = io.read("*a")
  print(value)
end
fileHandle:close()

print(errorqueue.next())
Writes data to a USB flash drive.
```

Also see

[fileVar:write\(\)](#) (on page 11-88)

[io.open\(\)](#) (on page 11-104)

[io.write\(\)](#) (on page 11-108)

fileVar:read()

This function reads data from a file.

Type	TSP-Link accessible	Affected by	Where saved	Default value
Function	No			

Usage

```
data1 = fileVar:read()
data1 = fileVar:read(format1)
data1, data2 = fileVar:read("format1", "format2")
data1, ..., datan = fileVar:read("format1", ..., "formatn")
```

<i>data1</i>	First data read from the file
<i>data2</i>	Second data read from the file
<i>datan</i>	Last data read from the file
<i>fileVar</i>	The descriptor of the file to be read
<i>format1</i>	A string or number indicating the first type of data to be read
<i>format2</i>	A string or number indicating the second type of data to be read
<i>formatn</i>	A string or number indicating the last type of data to be read
...	One or more entries (or values) separated by commas

Details

The format parameters may be any of the following:

"*n": Returns a number.

"*a": Returns the whole file, starting at the current position (returns an empty string if the current file position is at the end of the file).

"*l": Returns the next line, skipping the end of line; returns `nil` if the current file position is at the end of file.

n: Returns a string with up to *n* characters; returns an empty string if *n* is zero; returns `nil` if the current file position is at the end of file.

If no format parameters are provided, the function will perform as if the function is passed the value "*l".

Any number of format parameters may be passed to this command, each corresponding to a returned data value.

Example

```

local fileName = "/usb1/myfile.txt"

if fs.is_file(fileName) then
  os.remove(fileName)
  print("Removing file")
else
  print("Nothing removed")
end

print("fileVar:read")
myfile, myfile_err, myfile_errnum = io.open(fileName, "w")
myfile:write("Line 1")
myfile:close()
do
myfile, myfile_err, myfile_errnum = io.open(fileName, "r")
contents = myfile:read("*a")
print(contents)
end
myfile:close()
os.remove(fileName)

```

Reads data from the input file.

Also see

[fileVar.write\(\)](#) (on page 11-88)

[io.input\(\)](#) (on page 11-104)

[io.open\(\)](#) (on page 11-104)

fileVar:seek()

This function sets and gets the present position of a file.

Type	TSP-Link accessible	Affected by	Where saved	Default value
Function	No			

Usage

```

position, errorMsg = fileVar:seek()
position, errorMsg = fileVar:seek("whence")
position, errorMsg = fileVar:seek("whence", offset)

```

<i>position</i>	The new file position, measured in bytes from the beginning of the file
<i>errorMsg</i>	A string containing the error message
<i>fileVar</i>	The file descriptor variable
<i>whence</i>	A string indicating the base against which <i>offset</i> is applied; the default is "cur"
<i>offset</i>	The intended new position, measured in bytes from a base indicated by <i>whence</i> (default is 0)

Details

The *whence* parameters may be any of the following:

"set": Beginning of file

"cur": Current position

"end": End of file

If an error is encountered, it is logged to the error queue, and the command returns `nil` and the error string.

Example

```
local fileName = "/usb1/myfile.txt"

if fs.is_file(fileName) then
  os.remove(fileName)
  print("Removing file")
else
  print("Nothing removed")
end

errorqueue.clear()

print("\n*** fileVar:seek")
myfile, myfile_err, myfile_errnum = io.open(fileName, "w")
myfile:write("Line 1")
myfile:close()
do
  myfile, myfile_err, myfile_errnum = io.open(fileName, "r")
  position = myfile:seek("end", -1)
  print(position)
end
myfile:close()
os.remove(fileName)
```

Get the present position of a file.

Also see

[io.open\(\)](#) (on page 11-104)

fileVar:write()

This function writes data to a file.

Type	TSP-Link accessible	Affected by	Where saved	Default value
Function	No			

Usage

```
fileVar:write(data)
fileVar:write(data1, data2)
fileVar:write(data1, ..., datan)
```

<i>fileVar</i>	The file descriptor variable
<i>data</i>	Write all data to the file
<i>data1</i>	The first data to write to the file
<i>data2</i>	The second data to write to the file
<i>datan</i>	The last data to write to the file
...	One or more entries (or values) separated by commas

Details

This function may buffer data until a flush (`fileVar:flush()` or `io.flush()`) or close (`fileVar:close()` or `io.close()`) operation is performed.

Example

```
local fileName = "/usb1/myfile.txt"

if fs.is_file(fileName) then
    os.remove(fileName)
    print("Removing file")
else
    print("Nothing removed")
end

errorqueue.clear()

print("\n*** fileVar:write")
myfile, myfile_err, myfile_errnum = io.open(fileName, "w")
do
    myfile:write("Line 1")
end
myfile:close()
os.remove(fileName)

Write data to a file.
```

Also see

[fileVar:close\(\)](#) (on page 11-83)
[fileVar:flush\(\)](#) (on page 11-84)
[io.close\(\)](#) (on page 11-102)
[io.flush\(\)](#) (on page 11-103)
[io.open\(\)](#) (on page 11-104)

format.asciiprecision

This attribute sets the precision (number of digits) for all numbers returned in the ASCII format.

Type	TSP-Link accessible	Affected by	Where saved	Default value
Attribute (RW)	No	Instrument reset Recall setup	Not saved	6

Usage

```
precision = format.asciiprecision
format.asciiprecision = precision
```

<code>precision</code>	A number representing the number of digits to be printed for numbers printed with the <code>print()</code> , <code>printbuffer()</code> , and <code>printnumber()</code> functions; must be a number between 1 and 16
------------------------	---

Details

This attribute specifies the precision (number of digits) for numeric data printed with the `print()`, `printbuffer()`, and `printnumber()` functions. The `format.asciiprecision` attribute is only used with the ASCII format. The precision value must be a number from 0 to 16.

Note that the precision is the number of significant digits printed. There is always one digit to the left of the decimal point; be sure to include this digit when setting the precision.

Example

<pre>format.asciiprecision = 10 x = 2.54 printnumber(x) format.asciiprecision = 3 printnumber(x)</pre>	Output: 2.540000000e+00 2.54e+00
--	---

Also see

- [format.byteorder](#) (on page 11-89)
- [format.data](#) (on page 11-91)
- [print\(\)](#) (on page 11-153)
- [printbuffer\(\)](#) (on page 11-154)
- [printnumber\(\)](#) (on page 11-155)

format.byteorder

This attribute sets the binary byte order for the data that is printed using the `printnumber()` and `printbuffer()` functions.

Type	TSP-Link accessible	Affected by	Where saved	Default value
Attribute (RW)	Yes	Instrument reset Recall setup	Not saved	1 (format.LITTLEENDIAN)

Usage

```
order = format.byteorder
format.byteorder = order
```

`order`

Byte order value as follows:

- Most significant byte first: 0, `format.NORMAL`, `format.NETWORK`, or `format.BIGENDIAN`
- Least significant byte first: 1, `format.SWAPPED` or `format.LITTLEENDIAN`

Details

This attribute selects the byte order in which data is written when you are printing data values with the `printnumber()` and `printbuffer()` functions. The byte order attribute is only used with the `format.SREAL`, `format.REAL`, `format.REAL32`, and `format.REAL64` data formats.

`format.NORMAL`, `format.BIGENDIAN`, and `format.NETWORK` select the same byte order. `format.SWAPPED` and `format.LITTLEENDIAN` select the same byte order. Selecting which to use is a matter of preference.

Select the `format.SWAPPED` or `format.LITTLEENDIAN` byte order when sending data to a computer with a Microsoft Windows operating system.

Example

```
x = 1.23
format.data = format.REAL32
format.byteorder = format.LITTLEENDIAN
printnumber(x)
format.byteorder = format.BIGENDIAN
printnumber(x)
```

Output depends on the terminal program you use, but will look something like:

```
#0p??
#0??p
```

Also see

[format.asciiprecision](#) (on page 11-89)

[format.data](#) (on page 11-91)

[printbuffer\(\)](#) (on page 11-154)

[printnumber\(\)](#) (on page 11-155)

format.data

This attribute sets the data format for data that is printed using the `printnumber()` and `printbuffer()` functions.

Type	TSP-Link accessible	Affected by	Where saved	Default value
Attribute (RW)	No	Instrument reset Recall setup	Not saved	1 (format.ASCII)

Usage

```
value = format.data
format.data = value
```

value

The format to use for data, set to one of the following values:

- ASCII format: 1 or `format.ASCII`
- Single-precision IEEE Std 754 binary format: 2, `format.SREAL`, or `format.REAL32`
- Double-precision IEEE Std 754 binary format: 3, `format.REAL`, `format.REAL64`, or `format.DREAL`

Details

The precision of numeric values can be controlled with the `format.asciiprecision` attribute. The byte order of `format.SREAL`, `format.REAL`, `format.REAL32`, and `format.REAL64` can be selected with the `format.byteorder` attribute.

`REAL32` and `SREAL` select the same single precision format. `REAL` and `REAL64` select the same double precision format. They are alternative identifiers. Selecting which to use is a matter of preference.

The IEEE Std 754 binary formats use four bytes for single-precision values and eight bytes for double-precision values.

When data is written with any of the binary formats, the response message starts with `#0` and ends with a new line. When data is written with the ASCII format, elements are separated with a comma and space.

NOTE

Binary formats are not intended to be interpreted by humans.

Example

```
format.asciiprecision = 10
x = 3.14159265
format.data = format.ASCII
printnumber(x)
format.data = format.REAL64
printnumber(x)
```

Output a number represented by *x* in ASCII using a precision of 10, then output the same number in binary using double precision format.

Output:
3.141592650e+00
#0ñÔÈSû! @

Also see

[format.asciiprecision](#) (on page 11-89)

[format.byteorder](#) (on page 11-89)

[printbuffer\(\)](#) (on page 11-154)

[printnumber\(\)](#) (on page 11-155)

fs.chdir()

This function sets the current working directory.

Type	TSP-Link accessible	Affected by	Where saved	Default value
Function	Yes			

Usage

```
workingDirectory = fs.chdir("path")
```

<i>workingDirectory</i>	Returned value containing the working path
<i>path</i>	A string indicating the new working directory path

Details

The new working directory path may be absolute or relative to the current working directory.

An error is logged to the error queue if the given path does not exist.

Example

```
if fs.is_dir("/usb1/temp") == true then
  fs.chdir("/usb1/temp")
  testPath = fs.cwd()
  print(testPath)
else
  testPath = fs.cwd()
  print(testPath)
end
```

Insert a USB flash drive into the front panel of the instrument.

Verify that `/usb1/temp` is a directory and change it to be the current working directory.

Set the variable for the current working directory to be `testPath`.

The return should be:

```
/usb1/temp
```

If `/usb1/temp` is not a directory, set the variable for the current working directory to be `testPath`.

The return should be:

```
/usb1
```

Also see

None

fs.cwd()

This function returns the absolute path of the current working directory.

Type	TSP-Link accessible	Affected by	Where saved	Default value
Function	Yes			

Usage

```
path = fs.cwd()
```

<i>path</i>	The absolute path of the current working directory
-------------	--

Example

```
if fs.is_dir("/usb1/temp") == true then
  fs.chdir("/usb1/temp")
  testPath = fs.cwd()
  print(testPath)
else
  testPath = fs.cwd()
  print(testPath)
end
```

Insert a USB flash drive into the front panel of the instrument.
 Verify that /usb1/temp is a directory and change it to be the current working directory.
 Set the variable for the current working directory to be testPath.
 The return should be:
 /usb1/temp
 If /usb1/temp is not a directory, set the variable for the current working directory to be testPath.
 The return should be:
 /usb1

Also see

None

fs.is_dir()

This function tests whether or not the specified path refers to a directory.

Type	TSP-Link accessible	Affected by	Where saved	Default value
Function	Yes			

Usage

```
status = fs.is_dir("path")
```

<i>status</i>	Whether or not the given path is a directory (true or false)
<i>path</i>	The path of the file system entry to test

Details

The file system path may be absolute or relative to the current working system path.

Example 1

```
print("Is directory: ", fs.is_dir("/usb1/"))
```

Because /usb1/ is always the root directory of an inserted flash drive, you can use this command to verify that USB flash drive is inserted.

Example 2

```
if fs.is_dir("/usb1/temp") == false then
  fs.mkdir("/usb1/temp")
end
```

Insert a USB flash drive into the front panel of the instrument.

Check to see if the `temp` directory exists.

If it does not exist, create a directory named `temp`.

Also see

[fs.is_file\(\)](#) (on page 11-94)

fs.is_file()

Tests whether the specified path refers to a file (as opposed to a directory).

Type	TSP-Link accessible	Affected by	Where saved	Default value
Function	Yes			

Usage

```
status = fs.is_file("path")
```

<i>status</i>	true if the given path is a file; otherwise, false
<i>path</i>	The path of the file system entry to test

Details

The file system path may be absolute or relative to the current working system path.

Example

```
rootDirectory = "/usb1/"
print("Is file: ", fs.is_file(rootDirectory))
```

Insert a USB flash drive into the front panel of the instrument.

Set `rootDirectory` to be the USB port.

Check to see if `rootDirectory` is a file. Because `rootDirectory` was set up as a directory, the return is false.

Also see

[fs.is_dir\(\)](#) (on page 11-93)

fs.mkdir()

This function creates a directory at the specified path.

Type	TSP-Link accessible	Affected by	Where saved	Default value
Function	Yes			

Usage

```
path = fs.mkdir("newPath")
```

<i>path</i>	The returned path of the new directory
<i>newpath</i>	Location (path) of where to create the new directory

Details

The directory path may be absolute or relative to the current working directory.

An error is logged to the error queue if the parent folder of the new directory does not exist, or if a file system entry already exists at the given path.

Example

```
if fs.is_dir("/usb1/temp") == false then
    fs.mkdir("/usb1/temp")
end
```

Insert a USB flash drive into the front panel of the instrument.
 Check to see if the `temp` directory exists.
 If it does not exist, create a directory named `temp`.

Also see

[fs.rmdir\(\)](#) (on page 11-96)

fs.readdir()

This function returns a list of the file system entries in the directory.

Type	TSP-Link accessible	Affected by	Where saved	Default value
Function	Yes			

Usage

```
files = fs.readdir("path")
```

<i>files</i>	A table containing the names of all the file system entries in the specified directory
<i>path</i>	The directory path

Details

The directory path may be absolute or relative to the current working directory.

This command is nonrecursive. For example, entries in subfolders are not returned.

An error is logged to the error queue if the given path does not exist or does not represent a directory.

Example

```

rootDirectory = "/usb1/"
entries = fs.readdir(rootDirectory)
count = table.getn(entries)
print("Found a total of "..count.." files and directories")
for i = 1, count do
    print(entries[i])
end

```

Insert a USB flash drive into the front panel of the instrument.
Set `rootDirectory` to be the USB port.
Set `entries` as the variable for the file system entries in `rootDirectory`.
Return the number of files and directories in the directory.

Also see

None

fs.rmdir()

This function removes a directory from the file system.

Type	TSP-Link accessible	Affected by	Where saved	Default value
Function	Yes			

Usage

```
fs.rmdir("path")
```

<code>path</code>	The path of the directory to remove
-------------------	-------------------------------------

Details

This path may be absolute or relative to the present working directory.

An error is logged to the error queue if the given path does not exist or does not represent a directory.
An error is also logged if the directory is not empty.

Example

```

rootDirectory = "/usb1/"
tempDirectoryName = "temp"
if fs.is_dir(rootDirectory..tempDirectoryName) == false then
    fs.mkdir(rootDirectory..tempDirectoryName)
end
fs.rmdir(rootDirectory..tempDirectoryName)

```

Insert a USB flash drive into the front panel of the instrument.
Set `rootDirectory` to be the USB port.
Set `tempDirectoryName` to be equivalent to `temp`.
Check to see if `tempDirectoryName` exists.
If it does not exist, create a directory named `temp`.
Remove the directory.

Also see

[fs.mkdir\(\)](#) (on page 11-95)

gettimezone()

This function retrieves the local time zone.

Type	TSP-Link accessible	Affected by	Where saved	Default value
Function	Yes			

Usage

```
timeZone = gettimezone()
```

<i>timeZone</i>	The local time zone of the instrument
-----------------	---------------------------------------

Details

See `settimezone()` for additional details about the time zone format and a description of the fields.

timeZone can be in either of the following formats:

- If one parameter was used with `settimezone()`, the format used is:
GMThh:mm:ss
- If four parameters were used with `settimezone()`, the format used is:
GMThh:mm:ssGMThh:mm:ss,Mmm.w.dw/hh:mm:ss,Mmm.w.dw/hh:mm:ss

Example

<code>timezone = gettimezone()</code>	Reads the value of the local time zone.
---------------------------------------	---

Also see

[settimezone\(\)](#) (on page 11-173)

gm_isweep()

This KIParlib factory script function performs a linear current sweep and calculates the transconductance (G_m) at each point.

Type	TSP-Link accessible	Affected by	Where saved	Default value
Function	No			

Usage

```
gm_array, vbuf, ibuf = gm_isweep(smu, start_i, stop_i, points)
```

<i>gm_array</i>	A Lua table containing the calculated G_m values at each point
<i>vbuf</i>	A reading buffer containing the measured voltage at each point
<i>ibuf</i>	A reading buffer containing the measured current at each point
<i>smu</i>	Instrument channel (for example, <i>smua</i> refers to SMU channel A)
<i>start_i</i>	Starting current level of the sweep
<i>stop_i</i>	Ending current level of the sweep
<i>points</i>	Number of measurements between <i>start_i</i> and <i>stop_i</i> (must be ≥ 2)

Details

Output data includes transconductance values, reading buffer with measured voltages, reading buffer with measured voltages and currents.

If all parameters are omitted when this function is called, this function is executed with the parameters set to the default values.

The `gm_ismweep()` function performs a linear current sweep, measuring voltage and current, and then calculating the transconductance (G_m) at each point using the central difference method. It can return an array of G_m values, a reading buffer with the measured voltages, and a reading buffer with the measured currents.

Example

<code>gm_array = gm_ismweep(smua, 0, 0.01, 20)</code>	Source-measure unit (SMU) A returns G_m values only.
<code>gm_array, vbuf = gm_ismweep(smua, 0, 0.01, 20)</code>	SMU A returns G_m and reading buffer with measured voltages.
<code>gm_array, vbuf, ibuf = gm_ismweep(smua, 0, 0.01, 20)</code>	SMU A returns G_m and reading buffers with measured voltages and currents.

Also see

[gm_vsweep\(\)](#) (on page 11-98)

[KIParlib factory script](#) (on page 9-22)

gm_vsweep()

This KIParlib factory script function performs a linear voltage sweep and calculates the transconductance (G_m) at each point.

Type	TSP-Link accessible	Affected by	Where saved	Default value
Function	No			

Usage

```
gm_array, ibuf, vbuf = gm_vsweep(smu, start_v, stop_v, points)
```

<code>gm_array</code>	A Lua table containing the calculated G_m values at each point
<code>ibuf</code>	A reading buffer containing the measured current at each point
<code>vbuf</code>	A reading buffer containing the measured voltage at each point
<code>smu</code>	Instrument channel (for example, <code>smua</code> refers to SMU channel A)
<code>start_v</code>	Starting voltage level of the sweep
<code>stop_v</code>	Ending voltage level of the sweep
<code>points</code>	Number of measurements between <code>start_v</code> and <code>stop_v</code> (must be ≥ 2)

Details

Output data includes transconductance values, reading buffer with measured currents, reading buffer with measured currents and voltages.

The `gm_vsweep()` function performs a linear voltage sweep, measuring voltage and current, and then calculating the transconductance (G_m) at each point using the central difference method. It can return an array of G_m values, a reading buffer with the measured currents, and a reading buffer with the measured voltages.

Example

<pre>gm_array = gm_vsweep(smua, 0, 5, 20) gm_array, ibuf = gm_vsweep(smua, 0, 5, 20) gm_array, ibuf, vbuf = gm_vsweep(smua, 0, 5, 20)</pre>	<p>SMU A returns G_m values only.</p> <p>SMU A returns G_m and reading buffer with measured currents.</p> <p>SMU A returns G_m and reading buffers with measured currents and voltages.</p>
--	--

Also see

- [gm_isweep\(\)](#) (on page 11-97)
- [KIParlib factory script](#) (on page 9-22)

gpib.address

This attribute contains the GPIB address.

Type	TSP-Link accessible	Affected by	Where saved	Default value
Attribute (RW)	No	Not applicable	Nonvolatile memory	26

Usage

```
address = gpib.address
gpib.address = address
```

<i>address</i>	The GPIB address of the instrument (1 to 30)
----------------	--

Details

The address can be set to any address value from 1 to 30. However, the address must be unique in the system. It cannot conflict with an address that is assigned to another instrument or to the GPIB controller.

A new GPIB address takes effect when the command to change it is processed. If there are response messages in the output queue when this command is processed, they must be read at the new address.

If command messages are being queued (sent before this command has executed), the new settings may take effect in the middle of a subsequent command message, so care should be exercised when setting this attribute from the GPIB interface.

You should allow sufficient time for the command to be processed before attempting to communicate with the instrument again.

The `reset()` function does not affect the GPIB address.

Example

<pre>gpib.address = 26 address = gpib.address print(address)</pre>	<p>Sets the GPIB address and reads the address.</p> <p>Output:</p> <p>26</p>
--	--

Also see

- [GPIB setup](#) (on page 2-29)

i_leakage_measure()

This KHighC factory script function performs a current leakage measurement after stepping the output voltage.

Type	TSP-Link accessible	Affected by	Where saved	Default value
Function	No			

Usage

```
imeas = i_leakage_measure(smua, levelv, limiti, sourcedelay, measurei, measuredelay)
```

<i>imeas</i>	The measured current
<i>levelv</i>	Voltage level to step to when this function is called
<i>limiti</i>	Current limit setting for the voltage step
<i>sourcedelay</i>	Delay to wait before lowering the current limit for measurement
<i>measurei</i>	Current limit (and measure range); note the current limit is lower at this level and because high-capacitance mode is active, the measure range will follow
<i>measuredelay</i>	Delay to wait after lowering the current limit before taking the measurement

Details

This function causes the SMU to:

- Change its current limit to *limiti* with a voltage output of *levelv* for *sourcedelay* time, and then change its current limit to *measurei* (that also changes the measurement range to *measurei*) for *measuredelay* time
- When *measuredelay* time expires, a measurement is made and returned as *imeas*

When measuring leakage current:

- Charge the capacitor before calling this function (the output of the instrument is usually at a nonzero voltage before calling this function; when measuring leakage, this function does not charge the capacitor)
- Set *levelv* = 0

Example

```
smua.source.highc = smua.ENABLE
smua.source.levelv = 5
smua.source.output = smua.OUTPUT_ON
delay(1)
imeas = i_leakage_measure(smua, 0, 1, 300e-3, 10e-6, 0.1)
```

Enable high-capacitance mode. Charge the capacitor at 5 V for 1 second set by `delay(1)`.

The parameters passed on to the `i_leakage_measure()` function in this example are:

```
smu = smua
levelv = 0 V
limiti = 1 A
sourcedelay = 300 ms
measurei = 10 µA range
measuredelay = 100 ms
```

The levels and delays depend on the value and type of capacitor used.

Also see

- [i_leakage_threshold\(\)](#) (on page 11-101)
- [High-capacitance mode](#) (on page 4-80)
- [KIHighC factory script](#) (on page 9-21)

i_leakage_threshold()

This KIHighC factory script function measures the current and compares it to a threshold. This continues until either the measured current drops below the threshold or the timeout expires.

Type	TSP-Link accessible	Affected by	Where saved	Default value
Function	No			

Usage

```
f = i_leakage_threshold(smua, levelv, limiti, sourcedelay, measurei, measuredelay,
threshold, timeout)
```

<i>f</i>	A Boolean flag; this flag is <code>true</code> when the current is below the threshold, <code>false</code> if threshold is not reached before timeout expires
<i>levelv</i>	Voltage level to step to when this function is called
<i>limiti</i>	Current limit setting for the voltage step
<i>sourcedelay</i>	Delay to wait before lowering the current limit for measurement
<i>measurei</i>	Current limit (and measure range); note the current limit is lower at this level and because high-capacitance mode is active, the measure range will follow
<i>measuredelay</i>	Delay before the first measurement after measure range is changed
<i>threshold</i>	The specified current that establishes the test limit
<i>timeout</i>	Amount of time (in seconds) to wait for the current to drop to <i>threshold</i> after all the delays have occurred

Details

This function causes the SMU to:

- Change its current limit to *limiti* with a voltage output of *levelv* for *sourcedelay* time, and then changes its current limit to *measurei* (that also changes the measurement range to *measurei*) for *measuredelay* time.
- When *measuredelay* time expires, measurements are taken at a rate determined by the `smua.measure.nplc` setting.

When testing the leakage current threshold:

- Charge the capacitor before calling this function. The output of the instrument is usually at a non-zero voltage before calling this function; when measuring leakage, this function does not charge the capacitor.
- If testing the leakage current threshold of the device, set *levelv* = 0.

Example

```

smua.source.highc = smua.ENABLE
smua.source.levelv = 5
smua.source.output = smua.OUTPUT_ON
delay(1)
pass = i_leakage_threshold(smua, 0, 1, 300e-3, 10e-6, 100e-3, 1e-6, 1)

```

Enable high-capacitance mode.

Charge the capacitor.

The parameters passed on to the `i_threshold_measure()` function in this example are:

```

smu = smua
levelv = 0 V
limiti = 1 A
sourcedelay = 300 ms
measurei = 10 µA range
measuredelay = 100 ms
threshold = 1 µA
timeout = 1 s

```

The levels and delays depend on the value and type of capacitor used.

Sets `pass = true` if the current is measured below 1 µA in less than 1 second.

Also see

[High-capacitance mode](#) (on page 4-80)

[i_leakage_measure\(\)](#) (on page 11-100)

[High-capacitance mode](#) (on page 4-80)

[KIHighC factory script](#) (on page 9-21)

io.close()

This function closes a file.

Type	TSP-Link accessible	Affected by	Where saved	Default value
Function	Yes (see Details)			

Usage

```

io.close()
io.close(file)

```

<i>file</i>	The descriptor of the file to close
-------------	-------------------------------------

Details

If a file is not specified, the default output file closes.

Only `io.close()`, used without specifying a parameter, can be accessed from a remote node.

Example

```
testFile, testError = io.open("testfile.txt", "w")
if nil == testError then
    testFile:write("This is my test file")
    io.close(testFile)
end
```

Opens file `testfile.txt` for writing. If no errors were found while opening, writes "This is my test file" and closes the file.

Also see

[io.open\(\)](#) (on page 11-104)

io.flush()

This function saves buffered data to a file.

Type	TSP-Link accessible	Affected by	Where saved	Default value
Function	Yes			

Usage

```
io.flush()
```

Details

You must use the `io.flush()` or `io.close()` functions to write data to the file system.

NOTE

Data is not automatically written to a file when you use the `io.write()` function. The `io.write()` function buffers data; it may not be written to the USB flash drive immediately. Use the `io.flush()` function to immediately write buffered data to the drive.

This function only flushes the default output file.

Using this command removes the need to close a file after writing to it and allows it to be left open to write more data. Data may be lost if the file is not closed or flushed before an application ends. To prevent the loss of data if there is going to be a time delay before more data is written (and when you want to keep the file open and not close it), flush the file after writing to it.

Also see

[fileVar:flush\(\)](#) (on page 11-84)

[fileVar.write\(\)](#) (on page 11-88)

[io.write\(\)](#) (on page 11-108)

io.input()

This function assigns a previously opened file, or opens a new file, as the default input file.

Type	TSP-Link accessible	Affected by	Where saved	Default value
Function	Yes (see Details)			

Usage

```
fileVar = io.input()
fileVar = io.input("newfile")
```

<i>fileVar</i>	The descriptor of the input file or an error message (if the function fails)
<i>newfile</i>	A string representing the path of a file to open as the default input file, or the file descriptor of an open file to use as the default input file

Details

The *newfile* path may be absolute or relative to the current working directory.

When using this function from a remote TSP-Link® node, this command does not accept a file descriptor and does not return a value.

If the function fails, an error message is returned.

Also see

[io.open\(\)](#) (on page 11-104)

[io.output\(\)](#) (on page 11-105)

io.open()

This function opens a file for later reference.

Type	TSP-Link accessible	Affected by	Where saved	Default value
Function	No			

Usage

```
fileVar, errorMsg = io.open("path")
fileVar, errorMsg = io.open("path", "mode")
```

<i>fileVar</i>	The descriptor of the opened file
<i>errorMsg</i>	Indicates whether an error was encountered while processing the function
<i>path</i>	The path of the file to open
<i>mode</i>	A string representing the intended access mode ("r" = read, "w" = write, and "a" = append)

Details

The path to the file to open may be absolute or relative to the current working directory. If you successfully open the file, *errorMsg* is nil and *fileVar* has the descriptor that can be used to access the file.

If an error is encountered, the command returns nil for *fileVar* and an error string.

Example

```
testFile, testError = io.open("testfile.txt", "w")
if testError == nil then
    testFile:write("This is my test file")
    io.close(testFile)
end
```

Opens file `testfile.txt` for writing. If no errors were found while opening, writes "This is my test file" and closes the file.

Also see

[io.close\(\)](#) (on page 11-102)

io.output()

This function assigns a previously opened file or opens a new file as the default output file.

Type	TSP-Link accessible	Affected by	Where saved	Default value
Function	Yes (see Details)			

Usage

```
fileVar = io.output()
fileVar = io.output("newfile")
```

<i>fileVar</i>	The descriptor of the output file or an error message (if the function fails)
<i>newfile</i>	A file descriptor to assign (or the path of a file to open) as the default output file

Details

The path of the file to open may be absolute or relative to the current working directory.

When accessed from a remote node using the TSP-Link network, this command does not accept a file descriptor parameter and does not return a value.

If the function fails, an error message is returned.

Example

```
local fileName = "/usb1/myfile.txt"
if fs.is_file(fileName) then
    os.remove(fileName)
    print("Removing file")
else
    print("Nothing removed")
end
errorqueue.clear()
print("\n*** io.output")
myfile, myfile_err, myfile_errnum = io.open(fileName, "w")
myfile:write("Line 1")
myfile:close()
do
    fileHandle = io.output(fileName)
    print(fileHandle)
end
io.close(fileHandle)
print(fileHandle)
os.remove(fileName)
```

Assign the file to be the default output file.

Also see[io.input\(\)](#) (on page 11-104)[io.open\(\)](#) (on page 11-104)**io.read()**

This function reads data from the default input file.

Type	TSP-Link accessible	Affected by	Where saved	Default value
Function	Yes			

Usage

```
data1 = io.read()
data1 = io.read("format1")
data1, data2 = io.read("format1", "format2")
data1, ..., dataN = io.read("format1", ..., "formatN")
```

<i>data1</i>	The data read from the file
<i>data2</i>	The data read from the file
<i>dataN</i>	The data read from the file; the number of return values matches the number of format values given
<i>format1</i>	A string or number indicating the type of data to be read
<i>format2</i>	A string or number indicating the type of data to be read
<i>formatN</i>	A string or number indicating the type of data to be read
...	One or more entries (or values) separated by commas

Details

The format parameters may be any of the following:

Format parameter	Description
"*n"	Returns a number
"*a"	Returns the whole file, starting at the present position; returns an empty string if it is at the end of file
"*l"	Returns the next line, skipping the end of line; returns <code>nil</code> if the present file position is at the end of file
<i>N</i>	Returns a string with up to <i>N</i> characters; returns an empty string if <i>N</i> is zero (0); returns <code>nil</code> if the present file position is at the end of file

Any number of format parameters may be passed to this command, each corresponding to a returned data value.

If no format parameters are provided, the function will perform as if the function was passed the value `"*l"`.

Example

```

local fileName = "/usb1/myfile.txt"

if fs.is_file(fileName) then
    os.remove(fileName)
    print("Removing file")
else
    print("Nothing removed")
end

errorqueue.clear()

-- io.read
print("\n*** io.read")
myfile, myfile_err, myfile_errnum = io.open(fileName, "w")
myfile:write("Line 1\n")
myfile:flush()
myfile:close()
do
    fileHandle = io.input(fileName)
    value = io.read("*a")
    print(value)
end
fileHandle:close()

print(errorqueue.next())
Read data from the default input file.
    
```

Also see

None

io.type()

This function checks whether or not a given object is a file handle.

Type	TSP-Link accessible	Affected by	Where saved	Default value
Function	No			

Usage

```
type = io.type(obj)
```

<i>type</i>	Indicates whether the object is an open file handle
<i>obj</i>	Object to check

Details

Returns the string "file" if the object is an open file handle. If it is not an open file handle, nil is returned.

Example

```

local fileName = "/usb1/myfile.txt"

if fs.is_file(fileName) then
  os.remove(fileName)
  print("Removing file")
else
  print("Nothing removed")
end

errorqueue.clear()

print("\n*** io.type")
myfile, myfile_err, myfile_errnum = io.open(fileName, "w")
myfile:write("Line 1")
myfile:close()
do
  fileHandle = io.output(fileName)
  state = io.type(fileHandle)
  print(state)
end
io.close(fileHandle)
local state = io.type(fileHandle)
print(state)
os.remove(fileName)

```

Check whether or not `fileName` is a file handle.

Also see

[io.open\(\)](#) (on page 11-104)

io.write()

This function writes data to the default output file.

Type	TSP-Link accessible	Affected by	Where saved	Default value
Function	Yes			

Usage

```

io.write()
io.write(data1)
io.write(data1, data2)
io.write(data1, ..., dataN)

```

<i>data1</i>	The data to be written
<i>data2</i>	The data to be written
<i>dataN</i>	The data to be written
...	One or more values separated by commas

Details

All data parameters must be either strings or numbers.

NOTE

Data is not immediately written to a file when you use the `io.write()` function. The `io.write()` function buffers data; it may not be written to the USB flash drive immediately. Use the `io.flush()` function to immediately write buffered data to the drive.

Example

```
local fileName = "/usb1/myfile.txt"
if fs.is_file(fileName) then
    os.remove(fileName)
    print("Removing file")
else
    print("Nothing removed")
end
errorqueue.clear()
print("\n*** io.write")
myfile, myfile_err, myfile_errnum = io.open(fileName, "w")
myfile:write("Line 1")
myfile:close()
do
    fileHandle = io.output(fileName)
    io.write("Line 2")
end
io.close(fileHandle)
os.remove(fileName)
```

Writes data to the default output file.

Also see

[io.flush\(\)](#) (on page 11-103)

lan.applysettings()

This function re-initializes the LAN interface with new settings.

Type	TSP-Link accessible	Affected by	Where saved	Default value
Function	Yes			

Usage

```
lan.applysettings()
```

Details

Disconnects all existing LAN connections to the instrument and re-initializes the LAN with the present configuration settings.

This function initiates a background operation. LAN configuration could be a lengthy operation. Although the function returns immediately, the LAN initialization continues to run in the background.

Even though the LAN configuration settings may not have changed since the LAN was last connected, new settings may take effect due to the dynamic nature of dynamic host configuration protocol (DHCP) or dynamic link local addressing (DLLA) configuration.

Re-initialization takes effect even if the configuration has not changed since the last time the instrument connected to the LAN.

Example

```
lan.applysettings() Re-initialize the LAN interface with new settings.
```

Also see

None

lan.autoconnect

This attribute is used to enable or disable link monitoring.

Type	TSP-Link accessible	Affected by	Where saved	Default value
Attribute (RW)	Yes	LAN restore defaults	Nonvolatile memory	1 (lan.ENABLE)

Usage

```
state = lan.autoconnect
lan.autoconnect = state
```

<i>state</i>	LAN link monitoring state: 1 or <code>lan.ENABLE</code> : Enables automatic link reconnection and monitoring 0 or <code>lan.DISABLE</code> : Disables automatic link reconnection and monitoring
--------------	--

Details

This attribute sets the LAN link monitoring and automatic connection state.

When this is set to `lan.ENABLE`, all connections are closed if the link to the LAN is lost for more than the time specified by `lan.linktimeout`.

Set this attribute to `lan.ENABLE` to automatically reset the LAN connection after the LAN link is established.

Example

```
lan.autoconnect = lan.ENABLE Enable LANK link monitoring.
```

Also see

[lan.linktimeout](#) (on page 11-118)

[lan.restoredefaults\(\)](#) (on page 11-121)

lan.config.dns.address[N]

Configures DNS server IP addresses.

Type	TSP-Link accessible	Affected by	Where saved	Default value
Attribute (RW)	Yes	LAN restore defaults	Nonvolatile memory	"0.0.0.0"

Usage

```
dnsAddress = lan.config.dns.address[N]
lan.config.dns.address[N] = "dnsAddress"
```

<i>dnsAddress</i>	DNS server IP address
<i>N</i>	Entry index (1 or 2)

Details

This attribute is an array of DNS (domain name system) server addresses. These addresses take priority for DNS lookups and are consulted before any server addresses that are obtained using DHCP. This allows local DNS servers to be specified that take priority over DHCP-configured global DNS servers.

You can specify up to two addresses. The address specified by 1 is consulted first for DNS lookups. *dnsAddress* must be a string specifying the IP address of the DNS server in dotted decimal notation.

Unused entries are returned as "0.0.0.0" when read. To disable an entry, set its value to "0.0.0.0" or the empty string "".

Although only two addresses may be manually specified here, the instrument will use up to three DNS server addresses. If two are specified here, only one that is given by a DHCP server is used. If no entries are specified here, up to three addresses that are given by a DHCP server are used.

Example

```
dnsaddress = "164.109.48.173"
lan.config.dns.address[1] = dnsaddress
```

Set the DNS address 1 to "164.109.48.173"

Also see

- [lan.config.dns.domain](#) (on page 11-112)
- [lan.config.dns.dynamic](#) (on page 11-112)
- [lan.config.dns.hostname](#) (on page 11-113)
- [lan.config.dns.verify](#) (on page 11-114)
- [lan.restoredefaults\(\)](#) (on page 11-121)

lan.config.dns.domain

Configures the dynamic DNS domain.

Type	TSP-Link accessible	Affected by	Where saved	Default value
Attribute (RW)	Yes	LAN restore defaults	Nonvolatile memory	""

Usage

```
domain = lan.config.dns.domain
lan.config.dns.domain = "domain"
```

<i>domain</i>	Dynamic DNS registration domain; use a string of 255 characters or less
---------------	---

Details

This attribute holds the domain to request during dynamic DNS registration. Dynamic DNS registration works with DHCP to register the domain specified in this attribute with the DNS server.

The length of the fully qualified host name (combined length of the domain and host name with separator characters) must be less than or equal to 255 characters. Although up to 255 characters are allowed, you must make sure the combined length is also no more than 255 characters.

Example

<pre>print(lan.config.dns.domain)</pre>	Outputs the present dynamic DNS domain. For example, if the domain is "Matrix", the response would be: Matrix
---	--

Also see

[lan.config.dns.dynamic](#) (on page 11-112)
[lan.config.dns.hostname](#) (on page 11-113)
[lan.config.dns.verify](#) (on page 11-114)
[lan.restoredefaults\(\)](#) (on page 11-121)

lan.config.dns.dynamic

Enables or disables the dynamic DNS registration.

Type	TSP-Link accessible	Affected by	Where saved	Default value
Attribute (RW)	Yes	LAN restore defaults	Nonvolatile memory	1 (lan.ENABLE)

Usage

```
state = lan.config.dns.dynamic
lan.config.dns.dynamic = state
```

<i>state</i>	The dynamic DNS registration state. It may be one of the following values: <ul style="list-style-type: none"> ▪ 1 or lan.ENABLE: Enabled ▪ 0 or lan.DISABLE: Disabled
--------------	---

Details

Dynamic DNS registration works with DHCP to register the host name with the DNS server. The host name is specified in the `lan.config.dns.hostname` attribute.

Example

```
print(lan.config.dns.dynamic)
```

Outputs the dynamic registration state.
If dynamic DNS registration is enabled, the response is:
1.00000e+00

Also see

[lan.config.dns.hostname](#) (on page 11-113)

[lan.restoredefaults\(\)](#) (on page 11-121)

lan.config.dns.hostname

This attribute defines the dynamic DNS host name.

Type	TSP-Link accessible	Affected by	Where saved	Default value
Attribute (RW)	Yes	Not applicable	Nonvolatile memory	Instrument specific (see Details)

Usage

```
hostName = lan.config.dns.hostname
lan.config.dns.hostname = "hostName"
```

<i>hostName</i>	The host name to use for dynamic DNS registration; the host name must: <ul style="list-style-type: none"> ▪ be a string of 63 characters or less ▪ start with a letter ▪ end with a letter or digit ▪ contain only letters, digits, and hyphens
-----------------	---

Details

This attribute holds the host name to request during dynamic DNS registration. Dynamic DNS registration works with DHCP to register the host name specified in this attribute with the DNS server.

The factory default value for *hostName* is "k-<model number>-<serial number>", where <model number> and <serial number> are replaced with the actual model number and serial number of the instrument (for example, "k-2601B-PULSE-1234567"). Note that hyphens separate the characters of *hostName*.

The length of the fully qualified host name (combined length of the domain and host name with separator characters) must be less than or equal to 255 characters. Although up to 63 characters can be entered here, care must be taken to be sure the combined length is no more than 255 characters.

Setting this attribute to an empty string (in other words, setting this attribute to a string of length zero, or one consisting entirely of whitespace characters) will revert the host name to the factory default value.

Example

```
print(lan.config.dns.hostname)
```

Outputs the present dynamic DNS host name.

Also see

- [lan.config.dns.domain](#) (on page 11-112)
- [lan.config.dns.dynamic](#) (on page 11-112)
- [lan.restoredefaults\(\)](#) (on page 11-121)

lan.config.dns.verify

This attribute defines the DNS host name verification state.

Type	TSP-Link accessible	Affected by	Where saved	Default value
Attribute (RW)	Yes	LAN restore defaults	Nonvolatile memory	1 (lan.ENABLE)

Usage

```
state = lan.config.dns.verify
lan.config.dns.verify = state
```

<i>state</i>	DNS hostname verification state: <ul style="list-style-type: none"> ▪ 1 or lan.ENABLE: DNS host name verification enabled ▪ 0 or lan.DISABLE: DNS host name verification disabled
--------------	---

Details

When this is enabled, the instrument performs DNS lookups to verify that the DNS host name matches the value specified by `lan.config.dns.hostname`.

Example

<pre>print(lan.config.dns.verify)</pre>	Outputs the present DNS host name verification state. If it is enabled, the output is: 1.00000e+00
---	--

Also see

- [lan.config.dns.hostname](#) (on page 11-113)
- [lan.restoredefaults\(\)](#) (on page 11-121)

lan.config.duplex

This attribute defines the LAN duplex mode.

Type	TSP-Link accessible	Affected by	Where saved	Default value
Attribute (RW)	Yes	LAN restore defaults	Nonvolatile memory	1 (lan.FULL)

Usage

```
duplex = lan.config.duplex
lan.config.duplex = duplex
```

<i>duplex</i>	LAN duplex setting can be one of the following values: <ul style="list-style-type: none"> ▪ 1 or lan.FULL: Selects full-duplex operation ▪ 0 or lan.HALF: Selects half-duplex operation
---------------	---

Details

This attribute does not indicate the actual setting currently in effect. Use the `lan.status.duplex` attribute to determine the present operating state of the LAN.

Example

```
lan.config.duplex = lan.FULL
```

Select the LAN duplex mode to full.

Also see

[lan.restoredefaults\(\)](#) (on page 11-121)

lan.config.gateway

This attribute contains the LAN default gateway address.

Type	TSP-Link accessible	Affected by	Where saved	Default value
Attribute (RW)	Yes	LAN restore defaults	Nonvolatile memory	"0.0.0.0"

Usage

```
gatewayAddress = lan.config.gateway
lan.config.gateway = "gatewayAddress"
```

<i>gatewayAddress</i>	LAN default gateway address; must be a string specifying the default gateway's IP address in dotted decimal notation
-----------------------	--

Details

This attribute specifies the default gateway IP address to use when manual or DLLA configuration methods are used to configure the LAN. If DHCP is enabled, this setting is ignored.

This attribute does not indicate the actual setting that is presently in effect. Use the `lan.status.gateway` attribute to determine the present operating state of the LAN.

The IP address must be formatted in four groups of numbers, each separated by a decimal.

Example

```
print(lan.config.gateway)
```

Outputs the default gateway address. For example, you might see the output:
192.168.0.1

Also see

[lan.restoredefaults\(\)](#) (on page 11-121)

[lan.status.gateway](#) (on page 11-124)

lan.config.ipaddress

This command specifies the LAN IP address.

Type	TSP-Link accessible	Affected by	Where saved	Default value
Attribute (RW)	Yes	LAN restore defaults	Nonvolatile memory	"192.168.0.2"

Usage

```
ipAddress = lan.config.ipaddress
lan.config.ipaddress = "ipAddress"
```

<i>ipAddress</i>	LAN IP address; must be a string specifying the IP address in dotted decimal notation
------------------	---

Details

This command specifies the LAN IP address to use when the LAN is configured using the manual configuration method. This setting is ignored when DLLA or DHCP is used.

This attribute does not indicate the actual setting that is presently in effect. Use the `lan.status.ipaddress` attribute to determine the present operating state of the LAN.

Example

```
ipaddress = lan.config.ipaddress
```

Retrieves the presently set LAN IP address.

Also see

[lan.restoredefaults\(\)](#) (on page 11-121)

[lan.status.ipaddress](#) (on page 11-124)

lan.config.method

This attribute contains the LAN settings configuration method.

Type	TSP-Link accessible	Affected by	Where saved	Default value
Attribute (RW)	Yes	LAN restore defaults	Nonvolatile memory	0 (lan.AUTO)

Usage

```
method = lan.config.method
lan.config.method = method
```

<i>method</i>	<p>The method for configuring LAN settings; it can be one of the following values:</p> <ul style="list-style-type: none"> ▪ 0 or <code>lan.AUTO</code>: Selects automatic sequencing of configuration methods ▪ 1 or <code>lan.MANUAL</code>: Use only manually specified configuration settings
---------------	--

Details

This attribute controls how the LAN IP address, subnet mask, default gateway address, and DNS server addresses are determined.

When method is `lan.AUTO`, the instrument first attempts to configure the LAN settings using dynamic host configuration protocol (DHCP). If DHCP fails, it tries dynamic link local addressing (DLLA). If DLLA fails, it uses the manually specified settings.

When method is `lan.MANUAL`, only the manually specified settings are used. Neither DHCP nor DLLA are attempted.

Example

```
print(lan.config.method)
```

Outputs the current method.
For example:
1.00000e+00

Also see

[lan.restoredefaults\(\)](#) (on page 11-121)

lan.config.speed

This attribute contains the LAN speed used when restarting in manual configuration mode.

Type	TSP-Link accessible	Affected by	Where saved	Default value
Attribute (RW)	Yes	LAN restore defaults	Nonvolatile memory	100 (100 Mbps)

Usage

```
speed = lan.config.speed
lan.config.speed = speed
```

<code>speed</code>	LAN speed setting in Mbps (10 or 100)
--------------------	---------------------------------------

Details

This attribute stores the speed that will be used if the LAN is restarted for manual configuration operation.

This attribute does not indicate the actual setting presently in effect. Use the `lan.status.speed` attribute to determine the present operating state of the LAN.

The LAN speed is measured in megabits per second (Mbps).

Example

```
lan.config.speed = 100
```

Configure LAN speed for 100.

Also see

[lan.restoredefaults\(\)](#) (on page 11-121)

[lan.status.speed](#) (on page 11-127)

lan.config.subnetmask

This attribute contains the LAN subnet mask.

Type	TSP-Link accessible	Affected by	Where saved	Default value
Attribute (RW)	Yes	LAN restore defaults	Nonvolatile memory	"255.255.255.0"

Usage

```
mask = lan.config.subnetmask
lan.config.subnetmask = "mask"
```

<code>mask</code>	String that specifies the LAN subnet mask value in dotted decimal notation
-------------------	--

Details

This attribute specifies the LAN subnet mask that will be used when the manual configuration method is used to configure the LAN. This setting is ignored when DLLA or DHCP is used.

This attribute does not indicate the actual setting presently in effect. Use the `lan.status.subnetmask` attribute to determine the present operating state of the LAN.

Example

<code>print(lan.config.subnetmask)</code>	Outputs the LAN subnet mask, such as: 255.255.255.0
---	--

Also see

[lan.restoredefaults\(\)](#) (on page 11-121)
[lan.status.subnetmask](#) (on page 11-128)

lan.linktimeout

This attribute contains the LAN link timeout period.

Type	TSP-Link accessible	Affected by	Where saved	Default value
Attribute (RW)	Yes	LAN restore defaults	Nonvolatile memory	20 (20 s)

Usage

```
timeout = lan.linktimeout
lan.linktimeout = timeout
```

<code>timeout</code>	The LAN link monitor time-out period (in seconds)
----------------------	---

Details

You must enable the command `lan.autoconnect` before you can use this attribute.

The `timeout` value represents the amount of time that passes before the instrument disconnects from the LAN due to the loss of the LAN link integrity.

The LAN interface does not disconnect if the connection to the LAN is reestablished before the `timeout` value expires.

If the LAN link integrity is not restored before the `timeout` value expires, the instrument begins to monitor for a new connection.

Example

```
print(lan.linktimeout)
```

 Outputs the present LAN link timeout setting.
Also see
[lan.autoconnect](#) (on page 11-110)

[lan.restoredefaults\(\)](#) (on page 11-121)

lan.lxidomain

This attribute contains the LXI domain.

Type	TSP-Link accessible	Affected by	Where saved	Default value
Attribute (RW)	Yes	LAN restore defaults	Nonvolatile memory	0

Usage

```
domain = lan.lxidomain
lan.lxidomain = domain
```

```
domain
```

 The LXI domain number (0 to 255)
Details

This attribute sets the LXI domain number.

All outgoing LXI packets are generated with this domain number. All inbound LXI packets are ignored unless they have this domain number.

Example

```
print(lan.lxidomain)
```

 Displays the LXI domain.
Also see

None

lan.nagle

This attribute controls the state of the LAN Nagle algorithm.

Type	TSP-Link accessible	Affected by	Where saved	Default value
Attribute (RW)	Yes	Power cycle	Not saved	0 (lan.DISABLE)

Usage

```
state = lan.nagle
lan.nagle = state
```

`state`

The state of the Nagle algorithm:

- 1 or `lan.ENABLE`: Enable the LAN Nagle algorithm for TCP connections
- 0 or `lan.DISABLE`: Disable the Nagle algorithm for TCP connections

Details

This attribute enables or disables the use of the LAN Nagle algorithm on transmission control protocol (TCP) connections.

Also see

[lan.restoredefaults\(\)](#) (on page 11-121)

lan.reset()

This function resets the LAN interface.

Type	TSP-Link accessible	Affected by	Where saved	Default value
Function	Yes			

Usage

```
lan.reset()
```

Details

This function resets the LAN interface. It performs the commands `lan.restoredefaults()` and `lan.applysettings()`.

Also see

[lan.applysettings\(\)](#) (on page 11-109)

[lan.restoredefaults\(\)](#) (on page 11-121)

lan.restoredefaults()

This function resets LAN settings to default values.

Type	TSP-Link accessible	Affected by	Where saved	Default value
Function	Yes			

Usage

```
lan.restoredefaults()
```

Details

The settings that are restored are shown in the following table.

Settings that are restored to default	
Attribute	Default setting
lan.autoconnect	lan.ENABLE
lan.config.dns.address[N]	"0.0.0.0"
lan.config.dns.domain	""
lan.config.dns.dynamic	lan.ENABLE
lan.config.dns.hostname	"K-<model number>-<serial number>"
lan.config.dns.verify	lan.ENABLE
lan.config.duplex	lan.FULL
lan.config.gateway	"0.0.0.0"
lan.config.ipaddress	"192.168.0.2"
lan.config.method	lan.AUTO
lan.config.speed	100
lan.config.subnetmask	"255.255.255.0"
lan.linktimeout	20 (seconds)
lan.lxidomain	0
lan.nagle	lan.DISABLE
lan.timedwait	20 (seconds)

This command is run when `lan.reset()` is sent.

Example

<code>lan.restoredefaults()</code>	Restores the LAN defaults.
------------------------------------	----------------------------

Also see

[lan.reset\(\)](#) (on page 11-120)

[localnode.password](#) (on page 11-141)

lan.status.dns.address[N]

This attribute contains the DNS server IP addresses.

Type	TSP-Link accessible	Affected by	Where saved	Default value
Attribute (R)	Yes	Not applicable	Not applicable	Not applicable

Usage

```
dnsAddress = lan.status.dns.address[N]
```

<i>dnsAddress</i>	DNS server IP address
<i>N</i>	Entry index (1, 2, or 3)

Details

This attribute is an array of DNS server addresses. The instrument can use up to three addresses.

Unused or disabled entries are returned as "0.0.0.0" when read. The *dnsAddress* returned is a string specifying the IP address of the DNS server in dotted decimal notation.

You can only specify two addresses manually. However, the instrument uses up to three DNS server addresses. If two are specified, only the one given by a DHCP server is used. If no entries are specified, up to three address given by a DHCP server are used.

The value of `lan.status.dns.address[1]` is referenced first for all DNS lookups. The values of `lan.status.dns.address[2]` and `lan.status.dns.address[3]` are referenced second and third, respectively.

Example

```
print(lan.status.dns.address[1])
```

Outputs DNS server address 1, for example:
164.109.48.173

Also see

[lan.status.dns.name](#) (on page 11-122)

lan.status.dns.name

This attribute contains the present DNS fully qualified host name.

Type	TSP-Link accessible	Affected by	Where saved	Default value
Attribute (R)	Yes	Not applicable	Not applicable	Not applicable

Usage

```
hostName = lan.status.dns.name
```

<i>hostName</i>	Fully qualified DNS host name that can be used to connect to the instrument
-----------------	---

Details

A fully qualified domain name (FQDN), sometimes referred to as an absolute domain name, is a domain name that specifies its exact location in the tree hierarchy of the Domain Name System (DNS).

A FQDN is the complete domain name for a specific computer or host on the LAN. The FQDN consists of two parts: the host name and the domain name.

If the DNS host name for an instrument is not found, this attribute stores the IP address in dotted decimal notation.

Example

```
print(lan.status.dns.name)      Outputs the dynamic DNS host name.
```

Also see

- [lan.config.dns.address\[N\]](#) (on page 11-111)
- [lan.config.dns.hostname](#) (on page 11-113)

lan.status.duplex

This attribute contains the duplex mode presently in use by the LAN interface.

Type	TSP-Link accessible	Affected by	Where saved	Default value
Attribute (R)	Yes	Not applicable	Not applicable	Not applicable

Usage

```
duplex = lan.status.duplex
```

<i>duplex</i>	LAN duplex setting can be one of the following values: <ul style="list-style-type: none"> ▪ 0 or <code>lan.HALF</code>: half-duplex operation ▪ 1 or <code>lan.FULL</code>: full-duplex operation
---------------	---

Example

```
print(lan.status.duplex)      Outputs the present LAN duplex mode, such as:  
1.00000e+00
```

Also see

None

lan.status.gateway

This attribute contains the gateway address presently in use by the LAN interface.

Type	TSP-Link accessible	Affected by	Where saved	Default value
Attribute (R)	Yes	Not applicable	Not applicable	Not applicable

Usage

```
gatewayAddress = lan.status.gateway
```

<code>gatewayAddress</code>	LAN gateway address presently being used
-----------------------------	--

Details

The value of `gatewayAddress` is a string that indicates the IP address of the gateway in dotted decimal notation.

Example

<code>print(lan.status.gateway)</code>	Outputs the gateway address, such as: 192.168.0.1
--	--

Also see

[lan.config.gateway](#) (on page 11-115)

lan.status.ipaddress

This attribute contains the LAN IP address presently in use by the LAN interface.

Type	TSP-Link accessible	Affected by	Where saved	Default value
Attribute (R)	Yes	Not applicable	Not applicable	Not applicable

Usage

```
ipAddress = lan.status.ipaddress
```

<code>ipAddress</code>	LAN IP address specified in dotted decimal notation
------------------------	---

Details

The IP address is a character string that represents the IP address assigned to the instrument.

Example

<code>print(lan.status.ipaddress)</code>	Outputs the LAN IP address currently in use, such as: 192.168.0.2
--	--

Also see

[lan.config.ipaddress](#) (on page 11-116)

lan.status.macaddress

This attribute contains the LAN MAC address.

Type	TSP-Link accessible	Affected by	Where saved	Default value
Attribute (R)	Yes	Not applicable	Not applicable	Not applicable

Usage

```
macAddress = lan.status.macaddress
```

<code>macAddress</code>	The instrument MAC address
-------------------------	----------------------------

Details

The MAC address is a character string representing the MAC address of the instrument in hexadecimal notation. The string includes colons that separate the address octets (see Example).

Example

<pre>print(lan.status.macaddress)</pre>	Outputs the MAC address of the instrument, for example: 08:00:11:00:00:57
---	--

Also see

None

lan.status.port.dst

This attribute contains the LAN dead socket termination port number.

Type	TSP-Link accessible	Affected by	Where saved	Default value
Attribute (R)	Yes	Not applicable	Not applicable	Not applicable

Usage

```
port = lan.status.port.dst
```

<code>port</code>	Dead socket termination socket port number
-------------------	--

Details

This attribute holds the TCP port number used to reset all other LAN socket connections.

To reset all LAN connections, open a connection to the DST port number.

Example

<pre>print(lan.status.port.dst)</pre>	Outputs the LAN dead socket termination port number, such as: 5.03000e+03
---------------------------------------	--

Also see

None

lan.status.port.rawsocket

This attribute contains the LAN raw socket connection port number.

Type	TSP-Link accessible	Affected by	Where saved	Default value
Attribute (R)	Yes	Not applicable	Not applicable	Not applicable

Usage

```
port = lan.status.port.rawsocket
```

<code>port</code>	Raw socket port number
-------------------	------------------------

Details

The TCP port number used to connect the instrument and to control the instrument over a raw socket communication interface.

Example

```
print(lan.status.port.rawsocket)
```

Outputs the LAN raw socket port number, such as:
5.02500e+03

Also see

None

lan.status.port.telnet

This attribute contains the LAN Telnet connection port number.

Type	TSP-Link accessible	Affected by	Where saved	Default value
Attribute (R)	Yes	Not applicable	Not applicable	Not applicable

Usage

```
port = lan.status.port.telnet
```

<code>port</code>	Telnet port number
-------------------	--------------------

Details

This attribute holds the TCP port number used to connect to the instrument to control it over a Telnet interface.

Example

```
print(lan.status.port.telnet)
```

Get the LAN Telnet connection port number.
Output:
2.30000e+01

Also see

None

lan.status.port.vxi11

This attribute contains the LAN VXI-11 connection port number.

Type	TSP-Link accessible	Affected by	Where saved	Default value
Attribute (R)	Yes	Not applicable	Not applicable	Not applicable

Usage

```
port = lan.status.port.vxi11
```

<code>port</code>	LAN VXI-11 port number
-------------------	------------------------

Details

This attribute stores the TCP port number used to connect to the instrument over a VXI-11 interface.

Example

```
print(lan.status.port.vxi11)
```

Outputs the VXI-11 number, such as:
1.02400e+03

Also see

None

lan.status.speed

This attribute contains the LAN speed.

Type	TSP-Link accessible	Affected by	Where saved	Default value
Attribute (R)	Yes	Not applicable	Not applicable	Not applicable

Usage

```
speed = lan.status.speed
```

<code>speed</code>	LAN speed in Mbps, either 10 or 100
--------------------	-------------------------------------

Details

This attribute indicates the transmission speed currently in use by the LAN interface.

Example

```
print(lan.status.speed)
```

Outputs the transmission speed of the instrument presently in use, such as:
1.00000e+02

Also see

None

lan.status.subnetmask

This attribute contains the LAN subnet mask that is presently in use by the LAN interface.

Type	TSP-Link accessible	Affected by	Where saved	Default value
Attribute (R)	Yes	Not applicable	Not applicable	Not applicable

Usage

```
mask = lan.status.subnetmask
```

<code>mask</code>	A string specifying the subnet mask in dotted decimal notation
-------------------	--

Details

Use this attribute to determine the present operating state of the LAN. This attribute will return the present LAN subnet mask value if the LAN is manually configured, or when DLLA or DHCP is used.

Example

<pre>print(lan.status.subnetmask)</pre>	Outputs the subnet mask of the instrument that is presently in use, such as: 255.255.255.0
---	---

Also see

[lan.config.subnetmask](#) (on page 11-118)

lan.timedwait

This attribute contains the LAN timed-wait state interval.

Type	TSP-Link accessible	Affected by	Where saved	Default value
Attribute (RW)	Yes	LAN restore defaults	Nonvolatile memory	20 (20 s)

Usage

```
timeout = lan.timedwait
lan.timedwait = timeout
```

<code>timeout</code>	The LAN timed-wait state interval in seconds
----------------------	--

Details

This attribute controls the amount of time that resources are allocated to closed TCP connections. When a TCP connection is closed, the connection is put in a timed-wait state and resources remain allocated for the connection until the timed-wait state ends. During the timed-wait interval, the instrument processes delayed packets that arrive after the connection is closed.

Use this attribute to tailor the timed-wait state interval for the instrument.

Example

<pre>lan.timedwait = 30</pre>	Set the amount of time resources are allocated to TCP connection to 30 s.
-------------------------------	---

Also see

[lan.restoredefaults\(\)](#) (on page 11-121)

lan.trigger[N].assert()

This function simulates the occurrence of the trigger and generates the corresponding event ID.

Type	TSP-Link accessible	Affected by	Where saved	Default value
Function	Yes			

Usage

```
lan.trigger[N].assert()
```

<i>N</i>	The LAN event number (1 to 8)
----------	-------------------------------

Details

Generates and sends a LAN trigger packet for the LAN event number specified.

Sets the pseudo line state to the appropriate state.

The following indexes provide the listed LXI events:

- 1:LAN0
- 2:LAN1
- 3:LAN2
- ...
- 8:LAN7

Example

<code>lan.trigger[5].assert()</code>	Creates a trigger with LAN packet 5.
--------------------------------------	--------------------------------------

Also see

[lan.lxidomain](#) (on page 11-119)

[lan.trigger\[N\].clear\(\)](#) (on page 11-129)

[lan.trigger\[N\].mode](#) (on page 11-133)

[lan.trigger\[N\].overrun](#) (on page 11-134)

[lan.trigger\[N\].stimulus](#) (on page 11-136)

[lan.trigger\[N\].wait\(\)](#) (on page 11-137)

[Understanding hardware value and pseudo line state](#) (on page 6-21)

lan.trigger[N].clear()

This function clears the event detector for a LAN trigger.

Type	TSP-Link accessible	Affected by	Where saved	Default value
Function	Yes			

Usage

```
lan.trigger[N].clear()
```

<i>N</i>	The LAN event number (1 to 8) to clear
----------	--

Details

The trigger event detector enters the detected state when an event is detected. This function clears a trigger event detector and discards the history of the trigger packet.

This function clears all overruns associated with this LAN trigger.

Example

```
lan.trigger[5].clear()
```

Clears the event detector with LAN packet 5.

Also see

[lan.trigger\[N\].assert\(\)](#) (on page 11-129)

[lan.trigger\[N\].overrun](#) (on page 11-134)

[lan.trigger\[N\].stimulus](#) (on page 11-136)

[lan.trigger\[N\].wait\(\)](#) (on page 11-137)

lan.trigger[N].connect()

This function prepares the event generator for outgoing trigger events.

Type	TSP-Link accessible	Affected by	Where saved	Default value
Function	Yes			

Usage

```
lan.trigger[N].connect()
```

N The LAN event number (1 to 8)

Details

This command prepares the event generator to send event messages. For TCP connections, this opens the TCP connection.

The event generator automatically disconnects when either the protocol or IP address for this event is changed.

Example

```
lan.trigger[1].protocol = lan.MULTICAST
lan.trigger[1].connect()
lan.trigger[1].assert()
```

Set the protocol for LAN trigger 1 to be multicast when sending LAN triggers. Then, after connecting the LAN trigger, send a message on LAN trigger 1 by asserting it.

Also see

[lan.trigger\[N\].assert\(\)](#) (on page 11-129)

[lan.trigger\[N\].ipaddress](#) (on page 11-132)

[lan.trigger\[N\].overrun](#) (on page 11-134)

[lan.trigger\[N\].protocol](#) (on page 11-135)

[lan.trigger\[N\].stimulus](#) (on page 11-136)

[lan.trigger\[N\].wait\(\)](#) (on page 11-137)

lan.trigger[N].connected

This attribute stores the LAN event connection state.

Type	TSP-Link accessible	Affected by	Where saved	Default value
Attribute (R)	Yes	Not applicable	Not applicable	Not applicable

Usage

```
connected = lan.trigger[N].connected
```

<i>connected</i>	The LAN event connection state: <ul style="list-style-type: none"> ▪ true: Connected ▪ false: Not connected
<i>N</i>	The LAN event number (1 to 8)

Details

This read-only attribute is set to `true` when the LAN trigger is connected and ready to send trigger events following a successful `lan.trigger[N].connect()` command; if the LAN trigger is not ready to send trigger events, this value is `false`.

This attribute is also `false` when either `lan.trigger[N].protocol` or `lan.trigger[N].ipaddress` attributes are changed or the remote connection closes the connection.

Example

```
lan.trigger[1].protocol = lan.MULTICAST
print(lan.trigger[1].connected)
```

Outputs `true` if connected, or `false` if not connected.
Example output:
`false`

Also see

- [lan.trigger\[N\].connect\(\)](#) (on page 11-130)
- [lan.trigger\[N\].ipaddress](#) (on page 11-132)
- [lan.trigger\[N\].protocol](#) (on page 11-135)

lan.trigger[N].disconnect()

This function disconnects the LAN trigger.

Type	TSP-Link accessible	Affected by	Where saved	Default value
Function	Yes			

Usage

```
lan.trigger[N].disconnect()
```

<i>N</i>	The LAN event number (1 to 8)
----------	-------------------------------

Details

For TCP connections, this closes the TCP connection.

The LAN trigger automatically disconnects when either the `lan.trigger[N].protocol` or `lan.trigger[N].ipaddress` attributes for this event are changed.

Also see

[lan.trigger\[N\].ipaddress](#) (on page 11-132)

[lan.trigger\[N\].protocol](#) (on page 11-135)

lan.trigger[N].EVENT_ID

This constant is the event identifier used to route the LAN trigger to other subsystems (using stimulus properties).

Type	TSP-Link accessible	Affected by	Where saved	Default value
Constant	Yes			

Usage

```
lan.trigger[N].EVENT_ID
```

<i>N</i>	The LAN event number (1 to 8)
----------	-------------------------------

Details

Set the stimulus of any trigger event detector to the value of this constant to have it respond to incoming LAN trigger packets.

Example

```
digio.trigger[14].stimulus = lan.trigger[1].EVENT_ID
```

Route occurrences of triggers on LAN trigger 1 to digital I/O trigger 14.

Also see

None

lan.trigger[N].ipaddress

This attribute specifies the address (in dotted-decimal format) of UDP or TCP listeners.

Type	TSP-Link accessible	Affected by	Where saved	Default value
Attribute (RW)	Yes	Instrument reset LAN trigger N reset Recall setup	Not saved	"0.0.0.0"

Usage

```
ipAddress = lan.trigger[N].ipaddress
lan.trigger[N].ipaddress = "ipAddress"
```

<i>ipAddress</i>	The LAN address for this attribute as a string in dotted decimal notation
<i>N</i>	The LAN event number (1 to 8)

Details

Sets the IP address for outgoing trigger events.

Set to "0.0.0.0" for multicast.

After changing this setting, the `lan.trigger[N].connect()` command must be called before outgoing messages can be sent.

Example

```
lan.trigger[3].protocol = lan.TCP
lan.trigger[3].ipaddress = "192.168.1.100"
lan.trigger[3].connect()
```

Set the protocol for LAN trigger 3 to be `lan.TCP` when sending LAN triggers. Use IP address "192.168.1.100" to connect the LAN trigger.

Also see

[lan.trigger\[N\].connect\(\)](#) (on page 11-130)

lan.trigger[N].mode

This attribute sets the trigger operation and detection mode of the specified LAN event.

Type	TSP-Link accessible	Affected by	Where saved	Default value
Attribute (RW)	Yes	Instrument reset LAN trigger N reset Recall setup	Not saved	0 (lan.TRIG_EITHER)

Usage

```
mode = lan.trigger[N].mode
lan.trigger[N].mode = mode
```

<i>mode</i>	A number representing the trigger mode (0 to 7); see the Details section for more information
<i>N</i>	A number representing the LAN event number (1 to 8)

Details

This command controls how the trigger event detector and the output trigger generator operate on the given trigger. These settings are intended to provide behavior similar to the digital I/O triggers.

LAN trigger mode values			
Mode	Number	Trigger packets detected as input	LAN trigger packet generated for output with a...
lan.TRIG_EITHER	0	Rising or falling edge (positive or negative state)	negative state
lan.TRIG_FALLING	1	Falling edge (negative state)	negative state
lan.TRIG_RISING	2	Rising edge (positive state)	positive state
lan.TRIG_RISINGA	3	Rising edge (positive state)	positive state
lan.TRIG_RISINGM	4	Rising edge (positive state)	positive state
lan.TRIG_SYNCHRONOUS	5	Falling edge (negative state)	positive state
lan.TRIG_SYNCHRONOUSA	6	Falling edge (negative state)	positive state
lan.TRIG_SYNCHRONOUSM	7	Rising edge (positive state)	negative state

`lan.TRIG_RISING` and `lan.TRIG_RISINGA` are the same.

`lan.TRIG_RISING` and `lan.TRIG_RISINGM` are the same.

Use of either `lan.TRIG_SYNCHRONOUSA` or `lan.TRIG_SYNCHRONOUSM` over `lan.TRIG_SYNCHRONOUS` is preferred, as `lan.TRIG_SYNCHRONOUS` is provided for compatibility with older firmware.

Example

```
print(lan.trigger[1].mode)
```

Outputs the present LAN trigger mode of LAN event 1.

Also see

[Digital I/O](#) (on page 6-36)

[TSP-Link system expansion interface](#) (on page 10-45)

lan.trigger[N].overrun

This attribute contains the overrun status of the LAN event detector.

Type	TSP-Link accessible	Affected by	Where saved	Default value
Attribute (R)	Yes	LAN trigger N clear LAN trigger N reset Instrument reset Recall setup	Not applicable	Not applicable

Usage

```
overrun = lan.trigger[N].overrun
```

<code>overrun</code>	The trigger overrun state for the specified LAN packet (<code>true</code> or <code>false</code>)
<code>N</code>	The LAN event number (1 to 8)

Details

This command indicates whether an event has been ignored because the event detector was already in the detected state when the event occurred.

This is an indication of the state of the event detector built into the synchronization line itself. It does not indicate if an overrun occurred in any other part of the trigger model, or in any other construct that is monitoring the event.

It also is not an indication of an output trigger overrun. Output trigger overrun indications are provided in the status model.

Example

```
overrun = lan.trigger[5].overrun
print(overrun)
```

Checks the overrun status of a trigger on LAN5 and outputs the value, such as:
`false`

Also see

[lan.trigger\[N\].assert\(\)](#) (on page 11-129)

[lan.trigger\[N\].clear\(\)](#) (on page 11-129)

[lan.trigger\[N\].stimulus](#) (on page 11-136)

[lan.trigger\[N\].wait\(\)](#) (on page 11-137)

lan.trigger[N].protocol

This attribute sets the LAN protocol to use for sending trigger messages.

Type	TSP-Link accessible	Affected by	Where saved	Default value
Attribute (RW)	Yes	Instrument reset LAN trigger N reset Recall setup	Not saved	0 (lan.TCP)

Usage

```
protocol = lan.trigger[N].protocol
lan.trigger[N].protocol = protocol
```

<i>protocol</i>	The protocol to use for messages from the trigger: <ul style="list-style-type: none"> ▪ 0 or lan.TCP ▪ 1 or lan.UDP ▪ 2 or lan.MULTICAST
<i>N</i>	The LAN event number (1 to 8)

Details

The LAN trigger listens for trigger messages on all supported protocols, but uses the designated protocol for sending outgoing messages. After changing this setting, `lan.trigger[N].connect()` must be called before outgoing event messages can be sent.

When the `lan.MULTICAST` protocol is selected, the `lan.trigger[N].ipaddress` attribute is ignored and event messages are sent to the multicast address 224.0.23.159.

Example

<code>print(lan.trigger[1].protocol)</code>	Get LAN protocol to use for sending trigger messages for LAN event 1.
---	---

Also see

- [lan.trigger\[N\].connect\(\)](#) (on page 11-130)
- [lan.trigger\[N\].ipaddress](#) (on page 11-132)

lan.trigger[N].pseudostate

This attribute sets the simulated line state for the LAN trigger.

Type	TSP-Link accessible	Affected by	Where saved	Default value
Attribute (RW)	Yes	Instrument reset LAN trigger N reset Recall setup	Not saved	1

Usage

```
pseudostate = lan.trigger[N].pseudostate
lan.trigger[N].pseudostate = pseudostate
```

<i>pseudostate</i>	The simulated line state (0 or 1)
<i>N</i>	A number representing the LAN event number (1 to 8)

Details

This attribute can be set to initialize the pseudo line state to a known value.

Setting this attribute does not cause the LAN trigger to generate any events or output packets.

Example

```
print(lan.trigger[1].pseudostate)  Get the present simulated line state for the LAN event 1.
```

Also see

None

lan.trigger[N].stimulus

This attribute specifies events that cause this trigger to assert.

Type	TSP-Link accessible	Affected by	Where saved	Default value
Attribute (RW)	Yes	Instrument reset LAN trigger N reset Recall setup	Not saved	0

Usage

```
triggerStimulus = lan.trigger[N].stimulus
lan.trigger[N].stimulus = triggerStimulus
```

<i>triggerStimulus</i>	The LAN event identifier used to trigger the event
<i>N</i>	A number specifying the trigger packet over the LAN for which to set or query the trigger source (1 to 8)

Details

This attribute specifies which event causes a LAN trigger packet to be sent for this trigger. Set *triggerStimulus* to one of the trigger event IDs, which are shown in the following table.

Trigger event IDs*	
Event ID	Event description
smua.trigger.SWEEPING_EVENT_ID	Occurs when the source-measure unit (SMU) transitions from the idle state to the arm layer of the trigger model
smua.trigger.ARMED_EVENT_ID	Occurs when the SMU moves from the arm layer to the trigger layer of the trigger model
smua.trigger.SOURCE_COMPLETE_EVENT_ID	Occurs when the SMU completes a source action
smua.trigger.MEASURE_COMPLETE_EVENT_ID	Occurs when the SMU completes a measurement action
smua.trigger.PULSE_COMPLETE_EVENT_ID	Occurs when the SMU completes a pulse
smua.trigger.SWEEP_COMPLETE_EVENT_ID	Occurs when the SMU completes a sweep
smua.trigger.IDLE_EVENT_ID	Occurs when the SMU returns to the idle state
digio.trigger[N].EVENT_ID	Occurs when an edge is detected on a digital I/O line
tsplink.trigger[N].EVENT_ID	Occurs when an edge is detected on a TSP-Link line
lan.trigger[N].EVENT_ID	Occurs when the appropriate LXI trigger packet is received on LAN trigger object <i>N</i>
display.trigger.EVENT_ID	Occurs when the TRIG key on the front panel is pressed

Trigger event IDs*	
Event ID	Event description
<code>trigger.EVENT_ID</code>	Occurs when a *TRG command is received on the remote interface GPIB only: Occurs when a GET bus command is received USB only: Occurs when a USBTMC TRIGGER message is received VXI-11 only: Occurs with the VXI-11 command <code>device_trigger</code> ; reference the VXI-11 standard for additional details on the device trigger operation
<code>trigger.blender[N].EVENT_ID</code>	Occurs after a collection of events is detected
<code>trigger.timer[N].EVENT_ID</code>	Occurs when a delay expires
<code>trigger.generator[N].EVENT_ID</code>	Occurs when the <code>trigger.generator[N].assert()</code> function is executed
* Use the name of the trigger event ID to set the stimulus value rather than the numeric value. Using the name makes the code compatible for future upgrades (for example, if the numeric values must change when enhancements are added to the instrument).	

Setting this attribute to zero disables automatic trigger generation.

If any events are detected prior to calling `lan.trigger[N].connect()`, the event is ignored and the action overrun is set.

Example

```
lan.trigger[5].stimulus = trigger.timer[1].EVENT_ID
Use timer 1 trigger event as the source for LAN packet 5 trigger stimulus.
```

Also see

- [lan.trigger\[N\].assert\(\)](#) (on page 11-129)
- [lan.trigger\[N\].clear\(\)](#) (on page 11-129)
- [lan.trigger\[N\].connect\(\)](#) (on page 11-130)
- [lan.trigger\[N\].overrun](#) (on page 11-134)
- [lan.trigger\[N\].wait\(\)](#) (on page 11-137)

lan.trigger[N].wait()

This function waits for an input trigger.

Type	TSP-Link accessible	Affected by	Where saved	Default value
Function	Yes			

Usage

```
triggered = lan.trigger[N].wait(timeout)
```

<code>triggered</code>	Trigger detection indication (true or false)
<code>N</code>	The trigger packet over LAN to wait for (1 to 8)
<code>timeout</code>	Maximum amount of time in seconds to wait for the trigger event

Details

If one or more trigger events have been detected since the last time `lan.trigger[N].wait()` or `lan.trigger[N].clear()` was called, this function returns immediately.

After waiting for a LAN trigger event with this function, the event detector is automatically reset and rearmed regardless of the number of events detected.

Example

```
triggered = lan.trigger[5].wait(3)
```

Wait for a trigger with LAN packet 5 with a timeout of 3 seconds.

Also see

[lan.trigger\[N\].assert\(\)](#) (on page 11-129)

[lan.trigger\[N\].clear\(\)](#) (on page 11-129)

[lan.trigger\[N\].overrun](#) (on page 11-134)

[lan.trigger\[N\].stimulus](#) (on page 11-136)

localnode.autolinefreq

This attribute enables or disables automatic power line frequency detection at start-up.

Type	TSP-Link accessible	Affected by	Where saved	Default value
Attribute (RW)	Yes	Not applicable	Nonvolatile memory	true (enabled)

Usage

```
flag = localnode.autolinefreq
localnode.autolinefreq = flag
```

flag

The auto line frequency detection setting:

- `true`: Enable automatic line frequency detection at start-up
- `false`: Disable automatic line frequency detection at start-up

Details

When this attribute is set to `true`, the power line frequency is detected automatically the next time the 2601B-PULSE powers up. After the power line frequency is automatically detected at power-up, the `localnode.linefreq` attribute is set automatically to 50 or 60.

If the `localnode.linefreq` attribute is explicitly set, `localnode.autolinefreq` is automatically set to `false`.

When using this command from a remote node, `localnode` should be replaced with the node reference, for example `node[5].autolinefreq`.

Also see

[localnode.linefreq](#) (on page 11-140)

localnode.description

This attribute stores a user-defined description and mDNS service name of the instrument.

Type	TSP-Link accessible	Affected by	Where saved	Default value
Attribute (RW)	Yes	Not applicable	Nonvolatile memory	Instrument specific (see Details)

Usage

```
localnode.description = "description"
description = localnode.description
```

<i>description</i>	User-defined description and mDNS service name of the instrument; use a string of 63 characters or less
--------------------	---

Details

This attribute stores a string that contains a description of the instrument. This value appears on LXI welcome page of the instrument. The value of this attribute is also used as the mDNS service name of the instrument.

This attribute's factory default value is "Keithley Instruments SMU <model number> - <serial number>", where <model number> and <serial number> are replaced with the actual model number and serial number of the instrument. Setting this attribute to an empty string (in other words, setting this attribute to a string of length zero, or one consisting entirely of whitespace characters) will revert the description to the factory default value.

When using this command from a remote node, `localnode` should be replaced with the node reference, for example `node[5].description`.

Example

<pre>description = "System in Lab 05" localnode.description = description</pre>	Set description to "System in Lab 05".
---	--

Also see

None

localnode.license

This attribute returns the product license agreements.

Type	TSP-Link accessible	Affected by	Where saved	Default value
Attribute (R)	Yes	Not applicable	Nonvolatile memory	Not applicable

Usage

```
license_agreement = localnode.license
```

<i>license_agreement</i>	The text of the license agreements
--------------------------	------------------------------------

Example

<pre>print(localnode.license)</pre>	Returns the license agreements for the 2601B-PULSE.
-------------------------------------	---

Also see

None

localnode.linefreq

This attribute contains the power line frequency setting that is used for NPLC calculations.

Type	TSP-Link accessible	Affected by	Where saved	Default value
Attribute (RW)	Yes	Not applicable	Nonvolatile memory	60 (60 Hz)

Usage

```
frequency = localnode.linefreq
localnode.linefreq = frequency
```

<code>frequency</code>	An integer representing the detected or specified line frequency of the instrument
------------------------	--

Details

To achieve optimum noise rejection when performing measurements at integer NPLC apertures, set the line frequency attribute to match the frequency (50 Hz or 60 Hz) of the AC power line.

When using this command from a remote node, `localnode` should be replaced with the node reference, for example `node[5].linefreq`. When this attribute is set, the `localnode.autolinefreq` attribute is automatically set to `false`. You can have the instrument automatically detect the AC power line frequency and set this attribute with the line frequency detected when the instrument power is turned on by setting the `localnode.autolinefreq` attribute to `true`.

Example 1

<code>frequency = localnode.linefreq</code>	Reads line frequency setting.
---	-------------------------------

Example 2

<code>localnode.linefreq = 60</code>	Sets the line frequency to 60 Hz.
--------------------------------------	-----------------------------------

Also see

[localnode.autolinefreq](#) (on page 11-138)

localnode.model

This attribute stores the model number.

Type	TSP-Link accessible	Affected by	Where saved	Default value
Attribute (R)	Yes	Not applicable	Not applicable	Not applicable

Usage

```
model = localnode.model
```

<code>model</code>	The model number of the instrument
--------------------	------------------------------------

Example

```
print(localnode.model)
Outputs the model number of the local node. For example:
2601B-PULSE
```

Also see

[localnode.serialno](#) (on page 11-145)

localnode.password

This attribute stores the remote access password.

Type	TSP-Link accessible	Affected by	Where saved	Default value
Attribute (W)	Yes	LAN reset LAN restore defaults	Nonvolatile memory	""

Usage

```
localnode.password = "password"
```

<i>password</i>	A string that contains the remote interface password
-----------------	--

Details

This write-only attribute stores the password that is set for any remote interface. When password usage is enabled (`localnode.passwordmode`), you must supply a password to change the configuration or to control an instrument from a web page or other remote command interface.

The instrument continues to use the old password for all interactions until the command to change it executes. When changing the password, give the instrument time to execute the command before attempting to use the new password.

You cannot retrieve a lost password from any command interface.

You can reset the password by resetting the LAN from the front panel or by using the `lan.reset()` command.

When using this command from a remote node, `localnode` should be replaced with the node reference, for example, `node[5].password`.

Example

```
localnode.password = "N3wpa55w0rd" Changes the remote interface password to N3wpa55w0rd.
```

Also see

[lan.reset\(\)](#) (on page 11-120)

[localnode.passwordmode](#) (on page 11-141)

localnode.passwordmode

This attribute stores the remote access password enable mode.

Type	TSP-Link accessible	Affected by	Where saved	Default value
Attribute (RW)	Yes	Not applicable	Nonvolatile memory	1 (localnode.PASSWORD_WEB)

Usage

```
mode = localnode.passwordmode
localnode.passwordmode = mode
```

<i>mode</i>	The remote password enable mode
-------------	---------------------------------

Details

This attribute controls if and where remote access passwords are required. Set this attribute to one of the values below to enable password checking:

- `localnode.PASSWORD_NONE` or 0: Disable passwords everywhere
- `localnode.PASSWORD_WEB` or 1: Use passwords on the web interface only
- `localnode.PASSWORD_LAN` or 2: Use passwords on the web interface and all LAN interfaces
- `localnode.PASSWORD_ALL` or 3: Use passwords on the web interface and all remote command interfaces

When using this command from a remote node, `localnode` should be replaced with the node reference, for example `node[5].passwordmode`.

You must also set a password.

Example

```
mode = localnode.PASSWORD_WEB
localnode.passwordmode = mode
localnode.password = "SMU1234"
```

Sets value of `mode` to `PASSWORD_WEB`.
Allows use of passwords on the web interface only.
Set the password to `SMU1234`.

Also see

[localnode.password](#) (on page 11-141)

localnode.prompts

This attribute determines if the instrument generates prompts in response to command messages.

Type	TSP-Link accessible	Affected by	Where saved	Default value
Attribute (RW)	Yes	Power cycle	Not saved	0 (disabled)

Usage

```
prompting = localnode.prompts
localnode.prompts = prompting
```

<i>prompting</i>	Prompting mode: <ul style="list-style-type: none"> ▪ Do not generate prompts: 1 ▪ Generate prompts: 0
------------------	---

Details

When the prompting mode is enabled, the instrument generates prompts when the instrument is ready to take another command. Because the prompt is not generated until the previous command completes, enabling prompts provides handshaking with the instrument to prevent buffer overruns.

When prompting is enabled, the instrument might generate the following prompts:

- **TSP>**. The standard prompt, which indicates that the previous command completed normally.
- **TSP?**. The prompt that is issued if there are unread entries in the error queue when the prompt is issued. Like the TSP> prompt, it indicates that processing of the command is complete. It does not mean the previous command generated an error, only that there were still errors in the queue when the command processing was complete.
- **>>>>**. The continuation prompt, which occurs when downloading scripts. When downloading scripts, many command messages must be sent as a group. The continuation prompt indicates that the instrument is expecting more messages as part of the present command.

Commands do not generate prompts. The instrument generates prompts in response to command completion.

Prompts are enabled or disabled only for the remote interface that is active when you send the command. For example, if you enable prompts when the LAN connection is active, they will not be enabled for a subsequent USB connection.

NOTE

Do not disable prompting when using Test Script Builder. Test Script Builder requires prompts and sets the prompting mode automatically. If you disable prompting, the instrument will stop responding when you communicate using Test Script Builder because it is waiting for a common complete prompt from Test Script Builder.

Example

```
localnode.prompts = 1      Enable prompting.
```

Also see

- [localnode.showerrors](#) (on page 11-146)
- [tsplink.reset\(\)](#) (on page 11-368)

localnode.prompts4882

This attribute enables and disables the generation of prompts for IEEE Std 488.2 common commands.

Type	TSP-Link accessible	Affected by	Where saved	Default value
Attribute (RW)	Yes	Power cycle	Not saved	1 (enabled)

Usage

```
prompting = localnode.prompts4882
localnode.prompts4882 = prompting
```

<i>prompting</i>	IEEE Std 488.2 prompting mode: <ul style="list-style-type: none"> ▪ Disable prompting: 0 ▪ Enable prompting: 1
------------------	--

Details

When this attribute is enabled, the IEEE Std 488.2 common commands generate prompts if prompting is enabled with the `localnode.prompts` attribute. If `localnode.prompts4882` is enabled, limit the number of `*trg` commands sent to a running script to 50 regardless of the setting of the `localnode.prompts` attribute.

When this attribute is disabled, IEEE Std 488.2 common commands will not generate prompts. When using the `*trg` command with a script that executes `trigger.wait()` repeatedly, disable prompting to avoid problems associated with the command interface input queue filling.

Example

```
localnode.prompts4882 = 0
```

Disables IEEE Std 488.2 common command prompting.

Also see

[localnode.prompts](#) (on page 11-142)

localnode.reset()

This function resets the local node instrument.

Type	TSP-Link accessible	Affected by	Where saved	Default value
Function	Yes			

Usage

```
localnode.reset()
```

Details

If you want to reset a specific instrument or a subordinate node, use the `node[X].reset()` command.

A local node reset includes:

- Source-measure unit (SMU) attributes affected by a SMU reset are reset
- Other settings are restored back to factory default settings

A `localnode.reset()` is different than a `reset()` because `reset()` resets the entire system.

When using this command from a remote node, `localnode` should be replaced with the node reference, for example `node[5].reset()`.

Example

```
localnode.reset()
```

Resets the local node.

Also see

[reset\(\)](#) (on page 11-156)

[smua.reset\(\)](#) (on page 11-222)

localnode.revision

This attribute stores the firmware revision level.

Type	TSP-Link accessible	Affected by	Where saved	Default value
Attribute (R)	Yes	Not applicable	Not applicable	Not applicable

Usage

```
revision = localnode.revision
```

<code>revision</code>	Firmware revision level
-----------------------	-------------------------

Details

This attribute indicates the revision number of the firmware that is presently running in the instrument.

When using this command from a remote node, `localnode` should be replaced with the node reference. For example, `node[5].revision`.

Example

<pre>print(localnode.revision)</pre>	Outputs the present revision level. Sample output: 1.0.0
--------------------------------------	--

Also see

- [localnode.description](#) (on page 11-139)
- [localnode.model](#) (on page 11-140)
- [localnode.serialno](#) (on page 11-145)

localnode.serialno

This attribute stores the instrument's serial number.

Type	TSP-Link accessible	Affected by	Where saved	Default value
Attribute (R)	Yes	Not applicable	Not applicable	Not applicable

Usage

```
serialno = localnode.serialno
```

<code>serialno</code>	The serial number of the instrument
-----------------------	-------------------------------------

Details

This indicates the instrument serial number.

Example

<pre>display.clear() display.settext(localnode.serialno)</pre>	Clears the instrument display. Places the serial number of the instrument on the top line of its display.
--	--

Also see

- [localnode.description](#) (on page 11-139)
- [localnode.model](#) (on page 11-140)
- [localnode.revision](#) (on page 11-145)

localnode.showerrors

This attribute sets whether or not the instrument automatically sends generated errors.

Type	TSP-Link accessible	Affected by	Where saved	Default value
Attribute (RW)	Yes	Power cycle	Not saved	0 (disabled)

Usage

```
errorMode = localnode.showerrors
localnode.showerrors = errorMode
```

<i>errorMode</i>	Show error setting: <ul style="list-style-type: none"> ▪ Show errors: 1 ▪ Do not show errors: 0
------------------	---

Details

If this attribute is set to 1, the instrument automatically sends any generated errors stored in the error queue, and then clears the queue. Errors are processed after executing a command message (just before issuing a prompt, if prompts are enabled).

If this attribute is set to 0, errors are left in the error queue and must be explicitly read or cleared.

When using this command from a remote node, `localnode` should be replaced with the node reference, for example, `node[5].showerrors`.

Example

```
localnode.showerrors = 1
```

Enables sending of generated errors.

Also see

[localnode.prompts](#) (on page 11-142)

makegetter()

This function creates a function to get the value of an attribute.

Type	TSP-Link accessible	Affected by	Where saved	Default value
Function	No			

Usage

```
getter = makegetter(table, "attributeName")
```

<i>getter</i>	The return value
<i>table</i>	Read-only table where the attribute is located
<i>attributeName</i>	A string representing the name of the attribute

Details

This function is useful for aliasing attributes to improve execution speed. Calling the function created with `makegetter()` executes more quickly than accessing the attribute directly.

Creating a getter function is only useful if it is going to be called several times. Otherwise, the overhead of creating the getter function outweighs the overhead of accessing the attribute directly.

Example

```
getlevel = makegetter(smua.source, "levelv")
v = getlevel()
```

Creates a getter function called `getlevel`.
When `getlevel()` is called, it returns the value of `smua.source.levelv`.

Also see

[makesetter\(\)](#) (on page 11-147)

makesetter()

This function creates a function that, when called, sets the value of an attribute.

Type	TSP-Link accessible	Affected by	Where saved	Default value
Function	No			

Usage

```
setter = makesetter(table, "attributeName")
```

<i>setter</i>	Function that sets the value of the attribute
<i>table</i>	Read-only table where the attribute is located
<i>attributeName</i>	The string name of the attribute

Details

This function is useful for aliasing attributes to improve execution speed. Calling the *setter* function execute more quickly than accessing the attribute directly.

Creating a *setter* function is only useful if it is going to be called several times. If you are not calling the *setter* function several times, it is more efficient to access the attribute directly.

Example

```
setlevel = makesetter(smua.source, "levelv")
for v = 1, 10 do
    setlevel(v)
end
```

Creates a setter function called `setlevel`.
Using `setlevel()` in the loop sets the value of `smua.source.levelv`, performing a source sweep.

Also see

[makegetter\(\)](#) (on page 11-146)

meminfo()

This function returns the present amount of available memory and the total amount of memory in the instrument.

Type	TSP-Link accessible	Affected by	Where saved	Default value
Function	No			

Usage

```
freeMem, totalMem = meminfo()
```

<i>freeMem</i>	The amount of free dynamically allocated memory available
<i>totalMem</i>	The total amount of dynamically allocated memory in the instrument

Details

This function returns two values:

- The amount of free dynamically allocated memory available in kilobytes
- The total amount of dynamically allocated memory on the instrument in kilobytes

The difference between the two values is the amount presently used.

Example

```
print(meminfo())
```

Retrieve the amount of free and total memory in the instrument.
Output:
2.89840e+04 3.27680e+04

Also see

None

node[N].execute()

This function starts test scripts from a remote node.

Type	TSP-Link accessible	Affected by	Where saved	Default value
Function	Yes (see Details)			

Usage

```
node[N].execute("scriptCode")
```

<i>N</i>	The node number of this instrument
<i>scriptCode</i>	A string containing the source code

Details

Only the remote master node can use the execute command to run a script on this node. This function does not run test scripts on the master node; only on this node when initiated by the master node.

This function may only be called when the group number of the node is different than the node of the master.

This function does not wait for the script to finish execution.

This command should only be used from a remote master when controlling this instrument over a TSP-Link®.

Example 1

<code>node[2].execute(sourcecode)</code>	Runs script code on node 2. The code is in a string variable called <code>sourcecode</code> .
--	---

Example 2

<code>node[3].execute("x = 5")</code>	Runs script code in string constant ("x = 5") to set x equal to 5 on node 3.
---------------------------------------	--

Example 3

<code>node[32].execute(TestDut.source)</code>	Runs the test script stored in the variable <code>TestDut</code> (previously stored on the master node) on node 32.
---	---

Also see

- [TSP advanced features](#) (on page 10-51)
- [tsplink.group](#) (on page 11-365)

node[N].getglobal()

This function returns the value of a global variable.

Type	TSP-Link accessible	Affected by	Where saved	Default value
Function	Yes			

Usage

```
value = node[N].getglobal("name")
```

<i>value</i>	The value of the variable
<i>N</i>	The node number of this instrument (1 to 64)
<i>name</i>	The global variable name

Details

This function retrieves the value of a global variable from the runtime environment of this node.

Do not use this command to retrieve the value of a global variable from the local node. Instead, access the global variable directly. This command should only be used from a remote master when controlling this instrument over a TSP-Link network.

Example

<code>print(node[5].getglobal("test_val"))</code>
Retrieves and outputs the value of the global variable named <code>test_val</code> from node 5.

Also see

- [node\[N\].setglobal\(\)](#) (on page 11-150)
- [TSP advanced features](#) (on page 10-51)

node[N].setglobal()

This function sets the value of a global variable.

Type	TSP-Link accessible	Affected by	Where saved	Default value
Function	Yes			

Usage

```
node[N].setglobal("name", value)
```

<i>N</i>	The node number of this instrument (1 to 6463)
<i>name</i>	The global variable name to set
<i>value</i>	The value to assign to the variable

Details

From a remote node, use this function to assign the given value to a global variable.

Do not use this command to create or set the value of a global variable from the local node (set the global variable directly instead). This command should only be used from a remote master when controlling this instrument over a TSP-Link network.

Example

```
node[3].setglobal("x", 5)      Sets the global variable x on node 3 to the value of 5.
```

Also see

[node\[N\].getglobal\(\)](#) (on page 11-149)

[TSP advanced features](#) (on page 10-51)

opc()

This function sets the operation complete status bit when all overlapped commands are completed.

Type	TSP-Link accessible	Affected by	Where saved	Default value
Function	No			

Usage

```
opc()
```

Details

This function causes the operation complete bit in the Standard Event Status Register to be set when all previously started local overlapped commands are complete.

Note that each node independently sets its operation complete bits in its own status model. Any nodes that are not actively performing overlapped commands set their bits immediately. All remaining nodes set their own bits as they complete their own overlapped commands.

Example

```
opc()
waitcomplete()
print("1")
```

Output:
1

Also see

[Status model](#) (on page 15-1)

[waitcomplete\(\)](#) (on page 11-393)

os.remove()

This function deletes the file or directory with a given name.

Type	TSP-Link accessible	Affected by	Where saved	Default value
Function	Yes			

Usage

```
success, msg = os.remove("filename")
```

<i>success</i>	A success indicator (<code>true</code> or <code>nil</code>)
<i>msg</i>	A message value (<code>nil</code> or an error message)
<i>filename</i>	A string representing the name of the file or directory to delete

Details

Directories must be empty before using the `os.remove()` function to delete them.

If this function fails, it returns `nil` (for *success*) and an error message string (for *msg*).

Example

```
os.remove("testFile")
```

Delete the file named `testFile`.

Also see

[os.rename\(\)](#) (on page 11-151)

os.rename()

This function renames an existing file or directory.

Type	TSP-Link accessible	Affected by	Where saved	Default value
Function	Yes			

Usage

```
success, msg = os.rename("oldname", "newname")
```

<i>success</i>	A success indicator (<code>true</code> or <code>nil</code>)
<i>msg</i>	A message value (<code>nil</code> or an error message)
<i>oldname</i>	String representing the name of the file or directory to rename
<i>newname</i>	String represent the new name of the file or directory

Details

If this function fails, it returns `nil` (for *success*) and an error message string (for *msg*).

Example

```
os.rename("testFile", "exampleFile")
```

Changes the name of the existing file `testFile` to the name `exampleFile`.

Also see

[os.remove\(\)](#) (on page 11-151)

os.time()

This function generates a time value in UTC time.

Type	TSP-Link accessible	Affected by	Where saved	Default value
Function	Yes			

Usage

```
utcTime = os.time()
utcTime = os.time(timespec)
```

<i>utcTime</i>	Time value in UTC time
<i>timespec</i>	The date and time (year, month, day, hour, and minute)

Details

The *timespec* is a table using the fields listed in the table below.

year	The year (1970 or later)
month	The month (1 to 12)
day	The day (1 to 31)
hour	The hour (00 to 23)
min	The minute (00 to 59)
sec	The second (00 to 59)

If the time (hour, minute, and second) options are not used, they default to noon for that day. When called without a parameter (the first form), the function returns the current time.

Set the time zone before calling the `os.time()` function.

Example

```
systemTime = os.time({year = 2019,
  month = 3,
  day = 31,
  hour = 14,
  min = 25})
settime(systemTime)
```

Sets the date and time to Mar 31, 2019 at 2:25 pm.

Also see

[settime\(\)](#) (on page 11-172)

[settimezone\(\)](#) (on page 11-173)

print()

This function generates a response message.

Type	TSP-Link accessible	Affected by	Where saved	Default value
Function	No			

Usage

```
print(value1)
print(value1, value2)
print(value1, ..., valueN)
```

<i>value1</i>	The first argument to output
<i>value2</i>	The second argument to output
<i>valueN</i>	The last argument to output
...	One or more values separated with commas

Details

TSP-enabled instruments do not have inherent query commands. Like other scripting environments, the `print()` command and other related `print()` commands generate output. The `print()` command creates one response message.

The output from multiple arguments is separated with a tab character.

Numbers are printed using the `format.asciiprecision` attribute. If you want use Lua formatting, print the return value from the `tostring()` function.

Example 1

```
x = 10
print(x)
```

Example of an output response message:

```
10
```

Note that your output might be different if you set your ASCII precision setting to a different value.

Example 2

```
x = true
print(tostring(x))
```

Example of an output response message:

```
true
```

Also see

[format.asciiprecision](#) (on page 11-89)

printbuffer()

This function prints data from tables or reading buffer subtables.

Type	TSP-Link accessible	Affected by	Where saved	Default value
Function	No			

Usage

```
printbuffer(startIndex, endIndex, bufferVar)
printbuffer(startIndex, endIndex, bufferVar, bufferVar2)
printbuffer(startIndex, endIndex, bufferVar, ..., bufferVarN)
```

<i>startIndex</i>	Beginning index of the buffer to print; this must be more than one and less than <i>endIndex</i>
<i>endIndex</i>	Ending index of the buffer to print; this must be more than <i>startIndex</i> and less than the index of the last entry in the tables
<i>bufferVar</i>	First table or reading buffer subtable to print
<i>bufferVar2</i>	Second table or reading buffer subtable to print
<i>bufferVarN</i>	The last table or reading buffer subtable to print
...	One or more tables or reading buffer subtables separated with commas

Details

If $startIndex \leq 1$, 1 is used as *startIndex*. If $n < endIndex$, *n* is used as *endIndex*.

When any given reading buffers are used in overlapped commands that have not yet completed (at least to the specified index), this function outputs data as it becomes available.

When there are outstanding overlapped commands to acquire data, *n* refers to the index that the last entry in the table has after all the measurements have completed.

If you pass a reading buffer instead of a reading buffer subtable, the default subtable for that reading buffer is used.

This command generates a single response message that contains all data. The response message is stored in the output queue.

The `format.data` attribute controls the format of the response message.

Example

```
format.data = format.ASCII
format.asciiprecision = 6
printbuffer(1, rb1.n, rb1)
```

This assumes that `rb1` is a valid reading buffer in the runtime environment. The use of `rb1.n` (*bufferVar.n*) indicates that the instrument should output all readings in the reading buffer. In this example, `rb1.n` equals 10.

Example of output data (`rb1.readings`):

```
4.07205e-05, 4.10966e-05, 4.06867e-05, 4.08865e-05, 4.08220e-05, 4.08988e-05,
4.08250e-05, 4.09741e-05, 4.07174e-05, 4.07881e-05
```

Also see

[bufferVar.n](#) (on page 11-28)
[bufferVar.readings](#) (on page 11-29)
[format.asciiprecision](#) (on page 11-89)
[format.byteorder](#) (on page 11-89)
[format.data](#) (on page 11-91)
[printnumber\(\)](#) (on page 11-155)

printnumber()

This function prints numbers using the configured format.

Type	TSP-Link accessible	Affected by	Where saved	Default value
Function	No			

Usage

```
printnumber(value1)
printnumber(value1, value2)
printnumber(value1, ..., valueN)
```

<i>value1</i>	First value to print in the configured format
<i>value2</i>	Second value to print in the configured format
<i>valueN</i>	Last value to print in the configured format
...	One or more values separated with commas

Details

There are multiple ways to use this function, depending on how many numbers are to be printed.

This function prints the given numbers using the data format specified by `format.data` and `format.asciiprecision`.

Example

```
format.asciiprecision = 10
x = 2.54
printnumber(x)
format.asciiprecision = 3
printnumber(x, 2.54321, 3.1)
```

Configure the ASCII precision to 10 and set `x` to 2.54.
Read the value of `x` based on these settings.
Change the ASCII precision to 3.
View how the change affects the output of `x` and some numbers.
Output:
2.540000000e+00
2.54e+00, 2.54e+00, 3.10e+00

Also see

- [format.asciiprecision](#) (on page 11-89)
- [format.byteorder](#) (on page 11-89)
- [format.data](#) (on page 11-91)
- [print\(\)](#) (on page 11-153)
- [printbuffer\(\)](#) (on page 11-154)

reset()

This function resets commands to their default settings.

Type	TSP-Link accessible	Affected by	Where saved	Default value
Function	No			

Usage

```
reset()
reset(system)
```

system

What to reset:

- `true`: If the node is the master, the entire system is reset (default)
- `false`: Only the local group is reset

Details

The `reset()` command in its simplest form resets the entire TSP-enabled system, including the controlling node and all subordinate nodes.

If you want to reset a specific instrument, use either the `localnode.reset()` or `node[X].reset()` command. Use the `localnode.reset()` command for the local instrument. Use the `node[X].reset()` command to reset an instrument on a subordinate node.

You can only reset the entire system using `reset(true)` if the node is the master. If the node is not the master node, executing this command generates an error.

Example

```
reset(true)
```

If the node is the master node, the entire system is reset; if the node is not the master node, an error is generated.

Also see

[localnode.reset\(\)](#) (on page 11-144)

savebuffer()

This KISavebuffer factory script function saves a specified reading buffer as either a CSV file or an XML file.

Type	TSP-Link accessible	Affected by	Where saved	Default value
Function	No			

Usage

```
savebuffer(buffer, "formatType", "fileName")
```

buffer

The reading buffer to save

formatType

A string indicating which file type to use: `csv` or `xml`

fileName

The file name of the saved buffer

Details

Use this function to save the specified buffer to a USB flash drive.

This function will only save to a USB flash drive.

You are not required to qualify the path to the USB flash drive, but you can add `/usb1/` before the `fileName` (see Example 2).

Example 1

```
savebuffer(smua.nvbuffer1, "csv", "mybuffer.csv")
```

Save smua dedicated reading buffer 1 as a CSV file named `mybuffer.csv`.

Example 2

```
savebuffer(smua.nvbuffer1, "csv", "/usb1/mybuffer.csv")
```

Save smua dedicated reading buffer 1 to an installed USB flash drive as a CSV file named `mybuffer.csv`.

Also see

- [KISavebuffer factory script](#) (on page 9-22)
- [smua.savebuffer\(\)](#) (on page 11-222)

script.anonymous

This is a reference to the anonymous script.

Type	TSP-Link accessible	Affected by	Where saved	Default value
Attribute (R)	No	See Details	See Details	Not applicable

Usage

```
scriptVar = script.anonymous
```

`scriptVar` The name of the variable that references the script

Details

You can use the `script.anonymous` script like any other script. Also, you can save the anonymous script as a user script by giving it a name.

This script is replaced by loading a script with the `loadscript` or `loadandruncscript` commands when they are used without a name.

Example 1

```
script.anonymous.list()
```

Displays the content of the anonymous script.

Example 2

```
print(script.anonymous.source)
```

Retrieves the source of the anonymous script.

Also see

- [Anonymous scripts](#) (on page 10-3)
- [scriptVar.autorun](#) (on page 11-163)
- [scriptVar.list\(\)](#) (on page 11-164)
- [scriptVar.name](#) (on page 11-165)
- [scriptVar.run\(\)](#) (on page 11-166)
- [scriptVar.save\(\)](#) (on page 11-166)
- [scriptVar.source](#) (on page 11-167)

script.delete()

This function deletes a script from nonvolatile memory.

Type	TSP-Link accessible	Affected by	Where saved	Default value
Function	No			

Usage

```
script.delete("scriptName")
```

<i>scriptName</i>	The string that represents the name of the script
-------------------	---

Example

<pre>script.delete("test8")</pre>	Deletes a user script named "test8" from nonvolatile memory.
-----------------------------------	--

Also see

[Delete user scripts from the instrument](#) (on page 10-43)

[scriptVar.save\(\)](#) (on page 11-166)

script.factory.catalog()

This function returns an iterator that can be used in a `for` loop to iterate over all the factory scripts.

Type	TSP-Link accessible	Affected by	Where saved	Default value
Function	Yes			

Usage

```
for name in script.factory.catalog() do body end
```

<i>name</i>	String representing the name of the script
-------------	--

<i>body</i>	Code that implements the body of the <code>for</code> loop to process the names in the catalog
-------------	--

Details

Accessing this catalog of scripts allows you to process the factory scripts. The entries will be enumerated in no particular order.

Each time the body of the function executes, *name* takes on the name of one of the factory scripts. The `for` loop repeats until all scripts have been iterated.

Example

<pre>for name in script.factory.catalog() do print(name) end</pre>	Retrieve the catalog listing for factory scripts.
--	---

Also see

None

script.load()

This function creates a script from a specified file.

Type	TSP-Link accessible	Affected by	Where saved	Default value
Function	No			

Usage

```
scriptVar = script.load("file")
scriptVar = script.load("file", "name")
```

<i>scriptVar</i>	The created script; this is <code>nil</code> if an error is encountered
<i>file</i>	The path and file name of the script file to load
<i>name</i>	The name of the script to be created

Details

The file path may be absolute or relative to the current working directory. The root folder of the USB flash drive has the absolute path `"/usb1/"`. Both the forward slash (`/`) and backslash (`\`) are supported as directory separators.

The file to be loaded must start with the `loadscript` or `loadandrunscript` keywords, contain the body of the script, and end with the `endscript` keyword.

Script naming:

- If the *name* parameter is an empty string, or *name* is absent (or `nil`) and the script name cannot be extracted from the file, *scriptVar* is the only handle to the created script.
- If *name* is given (and not `nil`), any script name embedded in the file is ignored.
- If *name* conflicts with the name of an existing script in the `script.user.scripts` table, the existing script's name attribute is set to an empty string before it is replaced in the `script.user.scripts` table by the new script.
- If *name* is absent or `nil`, the command attempts to extract the name of the script from the file. Any conflict between the extracted name and that of an existing script in the scripts table generates an error. If the script name cannot be extracted, the created script's name attribute is initialized to the empty string and must be set to a valid nonempty string before saving the script to nonvolatile memory.

Example

```
myTest8 =
  script.load("/usb1/filename.tsp",
    "myTest8")
```

Loads the script `myTest8` from the USB flash drive.

Also see

[script.new\(\)](#) (on page 11-160)

script.new()

This function creates a script.

Type	TSP-Link accessible	Affected by	Where saved	Default value
Function	No			

Usage

```
scriptVar = script.new("code")
scriptVar = script.new("code", "name")
```

<i>scriptVar</i>	The name of the variable that will reference the script
<i>code</i>	A string containing the body of the script
<i>name</i>	The name of the script

Details

The *name* parameter is the name that is added to the `script.user.scripts` table. If *name* is not given, an empty string is used, and the script is unnamed. If the name already exists in `script.user.scripts`, the existing script's *name* attribute is set to an empty string before it is replaced by the new script.

Note that *name* is the value that is used for the instrument front panel display. If this value is not defined, the script is not available from the front panel.

You must save the new script into nonvolatile memory to keep it when the instrument is turned off.

Example 1

```
myTest8 = script.new(
  "display.clear() display.settext('Hello from myTest8')", "myTest8")
myTest8()
```

Creates a new script referenced by the variable `myTest8` with the name "myTest8".
Runs the script. The instrument displays "Hello from myTest8".

Example 2

```
autoexec = script.new(
  "display.clear() display.settext('Hello from autoexec')", 'autoexec')
```

Creates a new `autoexec` script that clears the display when the instrument is turned on and displays "Hello from autoexec".

Also see

[Create a script using the script.new\(\) command](#) (on page 10-37)

[Global variables and the script.user.scripts table](#) (on page 10-36)

[Named scripts](#) (on page 10-4)

[scriptVar.save\(\)](#) (on page 11-166)

[script.newautorun\(\)](#) (on page 11-161)

script.newautorun()

This function creates a script and enables autorun.

Type	TSP-Link accessible	Affected by	Where saved	Default value
Function	No			

Usage

```
scriptVar = script.newautorun("code")
scriptVar = script.newautorun("code", "name")
```

<i>scriptVar</i>	The name of the variable that will reference the script
<i>code</i>	A string that contains the body of the script
<i>name</i>	The name of the script

Details

The *name* parameter is the name that is added to the `script.user.scripts` table. If *name* is not given, an empty string is used, and the script is unnamed. If the name already exists in `script.user.scripts`, the existing script's *name* attribute is set to an empty string before it is replaced by the new script.

Note that *name* is the value that is used for the instrument front panel display. If this value is not defined, the script is not available from the front panel.

You must save the new script into nonvolatile memory to keep it when the instrument is turned off.

The script is run automatically immediately after it is created.

This command is the same as the `script.new()` function except that the script is automatically run.

Example

```
NewAuto = script.newautorun("print('Hello from new auto run command')", 'NewAuto')
print(NewAuto.autorun)
print(NewAuto.name)
```

Creates a new script called `NewAuto` that automatically has the `autorun` attribute set to `yes` after it is created. The *name* is set to `"NewAuto"`.

Output:

```
Hello from new auto run command
yes
NewAuto
```

Also see

[Create a script using the `script.new\(\)` command](#) (on page 10-37)

[Global variables and the `script.user.scripts` table](#) (on page 10-36)

[Named scripts](#) (on page 10-4)

[`script.new\(\)`](#) (on page 11-160)

[`scriptVar.autorun`](#) (on page 11-163)

[`scriptVar.save\(\)`](#) (on page 11-166)

script.restore()

This function restores a script that was removed from the runtime environment.

Type	TSP-Link accessible	Affected by	Where saved	Default value
Function	No			

Usage

```
script.restore(name)
```

<i>name</i>	The name of the script to be restored
-------------	---------------------------------------

Details

This command copies the script from nonvolatile memory into the runtime environment. It also creates a global variable with the same name as the name of the script.

Example

```
script.restore("test9")
```

Restores a script named <code>test9</code> from nonvolatile memory.

Also see

[script.delete\(\)](#) (on page 11-158)

script.run()

This function runs the anonymous script.

Type	TSP-Link accessible	Affected by	Where saved	Default value
Function	No			

Usage

```
script.run()
run()
```

Details

Each time the `script.run()` command is given, the anonymous script is executed. This script can be run using this command many times without having to re-send it.

Example

```
run()
```

Runs the anonymous script.

Also see

[script.anonymous](#) (on page 11-157)

script.user.catalog()

This function returns an iterator that can be used in a `for` loop to iterate over all the scripts stored in nonvolatile memory.

Type	TSP-Link accessible	Affected by	Where saved	Default value
Function	No			

Usage

```
for name in script.user.catalog() do body end
```

<i>name</i>	String representing the name of the script
<i>body</i>	Code that implements the body of the <code>for</code> loop to process the names in the catalog

Details

This function accesses the catalog of scripts stored in nonvolatile memory, which allows you to process all scripts in nonvolatile memory. The entries are enumerated in no particular order.

Each time the body of the function executes, *name* takes on the name of one of the scripts stored in nonvolatile memory. The `for` loop repeats until all scripts have been iterated.

Example

<pre>for name in script.user.catalog() do print(name) end</pre>	Retrieve the catalog listing for user scripts.
---	--

Also see

None

scriptVar.autorun

This attribute controls the autorun state of a script.

Type	TSP-Link accessible	Affected by	Where saved	Default value
Attribute (RW)	No	Not applicable	See Details	See Details

Usage

```
scriptVar.autorun = "state"
state = scriptVar.autorun
```

<i>scriptVar</i>	The name of the variable that references the script
<i>state</i>	String that indicates whether or not the script runs automatically when powered on: <ul style="list-style-type: none"> ▪ <code>yes</code>: Script runs automatically ▪ <code>no</code>: Script does not run automatically

Details

Autorun scripts run automatically when the instrument is turned on. You can set any number of scripts to autorun.

The run order for autorun scripts is arbitrary, so make sure the run order is not important.

The default value for `scriptVar.autorun` depends on how the script was loaded. The default is `no` if the script was loaded with `loadscript` or `script.new()`. It is `yes` for scripts loaded with `loadandruncscript` or `script.newautorun()`.

NOTE

Make sure to save the script in nonvolatile memory after setting the `autorun` attribute so that the instrument keeps the setting.

Example

```
test5.autorun = "yes"
test5.save()
```

Assume a script named `test5` is in the runtime environment. The next time the instrument is turned on, `test5` script automatically loads and runs.

Also see

None

scriptVar.list()

This function generates a script listing.

Type	TSP-Link accessible	Affected by	Where saved	Default value
Function	No			

Usage

```
scriptVar.list()
```

<code>scriptVar</code>	The name of the variable that references the script
------------------------	---

Details

This function generates output in the form of a sequence of response messages (one message for each line of the script). It also generates output of the script control messages (`loadscript` or `loadandruncscript` and `endscript`).

Example

```
test7 = script.new("display.clear() display.settext('Hello from my test')",
  "test7")
test7()
test7.save()
test7.list()
```

The above example code creates a script named `test7` that displays text on the front panel and lists the script with the following output:

```
loadscript test7
display.clear() display.settext("Hello from my test")
endscript
```

Also see

[Load a script by sending commands over the remote interface](#) (on page 10-4)

[Retrieve source code one line at a time](#) (on page 10-42)

scriptVar.name

This attribute contains the name of a script in the runtime environment.

Type	TSP-Link accessible	Affected by	Where saved	Default value
Attribute (RW)	No	Not applicable	Not applicable	Not applicable

Usage

```
scriptVar.name = "scriptName"
scriptName = scriptVar.name
```

<i>scriptVar</i>	Name of the variable that references the script
<i>scriptName</i>	A string that represents the name of the script

Details

When setting the script name, this attribute renames the script that the variable *scriptVar* references.

This attribute must be either a valid Lua identifier or the empty string. Changing the name of a script changes the index that is used to access the script in the `script.user.scripts` table. Setting the attribute to an empty string removes the script from the table completely, and the script becomes an unnamed script.

As long as there are variables referencing an unnamed script, the script can be accessed through those variables. When all variables that reference an unnamed script are removed, the script is removed from the runtime environment.

If the new name is the same as a name that is already used for another script, the name of the other script is set to an empty string, and that script becomes unnamed.

NOTE

Changing the name of a script does not change the name of any variables that reference that script. The variables still reference the script, but the names of the script and variables may not match.

Example

```
test7 = script.new("display.clear() display.settext('Hello from my test')", "")
test7()
print(test7.name)
test7.name = "test7"
print(test7.name)
test7.save()
```

This example calls the `script.new()` function to create a script with no name, runs the script, names the script "test7", and then saves the script in nonvolatile memory.

Also see

[Rename a script](#) (on page 10-40)

[script.new\(\)](#) (on page 11-160)

[scriptVar.save\(\)](#) (on page 11-166)

scriptVar.run()

This function runs a script.

Type	TSP-Link accessible	Affected by	Where saved	Default value
Function	No			

Usage

```
scriptVar.run()
scriptVar()
```

<code>scriptVar</code>	The name of the variable that references the script
------------------------	---

Details

The `scriptVar.run()` function runs the script referenced by `scriptVar`. You can also run the script by using `scriptVar()`.

To run a factory script, use `script.factory.scripts.scriptName()`, replacing `scriptName` with the name of the factory script.

Example

<code>test8.run()</code>	Runs the script referenced by the variable <code>test8</code> .
--------------------------	---

Also see

None

scriptVar.save()

This function saves the script to nonvolatile memory or to a USB flash drive.

Type	TSP-Link accessible	Affected by	Where saved	Default value
Function	No			

Usage

```
scriptVar.save()
scriptVar.save("filename")
```

<code>scriptVar</code>	The name of variable that references the script
<code>filename</code>	A string that contains the file name to use when saving the script to a USB flash drive

Details

The `scriptVar.save()` function saves a script to nonvolatile memory or a USB flash drive. The root folder of the USB flash drive has the absolute path `/usb1/`.

If no `filename` is specified (the file name parameter is an empty string), the script is saved to internal nonvolatile memory. Only a script with `filename` defined can be saved to internal nonvolatile memory. If a `filename` is given, the script is saved to the USB flash drive.

You can add the file extension, but it is not required. The only allowed extension is `.tsp` (see Example 2).

Example 1

<code>test8.save()</code>	Saves the script referenced by the variable <code>test8</code> to nonvolatile memory.
---------------------------	---

Example 2

<code>test8.save("/usb1/myScript.tsp")</code>	Saves the script referenced by the variable <code>test8</code> to a file named <code>myScript.tsp</code> on your USB flash drive.
---	---

Also see

[Save a user script](#) (on page 10-10)

scriptVar.source

This attribute contains the source code of a script.

Type	TSP-Link accessible	Affected by	Where saved	Default value
Attribute (RW) (see Details)	No	Not applicable	Not saved	Not applicable

Usage

```
code = scriptVar.source
scriptVar.source = nil
```

<code>scriptVar</code>	The name of the variable that references the script that contains the source code
<code>code</code>	A string that contains the body of the script

Details

The `loadscript` or `loadandrunscript` and `endscript` keywords are not included in the source code.

The body of the script is a single string with lines separated by the new line character.

The instrument automatically stores the source for all scripts that are loaded on the instrument. To free up memory or to obfuscate the code, assign `nil` to the source attribute of the script. Although this attribute is writable, it can only be set to the `nil` value.

Example

<code>test7 = script.new("display.clear() display.settext('Hello from my test')", "")</code> <code>print(test7.source)</code>
This example creates a script called <code>test7</code> that displays a message on the front panel and retrieves the source code. Output: <code>display.clear() display.settext('Hello from my test')</code>

Also see

[scriptVar.list\(\)](#) (on page 11-164)

serial.baud

This attribute configures the baud rate for the RS-232 port.

Type	TSP-Link accessible	Affected by	Where saved	Default value
Attribute (RW)	Yes	Not applicable	Nonvolatile memory	9600

Usage

```

baud = serial.baud
serial.baud = baud

```

<i>baud</i>	The baud rate (300, 600, 1200, 2400, 4800, 9600, 19200, 38400, 57600, or 115200)
-------------	--

Details

A new baud rate setting takes effect when the command to change it is processed.

NOTE

Allow ample time for the command to be processed before attempting to communicate with the instrument again. If possible, set the baud rate from one of the other command interfaces or from the front panel.

The reset function has no effect on data bits.

Example

<code>serial.baud = 1200</code>	Sets the baud rate to 1200.
---------------------------------	-----------------------------

Also see

[RS-232 interface operation](#) (on page 2-32)

[serial.databits](#) (on page 11-169)

[serial.flowcontrol](#) (on page 11-170)

[serial.parity](#) (on page 11-170)

serial.databits

This attribute configures character width (data bits) for the RS-232 port.

Type	TSP-Link accessible	Affected by	Where saved	Default value
Attribute (RW)	Yes	Not applicable	Nonvolatile memory	8

Usage

```
bits = serial.databits
serial.databits = bits
```

<code>bits</code>	An integer representing the character width (7 or 8)
-------------------	--

Details

A new data width setting takes effect when the command to change it is processed.

NOTE

Allow ample time for the command to be processed before attempting to communicate with the instrument again. If possible, set the character width from one of the other command interfaces or from the front panel.

The reset function has no effect on data bits.

Example

<code>serial.databits = 8</code>	Sets data width to 8.
----------------------------------	-----------------------

Also see

[RS-232 interface operation](#) (on page 2-32)

[serial.baud](#) (on page 11-168)

[serial.flowcontrol](#) (on page 11-170)

[serial.parity](#) (on page 11-170)

serial.flowcontrol

This attribute configures flow control for the RS-232 port.

Type	TSP-Link accessible	Affected by	Where saved	Default value
Attribute (RW)	Yes	Not applicable	Nonvolatile memory	"none" (serial.FLOW_NONE)

Usage

```
flow = serial.flowcontrol
serial.flowcontrol = flow
```

flow

A string or value that represents flow control configuration; set to:

- "none" or serial.FLOW_NONE (selects no flow control)
- "hardware" or serial.FLOW_HARDWARE (selects hardware flow control)

Details

A new flow control setting takes effect when the command to change it is processed.

NOTE

Allow ample time for the command to be processed before attempting to communicate with the instrument again. If possible, set the flow control from one of the other command interfaces or from the front panel.

The reset function has no effect on flow control.

Example

```
serial.flowcontrol = serial.FLOW_NONE
```

Sets flow control to none.

Also see

- [serial.baud](#) (on page 11-168)
- [serial.databits](#) (on page 11-169)
- [serial.parity](#) (on page 11-170)

serial.parity

This attribute configures parity for the RS-232 port.

Type	TSP-Link accessible	Affected by	Where saved	Default value
Attribute (RW)	Yes	Not applicable	Nonvolatile memory	"none" (serial.PARITY_NONE)

Usage

```
parity = serial.parity
serial.parity = parity
```

parity

Set parity to one of the following values:

- Select no parity ("none" or serial.PARITY_NONE)
- Select even parity ("even" or serial.PARITY_EVEN)
- Select odd parity ("odd" or serial.PARITY_ODD)

Details

A new parity setting takes effect when the command to change it is processed.

NOTE

Allow ample time for the command to be processed before attempting to communicate with the instrument again. If possible, set parity from one of the other command interfaces or from the front panel.

The reset function has no effect on parity.

Example

<code>serial.parity = serial.PARITY_NONE</code>	Sets parity to none.
---	----------------------

Also see

- [RS-232 interface operation](#) (on page 2-32)
- [serial.baud](#) (on page 11-168)
- [serial.databits](#) (on page 11-169)
- [serial.flowcontrol](#) (on page 11-170)

serial.read()

This function reads available characters (data) from the serial port.

Type	TSP-Link accessible	Affected by	Where saved	Default value
Function	Yes			

Usage

```
data = serial.read(maxchars)
```

<i>data</i>	A string that consists of all data read from the serial port
<i>maxchars</i>	An integer that specifies the maximum number of characters to read

Details

This function reads available characters from the serial port. It does not wait for new characters to arrive. As long as *maxchars* is less than 200 characters, all characters that are received by the serial port (before the `serial.read()` command is executed) are returned. If too many characters are received between calls to this function, the RS-232 buffers will overflow and some characters may be lost.

Call this function as many times as necessary to receive the required number of characters. For optimal performance, use a small delay between repeated calls to this function.

The data returned is the raw data stream read from the port. No characters, such as control characters or terminator characters, are interpreted.

If you attempt to use this function when the serial port is enabled as a command interface, a settings conflict error is generated.

Example

```
data = serial.read(200)
print(data)
```

Read data from the serial port.

Output:

John Doe

The above output indicates that the string "John Doe" was read from the serial port.

Also see

[serial.write\(\)](#) (on page 11-172)

serial.write()

This function writes data to the serial port.

Type	TSP-Link accessible	Affected by	Where saved	Default value
Function	Yes			

Usage

```
serial.write("data")
```

<i>data</i>	A string representing the data to write
-------------	---

Details

This function writes the specified string to the serial port, where it can be read by connected equipment (for example, a component handler).

No terminator characters are added to the data, and data is written exactly as specified by the *data* parameter.

Example

```
serial.write("1 2 3 4")
```

Write data string "1 2 3 4" to the serial port.

Also see

[serial.read\(\)](#) (on page 11-171)

settime()

This function sets the real-time clock (sets present time of the system).

Type	TSP-Link accessible	Affected by	Where saved	Default value
Function	Yes			

Usage

```
settime(time)
```

<i>time</i>	The time in seconds since January 1, 1970 UTC
-------------	---

Details

This function sets the date and time of the instrument based on the *time* parameter (specified in UTC time). UTC time is specified as the number of seconds since Jan 1, 1970, UTC. You can use UTC time from a local time specification, or you can use UTC time from another source (for example, your computer).

Example

<pre>systemTime = os.time({year = 2020, month = 3, day = 31, hour = 14, min = 25}) settime(systemTime)</pre>	Sets the date and time to Mar 31, 2020 at 2:25 pm.
--	--

Also see

- [gettimezone\(\)](#) (on page 11-97)
- [os.time\(\)](#) (on page 11-152)
- [settimezone\(\)](#) (on page 11-173)

settimezone()

This function sets the local time zone.

Type	TSP-Link accessible	Affected by	Where saved	Default value
Function	No			

Usage

```
settimezone(offset)
settimezone("offset", "dstOffset", "dstStart", "dstEnd")
```

<i>offset</i>	String representing offset from UTC
<i>dstOffset</i>	String representing the daylight savings offset from UTC
<i>dstStart</i>	String representing when daylight savings time starts
<i>dstEnd</i>	String representing when daylight savings time ends

Details

You only need to set the time zone if you use the `os.time()` and `os.date()` functions.

If only one parameter is given, the same time offset is used throughout the year. If four parameters are given, time is adjusted twice during the year for daylight savings time.

offset and *dstOffset* are strings of the form "[+|-]hh[:mm[:ss]]" that indicate how much time must be added to the local time to get UTC time:

- *hh* is a number between 0 and 23 that represents hours
- *mm* is a number between 0 and 59 that represents minutes
- *ss* is a number between 0 and 59 that represents seconds

The minute, second, +, and - fields are optional.

For example, to set the UTC-5 time zone, you specify the string "5", because UTC-5 is 5 hours behind UTC and you must add 5 hours to the local time to determine UTC time. To specify the time zone UTC4, you specify "-4", because UTC4 is 4 hours ahead of UTC and 4 hours must be subtracted from the local time to determine UTC.

dstStart and *dstEnd* are strings of the form "MM.w.dw/hh[:mm[:ss]]" that indicate when daylight savings time begins and ends respectively:

- *MM* is a number between 1 and 12 that represents the month
- *w* is a number between 1 and 5 that represents the week in the month
- *dw* is a number between 0 and 6 that represents the day of the week (where 0 is Sunday)

The rest of the fields represent the time of day that the change takes effect:

- *hh* represents hours
- *mm* represents minutes
- *ss* represents seconds

The minutes and seconds fields are optional.

The week of the month and day of the week fields are not specific dates.

Example

```
settimezone("8", "1", "3.3.0/02", "11.2.0/02")
```

Sets *offset* to equal +8 hours, +1 hour for DST, starts on Mar 14 at 2:00 am, ends on Nov 7 at 2:00 am.

```
settimezone(offset)
```

Sets local time zone to *offset*.

Also see

[gettimezone\(\)](#) (on page 11-97)

[os.time\(\)](#) (on page 11-152)

[settime\(\)](#) (on page 11-172)

setup.poweron

This attribute specifies which saved setup to recall when the instrument is turned on.

Type	TSP-Link accessible	Affected by	Where saved	Default value
Attribute (RW)	Yes	Not applicable	Nonvolatile memory	0

Usage

```
id = setup.poweron
setup.poweron = id
```

id

An integer that specifies the setup to recall when the instrument power is turned on (0 to 5)

Details

When *id* = 0, the instrument uses the factory default setup when it is turned on. When *id* is set to 1 to 5, it uses the setup saved with `setup.save()`.

Only setups stored in nonvolatile memory are available (you cannot recall a script from a USB flash drive with this command).

To save a script that is used when the instrument is powered on, you can create a configuration script and name it `autoexec`.

Example

```
setup.poweron = 0
```

Set the instrument to use the factory default setup when power is turned on.

Also see

[setup.save\(\)](#) (on page 11-176)

[Start-up \(power-on\) configuration](#) (on page 4-54)

setup.recall()

This function recalls settings from a saved setup.

Type	TSP-Link accessible	Affected by	Where saved	Default value
Function	Yes			

Usage

```
setup.recall(id)
```

id

An integer or string that specifies the location of the setup to recall:

- Factory default setup: 0
- User-saved setup in nonvolatile memory: 1 to 5
- User-saved setup on a USB flash drive: `"/path/filename"`

Details

When the *id* parameter is an integer (*n*), it is interpreted as the setup number to restore from the instrument's nonvolatile memory. When *n* = 0, the instrument recalls the factory default setup; when *n* = 1 to 5, the instrument recalls a user-saved setup.

When the *id* parameter is a string, it is interpreted as the path and file name of the setup to restore from a file on a USB flash drive. The path may be absolute or relative to the current working directory.

Before a setup is recalled, an instrument reset is performed.

Example 1

```
setup.recall(1)
```

Recall the user-saved setup at location 1.

Example 2

```
setup.recall("/usb1/KEITHLEY_30730.set")
```

Recall a user-saved setup stored in a file named KEITHLEY_30730 on a USB flash drive.

Also see

[Saved setups](#) (on page 4-51)

[setup.save\(\)](#) (on page 11-176)

setup.save()

This function saves the present setup as a user-saved setup.

Type	TSP-Link accessible	Affected by	Where saved	Default value
Function	Yes			

Usage

```
setup.save(id)
```

id

An integer or string specifying where to save the user setup:

- Save in nonvolatile memory (1 to 5)
- Save as user-saved setup on a USB flash drive ("*/path/filename*")

Details

When the *id* parameter is an integer (*n*), it is interpreted as the setup number to save to the instrument's nonvolatile memory.

NOTE

When you save to a specified integer (1 to 5) in nonvolatile memory, the previous setup at that same location is overwritten.

When the *id* parameter is a string, it is interpreted as the path and file name of the location to save the present setup on a USB flash drive. The path may be absolute or relative to the current working directory.

Example

```
setup.save(5)
```

Saves the present setup to the internal memory of the instrument at location 5.

Also see

[Saved setups](#) (on page 4-51)

[setup.recall\(\)](#) (on page 11-175)

smua.abort()

This function terminates all overlapped operations on the source-measure unit (SMU).

Type	TSP-Link accessible	Affected by	Where saved	Default value
Function	Yes			

Usage

```
smua.abort()
```

Details

The `smua.abort()` function does not turn the output off or change any settings.

If this function is used to abort a sweep, when it is executed, the SMU exits its trigger model immediately and returns to the idle state of the trigger model.

Example

<code>smua.abort()</code>	Terminates all overlapped operations.
---------------------------	---------------------------------------

Also see

- [smua.measure.overlappedY\(\)](#) (on page 11-205)
- [smua.trigger.initiate\(\)](#) (on page 11-247)

smua.buffer.getstats()

This function returns the statistics for a specified reading buffer.

Type	TSP-Link accessible	Affected by	Where saved	Default value
Function	Yes			

Usage

```
statistics = smua.buffer.getstats(bufferVar)
```

<code>statistics</code>	The statistical data about the data in the reading buffer
<code>bufferVar</code>	The reading buffer to process

Details

This function returns a table with statistical data about the data that is placed in the buffer.

The SMU automatically updates reading buffer statistics as data is added to the reading buffer. When the reading buffer is configured to wrap around and overwrite older data with new data, the buffer statistics include the data that was overwritten.

The table returned from this function is a snapshot. Although the SMU continues to update the statistics, the table returned is not updated. To get fresh statistics, call this function again.

The `statistics` parameter has the attributes described in the following table.

Attribute	When returned	Description
<code>n</code>	Always	The number of data points on which the statistics are based
<code>mean</code>	When <code>n > 0</code>	The average of all readings added to the buffer
<code>stddev</code>	When <code>n > 1</code>	The standard deviation of all readings (samples) added to the buffer
<code>min</code>	When <code>n > 0</code>	A table containing data about the minimum reading value added to the buffer
<code>max</code>	When <code>n > 0</code>	A table containing data about the maximum reading value added to the buffer

If `n` equals zero (0), all other attributes are `nil`. If `n` equals 1, the `stddev` attribute is `nil` because the standard deviation of a sample size of 1 is undefined.

The `min` and `max` entries each have the attributes defined in the following table.

Attribute	Description
<code>measurefunction</code>	String indicating the function that was measured for the reading (current, voltage, ohms, or watts)
<code>measurerrange</code>	The full-scale range value for the measurement range used when the measurement was made
<code>reading</code>	The reading value
<code>sourcefunction</code>	String indicating the source function at the time of the measurement (current or voltage)
<code>sourceoutputstate</code>	String indicating the state of the source (off or on)
<code>sourcerange</code>	Full-scale range value for the source range used when the measurement was made
<code>sourcevalue</code>	If <code>bufferVar.collectsourcevalues</code> is enabled, the sourced value in effect at the time of the reading
<code>status</code>	Status value for the reading; the status value is a floating-point number that encodes the status value into a floating-point value
<code>timestamp</code>	If <code>bufferVar.collecttimestamps</code> is enabled, the timestamp, in seconds, between when the reading was acquired and when the first reading in the buffer was acquired; adding this value to the base timestamp will give the actual time the measurement was acquired

Example

```

reset()
smua.nvbuffer1.clear()
smua.measure.count = 10
smua.measure.v(smua.nvbuffer1)
stats = smua.buffer.getstats(smua.nvbuffer1)
print("n= " .. stats.n)
print("mean= " .. stats.mean)
print("stddev= " .. stats.stddev)
print("min= " .. stats.min.reading)
print("max= " .. stats.max.reading)

```

Make measurements and store them in `nvbuffer1`. Print the statistics for the data.

Example output:

```

n= 10
mean= -2.3851394871599e-05
stddev= 4.406545187484e-07
min= -2.4557113647461e-05
max= -2.322196996829e-05

```

Also see

[smua.buffer.recalculatestats\(\)](#) (on page 11-179)

smua.buffer.recalculatestats()

This function recalculates the statistics of the specified reading buffer.

Type	TSP-Link accessible	Affected by	Where saved	Default value
Function	Yes			

Usage

```
smua.buffer.recalculatestats(bufferVar)
```

<i>bufferVar</i>	The reading buffer to process
------------------	-------------------------------

Details

This function causes the SMU to regenerate the reading buffer statistics about the specified reading buffer. Because the SMU automatically updates reading buffer statistics when data is added to the reading buffer, this function is generally not needed. When the reading buffer is configured to wrap around and overwrite older data with new data, the buffer statistics will include the data that was overwritten. Use this function to recalculate the statistics that include only the data that is presently stored in the buffer.

Example

```
smua.buffer.recalculatestats(smua.nvbuffer1)
```

Recalculates the statistics of buffer `smua.nvbuffer1`.

Also see

[bufferVar.fillmode](#) (on page 11-25)

[smua.buffer.getstats\(\)](#) (on page 11-177)

smua.cal.adjustdate

This attribute stores the date of the last calibration adjustment.

Type	TSP-Link accessible	Affected by	Where saved	Default value
Attribute (RW)	Yes	SMU cal. restore	SMU nonvolatile memory	Initially set to factory calibration date

Usage

```
adjustDate = smua.cal.adjustdate
smua.cal.adjustdate = adjustDate
```

<i>adjustDate</i>	Date of the last adjustment
-------------------	-----------------------------

Details

This attribute stores the adjustment date associated with the active calibration set. The adjustment date can be read at any time but can only be assigned a new value when calibration has been enabled with the `smua.cal.unlock()` function.

You cannot change the adjustment date without first making a change to the calibration constants.

Once you change any calibration constants, you must set the adjustment date before you can save the calibration data to the nonvolatile memory of the SMU.

This attribute is stored with the active calibration set. If a different calibration set is restored, this attribute reflects the date stored with that set.

`smua.cal.adjustdate` must be set to the date the adjustment was done using the UTC time and date. The date is stored as the number of seconds since UTC, 12:00 am Jan 1, 1970.

Due to the internal storage format, `smua.cal.adjustdate` is only accurate to within a few minutes of the value set.

Example

```
smua.cal.adjustdate = os.time()
```

Sets the adjustment date to the current time set on the instrument.

Also see

[Adjustment](#) (on page 13-19)
[os.time\(\)](#) (on page 11-152)
[smua.cal.due](#) (on page 11-181)
[smua.cal.lock\(\)](#) (on page 11-182)
[smua.cal.restore\(\)](#) (on page 11-184)
[smua.cal.save\(\)](#) (on page 11-184)
[smua.cal.state](#) (on page 11-185)
[smua.cal.unlock\(\)](#) (on page 11-186)

smua.cal.date

This attribute stores the calibration date of the active calibration set.

Type	TSP-Link accessible	Affected by	Where saved	Default value
Attribute (RW)	Yes	SMU calibration restore	SMU nonvolatile memory	Initially set to factory calibration date

Usage

```
calDate = smua.cal.date
smua.cal.date = calDate
```

```
calDate
```

The calibration date of the active calibration set

Details

This attribute stores the calibration date that is associated with the active calibration set. The calibration date can be read at any time but can only be assigned a new value when calibration has been enabled with the `smua.cal.unlock()` function. It is typically set to the date when the instrument was calibrated.

This attribute is stored with the active calibration set. If a different calibration set is restored, this attribute will reflect the date stored with that set.

`smua.cal.date` must be set to the date the calibration was done using the UTC time and date. The date is stored as the number of seconds since UTC 12:00 am Jan 1, 1970.

Due to the internal storage format, `smua.cal.date` is accurate to within a few minutes of the value set.

Example

```
smua.cal.date = os.time()
```

Sets calibration date to the present time set on the instrument.

Also see

- [Adjustment](#) (on page 13-19)
- [os.time\(\)](#) (on page 11-152)
- [smua.cal.adjustdate](#) (on page 11-179)
- [smua.cal.lock\(\)](#) (on page 11-182)
- [smua.cal.restore\(\)](#) (on page 11-184)
- [smua.cal.save\(\)](#) (on page 11-184)
- [smua.cal.state](#) (on page 11-185)
- [smua.cal.unlock\(\)](#) (on page 11-186)

smua.cal.due

This attribute stores the calibration due date for the next calibration.

Type	TSP-Link accessible	Affected by	Where saved	Default value
Attribute (RW)	Yes	SMU cal. restore	SMU nonvolatile memory	0

Usage

```
calDue = smua.cal.due
smua.cal.due = calDue
```

<i>calDue</i>	Due date of next calibration (0 indicates that no date is set)
---------------	--

Details

This attribute stores the calibration due date associated with the active calibration set. The calibration due date can be read at any time but can only be assigned a new value when calibration has been enabled with the `smua.cal.unlock()` function. It is typically set to the date when the next calibration should be performed.

This attribute is stored with the active calibration set. If a different calibration set is restored, this attribute reflects the due date stored with that set.

`smua.cal.due` must be set to the date the next calibration is required using the UTC time and date. The date is stored as the number of seconds since UTC 12:00 am Jan 1, 1970.

Due to the internal storage format, `smua.cal.due` is only accurate to within a few minutes of the value set.

Example

<code>smua.cal.due = os.time() + 365 * 24 * 60 * 60</code>	Sets the calibration due date equal to one year from the present time set on the instrument.
--	--

Also see

- [Adjustment](#) (on page 13-19)
- [os.time\(\)](#) (on page 11-152)
- [smua.cal.adjustdate](#) (on page 11-179)
- [smua.cal.date](#) (on page 11-180)
- [smua.cal.lock\(\)](#) (on page 11-182)
- [smua.cal.restore\(\)](#) (on page 11-184)
- [smua.cal.state](#) (on page 11-185)
- [smua.cal.unlock\(\)](#) (on page 11-186)

smua.cal.lock()

This function disables the commands that change calibration settings.

Type	TSP-Link accessible	Affected by	Where saved	Default value
Function	Yes			

Usage

```
smua.cal.lock()
```

Details

Before you can lock calibration, the calibration constants must be written to nonvolatile memory or a previous calibration set must be restored. Error code 5012, "Cal data not saved - save or restore before lock," results if this function is called when the calibration state is

```
smua.CALSTATE_CALIBRATING.
```

Example

<code>smua.cal.lock()</code>	Disables calibration functions.
------------------------------	---------------------------------

Also see

[Adjustment](#) (on page 13-19)
[smua.cal.restore\(\)](#) (on page 11-184)
[smua.cal.save\(\)](#) (on page 11-184)
[smua.cal.state](#) (on page 11-185)
[smua.cal.unlock\(\)](#) (on page 11-186)

smua.cal.password

This attribute stores the password required to enable calibration.

Type	TSP-Link accessible	Affected by	Where saved	Default value
Attribute (W)	Yes	Not applicable	SMU nonvolatile memory	"KI0026XX"

Usage

```
smua.cal.password = "newPassword"
```

<code>newPassword</code>	A string that contains the new password
--------------------------	---

Details

A new password can only be assigned when calibration has been unlocked.

The calibration password is write-only and cannot be read.

Example

<code>smua.cal.password = "LetMeIn"</code>	Assigns a new calibration password.
--	-------------------------------------

Also see

[Adjustment](#) (on page 13-19)
[smua.cal.unlock\(\)](#) (on page 11-186)

smua.cal.polarity

This attribute controls which calibration constants are used for all subsequent measurements.

Type	TSP-Link accessible	Affected by	Where saved	Default value
Attribute (RW)	Yes	Instrument reset SMU reset SMU calibration lock Recall setup	Not saved	0 (smua.CAL_AUTO)

Usage

```
calPolarity = smua.cal.polarity
smua.cal.polarity = calPolarity
```

calPolarity

The polarity to use for measurements. Set to one of the following values:

- 0 or `smua.CAL_AUTO`: Automatic polarity detection
- 1 or `smua.CAL_POSITIVE`: Measure with positive polarity calibration constants
- 2 or `smua.CAL_NEGATIVE`: Measure with negative polarity calibration constants

Details

This attribute controls which polarity calibration constants are used to make all subsequent measurements.

This attribute does not affect the `smua.measure.calibrateY()` and `smua.pulser.measure.calibrateY()` commands. The polarity for the measure calibrate commands is dictated by their range parameters. The measure calibration commands require the measurements provided to have been made using the polarity being calibrated.

When making measurements for points far away from zero, the desired polarity constants are inherently used. However, when making measurements near zero, it is possible that the instrument could use the calibration constants from the wrong polarity. Setting `smua.cal.polarity` to positive or negative forces measurements to be made using the calibration constants for a given polarity, rather than basing the choice on the raw measurement data.

This attribute can only be set to positive or negative when calibration is unlocked. This attribute is automatically set to `smua.CAL_AUTO` when calibration is locked.

Example

```
smua.cal.polarity = smua.CAL_POSITIVE
```

Selects positive calibration constants for all subsequent measurements.

Also see

- [Adjustment](#) (on page 13-19)
- [reset\(\)](#) (on page 11-156)
- [smua.cal.lock\(\)](#) (on page 11-182)
- [smua.cal.unlock\(\)](#) (on page 11-186)
- [smua.measure.calibrateY\(\)](#) (on page 11-196)
- [smua.pulser.measure.calibrateY\(\)](#) (on page 11-214)
- [smua.reset\(\)](#) (on page 11-222)

smua.cal.restore()

This function loads a stored set of calibration constants.

Type	TSP-Link accessible	Affected by	Where saved	Default value
Function	Yes			

Usage

```
smua.cal.restore()
smua.cal.restore(calset)
```

calset

The calibration set to be loaded; set *calset* to one of the following values:

- 0 or `smua.CALSET_NOMINAL`: A set of calibration constants that are uncalibrated, but set to nominal values to allow rudimentary functioning of the instrument
- 1 or `smua.CALSET_FACTORY`: The calibration constants when the instrument left the factory
- 2 or `smua.CALSET_DEFAULT`: The normal calibration set
- 3 or `smua.CALSET_PREVIOUS`: The calibration set that was used before the last default set was overwritten

Details

This function overwrites the present set of calibration constants with constants read from nonvolatile memory.

This function is disabled until a successful call to `smua.cal.unlock()` is made.

If *calset* is not specified, `smua.CALSET_DEFAULT` is used.

Example

```
smua.cal.restore() Restores factory calibration constants.
```

Also see

- [Adjustment](#) (on page 13-19)
- [smua.cal.lock\(\)](#) (on page 11-182)
- [smua.cal.unlock\(\)](#) (on page 11-186)

smua.cal.save()

This function stores the active calibration constants to nonvolatile memory.

Type	TSP-Link accessible	Affected by	Where saved	Default value
Function	Yes			

Usage

```
smua.cal.save()
```

Details

This function stores the active set of calibration constants to nonvolatile memory. The previous calibration constants (from the default calibration set) are copied to the previous calibration set (`smua.CALSET_PREVIOUS`) before overwriting the default calibration set.

This function is disabled until a successful call to `smua.cal.unlock()` is made.

If any of the calibration constants have been changed, this function is disabled unless the calibration date, the calibration due date, and the calibration adjust date have been assigned new values.

Example

<code>smua.cal.save()</code>	Stores calibration constants in nonvolatile memory.
------------------------------	---

Also see

- [Adjustment](#) (on page 13-19)
- [smua.cal.adjustdate](#) (on page 11-179)
- [smua.cal.date](#) (on page 11-180)
- [smua.cal.due](#) (on page 11-181)
- [smua.cal.lock\(\)](#) (on page 11-182)
- [smua.cal.restore\(\)](#) (on page 11-184)
- [smua.cal.unlock\(\)](#) (on page 11-186)

smua.cal.state

This attribute returns the present calibration state.

Type	TSP-Link accessible	Affected by	Where saved	Default value
Attribute (R)	Yes	Not applicable	Not saved	Not applicable

Usage

```
calState = smua.cal.state
```

<code>calState</code>	<p>The present calibration state; when reading this attribute, <code>calState</code> has one of the following values:</p> <ul style="list-style-type: none"> ▪ 0 or <code>smua.CALSTATE_LOCKED</code>: Calibration is locked ▪ 1 or <code>smua.CALSTATE_CALIBRATING</code>: The calibration constants or dates have been changed but not yet saved to nonvolatile memory ▪ 2 or <code>smua.CALSTATE_UNLOCKED</code>: Calibration is unlocked but none of the calibration constants or dates have changed since the last save/restore
-----------------------	---

Details

This read-only attribute indicates the calibration state of the instrument: Locked, calibrating, or unlocked.

Example

<pre>calstate = smua.cal.state print(calstate)</pre>	<p>Reads calibration state. Output: 0.000000e+00 The above output indicates that calibration is locked.</p>
--	---

Also see

[Adjustment](#) (on page 13-19)
[smua.cal.lock\(\)](#) (on page 11-182)
[smua.cal.restore\(\)](#) (on page 11-184)
[smua.cal.save\(\)](#) (on page 11-184)
[smua.cal.unlock\(\)](#) (on page 11-186)

smua.cal.unlock()

This function enables the commands that change calibration settings.

Type	TSP-Link accessible	Affected by	Where saved	Default value
Function	Yes			

Usage

```
smua.cal.unlock(password)
```

<i>password</i>	Calibration password
-----------------	----------------------

Details

This function enables the calibration functions to change the calibration settings.

The password when the instrument is shipped from the factory is "KI0026XX".

Example

<code>smua.cal.unlock("KI0026XX")</code>	Unlocks calibration.
--	----------------------

Also see

[Adjustment](#) (on page 13-19)
[smua.cal.lock\(\)](#) (on page 11-182)
[smua.cal.password](#) (on page 11-182)
[smua.cal.state](#) (on page 11-185)

smua.contact.calibratehi()

This function adjusts the high/sense high contact check measurement.

Type	TSP-Link accessible	Affected by	Where saved	Default value
Function	Yes			

Usage

```
smua.contact.calibratehi(cp1Measured, cp1Reference, cp2Measured, cp2Reference)
```

<i>cp1Measured</i>	The value measured by this SMU for point 1
<i>cp1Reference</i>	The reference measurement for point 1 as measured externally
<i>cp2Measured</i>	The value measured by this SMU for point 2
<i>cp2Reference</i>	The reference measurement for point 2 as measured externally

Details

Contact check measurement calibration does not require range information.

Typically, points one and two will be near 0 Ω and 50 Ω, respectively.

All four measurements (*cp1Measured*, *cp1Reference*, *cp2Measured*, and *cp2Reference*) must be made with the calibration set that is active. If not, corruption of the calibration constants may result.

The new calibration constants are activated immediately but are not written to nonvolatile memory. Use `smua.cal.save()` to save the new constants to nonvolatile memory. The active calibration constants stay in effect until the instrument is power cycled or a calibration set is loaded from nonvolatile memory with the `smua.cal.restore()` function.

This function is disabled until a successful call to `smua.cal.unlock()` is made.

Example

```
-- Short SENSE LO and LO terminals.
-- Short SENSE HI and HI terminals.
-- Allow readings to settle, then get measurements.
r0_hi, r0_lo = smua.contact.r()
-- Connect 50 OHM resistor between SENSE LO and LO.
-- Connect 50 OHM resistor between SENSE HI and HI.
-- Allow readings to settle, then get measurements.
r50_hi, r50_lo = smua.contact.r()
smua.contact.calibratelo(r0_lo, Z_actual_lo, r50_lo, 50_ohm_actual_lo)
smua.contact.calibratehi(r0_hi, Z_actual_hi, r50_hi, 50_ohm_actual_hi)
```

The instrument performs a contact check.
 Install and measure two resistors.
 The user sends the contact check LO calibration command.
 The user sends the contact check HI calibration command.

Also see

- [Adjustment](#) (on page 13-19)
- [smua.cal.restore\(\)](#) (on page 11-184)
- [smua.cal.save\(\)](#) (on page 11-184)
- [smua.cal.unlock\(\)](#) (on page 11-186)
- [smua.contact.calibratelo\(\)](#) (on page 11-187)

smua.contact.calibratelo()

This function adjusts the low/sense low contact check measurement.

Type	TSP-Link accessible	Affected by	Where saved	Default value
Function	Yes			

Usage

```
smua.contact.calibratelo(cp1Measured, cp1Reference, cp2Measured, cp2Reference)
```

<i>cp1Measured</i>	The value measured by this SMU for point 1
<i>cp1Reference</i>	The reference measurement for point 1 as measured externally
<i>cp2Measured</i>	The value measured by this SMU for point 2
<i>cp2Reference</i>	The reference measurement for point 2 as measured externally

Details

Contact check measurement adjustment does not require range information.

Typically, points one and two are near 0 Ω and 50 Ω , respectively.

All four measurements (*cp1Measured*, *cp1Reference*, *cp2Measured*, and *cp2Reference*) must be made with the active calibration set. If not, corruption of the calibration constants may result.

The new calibration constants are activated immediately but are not written to nonvolatile memory. Use `smua.cal.save()` to save the new constants to nonvolatile memory. The active calibration constants stay in effect until the instrument is power cycled or a calibration set is loaded from nonvolatile memory with the `smua.cal.restore()` function.

This function is disabled until a successful call to `smua.cal.unlock()` is made.

Example

```
-- Short SENSE LO and LO terminals.
-- Short SENSE HI and HI terminals.
-- Allow readings to settle, then get measurements.
r0_hi, r0_lo = smua.contact.r()

-- Connect 50 OHM resistor between SENSE LO and LO.
-- Connect 50 OHM resistor between SENSE HI and HI.
-- Allow readings to settle, then get measurements.
r50_hi, r50_lo = smua.contact.r()
smua.contact.calibrate_lo(r0_lo, Z_actual_lo, r50_lo, 50_ohm_actual_lo)
smua.contact.calibrate_hi(r0_hi, Z_actual_hi, r50_hi, 50_ohm_actual_hi)
```

The instrument performs a contact check.
Install and measure two resistors.
The user sends the contact check LO calibration command.
The user sends the contact check HI calibration command.

Also see

[Adjustment](#) (on page 13-19)
[smua.cal.restore\(\)](#) (on page 11-184)
[smua.cal.save\(\)](#) (on page 11-184)
[smua.cal.unlock\(\)](#) (on page 11-186)
[smua.contact.calibrate_hi\(\)](#) (on page 11-186)

smua.contact.check()

This function determines if contact resistance is lower than the threshold.

Type	TSP-Link accessible	Affected by	Where saved	Default value
Function	Yes			

Usage

```
smua.contact.check()
```

Details

NOTE

Contact check is not available when the pulser is enabled. If you need to use the contact check function in a pulser application, you can disable the pulser, run the contact check measurements, then enable the pulser. See [Example 1: Ten-point pulse sweep](#) (on page 4-37) for a code example.

This function returns `true` if the contact resistance is below the threshold; this function returns `false` if it is above the threshold. The threshold value is set by the `smua.contact.threshold` attribute.

When the output is on and any of the following:

- SMU is a current source with current range set to less than 1 mA (error code 5065, "I range too low for contact check")
- SMU is a voltage source with current limit set to less than 1 mA (error code 5050, "I limit too low for contact check")

When the output is off and any of the following:

- The output off mode is High-Z (error code 5048, "Contact check not valid with HIGH-Z OUTPUT off")
- The output off mode is Normal with the `smua.source.offfunc` attribute set to `smua.OUTPUT_DCVOLTS` and the off current limit set to less than 1 mA (error code 5066, "source.offlimiti too low for contact check")
- The output off mode is Normal with the `smua.source.offfunc` attribute set to `smua.OUTPUT_DCAMPS` and the source range is less than 1 mA (error code 5065, "I range too low for contact check")

If you attempt to perform a contact check measurement when any of the above conditions exist, an error is generated.

Example

```
if not smua.contact.check() then
  -- take action
end
```

Takes action if contact check fails.

Also see

[Contact check connections](#) (on page 4-12)

[Contact check measurements](#) (on page 4-12)

[smua.contact.speed](#) (on page 11-191)

[smua.contact.threshold](#) (on page 11-192)

[smua.source.offfunc](#) (on page 11-231)

smua.contact.r()

This function measures aggregate contact resistance.

Type	TSP-Link accessible	Affected by	Where saved	Default value
Function	Yes			

Usage

```
rhi, rlo = smua.contact.r()
```

<i>rhi</i>	The measured aggregate contact resistance on the HI/sense HI side
<i>rlo</i>	The measured aggregate contact resistance on the LO/sense LO side

Details

If you attempt to perform a contact resistance measurement when any of the following conditions exist, an error is generated.

- When the output is on and SMU is a current source with current range set to less than 1 mA
- When the output is on and SMU is a voltage source with current limit set to less than 1 mA
- When the output is off and the output off mode is High-Z
- When the output is off and the output off mode is Normal with the `smua.source.offfunc` attribute set to `smua.OUTPUT_DCVOLTS` and the off current limit set to less than 1 mA
- When the output is off and the output off mode is Normal with the `smua.source.offfunc` attribute set to `smua.OUTPUT_DCAMPS` and the source range is less than 1 mA
- When the pulser is enabled (`smua.pulser.enable` attribute is set to `smua.ENABLE`)

NOTE

Contact check is not available when the pulser is enabled. If you need to use the contact check function in a pulser application, you can disable the pulser, run the contact check measurements, then enable the pulser.

Example

```
if not smua.contact.check() then
  smua.contact.speed = smua.CONTACT_SLOW
  rhi, rlo = smua.contact.r()
  print(rhi, rlo)
  exit()
end
```

Check contacts against threshold.
Set speed to slow.
Get resistance readings.
Output contact resistances.
Terminate execution.

Also see

- [Contact check connections](#) (on page 4-12)
- [Contact check measurements](#) (on page 4-12)
- [smua.contact.check\(\)](#) (on page 11-188)
- [smua.contact.speed](#) (on page 11-191)

smua.contact.speed

This attribute stores the speed setting for contact check measurements.

Type	TSP-Link accessible	Affected by	Where saved	Default value
Attribute (RW)	Yes	Instrument reset SMU reset Recall setup	Not saved	0 (smua.CONTACT_FAST)

Usage

```
speedSetting = smua.contact.speed
smua.contact.speed = speedSetting
```

<i>speedSetting</i>	<p>The speed setting. Set to one of the following:</p> <ul style="list-style-type: none"> ▪ 0 or smua.CONTACT_FAST ▪ 1 or smua.CONTACT_MEDIUM ▪ 2 or smua.CONTACT_SLOW
---------------------	---

Details

This setting controls the aperture of measurements made for contact check. It does not affect the `smua.measure.nplc` aperture setting.

The speed setting can have a dramatic effect on the accuracy of the measurement (see the specifications).

NOTE

Contact check is not available when the pulser is enabled. If you need to use the contact check function in a pulser application, you can disable the pulser, run the contact check measurements, then enable the pulser.

Example

```
smua.contact.speed = smua.CONTACT_SLOW
```

Configure contact check for higher accuracy.

Also see

- [Contact check connections](#) (on page 4-12)
- [Contact check measurements](#) (on page 4-12)
- [reset\(\)](#) (on page 11-156)
- [smua.contact.check\(\)](#) (on page 11-188)
- [smua.contact.r\(\)](#) (on page 11-190)
- [smua.reset\(\)](#) (on page 11-222)

smua.contact.threshold

This attribute stores the resistance threshold for the `smua.contact.check()` function.

Type	TSP-Link accessible	Affected by	Where saved	Default value
Attribute (RW)	Yes	Instrument reset SMU reset Recall setup	Not saved	50 (50 Ω)

Usage

```
rValue = smua.contact.threshold
smua.contact.threshold = rValue
```

<code>rValue</code>	The resistance above which contact check should fail (measured in ohms)
---------------------	---

Details

The threshold should be set to less than 1 k Ω .

NOTE

Contact check is not available when the pulser is enabled. If you need to use the contact check function in a pulser application, you can disable the pulser, run the contact check measurements, then enable the pulser.

Example

```
smua.contact.threshold = 5
Set the contact check threshold to 5  $\Omega$ .
```

Also see

[Contact check connections](#) (on page 4-12)
[Contact check measurements](#) (on page 4-12)
[reset\(\)](#) (on page 11-156)
[smua.contact.check\(\)](#) (on page 11-188)
[smua.reset\(\)](#) (on page 11-222)

smua.interlock.enable

This attribute enables or disables use of the interlock signal.

Type	TSP-Link accessible	Affected by	Where saved	Default value
Attribute (RW)	Yes	Not applicable	Nonvolatile memory	smua.DISABLE

Usage

```
interlockState = smua.interlock.enable
smua.interlock.enable = interlockState
```

<code>interlockState</code>	Enable or disable use of the interlock signal: <ul style="list-style-type: none"> ▪ Turn the output off if the interlock signal is not asserted: <code>smua.ENABLE</code> ▪ Ignore the interlock signal: <code>smua.DISABLE</code>
-----------------------------	--

Details

The setting of this attribute must match the jumper setting on the 2601B-P-INT Interlock and Cable Connector Box.

Example

```
smua.interlock.enable = smua.ENABLE
Enable the interlock.
```

Also see

[Using the interlock](#) (on page 2-42)

smua.makebuffer()

This function creates a reading buffer.

Type	TSP-Link accessible	Affected by	Where saved	Default value
Function	Yes			

Usage

```
bufferVar = smua.makebuffer(bufferSize)
```

<i>bufferVar</i>	The created reading buffer
<i>bufferSize</i>	Maximum number of readings that can be stored

Details

Reading buffers can be created and allocated dynamically using this function. Use *bufferSize* to designate the number of readings the buffer can store.

Dynamically allocated reading buffers can be used interchangeably with the `smua.nvbufferY` buffers.

A reading buffer can be deleted by setting all references to the reading buffer equal to `nil`, then running the garbage collector (see the `collectgarbage()` function in [Standard libraries](#) (on page 10-27)).

Example

```
mybuffer2 = smua.makebuffer(200)  Creates a 200 element reading buffer (mybuffer2).
```

Also see

`collectgarbage()` in [Base library functions](#) (on page 10-27)

[Remote reading buffer programming](#) (on page 5-6)

[savebuffer\(\)](#) (on page 11-156)

[smua.nvbufferY](#) (on page 11-211)

smua.measure.autorangeY

This attribute stores the measurement autorange setting.

Type	TSP-Link accessible	Affected by	Where saved	Default value
Attribute (RW)	Yes	Instrument reset SMU reset Recall setup	Saved setup	1 (smua.AUTORANGE_ON)

Usage

```
autoRange = smua.measure.autorangeY
smua.measure.autorangeY = autoRange
```

<i>autoRange</i>	The state of the measurement autorange setting; set to one of the following values: <ul style="list-style-type: none"> ▪ 0 or <code>smua.AUTORANGE_OFF</code>: Disabled ▪ 1 or <code>smua.AUTORANGE_ON</code>: Enabled ▪ 2 or <code>smua.AUTORANGE_FOLLOW_LIMIT</code>: Measure range automatically set to the limit range
Y	SMU measure function (v = voltage, i = current)

Details

This attribute indicates the measurement autorange state. Its value is `smua.AUTORANGE_OFF` when the SMU measure circuit is on a fixed range and `smua.AUTORANGE_ON` when it is in autorange mode.

Setting this attribute to `smua.AUTORANGE_OFF` puts the SMU on a fixed range. The fixed range is the present SMU measure range.

Setting this attribute to `smua.AUTORANGE_ON` puts the SMU measure circuit in autorange mode. It remains on its present measure range until the next measurement is requested.

If source high capacitance mode is enabled, current autorange is set to `smua.AUTORANGE_FOLLOW_LIMIT` and cannot be changed.

Example

```
smua.measure.autorangev = smua.AUTORANGE_ON
Enables voltage measurement autoranging.
```

Also see

- [Autoranging](#) (on page 4-56)
- [Range](#) (on page 4-54)
- [reset\(\)](#) (on page 11-156)
- [setup.recall\(\)](#) (on page 11-175)
- [smua.measure.rangeY](#) (on page 11-206)
- [smua.reset\(\)](#) (on page 11-222)

smua.measure.autozero

This attribute enables or disables automatic updates to the internal reference measurements (autozero) of the instrument.

Type	TSP-Link accessible	Affected by	Where saved	Default value
Attribute (RW)	Yes	Instrument reset SMU reset Recall setup	Saved setup	2 (smua.AUTOZERO_AUTO)

Usage

```
azMode = smua.measure.autozero
smua.measure.autozero = azMode
```

azMode

Indicates status of autozero; set to one of the following values:

- 0 or `smua.AUTOZERO_OFF`: Autozero disabled
- 1 or `smua.AUTOZERO_ONCE`: Performs autozero once, then disables autozero
- 2 or `smua.AUTOZERO_AUTO`: Automatic checking of reference and zero measurements; an autozero is performed when needed

Details

The analog-to-digital converter (ADC) uses a ratiometric A/D conversion technique. To ensure the accuracy of readings, the instrument must periodically obtain new measurements of its internal ground and voltage reference. The time interval between updates to these reference measurements is determined by the integration aperture being used for measurements. The 2601B-PULSE uses separate reference and zero measurements for each aperture.

By default, the instrument automatically checks these reference measurements whenever a signal measurement is made. If the reference measurements have expired when a signal measurement is made, the instrument will automatically take two more A/D conversions, one for the reference and one for the zero, before returning the result. Thus, occasionally, a measurement takes longer than normal.

This additional time can cause problems in sweeps and other test sequences in which measurement timing is critical. To avoid the time that is needed for the reference measurements in these situations, you can use the `smua.measure.autozero` attribute to disable the automatic reference measurements.

Disabling automatic reference measurements may allow the instrument to gradually drift out of specification. To minimize the drift, a reference and zero measurement should be made immediately before any critical test sequences. You can use the `smua.AUTOZERO_ONCE` setting to force a refresh of the reference and zero measurements that are used for the present aperture setting.

The 2601B-PULSE stores the reference measurements for the last ten NPLC settings that were used in a reference cache. If an NPLC setting is selected and an entry for it is not in the cache, the oldest (least recently used) entry is discarded to make room for the new entry.

When the pulser is enabled, two high-speed digitizing sampling ADCs are used to measure voltage and current. These ADCs do not use a ratiometric conversion technique, so the autozero settings are ignored when the pulser is enabled.

Example

```
smua.measure.autozero = smua.AUTOZERO_ONCE
Performs autozero once.
```

Also see

[Autozero](#) (on page 4-41)
[reset\(\)](#) (on page 11-156)
[smua.measure.nplc](#) (on page 11-204)
[setup.recall\(\)](#) (on page 11-175)
[smua.reset\(\)](#) (on page 11-222)

smua.measure.calibrateY()

This function generates and activates new measurement calibration constants.

Type	TSP-Link accessible	Affected by	Where saved	Default value
Function	Yes			

Usage

```
smua.measure.calibrateY(range, cp1Measured, cp1Reference, cp2Measured, cp2Reference)
```

<i>Y</i>	SMU measurement function (v = voltage, i = current)
<i>range</i>	The measurement range to adjust
<i>cp1Measured</i>	The value measured by this SMU for point 1
<i>cp1Reference</i>	The reference measurement for point 1 as measured externally
<i>cp2Measured</i>	The value measured by this SMU for point 2
<i>cp2Reference</i>	The reference measurement for point 2 as measured externally

Details

This function generates and activates new calibration constants for the given range.

The positive and negative polarities of the instrument must be adjusted separately. Use a positive value for the *range* parameter to adjust the positive polarity and a negative value for the *range* parameter to adjust the negative polarity.

All four measurements (*cp1Measured*, *cp1Reference*, *cp2Measured*, and *cp2Reference*) must be made with the calibration set that is active. Corruption of the calibration constants may result if this is ignored.

The new calibration constants are activated immediately but they are not written to nonvolatile memory. Use the `smua.cal.save()` function to save the new constants to nonvolatile memory. The active calibration constants stay in effect until the instrument is power cycled or a calibration set is loaded from nonvolatile memory with the `smua.cal.restore()` function.

This function is only available when calibration is unlocked using `smua.cal.unlock()`.

Example

```
smua.measure.calibratev(1, 1e-4, 1e-5, 0.92, 0.903)
```

Adjust SMU channel A voltage measurement using the following values:

- 1 V calibration range
- 1e-4 for +zero measurement reading
- 1e-5 for +zero DMM measurement reading
- 0.92 for +FS measurement reading
- 0.903 for the +FS DMM measurement reading

Also see

- [Adjustment](#) (on page 13-19)
- [smua.cal.lock\(\)](#) (on page 11-182)
- [smua.cal.restore\(\)](#) (on page 11-184)
- [smua.cal.save\(\)](#) (on page 11-184)
- [smua.cal.unlock\(\)](#) (on page 11-186)
- [smua.source.calibrateY\(\)](#) (on page 11-225)

smua.measure.count

This attribute sets the number of measurements made when a measurement is requested.

Type	TSP-Link accessible	Affected by	Where saved	Default value
Attribute (RW)	Yes	Instrument reset SMU reset Recall setup	Saved setup	1

Usage

```
count = smua.measure.count
smua.measure.count = count
```

<code>count</code>	Number of measurements
--------------------	------------------------

Details

This attribute controls the number of measurements made any time a measurement is requested. When using a reading buffer with a measure command, this attribute also controls the number of readings to be stored.

If the count is set to a value greater than 1, any measurement delay set by `smua.measure.delay` only occurs before the first measurement, while the `smua.measure.interval` controls the interval between successive measurements.

When the pulser is enabled and measurements are not overlapped, this attribute must be less than 3500.

Example

<code>smua.measure.count = 10</code>	Sets the measure count to 10.
--------------------------------------	-------------------------------

Also see

- [reset\(\)](#) (on page 11-156)
- [setup.recall\(\)](#) (on page 11-175)
- [smua.measure.delay](#) (on page 11-198)
- [smua.measure.interval](#) (on page 11-202)
- [smua.measure.overlappedY\(\)](#) (on page 11-205)
- [smua.measure.Y\(\)](#) (on page 11-209)
- [smua.reset\(\)](#) (on page 11-222)

smua.measure.delay

This attribute controls the measurement delay.

Type	TSP-Link accessible	Affected by	Where saved	Default value
Attribute (RW)	Yes	Instrument reset SMU reset Recall setup	Saved setup	0 (smua.DELAY_OFF)

Usage

```
mDelay = smua.measure.delay
smua.measure.delay = mDelay
```

<i>mDelay</i>	<p>Set to the measurement delay value in seconds (for example, to specify an additional 10 ms measurement delay, set the value to 0.010)</p> <p>You can also set it to one of the following values:</p> <ul style="list-style-type: none"> ■ 0 or <code>smua.DELAY_OFF</code>: No delay ■ -1 or <code>smua.DELAY_AUTO</code>: Automatic delay value
---------------	---

Details

This attribute allows for additional delay (settling time) before making a measurement. If you define the value instead of using the automatic delay value, the delay you set is used regardless of the range.

The `smua.DELAY_AUTO` setting causes a current range-dependent delay to be inserted when a current measurement is requested. This happens when a current measurement command is executed, when the measure action is being performed in a sweep, or after changing ranges during an autoranged measurement.

If `smua.measure.count` is greater than 1, the measurement delay is only inserted before the first measurement.

Example

```
smua.measure.delay = 0.010
```

Sets a 10 ms measurement delay.

Also see

[Measure auto delay](#) (on page 4-55)
[reset\(\)](#) (on page 11-156)
[smua.measure.count](#) (on page 11-197)
[smua.measure.delayfactor](#) (on page 11-199)
[smua.source.delay](#) (on page 11-226)
[smua.reset\(\)](#) (on page 11-222)

smua.measure.delayfactor

This attribute stores a multiplier to the delays that are used when `smua.measure.delay` is set to `smua.DELAY_AUTO`.

Type	TSP-Link accessible	Affected by	Where saved	Default value
Attribute (RW)	Yes	Instrument reset SMU reset Recall setup	Not saved	1

Usage

```
delayFactor = smua.measure.delayfactor
smua.measure.delayfactor = delayFactor
```

<code>delayFactor</code>	The delay factor multiplier
--------------------------	-----------------------------

Details

The delay factor is only applied when `smua.measure.delay = smua.DELAY_AUTO`.

This attribute can be set to a value less than 1 (for example, 0.5) to decrease the automatic delay.

This attribute can be set to a value greater than 1 (for example, 1.5 or 2.0) to increase the automatic delay.

Setting this attribute to zero disables delays when `smua.measure.delay = smua.DELAY_AUTO`.

Example

<code>smua.measure.delayfactor = 2.0</code>	Doubles the measure delay.
---	----------------------------

Also see

- [Measure auto delay](#) (on page 4-55)
- [reset\(\)](#) (on page 11-156)
- [smua.measure.delay](#) (on page 11-198)
- [smua.reset\(\)](#) (on page 11-222)

smua.measure.filter.count

This command sets the number of measured readings that are required to yield one filtered measurement.

Type	TSP-Link accessible	Affected by	Where saved	Default value
Attribute (RW)	Yes	Instrument reset SMU reset Recall setup	Saved setup	1

Usage

```
filterCount = smua.measure.filter.count
smua.measure.filter.count = filterCount
```

<code>filterCount</code>	The number of readings required for each filtered measurement (1 to 100)
--------------------------	--

Details

This attribute sets the size of the stack used for filtered measurements.

Example

```
smua.measure.filter.count = 10
smua.measure.filter.type = smua.FILTER_MOVING_AVG
smua.measure.filter.enable = smua.FILTER_ON
```

Sets the filter count to 10.
Sets the filter type to moving average.
Enables the filter.

Also see

[Filters](#) (on page 4-77)
[reset\(\)](#) (on page 11-156)
[setup.recall\(\)](#) (on page 11-175)
[smua.measure.filter.type](#) (on page 11-201)
[smua.reset\(\)](#) (on page 11-222)

smua.measure.filter.enable

This command enables or disables filtered measurements.

Type	TSP-Link accessible	Affected by	Where saved	Default value
Attribute (RW)	Yes	Instrument reset SMU reset Recall setup	Saved setup	0 (smua.FILTER_OFF)

Usage

```
filterState = smua.measure.filter.enable
smua.measure.filter.enable = filterState
```

filterState

The filter status; set to one of the following values:

- 0 or smua.FILTER_OFF: Disables the filter
- 1 or smua.FILTER_ON: Enables the filter

Details

This command enables or disables the filter.

Example

```
smua.measure.filter.count = 10
smua.measure.filter.type = smua.FILTER_MOVING_AVG
smua.measure.filter.enable = smua.FILTER_ON
```

Sets the filter count to 10.
Sets the filter type to moving average.
Enables the filter.

Also see

[Filters](#) (on page 4-77)
[reset\(\)](#) (on page 11-156)
[setup.recall\(\)](#) (on page 11-175)
[smua.measure.filter.count](#) (on page 11-199)
[smua.measure.filter.type](#) (on page 11-201)
[smua.reset\(\)](#) (on page 11-222)

smua.measure.filter.type

This command sets the type of filter used for measurements when the measurement filter is enabled.

Type	TSP-Link accessible	Affected by	Where saved	Default value
Attribute (RW)	Yes	Instrument reset SMU reset Recall setup	Saved setup	1 (smua.FILTER_REPEAT_AVG)

Usage

```
filterType = smua.measure.filter.type
smua.measure.filter.type = filterType
```

filterType

The filter type to use when filtering is enabled. Set to one of the following values:

- 0 or `smua.FILTER_MOVING_AVG`: Selects the moving filter
- 1 or `smua.FILTER_REPEAT_AVG`: Selects the repeat filter
- 2 or `smua.FILTER_MEDIAN`: Selects the median filter

Details

The 2601B-PULSE provides a moving average, repeating average, and median filter type.

For the repeating filter, the stack (filter count) is filled, and the conversions are averaged to yield a reading. The stack is then cleared, and the process starts over.

The moving average filter uses a first-in, first-out stack. When the stack (filter count) becomes full, the measurement conversions are averaged, yielding a reading. For each subsequent conversion placed into the stack, the oldest conversion is discarded. The stack is re-averaged, yielding a new reading.

The median filter uses a first-in, first-out stack. When the stack (filter count) becomes full, the reading nearest to the middle is returned. For each subsequent conversion placed into the stack, the oldest reading is discarded. The stack is then re-sorted, yielding a new reading. If the filter count is an even number, the reading returned is the average of the two middle readings.

NOTE

If the pulser is enabled, the repeating filter is the only available filter.

Example

```
smua.measure.filter.count = 10
smua.measure.filter.type = smua.FILTER_MOVING_AVG
smua.measure.filter.enable = smua.FILTER_ON
```

Sets the filter count to 10.
Sets the filter type to moving average.
Enables the filter.

Also see

- [Filters](#) (on page 4-77)
- [reset\(\)](#) (on page 11-156)
- [setup.recall\(\)](#) (on page 11-175)
- [smua.measure.filter.count](#) (on page 11-199)
- [smua.measure.filter.enable](#) (on page 11-200)
- [smua.reset\(\)](#) (on page 11-222)

smua.measure.highcrangedelayfactor

This attribute contains a delay multiplier that is only used during range changes when the high-capacitance mode is active.

Type	TSP-Link accessible	Affected by	Where saved	Default value
Attribute (RW)	Yes	Instrument reset SMU reset Recall setup	Saved setup	10

Usage

```
delayFactor = smua.measure.highcrangedelayfactor
smua.measure.highcrangedelayfactor = delayFactor
```

<code>delayFactor</code>	The delay factor; set to a value between 1 and 99
--------------------------	---

Details

This delay multiplier is only active when the high-capacitance mode is active.

Example

<code>smua.measure.highcrangedelayfactor = 5</code>	Increases the delay used during range changes by a factor of 5.
---	---

Also see

[High-capacitance mode](#) (on page 4-80)
[reset\(\)](#) (on page 11-156)
[setup.recall\(\)](#) (on page 11-175)
[smua.reset\(\)](#) (on page 11-222)
[smua.source.highc](#) (on page 11-228)

smua.measure.interval

This attribute sets the interval between multiple measurements.

Type	TSP-Link accessible	Affected by	Where saved	Default value
Attribute (RW)	Yes	Instrument reset SMU reset Recall setup	Saved setup	0 (0 s)

Usage

```
interval = smua.measure.interval
smua.measure.interval = interval
```

<code>interval</code>	The interval value (in seconds); set to a value between 0 and 1
-----------------------	---

Details

This attribute sets the time interval between measurements when `smua.measure.count` is set to a value greater than 1.

The SMU attempts to start each measurement when scheduled. When the pulser is disabled, if the SMU cannot keep up with the interval setting, measurements are made as quickly as possible. When the pulser is enabled and the trigger model is not configured for asynchronous measurements, if the SMU cannot keep up with the interval setting, it aborts the sweep and turns the output off.

If filtered measurements are being made, the time interval is from the start of the first measurement for the filtered reading to the first measurement for a subsequent filtered reading. Extra measurements made to satisfy a filtered reading are not paced by this interval.

When the measure count is greater than 1 and the pulser is enabled, the measure interval must be less than 65 ms.

Example

```
smua.measure.interval = 0.5
Sets the measure interval to 0.5 s.
```

Also see

- [reset\(\)](#) (on page 11-156)
- [setup.recall\(\)](#) (on page 11-175)
- [smua.measure.count](#) (on page 11-197)
- [smua.reset\(\)](#) (on page 11-222)

smua.measure.lowrangeY

This attribute sets the lowest measurement range that is used when the instrument is autoranging.

Type	TSP-Link accessible	Affected by	Where saved	Default value
Attribute (RW)	Yes	Instrument reset SMU reset Recall setup	Saved setup	Current: 100e-9 (100 nA) Voltage: 100e-3 (100 mV)

Usage

```
lowRange = smua.measure.lowrangeY
smua.measure.lowrangeY = lowRange
```

<i>lowRange</i>	The lowest voltage or current measurement range used during autoranging
<i>Y</i>	SMU measure function (<i>v</i> = voltage, <i>i</i> = current)

Details

This attribute is used with autoranging to put a lower bound on the range used. Since lower ranges generally require greater settling times, setting a lowest range limit might make measurements require less settling time.

If the instrument is set to autorange and it is on a range lower than the one specified, the range is changed to the *lowRange* range value.

Example

```
smua.measure.lowrangev = 1
Sets voltage low range to 1 V.
```

Also see

[Range](#) (on page 4-54)
[reset\(\)](#) (on page 11-156)
[setup.recall\(\)](#) (on page 11-175)
[smua.measure.autorangeY](#) (on page 11-194)
[smua.reset\(\)](#) (on page 11-222)

smua.measure.nplc

This command sets the integration aperture for measurements when the pulser is disabled.

Type	TSP-Link accessible	Affected by	Where saved	Default value
Attribute (RW)	Yes	Instrument reset SMU reset Recall setup	Saved setup	1.0

Usage

```

nplc = smua.measure.nplc
smua.measure.nplc = nplc

```

<i>nplc</i>	The integration aperture; set from 0.001 to 25
-------------	--

Details

This attribute controls the integration aperture for the analog-to-digital converter (ADC) that is used when the pulser is disabled.

The integration aperture is based on the number of power line cycles (NPLC), where 1 PLC for 60 Hz is 16.67 ms (1/60) and 1 PLC for 50 Hz is 20 ms (1/50).

Example

```

smua.measure.nplc = 0.5

```

Sets the integration time to 0.5.

Also see

[Speed](#) (on page 4-60)
[reset\(\)](#) (on page 11-156)
[setup.recall\(\)](#) (on page 11-175)
[smua.pulser.measure.aperture](#) (on page 11-213)
[smua.reset\(\)](#) (on page 11-222)

smua.measure.overlappedY()

This function starts an asynchronous (background) measurement.

Type	TSP-Link accessible	Affected by	Where saved	Default value
Function	No			

Usage

```
smua.measure.overlappedY(rbuffer)
smua.measure.overlappediv(ibuffer, vbuffer)
```

<i>Y</i>	SMU measurement type (<i>v</i> = voltage, <i>i</i> = current, <i>r</i> = resistance, <i>p</i> = power)
<i>rbuffer</i>	A reading buffer object where the readings are stored
<i>ibuffer</i>	A reading buffer object where current readings are stored
<i>vbuffer</i>	A reading buffer object where voltage readings are stored

Details

This function starts a measurement and returns immediately. The measurements, as they are performed, are stored in a reading buffer (along with any other information that is being acquired). If the instrument is configured to return multiple readings where one is requested, the readings are available as they are made. Measurements are in the following units of measure: *v* = volts, *i* = amperes, *r* = ohms, *p* = watts.

The second form of this function, `smua.measure.overlappediv()`, stores current readings in *ibuffer* and voltage readings in *vbuffer*.

This function is an overlapped command. Script execution continues while the measurements are made in the background. Attempts to access result values that have not yet been generated cause the script to block and wait for the data to become available. The `waitcomplete()` function can also be used to wait for the measurements to complete before continuing.

If a given reading buffer contains any data, it is cleared before making any measurements, unless the reading buffer has been configured to append data.

Example

```
smua.measure.overlappedv(smua.nvbuffer1)
Starts background voltage measurements.
```

Also see

[Reading buffers](#) (on page 5-1)
[smua.measure.Y\(\)](#) (on page 11-209)
[smua.nvbufferY](#) (on page 11-211)
[waitcomplete\(\)](#) (on page 11-393)

smua.measure.rangeY

This attribute contains the positive full-scale value of the measurement range for voltage or current.

Type	TSP-Link accessible	Affected by	Where saved	Default value
Attribute (RW)	Yes	Instrument reset SMU reset Recall setup	Saved setup	Voltage: 100e-3 (100 mV) Current: 100e-3 (100 mA)

Usage

```
rangeValue = smua.measure.rangeY
smua.measure.rangeY = rangeValue
```

<i>rangeValue</i>	Set to the maximum expected voltage or current to be measured
<i>Y</i>	SMU measurement function (<i>v</i> = voltage, <i>i</i> = current)

Details

Reading this attribute returns the positive full-scale value of the measurement range that the SMU is currently using. Assigning a value to this attribute sets the SMU on a fixed range large enough to measure the assigned value. The instrument will select the best range for measuring a value of *rangeValue*.

This attribute is primarily intended to eliminate the time that is required by the automatic range selection performed by a measuring instrument. Because selecting a fixed range prevents autoranging, an overrange condition can occur. For example, measuring 10.0 V on the 6 V range causes an overrange. The value 9.91000E+37 is returned when this occurs.

If the source function is the same as the measurement function (for example, sourcing voltage and measuring voltage), the measurement range is locked to be the same as the source range. However, the setting for the measure range is retained. If the source function is changed (for example, from sourcing voltage to sourcing current), the retained measurement range is used.

For example, assume the source function is voltage. The source range is 1 V and you set the measure range for 6 V. Since the source range is 1 V, the SMU performs voltage measurements on the 1 V range. If you now change the source function to current, voltage measurements are made on the 6 V range.

Explicitly setting a measure range will disable measure autoranging for that function. Autoranging is controlled separately for each source and measurement function: source voltage, source current, measure voltage and measure current. Autoranging is enabled for all four by default.

Changing the range while the output is off does not update the hardware settings, but querying returns the range setting that will be used once the output is turned on. Setting a range while the output is on takes effect immediately.

With measure autoranging enabled, the range is changed only when a measurement is taken. Querying the range after a measurement returns the range selected for that measurement.

Example

```
smua.measure.rangev = 0.5
```

Selects the 1 V measurement range.

Also see

- [Range](#) (on page 4-54)
- [reset\(\)](#) (on page 11-156)
- [setup.recall\(\)](#) (on page 11-175)
- [smua.measure.autorangeY](#) (on page 11-194)
- [smua.pulser.rangeY](#) (on page 11-220)
- [smua.reset\(\)](#) (on page 11-222)
- [smua.source.rangeY](#) (on page 11-235)

smua.measure.rel.enableY

This attribute turns relative measurements on or off.

Type	TSP-Link accessible	Affected by	Where saved	Default value
Attribute (RW)	Yes	Instrument reset SMU reset Recall setup	Not saved	0 (smua.REL_OFF)

Usage

```
relEnable = smua.measure.rel.enableY
smua.measure.rel.enableY = relEnable
```

<i>relEnable</i>	Relative measurement control. Set <i>relEnable</i> to one of the following values: <ul style="list-style-type: none"> ▪ 0 or smua.REL_OFF: Disables relative measurements ▪ 1 or smua.REL_ON: Enables relative measurements
Y	SMU measurement function (v = voltage, i = current, r = resistance, p = power)

Details

This attribute enables or disables relative measurements. When relative measurements are enabled, all subsequent measured readings are offset by the relative offset value specified by `smua.measure.rel.levelY`. Each returned measured relative reading is the result of the following calculation:

$$\text{Relative reading} = \text{Actual measured reading} - \text{Relative offset value}$$

Example

<code>smua.measure.rel.enablev = smua.REL_ON</code>	Enables relative voltage measurements.
---	--

Also see

- [Relative offset](#) (on page 4-75)
- [reset\(\)](#) (on page 11-156)
- [setup.recall\(\)](#) (on page 11-175)
- [smua.measure.rel.levelY](#) (on page 11-208)
- [smua.reset\(\)](#) (on page 11-222)

smua.measure.rel.levelY

This attribute sets the offset value for relative measurements.

Type	TSP-Link accessible	Affected by	Where saved	Default value
Attribute (RW)	Yes	Instrument reset SMU reset Recall setup	Not saved	0

Usage

```
relValue = smua.measure.rel.levelY
smua.measure.rel.levelY = relValue
```

<i>relValue</i>	Relative measurement offset value
Y	SMU measurement function (v = voltage, i = current, r = resistance, p = power)

Details

This attribute specifies the offset value used for relative measurements. When relative measurements are enabled (see `smua.measure.rel.enableY`), all subsequent measured readings will be offset by the value of this attribute. Each returned measured relative reading is the result of the following calculation:

$$\text{Relative reading} = \text{Actual measured reading} - \text{Relative offset value}$$

Example

```
smua.measure.rel.levelv = smua.measure.v()
```

Performs a voltage measurement and then uses it as the relative offset value.

Also see

- [Relative offset](#) (on page 4-75)
- [reset\(\)](#) (on page 11-156)
- [smua.measure.rel.enableY](#) (on page 11-207)
- [smua.reset\(\)](#) (on page 11-222)

smua.measure.Y()

This function makes one or more measurements.

Type	TSP-Link accessible	Affected by	Where saved	Default value
Function	Yes			

Usage

```

reading = smua.measure.Y()
reading = smua.measure.Y(readingBuffer)
iReading, vReading = smua.measure.iv()
iReading, vReading = smua.measure.iv(iReadingBuffer)
iReading, vReading = smua.measure.iv(iReadingBuffer, vReadingBuffer)

```

<i>reading</i>	Returned value of the last (or only) reading of the measurement process
<i>Y</i>	SMU measurement function (v = voltage, i = current, r = resistance, p = power)
<i>readingBuffer</i>	A reading buffer object where all readings are stored
<i>iReading</i>	The last reading of the current measurement process
<i>vReading</i>	The last reading of the voltage measurement process
<i>iReadingBuffer</i>	A reading buffer object where current readings are stored
<i>vReadingBuffer</i>	A reading buffer object where voltage readings are stored

Details

If you use this function without specifying a reading buffer, it makes one measurement and returns that measurement as *reading*. To use the additional information that is acquired while making a measurement or to return multiple readings, specify a reading buffer. If the instrument is configured to return multiple readings for a measurement and *readingBuffer* is specified, all readings are available in *readingBuffer*, but only the last measurement is returned as *reading*.

Measurements are in the following units of measure:

- v = volts
- i = amperes
- r = ohms
- p = watts

The `smua.measure.iv()` function returns the last actual current measurement and voltage measurement as *iReading* and *vReading*, respectively. Additionally, it can store current and voltage readings if buffers are provided (*iReadingBuffer* and *vReadingBuffer*).

The `smua.measure.count` attribute determines how many measurements are performed. When using a reading buffer, it also determines the number of readings to store in the buffer. If a reading buffer is not specified, the SMU ignores the `smua.measure.count` attribute and only makes one measurement.

The *readingBuffer* is cleared before making any measurements unless the buffer is configured to append data.

Example

<pre>smua.measure.count = 10 smua.measure.v(smua.nvbuffer1)</pre>	Makes 10 voltage measurements using SMU channel A and stores them in a buffer.
---	--

Also see

[Reading buffers](#) (on page 5-1)
[smua.measure.count](#) (on page 11-197)
[smua.measure.overlappedY\(\)](#) (on page 11-205)
[smua.nvbufferY](#) (on page 11-211)

smua.measureYandstep()

This function makes one or two measurements and then steps the source.

Type	TSP-Link accessible	Affected by	Where saved	Default value
Function	Yes			

Usage

```

reading = smua.measureYandstep(sourceValue)
iReading, vReading = smua.measureivandstep(sourceValue)

```

<i>reading</i>	The measured reading before stepping the source
<i>Y</i>	SMU measurement function (v = voltage, i = current, r = resistance, p = power)
<i>sourceValue</i>	Source value to be set after the measurement is made
<i>iReading</i>	The current reading before stepping the source
<i>vReading</i>	The voltage reading before stepping the source

Details

The `smua.measureYandstep()` function makes a measurement and then sets the source to `sourceValue`. The `smua.measureivandstep()` function makes two measurements simultaneously, one for current (*i*) and one for voltage (*v*), and then sets the source to `sourceValue`.

Measurements are in the following units of measure: *v* = volts, *i* = amperes, *r* = ohms, *p* = watts.

The specified source value should be appropriate for the selected source function. For example, if the source voltage function is selected, then `sourceValue` is expected to be a new voltage level.

Both source and measure autorange must be disabled before using this function. This function cannot be used if source high-capacitance mode is enabled (high-capacitance mode requires autoranging to be enabled).

This function is provided for very fast execution of source-measure loops. The measurement is made before the source is stepped. Before using this function, and before any loop this function may be used in, set the source value to its initial level.

NOTE

This function is not available when the pulser is enabled.

Example

```

local ivalues = {}
smua.source.rangev = 1
smua.source.levelv = 0
smua.measure.rangei = 0.01
smua.source.output = smua.OUTPUT_ON
for index = 1, 10 do
    ivalues[index] = smua.measureiandstep(index / 10)
end
ivalues[11] = smua.measure.i()

```

This use of the measure and step function measures current, starting at a source value of 0 V. After each current measurement, the source is stepped 100 mV for the next current measurement. The final source level is 1 V, where current is measured again.

Also see

[smua.measure.autorangeY](#) (on page 11-194)
[smua.measure.Y\(\)](#) (on page 11-209)
[smua.source.autorangeY](#) (on page 11-224)
[smua.trigger.source.limitY](#) (on page 11-253)
[smua.trigger.source.linearY\(\)](#) (on page 11-254)
[smua.trigger.source.listY\(\)](#) (on page 11-255)
[smua.trigger.source.logY\(\)](#) (on page 11-256)
[Sweep Operation](#) (on page 4-61)

smua.nvbufferY

This attribute contains a dedicated reading buffer.

Type	TSP-Link accessible	Affected by	Where saved	Default value
Attribute (R)	Yes	Not applicable	See Details	Not applicable

Usage

```
bufferVar = smua.nvbufferY
```

<i>bufferVar</i>	The dedicated reading buffer
<i>Y</i>	Nonvolatile buffer (1 or 2)

Details

The SMU contains two dedicated reading buffers: `smua.nvbuffer1` and `smua.nvbuffer2`.

All routines that return measurements can also store them in either reading buffer. Overlapped measurements are always stored in a reading buffer. Synchronous measurements return either a single-point measurement or can be stored in a reading buffer if passed to the measurement command.

The dedicated reading buffers can be saved to internal nonvolatile memory (to retain data between power cycles) using the `smua.savebuffer()` function.

Example

```
smua.measure.overlappedv(smua.nvbuffer1)
Store voltage readings into dedicated reading buffer 1.
```

Also see

- [Configuring and running sweeps](#) (on page 4-71)
- [Reading buffers](#) (on page 5-1)
- [savebuffer\(\)](#) (on page 11-156)
- [smua.makebuffer\(\)](#) (on page 11-193)
- [smua.measure.overlappedY\(\)](#) (on page 11-205)
- [smua.savebuffer\(\)](#) (on page 11-222)
- [smua.trigger.measure.action](#) (on page 11-248)
- [smua.trigger.measure.set\(\)](#) (on page 11-249)
- [smua.trigger.measure.stimulus](#) (on page 11-250)
- [smua.trigger.measure.Y\(\)](#) (on page 11-251)

smua.pulser.enable

This attribute enables or disables the 2601B-PULSE pulser.

Type	TSP-Link accessible	Affected by	Where saved	Default value
Attribute (RW)	Yes	Instrument reset SMU reset Recall setup	Saved setup	smua.DISABLE

Usage

```
enable = smua.pulser.enable
smua.pulser.enable = enable
```

<i>enable</i>	Enable or disable the pulser; set to: <ul style="list-style-type: none"> ▪ <code>smua.DISABLE</code>: Conventional pulsing and full source-measure unit (SMU) functionality ▪ <code>smua.ENABLE</code>: Allow fast-edge pulsing using the trigger model
---------------	---

Details

When the pulser is enabled, there are the following differences in source-measure unit (SMU) functionality:

- You can only source current (not voltage).
- If the output exceeds a maximum pulse width, maximum duty cycle, or the specified protection level during a sweep, the 2601B-PULSE output is shorted, but the sweep continues with no source output until it is finished.
- Some SMU settings are ignored; see [Settings ignored when the pulser is enabled](#) (on page 4-36) for details.
- The `smua.trigger.source.pulsewidth` and `smua.pulser.measure.delay` attributes provide more precise timing than you can achieve using the `smua.trigger.endpulse.stimulus` and `smua.trigger.measure.stimulus` attributes.
- Some of the output-off modes behave differently:
 - **OUTPUT_NORMAL**: The output circuit is shorted when this output-off mode is selected.
 - **OUTPUT_ZERO**: The output circuit is shorted and measurements cannot be made when this output-off mode is selected.
- You cannot use contact check.

- You cannot make measurements when the output is off.
- Compliance limits (`smua.source.limitY`) are not used to control the output. Pulser protection levels are used instead. Refer to [Pulser protection levels](#) (on page 4-4) for information.

Example

```
smua.pulser.enable = smua.ENABLE
Enable the pulser.
```

Also see

- [Pulser operation](#) (on page 4-33)
- [smua.pulser.measure.delay](#) (on page 11-215)
- [smua.trigger.source.pulsewidth](#) (on page 11-258)

smua.pulser.measure.aperture

This attribute specifies the pulse measurement aperture when the pulser is enabled.

Type	TSP-Link accessible	Affected by	Where saved	Default value
Attribute (RW)	Yes	Instrument reset SMU reset Recall setup	Saved setup	0.000001

Usage

```
aperture = smua.pulser.measure.aperture
smua.pulser.measure.aperture = aperture
```

<i>aperture</i>	The measurement aperture; set from 0.000001 s to 0.1 s
-----------------	--

Details

When using this attribute with the trigger model or in a pulse-width limited region, the sum of the measure delay and the total measure time must be less than the pulse width. The total measure time depends on the measure count, the filter count, and the measure interval.

The settings for this attribute are ignored if the pulser is disabled.

Example

```
smua.pulser.measure.aperture = 10e-6
Set the measurement aperture to 10 μs.
```

Also see

- [smua.trigger.source.pulsewidth](#) (on page 11-258)

smua.pulser.measure.calibrateY()

This function generates and activates new measurement calibration constants for the pulser.

Type	TSP-Link accessible	Affected by	Where saved	Default value
Function	Yes			

Usage

```
smua.pulser.measure.calibrateY(range, cp1Measured, cp1Reference, cp2Measured,
cp2Reference)
```

<i>range</i>	The pulse measurement range to adjust
<i>Y</i>	The measurement function (v = voltage, i = current)
<i>cp1Measured</i>	The value measured by this SMU for point 1
<i>cp1Reference</i>	The reference measurement for point 1 as measured externally
<i>cp2Measured</i>	The value measured by this SMU for point 2
<i>cp2Reference</i>	The reference measurement for point 2 as measured externally

Details

This function generates and activates new calibration constants for the given range.

The positive and negative polarities of the instrument must be adjusted separately. Use a positive value for the *range* parameter to adjust the positive polarity and a negative value for the *range* parameter to adjust the negative polarity.

The new calibration constants are activated immediately but they are not written to nonvolatile memory. Use the `smua.cal.save()` function to save the new constants to nonvolatile memory. The active calibration constants stay in effect until the instrument is power cycled or a calibration set is loaded from nonvolatile memory with the `smua.cal.restore()` function.

This function is only available when calibration is unlocked using `smua.cal.unlock()`.

Example

```
smua.pulser.measure.calibratei(1, 0.01, 0.011, 0.75, 0.76)
```

Adjusts the current measurement using the following values:

- 1 A measurement range
- 0.01 for the +zero measurement reading
- 0.011 for the +zero DMM measurement reading
- 0.75 for the + full-scale measurement reading
- 0.76 for the + full-scale DMM measurement reading

Also see

- [Calibration](#) (on page 13-1)
- [smua.cal.restore\(\)](#) (on page 11-184)
- [smua.cal.save\(\)](#) (on page 11-184)
- [smua.cal.unlock\(\)](#) (on page 11-186)
- [smua.pulser.source.calibratebiasi\(\)](#) (on page 11-219)
- [smua.pulser.source.calibratei\(\)](#) (on page 11-221)

smua.pulser.measure.delay

This attribute sets the measurement delay when the pulser is enabled.

Type	TSP-Link accessible	Affected by	Where saved	Default value
Attribute (RW)	Yes	Instrument reset SMU reset Recall setup	Saved setup	0

Usage

```
delay = smua.pulser.measure.delay
smua.pulser.measure.delay = delay
```

<code>delay</code>	The measurement delay value in seconds; set from 0 to 0.065
--------------------	---

Details

Use this attribute with the trigger model when performing a pulse sweep.

Set the `delay` parameter to a nonzero value to specify when a measurement starts during a pulse. The measurement starts after the delay interval expires. This allows the 2601B-PULSE to locate measurements within a pulse with less jitter than those generated using the measure trigger stimulus in the trigger model.

The sum of the measure delay and the total measure time must be less than the pulse width configured with the `smua.trigger.source.pulsewidth` setting. The total measure time depends on the measure count, the filter count, and the measure interval.

You cannot use this attribute and a measurement stimulus in the trigger model at the same time.

CAUTION

Using both the end-pulse stimulus and this attribute in a script may cause the pulse output to end before the specified duration of the pulse is completed, causing invalid measurements.

When this attribute is set to zero, measurements are only triggered by a measurement stimulus.

The settings for this attribute are ignored if the pulser is disabled.

Example

```
smua.pulser.measure.delay = 35e-6
smua.pulser.measure.aperture = 10e-6
```

Specify a 35 μ s pulse measure delay and a 10 μ s measurement aperture.

Also see

[Triggering](#) (on page 6-1)
[smua.pulser.enable](#) (on page 11-212)
[smua.pulser.measure.aperture](#) (on page 11-213)
[smua.trigger.source.pulsewidth](#) (on page 11-258)

smua.pulser.protect.sensev

This attribute sets a voltage protection level used to monitor the sense terminals when the pulser is enabled.

Type	TSP-Link accessible	Affected by	Where saved	Default value
Attribute (RW)	Yes	Instrument reset SMU reset Recall setup	Saved setup	20 V

Usage

```
level = smua.pulser.protect.sensev
smua.pulser.protect.sensev = level
```

<i>level</i>	The voltage protection level when the pulser is enabled; the value must be between 5% and 200% of the voltage range set by the <code>smua.pulser.rangeY</code> attribute
--------------	--

Details

If the voltage on the sense terminals goes above the protection level, the 2601B-PULSE output is shorted for the remainder of the sweep and the output turns off at the end of the sweep.

The current pulse terminates within 3 μ s after the remotely sensed voltage from the device under test (DUT) exceeds the specified level.

CAUTION

Setting the protection level does not guarantee that the output will not go above the protection level. The 2601B-PULSE turns off the output as quickly as possible, but the voltage level can briefly exceed this level, potentially causing damage to the device under test (DUT).

The settings for this attribute are ignored if the pulser is disabled.

Example

```
smua.pulser.protect.sensev = 8
Set the voltage protection limit to 8 V.
```

Also see

[smua.pulser.protect.sourcev](#) (on page 11-217)

[smua.pulser.protect.tripped](#) (on page 11-218)

[smua.pulser.rangeY](#) (on page 11-220)

smua.pulser.protect.sourcev

This attribute sets an absolute voltage protection level used to monitor the force terminals when the pulser is enabled.

Type	TSP-Link accessible	Affected by	Where saved	Default value
Attribute (RW)	Yes	Instrument reset SMU reset Recall setup	Saved setup	40 V

Usage

```
level = smua.pulser.protect.sourcev
smua.pulser.protect.sourcev = level
```

<code>level</code>	The absolute voltage protection level when the pulser is enabled; 2 V to 40 V
--------------------	---

Details

If the voltage on the force terminals goes above the protection level, the 2601B-PULSE automatically turns off the output.

The absolute voltage protection level ignores normal transients during the pulse rise and fall time.

The current pulse terminates within 3 μ s after the remotely sensed voltage from the device under test (DUT) exceeds the specified level.

CAUTION

Setting the protection level does not guarantee that the output will not go above the protection level. The 2601B-PULSE turns off the output as quickly as possible, but the voltage level can briefly exceed this level, potentially causing damage to the device under test (DUT).

The settings for this attribute are ignored if the pulser is disabled.

Example

```
smua.pulser.protect.sourcev = 8
Set the voltage protection limit to 8 V.
```

Also see

[smua.pulser.protect.sensev](#) (on page 11-216)

[smua.pulser.protect.tripped](#) (on page 11-218)

smua.pulser.protect.tripped

This attribute indicates if the protection circuit was tripped.

Type	TSP-Link accessible	Affected by	Where saved	Default value
Attribute (R)	Yes	Instrument reset SMU reset	None	Not applicable

Usage

```
tripped = smua.pulser.protect.tripped
```

```
tripped
```

The voltage protection status:

- true: The protection circuit was tripped
- false: The protection circuit was not tripped

Details

When the pulser is enabled, this attribute indicates if the protection circuit was tripped. When the protection circuit is tripped, the output is shorted and turned off.

The following events can trip the protection circuit:

- A voltage greater than `smua.pulser.protect.sensev` was detected on the sense terminals.
- A voltage greater than `smua.pulser.protect.sourcev` was detected on the force terminals.
- The maximum pulse width was exceeded during trigger model operation.
- The maximum duty cycle was exceeded during trigger model operation.
- If the SMU cannot keep up with the pulse rate.
- If the SMU cannot keep up with the measurement rate.

The status is reset to `false` when the pulser is disabled or when the output is turned on.

Example

```
print(smua.pulser.protect.tripped)
```

Determine if the protection circuit was tripped.

Also see

[smua.pulser.protect.sensev](#) (on page 11-216)

[smua.pulser.protect.sourcev](#) (on page 11-217)

smua.pulser.source.calibratebiasi()

This function adjusts the new bias source calibration constants for the pulser.

Type	TSP-Link accessible	Affected by	Where saved	Default value
Function	Yes			

Usage

```
smua.pulser.source.calibratebiasi(range, cp1Expected, cp1Reference, cp2Expected,
cp2Reference)
```

<i>range</i>	The pulser bias-current range to adjust
<i>cp1Expected</i>	The source value set for point 1
<i>cp1Reference</i>	The reference measurement for point 1 as measured externally
<i>cp2Expected</i>	The source value set for point 2
<i>cp2Reference</i>	The reference measurement for point 2 as measured externally

Details

The positive and negative polarities must be adjusted separately. To adjust the positive polarity, use the $+250\text{e-}3$ range; to adjust the negative polarity, use the $-250\text{e-}3$ range.

Typically, the two points that are used are near zero for point 1 and 90% of full scale for point 2. Full scale for point 2 should be avoided if the source of the SMU is substantially out of calibration.

The new calibration constants are activated immediately but they are not written to nonvolatile memory. Use the `smua.cal.save()` function to save the new constants to nonvolatile memory. The active calibration constants stay in effect until the instrument is power cycled or a calibration set is loaded from nonvolatile memory with the `smua.cal.restore()` function.

This function is only available when calibration is unlocked using `smua.cal.unlock()`.

Example

```
smua.pulser.source.calibratebiasi(250e-3, 1e-10, 1e-5, 0.224, 0.225)
```

Adjusts the bias source calibration constant for the $250\text{e-}3$ pulser range using $1\text{e-}10$ as the source value and $1\text{e-}5$ for the reference measurement for point 1 and 0.224 as the source value and 0.225 as the reference measurement for point 2.

Also see

- [Calibration](#) (on page 13-1)
- [smua.cal.restore\(\)](#) (on page 11-184)
- [smua.cal.save\(\)](#) (on page 11-184)
- [smua.cal.unlock\(\)](#) (on page 11-186)
- [smua.pulser.measure.calibrateY\(\)](#) (on page 11-214)
- [smua.pulser.source.calibratei\(\)](#) (on page 11-221)

smua.pulser.rangeY

This attribute sets the source and measure ranges when the pulser is enabled.

Type	TSP-Link accessible	Affected by	Where saved	Default value
Attribute (RW)	Yes	Instrument reset SMU reset Recall setup	Saved setup	Current: 10 A Voltage: 10 V

Usage

```
range = smua.pulser.rangei
range = smua.pulser.rangev
smua.pulser.rangei = range
smua.pulser.rangev = range
```

<i>range</i>	The source and measure range
--------------	------------------------------

Details

When you set a value for the range, the 2601B-PULSE automatically sets the range as appropriate for the specified value.

This attribute setting affects the settings that are allowed for the `smua.pulser.protect.sensev` attribute, which must be between 5 percent and 200 percent of the voltage range.

The following table lists the pulser voltage and current ranges.

Voltage range	Source	Measure
5 V	Not applicable	5.1 V
10 V	Not applicable	10.2 V
Current ranges		
1 A	±1.01 A	±1.02 A
5 A	±5.05 A	±5.1 A
10 A	±10.1 A	±10.2 A
250 mA (DC bias)	±250 mA	Selected pulse measure range

The 2601B-PULSE can sustain a measurement speed of 33,000, as determined by:

$$(\text{Pulse rate per second}) + (\text{Measurements per second} \times \text{Filter count}) < 33000$$

If this rate is exceeded, the instrument may not be able to sustain the sweep.

The settings for this attribute are ignored if the pulser is disabled.

Example

```
smua.pulser.rangei = 1
Set the pulser current range to 1 A.
```

Also see

[smua.pulser.protect.sensev](#) (on page 11-216)

smua.pulser.source.calibratei()

This function generates and activates new source calibration constants for the pulser.

Type	TSP-Link accessible	Affected by	Where saved	Default value
Function	Yes			

Usage

```
smua.pulser.source.calibratei(range, cp1Expected, cp1Reference, cp2Expected,
                             cp2Reference)
```

<i>range</i>	The pulser current range to adjust
<i>cp1Expected</i>	The source value set for point 1
<i>cp1Reference</i>	The reference measurement for point 1 as measured externally
<i>cp2Expected</i>	The source value set for point 2
<i>cp2Reference</i>	The reference measurement for point 2 as measured externally

Details

This function generates and activates new calibration constants for the given range.

Typically, the two points that are used are near zero for point 1 and 90% of full scale for point 2. Full scale for point 2 should be avoided if the source of the SMU is substantially out of calibration.

The new calibration constants are activated immediately but they are not written to nonvolatile memory. Use the `smua.cal.save()` function to save the new constants to nonvolatile memory. The active calibration constants stay in effect until the instrument is power cycled or a calibration set is loaded from nonvolatile memory with the `smua.cal.restore()` function.

This function is only available when calibration is unlocked using `smua.cal.unlock()`.

Example

```
smua.pulser.source.calibratei(1, 1e-10, 1e-5, 0.9, 0.903)
```

Generates and activates new source calibration constants for the pulser 1 A range. For point 1, it uses 1e-10 as the source value and 1e-5 as the reference measurement. For point 2, it uses 0.9 for the source value and 0.903 for the reference measurement.

Also see

- [Calibration](#) (on page 13-1)
- [smua.cal.restore\(\)](#) (on page 11-184)
- [smua.cal.save\(\)](#) (on page 11-184)
- [smua.cal.unlock\(\)](#) (on page 11-186)
- [smua.pulser.measure.calibrateY\(\)](#) (on page 11-214)
- [smua.pulser.source.calibratebiasi\(\)](#) (on page 11-219)

smua.reset()

This function turns off the output and resets the commands that begin with `smua.` to their default settings.

Type	TSP-Link accessible	Affected by	Where saved	Default value
Function	Yes			

Usage

```
smua.reset()
```

Details

This function turns off the output and returns the specified SMU to its default settings.

Example

```
smua.reset() Turns off the output and resets SMU to its default settings.
```

Also see

[reset\(\)](#) (on page 11-156)

smua.savebuffer()

This function saves one source-measure unit (SMU) dedicated reading buffer to nonvolatile memory.

Type	TSP-Link accessible	Affected by	Where saved	Default value
Function	Yes			

Usage

```
smua.savebuffer(smua.nvbufferY)
```

```
Y SMU dedicated reading buffer (1 or 2)
```

Details

When the instrument is turned off and back on, the dedicated reading buffers are restored from nonvolatile memory to their last saved values.

Example

```
smua.savebuffer(smua.nvbuffer1) Saves buffer 1 to internal memory.
```

Also see

[Reading buffers](#) (on page 5-1)

[savebuffer\(\)](#) (on page 11-156)

[smua.nvbufferY](#) (on page 11-211)

smua.sense

This attribute contains the state of the sense mode.

Type	TSP-Link accessible	Affected by	Where saved	Default value
Attribute (RW)	Yes	SMU reset Instrument reset Recall setup	Saved setup	0 (smua.SENSE_LOCAL)

Usage

```
senseMode = smua.sense
smua.sense = senseMode
```

senseMode

The sense mode; set to one of the following:

- 0 or `smua.SENSE_LOCAL`: Selects local sense (2-wire)
- 1 or `smua.SENSE_REMOTE`: Selects remote sense (4-wire)
- 3 or `smua.SENSE_CALA`: Selects calibration sense mode

Details

You can do source-measure operations using either 2-wire local sense connections or 4-wire remote sense connections.

NOTE

When the pulser is enabled, the instrument always uses 4-wire remote sensing. The setting of `smua.sense` is ignored.

You can change the sense mode between local and remote while the output is on.

The `smua.SENSE_CALA` mode is only used for calibration and may only be selected when calibration is enabled. The calibration sense mode cannot be selected while the output is on.

Example

```
smua.sense = smua.SENSE_REMOTE
```

Select 4-wire remote sensing.

Also see

- [2-wire local sensing connections](#) (on page 4-10)
- [4-wire remote sensing connections](#) (on page 4-10)
- [Sense mode selection](#) (on page 4-25)

smua.source.autorangeY

This attribute contains the state of the source autorange control (on/off).

Type	TSP-Link accessible	Affected by	Where saved	Default value
Attribute (RW)	Yes	SMU reset Instrument reset Recall setup	Saved setup	1 (smua.AUTORANGE_ON)

Usage

```
sourceAutorange = smua.source.autorangeY
smua.source.autorangeY = sourceAutorange
```

<i>sourceAutorange</i>	The state of the source autorange control. Set to one of the following: <ul style="list-style-type: none"> ■ 0 or <code>smua.AUTORANGE_OFF</code>: Disables source autorange ■ 1 or <code>smua.AUTORANGE_ON</code>: Enables source autorange
Y	SMU source function (v = voltage, i = current)

Details

This attribute indicates the source autorange state. Its value is `smua.AUTORANGE_OFF` when the SMU source circuit is on a fixed range and `smua.AUTORANGE_ON` when it is in autorange mode.

Setting this attribute to `smua.AUTORANGE_OFF` puts the SMU on a fixed source range. The fixed range used is the present SMU source circuit range.

Setting this attribute to `smua.AUTORANGE_ON` puts the SMU source circuit into autorange mode. If the source output is on, the SMU immediately changes range to the range most appropriate for the value being sourced if that range is different than the present SMU range.

Autorange is disabled if the source level is edited from the front panel. Setting the source range also turns off autorange when set by using the `smua.source.rangeY` attribute.

Resetting the instrument selects the `smua.AUTORANGE_ON`.

Example

```
smua.source.autorangev = smua.AUTORANGE_ON
```

Enables volts source autorange.

Also see

[smua.measure.autorangeY](#) (on page 11-194)

[smua.source.rangeY](#) (on page 11-235)

smua.source.calibrateY()

This function generates and activates new source calibration constants.

Type	TSP-Link accessible	Affected by	Where saved	Default value
Function	Yes			

Usage

```
smua.source.calibrateY(range, cp1Expected, cp1Reference, cp2Expected, cp2Reference)
```

<i>Y</i>	SMU source function (v = voltage, i = current)
<i>range</i>	The measurement range to adjust
<i>cp1Expected</i>	The source value set for point 1
<i>cp1Reference</i>	The reference measurement for point 1 as measured externally
<i>cp2Expected</i>	The source value set for point 2
<i>cp2Reference</i>	The reference measurement for point 2 as measured externally

Details

This function generates and activates new calibration constants for the given range.

The positive and negative polarities of the source must be adjusted separately. Use a positive value for *range* to adjust the positive polarity and a negative value for range to adjust the negative polarity. Do not use 0.0 for a negative point; 0.0 is considered to be a positive number.

Typically, the two points that are used are near zero for point 1 and 90% of full scale for point 2. Full scale for point 2 should be avoided if the source of the SMU is substantially out of calibration.

The two reference measurements must be made with the source using the active calibration set. For example, source a value, measure it, and do not change the active calibration set before issuing this command.

The new calibration constants are activated immediately but they are not written to nonvolatile memory. Use the `smua.cal.save()` function to save the new constants to nonvolatile memory. The active calibration constants stay in effect until the instrument is power cycled or a calibration set is loaded from nonvolatile memory with the `smua.cal.restore()` function.

This function is only available when calibration is unlocked using `smua.cal.unlock()`.

Example

```
smua.source.calibratev(1, 1e-10, 1e-5, 0.9, 0.903)
```

Generates and activates new source calibration constants for the 1 A range. For point 1, it uses 1e-10 as the source value and 1e-5 as the reference measurement. For point 2, it uses 0.9 for the source value and 0.903 for the reference measurement.

Also see

- [Calibration](#) (on page 13-1)
- [smua.cal.restore\(\)](#) (on page 11-184)
- [smua.cal.save\(\)](#) (on page 11-184)
- [smua.cal.unlock\(\)](#) (on page 11-186)
- [smua.measure.calibrateY\(\)](#) (on page 11-196)

smua.source.compliance

This attribute contains the state of source compliance.

Type	TSP-Link accessible	Affected by	Where saved	Default value
Attribute (R)	Yes	Not applicable	Not saved	Not applicable

Usage

```
compliance = smua.source.compliance
```

compliance

The state of source compliance:

- `true`: Indicates that the limit function is in control of the source (source in compliance)
- `false`: Indicates that the source function is in control of the output (source not in compliance)

Details

Reading this attribute updates the status model and the front panel with generated compliance information. See Current Limit (ILMT) in the status model diagram for the [Measurement event registers](#) (on page 15-7). The Voltage Limit (VLMT) is not shown in the status model diagram for the Measurement event registers, but is similar to the Current Limit (ILMT).

Example

```
compliance = smua.source.compliance
print(compliance)
```

Reads the source compliance state.

Output:

```
true
```

This output indicates that a configured limit has been reached (voltage, current, or power limit).

Also see

[smua.source.limitY](#) (on page 11-230)

smua.source.delay

This attribute contains the source delay.

Type	TSP-Link accessible	Affected by	Where saved	Default value
Attribute (RW)	Yes	SMU reset Instrument reset Recall setup	Not saved	0 (smua.DELAY_OFF)

Usage

```
sDelay = smua.source.delay
smua.source.delay = sDelay
```

sDelay

Set to the source delay value (for example, to specify an additional 10 ms source delay, set the value to `0.010`); you can also set it one of the following values:

- `0` or `smua.DELAY_OFF`: No delay
- `-1` or `smua.DELAY_AUTO`: Automatic delay value

Details

This attribute allows for additional delay (settling time) after an output step.

The `smua.DELAY_AUTO` setting causes a range-dependent delay to be inserted when the source is changed. Range-dependent delays are based on the output settling time values as defined in the 2601B-PULSE specifications.

Example

```
smua.source.delay = smua.DELAY_AUTO
Sets the delay to automatic (a range-dependent delay is inserted whenever the source is changed).
```

Also see

- [reset\(\)](#) (on page 11-156)
- [smua.measure.count](#) (on page 11-197)
- [smua.measure.delay](#) (on page 11-198)
- [smua.reset\(\)](#) (on page 11-222)

smua.source.func

This attribute contains the source function, which can be voltage or current.

Type	TSP-Link accessible	Affected by	Where saved	Default value
Attribute (RW)	Yes	SMU reset Instrument reset Recall setup	Saved setup	1 (smua.OUTPUT_DCVOLTS)

Usage

```
sFunction = smua.source.func
smua.source.func = sFunction
```

<i>sFunction</i>	The source function; set to one of the following values: <ul style="list-style-type: none"> ▪ 0 or <code>smua.OUTPUT_DCAMPS</code>: Selects the current source function ▪ 1 or <code>smua.OUTPUT_DCVOLTS</code>: Selects the voltage source function
------------------	--

Details

Reading this attribute indicates the output function of the source. Setting this attribute configures the SMU as either a voltage source or a current source.

Example

```
smua.source.func = smua.OUTPUT_DCAMPS
Sets the source function to be a current source.
```

Also see

- [smua.source.levelY](#) (on page 11-229)
- [smua.source.output](#) (on page 11-234)

smua.source.highc

This attribute enables or disables high-capacitance mode.

Type	TSP-Link accessible	Affected by	Where saved	Default value
Attribute (RW)	Yes	SMU reset Instrument reset Recall setup	Saved setup	0 (smua.DISABLE)

Usage

```
highC = smua.source.highc
smua.source.highc = highC
```

highC

The state of the high-capacitance mode; set to one of the following values:

- 0 or `smua.DISABLE`: Disables high-capacitance mode
- 1 or `smua.ENABLE`: Enables high-capacitance mode

Details

When enabled, the high-capacitance mode has the following effects on the SMU settings:

- `smua.measure.autorangei` is set to `smua.AUTORANGE_FOLLOW_LIMIT` and cannot be changed
- Current ranges below 1 μA are not accessible
- If `smua.source.limiti` is less than 1 μA , it is raised to 1 μA
- If `smua.source.rangei` is less than 1 μA , it is raised to 1 μA
- If `smua.source.lowrangei` is less than 1 μA , it is raised to 1 μA
- If `smua.measure.lowrangei` is less than 1 μA , it is raised to 1 μA

NOTE

High-capacitance mode is not available when the pulser is enabled.

Example

```
smua.source.highc = smua.ENABLE Activates high-capacitance mode.
```

Also see

[High-capacitance mode](#) (on page 4-80)

smua.source.levelY

This attribute sets the source level.

Type	TSP-Link accessible	Affected by	Where saved	Default value
Attribute (RW)	Yes	SMU reset Instrument reset Recall setup	Saved setup	0

Usage

```
sourceLevel = smua.source.levelY
smua.source.levelY = sourceLevel
```

<i>sourceLevel</i>	The source value; set to one of the following values: <ul style="list-style-type: none"> ■ Voltage: 0 V to ± 40 V ■ Current when the pulser is disabled: 0 A to ± 3 A ■ Bias current when the pulser is enabled: 0 A to ± 250 mA
Y	SMU source function (v = voltage, i = current)

Details

This attribute configures the output level of the voltage or current source.

If the source is configured as a voltage source and the output is on, the new `smua.source.levelv` setting is sourced immediately. If the output is off or the source is configured as a current source, the voltage level is sourced when the source is configured as a voltage source and the output is turned on.

If the source is configured as a current source and the output is on, the new `smua.source.leveli` setting is sourced immediately. If the output is off or the source is configured as a voltage source, the current level is sourced when the source is configured as a current source and the output is turned on.

The sign of *sourceLevel* dictates the polarity of the source. Positive values generate positive voltage or current from the high terminal of the source relative to the low terminal. Negative values generate negative voltage or current from the high terminal of the source relative to the low terminal.

The `reset()` function sets the source levels to 0 V and 0 A.

Example

```
smua.source.levelv = 1
```

Sets voltage source of SMU channel A to 1 V.

Also see

[smua.source.compliance](#) (on page 11-226)

[smua.source.func](#) (on page 11-227)

[smua.source.output](#) (on page 11-234)

[Source-measure concepts](#) (on page 7-1)

smua.source.limitY

This attribute sets compliance limits.

Type	TSP-Link accessible	Affected by	Where saved	Default value
Attribute (RW)	Yes	SMU reset Instrument reset Recall setup	Saved setup	Limit voltage: 40 (40 V) Limit current: 1 (1 A) Limit power: 0 (disabled)

Usage

```
limit = smua.source.limitY
smua.source.limitY = limit
```

<i>limit</i>	The compliance limit value; set to one of the following values: <ul style="list-style-type: none"> ■ Voltage compliance: 10 mV to 40 V ■ Current compliance: 10 nA to 3 A ■ Power compliance (in watts)
<i>Y</i>	SMU function (<i>v</i> = voltage, <i>i</i> = current, <i>p</i> = power)

Details

Use the `smua.source.limiti` attribute to limit the current output of the voltage source. Use `smua.source.limitv` to limit the voltage output of the current source. The SMU always uses autoranging for the limit setting. Use the `smua.source.limitp` attribute to limit the output power of the source.

This attribute should be set in the test sequence before the turning the source on.

Using a limit value of 0 results in error code 1102, "Parameter too small," for *v* and *i*. Setting this attribute to zero disables power compliance for *p*. When setting the power compliance limit to a nonzero value, the SMU adjusts the source limit where appropriate to limit the output to the specified power. The SMU uses the lower of the programmed compliance value (the compliance level that would be used if power compliance were disabled) or the limit calculated from the power compliance setting.

Reading this attribute indicates the presently set compliance value. Use `smua.source.compliance` to read the state of source compliance.

Example

```
smua.source.limitv = 15
```

Sets the voltage limit to 15 V.

Also see

- [DUT test connections](#) (on page 4-6)
- [smua.source.compliance](#) (on page 11-226)
- [smua.source.func](#) (on page 11-227)
- [smua.source.output](#) (on page 11-234)

smua.source.lowrangeY

This attribute sets the lowest source range that is used during autoranging.

Type	TSP-Link accessible	Affected by	Where saved	Default value
Attribute (RW)	Yes	SMU reset Instrument reset Recall setup	Saved setup	Voltage: 100e-3 (100 mV) Current: 100e-9 (100 nA)

Usage

```
sourceRangeLow = smua.source.lowrangeY
smua.source.lowrangeY = sourceRangeLow
```

<i>sourceRangeLow</i>	Set to the lowest voltage (in volts) or current (in amperes) range to be used
<i>Y</i>	SMU source function (v = voltage, i = current)

Details

This attribute is used with source autoranging to put a lower bound on the range that is used. Lower ranges generally require greater settling times. If you set a low-range value, you might be able to source small values with less settling time.

If the instrument is set to autorange and it is on a range lower than the one specified by *sourceRangeLow*, the source range will be changed to the range specified by *sourceRangeLow*.

Example

<code>smua.source.lowrangev = 1</code>	Sets the voltage low range to 1 V. This prevents the source from using the 100 mV range when sourcing voltage.
--	--

Also see

[smua.source.autorangeY](#) (on page 11-224)

smua.source.offfunc

This attribute sets the source function that is used (source 0 A or 0 V) when the output is turned off and the source-measure unit (SMU) is in normal output-off mode.

Type	TSP-Link accessible	Affected by	Where saved	Default value
Attribute (RW)	Yes	SMU reset Instrument reset Recall setup	Saved setup	1 (smua.OUTPUT_DCVOLTS)

Usage

```
offfunc = smua.source.offfunc
smua.source.offfunc = offfunc
```

<i>offfunc</i>	Set to the source function to be used when the output is off and the SMU is in normal output-off mode. Set to one of the following values: <ul style="list-style-type: none"> ■ 0 or smua.OUTPUT_DCAMPS: Source 0 A ■ 1 or smua.OUTPUT_DCVOLTS: Source 0 V
----------------	--

Details

This attribute controls the source function used when the output is turned off and `smua.source.offmode` is set to `smua.OUTPUT_NORMAL`.

Set this attribute to `smua.OUTPUT_DCVOLTS` for the source to be a 0 V source when the output is off (`smua.source.offlimiti` is used).

Set it to `smua.OUTPUT_DCAMPS` for the source to be a 0 A source when the output is off (`smua.source.offlimitv` is used).

NOTE

If the pulser is enabled and the output-off mode is set to normal, the `smua.source.offfunc` setting is ignored and the output circuit is shorted.

Example

```
smua.source.offmode = smua.OUTPUT_NORMAL
smua.source.offfunc = smua.OUTPUT_DCVOLTS
```

Sets the normal output-off mode to source 0 V when the output is turned off.

Also see

[Output-off states](#) (on page 4-26)

[smua.source.offmode](#) (on page 11-233)

[smua.source.output](#) (on page 11-234)

smua.source.offlimitY

This attribute sets the limit (current or voltage) used when the source-measure unit (SMU) is in normal output-off mode.

Type	TSP-Link accessible	Affected by	Where saved	Default value
Attribute (RW)	Yes	SMU reset Instrument reset Recall setup	Saved setup	Current: 1e-3 (1 mA) Voltage: 40 (40 V)

Usage

```
sourceLimit = smua.source.offlimitY
smua.source.offlimitY = sourceLimit
```

<code>sourceLimit</code>	Set to the limit to be used when the SMU is in normal output-off mode
Y	SMU source function (v = voltage, i = current)

Details

Setting the current limit to lower than 1 mA may interfere with operation of the contact check function. See `smua.contact.check()` and `smua.contact.r()` for details.

Example

```
smua.source.offlimiti = 10e-3
```

Changes the normal output-off mode limit to 10 mA.

Also see

- [smua.contact.check\(\)](#) (on page 11-188)
- [smua.contact.r\(\)](#) (on page 11-190)
- [smua.source.offfunc](#) (on page 11-231)
- [smua.source.offmode](#) (on page 11-233)

smua.source.offmode

This attribute sets the source output-off mode.

Type	TSP-Link accessible	Affected by	Where saved	Default value
Attribute (RW)	Yes	SMU reset Instrument reset Recall setup	Saved setup	0 (smua.OUTPUT_NORMAL)

Usage

```
sourceOffMode = smua.source.offmode
smua.source.offmode = sourceOffMode
```

<i>sourceOffMode</i>	<p>The output-off setting; set to one of the following values:</p> <ul style="list-style-type: none"> ▪ 0 or smua.OUTPUT_NORMAL: See Details ▪ 1 or smua.OUTPUT_ZERO: See Details ▪ 2 or smua.OUTPUT_HIGH_Z: Opens the output relay when the output is turned off
----------------------	--

Details

Reading this attribute returns the output-off mode of the source. Setting this attribute configures the SMU output-off mode.

When smua.OUTPUT_NORMAL is selected and the pulser is disabled, the source function is configured according to the smua.source.offfunc attribute. The smua.source.offfunc attribute controls whether the SMU is configured as a 0 V voltage source or a 0 A current source. When the SMU is operating as a 0 A current source, the smua.source.offlimitv attribute sets the voltage limit (similar to how the smua.source.offlimiti attribute sets the current limit when the SMU is operating as a 0 V voltage source).

When the output-off mode is set to smua.OUTPUT_ZERO and the pulser is disabled, the source is configured to output 0 V. This is equivalent to smua.OUTPUT_NORMAL mode with smua.source.offfunc = smua.OUTPUT_DCVOLTS. If the source function is voltage, the current limit is not changed. If the source function is current, the current limit is set to the current source level or 10% of the current source range, whichever is greater.

When smua.OUTPUT_NORMAL or smua.OUTPUT_ZERO is selected and the pulser is enabled, the output circuit is shorted.

When sourceOffMode is set to smua.OUTPUT_HIGH_Z, the SMU opens the output relay when the output is turned off. To prevent excessive wear on the output relay, do not use this output-off mode for tests that turn the output off and on frequently.

Example

```
smua.source.offmode = smua.OUTPUT_HIGH_Z
```

Sets the output-off mode to open the output relay when the output is turned off.

Also see

- [Output-off states](#) (on page 4-26)
- [smua.source.offfunc](#) (on page 11-231)
- [smua.source.offlimitY](#) (on page 11-232)
- [smua.source.output](#) (on page 11-234)

smua.source.output

This attribute enables or disables the source output.

Type	TSP-Link accessible	Affected by	Where saved	Default value
Attribute (RW)	Yes	SMU reset Instrument reset Recall setup	Not saved	0 (smua.OUTPUT_OFF)

Usage

```
sourceOutput = smua.source.output
smua.source.output = sourceOutput
```

sourceOutput

The output state setting of the source; set to one of the following values:

- 0 or `smua.OUTPUT_OFF`: Turns off the source output
- 1 or `smua.OUTPUT_ON`: Turns on the source output
- 2 or `smua.OUTPUT_HIGH_Z`: Turns off the output in high Z mode (allows you to go to high Z mode without first setting the `smua.source.offmode` attribute to `smua.OUTPUT_HIGH_Z`)

Details

Reading this attribute returns the output state of the source. Setting this attribute switches the output of the source on or off.

When the output is switched on, the SMU sources either voltage or current, as set by `smua.source.func`.

Setting this attribute to `smua.OUTPUT_HIGH_Z` causes the output to turn off and go to the High Z mode. If the `smua.source.output` is read after setting this attribute to `smua.OUTPUT_HIGH_Z`, it returns 0.

Example

```
smua.source.output = smua.OUTPUT_ON
```

Turns on the source output.

Also see

- [DUT test connections](#) (on page 4-6)
- [smua.source.func](#) (on page 11-227)
- [smua.source.offmode](#) (on page 11-233)

smua.source.rangeY

This attribute contains the source range.

Type	TSP-Link accessible	Affected by	Where saved	Default value
Attribute (RW)	Yes	SMU reset Instrument reset Recall setup	Saved setup	Voltage: 100e-3 (100 mV) Current: 100e-9 (100 nA)

Usage

```
rangeValue = smua.source.rangeY
smua.source.rangeY = rangeValue
```

<i>rangeValue</i>	Set to the maximum expected voltage or current to be sourced
Y	SMU source function (v = voltage, i = current)

Details

This attribute contains a value that sets the source-measure unit (SMU) to a fixed range large enough to source the value. When read, the attribute contains the range the instrument is presently on when in autorange.

Assigning a value to this attribute sets the SMU to a fixed range large enough to source the assigned value. The instrument selects the best range for sourcing a value of *rangeValue*.

Reading this attribute returns the positive full-scale value of the source range the SMU is currently using. With source autoranging enabled, the output level controls the range. Querying the range after the level is set returns the range the instrument chose as appropriate for that source level.

This attribute is primarily intended to eliminate the time required by the automatic range selection performed by a sourcing instrument. Because selecting a fixed range prevents autoranging, an overrange condition can occur. For example, sourcing 10.0 V on the 2601B-PULSE 6 V range causes an overrange condition.

Example

```
smua.source.rangev = 1
```

Selects the 1 V source range.

Also see

- [Range](#) (on page 4-54)
- [reset\(\)](#) (on page 11-156)
- [setup.recall\(\)](#) (on page 11-175)
- [smua.measure.rangeY](#) (on page 11-206)
- [smua.reset\(\)](#) (on page 11-222)
- [smua.source.autorangeY](#) (on page 11-224)

smua.source.settling

This attribute contains the source settling mode.

Type	TSP-Link accessible	Affected by	Where saved	Default value
Attribute (RW)	Yes	SMU reset Instrument reset Recall setup	Not saved	0 (smua.SETTLE_SMOOTH)

Usage

```
settleOption = smua.source.settling
smua.source.settling = settleOption
```

settleOption

Set to the source settling mode. Set to one of the following values:

- 0 or `smua.SETTLE_SMOOTH`: Turns off additional settling operations (default)
- 1 or `smua.SETTLE_FAST_RANGE`: Instructs the source-measure unit (SMU) to use a faster procedure when changing ranges
- 2 or `smua.SETTLE_FAST_POLARITY`: Instructs the SMU to change polarity without going to zero
- 3 or `smua.SETTLE_DIRECT_IRANGE`: Instructs the SMU to change the current range directly
- 128 or `smua.SETTLE_FAST_ALL`: Enables all `smua.SETTLE_FAST_*` operations

Details

Using `smua.SETTLE_FAST_RANGE` may cause the SMU to exceed the range change overshoot specification.

`smua.SETTLE_FAST_POLARITY` does not go to zero when changing polarity and may create inconsistencies at the zero crossing.

`smua.SETTLE_DIRECT_IRANGE` switches the SMU directly to the target range instead of the default range-by-range method. This option is mutually exclusive of any other `smua.SETTLE_FAST_*` commands.

Example

```
smua.source.settling = smua.SETTLE_FAST_POLARITY
```

Selects fast polarity changing.

Also see

[Range](#) (on page 4-54)

smua.source.sink

This attribute turns sink mode on or off.

Type	TSP-Link accessible	Affected by	Where saved	Default value
Attribute (RW)	Yes	SMU reset Instrument reset Recall setup	Saved setup	0 (smua.DISABLE)

Usage

```

sinkMode = smua.source.sink
smua.source.sink = sinkMode

```

<i>sinkMode</i>	Sets the sink mode on or off; set to one of the following values: <ul style="list-style-type: none"> ▪ 0 or smua.DISABLE: Turns off sink mode ▪ 1 or smua.ENABLE: Turns on sink mode
-----------------	--

Details

This attribute enables or disables sink mode. When sink mode is enabled, it reduces the source limit inaccuracy that occurs when operating in quadrants II and IV (quadrants I and III will show this source limit inaccuracy).

Example

<code>smua.source.sink = smua.ENABLE</code>	Enables sink mode.
---	--------------------

Also see

[Source or sink](#) (on page 7-6)

smua.trigger.arm.count

This attribute sets the arm count in the trigger model.

Type	TSP-Link accessible	Affected by	Where saved	Default value
Attribute (RW)	Yes	SMU reset Instrument reset Recall setup	Not saved	1

Usage

```

triggerArmCount = smua.trigger.arm.count
smua.trigger.arm.count = triggerArmCount

```

<i>triggerArmCount</i>	The arm count in the trigger model
------------------------	------------------------------------

Details

During a sweep, the SMU iterates through the arm layer of the trigger model this many times. After performing this many iterations, the SMU returns to an idle state.

If this count is set to zero, the SMU stays in the trigger model indefinitely until aborted.

Example

```
smua.trigger.arm.count = 5
```

Sets the SMU to iterate through the arm layer of the trigger model five times and then return to the idle state.

Also see

[smua.trigger.count](#) (on page 11-241)

smua.trigger.arm.set()

This function sets the arm event detector to the detected state.

Type	TSP-Link accessible	Affected by	Where saved	Default value
Function	Yes			

Usage

```
smua.trigger.arm.set()
```

Details

The SMU automatically clears all the event detectors when the `smua.trigger.initiate()` function is executed. This function should be called after the sweep is initiated.

A common example of when this function can be used is when you want the SMU to immediately perform an action the first time through the trigger model even if a programmed trigger event does not occur.

This function can also be used to start actions on the SMU in case of a missed trigger event.

Example

```
smua.trigger.arm.set()
```

Sets the arm event detector to the detected state.

Also see

[smua.trigger.initiate\(\)](#) (on page 11-247)

[smua.trigger.measure.set\(\)](#) (on page 11-249)

[smua.trigger.source.set\(\)](#) (on page 11-258)

smua.trigger.arm.stimulus

This attribute selects the event that will cause the arm event detector to enter the detected state.

Type	TSP-Link accessible	Affected by	Where saved	Default value
Attribute (RW)	Yes	SMU reset Instrument reset Recall setup	Not saved	0

Usage

```
eventID = smua.trigger.arm.stimulus
smua.trigger.arm.stimulus = eventID
```

<i>eventID</i>	Event that triggers the arm detector
----------------	--------------------------------------

Details

Set this attribute to the event ID of any trigger event generator to wait for that event.

Set this attribute to zero to bypass waiting for events at the arm event detector (the SMU continues uninterrupted through the remote trigger model). Set *eventID* to one of the existing trigger event IDs shown in the following table.

Trigger event IDs*	
Event ID	Event description
smua.trigger.SWEEPING_EVENT_ID	Occurs when the source-measure unit (SMU) transitions from the idle state to the arm layer of the trigger model
smua.trigger.ARMED_EVENT_ID	Occurs when the SMU moves from the arm layer to the trigger layer of the trigger model
smua.trigger.SOURCE_COMPLETE_EVENT_ID	Occurs when the SMU completes a source action
smua.trigger.MEASURE_COMPLETE_EVENT_ID	Occurs when the SMU completes a measurement action
smua.trigger.PULSE_COMPLETE_EVENT_ID	Occurs when the SMU completes a pulse
smua.trigger.SWEEP_COMPLETE_EVENT_ID	Occurs when the SMU completes a sweep
smua.trigger.IDLE_EVENT_ID	Occurs when the SMU returns to the idle state
digio.trigger[N].EVENT_ID	Occurs when an edge is detected on a digital I/O line
tsplink.trigger[N].EVENT_ID	Occurs when an edge is detected on a TSP-Link line
lan.trigger[N].EVENT_ID	Occurs when the appropriate LXI trigger packet is received on LAN trigger object <i>N</i>
display.trigger.EVENT_ID	Occurs when the TRIG key on the front panel is pressed
trigger.EVENT_ID	Occurs when a *TRG command is received on the remote interface GPIB only: Occurs when a GET bus command is received USB only: Occurs when a USBTMC TRIGGER message is received VXI-11 only: Occurs with the VXI-11 command <i>device_trigger</i> ; reference the VXI-11 standard for additional details on the device trigger operation
trigger.blender[N].EVENT_ID	Occurs after a collection of events is detected
trigger.timer[N].EVENT_ID	Occurs when a delay expires
trigger.generator[N].EVENT_ID	Occurs when the <i>trigger.generator[N].assert()</i> function is executed

* Use the name of the trigger event ID to set the stimulus value rather than the numeric value. Using the name makes the code compatible for future upgrades (for example, if the numeric values must change when enhancements are added to the instrument).

Example

```
smua.trigger.arm.stimulus = trigger.timer[1].EVENT_ID
```

An event on trigger timer 1 causes the arm event detector to enter the detected state.

Also see

[Triggering](#) (on page 6-1)

smua.trigger.ARMED_EVENT_ID

This constant contains the number of the armed event.

Type	TSP-Link accessible	Affected by	Where saved	Default value
Constant	Yes			

Usage

```
eventID = smua.trigger.ARMED_EVENT_ID
```

<i>eventID</i>	The armed event number
----------------	------------------------

Details

Set the stimulus of any trigger object to the value of this constant to have the trigger object respond to armed events from this SMU.

Example

```
trigger.timer[1].stimulus = smua.trigger.ARMED_EVENT_ID
```

Trigger timer when the SMU passes through the arm layer.

Also see

[Triggering](#) (on page 6-1)

smua.trigger.autoclear

This attribute turns automatic clearing of the event detectors on or off.

Type	TSP-Link accessible	Affected by	Where saved	Default value
Attribute (RW)	Yes	SMU reset Instrument reset Recall setup	Not saved	0 (smua.DISABLE)

Usage

```
autoClear = smua.trigger.autoclear  
smua.trigger.autoclear = autoClear
```

<i>autoClear</i>	Auto clear setting; set to one of the following values: <ul style="list-style-type: none"> ■ 0 or <code>smua.DISABLE</code>: Turns off automatic clearing of the event detectors ■ 1 or <code>smua.ENABLE</code>: Turns on automatic clearing of the event detectors
------------------	--

Details

This attribute enables or disables automatic clearing of the trigger model state machine event detectors when the SMU transitions from the arm layer to the trigger layer.

Only the detected states of the event detectors are cleared.

The overrun statuses of the event detectors are not automatically cleared when the SMU transitions from the arm layer to the trigger layer.

The event detectors are always cleared when a sweep is initiated.

Example

```
smua.trigger.autoclear = smua.ENABLE
```

Automatically clear the event detectors for the trigger mode state.

Also see

[Triggering](#) (on page 6-1)

smua.trigger.count

This attribute sets the trigger count in the trigger model.

Type	TSP-Link accessible	Affected by	Where saved	Default value
Attribute (RW)	Yes	SMU reset Instrument reset Recall setup	Not saved	1

Usage

```
triggerCount = smua.trigger.count
smua.trigger.count = triggerCount
```

<i>triggerCount</i>	The trigger count is the number of times the source-measure unit (SMU) will iterate in the trigger layer for any given sweep
---------------------	--

Details

During a sweep, the SMU iterates through the trigger layer of the trigger model this many times. After performing this many iterations, the SMU returns to the arm layer.

If this count is set to zero (0), the SMU stays in the trigger model indefinitely until aborted.

Example

```
reset()
period_timer = trigger.timer[1]
pulse_timer = trigger.timer[2]
smua.trigger.source.listv( {5} )
smua.trigger.source.action = smua.ENABLE
smua.source.rangev = 5
smua.trigger.measure.action = smua.DISABLE
pulse_timer.delay = 0.0006
pulse_timer.stimulus = period_timer.EVENT_ID
pulse_timer.count = 1
period_timer.delay = 0.005
period_timer.count = 9
period_timer.stimulus = smua.trigger.SWEEPING_EVENT_ID
period_timer.passthrough = true
smua.trigger.source.stimulus = period_timer.EVENT_ID
smua.trigger.endpulse.action = smua.SOURCE_IDLE
smua.trigger.endpulse.stimulus = pulse_timer.EVENT_ID
smua.trigger.count = 1
smua.trigger.arm.count = 10
smua.source.output = smua.OUTPUT_ON
smua.trigger.initiate()
waitcomplete()
smua.source.output = smua.OUTPUT_OFF
```

Generate a 10-point pulse train where each pulse has a width of 600 μ s and a pulse period of 5 ms.
Alias the trigger timers to use for pulse width and period.
Create a fixed level voltage sweep.
Set the pulse width and trigger the pulse width timer with a period timer.
Set the pulse period to output one pulse per period and the count to generate 10 pulses.
Trigger the pulse period timer when a sweep is initiated.
Configure the timer to output a trigger event when it starts the first delay.
Trigger the SMU source action using pulse period timer.
Trigger the SMU end pulse action using pulse width timer.
Set the trigger model counts.
Configure the SMU to execute a 10-point pulse train.
Start the trigger model.
Wait for the sweep to complete.

Also see

[Triggering](#) (on page 6-1)

smua.trigger.endpulse.action

This attribute enables or disables pulse sweeps when the pulser is disabled.

Type	TSP-Link accessible	Affected by	Where saved	Default value
Attribute (RW)	Yes	SMU reset Instrument reset Recall setup	Not saved	1 (smua.SOURCE_HOLD)

Usage

```
pulseAction = smua.trigger.endpulse.action
smua.trigger.endpulse.action = pulseAction
```

<i>pulseAction</i>	The pulse mode setting; set to one of the following values (see Details for definition): <ul style="list-style-type: none"> ■ 0 or smua.SOURCE_IDLE ■ 1 or smua.SOURCE_HOLD
--------------------	--

Details

When set to `smua.SOURCE_HOLD`, this attribute disables pulse mode sweeps, holding the source level for the remainder of the step.

When set to `smua.SOURCE_IDLE`, this attribute enables pulse mode sweeps, setting the source level to the programmed (idle) level at the end of the pulse.

You cannot use this attribute and `smua.trigger.source.pulsewidth` in the same trigger model.

When the pulser is enabled, this setting is ignored. The source level is set to the programmed idle level at the end of the pulse.

Example

```
smua.trigger.endpulse.action = smua.SOURCE_IDLE
smua.trigger.endpulse.stimulus = trigger.timer[1].EVENT_ID
```

Configure the end pulse action to achieve a pulse and configure trigger timer 1 to control the end of pulse.

Also see

- [smua.trigger.source.pulsewidth](#) (on page 11-258)
- [Triggering](#) (on page 6-1)

smua.trigger.endpulse.set()

This function sets the end pulse event detector to the detected state.

Type	TSP-Link accessible	Affected by	Where saved	Default value
Function	Yes			

Usage

```
smua.trigger.endpulse.set()
```

Details

This function sets the end pulse event detector to the detected state.

The SMU automatically clears all the event detectors when the `smua.trigger.initiate()` function is executed. Therefore, `smua.trigger.endpulse.set()` should be called after the sweep is initiated. If the event detectors are configured to clear automatically because the `smua.trigger.autoclear` attribute is set to `smua.ENABLE`, make sure that `smua.trigger.endpulse.set()` is issued after the SMU has entered the trigger layer.

Example

```
reset()
period_timer = trigger.timer[1]
pulse_timer = trigger.timer[2]
smua.trigger.source.listv( {5} )
smua.trigger.source.action = smua.ENABLE
smua.source.rangev = 5
smua.trigger.measure.action = smua.DISABLE
pulse_timer.delay = 0.0006
pulse_timer.stimulus = period_timer.EVENT_ID
pulse_timer.count = 1
period_timer.delay = 0.005
period_timer.count = 9
period_timer.stimulus = smua.trigger.SWEEPING_EVENT_ID
period_timer.passthrough = true
smua.trigger.source.stimulus = period_timer.EVENT_ID
smua.trigger.endpulse.action = smua.SOURCE_IDLE
smua.trigger.endpulse.stimulus = pulse_timer.EVENT_ID
smua.trigger.count = 1
smua.trigger.arm.count = 10
smua.source.output = smua.OUTPUT_ON
smua.trigger.initiate()
waitcomplete()
smua.source.output = smua.OUTPUT_OFF
```

Generate a 10-point pulse train where each pulse has a width of 600 μ s and a pulse period of 5 ms. Alias the trigger timers to use for pulse width and period. Create a fixed level voltage sweep. Set the pulse width and trigger the pulse width timer with a period timer. Set the pulse period to output one pulse per period and the count to generate 10 pulses. Trigger the pulse period timer when a sweep is initiated. Configure the timer to output a trigger event when it starts the first delay. Trigger the SMU source action using pulse period timer. Trigger the SMU end pulse action using pulse width timer. Set the trigger model counts. Configure the SMU to execute a 10-point pulse train. Start the trigger model. Wait for the sweep to complete.

Also see

[smua.trigger.autoclear](#) (on page 11-240)

[smua.trigger.initiate\(\)](#) (on page 11-247)

[Triggering](#) (on page 6-1)

smua.trigger.endpulse.stimulus

This attribute defines which event will cause the end pulse event detector to enter the detected state.

Type	TSP-Link accessible	Affected by	Where saved	Default value
Attribute (RW)	Yes	SMU reset Instrument reset Recall setup	Not saved	0

Usage

```
eventID = smua.trigger.endpulse.stimulus
smua.trigger.endpulse.stimulus = eventID
```

<i>eventID</i>	Set to the event that triggers the end pulse action of the source
----------------	---

Details

Set this attribute to the event ID of any trigger event generator to wait for that event. To bypass waiting for an event, set this value of this attribute to 0. Set *eventID* to one of the existing trigger event IDs, which are shown in the following table.

Trigger event IDs*	
Event ID	Event description
smua.trigger.SWEEPING_EVENT_ID	Occurs when the source-measure unit (SMU) transitions from the idle state to the arm layer of the trigger model
smua.trigger.ARMED_EVENT_ID	Occurs when the SMU moves from the arm layer to the trigger layer of the trigger model
smua.trigger.SOURCE_COMPLETE_EVENT_ID	Occurs when the SMU completes a source action
smua.trigger.MEASURE_COMPLETE_EVENT_ID	Occurs when the SMU completes a measurement action
smua.trigger.PULSE_COMPLETE_EVENT_ID	Occurs when the SMU completes a pulse
smua.trigger.SWEEP_COMPLETE_EVENT_ID	Occurs when the SMU completes a sweep
smua.trigger.IDLE_EVENT_ID	Occurs when the SMU returns to the idle state
digio.trigger[N].EVENT_ID	Occurs when an edge is detected on a digital I/O line
tsplink.trigger[N].EVENT_ID	Occurs when an edge is detected on a TSP-Link line
lan.trigger[N].EVENT_ID	Occurs when the appropriate LXI trigger packet is received on LAN trigger object <i>N</i>
display.trigger.EVENT_ID	Occurs when the TRIG key on the front panel is pressed
trigger.EVENT_ID	Occurs when a *TRG command is received on the remote interface GPIB only: Occurs when a GET bus command is received USB only: Occurs when a USBTMC TRIGGER message is received VXI-11 only: Occurs with the VXI-11 command <code>device_trigger</code> ; reference the VXI-11 standard for additional details on the device trigger operation
trigger.blender[N].EVENT_ID	Occurs after a collection of events is detected
trigger.timer[N].EVENT_ID	Occurs when a delay expires
trigger.generator[N].EVENT_ID	Occurs when the <code>trigger.generator[N].assert()</code> function is executed
* Use the name of the trigger event ID to set the stimulus value rather than the numeric value. Using the name makes the code compatible for future upgrades (for example, if the numeric values must change when enhancements are added to the instrument).	

Example

```
smua.trigger.endpulse.action = smua.SOURCE_IDLE
smua.trigger.endpulse.stimulus = trigger.timer[1].EVENT_ID
```

Configure the end pulse action to achieve a pulse and select the event, `trigger.timer[1].EVENT_ID`, that causes the arm event detector to enter the detected state.

Also see

[Triggering](#) (on page 6-1)

smua.trigger.endsweep.action

This attribute sets the action of the source at the end of a sweep.

Type	TSP-Link accessible	Affected by	Where saved	Default value
Attribute (RW)	Yes	SMU reset Instrument reset Recall setup	Not saved	0 (smua.SOURCE_IDLE)

Usage

```
action = smua.trigger.endsweep.action
smua.trigger.endsweep.action = action
```

action

The source action at the end of a sweep; set to one of the following values:

- 0 or `smua.SOURCE_IDLE`: Sets the source level to the programmed (idle) level at the end of the sweep
- 1 or `smua.SOURCE_HOLD`: Sets the source level to stay at the level of the last step

Details

Use this attribute to configure the source action at the end of the sweep. The SMU can be programmed to return to the idle source level or hold the last value of the sweep.

Example

```
smua.trigger.endsweep.action = smua.SOURCE_IDLE
```

Sets SMU return the source back to the idle source level at the end of a sweep.

Also see

[Triggering](#) (on page 6-1)

smua.trigger.IDLE_EVENT_ID

This constant contains the idle event number.

Type	TSP-Link accessible	Affected by	Where saved	Default value
Constant	Yes			

Usage

```
eventID = smua.trigger.IDLE_EVENT_ID
```

eventID

The idle event number

Details

Set the stimulus of any trigger object to the value of this constant to have the trigger object respond to idle events from this SMU.

Example

```
trigger.timer[1].stimulus = smua.trigger.IDLE_EVENT_ID
```

Trigger timer 1 when the SMU returns to the idle layer.

Also see

[Triggering](#) (on page 6-1)

smua.trigger.initiate()

This function initiates a sweep operation.

Type	TSP-Link accessible	Affected by	Where saved	Default value
Function	Yes			

Usage

```
smua.trigger.initiate()
```

Details

This function causes the SMU to clear the four trigger model event detectors and enter its trigger model (moves the SMU from the idle state into the arm layer).

To perform source actions during the sweep, before calling this function, it is necessary to configure and enable one of the following sweep source actions:

- `smua.trigger.source.linearY()`
- `smua.trigger.source.listY()`
- `smua.trigger.source.logY()`

To make measurements during the sweep, you must also configure and enable the measure action using `smua.trigger.measure.Y()`.

If you run this function more than once without reconfiguring the sweep measurements, the caches on the configured measurement reading buffers will hold stale data; use the `bufferVar.clearcache()` function to remove stale values from the reading buffer cache.

This function initiates an overlapped operation.

Example

```
smua.trigger.initiate()
```

Starts a preconfigured sweep and clears the event detectors.

Also see

[bufferVar.clearcache\(\)](#) (on page 11-22)
[Configuring and running sweeps](#) (on page 4-71)
[smua.trigger.measure.action](#) (on page 11-248)
[smua.trigger.measure.Y\(\)](#) (on page 11-251)
[smua.trigger.source.action](#) (on page 11-253)
[smua.trigger.source.linearY\(\)](#) (on page 11-254)
[smua.trigger.source.listY\(\)](#) (on page 11-255)
[smua.trigger.source.logY\(\)](#) (on page 11-256)
[Triggering](#) (on page 6-1)

smua.trigger.measure.action

This attribute controls measurement actions during a sweep.

Type	TSP-Link accessible	Affected by	Where saved	Default value
Attribute (RW)	Yes	SMU reset Instrument reset Recall setup	Not saved	0 (smua.DISABLE)

Usage

```

action = smua.trigger.measure.action
smua.trigger.measure.action = action

```

<i>action</i>	<p>The sweep measurement action; set to one of the following values:</p> <ul style="list-style-type: none"> ▪ 0 or <code>smua.DISABLE</code>: Do not make measurements during the sweep ▪ 1 or <code>smua.ENABLE</code>: Make measurements during the sweep ▪ 2 or <code>smua.ASYNC</code>: Make measurements during the sweep, but asynchronously with the source area of the trigger model
---------------	---

Details

With this attribute enabled (setting *action* to `smua.ENABLE` or `smua.ASYNC`), configure the measurement with one of the `smua.trigger.measure.Y()` functions.

If this attribute is set to `smua.ASYNC`:

- Asynchronous sweep measurements can only be used with measure autoranging turned off. To turn measure autoranging off for all measurements during the sweep, set the `smua.measure.autorangeY` attribute to `smua.AUTORANGE_OFF`.
- Autozero must also be turned off. To turn off autozero, set the `smua.measure.autozero` attribute to `smua.AUTOZERO_OFF` or `smua.AUTOZERO_ONCE`.
- The reading buffer used by `smua.trigger.measure.Y()` must have `bufferVar.collectsourcevalues` set to 0.

If any of the above items is incorrectly configured, the `smua.trigger.initiate()` function generates an error.

Example

```
smua.trigger.measure.v(smua.nvbuffer1)
smua.trigger.measure.action = smua.ENABLE
```

Configure sweep voltage measurements.
Enable voltage measurements during the sweep.

Also see

- [bufferVar.collectsourcevalues](#) (on page 11-23)
- [smua.trigger.autoclear](#) (on page 11-240)
- [smua.trigger.measure.Y\(\)](#) (on page 11-251)
- [Triggering](#) (on page 6-1)

smua.trigger.measure.set()

This function sets the measurement event detector to the detected state.

Type	TSP-Link accessible	Affected by	Where saved	Default value
Function	Yes			

Usage

```
smua.trigger.measure.set()
```

Details

This function is useful whenever you want the SMU to continue operation without waiting for a programmed trigger event. When called, this function immediately satisfies the event detector, allowing the SMU to continue through the trigger model.

For example, you might use this function to have the SMU immediately perform an action the first time through the trigger model, even if a programmed trigger event does not occur.

If the event detectors are configured to clear automatically because the `smua.trigger.autoclear` attribute is set to `smua.ENABLE`, make sure that `smua.trigger.measure.set()` is issued after the SMU has entered the trigger layer. This function can also be used to start actions on the SMU in case of a missed trigger event.

The SMU automatically clears all event detectors when the `smua.trigger.initiate()` function is executed. This function should be called after the sweep is initiated.

Example

```
smua.trigger.measure.set() Sets the measure event detector.
```

Also see

- [smua.trigger.arm.set\(\)](#) (on page 11-238)
- [smua.trigger.autoclear](#) (on page 11-240)
- [smua.trigger.endpulse.set\(\)](#) (on page 11-243)
- [smua.trigger.source.set\(\)](#) (on page 11-258)

smua.trigger.measure.stimulus

This attribute selects the event that causes the measure event detector to enter the detected state.

Type	TSP-Link accessible	Affected by	Where saved	Default value
Attribute (RW)	Yes	SMU reset Instrument reset Recall setup	Not saved	0

Usage

```
eventID = smua.trigger.measure.stimulus
smua.trigger.measure.stimulus = eventID
```

<i>eventID</i>	Event that triggers the measurement detector
----------------	--

Details

Set this attribute to the event ID of any trigger event generator to wait for that event. When set, the SMU waits for the event at the measurement event detector portion of the trigger model.

Set this attribute to zero to bypass waiting for an event (the SMU continues uninterrupted through the remote trigger model). Set *eventID* to one of the existing trigger event IDs shown in the following table.

Trigger event IDs*	
Event ID	Event description
smua.trigger.SWEEPING_EVENT_ID	Occurs when the source-measure unit (SMU) transitions from the idle state to the arm layer of the trigger model
smua.trigger.ARMED_EVENT_ID	Occurs when the SMU moves from the arm layer to the trigger layer of the trigger model
smua.trigger.SOURCE_COMPLETE_EVENT_ID	Occurs when the SMU completes a source action
smua.trigger.MEASURE_COMPLETE_EVENT_ID	Occurs when the SMU completes a measurement action
smua.trigger.PULSE_COMPLETE_EVENT_ID	Occurs when the SMU completes a pulse
smua.trigger.SWEEP_COMPLETE_EVENT_ID	Occurs when the SMU completes a sweep
smua.trigger.IDLE_EVENT_ID	Occurs when the SMU returns to the idle state
digio.trigger[N].EVENT_ID	Occurs when an edge is detected on a digital I/O line
tsplink.trigger[N].EVENT_ID	Occurs when an edge is detected on a TSP-Link line
lan.trigger[N].EVENT_ID	Occurs when the appropriate LXI trigger packet is received on LAN trigger object <i>N</i>
display.trigger.EVENT_ID	Occurs when the TRIG key on the front panel is pressed
trigger.EVENT_ID	Occurs when a *TRG command is received on the remote interface GPIB only: Occurs when a GET bus command is received USB only: Occurs when a USBTMC TRIGGER message is received VXI-11 only: Occurs with the VXI-11 command <code>device_trigger</code> ; reference the VXI-11 standard for additional details on the device trigger operation
trigger.blender[N].EVENT_ID	Occurs after a collection of events is detected
trigger.timer[N].EVENT_ID	Occurs when a delay expires
trigger.generator[N].EVENT_ID	Occurs when the <code>trigger.generator[N].assert()</code> function is executed

* Use the name of the trigger event ID to set the stimulus value rather than the numeric value. Using the name makes the code compatible for future upgrades (for example, if the numeric values must change when enhancements are added to the instrument).

Example

```
smua.trigger.measure.stimulus = trigger.timer[1].EVENT_ID
Sets delay before measurement begins.
```

Also see

[Triggering](#) (on page 6-1)

smua.trigger.measure.Y()

This function configures the measurements that are to be made in a subsequent sweep.

Type	TSP-Link accessible	Affected by	Where saved	Default value
Function	Yes			

Usage

```
smua.trigger.measure.Y(rbuffer)
smua.trigger.measure.iv(ibuffer, vbuffer)
```

<i>Y</i>	SMU measurement type (<i>v</i> = voltage, <i>i</i> = current, <i>r</i> = resistance, <i>p</i> = power)
<i>rbuffer</i>	A reading buffer object where the readings will be stored
<i>ibuffer</i>	A reading buffer object where current readings will be stored
<i>vbuffer</i>	A reading buffer object where voltage readings will be stored

Details

As measurements are made, they are stored in a reading buffer. If the instrument is configured to return multiple readings where one is requested, the readings are available as they are made. Measurements are in the following units of measure: *v* = volts, *i* = amperes, *r* = ohms, *p* = watts.

The `smua.trigger.measure.iv()` function stores current readings in *ibuffer* and voltage readings in *vbuffer*.

If a given reading buffer contains any data, it is cleared before making any measurements, unless the reading buffer has been configured to append data.

The SMU only retains the last call to any one of these functions and only that measurement action is performed.

After configuring the measurements to make with this function, enable the measurement action.

Example

```
smua.trigger.measure.v(vbuffername)
smua.trigger.measure.action = smua.ENABLE
Stores voltage readings during the sweep in
buffer vbuffername.
```

Also see

- [Reading buffers](#) (on page 5-1)
- [smua.measure.Y\(\)](#) (on page 11-209)
- [smua.nvbufferY](#) (on page 11-211)
- [smua.trigger.measure.action](#) (on page 11-248)
- [Sweep Operation](#) (on page 4-61)
- [Triggering](#) (on page 6-1)
- [waitcomplete\(\)](#) (on page 11-393)

smua.trigger.MEASURE_COMPLETE_EVENT_ID

This constant contains the measurement complete event number.

Type	TSP-Link accessible	Affected by	Where saved	Default value
Constant	Yes			

Usage

```
eventID = smua.trigger.MEASURE_COMPLETE_EVENT_ID
```

<i>eventID</i>	The measurement complete event number
----------------	---------------------------------------

Details

Set the stimulus of any trigger object to the value of this constant to have the trigger object respond to measure complete events from this SMU.

Example

```
trigger.timer[1].stimulus = smua.trigger.MEASURE_COMPLETE_EVENT_ID
```

Trigger the timer when the SMU completes a measurement.

Also see

[Triggering](#) (on page 6-1)

smua.trigger.PULSE_COMPLETE_EVENT_ID

This constant contains the pulse complete event number.

Type	TSP-Link accessible	Affected by	Where saved	Default value
Constant	Yes			

Usage

```
eventID = smua.trigger.PULSE_COMPLETE_EVENT_ID
```

<i>eventID</i>	The pulse complete event number
----------------	---------------------------------

Details

Set the stimulus of any trigger object to the value of this constant to have the trigger object respond to pulse complete events.

Example

```
trigger.timer[1].stimulus = smua.trigger.PULSE_COMPLETE_EVENT_ID
```

Trigger a timer when the SMU completes a pulse.

Also see

[Triggering](#) (on page 6-1)

smua.trigger.source.action

This attribute enables or disables sweeping the source (on or off).

Type	TSP-Link accessible	Affected by	Where saved	Default value
Attribute (RW)	Yes	SMU reset Instrument reset Recall setup	Not saved	0 (smua.DISABLE)

Usage

```
action = smua.trigger.source.action
smua.trigger.source.action = action
```

<i>action</i>	Sweep source action. Set to one of the following values: <ul style="list-style-type: none"> ▪ 0 or smua.DISABLE: Do not sweep the source ▪ 1 or smua.ENABLE: Sweep the source
---------------	---

Details

This attribute is used to enable or disable source level changes during a sweep. In addition to enabling the action before initiating the sweep, make sure to configure it using `smua.trigger.source.linearY()`, `smua.trigger.source.listY()`, or `smua.trigger.source.logY()`.

Example

```
smua.trigger.source.listv({3, 1, 4, 5, 2})
smua.trigger.source.action = smua.ENABLE
```

Configure list sweep (sweep through 3 V, 1 V, 4 V, 5 V, and 2 V).
Enable the source action.

Also see

- [smua.trigger.source.linearY\(\)](#) (on page 11-254)
- [smua.trigger.source.listY\(\)](#) (on page 11-255)
- [smua.trigger.source.logY\(\)](#) (on page 11-256)
- [Triggering](#) (on page 6-1)

smua.trigger.source.limitY

This attribute sets the sweep source limit.

Type	TSP-Link accessible	Affected by	Where saved	Default value
Attribute (RW)	Yes	SMU reset Instrument reset Recall setup	Not saved	0 (smua.LIMIT_AUTO)

Usage

```
sweepSourceLimit = smua.trigger.source.limitY
smua.trigger.source.limitY = sweepSourceLimit
```

<i>sweepSourceLimit</i>	The source limit that is used during triggered operation; set to a user-defined value or <code>smua.LIMIT_AUTO</code>
Y	SMU output function (v = voltage, i = current)

Details

Use this attribute to perform extended operating area (EOA) pulse mode sweeps.

If this attribute is set to `smua.LIMIT_AUTO` (or 0), the SMU uses the normal limit setting during sweeping. If this attribute is set to any other numeric value, the SMU switches in this limit at the start of the source action and returns to the normal limit setting at the end of the end pulse action.

Normally, the limit range is automatically adjusted in accordance with the limit value. During sweeping, however, the limit range is fixed to avoid the delays associated with changing range. This fixed limit range is determined by the maximum limit value needed during the sweep; that is, the greater of either the normal limit value (as specified by `smua.source.limitY`) or the sweep limit value (as specified by `smua.trigger.source.limitY`). Note that the minimum limit value that can be enforced during the sweep is equal to 10% of the full scale value of the fixed limit range. If the smaller limit value (normal or sweep) falls below this 10% threshold, the 10% value is enforced instead. Likewise, if the limit value falls below the 10% threshold as a result of power compliance, the 10% value is enforced instead.

When using the EOA, the SMU will automatically start the end pulse action if the SMU is not triggered before its maximum pulse width. It will also delay the source action if necessary to limit the pulse duty cycle to stay within the capabilities of the SMU.

Example

```
smua.trigger.source.limitv = 10
```

Sets the voltage sweep limit to 10 V.

Also see

[Configuring and running sweeps](#) (on page 4-71)

[smua.source.limitY](#) (on page 11-230)

[Triggering](#) (on page 6-1)

smua.trigger.source.linearY()

This function configures a linear source sweep.

Type	TSP-Link accessible	Affected by	Where saved	Default value
Function	Yes			

Usage

```
smua.trigger.source.linearY(startValue, endValue, points)
```

<i>Y</i>	SMU source function (<i>v</i> = voltage, <i>i</i> = current)
<i>startValue</i>	Source value of the first point
<i>endValue</i>	Source value of the last point
<i>points</i>	The number of points used to calculate the step size

Details

This function configures the source action to be a linear source sweep in a subsequent sweep. During the sweep, the source will generate a uniform series of ascending or descending voltage or current changes called steps. The number of source steps is one less than the number of sourced *points*.

The *points* parameter does not set the number of steps in a sweep, but rather is used to calculate source values within a subsequent sweep. If the subsequent sweep has more points than specified in *points*, the source will restart at the beginning. This means that if the trigger count is greater than the number of points in a sweep as configured, the SMU will satisfy the trigger count by restarting the sweep values from the beginning.

If the subsequent sweep has fewer points than specified in *points*, *endValue* will not be reached during the sweep. This means that if the trigger count is less than the number of source values configured, the SMU will satisfy the trigger count and ignore the remaining source values.

In cases where the first sweep point is a nonzero value, it may be necessary to pre-charge the circuit so that the sweep will return a stable value for the first measured point without penalizing remaining points in the sweep.

With linear sweeps, it is acceptable to maintain a fixed source resolution over the entire sweep. To prevent source range changes during the sweep (especially when sweeping through 0.0), set the source range to a fixed range appropriate for the larger of either *startValue* or *endValue*.

The SMU will only store the most recent configured source action. The last call to `smua.trigger.source.linearY()`, `smua.trigger.source.listY()`, or `smua.trigger.source.logY()` is used for the source action.

Source functions cannot be changed within a sweep.

After configuring the sweep source values, enable the source action by setting `smua.trigger.source.action`.

Example

```
smua.trigger.source.linearv(0, 10, 11)
```

Sweeps from 0 V to 10 V in 1 V steps.

Also see

[smua.trigger.source.action](#) (on page 11-253)

[smua.trigger.source.listY\(\)](#) (on page 11-255)

[smua.trigger.source.logY\(\)](#) (on page 11-256)

[Sweep Operation](#) (on page 4-61)

smua.trigger.source.listY()

This function configures an array-based source sweep.

Type	TSP-Link accessible	Affected by	Where saved	Default value
Function	Yes			

Usage

```
smua.trigger.source.listY(sweepList)
```

<i>Y</i>	SMU source function (<i>v</i> = voltage, <i>i</i> = current)
<i>sweepList</i>	An array of source values

Details

This function configures the source action to be a list sweep in a subsequent sweep. During the sweep, the source will output the sequence of source values given in the *sweepList* array.

If the subsequent sweep has more points than specified in *sweepList*, the source will restart at the beginning. This means that if the trigger count is greater than the number of points in a sweep as configured, the SMU will satisfy the trigger count by restarting the sweep values from the beginning.

If the subsequent sweep has fewer points than specified in *sweepList*, the extra values will be ignored. This means that if the trigger count is less than the number of source values configured, the SMU will satisfy the trigger count and ignore the remaining source values.

In cases where the first sweep point is a nonzero value, it may be necessary to pre-charge the circuit so that the sweep will return a stable value for the first measured point without penalizing remaining points in the sweep.

The SMU will only store the most recent configured source action. The last call to `smua.trigger.source.linearY()`, `smua.trigger.source.listY()`, or `smua.trigger.source.logY()` is used for the source action.

Source functions cannot be changed within a sweep.

After configuring the sweep source values, enable the source action by setting `smua.trigger.source.action`.

Example

```
smua.trigger.source.listv({3, 1, 4, 5, 2}) Sweeps through 3 V, 1 V, 4 V, 5 V, and 2 V.
```

Also see

[smua.trigger.source.action](#) (on page 11-253)
[smua.trigger.source.linearY\(\)](#) (on page 11-254)
[smua.trigger.source.logY\(\)](#) (on page 11-256)
[Sweep Operation](#) (on page 4-61)

smua.trigger.source.logY()

This function configures an exponential (geometric) source sweep.

Type	TSP-Link accessible	Affected by	Where saved	Default value
Function	Yes			

Usage

```
smua.trigger.source.logY(startValue, endValue, points, asymptote)
```

<i>Y</i>	SMU source function (v = voltage, i = current)
<i>startValue</i>	Source value of the first point
<i>endValue</i>	Source value of the last point
<i>points</i>	The number of points used to calculate the step size
<i>asymptote</i>	The asymptotic offset value

Details

This function configures the source action to be a geometric source sweep in a subsequent sweep. During the sweep, the source generates a geometric series of ascending or descending voltage or current changes called steps. Each step is larger or smaller than the previous step by a fixed proportion. The constant of proportionality is determined by the starting value, the ending value, the asymptote, and the number of steps in the sweep. The number of source steps is one less than the number of sourced *points*.

The *points* parameter does not set the number of steps in a sweep, but rather is used to calculate source values within a subsequent sweep. If the subsequent sweep has more points than specified in *points*, the source restarts at the beginning. This means that if the trigger count is greater than the number of points in a sweep as configured, the SMU satisfies the trigger count by restarting the sweep values from the beginning.

If the subsequent sweep has fewer points than specified in *points*, *endValue* is not reached during the sweep. This means that if the trigger count is less than the number of source values configured, the SMU satisfies the trigger count and ignores the remaining source values.

In cases where the first sweep point is nonzero, it may be necessary to pre-charge the circuit so that the sweep returns a stable value for the first measured point without penalizing remaining points in the sweep.

With logarithmic sweeps, it is usually necessary to allow the source to autorange to maintain good source accuracy when sweeping over more than one decade or across range boundaries.

The *asymptote* parameter can be used to customize the inflection and offset of the source value curve. This allows log sweeps to cross zero. Setting this parameter to zero provides a conventional logarithmic sweep. The *asymptote* value is the value that the curve has at either positive or negative infinity, depending on the direction of the sweep.

The *asymptote* value must not be equal to or between the starting and ending values. It must be outside the range defined by the starting and ending values.

The SMU stores only the most recent configured source action. The last call to `smua.trigger.source.linearY()`, `smua.trigger.source.listY()`, or `smua.trigger.source.logY()` is used for the source action.

Source functions cannot be changed within a sweep.

After configuring the sweep source values, enable the source action by setting `smua.trigger.source.action`.

Example

```
smua.trigger.source.logv(1, 10, 11, 0)
```

Sweeps from 1 V to 10 V in 10 steps with an asymptote of 0 V.

Also see

[smua.trigger.source.action](#) (on page 11-253)
[smua.trigger.source.linearY\(\)](#) (on page 11-254)
[smua.trigger.source.listY\(\)](#) (on page 11-255)
[Sweep operation](#) (on page 4-61)

smua.trigger.source.pulsewidth

This attribute sets the source pulse width when using a trigger model sweep when the pulser is enabled

Type	TSP-Link accessible	Affected by	Where saved	Default value
Attribute (RW)	Yes	Instrument reset SMU reset Recall setup	Saved setup	0

Usage

```
pulsewidth = smua.trigger.source.pulsewidth
smua.trigger.source.pulsewidth = pulsewidth
```

<i>pulsewidth</i>	The source pulse width in seconds; set from 0.000001 to 0.065; set to 0 to disable automatic pulsewidth control
-------------------	---

Details

Use this attribute only when generating pulses using the trigger model when the pulser is enabled.

Set the *pulsewidth* parameter to a nonzero value to limit the action of the source to the specified pulse width. This allows the 2601B-PULSE to generate pulses with less pulsewidth jitter than those generated using the end-pulse trigger block in the trigger model.

The value set for this attribute affects the values you can use for the `smua.pulser.measure.aperture` and `smu.pulser.measure.delay` attributes. The sum of the measure delay and the aperture must be less than the specified pulse width.

You cannot use this attribute and `smua.trigger.endpulse.action` in the same trigger model.

Example

```
smua.trigger.source.pulsewidth = 50e-6
```

Set the source pulse width to 50 μ s.

Also see

[smua.pulser.measure.aperture](#) (on page 11-213)

[smua.pulser.measure.delay](#) (on page 11-215)

[smua.trigger.endpulse.action](#) (on page 11-243)

smua.trigger.source.set()

This function sets the source event detector to the detected state.

Type	TSP-Link accessible	Affected by	Where saved	Default value
Function	Yes			

Usage

```
smua.trigger.source.set()
```

Details

This function sets the source event detector to the detected state.

The SMU automatically clears all event detectors when the `smua.trigger.initiate()` function is executed. This function should be called after the sweep is initiated. If the event detectors are configured to clear automatically because the `smua.trigger.autoclear` attribute is set to `smua.ENABLE`, make sure that `smua.trigger.source.set()` is issued after the SMU has entered the trigger layer.

Example

```
reset()
smua.trigger.source.listv({5})
smua.trigger.source.stimulus = display.trigger.EVENT_ID
smua.source.output = smua.OUTPUT_ON
smua.trigger.initiate()
delay(1)
-- Continue even if the display trigger key was not pressed.
smua.trigger.source.set()
waitcomplete()
```

Sets the source event detector.

Also see

[smua.trigger.arm.set\(\)](#) (on page 11-238)
[smua.trigger.autoclear](#) (on page 11-240)
[smua.trigger.endpulse.set\(\)](#) (on page 11-243)
[smua.trigger.initiate\(\)](#) (on page 11-247)
[smua.trigger.measure.set\(\)](#) (on page 11-249)
[Triggering](#) (on page 6-1)

smua.trigger.source.stimulus

This attribute defines which event causes the source event detector to enter the detected state.

Type	TSP-Link accessible	Affected by	Where saved	Default value
Attribute (RW)	Yes	SMU reset Instrument reset Recall setup	Not saved	0

Usage

```
eventID = smua.trigger.source.stimulus
smua.trigger.source.stimulus = eventID
```

<code>eventID</code>	Set to the event that triggers the end-pulse source off action
----------------------	--

Details

Set this attribute to the event ID of any trigger event generator to wait for that event. When set, the SMU waits for the event at the source event detector portion of the trigger model. To bypass waiting for an event, set the value of this attribute to zero (0). Set *eventID* to one of the existing trigger event IDs shown in the following table.

Trigger event IDs*	
Event ID	Event description
<code>smua.trigger.SWEEPING_EVENT_ID</code>	Occurs when the source-measure unit (SMU) transitions from the idle state to the arm layer of the trigger model
<code>smua.trigger.ARMED_EVENT_ID</code>	Occurs when the SMU moves from the arm layer to the trigger layer of the trigger model
<code>smua.trigger.SOURCE_COMPLETE_EVENT_ID</code>	Occurs when the SMU completes a source action
<code>smua.trigger.MEASURE_COMPLETE_EVENT_ID</code>	Occurs when the SMU completes a measurement action
<code>smua.trigger.PULSE_COMPLETE_EVENT_ID</code>	Occurs when the SMU completes a pulse
<code>smua.trigger.SWEEP_COMPLETE_EVENT_ID</code>	Occurs when the SMU completes a sweep
<code>smua.trigger.IDLE_EVENT_ID</code>	Occurs when the SMU returns to the idle state
<code>digio.trigger[N].EVENT_ID</code>	Occurs when an edge is detected on a digital I/O line
<code>tsplink.trigger[N].EVENT_ID</code>	Occurs when an edge is detected on a TSP-Link line
<code>lan.trigger[N].EVENT_ID</code>	Occurs when the appropriate LXI trigger packet is received on LAN trigger object <i>N</i>
<code>display.trigger.EVENT_ID</code>	Occurs when the TRIG key on the front panel is pressed
<code>trigger.EVENT_ID</code>	Occurs when a *TRG command is received on the remote interface GPIB only: Occurs when a GET bus command is received USB only: Occurs when a USBTMC TRIGGER message is received VXI-11 only: Occurs with the VXI-11 command <code>device_trigger</code> ; reference the VXI-11 standard for additional details on the device trigger operation
<code>trigger.blender[N].EVENT_ID</code>	Occurs after a collection of events is detected
<code>trigger.timer[N].EVENT_ID</code>	Occurs when a delay expires
<code>trigger.generator[N].EVENT_ID</code>	Occurs when the <code>trigger.generator[N].assert()</code> function is executed
* Use the name of the trigger event ID to set the stimulus value rather than the numeric value. Using the name makes the code compatible for future upgrades (for example, if the numeric values must change when enhancements are added to the instrument).	

Example

```
smua.trigger.source.stimulus = digio.trigger[2].EVENT_ID
```

Configure to start its source action when a trigger event occurs on digital I/O line 2.

Also see

[Triggering](#) (on page 6-1)

smua.trigger.SOURCE_COMPLETE_EVENT_ID

This constant contains the source complete event number.

Type	TSP-Link accessible	Affected by	Where saved	Default value
Constant	Yes			

Usage

```
eventID = smua.trigger.SOURCE_COMPLETE_EVENT_ID
```

<i>eventID</i>	The source action complete event number
----------------	---

Details

Set the stimulus of any trigger object to the value of this constant to have the trigger object respond to source complete events from this source-measure unit (SMU).

Example

```
trigger.timer[1].stimulus = smua.trigger.SOURCE_COMPLETE_EVENT_ID
```

Trigger the timer when the SMU updates the source level or starts a pulse.

Also see

[Triggering](#) (on page 6-1)

smua.trigger.SWEEP_COMPLETE_EVENT_ID

This constant contains the sweep complete event number.

Type	TSP-Link accessible	Affected by	Where saved	Default value
Constant	Yes			

Usage

```
eventID = smua.trigger.SWEEP_COMPLETE_EVENT_ID
```

<i>eventID</i>	The sweep complete event number
----------------	---------------------------------

Details

Set the stimulus of any trigger object to the value of this constant to have the trigger object respond to sweep complete events from this SMU.

Example

```
digio.trigger[2].mode = digio.TRIG_RISINGA
digio.trigger[2].clear()
smua.trigger.source.stimulus = digio.trigger[2].EVENT_ID
digio.trigger[4].mode = digio.TRIG_RISINGM
digio.trigger[4].pulsewidth = 0.001
digio.trigger[4].stimulus = smua.trigger.SWEEP_COMPLETE_EVENT_ID
```

Configure the 2601B-PULSE to detect a rising edge on digital I/O line 2.
 Configure SMU A to start its source action when a trigger event occurs on digital I/O line 2.
 Configure digital I/O line 4 to output a 1 ms rising-edge trigger pulse at the completion of the SMU sweep.

Also see

[Triggering](#) (on page 6-1)

smua.trigger.SWEEPING_EVENT_ID

This constant contains the sweeping event number.

Type	TSP-Link accessible	Affected by	Where saved	Default value
Constant	Yes			

Usage

```
eventID = smua.trigger.SWEEPING_EVENT_ID
```

eventID	The sweeping event number
---------	---------------------------

Details

Set the stimulus of any trigger object to the value of this constant to have the trigger object respond to sweeping events from this SMU.

Example

```
reset()
period_timer = trigger.timer[1]
pulse_timer = trigger.timer[2]
smua.trigger.source.listv( {5} )
smua.trigger.source.action = smua.ENABLE
smua.source.rangev = 5
smua.trigger.measure.action = smua.DISABLE
pulse_timer.delay = 0.0006
pulse_timer.stimulus = period_timer.EVENT_ID
pulse_timer.count = 1
period_timer.delay = 0.005
period_timer.count = 9
period_timer.stimulus = smua.trigger.SWEEPING_EVENT_ID
period_timer.passthrough = true
smua.trigger.source.stimulus = period_timer.EVENT_ID
smua.trigger.endpulse.action = smua.SOURCE_IDLE
smua.trigger.endpulse.stimulus = pulse_timer.EVENT_ID
smua.trigger.count = 1
smua.trigger.arm.count = 10
smua.source.output = smua.OUTPUT_ON
smua.trigger.initiate()
waitcomplete()
smua.source.output = smua.OUTPUT_OFF
```

Generate a 10-point pulse train where each pulse has a width of 600 μ s and a pulse period of 5 ms.

Alias the trigger timers to use for pulse width and period.

Create a fixed level voltage sweep.

Set the pulse width and trigger the pulse width timer with a period timer.

Set the pulse period to output one pulse per period and the count to generate 10 pulses.

Trigger the pulse period timer when a sweep is initiated.

Configure the timer to output a trigger event when it starts the first delay.

Trigger the SMU source action using pulse period timer.

Trigger the SMU end pulse action using pulse width timer.

Set the trigger model counts.
 Configure the SMU to execute a 10-point pulse train.
 Start the trigger model.
 Wait for the sweep to complete.

Also see

[Triggering](#) (on page 6-1)

status.condition

This attribute stores the status byte condition register.

Type	TSP-Link accessible	Affected by	Where saved	Default value
Attribute (R)	Yes	Not applicable	Not saved	Not applicable

Usage

```
statusByte = status.condition
```

<i>statusByte</i>	The status byte; a zero (0) indicates no bits set; other values indicate various bit settings
-------------------	---

Details

This attribute is used to read the status byte, which is returned as a numeric value. The binary equivalent of the value of this attribute indicates which register bits are set. In the binary equivalent, the least significant bit is bit B0, and the most significant bit is bit B7. For example, if a value of 1.29000e+02 (which is 129) is read as the value of this register, the binary equivalent is 1000 0001. This value indicates that bit B0 and bit B7 are set.

B7	B6	B5	B4	B3	B2	B1	B0
**	>	>	>	>	>	>	*
1	0	0	0	0	0	0	1

* Least significant bit

** Most significant bit

The returned value can indicate one or more status events occurred. When an enabled status event occurs, a summary bit is set in this register to indicate the event occurrence.

The individual bits of this register have the following meanings:

Bit	Value and description
B0	status.MEASUREMENT_SUMMARY_BIT status.MSB Set summary bit indicates that an enabled measurement event has occurred. Bit B0 decimal value: 1
B1	status.SYSTEM_SUMMARY_BIT status.SSB Set summary bit indicates that an enabled system event has occurred. Bit B1 decimal value: 2
B2	status.ERROR_AVAILABLE status.EAV Set summary bit indicates that an error or status message is present in the Error Queue. Bit B2 decimal value: 4

Bit	Value and description
B3	status.QUESTIONABLE_SUMMARY_BIT status.QSB Set summary bit indicates that an enabled questionable event has occurred. Bit B3 decimal value: 8
B4	status.MESSAGE_AVAILABLE status.MAV Set summary bit indicates that a response message is present in the Output Queue. Bit B4 decimal value: 16
B5	status.EVENT_SUMMARY_BIT status.ESB Set summary bit indicates that an enabled standard event has occurred. Bit B5 decimal value: 32
B6	status.MASTER_SUMMARY_STATUS status.MSS Request Service (RQS)/Master Summary Status (MSS). Depending on how it is used, bit B6 of the status byte register is either the Request for Service (RQS) bit or the Master Summary Status (MSS) bit: <ul style="list-style-type: none"> ■ When using the GPIB, USB, or VXI-11 serial poll sequence of the 2601B-PULSE to obtain the status byte (serial poll byte), B6 is the RQS bit. The set bit indicates that the Request Service (RQS) bit of the status byte (serial poll byte) is set and a service request (SRQ) has occurred. ■ When using the <code>status.condition</code> register command or the <code>*STB?</code> common command to read the status byte, B6 is the MSS bit. Set bit indicates that an enabled summary bit of the status byte register is set. Bit B6 decimal value: 64
B7	status.OPERATION_SUMMARY_BIT status.OSB Set summary bit indicates that an enabled operation event has occurred. Bit B7 decimal value: 128

In addition to the above constants, when more than one bit of the register is set, `statusByte` equals the sum of their decimal weights. For example, if 129 is returned, bits B0 and B7 are set (1 + 128).

Bit	B7	B6	B5	B4	B3	B2	B1	B0
Binary value	0/1	0/1	0/1	0/1	0/1	0/1	0/1	0/1
Decimal	128	64	32	16	8	4	2	1
Weights	(2 ⁷)	(2 ⁶)	(2 ⁵)	(2 ⁴)	(2 ³)	(2 ²)	(2 ¹)	(2 ⁰)

Example

```
statusByte = status.condition
print(statusByte)
```

Returns `statusByte`.

Sample output:

```
1.29000e+02
```

Converting this output (129) to its binary equivalent yields 1000 0001

Therefore, this output indicates that the set bits of the status byte condition register are presently B0 (MSS) and B7 (OSB).

Also see

[Status byte and service request \(SRQ\)](#) (on page 15-15)

status.measurement.*

This attribute contains the measurement event register set.

Type	TSP-Link accessible	Affected by	Where saved	Default value
Attribute	--	--	--	--
.condition (R)	Yes	Not applicable	Not saved	Not applicable
.enable (RW)	Yes	Status reset	Not saved	0
.event (R)	Yes	Status reset	Not saved	0
.ntr (RW)	Yes	Status reset	Not saved	0
.ptr (RW)	Yes	Status reset	Not saved	10,635 (All bits set)

Usage

```

measurementRegister = status.measurement.condition
measurementRegister = status.measurement.enable
measurementRegister = status.measurement.event
measurementRegister = status.measurement.ntr
measurementRegister = status.measurement.ptr
status.measurement.enable = measurementRegister
status.measurement.ntr = measurementRegister
status.measurement.ptr = measurementRegister
    
```

<i>measurementRegister</i>	The status of the measurement event register; a zero (0) indicates no bits set (also send 0 to clear all bits); other values indicate various bit settings
----------------------------	--

Details

These attributes read or write the measurement event registers.

Reading a status register returns a value. The binary equivalent of the returned value indicates which register bits are set. The least significant bit of the binary number is bit B0, and the most significant bit is bit B15.

For example, assume value 257 is returned for the enable register. The binary equivalent is 0000 0001 0000 0001. This value indicates that bit B0 (VLMT) and bit B8 (BAV) are set.

B15	B14	B13	B12	B11	B10	B9	B8	B7	B6	B5	B4	B3	B2	B1	B0
**	>	>	>	>	>	>	>	>	>	>	>	>	>	>	*
0	0	0	0	0	0	0	1	0	0	0	0	0	0	0	1

- * Least significant bit
- ** Most significant bit

For information about .condition, .enable, .event, .ntr, and .ptr registers, refer to [Status register set contents](#) (on page 15-1) and [Enable and transition registers](#) (on page 15-19). The individual bits of this register are defined in the following table.

Bit	Value and description
B0	status.measurement.VOLTAGE_LIMIT status.measurement.VLMT Set bit is a summary of the status.measurement.voltage_limit register. Bit B0 decimal value: 1
B1	status.measurement.CURRENT_LIMIT status.measurement.ILMT Set bit is a summary of the status.measurement.current_limit register. Bit B1 decimal value: 2
B2	Not used
B3	status.measurement.PROTECTION status.measurement.PROT Set bit indicates that the pulser protection was tripped. Refer to smua.pulser.protect.tripped for events that can trip the protection circuits. Bit B1 decimal value: 8
B4 to B6	Not used
B7	status.measurement.READING_OVERFLOW status.measurement.ROF Set bit is a summary of the status.measurement.reading_overflow register. Bit B7 decimal value: 128
B8	status.measurement.BUFFER_AVAILABLE status.measurement.BAV Set bit is a summary of the status.measurement.buffer_available register. Bit B8 decimal value: 256
B9 to B10	Not used
B11	status.measurement.INTERLOCK status.measurement.INT Interlock line. Set bit indicates that interlock is asserted. Bit B11 decimal value: 2,048
B12	Not used
B13	status.measurement.INSTRUMENT_SUMMARY status.measurement.INST Set bit indicates that a bit in the measurement instrument summary register is set. Bit B13 decimal value: 8,192
B14 to B15	Not used

As an example, to set bit B8 of the measurement event enable register, set
`status.measurement.enable = status.measurement.BAV.`

In addition to the above constants, *measurementRegister* can be set to the decimal equivalent of the bit to set. To set more than one bit of the register, set *measurementRegister* to the sum of their decimal weights. For example, to set bits B1 and B8, set *measurementRegister* to 258 (which is the sum of 2 + 256).

Bit	B7	B6	B5	B4	B3	B2	B1	B0
Binary value	0/1	0/1	0/1	0/1	0/1	0/1	0/1	0/1
Decimal	128	64	32	16	8	4	2	1
Weights	(2 ⁷)	(2 ⁶)	(2 ⁵)	(2 ⁴)	(2 ³)	(2 ²)	(2 ¹)	(2 ⁰)

Bit	B15	B14	B13	B12	B11	B10	B9	B8
Binary value	0/1	0/1	0/1	0/1	0/1	0/1	0/1	0/1
Decimal	32,768	16,384	8,192	4,096	2,048	1,024	512	256
Weights	(2 ¹⁵)	(2 ¹⁴)	(2 ¹³)	(2 ¹²)	(2 ¹¹)	(2 ¹⁰)	(2 ⁹)	(2 ⁸)

Example

```
status.measurement.enable = status.measurement.BAV
```

Sets the BAV bit of the measurement event enable register.

Also see

[Measurement event registers](#) (on page 15-7)
[smua.pulser.protect.tripped](#) (on page 11-218)

status.measurement.buffer_available.*

This attribute contains the measurement event buffer available summary register set.

Type	TSP-Link accessible	Affected by	Where saved	Default value
Attribute	--	--	--	--
.condition (R)	Yes	Not applicable	Not saved	Not applicable
.enable (RW)	Yes	Status reset	Not saved	0
.event (R)	Yes	Status reset	Not saved	0
.ntr (RW)	Yes	Status reset	Not saved	0
.ptr (RW)	Yes	Status reset	Not saved	2 (All bits set)

Usage

```
measurementRegister = status.measurement.buffer_available.condition
measurementRegister = status.measurement.buffer_available.enable
measurementRegister = status.measurement.buffer_available.event
measurementRegister = status.measurement.buffer_available.ntr
measurementRegister = status.measurement.buffer_available.ptr
status.measurement.buffer_available.enable = measurementRegister
status.measurement.buffer_available.ntr = measurementRegister
status.measurement.buffer_available.ptr = measurementRegister
```

<i>measurementRegister</i>	The status of the measurement event register; a zero (0) indicates no bits set (also send 0 to clear all bits); other values indicate various bit settings
----------------------------	--

Details

These attributes are used to read or write to the measurement event buffer available summary registers. Reading a status register returns a value. The binary equivalent of the returned value indicates which register bits are set. The least significant bit of the binary number is bit B0, and the most significant bit is bit B15.

For information about .condition, .enable, .event, .ntr, and .ptr registers, refer to [Status register set contents](#) (on page 15-1) and [Enable and transition registers](#) (on page 15-19). The individual bits of this register are defined in the following table.

Bit	Value and description
B0	Not used
B1	<pre>status.measurement.buffer_available.SMUA</pre> Set bit indicates that there is at least one reading stored in either or both of the dedicated reading buffers. Bit B1 decimal value: 2 Binary value: 0000 0010
B2 to B15	Not used

As an example, to set bit B1 of the measurement event buffer available summary enable register, set `status.measurement.buffer_available.enable = status.measurement.buffer_available.SMUA`.

In addition to the above constants, `measurementRegister` can be set to the decimal equivalent of the bit to set.

Example 1

```
status.measurement.buffer_available.enable =
status.measurement.buffer_available.SMUA
```

Uses the constant to set the SMUA bit of the measurement event buffer available summary enable register.

Example 2

```
status.measurement.buffer_available.enable = 2
```

Uses the decimal value to set the SMUA bit of the measurement event buffer available summary enable register.

Also see

[Measurement event registers](#) (on page 15-7)

status.measurement.current_limit.*

This attribute contains the measurement event current limit summary registers.

Type	TSP-Link accessible	Affected by	Where saved	Default value
Attribute	--	--	--	--
.condition (R)	Yes	Not applicable	Not saved	Not applicable
.enable (RW)	Yes	Status reset	Not saved	0
.event (R)	Yes	Status reset	Not saved	0
.ntr (RW)	Yes	Status reset	Not saved	0
.ptr (RW)	Yes	Status reset	Not saved	2 (All bits set)

Usage

```
measurementRegister = status.measurement.current_limit.condition
measurementRegister = status.measurement.current_limit.enable
measurementRegister = status.measurement.current_limit.event
measurementRegister = status.measurement.current_limit.ntr
measurementRegister = status.measurement.current_limit.ptr
status.measurement.current_limit.enable = measurementRegister
status.measurement.current_limit.ntr = measurementRegister
status.measurement.current_limit.ptr = measurementRegister
```

<i>measurementRegister</i>	The status of the measurement event current limit summary register; a zero (0) indicates no bits set (also send 0 to clear all bits); other values indicate various bit settings
----------------------------	--

Details

These attributes are used to read or write to the measurement event current limit summary registers. Reading a status register returns a value. The binary equivalent of the returned value indicates which register bits are set. The least significant bit of the binary number is bit B0, and the most significant bit is bit B15.

For information about .condition, .enable, .event, .ntr, and .ptr registers, refer to [Status register set contents](#) (on page 15-1) and [Enable and transition registers](#) (on page 15-19). The individual bits of this register are defined in the following table.

Bit	Value and description
B0	Not used
B1	status.measurement.current_limit.SMUA Set bit indicates that the SMU A current limit was exceeded. Bit B1 decimal value: 2 Binary value: 0000 0010
B2 to B15	Not used

As an example, to set bit B1 of the measurement event current limit summary enable register, set `status.measurement.current_limit.enable = status.measurement.current_limit.SMUA`.

In addition to the above constants, *measurementRegister* can be set to the decimal value of Bit B1.

Example 1

```
status.measurement.current_limit.enable = status.measurement.current_limit.SMUA
Sets the SMUA bit of the Measurement Event Current Limit Summary Enable Register using a constant.
```

Example 2

```
status.measurement.current_limit.enable = 2
Sets the SMUA bit of the Measurement Event Current Limit Summary Enable Register using a decimal value.
```

Also see

- [Measurement event registers](#) (on page 15-7)
- [status.measurement.instrument.smua.*](#) (on page 11-271)

status.measurement.instrument.*

This attribute contains the registers of the measurement event instrument summary register set.

Type	TSP-Link accessible	Affected by	Where saved	Default value
Attribute	--	--	--	--
.condition (R)	Yes	Not applicable	Not saved	Not applicable
.enable (RW)	Yes	Status reset	Not saved	0
.event (R)	Yes	Status reset	Not saved	0
.ntr (RW)	Yes	Status reset	Not saved	0
.ptr (RW)	Yes	Status reset	Not saved	2 (All bits set)

Usage

```

measurementRegister = status.measurement.instrument.condition
measurementRegister = status.measurement.instrument.enable
measurementRegister = status.measurement.instrument.event
measurementRegister = status.measurement.instrument.ntr
measurementRegister = status.measurement.instrument.ptr
status.measurement.instrument.enable = measurementRegister
status.measurement.instrument.ntr = measurementRegister
status.measurement.instrument.ptr = measurementRegister

```

measurementRegister

The status of the measurement event instrument summary register; a zero (0) indicates no bits set (also send 0 to clear all bits); other values indicate various bit settings

Details

These attributes are used to read or write to the measurement event instrument summary registers. Reading a status register returns a value. The binary equivalent of the returned value indicates which register bits are set. The least significant bit of the binary number is bit B0, and the most significant bit is bit B15.

For information about .condition, .enable, .event, .ntr, and .ptr registers, refer to [Status register set contents](#) (on page 15-1) and [Enable and transition registers](#) (on page 15-19). The individual bits of this register are defined in the following table.

Bit	Value and description
B0	Not used
B1	<pre>status.measurement.instrument.SMUA</pre> Set bit indicates one or more enabled bits of the measurement event SMU A summary register is set. Bit B1 decimal value: 2 Binary value: 0000 0010
B2 to B15	Not used

As an example, to set bit B1 of the measurement event instrument summary enable register, set `status.measurement.instrument.enable = status.measurement.instrument.SMUA`.

In addition to the constant, *measurementRegister* can be set to the decimal value of bit B1.

Example 1

```
status.measurement.instrument.enable = status.measurement.instrument.SMUA
```

Uses the constant to set the SMU A bit of the measurement event instrument summary enable register.

Example 2

```
status.measurement.instrument.enable = 2
```

Uses the decimal value to set the SMU A bit of the measurement event instrument summary enable register.

Also see

[Measurement event registers](#) (on page 15-7)

status.measurement.instrument.smua.*

This attribute contains the registers of the measurement event SMU A summary register set.

Type	TSP-Link accessible	Affected by	Where saved	Default value
Attribute	--	--	--	--
.condition (R)	Yes	Not applicable	Not saved	Not applicable
.enable (RW)	Yes	Status reset	Not saved	0
.event (R)	Yes	Status reset	Not saved	0
.ntr (RW)	Yes	Status reset	Not saved	0
.ptr (RW)	Yes	Status reset	Not saved	395 (All bits set)

Usage

```
measurementRegister = status.measurement.instrument.smua.condition
measurementRegister = status.measurement.instrument.smua.enable
measurementRegister = status.measurement.instrument.smua.event
measurementRegister = status.measurement.instrument.smua.ntr
measurementRegister = status.measurement.instrument.smua.ptr
status.measurement.instrument.smua.enable = measurementRegister
status.measurement.instrument.smua.ntr = measurementRegister
status.measurement.instrument.smua.ptr = measurementRegister
```

<i>measurementRegister</i>	The status of the instrument measurement status SMU summary register; a zero (0) indicates no bits set (also send 0 to clear all bits); other values indicate various bit settings
----------------------------	--

Details

These attributes are used to read or write to the measurement event SMU summary registers. Reading a status register returns a value. The binary equivalent of the returned value indicates which register bits are set. The least significant bit of the binary number is bit B0, and the most significant bit is bit B15. For example, assume the value 257 is returned for the enable register. The binary equivalent is 0000 0001 0000 0001. This value indicates that bit B0 (VLMT) and bit B8 (BAV) are set.

B15	B14	B13	B12	B11	B10	B9	B8	B7	B6	B5	B4	B3	B2	B1	B0
**	>	>	>	>	>	>	>	>	>	>	>	>	>	>	*
0	0	0	0	0	0	0	1	0	0	0	0	0	0	0	1

* Least significant bit
 ** Most significant bit

For information about .condition, .enable, .event, .ntr, and .ptr registers, refer to [Status register set contents](#) (on page 15-1) and [Enable and transition registers](#) (on page 15-19). The individual bits of this register are defined in the following table.

Bit	Value and description
B0*	status.measurement.instrument.smua.VOLTAGE_LIMIT status.measurement.instrument.smua.VLMT Set bit indicates that the voltage limit was exceeded. Bit B0 decimal value: 1
B1*	status.measurement.instrument.smua.CURRENT_LIMIT status.measurement.instrument.smua.ILMT Set bit indicates that the current limit was exceeded. Bit B1 decimal value: 2
B2	Not used
B3	status.measurement.instrument.smua.PROTECTION status.measurement.instrument.smua.PROT Set bit indicates that the pulser protection was tripped. Refer to smua.pulser.protect.tripped for events that can trip the protection circuits. Bit B0 decimal value: 8
B4 to B6	Not used
B7	status.measurement.instrument.smua.READING_OVERFLOW status.measurement.instrument.smua.ROF Set bit indicates that an overflow reading has been detected. Bit B7 decimal value: 128
B8	status.measurement.instrument.smua.BUFFER_AVAILABLE status.measurement.instrument.smua.BAV Set bit indicates that there is at least one reading stored in either or both dedicated reading buffers. Bit B8 decimal value: 256
B9 to B15	Not used

* This bit is updated only when a measurement is made or smua.source.compliance is invoked.

As an example, to set bit B0 of the measurement event SMU A summary enable register, set
status.measurement.instrument.smua.enable =
status.measurement.instrument.smua.VLMT.

In addition to the above constants, *measurementRegister* can be set to the decimal equivalent of the bit to set. To set more than one bit of the register, set *measurementRegister* to the sum of their decimal weights. For example, to set bits B1 and B8, set *measurementRegister* to 258 (which is the sum of 2 + 256).

Bit	B7	B6	B5	B4	B3	B2	B1	B0
Binary value	0/1	0/1	0/1	0/1	0/1	0/1	0/1	0/1
Decimal	128	64	32	16	8	4	2	1
Weights	(2 ⁷)	(2 ⁶)	(2 ⁵)	(2 ⁴)	(2 ³)	(2 ²)	(2 ¹)	(2 ⁰)
Bit	B15	B14	B13	B12	B11	B10	B9	B8
Binary value	0/1	0/1	0/1	0/1	0/1	0/1	0/1	0/1
Decimal	32,768	16,384	8,192	4,096	2,048	1,024	512	256
Weights	(2 ¹⁵)	(2 ¹⁴)	(2 ¹³)	(2 ¹²)	(2 ¹¹)	(2 ¹⁰)	(2 ⁹)	(2 ⁸)

Example 1

```
status.measurement.instrument.smua.enable = status.measurement.instrument.smua.VLMT
```

Uses a constant to set the VLMT bit of the measurement event SMU A summary enable register.

Example 2

```
status.measurement.instrument.smua.enable = 1
```

Uses the decimal value to set the VLMT bit of the measurement event SMU A summary enable register.

Also see

- [Measurement event registers](#) (on page 15-7)
- [smua.pulser.protect.tripped](#) (on page 11-218)

status.measurement.protection.*

This attribute contains the registers of the measurement event protection summary register set.

Type	TSP-Link accessible	Affected by	Where saved	Default value
Attribute	--	--	--	--
.condition (R)	Yes	Not applicable	Not saved	Not applicable
.enable (RW)	Yes	Status reset	Not saved	0
.event (R)	Yes	Status reset	Not saved	0
.ntr (RW)	Yes	Status reset	Not saved	0
.ptr (RW)	Yes	Status reset	Not saved	2 (All bits set)

Usage

```
measurementRegister = status.measurement.protection.condition
measurementRegister = status.measurement.protection.enable
measurementRegister = status.measurement.protection.event
measurementRegister = status.measurement.protection.ntr
measurementRegister = status.measurement.protection.ptr
status.measurement.protection.enable = measurementRegister
status.measurement.protection.ntr = measurementRegister
status.measurement.protection.ptr = measurementRegister
```

<i>measurementRegister</i>	The status of the measurement event protection summary register; a zero (0) indicates no bits set (also send 0 to clear all bits); other values indicate various bit settings
----------------------------	---

Details

These attributes are used to read or write to the measurement event protection summary registers. Reading a status register returns a value. The binary equivalent of the returned value indicates which register bits are set. The least significant bit of the binary number is bit B0, and the most significant bit is bit B15.

For information about .condition, .enable, .event, .ntr, and .ptr registers, refer to [Status register set contents](#) (on page 15-1) and [Enable and transition registers](#) (on page 15-19). The individual bits of this register are defined in the following table.

Bit	Value
B0	Not used
B1	<code>status.measurement.protection.SMUA</code> Set bit indicates one of the pulser protection circuits have tripped. Bit B1 decimal value: 2 Binary value: 0000 0010
B2 to B15	Not used

In addition to the above constants, *measurementRegister* can be set to the decimal value of the bit to set.

Example 1

```
status.measurement.protection.enable = status.measurement.protection.SMUA
```

Uses the constant to set bit 1, the SMU A bit of the measurement event protection summary enable register.

Example 2

```
status.measurement.protection.enable = 2
```

Uses the decimal value to set bit 1, the SMU A bit of the measurement event protection summary enable register.

Also see

[Measurement event registers](#) (on page 15-7)

status.measurement.reading_overflow.*

This attribute contains the measurement event reading overflow summary register set.

Type	TSP-Link accessible	Affected by	Where saved	Default value
Attribute	--	--	--	--
.condition (R)	Yes	Not applicable	Not saved	Not applicable
.enable (RW)	Yes	Status reset	Not saved	0
.event (R)	Yes	Status reset	Not saved	0
.ntr (RW)	Yes	Status reset	Not saved	0
.ptr (RW)	Yes	Status reset	Not saved	2 (All bits set)

Usage

```
measurementRegister = status.measurement.reading_overflow.condition
measurementRegister = status.measurement.reading_overflow.enable
measurementRegister = status.measurement.reading_overflow.event
measurementRegister = status.measurement.reading_overflow.ntr
measurementRegister = status.measurement.reading_overflow.ptr
status.measurement.reading_overflow.enable = measurementRegister
status.measurement.reading_overflow.ntr = measurementRegister
status.measurement.reading_overflow.ptr = measurementRegister
```

measurementRegister

The status of the measurement reading overflow summary register; a zero (0) indicates no bits set (also send 0 to clear all bits); other values indicate various bit settings

Details

These attributes are used to read or write to the measurement event reading overflow summary registers. Reading a status register returns a value. The binary equivalent of the returned value indicates which register bits are set. The least significant bit of the binary number is bit B0, and the most significant bit is bit B15. For example, assume the value 2 is returned for the enable register. The binary equivalent is 0000 0000 0000 0010. This value indicates that bit B1 (SMUA) is set.

For information about `.condition`, `.enable`, `.event`, `.ntr`, and `.ptr` registers, refer to [Status register set contents](#) (on page 15-1) and [Enable and transition registers](#) (on page 15-19). The individual bits of this register are defined in the following table.

Bit	Value and description
B0	Not used
B1	<code>status.measurement.reading_overflow.SMUA</code> Set bit indicates that an overflow reading has been detected for SMU A. Bit B1 decimal value: 2 Binary value: 0000 0010
B2 to B15	Not used

In addition to the above constants, `measurementRegister` can be set to the decimal value of the bit to set.

Example 1

```
status.measurement.reading_overflow.enable =
    status.measurement.reading_overflow.SMUA
```

Uses the constant to set bit B1 of the measurement reading overflow summary enable register.

Example 2

```
status.measurement.reading_overflow.enable = 2
```

Uses the decimal value to set bit B1 of the measurement reading overflow summary enable register.

Also see

[Measurement event registers](#) (on page 15-7)

status.measurement.voltage_limit.*

This attribute contains the measurement event voltage limit summary register set.

Type	TSP-Link accessible	Affected by	Where saved	Default value
Attribute	--	--	--	--
.condition (R)	Yes	Not applicable	Not saved	Not applicable
.enable (RW)	Yes	Status reset	Not saved	0
.event (R)	Yes	Status reset	Not saved	0
.ntr (RW)	Yes	Status reset	Not saved	0
.ptr (RW)	Yes	Status reset	Not saved	2 (All bits set)

Usage

```

measurementRegister = status.measurement.voltage_limit.condition
measurementRegister = status.measurement.voltage_limit.enable
measurementRegister = status.measurement.voltage_limit.event
measurementRegister = status.measurement.voltage_limit.ntr
measurementRegister = status.measurement.voltage_limit.ptr
status.measurement.voltage_limit.enable = measurementRegister
status.measurement.voltage_limit.ntr = measurementRegister
status.measurement.voltage_limit.ptr = measurementRegister

```

measurementRegister

The status of the measurement voltage limit summary register; a zero (0) indicates no bits set (also send 0 to clear all bits); other decimal values indicate various bit settings

Details

These attributes read or write to the measurement event voltage limit summary registers. Reading a status register returns a value. The binary equivalent of the returned value indicates which register bits are set. The least significant bit of the binary number is bit B0, and the most significant bit is bit B15.

For information about .condition, .enable, .event, .ntr, and .ptr registers, refer to [Status register set contents](#) (on page 15-1) and [Enable and transition registers](#) (on page 15-19). The individual bits of this register are defined in the following table.

Bit	Value and description
B0	Not used
B1	status.measurement.voltage_limit.SMUA Set bit indicates the enabled VLMT bit for the SMU A measurement register is set. Bit B1 decimal value: 2 Binary value: 0000 0010
B2 to B15	Not used

In addition to the above constants, *measurementRegister* can be set to the decimal value of the bit to set.

Example 1

```

status.measurement.voltage_limit.enable = status.measurement.voltage_limit.SMUA

```

Uses the constant to set the SMUA bit, B1, of the measurement event voltage limit summary enable register.

Example 2

```
status.measurement.voltage_limit.enable = 2
```

Uses the decimal value to set the SMUA bit, B1, of the measurement event voltage limit summary enable register.

Also see

[Measurement event registers](#) (on page 15-7)

status.node_enable

This attribute stores the system node enable register.

Type	TSP-Link accessible	Affected by	Where saved	Default value
Attribute (RW)	Yes	Status reset	Not saved	0

Usage

```
nodeEnableRegister = status.node_enable
status.node_enable = nodeEnableRegister
```

```
nodeEnableRegister
```

The status of the system node enable register; a zero (0) indicates no bits set (also send 0 to clear all bits); other values indicate various bit settings

Details

This attribute is used to read or write to the system node enable register. Reading the system node enable register returns a value. The binary equivalent of the value of this attribute indicates which register bits are set. In the binary equivalent, the least significant bit is bit B0, and the most significant bit is bit B7. For example, if a value of 1.29000e+02 (which is 129) is read as the value of this register, the binary equivalent is 1000 0001. This value indicates that bit B0 and bit B7 are set.

B7	B6	B5	B4	B3	B2	B1	B0
**	>	>	>	>	>	>	*
1	0	0	0	0	0	0	1

- * Least significant bit
- ** Most significant bit

Assigning a value to this attribute enables one or more status events. When an enabled status event occurs, a summary bit is set in the appropriate system summary register. The register and bit that is set depends on the TSP-Link node number assigned to this instrument.

For information about .condition, .enable, .event, .ntr, and .ptr registers, refer to [Status register set contents](#) (on page 15-1) and [Enable and transition registers](#) (on page 15-19). The individual bits of this register are defined in the following table.

Bit	Value and description
B0	status.MEASUREMENT_SUMMARY_BIT status.MSB Set summary bit indicates that an enabled measurement event has occurred. Bit B0 decimal value: 1
B1	Not used
B2	status.ERROR_AVAILABLE status.EAV Set summary bit indicates that an error or status message is present in the error queue. Bit B2 decimal value: 4
B3	status.QUESTIONABLE_SUMMARY_BIT status.QSB Set summary bit indicates that an enabled questionable event has occurred. Bit B3 decimal value: 8
B4	status.MESSAGE_AVAILABLE status.MAV Set summary bit indicates that a response message is present in the output queue. Bit B4 decimal value: 16
B5	status.EVENT_SUMMARY_BIT status.ESB Set summary bit indicates that an enabled standard event has occurred. Bit B5 decimal value: 32
B6	status.MASTER_SUMMARY_STATUS status.MSS Set bit indicates that an enabled Master Summary Status (MSS) bit of the Status Byte Register is set. Bit B6 decimal value: 64
B7	status.OPERATION_SUMMARY_BIT status.OSB Set summary bit indicates that an enabled operation event has occurred. Bit B7 decimal value: 128

As an example, to set the B0 bit of the system node enable register, set
`status.node_enable = status.MSB.`

In addition to the above values, `nodeEnableRegister` can be set to the numeric equivalent of the bit to set. To set more than one bit of the register, set `nodeEnableRegister` to the sum of their decimal weights. For example, to set bits B0 and B7, set `nodeEnableRegister` to 129 (1 + 128).

Bit	B7	B6	B5	B4	B3	B2	B1	B0
Binary value	0/1	0/1	0/1	0/1	0/1	0/1	0/1	0/1
Decimal	128	64	32	16	8	4	2	1
Weights	(2 ⁷)	(2 ⁶)	(2 ⁵)	(2 ⁴)	(2 ³)	(2 ²)	(2 ¹)	(2 ⁰)

Example 1

```
nodeEnableRegister = status.MSB + status.OSB
status.node_enable = nodeEnableRegister
```

Use constants to set the MSB and OSB bits of the system node enable register.

Example 2

```
-- decimal 129 = binary 10000001
nodeEnableRegister = 129
status.node_enable = nodeEnableRegister
```

Sets the MSB and OSB bits of the system node enable register using a decimal value.

Also see

- [status.condition](#) (on page 11-263)
- [status.system.*](#) (on page 11-331)
- [Status byte and service request \(SRQ\)](#) (on page 15-15)

status.node_event

This attribute stores the status node event register.

Type	TSP-Link accessible	Affected by	Where saved	Default value
Attribute (R)	Yes	Not applicable	Not saved	0

Usage

```
nodeEventRegister = status.node_event
```

<i>nodeEventRegister</i>	The status of the node event register; a zero (0) indicates no bits set; other values indicate various bit settings
--------------------------	---

Details

This attribute is used to read the status node event register, which is returned as a numeric value (reading this register returns a value). The binary equivalent of the value of this attribute indicates which register bits are set. In the binary equivalent, the least significant bit is bit B0, and the most significant bit is bit B7. For example, if a value of 1.29000e+02 (which is 129) is read as the value of this register, the binary equivalent is 1000 0001. This value indicates that bit B0 and bit B7 are set.

B7	B6	B5	B4	B3	B2	B1	B0
**	>	>	>	>	>	>	*
1	0	0	0	0	0	0	1

- * Least significant bit
- ** Most significant bit

The returned value can indicate one or more status events occurred.

Bit	Value and description
B0	status.MEASUREMENT_SUMMARY_BIT status.MSB Set summary bit indicates that an enabled measurement event has occurred. Bit B0 decimal value: 1
B1	Not used
B2	status.ERROR_AVAILABLE status.EAV Set summary bit indicates that an error or status message is present in the error queue. Bit B2 decimal value: 4

Bit	Value and description
B3	status.QUESTIONABLE_SUMMARY_BIT status.QSB Set summary bit indicates that an enabled questionable event has occurred. Bit B3 decimal value: 8
B4	status.MESSAGE_AVAILABLE status.MAV Set summary bit indicates that a response message is present in the output queue. Bit B4 decimal value: 16
B5	status.EVENT_SUMMARY_BIT status.ESB Set summary bit indicates that an enabled standard event has occurred. Bit B5 decimal value: 32
B6	status.MASTER_SUMMARY_STATUS status.MSS Set bit indicates that an enabled Master Summary Status (MSS) bit of the Status Byte register is set. Bit B6 decimal value: 64
B7	status.OPERATION_SUMMARY_BIT status.OSB Set summary bit indicates that an enabled operation event has occurred. Bit B7 decimal value: 128

In addition to the above constants, *nodeEventRegister* can be set to the decimal equivalent of the bits set. When more than one bit of the register is set, *nodeEventRegister* contains the sum of their decimal weights. For example, if 129 is returned, bits B0 and B7 are set (1 + 128).

Bit	B7	B6	B5	B4	B3	B2	B1	B0
Binary value	0/1	0/1	0/1	0/1	0/1	0/1	0/1	0/1
Decimal	128	64	32	16	8	4	2	1
Weights	(2 ⁷)	(2 ⁶)	(2 ⁵)	(2 ⁴)	(2 ³)	(2 ²)	(2 ¹)	(2 ⁰)

Example

```
nodeEventRegister = status.node_event
print(nodeEventRegister)
```

Reads the status node event register.

Sample output:

```
1.29000e+02
```

Converting this output (129) to its binary equivalent yields 1000 0001. Therefore, this output indicates that the set bits of the status byte condition register are presently B0 (MSB) and B7 (OSB).

Also see

[Status byte and service request \(SRQ\)](#) (on page 15-15)

[status.condition](#) (on page 11-263)

[status.system.*](#) (on page 11-331)

status.operation.*

These attributes manage the operation status register set of the status model.

Type	TSP-Link accessible	Affected by	Where saved	Default value
Attribute	--	--	--	--
.condition (R)	Yes	Not applicable	Not saved	Not applicable
.enable (RW)	Yes	Status reset	Not saved	0
.event (R)	Yes	Status reset	Not saved	0
.ntr (RW)	Yes	Status reset	Not saved	0
.ptr (RW)	Yes	Status reset	Not saved	31,769 (All bits set)

Usage

```
operationRegister = status.operation.condition
operationRegister = status.operation.enable
operationRegister = status.operation.event
operationRegister = status.operation.ntr
operationRegister = status.operation.ptr
status.operation.enable = operationRegister
status.operation.ntr = operationRegister
status.operation.ptr = operationRegister
```

<i>operationRegister</i>	The status of the operation status register; a zero (0) indicates no bits set (also send 0 to clear all bits); other values indicate various bit settings
--------------------------	---

Details

These attributes read or write the operation status registers.

Reading a status register returns a value. The binary equivalent of the returned value indicates which register bits are set. The least significant bit of the binary number is bit B0, and the most significant bit is bit B15. For example, if a value of 2.04800e+04 (which is 20,480) is read as the value of the condition register, the binary equivalent is 0101 0000 0000 0000. This value indicates that bit B14 (PROGRAM_RUNNING) and bit B12 (USER) are set.

B15	B14	B13	B12	B11	B10	B9	B8	B7	B6	B5	B4	B3	B2	B1	B0
**	>	>	>	>	>	>	>	>	>	>	>	>	>	>	*
0	1	0	1	0	0	0	0	0	0	0	0	0	0	0	0

- * Least significant bit
- ** Most significant bit

For information about .condition, .enable, .event, .ntr, and .ptr registers, refer to [Status register set contents](#) (on page 15-1) and [Enable and transition registers](#) (on page 15-19). The individual bits of this register are defined in the following table.

Bit	Value and description
B0	status.operation.CALIBRATING status.operation.CAL Set bit indicates that the summary bit of the status.operation.calibrating register has been set. Bit B0 decimal value: 1
B1 to B2	Not used

Bit	Value and description
B3	status.operation.SWEEPING status.operation.SWE Set bit indicates that the summary bit from the status.operation.sweeping register is set. Bit B3 decimal value: 8
B4	status.operation.MEASURING status.operation.MEAS Set bit indicates that the summary bit of the status.operation.measuring register is set. Bit B4 decimal value: 16
B5 to B9	Not used
B10	status.operation.TRIGGER_OVERRUN status.operation.TRGOVR Set bit indicates that the summary bit from the status.operation.trigger_overrun register is set. Bit B10 decimal value: 1,024
B11	status.operation.REMOTE_SUMMARY status.operation.REM Set bit indicates that the summary bit of the status.operation.remote register is set. Bit B11 decimal value: 2,048
B12	status.operation.USER Set bit indicates that the summary bit from the status.operation.user register is set. Bit B12 decimal value: 4,096
B13	status.operation.INSTRUMENT_SUMMARY status.operation.INST Set bit indicates that the summary bit from the status.operation.instrument register is set. Bit B13 decimal value: 8,192
B14	status.operation.PROGRAM_RUNNING status.operation.PROG Set bit indicates that a command or program is running. Bit B14 decimal value: 16,384
B15	Not used

As an example, to set bit B12 of the operation status enable register, set
`status.operation.enable = status.operation.USER.`

In addition to the above constants, *operationRegister* can be set to the numeric equivalent of the bit to set. To set more than one bit of the register, set *operationRegister* to the sum of their decimal weights. For example, to set bits B12 and B14, set *operationRegister* to 20,480 (which is the sum of 4,096 + 16,384).

Bit	B7	B6	B5	B4	B3	B2	B1	B0
Binary value	0/1	0/1	0/1	0/1	0/1	0/1	0/1	0/1
Decimal	128	64	32	16	8	4	2	1
Weights	(2 ⁷)	(2 ⁶)	(2 ⁵)	(2 ⁴)	(2 ³)	(2 ²)	(2 ¹)	(2 ⁰)

Bit	B15	B14	B13	B12	B11	B10	B9	B8
Binary value	0/1	0/1	0/1	0/1	0/1	0/1	0/1	0/1
Decimal	32,768	16,384	8,192	4,096	2,048	1,024	512	256
Weights	(2 ¹⁵)	(2 ¹⁴)	(2 ¹³)	(2 ¹²)	(2 ¹¹)	(2 ¹⁰)	(2 ⁹)	(2 ⁸)

Example 1

```
operationRegister = status.operation.USER + status.operation.PROG
status.operation.enable = operationRegister
```

Uses constants to set the USER and PROG bits of the operation status enable register.

Example 2

```
-- decimal 20480 = binary 0101 0000 0000 0000
operationRegister = 20480
status.operation.enable = operationRegister
```

Uses a decimal value to set the USER and PROG bits of the operation status enable register.

Also see

[Operation Status Registers](#) (on page 15-8)

status.operation.calibrating.*

This attribute contains the operation status calibration summary register set.

Type	TSP-Link accessible	Affected by	Where saved	Default value
Attribute	--	--	--	--
.condition (R)	Yes	Not applicable	Not saved	Not applicable
.enable (RW)	Yes	Status reset	Not saved	0
.event (R)	Yes	Status reset	Not saved	0
.ntr (RW)	Yes	Status reset	Not saved	0
.ptr (RW)	Yes	Status reset	Not saved	2 (All bits set)

Usage

```
operationRegister = status.operation.calibrating.condition
operationRegister = status.operation.calibrating.enable
operationRegister = status.operation.calibrating.event
operationRegister = status.operation.calibrating.ntr
operationRegister = status.operation.calibrating.ptr
status.operation.calibrating.enable = operationRegister
status.operation.calibrating.ntr = operationRegister
status.operation.calibrating.ptr = operationRegister
```

<i>operationRegister</i>	The status of the operation calibrating event register; a zero (0) indicates no bits set (also send 0 to clear all bits); other values indicate various bit settings
--------------------------	--

Details

These attributes are used to read or write to the operation status calibration summary registers. Reading a status register returns a value. The binary equivalent of the returned value indicates which register bits are set. The least significant bit of the binary number is bit B0, and the most significant bit is bit B15.

For information about .condition, .enable, .event, .ntr, and .ptr registers, refer to [Status register set contents](#) (on page 15-1) and [Enable and transition registers](#) (on page 15-19). The individual bits of this register are defined in the following table.

Bit	Value and description
B0	Not used
B1	status.operation.calibrating.SMUA Set bit indicates that SMU A is unlocked for calibration. Bit B1 decimal value: 2 Binary value: 0000 0010
B2 to B15	Not used

Example 1

```
status.operation.calibrating.enable = status.operation.calibrating.SMUA
```

Sets the SMUA bit, B1, of the operation status calibration summary enable register using a constant.

Example 2

```
status.operation.calibrating.enable = 2
```

Sets the SMUA bit, B1, of the operation status calibration summary enable register using a decimal value.

Also see

[Operation Status Registers](#) (on page 15-8)
[status.operation.*](#) (on page 11-281)

status.operation.instrument.*

This attribute contains the operation status instrument summary register set.

Type	TSP-Link accessible	Affected by	Where saved	Default value
Attribute	--	--	--	--
.condition (R)	Yes	Not applicable	Not saved	Not applicable
.enable (RW)	Yes	Status reset	Not saved	0
.event (R)	Yes	Status reset	Not saved	0
.ntr (RW)	Yes	Status reset	Not saved	0
.ptr (RW)	Yes	Status reset	Not saved	31,746 (All bits set)

Usage

```
operationRegister = status.operation.instrument.condition
operationRegister = status.operation.instrument.enable
operationRegister = status.operation.instrument.event
operationRegister = status.operation.instrument.ntr
operationRegister = status.operation.instrument.ptr
status.operation.instrument.enable = operationRegister
status.operation.instrument.ntr = operationRegister
status.operation.instrument.ptr = operationRegister
```

<i>operationRegister</i>	The status of the operation event register; a zero (0) indicates no bits set (also send 0 to clear all bits); other values indicate various bit settings
--------------------------	--

Details

These attributes are used to read or write to the operation status instrument summary registers. Reading a status register returns a value. The binary equivalent of the returned value indicates which register bits are set. The least significant bit of the binary number is bit B0, and the most significant bit is bit B15. For example, if a value of 1.02600e+03 (which is 1,026) is read as the value of the condition register, the binary equivalent is 0000 0100 0000 0010. This value indicates that bit B1 and bit B10 are set.

B15	B14	B13	B12	B11	B10	B9	B8	B7	B6	B5	B4	B3	B2	B1	B0
**	>	>	>	>	>	>	>	>	>	>	>	>	>	>	*
0	0	0	0	0	1	0	0	0	0	0	0	0	0	1	0

* Least significant bit

** Most significant bit

For information about .condition, .enable, .event, .ntr, and .ptr registers, refer to [Status register set contents](#) (on page 15-1) and [Enable and transition registers](#) (on page 15-19). The individual bits of this register are defined in the following table.

Bit	Value and description
B0	Not used
B1	status.operation.instrument.SMUA Set bit indicates one or more enabled bits for the operation status SMU A summary register is set. Bit B1 decimal value: 2
B2 to B9	Not used
B10	status.operation.instrument.TRIGGER_BLENDER status.operation.instrument.TRGBLND Set bit indicates one or more enabled bits for the operation status trigger blender summary register is set. Bit B10 decimal value: 1,024.
B11	status.operation.instrument.TRIGGER_TIMER status.operation.instrument.TRGTMR Set bit indicates one or more enabled bits for the operation status trigger timer summary register is set. Bit B11 decimal value: 2,048
B12	status.operation.instrument.DIGITAL_IO status.operation.instrument.DIGIO Set bit indicates one or more enabled bits for the operation status digital I/O summary register is set. Bit B12 decimal value: 4,096
B13	status.operation.instrument.TSPLINK Set bit indicates one or more enabled bits for the operation status TSP-Link summary register is set. Bit B13 decimal value: 8,192
B14	status.operation.instrument.LAN Set bit indicates one or more enabled bits for the operation status LAN summary register is set. Bit B14 decimal value: 16,384
B15	Not used

As an example, to set bit B1 of the operation status instrument summary enable register, set `status.operation.instrument.enable = status.operation.instrument.SMUA`.

In addition to the above constants, *operationRegister* can be set to the decimal value of the bit to set. To set more than one bit of the register, set *operationRegister* to the sum of their decimal values. For example, to set bits B1 and B10, set *operationRegister* to 1,026 (which is the sum of 2 + 1,024).

Bit	B7	B6	B5	B4	B3	B2	B1	B0
Binary value	0/1	0/1	0/1	0/1	0/1	0/1	0/1	0/1
Decimal	128	64	32	16	8	4	2	1
Weights	(2 ⁷)	(2 ⁶)	(2 ⁵)	(2 ⁴)	(2 ³)	(2 ²)	(2 ¹)	(2 ⁰)

Bit	B15	B14	B13	B12	B11	B10	B9	B8
Binary value	0/1	0/1	0/1	0/1	0/1	0/1	0/1	0/1
Decimal	32,768	16,384	8,192	4,096	2,048	1,024	512	256
Weights	(2 ¹⁵)	(2 ¹⁴)	(2 ¹³)	(2 ¹²)	(2 ¹¹)	(2 ¹⁰)	(2 ⁹)	(2 ⁸)

Example 1

```
operationRegister = status.operation.instrument.SMUA +
    status.operation.instrument.TRGBLND
status.operation.instrument.enable = operationRegister
```

Use constants to set bit B1 and bit B10 of the operation status instrument summary enable register.

Example 2

```
-- 1026 = binary 0000 0100 0000 0010
operationRegister = 1026
status.operation.instrument.enable = operationRegister
```

Uses a decimal value to set bit B1 and bit B10 of the operation status instrument summary enable register.

Also see

[Operation Status Registers](#) (on page 15-8)

[status.operation.*](#) (on page 11-281)

Condition register sets of:

- [status.operation.instrument.digio.*](#) (on page 11-286)
- [status.operation.instrument.lan.*](#) (on page 11-290)
- [status.operation.instrument.trigger_blender.*](#) (on page 11-298)
- [status.operation.instrument.trigger_timer.*](#) (on page 11-301)
- [status.operation.instrument.tsplink.*](#) (on page 11-304)

status.operation.instrument.digio.*

This attribute contains the operation status digital I/O summary register set.

Type	TSP-Link accessible	Affected by	Where saved	Default value
Attribute	--	--	--	--
.condition (R)	Yes	Not applicable	Not saved	Not applicable
.enable (RW)	Yes	Status reset	Not saved	0
.event (R)	Yes	Status reset	Not saved	0
.ntr (RW)	Yes	Status reset	Not saved	0
.ptr (RW)	Yes	Status reset	Not saved	1024 (All bits set)

Usage

```
operationRegister = status.operation.instrument.digio.condition
operationRegister = status.operation.instrument.digio.enable
operationRegister = status.operation.instrument.digio.event
operationRegister = status.operation.instrument.digio.ntr
operationRegister = status.operation.instrument.digio.ptr
status.operation.instrument.digio.enable = operationRegister
status.operation.instrument.digio.ntr = operationRegister
status.operation.instrument.digio.ptr = operationRegister
```

<i>operationRegister</i>	The status of the operation status digital I/O summary register; a zero (0) indicates no bits set (also send 0 to clear all bits); the only valid value other than 0 is 1024
--------------------------	--

Details

These attributes are used to read or write to the operation status digital I/O summary registers. Reading a status register returns a value. The binary equivalent of the returned value indicates which register bits are set. The least significant bit of the binary number is bit B0, and the most significant bit is bit B15.

For information about .condition, .enable, .event, .ntr, and .ptr registers, refer to [Status register set contents](#) (on page 15-1) and [Enable and transition registers](#) (on page 15-19). The individual bits of this register are defined in the following table.

Bit	Value and description
B0 to B9	Not used
B10	status.operation.instrument.digio.TRIGGER_OVERRUN status.operation.instrument.digio.TRGOVR Set bit indicates an enabled bit in the Operation Status Digital I/O Overrun Register is set. Bit B10 decimal value: 1,024 Binary value: 0100 0000 0010
B11 to B15	Not used

In addition to the above constant, *operationRegister* can be set to the decimal value of the bit to set.

Example 1

```
status.operation.instrument.digio.enable = status.operation.instrument.digio.TRGOVR
```

Uses a constant to set the TRGOVR bit of the operation status digital I/O summary enable register.

Example 2

```
status.operation.instrument.digio.enable = 1024
```

Uses the decimal value to set the TRGOVR bit of the operation status digital I/O summary enable register.

Also see

- [Operation Status Registers](#) (on page 15-8)
- [status.operation.instrument.digio.trigger_overrun.*](#) (on page 11-288)

status.operation.instrument.digio.trigger_overnun.*

This attribute contains the operation status digital I/O overrun register set.

Type	TSP-Link accessible	Affected by	Where saved	Default value
Attribute	--	--	--	--
.condition (R)	Yes	Not applicable	Not saved	Not applicable
.enable (RW)	Yes	Status reset	Not saved	0
.event (R)	Yes	Status reset	Not saved	0
.ntr (RW)	Yes	Status reset	Not saved	0
.ptr (RW)	Yes	Status reset	Not saved	32,766 (All bits set)

Usage

```
operationRegister = status.operation.instrument.digio.trigger_overnun.condition
operationRegister = status.operation.instrument.digio.trigger_overnun.enable
operationRegister = status.operation.instrument.digio.trigger_overnun.event
operationRegister = status.operation.instrument.digio.trigger_overnun.ntr
operationRegister = status.operation.instrument.digio.trigger_overnun.ptr
status.operation.instrument.digio.trigger_overnun.enable = operationRegister
status.operation.instrument.digio.trigger_overnun.ntr = operationRegister
status.operation.instrument.digio.trigger_overnun.ptr = operationRegister
```

operationRegister

The status of the operation status digio I/O overrun register; a zero (0) indicates no bits set (also send 0 to clear all bits); other values indicate various bit settings

Details

These attributes are used to read or write to the operation status digital I/O overrun registers. Reading a status register returns a value. The binary equivalent of the returned value indicates which register bits are set. The least significant bit of the binary number is bit B0, and the most significant bit is bit B15. For example, if a value of $1.02600e+03$ (which is 1026) is read as the value of the condition register, the binary equivalent is 0000 0100 0000 0010. This value indicates that bit B1 and bit B10 are set.

B15	B14	B13	B12	B11	B10	B9	B8	B7	B6	B5	B4	B3	B2	B1	B0
**	>	>	>	>	>	>	>	>	>	>	>	>	>	>	*
0	0	0	0	0	1	0	0	0	0	0	0	0	0	1	0

* Least significant bit

** Most significant bit

A set bit indicates that the specified digital I/O line generated an action overrun when it was triggered to generate an output trigger.

For information about .condition, .enable, .event, .ntr, and .ptr registers, refer to [Status register set contents](#) (on page 15-1) and [Enable and transition registers](#) (on page 15-19). The individual bits of this register are defined in the following table.

Bit	Value	Decimal value
B0	Not used	Not applicable
B1	status.operation.instrument.digio.trigger_overnun.LINE1	2

Bit	Value	Decimal value
B2	status.operation.instrument.digio.trigger_overnun.LINE2	4
B3	status.operation.instrument.digio.trigger_overnun.LINE3	8
B4	status.operation.instrument.digio.trigger_overnun.LINE4	16
B5	status.operation.instrument.digio.trigger_overnun.LINE5	32
B6	status.operation.instrument.digio.trigger_overnun.LINE6	64
B7	status.operation.instrument.digio.trigger_overnun.LINE7	128
B8	status.operation.instrument.digio.trigger_overnun.LINE8	256
B9	status.operation.instrument.digio.trigger_overnun.LINE9	512
B10	status.operation.instrument.digio.trigger_overnun.LINE10	1,024
B11	status.operation.instrument.digio.trigger_overnun.LINE11	2,048
B12	status.operation.instrument.digio.trigger_overnun.LINE12	4,096
B13	status.operation.instrument.digio.trigger_overnun.LINE13	8,192
B14	status.operation.instrument.digio.trigger_overnun.LINE14	16,384
B15	Not used	Not applicable

As an example, to set bit B1 of the operation status digital I/O overrun enable register, set `status.operation.instrument.digio.trigger_overnun.enable = status.operation.instrument.digio.trigger_overnun.LINE1`.

In addition to the above constants, `operationRegister` can be set to the numeric equivalent of the bit to set. To set more than one bit of the register, set `operationRegister` to the sum of their decimal values. For example, to set bits B1 and B10, set `operationRegister` to 1,026 (which is the sum of 2 + 1,024).

Bit	B7	B6	B5	B4	B3	B2	B1	B0
Binary value	0/1	0/1	0/1	0/1	0/1	0/1	0/1	0/1
Decimal	128	64	32	16	8	4	2	1
Weights	(2 ⁷)	(2 ⁶)	(2 ⁵)	(2 ⁴)	(2 ³)	(2 ²)	(2 ¹)	(2 ⁰)

Bit	B15	B14	B13	B12	B11	B10	B9	B8
Binary value	0/1	0/1	0/1	0/1	0/1	0/1	0/1	0/1
Decimal	32,768	16,384	8,192	4,096	2,048	1,024	512	256
Weights	(2 ¹⁵)	(2 ¹⁴)	(2 ¹³)	(2 ¹²)	(2 ¹¹)	(2 ¹⁰)	(2 ⁹)	(2 ⁸)

Example 1

```
operationRegister = status.operation.instrument.digio.trigger_overnun.LINE1 +
status.operation.instrument.digio.trigger_overnun.LINE10
status.operation.instrument.digio.trigger_overnun.enable = operationRegister
```

Uses constants to set bit B1 and bit B10 of the operation status digital I/O overrun enable register.

Example 2

```
operationRegister = 1026
status.operation.instrument.digio.trigger_overnun.enable = operationRegister
```

Uses the decimal value to set bit B1 and bit B10 of the operation status digital I/O overrun enable register.

Also see

[Operation Status Registers](#) (on page 15-8)
[status.operation.instrument.digio.*](#) (on page 11-286)

status.operation.instrument.lan.*

This attribute contains the operation status LAN summary register set.

Type	TSP-Link accessible	Affected by	Where saved	Default value
Attribute	--	--	--	--
.condition (R)	Yes	Not applicable	Not saved	Not applicable
.enable (RW)	Yes	Status reset	Not saved	0
.event (R)	Yes	Status reset	Not saved	0
.ntr (RW)	Yes	Status reset	Not saved	0
.ptr (RW)	Yes	Status reset	Not saved	1027 (All bits set)

Usage

```
operationRegister = status.operation.instrument.lan.condition
operationRegister = status.operation.instrument.lan.enable
operationRegister = status.operation.instrument.lan.event
operationRegister = status.operation.instrument.lan.ntr
operationRegister = status.operation.instrument.lan.ptr
status.operation.instrument.lan.enable = operationRegister
status.operation.instrument.lan.ntr = operationRegister
status.operation.instrument.lan.ptr = operationRegister
```

<i>operationRegister</i>	The status of the operation status LAN summary register; a zero (0) indicates no bits set (also send 0 to clear all bits); other values indicate various bit settings
--------------------------	---

Details

These attributes are used to read or write to the operation status LAN summary registers. The binary equivalent of the value indicates which register bits are set. In the binary equivalent, the least significant bit is bit B0, and the most significant bit is bit B15. For example, if a value of 1.02600e+03 (which is 1026) is read as the value of the condition register, the binary equivalent is 0000 0100 0000 0010. This value indicates that bit B1 and bit B10 are set.

B15	B14	B13	B12	B11	B10	B9	B8	B7	B6	B5	B4	B3	B2	B1	B0
**	>	>	>	>	>	>	>	>	>	>	>	>	>	>	*
0	0	0	0	0	1	0	0	0	0	0	0	0	0	1	0

* Least significant bit
 ** Most significant bit

For information about .condition, .enable, .event, .ntr, and .ptr registers, refer to [Status register set contents](#) (on page 15-1) and [Enable and transition registers](#) (on page 15-19). The individual bits of this register are defined in the following table.

Bit	Value and description
B0	status.operation.instrument.lan.CONNECTION status.operation.instrument.lan.CON Set bit indicates that the LAN cable is connected and a link has been detected. Bit B0 decimal value: 1
B1	status.operation.instrument.lan.CONFIGURING status.operation.instrument.lan.CONF Set bit indicates the LAN is performing its configuration sequence. Bit B1 decimal value: 2
B2 to B9	Not used
B10	status.operation.instrument.lan.TRIGGER_OVERRUN status.operation.instrument.lan.TRGOVR Set bit indicates one or more enabled bits for the operation status LAN trigger overrun register is set. Bit B10 decimal value: 1,024
B11 to B15	Not used

As an example, to set bit B0 of the operation status LAN summary enable register, send:

```
status.operation.instrument.lan.enable = status.operation.instrument.lan.CON
```

In addition to the above constants, *operationRegister* can be set to the numeric equivalent of the bit to set. To set more than one bit of the register, set *operationRegister* to the sum of their decimal weights. For example, to set bits B1 and B10, set *operationRegister* to 1,026 (which is the sum of 2 + 1024).

Bit	B7	B6	B5	B4	B3	B2	B1	B0
Binary value	0/1	0/1	0/1	0/1	0/1	0/1	0/1	0/1
Decimal	128	64	32	16	8	4	2	1
Weights	(2 ⁷)	(2 ⁶)	(2 ⁵)	(2 ⁴)	(2 ³)	(2 ²)	(2 ¹)	(2 ⁰)

Bit	B15	B14	B13	B12	B11	B10	B9	B8
Binary value	0/1	0/1	0/1	0/1	0/1	0/1	0/1	0/1
Decimal	32,768	16,384	8,192	4,096	2,048	1,024	512	256
Weights	(2 ¹⁵)	(2 ¹⁴)	(2 ¹³)	(2 ¹²)	(2 ¹¹)	(2 ¹⁰)	(2 ⁹)	(2 ⁸)

Example 1

```
operationRegister = status.operation.instrument.lan.CONF +
status.operation.instrument.lan.TRGOVR
status.operation.instrument.lan.enable = operationRegister
Use constants to set bit B1 and bit B10 of the operation status LAN summary enable register.
```

Example 2

```
operationRegister = 1026
status.operation.instrument.lan.enable = operationRegister
Use the decimal value to set bit B1 and bit B10 of the operation status LAN summary enable register.
```

Also see

- [Operation Status Registers](#) (on page 15-8)
- [status.operation.instrument.lan.trigger_overrun.*](#) (on page 11-292)

status.operation.instrument.lan.trigger_overnrun.*

This attribute contains the operation status LAN trigger overrun register set.

Type	TSP-Link accessible	Affected by	Where saved	Default value
Attribute	--	--	--	--
.condition (R)	Yes	Not applicable	Not saved	Not applicable
.enable (RW)	Yes	Status reset	Not saved	0
.event (R)	Yes	Status reset	Not saved	0
.ntr (RW)	Yes	Status reset	Not saved	0
.ptr (RW)	Yes	Status reset	Not saved	510 (All bits set)

Usage

```
operationRegister = status.operation.instrument.lan.trigger_overnrun.condition
operationRegister = status.operation.instrument.lan.trigger_overnrun.enable
operationRegister = status.operation.instrument.lan.trigger_overnrun.event
operationRegister = status.operation.instrument.lan.trigger_overnrun.ntr
operationRegister = status.operation.instrument.lan.trigger_overnrun.ptr
status.operation.instrument.lan.trigger_overnrun.enable = operationRegister
status.operation.instrument.lan.trigger_overnrun.ntr = operationRegister
status.operation.instrument.lan.trigger_overnrun.ptr = operationRegister
```

<i>operationRegister</i>	The status of the operation status LAN trigger overrun register; a zero (0) indicates no bits set (also send 0 to clear all bits); other values indicate various bit settings
--------------------------	---

Details

These attributes are used to read or write to the operation status LAN trigger overrun registers. Reading a status register returns a value. The binary equivalent of the returned value indicates which register bits are set. The least significant bit of the binary number is bit B0, and the most significant bit is bit B15. For example, if a value of 2.58000e+02 (which is 258) is read as the value of the condition register, the binary equivalent is 0000 0001 0000 0010. This value indicates that bit B1 and bit B8 are set.

B15	B14	B13	B12	B11	B10	B9	B8	B7	B6	B5	B4	B3	B2	B1	B0
**	>	>	>	>	>	>	>	>	>	>	>	>	>	>	*
0	0	0	0	0	0	0	1	0	0	0	0	0	0	1	0

* Least significant bit

** Most significant bit

A set bit indicates that the specified LAN trigger generated an action overrun when triggered to generate a trigger packet.

For information about .condition, .enable, .event, .ntr, and .ptr registers, refer to [Status register set contents](#) (on page 15-1) and [Enable and transition registers](#) (on page 15-19). The individual bits of this register are defined in the following table.

Bit	Value	Decimal value
B0	Not used	Not applicable
B1	status.operation.instrument.lan.trigger_overnrun.LAN1	2

Bit	Value	Decimal value
B2	status.operation.instrument.lan.trigger_overnun.LAN2	4
B3	status.operation.instrument.lan.trigger_overnun.LAN3	8
B4	status.operation.instrument.lan.trigger_overnun.LAN4	16
B5	status.operation.instrument.lan.trigger_overnun.LAN5	32
B6	status.operation.instrument.lan.trigger_overnun.LAN6	64
B7	status.operation.instrument.lan.trigger_overnun.LAN7	128
B8	status.operation.instrument.lan.trigger_overnun.LAN8	256
B9 to B15	Not used	Not applicable

As an example, to set bit B1 of the operation status LAN trigger overrun enable register, set `status.operation.instrument.lan.trigger_overnun.enable = status.operation.instrument.lan.trigger_overnun.LAN1`.

In addition to the above constants, *operationRegister* can be set to the numeric equivalent of the bit to set. To set more than one bit of the register, set *operationRegister* to the sum of their decimal weights. For example, to set bits B1 and B8, set *operationRegister* to 258 (which is the sum of 2 + 256).

Bit	B7	B6	B5	B4	B3	B2	B1	B0
Binary value	0/1	0/1	0/1	0/1	0/1	0/1	0/1	0/1
Decimal	128	64	32	16	8	4	2	1
Weights	(2 ⁷)	(2 ⁶)	(2 ⁵)	(2 ⁴)	(2 ³)	(2 ²)	(2 ¹)	(2 ⁰)

Bit	B15	B14	B13	B12	B11	B10	B9	B8
Binary value	0/1	0/1	0/1	0/1	0/1	0/1	0/1	0/1
Decimal	32,768	16,384	8,192	4,096	2,048	1,024	512	256
Weights	(2 ¹⁵)	(2 ¹⁴)	(2 ¹³)	(2 ¹²)	(2 ¹¹)	(2 ¹⁰)	(2 ⁹)	(2 ⁸)

Example 1

```
operationRegister = status.operation.instrument.lan.trigger_overnun.LAN1 +
status.operation.instrument.lan.trigger_overnun.LAN8
status.operation.instrument.lan.trigger_overnun.enable = operationRegister
Use constants to set bit B1 and bit B8 of the operation status LAN trigger overrun enable register.
```

Example 2

```
operationRegister = 258
status.operation.instrument.lan.trigger_overnun.enable = operationRegister
Use the decimal value to set bit B1 and bit B8 of the operation status LAN trigger overrun enable register.
```

Also see

- [Operation Status Registers](#) (on page 15-8)
- [status.operation.instrument.lan.*](#) (on page 11-290)

status.operation.instrument.smua.*

This attribute contains the operation status SMU summary register set.

Type	TSP-Link accessible	Affected by	Where saved	Default value
Attribute	--	--	--	--
.condition (R)	Yes	Not applicable	Not saved	Not applicable
.enable (RW)	Yes	Status reset	Not saved	0
.event (R)	Yes	Status reset	Not saved	0
.ntr (RW)	Yes	Status reset	Not saved	0
.ptr (RW)	Yes	Status reset	Not saved	1049 (All bits set)

Usage

```

operationRegister = status.operation.instrument.smua.condition
operationRegister = status.operation.instrument.smua.enable
operationRegister = status.operation.instrument.smua.event
operationRegister = status.operation.instrument.smua.ntr
operationRegister = status.operation.instrument.smua.ptr
status.operation.instrument.smua.enable = operationRegister
status.operation.instrument.smua.ntr = operationRegister
status.operation.instrument.smua.ptr = operationRegister

```

<i>operationRegister</i>	The status of the operation status SMU summary register; a zero (0) indicates no bits set (also send 0 to clear all bits); other values indicate various bit settings
--------------------------	---

Details

These attributes are used to read or write to the operation status SMU summary registers. Reading a status register returns a value. The binary equivalent of the returned value indicates which register bits are set. The least significant bit of the binary number is bit B0, and the most significant bit is bit B15. The binary equivalent of the value indicates which register bits are set. In the binary equivalent, the least significant bit is bit B0, and the most significant bit is bit B15. For example, if a value of 1.02500e+02 (which is 1,025) is read as the value of the condition register, the binary equivalent is 0000 0100 0000 0010. This value indicates that bit B0 and bit B10 are set.

B15	B14	B13	B12	B11	B10	B9	B8	B7	B6	B5	B4	B3	B2	B1	B0
**	>	>	>	>	>	>	>	>	>	>	>	>	>	>	*
0	0	0	0	0	1	0	0	0	0	0	0	0	0	1	0

* Least significant bit

** Most significant bit

For information about .condition, .enable, .event, .ntr, and .ptr registers, refer to [Status register set contents](#) (on page 15-1) and [Enable and transition registers](#) (on page 15-19). The individual bits of this register are defined in the following table.

Bit	Value and description
B0	status.operation.instrument.smua.CALIBRATING status.operation.instrument.smua.CAL Set bit indicates that smua is unlocked for calibration. Bit B0 decimal value: 1
B1 to B2	Not used

Bit	Value and description
B3	<code>status.operation.instrument.smua.SWEEPING</code> <code>status.operation.instrument.smua.SWE</code> Set bit indicates that <code>smua</code> is sweeping. Bit B3 decimal value: 8
B4	<code>status.operation.instrument.smua.MEASURING</code> <code>status.operation.instrument.smua.MEAS</code> Bit is set when making an overlapped measurement, but it will not set when taking a normal synchronous measurement. Bit B4 decimal value: 16
B5 to B9	Not used
B10	<code>status.operation.instrument.smua.TRIGGER_OVERRUN</code> <code>status.operation.instrument.smua.TRGOVR</code> Set bit indicates an enabled bit has been set in the operation status <code>smua</code> trigger overrun event register. Bit B10 decimal value: 1,024
B11 to B15	Not used

As an example, to set bit B0 of the operation status SMU A summary enable register, set `status.operation.instrument.smua.enable = status.operation.instrument.smua.CAL`.

In addition to the above constants, `operationRegister` can be set to the numeric equivalent of the bit to set. To set more than one bit of the register, set `operationRegister` to the sum of their decimal weights. For example, to set bits B0 and B10, set `operationRegister` to 1,025 (which is the sum of 1 + 1,024).

Bit	B7	B6	B5	B4	B3	B2	B1	B0
Binary value	0/1	0/1	0/1	0/1	0/1	0/1	0/1	0/1
Decimal	128	64	32	16	8	4	2	1
Weights	(2 ⁷)	(2 ⁶)	(2 ⁵)	(2 ⁴)	(2 ³)	(2 ²)	(2 ¹)	(2 ⁰)

Bit	B15	B14	B13	B12	B11	B10	B9	B8
Binary value	0/1	0/1	0/1	0/1	0/1	0/1	0/1	0/1
Decimal	32,768	16,384	8,192	4,096	2,048	1,024	512	256
Weights	(2 ¹⁵)	(2 ¹⁴)	(2 ¹³)	(2 ¹²)	(2 ¹¹)	(2 ¹⁰)	(2 ⁹)	(2 ⁸)

Example 1

```
status.operation.instrument.smua.enable = status.operation.instrument.smua.MEAS
```

Use a constant to set bit B4t of the operation status SMU A summary enable register.

Example 2

```
status.operation.instrument.smua.enable = 1025
```

Use the decimal value to set bits B0 and B10 of the operation status SMU A summary enable register.

Also see

- [Operation Status Registers](#) (on page 15-8)
- [status.operation.instrument.smua.trigger_overrrun.*](#) (on page 11-296)

status.operation.instrument.smua.trigger_overnrun.*

This attribute contains the operation status SMU trigger overrun register set.

Type	TSP-Link accessible	Affected by	Where saved	Default value
Attribute	--	--	--	--
.condition (R)	Yes	Not applicable	Not saved	Not applicable
.enable (RW)	Yes	Status reset	Not saved	0
.event (R)	Yes	Status reset	Not saved	0
.ntr (RW)	Yes	Status reset	Not saved	0
.ptr (RW)	Yes	Status reset	Not saved	30 (All bits set)

Usage

```
operationRegister = status.operation.instrument.smua.trigger_overnrun.condition
operationRegister = status.operation.instrument.smua.trigger_overnrun.enable
operationRegister = status.operation.instrument.smua.trigger_overnrun.event
operationRegister = status.operation.instrument.smua.trigger_overnrun.ntr
operationRegister = status.operation.instrument.smua.trigger_overnrun.ptr
status.operation.instrument.smua.trigger_overnrun.enable = operationRegister
status.operation.instrument.smua.trigger_overnrun.ntr = operationRegister
status.operation.instrument.smua.trigger_overnrun.ptr = operationRegister
```

<i>operationRegister</i>	The status of the operation status SMU trigger overrun register; a zero (0) indicates no bits set (also send 0 to clear all bits); other values indicate various bit settings
--------------------------	---

Details

These attributes are used to read or write to the operation status SMU trigger overrun registers. Reading a status register returns a value. The binary equivalent of the returned value indicates which register bits are set. The least significant bit of the binary number is bit B0, and the most significant bit is bit B15. For example, if a value of 18 is read as the value of the condition register, the binary equivalent is 0000 0000 0001 0010. This value indicates that bit B1 and bit B4 are set.

B15	B14	B13	B12	B11	B10	B9	B8	B7	B6	B5	B4	B3	B2	B1	B0
**	>	>	>	>	>	>	>	>	>	>	>	>	>	>	*
0	0	0	0	0	0	0	0	0	0	0	1	0	0	1	0

* Least significant bit

** Most significant bit

For information about .condition, .enable, .event, .ntr, and .ptr registers, refer to [Status register set contents](#) (on page 15-1) and [Enable and transition registers](#) (on page 15-19). The individual bits of this register are defined in the following table.

Bit	Value and description
B0	Not used
B1	status.operation.instrument.smua.trigger_overnrun.ARM Set bit indicates that the arm event detector of the SMU was already in the detected state when a trigger was received. Bit B1 decimal value: 2
B2	status.operation.instrument.smua.trigger_overnrun.SRC Set bit indicates that the source event detector of the SMU was already in the detected state when a trigger was received. Bit B2 decimal value: 4

Bit	Value and description
B3	<code>status.operation.instrument.smua.trigger_overrun.MEAS</code> Set bit indicates that the measurement event detector of the SMU was already in the detected state when a trigger was received. Bit B3 decimal value: 8
B4	<code>status.operation.instrument.smua.trigger_overrun.ENDP</code> Set bit indicates that the end pulse event detector of the SMU was already in the detected state when a trigger was received. Bit B4 decimal value: 16
B5 to B15	Not used

As an example, to set bit B1 of the operation status SMU A trigger overrun enable register, set `status.operation.instrument.smua.trigger_overrun.enable = status.operation.instrument.smua.trigger_overrun.ARM`.

In addition to the above constants, `operationRegister` can be set to the numeric equivalent of the bit to set. To set more than one bit of the register, set `operationRegister` to the sum of their decimal weights. For example, to set bits B1 and B4, set `operationRegister` to 18 (which is the sum of 2 + 16).

Bit	B7	B6	B5	B4	B3	B2	B1	B0
Binary value	0/1	0/1	0/1	0/1	0/1	0/1	0/1	0/1
Decimal	128	64	32	16	8	4	2	1
Weights	(2 ⁷)	(2 ⁶)	(2 ⁵)	(2 ⁴)	(2 ³)	(2 ²)	(2 ¹)	(2 ⁰)

Bit	B15	B14	B13	B12	B11	B10	B9	B8
Binary value	0/1	0/1	0/1	0/1	0/1	0/1	0/1	0/1
Decimal	32,768	16,384	8,192	4,096	2,048	1,024	512	256
Weights	(2 ¹⁵)	(2 ¹⁴)	(2 ¹³)	(2 ¹²)	(2 ¹¹)	(2 ¹⁰)	(2 ⁹)	(2 ⁸)

Example 1

```
status.operation.instrument.smua.trigger_overrun.enable =
status.operation.instrument.smua.trigger_overrun.ARM
```

Uses a constant to sets the ARM bit of the operation status SMU A trigger overrun enable register.

Example 2

```
status.operation.instrument.smua.trigger_overrun.enable = 18
```

Uses the decimal value to set bits B1 and B4 of the operation status SMU A trigger overrun enable register.

Also see

- [Operation Status Registers](#) (on page 15-8)
- [status.operation.instrument.smua.*](#) (on page 11-294)

status.operation.instrument.trigger_blender.*

This attribute contains the operation status trigger blender summary register set.

Type	TSP-Link accessible	Affected by	Where saved	Default value
Attribute	--	--	--	--
.condition (R)	Yes	Not applicable	Not saved	Not applicable
.enable (RW)	Yes	Status reset	Not saved	0
.event (R)	Yes	Status reset	Not saved	0
.ntr (RW)	Yes	Status reset	Not saved	0
.ptr (RW)	Yes	Status reset	Not saved	1024 (All bits set)

Usage

```
operationRegister = status.operation.instrument.trigger_blender.condition
operationRegister = status.operation.instrument.trigger_blender.enable
operationRegister = status.operation.instrument.trigger_blender.event
operationRegister = status.operation.instrument.trigger_blender.ntr
operationRegister = status.operation.instrument.trigger_blender.ptr
status.operation.instrument.trigger_blender.enable = operationRegister
status.operation.instrument.trigger_blender.ntr = operationRegister
status.operation.instrument.trigger_blender.ptr = operationRegister
```

operationRegister

The status of the operation status trigger blender summary register; a zero (0) indicates no bits set (also send 0 to clear all bits); the only valid value other than 0 is 1024

Details

These attributes are used to read or write to the operation status trigger blender summary registers. Reading a status register returns a value. The binary equivalent of the returned value indicates which register bits are set. The least significant bit of the binary number is bit B0, and the most significant bit is bit B15.

For information about .condition, .enable, .event, .ntr, and .ptr registers, refer to [Status register set contents](#) (on page 15-1) and [Enable and transition registers](#) (on page 15-19). The individual bits of this register are defined in the following table.

Bit	Value and description
B0 to B9	Not used
B10	status.operation.instrument.trigger_blender.TRIGGER_OVERRUN status.operation.instrument.trigger_blender.TRGOVR Set bit indicates one or more enabled bits for operation status trigger blender overrun register is set. Bit B10 decimal value: 1,024 Binary value: 0100 0000 0000
B11 to B15	Not used

In addition to the above constants, *operationRegister* can be set to the numeric equivalent of the bit to set. For example, to set bit B10, set *operationRegister* to 1024.

Example

```
status.operation.instrument.trigger_blender.enable = 1024
```

Uses a decimal value to set the TRGOVR bit of the operation status trigger blender summary enable.

Also see

- [Operation Status Registers](#) (on page 15-8)
- [status.operation.instrument.trigger_blender.trigger_overrun.*](#) (on page 11-299)

status.operation.instrument.trigger_blender.trigger_overrun.*

This attribute contains the operation status trigger blender overrun register set.

Type	TSP-Link accessible	Affected by	Where saved	Default value
Attribute	--	--	--	--
.condition (R)	Yes	Not applicable	Not saved	Not applicable
.enable (RW)	Yes	Status reset	Not saved	0
.event (R)	Yes	Status reset	Not saved	0
.ntr (RW)	Yes	Status reset	Not saved	0
.ptr (RW)	Yes	Status reset	Not saved	126 (All bits set)

Usage

```
operationRegister =
    status.operation.instrument.trigger_blender.trigger_overrun.condition
operationRegister =
    status.operation.instrument.trigger_blender.trigger_overrun.enable
operationRegister =
    status.operation.instrument.trigger_blender.trigger_overrun.event
operationRegister =
    status.operation.instrument.trigger_blender.trigger_overrun.ntr
operationRegister =
    status.operation.instrument.trigger_blender.trigger_overrun.ptr
status.operation.instrument.trigger_blender.trigger_overrun.enable =
    operationRegister
status.operation.instrument.trigger_blender.trigger_overrun.ntr =
    operationRegister
status.operation.instrument.trigger_blender.trigger_overrun.ptr =
    operationRegister
```

<i>operationRegister</i>	The status of the operation status trigger blender overrun register; a zero (0) indicates no bits set (also send 0 to clear all bits); other values indicate various bit settings
--------------------------	---

Details

These attributes are used to read or write to the operation status trigger blender overrun registers. Reading a status register returns a value. The binary equivalent of the returned value indicates which register bits are set. The least significant bit of the binary number is bit B0, and the most significant bit is bit B15. For example, if a value of 18 is read as the value of the condition register, the binary equivalent is 0000 0000 0001 0010. This value indicates that bit B1 and bit B4 are set.

B15	B14	B13	B12	B11	B10	B9	B8	B7	B6	B5	B4	B3	B2	B1	B0
**	>	>	>	>	>	>	>	>	>	>	>	>	>	>	*
0	0	0	0	0	0	0	0	0	0	0	1	0	0	1	0

* Least significant bit

** Most significant bit

A set bit value indicates that the specified trigger blender generated an action overrun.

For information about .condition, .enable, .event, .ntr, and .ptr registers, refer to [Status register set contents](#) (on page 15-1) and [Enable and transition registers](#) (on page 15-19). The individual bits of this register are defined in the following table.

Bit	Value	Decimal value
B0	Not used	Not applicable
B1	status.operation.instrument.trigger_blender.trigger_overrun.BLND1	2
B2	status.operation.instrument.trigger_blender.trigger_overrun.BLND2	4
B3	status.operation.instrument.trigger_blender.trigger_overrun.BLND3	8
B4	status.operation.instrument.trigger_blender.trigger_overrun.BLND4	16
B5	status.operation.instrument.trigger_blender.trigger_overrun.BLND5	32
B6	status.operation.instrument.trigger_blender.trigger_overrun.BLND6	64
B7 to B15	Not used	Not applicable

As an example, to set bit B1 of the operation status trigger blender overrun enable register, set `status.operation.instrument.trigger_blender.trigger_overrun.enable = status.operation.instrument.trigger_blender.trigger_overrun.BLND1`.

In addition to the above constants, *operationRegister* can be set to the numeric equivalent of the bit to set. To set more than one bit of the register, set *operationRegister* to the sum of their decimal weights. For example, to set bits B1 and B4, set *operationRegister* to 18 (which is the sum of 2 + 16).

Bit	B7	B6	B5	B4	B3	B2	B1	B0
Binary value	0/1	0/1	0/1	0/1	0/1	0/1	0/1	0/1
Decimal	128	64	32	16	8	4	2	1
Weights	(2 ⁷)	(2 ⁶)	(2 ⁵)	(2 ⁴)	(2 ³)	(2 ²)	(2 ¹)	(2 ⁰)

Bit	B15	B14	B13	B12	B11	B10	B9	B8
Binary value	0/1	0/1	0/1	0/1	0/1	0/1	0/1	0/1
Decimal	32,768	16,384	8,192	4,096	2,048	1,024	512	256
Weights	(2 ¹⁵)	(2 ¹⁴)	(2 ¹³)	(2 ¹²)	(2 ¹¹)	(2 ¹⁰)	(2 ⁹)	(2 ⁸)

Example

```
status.operation.instrument.trigger_blender.trigger_overrun.enable
= status.operation.instrument.trigger_blender.trigger_overrun.BLND1
```

Uses the constant to set the bit for blender 1 of the operation status trigger blender overrun enable register.

Example

```
status.operation.instrument.trigger_blender.trigger_overrun.enable = 18
```

Uses the decimal value to set the bits for blenders 1 and 4 of the operation status trigger blender overrun enable register.

Also see

- [Operation Status Registers](#) (on page 15-8)
- [status.operation.instrument.trigger_blender.*](#) (on page 11-298)

status.operation.instrument.trigger_timer.*

This attribute contains the operation status trigger timer summary register set.

Type	TSP-Link accessible	Affected by	Where saved	Default value
Attribute	--	--	--	--
.condition (R)	Yes	Not applicable	Not saved	Not applicable
.enable (RW)	Yes	Status reset	Not saved	0
.event (R)	Yes	Status reset	Not saved	0
.ntr (RW)	Yes	Status reset	Not saved	0
.ptr (RW)	Yes	Status reset	Not saved	1024 (All bits set)

Usage

```
operationRegister = status.operation.instrument.trigger_timer.condition
operationRegister = status.operation.instrument.trigger_timer.enable
operationRegister = status.operation.instrument.trigger_timer.event
operationRegister = status.operation.instrument.trigger_timer.ntr
operationRegister = status.operation.instrument.trigger_timer.ptr
status.operation.instrument.trigger_timer.enable = operationRegister
status.operation.instrument.trigger_timer.ntr = operationRegister
status.operation.instrument.trigger_timer.ptr = operationRegister
```

operationRegister The status of the operation status trigger timer summary register; a zero (0) indicates no bits set (also send 0 to clear all bits); the only valid value other than 0 is 1024

Details

These attributes are used to read or write to the operation status trigger timer summary registers. Reading a status register returns a value. The binary equivalent of the returned value indicates which register bits are set. The least significant bit of the binary number is bit B0, and the most significant bit is bit B15.

For information about .condition, .enable, .event, .ntr, and .ptr registers, refer to [Status register set contents](#) (on page 15-1) and [Enable and transition registers](#) (on page 15-19). The individual bits of this register are defined in the following table.

Bit	Value and description
B0 to B9	Not used
B10	status.operation.instrument.trigger_timer.TRIGGER_OVERRUN status.operation.instrument.trigger_timer.TRGOVR Set bit indicates one or more enabled bits for the operation status trigger timer overrun register is set. Bit B10 decimal value: 1,024 Binary value: 0100 0000 0000
B11 to B15	Not used

In addition to the above constants, *operationRegister* can be set to the numeric equivalent of the bit to set. For example, to set bit B10, set *operationRegister* to 1024.

Example

```
status.operation.instrument.trigger_timer.enable = 1024
```

Uses the decimal value to set the TRGOVR bit of the operation status trigger timer summary enable register.

Also see

[Operation Status Registers](#) (on page 15-8)

[status.operation.instrument.trigger_timer.trigger_overrun.*](#) (on page 11-302)

status.operation.instrument.trigger_timer.trigger_overrun.*

This attribute contains the operation status trigger timer overrun register set.

Type	TSP-Link accessible	Affected by	Where saved	Default value
Attribute	--	--	--	--
.condition (R)	Yes	Not applicable	Not saved	Not applicable
.enable (RW)	Yes	Status reset	Not saved	0
.event (R)	Yes	Status reset	Not saved	0
.ntr (RW)	Yes	Status reset	Not saved	0
.ptr (RW)	Yes	Status reset	Not saved	510 (All bits set)

Usage

```

operationRegister =
    status.operation.instrument.trigger_timer.trigger_overrun.condition
operationRegister =
    status.operation.instrument.trigger_timer.trigger_overrun.enable
operationRegister =
    status.operation.instrument.trigger_timer.trigger_overrun.event
operationRegister =
    status.operation.instrument.trigger_timer.trigger_overrun.ntr
operationRegister =
    status.operation.instrument.trigger_timer.trigger_overrun.ptr
status.operation.instrument.trigger_timer.trigger_overrun.enable =
    operationRegister
status.operation.instrument.trigger_timer.trigger_overrun.ntr =
    operationRegister
status.operation.instrument.trigger_timer.trigger_overrun.ptr =
    operationRegister

```

<i>operationRegister</i>	The status of the operation status trigger timer trigger overrun register; a zero (0) indicates no bits set (also send 0 to clear all bits); other values indicate various bit settings
--------------------------	---

Details

These attributes are used to read or write to the operation status trigger timer overrun registers. Reading a status register returns a value. The binary equivalent of the returned value indicates which register bits are set. The least significant bit of the binary number is bit B0, and the most significant bit is bit B15. For example, if a value of 18 is read as the value of the condition register, the binary equivalent is 0000 0000 0001 0010. This value indicates that bit B1 and bit B4 are set.

B15	B14	B13	B12	B11	B10	B9	B8	B7	B6	B5	B4	B3	B2	B1	B0
**	>	>	>	>	>	>	>	>	>	>	>	>	>	>	*
0	0	0	0	0	0	0	0	0	0	0	1	0	0	1	0

* Least significant bit
 ** Most significant bit

A set bit indicates the specified timer generated an action overrun because it was still processing a delay from a previous trigger when a new trigger was received.

For information about .condition, .enable, .event, .ntr, and .ptr registers, refer to [Status register set contents](#) (on page 15-1) and [Enable and transition registers](#) (on page 15-19). The individual bits of this register are defined in the following table.

Bit	Value	Decimal value
B0	Not used	Not applicable
B1	status.operation.instrument.trigger_timer.trigger_overrun.TMR1	2
B2	status.operation.instrument.trigger_timer.trigger_overrun.TMR2	4
B3	status.operation.instrument.trigger_timer.trigger_overrun.TMR3	8
B4	status.operation.instrument.trigger_timer.trigger_overrun.TMR4	16
B5	status.operation.instrument.trigger_timer.trigger_overrun.TMR5	32
B6	status.operation.instrument.trigger_timer.trigger_overrun.TMR6	64
B7	status.operation.instrument.trigger_timer.trigger_overrun.TMR7	128
B8	status.operation.instrument.trigger_timer.trigger_overrun.TMR8	256
B9 to B15	Not used	Not applicable

As an example, to set bit B1 of the operation status trigger timer trigger overrun enable register, set `status.operation.instrument.trigger_timer.trigger_overrun.enable = status.operation.instrument.trigger_timer.trigger_overrun.TMR1`.

In addition to the above constants, *operationRegister* can be set to the numeric equivalent of the bit to set. To set more than one bit of the register, set *operationRegister* to the sum of their decimal weights. For example, to set bits B1 and B4, set *operationRegister* to 18 (which is the sum of 2 + 16).

Bit	B7	B6	B5	B4	B3	B2	B1	B0
Binary value	0/1	0/1	0/1	0/1	0/1	0/1	0/1	0/1
Decimal	128	64	32	16	8	4	2	1
Weights	(2 ⁷)	(2 ⁶)	(2 ⁵)	(2 ⁴)	(2 ³)	(2 ²)	(2 ¹)	(2 ⁰)

Bit	B15	B14	B13	B12	B11	B10	B9	B8
Binary value	0/1	0/1	0/1	0/1	0/1	0/1	0/1	0/1
Decimal	32,768	16,384	8,192	4,096	2,048	1,024	512	256
Weights	(2 ¹⁵)	(2 ¹⁴)	(2 ¹³)	(2 ¹²)	(2 ¹¹)	(2 ¹⁰)	(2 ⁹)	(2 ⁸)

Example 1

```
status.operation.instrument.trigger_timer.trigger_overrun.enable =
    status.operation.instrument.trigger_timer.trigger_overrun.TMR3
```

Uses a constant to set the timer 3 bit of the operation status trigger timer overrun enable register.

Example 2

```
status.operation.instrument.trigger_timer.trigger_overrun.enable = 18
```

Uses a constant to set timer bits B1 and B4 of the operation status trigger timer overrun enable register.

Also see

[Operation Status Registers](#) (on page 15-8)

[status.operation.instrument.trigger_timer.*](#) (on page 11-301)

status.operation.instrument.tsplink.*

This attribute contains the operation status TSP-Link summary register set.

Type	TSP-Link accessible	Affected by	Where saved	Default value
Attribute	--	--	--	--
.condition (R)	Yes	Not applicable	Not saved	Not applicable
.enable (RW)	Yes	Status reset	Not saved	0
.event (R)	Yes	Status reset	Not saved	0
.ntr (RW)	Yes	Status reset	Not saved	0
.ptr (RW)	Yes	Status reset	Not saved	1024 (All bits set)

Usage

```
operationRegister = status.operation.instrument.tsplink.condition
operationRegister = status.operation.instrument.tsplink.enable
operationRegister = status.operation.instrument.tsplink.event
operationRegister = status.operation.instrument.tsplink.ntr
operationRegister = status.operation.instrument.tsplink.ptr
status.operation.instrument.tsplink.enable = operationRegister
status.operation.instrument.tsplink.ntr = operationRegister
status.operation.instrument.tsplink.ptr = operationRegister
```

<i>operationRegister</i>	The status of the operation status TSP-Link summary register; a zero (0) indicates no bits set (also send 0 to clear all bits); the only valid value other than 0 is 1024
--------------------------	---

Details

These attributes are used to read or write to the operation status TSP-Link summary registers. Reading a status register returns a value. The binary equivalent of the returned value indicates which register bits are set. The least significant bit of the binary number is bit B0, and the most significant bit is bit B15.

For information about .condition, .enable, .event, .ntr, and .ptr registers, refer to [Status register set contents](#) (on page 15-1) and [Enable and transition registers](#) (on page 15-19). The individual bits of this register are defined in the following table.

Bit	Value and description
B0 to B9	Not used
B10	status.operation.instrument.tsplink.TRIGGER_OVERRUN status.operation.instrument.tsplink.TRGOVR Set bit indicates one or more enabled bits for the operation status TSP-Link overrun register is set. Bit B10 decimal value: 1,024 Binary value: 0100 0000 0000
B11 to B15	Not used

In addition to the above constants, *operationRegister* can be set to the numeric equivalent of the bit to set. For example, to set bit B10, set *operationRegister* to 1024.

Example

```
status.operation.instrument.tsplink.enable = 1024
Uses the decimal value to set the trigger overrun bit of the operation status TSP-Link summary enable register.
```

Also see

- [Operation Status Registers](#) (on page 15-8)
- [status.operation.instrument.tsplink.trigger_overrun.*](#) (on page 11-305)

status.operation.instrument.tsplink.trigger_overrun.*

This attribute contains the operation status TSP-Link overrun register set.

Type	TSP-Link accessible	Affected by	Where saved	Default value
Attribute	--	--	--	--
.condition (R)	Yes	Not applicable	Not saved	Not applicable
.enable (RW)	Yes	Status reset	Not saved	0
.event (R)	Yes	Status reset	Not saved	0
.ntr (RW)	Yes	Status reset	Not saved	0
.ptr (RW)	Yes	Status reset	Not saved	14 (All bits set)

Usage

```

operationRegister =
    status.operation.instrument.tsplink.trigger_overrun.condition
operationRegister = status.operation.instrument.tsplink.trigger_overrun.enable
operationRegister = status.operation.instrument.tsplink.trigger_overrun.event
operationRegister = status.operation.instrument.tsplink.trigger_overrun.ntr
operationRegister = status.operation.instrument.tsplink.trigger_overrun.ptr
status.operation.instrument.tsplink.trigger_overrun.enable = operationRegister
status.operation.instrument.tsplink.trigger_overrun.ntr = operationRegister
status.operation.instrument.tsplink.trigger_overrun.ptr = operationRegister

```

operationRegister

The status of the operation status TSP-link overrun register; a zero (0) indicates no bits set (also send 0 to clear all bits); other values indicate various bit settings

Details

These attributes are used to read or write to the operation status TSP-link overrun registers. Reading a status register returns a value. The binary equivalent of the returned value indicates which register bits are set. The least significant bit of the binary number is bit B0, and the most significant bit is bit B15. For example, if a value of 10 is read as the value of the condition register, the binary equivalent is 0000 0000 0000 1010. This value indicates that bit B1 and bit B3 are set.

B15	B14	B13	B12	B11	B10	B9	B8	B7	B6	B5	B4	B3	B2	B1	B0
**	>	>	>	>	>	>	>	>	>	>	>	>	>	>	*
0	0	0	0	0	0	0	0	0	0	0	0	1	0	1	0

* Least significant bit

** Most significant bit

A set bit indicates that the specified line generated an action overrun when triggered to generate an output trigger.

For information about .condition, .enable, .event, .ntr, and .ptr registers, refer to [Status register set contents](#) (on page 15-1) and [Enable and transition registers](#) (on page 15-19). The individual bits of this register are defined in the following table.

Bit	Value	Decimal value
B0	Not used	Not applicable
B1	status.operation.instrument.tsplink.trigger_overrun.LINE1	2
B2	status.operation.instrument.tsplink.trigger_overrun.LINE2	4
B3	status.operation.instrument.tsplink.trigger_overrun.LINE3	8
B4 to B15	Not used	Not applicable

As an example, to set bit B1 of the operation status TSP-Link overrun enable register, set
status.operation.instrument.tsplink.trigger_overrun.enable =
status.operation.instrument.tsplink.trigger_overrun.LINE1.

In addition to the above constants, *operationRegister* can be set to the numeric equivalent of the bit to set. To set more than one bit of the register, set *operationRegister* to the sum of their decimal weights. For example, to set bits B1 and B3, set *operationRegister* to 10 (which is the sum of 2 + 8).

Bit	B7	B6	B5	B4	B3	B2	B1	B0
Binary value	0/1	0/1	0/1	0/1	0/1	0/1	0/1	0/1
Decimal	128	64	32	16	8	4	2	1
Weights	(2 ⁷)	(2 ⁶)	(2 ⁵)	(2 ⁴)	(2 ³)	(2 ²)	(2 ¹)	(2 ⁰)

Bit	B15	B14	B13	B12	B11	B10	B9	B8
Binary value	0/1	0/1	0/1	0/1	0/1	0/1	0/1	0/1
Decimal	32,768	16,384	8,192	4,096	2,048	1,024	512	256
Weights	(2 ¹⁵)	(2 ¹⁴)	(2 ¹³)	(2 ¹²)	(2 ¹¹)	(2 ¹⁰)	(2 ⁹)	(2 ⁸)

Example 1

```
status.operation.instrument.tsplink.trigger_ouerrun.enable =
    status.operation.instrument.tsplink.trigger_ouerrun.LINE1
```

Uses a constant to set the line 1 bit of the operation status TSP-Link ouerrun enable register.

Example 2

```
status.operation.instrument.tsplink.trigger_ouerrun.enable = 10
```

Uses the decimal value to set bits for lines 1 and 3 of the operation status TSP-Link ouerrun enable register.

Also see

- [Operation Status Registers](#) (on page 15-8)
- [status.operation.instrument.trigger_timer.*](#) (on page 11-301)

status.operation.measuring.*

This attribute contains the operation status measuring summary register set.

Type	TSP-Link accessible	Affected by	Where saved	Default value
Attribute	--	--	--	--
.condition (R)	Yes	Not applicable	Not saved	Not applicable
.enable (RW)	Yes	Status reset	Not saved	0
.event (R)	Yes	Status reset	Not saved	0
.ntr (RW)	Yes	Status reset	Not saved	0
.ptr (RW)	Yes	Status reset	Not saved	2 (All bits set)

Usage

```
operationRegister = status.operation.measuring.condition
operationRegister = status.operation.measuring.enable
operationRegister = status.operation.measuring.event
operationRegister = status.operation.measuring.ntr
operationRegister = status.operation.measuring.ptr
status.operation.measuring.enable = operationRegister
status.operation.measuring.ntr = operationRegister
status.operation.measuring.ptr = operationRegister
```

operationRegister The status of the operation status measuring summary register; a zero (0) indicates no bits set (also send 0 to clear all bits); the only other valid value is 2

Details

These attributes are used to read or write to the operation status measuring summary registers. Reading a status register returns a value. The binary equivalent of the returned value indicates which register bits are set. The least significant bit of the binary number is bit B0, and the most significant bit is bit B15.

For information about `.condition`, `.enable`, `.event`, `.ntr`, and `.ptr` registers, refer to [Status register set contents](#) (on page 15-1) and [Enable and transition registers](#) (on page 15-19). The individual bits of this register are defined in the following table.

Bit	Value and description
B0	Not used
B1	<code>status.operation.measuring.SMUA</code> Bit is set when SMU A is taking an overlapped measurement, but it is not set when taking a normal synchronous measurement. Bit B1 decimal value: 2 Binary value: 0000 0010
B2 to B15	Not used

In addition to the above constants, `operationRegister` can be set to the decimal equivalent of the bit to set.

Example 1

```
status.operation.measuring.enable = status.operation.measuring.SMUA
```

Uses the constant to set the SMUA bit, B1, of the operation status measuring summary enable register.

Example 2

```
status.operation.measuring.enable = 2
```

Uses the decimal value to set the SMUA bit, B1, of the operation status measuring summary enable register.

Also see

[Operation Status Registers](#) (on page 15-8)

[status.operation.*](#) (on page 11-281)

status.operation.remote.*

This attribute contains the operation status remote summary register set.

Type	TSP-Link accessible	Affected by	Where saved	Default value
Attribute	--	--	--	--
<code>.condition</code> (R)	Yes	Not applicable	Not saved	Not applicable
<code>.enable</code> (RW)	Yes	Status reset	Not saved	0
<code>.event</code> (R)	Yes	Status reset	Not saved	0
<code>.ntr</code> (RW)	Yes	Status reset	Not saved	0
<code>.ptr</code> (RW)	Yes	Status reset	Not saved	2050 (All bits set)

Usage

```
operationRegister = status.operation.remote.condition
operationRegister = status.operation.remote.enable
operationRegister = status.operation.remote.event
operationRegister = status.operation.remote.ntr
operationRegister = status.operation.remote.ptr
status.operation.remote.enable = operationRegister
status.operation.remote.ntr = operationRegister
status.operation.remote.ptr = operationRegister
```

<i>operationRegister</i>	The status of the operation status remote summary register; a zero (0) indicates no bits set (also send 0 to clear all bits); other values indicate various bit settings
--------------------------	--

Details

These attributes are used to read or write to the operation status remote summary registers. Reading a status register returns a value. The binary equivalent of the returned value indicates which register bits are set. The least significant bit of the binary number is bit B0, and the most significant bit is bit B15.

For information about .condition, .enable, .event, .ntr, and .ptr registers, refer to [Status register set contents](#) (on page 15-1) and [Enable and transition registers](#) (on page 15-19). The individual bits of this register are defined in the following table.

Bit	Value and description
B0	Not used
B1	status.operation.remote.COMMAND_AVAILABLE status.operation.remote.CAV Set bit indicates there is a command available in the execution queue. Bit B1 decimal value: 2 Binary value: 0000 0000 0000 0010
B2 to B10	Not used
B11	status.operation.remote.PROMPTS_ENABLED status.operation.remote.PRMPPT Set bit indicates command prompts are enabled. Bit B11 decimal value: 2,048 Binary value: 0000 0100 0000 0000
B12 to B15	Not used

As an example, to set bit B1 of the operation status remote summary enable register, set `status.operation.remote.enable = status.operation.remote.CAV`.

In addition to the above constants, *operationRegister* can be set to the decimal value of the bit to set. To set more than one bit of the register, set *operationRegister* to the sum of their decimal values. For example, to set bits B1 and B11, set *operationRegister* to 2,050 (which is the sum of 2 + 2,048).

Example 1

<code>status.operation.remote.enable = status.operation.remote.CAV</code>
Uses a constant to set the CAV bit, B1, of the operation status remote summary enable register.

Example 2

```
status.operation.remote.enable = 2050
```

Uses the decimal value to set bits B1 and B11 of the operation status remote summary enable register.

Also see

[Operation Status Registers](#) (on page 15-8)

[status.operation.*](#) (on page 11-281)

status.operation.sweeping.*

This attribute contains the operation status sweeping summary register set.

Type	TSP-Link accessible	Affected by	Where saved	Default value
Attribute	--	--	--	--
.condition (R)	Yes	Not applicable	Not saved	Not applicable
.enable (RW)	Yes	Status reset	Not saved	0
.event (R)	Yes	Status reset	Not saved	0
.ntr (RW)	Yes	Status reset	Not saved	0
.ptr (RW)	Yes	Status reset	Not saved	2 (All bits set)

Usage

```
operationRegister = status.operation.sweeping.condition
operationRegister = status.operation.sweeping.enable
operationRegister = status.operation.sweeping.event
operationRegister = status.operation.sweeping.ntr
operationRegister = status.operation.sweeping.ptr
status.operation.sweeping.enable = operationRegister
status.operation.sweeping.ntr = operationRegister
status.operation.sweeping.ptr = operationRegister
```

<i>operationRegister</i>	The status of the operation status sweeping summary register; a zero (0) indicates no bits set (also send 0 to clear all bits); other values indicate various bit settings
--------------------------	--

Details

These attributes are used to read or write to the operation status sweeping summary registers. Reading a status register returns a value. The binary equivalent of the returned value indicates which register bits are set. The least significant bit of the binary number is bit B0, and the most significant bit is bit B15.

For information about .condition, .enable, .event, .ntr, and .ptr registers, refer to [Status register set contents](#) (on page 15-1) and [Enable and transition registers](#) (on page 15-19). The individual bits of this register are defined in the following table.

Bit	Value and description
B0	Not used
B1	status.operation.sweeping.SMUA Set bit indicates that SMU A is sweeping. Bit B1 decimal value: 2 Binary value: 0000 0010
B2 to B15	Not used

As an example, to set bit B1 of the operation status sweeping summary enable register, set `status.operation.sweeping.enable = status.operation.sweeping.SMUA`.

In addition to the above constants, `operationRegister` can be set to 2, the decimal value of Bit 1.

Example

```
status.operation.sweeping.enable = status.operation.sweeping.SMUA
Uses a constant to set the SMUA bit of the operation status sweeping summary enable register.
```

Also see

- [Operation Status Registers](#) (on page 15-8)
- [status.operation.*](#) (on page 11-281)

status.operation.trigger_overrun.*

This attribute contains the operation status trigger overrun summary register set.

Type	TSP-Link accessible	Affected by	Where saved	Default value
Attribute	--	--	--	--
.condition (R)	Yes	Not applicable	Not saved	Not applicable
.enable (RW)	Yes	Status reset	Not saved	0
.event (R)	Yes	Status reset	Not saved	0
.ntr (RW)	Yes	Status reset	Not saved	0
.ptr (RW)	Yes	Status reset	Not saved	31,746 (All bits set)

Usage

```
operationRegister = status.operation.trigger_overrun.condition
operationRegister = status.operation.trigger_overrun.enable
operationRegister = status.operation.trigger_overrun.event
operationRegister = status.operation.trigger_overrun.ntr
operationRegister = status.operation.trigger_overrun.ptr
status.operation.trigger_overrun.enable = operationRegister
status.operation.trigger_overrun.ntr = operationRegister
status.operation.trigger_overrun.ptr = operationRegister
```

<code>operationRegister</code>	The status of the operation status trigger overrun summary register; a zero (0) indicates no bits set (also send 0 to clear all bits); other values indicate various bit settings
--------------------------------	---

Details

These attributes are used to read or write to the operation status trigger overrun summary registers. Reading a status register returns a value. The binary equivalent of the returned value indicates which register bits are set. The least significant bit of the binary number is bit B0, and the most significant bit is bit B15. For example, if a value of $1.02600e+03$ (which is 1,026) is read as the value of the condition register, the binary equivalent is 0000 0100 0000 0010. This value indicates that bit B1 and bit B10 are set.

B15	B14	B13	B12	B11	B10	B9	B8	B7	B6	B5	B4	B3	B2	B1	B0
**	>	>	>	>	>	>	>	>	>	>	>	>	>	>	*
0	0	0	0	0	1	0	0	0	0	0	0	0	0	1	0

* Least significant bit

** Most significant bit

The bits in this register summarize events in other registers. A set bit in this summary register indicates that an enabled event in one of the summarized registers is set.

For information about .condition, .enable, .event, .ntr, and .ptr registers, refer to [Status register set contents](#) (on page 15-1) and [Enable and transition registers](#) (on page 15-19). The individual bits of this register are defined in the following table.

Bit	Value and description
B0	Not used
B1	status.operation.trigger_overrun.SMUA Set bit indicates one of the enabled bits in the operation status SMU A trigger overrun event register is set. Bit B1 decimal value: 2
B2 to B9	Not used
B10	status.operation.trigger_overrun.TRIGGER_BLENDER status.operation.trigger_overrun.TRGBLND Set bit indicates one of the enabled bits in the operation status trigger blender overrun event register is set. Bit B10 decimal value: 1,024
B11	status.operation.trigger_overrun.TRIGGER_TIMER status.operation.trigger_overrun.TRGTMR Set bit indicates one of the enabled bits in the operation status trigger timer overrun event register is set. Bit B11 decimal value: 2,048
B12	status.operation.trigger_overrun.DIGITAL_IO status.operation.trigger_overrun.DIGIO Set bit indicates one of the enabled bits in the operation status digital I/O overrun event register is set. Bit B12 decimal value: 4,096
B13	status.operation.trigger_overrun.TSPLINK Set bit indicates one of the enabled bits in the operation status TSP-Link overrun event register is set. Bit B13 decimal value: 8,192
B14	status.operation.trigger_overrun.LAN Set bit indicates one of the enabled bits in the operation status LAN trigger overrun event register is set. Bit B14 decimal value: 16,384
B15	Not used

As an example, to set bit B1 of the operation status trigger overrun summary enable register, set `status.operation.trigger_overrun.enable = status.operation.trigger_overrun.SMUA`.

In addition to the above constants, `operationRegister` can be set to the numeric equivalent of the bit to set. To set more than one bit of the register, set `operationRegister` to the sum of their decimal weights. For example, to set bits B1 and B10, set `operationRegister` to 1,026 (which is the sum of 2 + 1,024).

Bit	B7	B6	B5	B4	B3	B2	B1	B0
Binary value	0/1	0/1	0/1	0/1	0/1	0/1	0/1	0/1
Decimal	128	64	32	16	8	4	2	1
Weights	(2 ⁷)	(2 ⁶)	(2 ⁵)	(2 ⁴)	(2 ³)	(2 ²)	(2 ¹)	(2 ⁰)

Bit	B15	B14	B13	B12	B11	B10	B9	B8
Binary value	0/1	0/1	0/1	0/1	0/1	0/1	0/1	0/1
Decimal	32,768	16,384	8,192	4,096	2,048	1,024	512	256
Weights	(2 ¹⁵)	(2 ¹⁴)	(2 ¹³)	(2 ¹²)	(2 ¹¹)	(2 ¹⁰)	(2 ⁹)	(2 ⁸)

Example 1

```
operationRegister = status.operation.trigger_overrun.SMUA +
    status.operation.trigger_overrun.TRGBLND
status.operation.trigger_overrun.enable = operationRegister
```

Uses constants to set bits B1 and bit B10 of the operation status trigger overrun summary enable register.

Example 2

```
operationRegister = 1026
status.operation.trigger_overrun.enable = operationRegister
```

Uses the decimal value to set bits B1 and bit B10 of the operation status trigger overrun summary enable register.

Also see

- [Operation Status Registers](#) (on page 15-8)
- [status.operation.*](#) (on page 11-281)

status.operation.user.*

These attributes manage the operation status user register set of the status model.

Type	TSP-Link accessible	Affected by	Where saved	Default value
Attribute	--	--	--	--
.condition (RW)	Yes	Status reset	Not saved	0
.enable (RW)	Yes	Status reset	Not saved	0
.event (R)	Yes	Status reset	Not saved	0
.ntr (RW)	Yes	Status reset	Not saved	0
.ptr (RW)	Yes	Status reset	Not saved	32,767 (All bits set)

Usage

```

operationRegister = status.operation.user.condition
operationRegister = status.operation.user.enable
operationRegister = status.operation.user.event
operationRegister = status.operation.user.ntr
operationRegister = status.operation.user.ptr
status.operation.user.condition = operationRegister
status.operation.user.enable = operationRegister
status.operation.user.ntr = operationRegister
status.operation.user.ptr = operationRegister

```

<i>operationRegister</i>	The status of the operation status user register; a zero (0) indicates no bits set (also send 0 to clear all bits); other values indicate various bit settings
--------------------------	--

Details

These attributes are used to read or write to the operation status user registers. Reading a status register returns a value. The binary equivalent of the value indicates which register bits are set. In the binary equivalent, the least significant bit is bit B0, and the most significant bit is bit B15. For example, if a value of $1.29000e+02$ (which is 129) is read as the value of the condition register, the binary equivalent is 0000 0000 1000 0001. This value indicates that bits B0 and B7 are set.

B15	B14	B13	B12	B11	B10	B9	B8	B7	B6	B5	B4	B3	B2	B1	B0
**	>	>	>	>	>	>	>	>	>	>	>	>	>	>	*
0	0	0	0	0	0	0	0	1	0	0	0	0	0	0	1

* Least significant bit

** Most significant bit

For information about .condition, .enable, .event, .ntr, and .ptr registers, refer to [Status register set contents](#) (on page 15-1) and [Enable and transition registers](#) (on page 15-19). The individual bits of this register are defined in the following table.

Bit	Value	Decimal value
B0	status.operation.user.BIT0	1
B1	status.operation.user.BIT1	2
B2	status.operation.user.BIT2	4
B3	status.operation.user.BIT3	8
B4	status.operation.user.BIT4	16
B5	status.operation.user.BIT5	32
B6	status.operation.user.BIT6	64
B7	status.operation.user.BIT7	128
B8	status.operation.user.BIT8	256
B9	status.operation.user.BIT9	512
B10	status.operation.user.BIT10	1,024
B11	status.operation.user.BIT11	2,048
B12	status.operation.user.BIT12	4,096
B13	status.operation.user.BIT13	8,192

Bit	Value	Decimal value
B14	status.operation.user.BIT14	16,384
B15	Not used	Not applicable

As an example, to set bit B0 of the operation status user enable register, set `status.operation.user.enable = status.operation.user.BIT0`.

In addition to the above constants, *operationRegister* can be set to the decimal value of the bit to set. To set more than one bit of the register, set *operationRegister* to the sum of their decimal values. For example, to set bits B11 and B14, set *operationRegister* to 18,432 (which is the sum of 2,048 + 16,384).

Bit	B7	B6	B5	B4	B3	B2	B1	B0
Binary value	0/1	0/1	0/1	0/1	0/1	0/1	0/1	0/1
Decimal	128	64	32	16	8	4	2	1
Weights	(2 ⁷)	(2 ⁶)	(2 ⁵)	(2 ⁴)	(2 ³)	(2 ²)	(2 ¹)	(2 ⁰)

Bit	B15	B14	B13	B12	B11	B10	B9	B8
Binary value	0/1	0/1	0/1	0/1	0/1	0/1	0/1	0/1
Decimal	32,768	16,384	8,192	4,096	2,048	1,024	512	256
Weights	(2 ¹⁵)	(2 ¹⁴)	(2 ¹³)	(2 ¹²)	(2 ¹¹)	(2 ¹⁰)	(2 ⁹)	(2 ⁸)

Example 1

```
operationRegister = status.operation.user.BIT11 + status.operation.user.BIT14
status.operation.user.enable = operationRegister
```

Uses constants to set bits B11 and B14 of the operation status user enable register.

Example 2

```
-- 18432 = binary 0100 1000 0000 0000
operationRegister = 18432
status.operation.enable = operationRegister
```

Uses the decimal value to set bits B11 and B14 of the operation status user enable register.

Also see

- [Operation Status Registers](#) (on page 15-8)
- [status.operation.*](#) (on page 11-281)

status.questionable.*

These attributes manage the questionable status register set of the status model.

Type	TSP-Link accessible	Affected by	Where saved	Default value
Attribute	--	--	--	--
.condition (R)	Yes	Not applicable	Not saved	Not applicable
.enable (RW)	Yes	Status reset	Not saved	0
.event (R)	Yes	Status reset	Not saved	0
.ntr (RW)	Yes	Status reset	Not saved	0
.ptr (RW)	Yes	Status reset	Not saved	13,056 (All bits set)

Usage

```
questionableRegister = status.questionable.condition
questionableRegister = status.questionable.enable
questionableRegister = status.questionable.event
questionableRegister = status.questionable.ntr
questionableRegister = status.questionable.ptr
status.questionable.enable = questionableRegister
status.questionable.ntr = questionableRegister
status.questionable.ptr = questionableRegister
```

questionableRegister

The status of the questionable status register; a zero (0) indicates no bits set (also send 0 to clear all bits); other values indicate various bit settings

Details

These attributes are used to read or write to the questionable status registers. Reading a status register returns a value. In the binary equivalent, the least significant bit is bit B0, and the most significant bit is bit B15. For example, if a value of 1.22880e+04 (which is 12,288) is read as the value of the condition register, the binary equivalent is 0011 0000 0000 0000. This value indicates that bits B12 and B13 are set.

B15	B14	B13	B12	B11	B10	B9	B8	B7	B6	B5	B4	B3	B2	B1	B0
**	>	>	>	>	>	>	>	>	>	>	>	>	>	>	*
0	0	1	1	0	0	0	0	0	0	0	0	0	0	0	0

* Least significant bit

** Most significant bit

For information about .condition, .enable, .event, .ntr, and .ptr registers, refer to [Status register set contents](#) (on page 15-1) and [Enable and transition registers](#) (on page 15-19). The individual bits of this register are defined in the following table.

Bit	Value and description
B0 to B7	Not used
B8	status.questionable.CALIBRATION status.questionable.CAL An enabled bit in the questionable status calibration summary event register is set. Bit B6 decimal value: 256

Bit	Value and description
B9	status.questionable.UNSTABLE_OUTPUT status.questionable.UO An enabled bit in the questionable status unstable output summary event register is set. Bit B9 decimal value: 512
B10	Not used
B11	Not used
B12	status.questionable.OVER_TEMPERATURE status.questionable.OTEMP An enabled bit in the questionable status over temperature summary event register is set. Bit B12 decimal value: 4,096
B13	status.questionable.INSTRUMENT_SUMMARY status.questionable.INST An enabled bit in the questionable status instrument summary event register is set. Bit B13 decimal value: 8,192
B14 to B15	Not used

As an example, to set bit B9 of the questionable status enable register, set `status.questionable.enable = status.questionable.UO`.

In addition to the above constants, *questionableRegister* can be set to the decimal value of the bit to set. To set more than one bit of the register, set *questionableRegister* to the sum of their decimal values. For example, to set bits B12 and B13, set *questionableRegister* to 12,288 (which is the sum of 4,096 + 8,192).

Bit	B7	B6	B5	B4	B3	B2	B1	B0
Binary value	0/1	0/1	0/1	0/1	0/1	0/1	0/1	0/1
Decimal	128	64	32	16	8	4	2	1
Weights	(2 ⁷)	(2 ⁶)	(2 ⁵)	(2 ⁴)	(2 ³)	(2 ²)	(2 ¹)	(2 ⁰)

Bit	B15	B14	B13	B12	B11	B10	B9	B8
Binary value	0/1	0/1	0/1	0/1	0/1	0/1	0/1	0/1
Decimal	32,768	16,384	8,192	4,096	2,048	1,024	512	256
Weights	(2 ¹⁵)	(2 ¹⁴)	(2 ¹³)	(2 ¹²)	(2 ¹¹)	(2 ¹⁰)	(2 ⁹)	(2 ⁸)

Example 1

```
status.questionable.enable = status.questionable.OTEMP
```

Uses a constant to set the OTEMP bit of the questionable status enable register.

Example 2

```
status.questionable.enable = 12288
```

Uses the decimal value to set the B12 and B13 bits of the questionable status enable register.

Also see

[Questionable Status Registers](#) (on page 15-13)

status.questionable.calibration.*

This attribute contains the questionable status calibration summary register set.

Type	TSP-Link accessible	Affected by	Where saved	Default value
Attribute	--	--	--	--
.condition (R)	Yes	Not applicable	Not saved	Not applicable
.enable (RW)	Yes	Status reset	Not saved	0
.event (R)	Yes	Status reset	Not saved	0
.ntr (RW)	Yes	Status reset	Not saved	0
.ptr (RW)	Yes	Status reset	Not saved	2 (All bits set)

Usage

```
questionableRegister = status.questionable.calibration.condition
questionableRegister = status.questionable.calibration.enable
questionableRegister = status.questionable.calibration.event
questionableRegister = status.questionable.calibration.ntr
questionableRegister = status.questionable.calibration.ptr
status.questionable.calibration.enable = questionableRegister
status.questionable.calibration.ntr = questionableRegister
status.questionable.calibration.ptr = questionableRegister
```

questionableRegister

The status of the questionable status calibration summary register; a zero (0) indicates no bits set (also send 0 to clear all bits); other values indicate various bit settings

Details

These attributes are used to read or write to the questionable status calibration summary registers. Reading a status register returns a value. The binary equivalent of the returned value indicates which register bits are set. The least significant bit of the binary number is bit B0, and the most significant bit is bit B15.

For information about .condition, .enable, .event, .ntr, and .ptr registers, refer to [Status register set contents](#) (on page 15-1) and [Enable and transition registers](#) (on page 15-19). The individual bits of this register are defined in the following table.

Bit	Value and description
B0	Not used
B1	status.questionable.calibration.SMUA Set bit indicates that the SMU A calibration constants stored in nonvolatile memory were corrupted and could not be loaded when the instrument powered up. Bit B1 decimal value: 2 Binary value: 0000 0010
B2 to B15	Not used

As an example, to set bit B1 of the questionable status calibration summary enable register, set

```
status.questionable.calibration.enable =
status.questionable.calibration.SMUA.
```

In addition to the above constants, *questionableRegister* can be set to 2, the decimal value of the B1 bit.

Example

```
status.questionable.calibration.enable = status.questionable.calibration.SMUA
Uses a constant to set the SMUA bit of the questionable status calibration summary enable register.
```

Also see

[Questionable Status Registers](#) (on page 15-13)
[status.questionable.*](#) (on page 11-316)

status.questionable.instrument.*

This attribute contains the questionable status instrument summary register set.

Type	TSP-Link accessible	Affected by	Where saved	Default value
Attribute	--	--	--	--
.condition (R)	Yes	Not applicable	Not saved	Not applicable
.enable (RW)	Yes	Status reset	Not saved	0
.event (R)	Yes	Status reset	Not saved	0
.ntr (RW)	Yes	Status reset	Not saved	0
.ptr (RW)	Yes	Status reset	Not saved	2 (All bits set)

Usage

```
questionableRegister = status.questionable.instrument.condition
questionableRegister = status.questionable.instrument.enable
questionableRegister = status.questionable.instrument.event
questionableRegister = status.questionable.instrument.ntr
questionableRegister = status.questionable.instrument.ptr
status.questionable.instrument.enable = questionableRegister
status.questionable.instrument.ntr = questionableRegister
status.questionable.instrument.ptr = questionableRegister
```

<i>questionableRegister</i>	The status of the questionable status instrument summary register; a zero (0) indicates no bits set (also send 0 to clear all bits); the only other valid setting is 2
-----------------------------	--

Details

These attributes are used to read or write to the questionable status instrument summary registers. Reading a status register returns a value. The binary equivalent of the returned value indicates which register bit is set. The least significant bit of the binary number is bit B0, and the most significant bit is bit B15.

For information about .condition, .enable, .event, .ntr, and .ptr registers, refer to [Status register set contents](#) (on page 15-1) and [Enable and transition registers](#) (on page 15-19). The individual bits of this register are defined in the following table.

Bit	Value and description
B0	Not used
B1	status.questionable.instrument.SMUA Set bit indicates one or more enabled bits for the SMU A questionable register are set. Bit B1 decimal value: 2 Binary value: 0000 0010
B2 to B15	Not used

As an example, to set bit B1 of the questionable status instrument summary enable register, set `status.questionable.instrument.enable = status.questionable.instrument.SMUA`.

In addition to the constant, `questionableRegister` can be set to the decimal value of the bit.

Example

```
status.questionable.instrument.enable = status.questionable.instrument.SMUA
```

Uses a constant to set the SMUA bit of the questionable status instrument summary enable register.

Also see

[Questionable Status Registers](#) (on page 15-13)

[status.questionable.*](#) (on page 11-316)

status.questionable.instrument.smua.*

This attribute contains the questionable status SMU A summary register set.

Type	TSP-Link accessible	Affected by	Where saved	Default value
Attribute	—	—	—	—
.condition (R)	Yes	Not applicable	Not saved	Not applicable
.enable (RW)	Yes	Status reset	Not saved	0
.event (R)	Yes	Status reset	Not saved	0
.ntr (RW)	Yes	Status reset	Not saved	0
.ptr (RW)	Yes	Status reset	Not saved	4864 (All bits set)

Usage

```
questionableRegister = status.questionable.instrument.smua.condition
questionableRegister = status.questionable.instrument.smua.enable
questionableRegister = status.questionable.instrument.smua.event
questionableRegister = status.questionable.instrument.smua.ntr
questionableRegister = status.questionable.instrument.smua.ptr
status.questionable.instrument.smua.enable = questionableRegister
status.questionable.instrument.smua.ntr = questionableRegister
status.questionable.instrument.smua.ptr = questionableRegister
```

`questionableRegister`

The status of the questionable status SMU summary register; a zero (0) indicates no bits set (also send 0 to clear all bits); other values indicate various bit settings

Details

These attributes are used to read or write to the questionable status instrument SMU summary registers. Reading a status register returns a value. The binary equivalent of the returned value indicates which register bits are set. The least significant bit of the binary number is bit B0, and the most significant bit is bit B15. For example, if a value of `7.68000e+02` (which is 768) is read as the value of the condition register, the binary equivalent is `0000 0011 0000 0000`. This value indicates that bit B8 and bit B9 are set.

B15	B14	B13	B12	B11	B10	B9	B8	B7	B6	B5	B4	B3	B2	B1	B0
**	>	>	>	>	>	>	>	>	>	>	>	>	>	>	*
0	0	0	0	0	0	1	1	0	0	0	0	0	0	0	0

* Least significant bit
 ** Most significant bit

For information about .condition, .enable, .event, .ntr, and .ptr registers, refer to [Status register set contents](#) (on page 15-1) and [Enable and transition registers](#) (on page 15-19). The individual bits of this register are defined in the following table.

Bit	Value and description
B0 to B7	Not used
B8	status.questionable.instrument.smua.CALIBRATION status.questionable.instrument.smua.CAL Set bit indicates that the calibration constants stored in nonvolatile memory were corrupted and could not be loaded when the instrument powered up. Bit B8 decimal value: 256
B9	status.questionable.instrument.smua.UNSTABLE_OUTPUT status.questionable.instrument.smua.UO Set bit indicates that an unstable output condition was detected. Bit B9 decimal value: 512
B10 to B11	Not used
B12	status.questionable.instrument.smua.OVER_TEMPERATURE status.questionable.instrument.smua.OTEMP Set bit indicates that an over temperature condition was detected. Bit B12 decimal value: 4,096
B13 to B15	Not used

As an example, to set bit B8 of the questionable status SMU A summary enable register, set `status.questionable.instrument.smua.enable = status.questionable.instrument.smua.CAL`.

In addition to the above constants, `questionableRegister` can be set to the decimal value of the bit to set. To set more than one bit of the register, set `questionableRegister` to the sum of their decimal values. For example, to set bits B8 and B9, set `questionableRegister` to 768 (which is the sum of 256 + 512).

Bit	B7	B6	B5	B4	B3	B2	B1	B0
Binary value	0/1	0/1	0/1	0/1	0/1	0/1	0/1	0/1
Decimal	128	64	32	16	8	4	2	1
Weights	(2 ⁷)	(2 ⁶)	(2 ⁵)	(2 ⁴)	(2 ³)	(2 ²)	(2 ¹)	(2 ⁰)

Bit	B15	B14	B13	B12	B11	B10	B9	B8
Binary value	0/1	0/1	0/1	0/1	0/1	0/1	0/1	0/1
Decimal	32,768	16,384	8,192	4,096	2,048	1,024	512	256
Weights	(2 ¹⁵)	(2 ¹⁴)	(2 ¹³)	(2 ¹²)	(2 ¹¹)	(2 ¹⁰)	(2 ⁹)	(2 ⁸)

Example

```
questionableRegister = status.questionable.instrument.smua.CAL +
    status.questionable.instrument.smua.UO
status.questionable.instrument.smua.enable = questionableRegister
```

Uses constants to set bits B8 and bit B9 of the questionable status SMU A summary enable register.

Example

```
questionableRegister = 768
status.questionable.instrument.smua.enable = questionableRegister
```

Uses the decimal value to set bits B8 and bit B9 of the questionable status SMU A summary enable register.

Also see

[Questionable Status Registers](#) (on page 15-13)

[status.operation.*](#) (on page 11-281)

status.questionable.over_temperature.*

This attribute contains the questionable status over temperature summary register set.

Type	TSP-Link accessible	Affected by	Where saved	Default value
Attribute	--	--	--	--
.condition (R)	Yes	Not applicable	Not saved	Not applicable
.enable (RW)	Yes	Status reset	Not saved	0
.event (R)	Yes	Status reset	Not saved	0
.ntr (RW)	Yes	Status reset	Not saved	0
.ptr (RW)	Yes	Status reset	Not saved	2 (All bits set)

Usage

```
questionableRegister = status.questionable.over_temperature.condition
questionableRegister = status.questionable.over_temperature.enable
questionableRegister = status.questionable.over_temperature.event
questionableRegister = status.questionable.over_temperature.ntr
questionableRegister = status.questionable.over_temperature.ptr
status.questionable.over_temperature.enable = questionableRegister
status.questionable.over_temperature.ntr = questionableRegister
status.questionable.over_temperature.ptr = questionableRegister
```

<i>operationRegister</i>	The status of the questionable status over temperature summary register; a zero (0) indicates no bits set (also send 0 to clear all bits)
--------------------------	---

Details

These attributes are used to read or write to the questionable status over temperature summary registers. Reading a status register returns a value. The binary equivalent of the returned value indicates if a register bit is set. The least significant bit of the binary number is bit B0, and the most significant bit is bit B15.

For information about .condition, .enable, .event, .ntr, and .ptr registers, refer to [Status register set contents](#) (on page 15-1) and [Enable and transition registers](#) (on page 15-19). The individual bits of this register are defined in the following table.

Bit	Value
B0	Not used
B1	status.questionable.over_temperature.SMUA Set bit indicates that an over temperature condition was detected on SMU A. Bit B1 decimal value: 2 Binary value: 0000 0010
B2 to B15	Not used

As an example, to set bit B1 of the questionable status over temperature summary enable register, set `status.questionable.instrument.enable = status.questionable.instrument.SMUA`. You can also set the bit to its decimal value.

Example

```
status.questionable.over_temperature.enable =
status.questionable.over_temperature.SMUA
```

Uses the constant to set the SMU A over temperature summary enable bit of the questionable status register.

Also see

- [Questionable Status Registers](#) (on page 15-13)
- [status.questionable.*](#) (on page 11-316)

status.questionable.unstable_output.*

This attribute contains the questionable status unstable output summary register set.

Type	TSP-Link accessible	Affected by	Where saved	Default value
Attribute	--	--	--	--
.condition (R)	Yes	Not applicable	Not saved	Not applicable
.enable (RW)	Yes	Status reset	Not saved	0
.event (R)	Yes	Status reset	Not saved	0
.ntr (RW)	Yes	Status reset	Not saved	0
.ptr (RW)	Yes	Status reset	Not saved	2 (All bits set)

Usage

```
questionableRegister = status.questionable.unstable_output.condition
questionableRegister = status.questionable.unstable_output.enable
questionableRegister = status.questionable.unstable_output.event
questionableRegister = status.questionable.unstable_output.ntr
questionableRegister = status.questionable.unstable_output.ptr
status.questionable.unstable_output.enable = questionableRegister
status.questionable.unstable_output.ntr = questionableRegister
status.questionable.unstable_output.ptr = questionableRegister
```

<i>operationRegister</i>	The status of the questionable status unstable output summary register; a zero (0) indicates no bits set (also send 0 to clear all bits); the only other valid value is 2
--------------------------	---

Details

These attributes are used to read or write to the questionable status unstable output summary registers. Reading a status register returns a value. The binary equivalent of the returned value indicates which register bits are set. The least significant bit of the binary number is bit B0, and the most significant bit is bit B15.

For information about `.condition`, `.enable`, `.event`, `.ntr`, and `.ptr` registers, refer to [Status register set contents](#) (on page 15-1) and [Enable and transition registers](#) (on page 15-19). The individual bits of this register are defined in the following table.

Bit	Value and description
B0	Not used
B1	<code>status.questionable.unstable_output.SMUA</code> Set bit indicates that an unstable output condition was detected on SMU A. Bit B1 decimal value: 2 Binary value: 0000 0010
B2 to B15	Not used

As an example, to set bit B1 of the questionable status unstable output summary enable register, set `status.questionable.instrument.enable = status.questionable.instrument.SMUA`.

In addition to the above constant, `questionableRegister` can be set to the decimal value of the bit to set.

Example

```
status.questionable.unstable_output.enable =
status.questionable.unstable_output.SMUA
```

Uses the constant to set the SMU A bit in the questionable status unstable output summary enable register bit.

Also see

[Questionable Status Registers](#) (on page 15-13)
[status.questionable.*](#) (on page 11-316)

status.request_enable

This attribute stores the service request (SRQ) enable register.

Type	TSP-Link accessible	Affected by	Where saved	Default value
Attribute (RW)	Yes	Status reset	Not saved	0

Usage

```
requestSRQEnableRegister = status.request_enable
status.request_enable = requestSRQEnableRegister
```

<code>requestSRQEnableRegister</code>	The status of the service request (SRQ) enable register; a zero (0) indicates no bits set (also send 0 to clear all bits); other values indicate various bit settings
---------------------------------------	---

Details

This attribute is used to read or write to the service request enable register. Reading the service request enable register returns a value. The binary equivalent of the value of this attribute indicates which register bits are set. In the binary equivalent, the least significant bit is bit B0, and the most significant bit is bit B7. For example, if a value of 1.29000e+02 (which is 129) is read as the value of this register, the binary equivalent is 1000 0001. This value indicates that bit B0 and bit B7 are set.

B7	B6	B5	B4	B3	B2	B1	B0
**	>	>	>	>	>	>	*
1	0	0	0	0	0	0	1

* Least significant bit
 ** Most significant bit

For information about .condition, .enable, .event, .ntr, and .ptr registers, refer to [Status register set contents](#) (on page 15-1) and [Enable and transition registers](#) (on page 15-19). The individual bits of this register are defined in the following table.

Bit	Value and description
B0	status.MEASUREMENT_SUMMARY_BIT status.MSB Set summary bit indicates that an enabled event in the Measurement Event Register has occurred. Bit B0 decimal value: 1
B1	status.SYSTEM_SUMMARY_BIT status.SSB Set summary bit indicates that an enabled event in the System Summary Register has occurred. Bit B1 decimal value: 2
B2	status.ERROR_AVAILABLE status.EAV Set summary bit indicates that an error or status message is present in the error queue. Bit B2 decimal value: 4
B3	status.QUESTIONABLE_SUMMARY_BIT status.QSB Set summary bit indicates that an enabled event in the Questionable Status Register has occurred. Bit B3 decimal value: 8
B4	status.MESSAGE_AVAILABLE status.MAV Set summary bit indicates that a response message is present in the output queue. Bit B4 decimal value: 16
B5	status.EVENT_SUMMARY_BIT status.ESB Set summary bit indicates that an enabled event in the Standard Event Status Register has occurred. Bit B5 decimal value: 32
B6	Not used
B7	status.OPERATION_SUMMARY_BIT status.OSB Set summary bit indicates that an enabled event in the Operation Status Register has occurred. Bit B7 decimal value: 128

As an example, to set bit B0 of the service request enable register, set `status.request_enable = status.MSB`.

In addition to the above values, `requestSRQEnableRegister` can be set to the decimal value of the bit to set. To set more than one bit of the register, set `requestSRQEnableRegister` to the sum of their decimal values. For example, to set bits B0 and B7, set `requestSRQEnableRegister` to 129 (1 + 128).

Bit	B7	B6	B5	B4	B3	B2	B1	B0
Binary value	0/1	0/1	0/1	0/1	0/1	0/1	0/1	0/1
Decimal	128	64	32	16	8	4	2	1
Weights	(2 ⁷)	(2 ⁶)	(2 ⁵)	(2 ⁴)	(2 ³)	(2 ²)	(2 ¹)	(2 ⁰)

Example 1

```
requestSRQEnableRegister = status.MSB + status.OSB
status.request_enable = requestSRQEnableRegister
```

Uses constants to set the MSB and OSB bits of the service request (SRQ) enable register.

Example 2

```
-- decimal 129 = binary 10000001
requestSRQEnableRegister = 129
status.request_enable = requestSRQEnableRegister
```

Uses the decimal value to set the MSB and OSB bits of the service request (SRQ) enable register.

Also see

[Status byte and service request \(SRQ\)](#) (on page 15-15)
[status.condition](#) (on page 11-263)
[status.system.*](#) (on page 11-331)

status.request_event

This attribute stores the service request (SRQ) event register.

Type	TSP-Link accessible	Affected by	Where saved	Default value
Attribute (R)	Yes	Not applicable	Not saved	0

Usage

```
requestSRQEventRegister = status.request_event
```

`requestSRQEventRegister`

The status of the request event register; a zero (0) indicates no bits set; other values indicate various bit settings

Details

This attribute is used to read the service request event register, which is returned as a numeric value. Reading this register returns a value. The binary equivalent of the value of this attribute indicates which register bits are set. In the binary equivalent, the least significant bit is bit B0, and the most significant bit is bit B7. For example, if a value of `1.29000e+02` (which is 129) is read as the value of this register, the binary equivalent is 1000 0001. This value indicates that bit B0 and bit B7 are set.

B7	B6	B5	B4	B3	B2	B1	B0
**	>	>	>	>	>	>	*
1	0	0	0	0	0	0	1

* Least significant bit
 ** Most significant bit

The returned value can indicate one or more status events occurred.

For information about .condition, .enable, .event, .ntr, and .ptr registers, refer to [Status register set contents](#) (on page 15-1) and [Enable and transition registers](#) (on page 15-19). The individual bits of this register are defined in the following table.

Bit	Value and description
B0	status.MEASUREMENT_SUMMARY_BIT status.MSB Set summary bit indicates that an enabled event in the Measurement Event Register has occurred. Bit B0 decimal value: 1
B1	status.SYSTEM_SUMMARY_BIT status.SSB Set summary bit indicates that an enabled event in the System Summary Register has occurred. Bit B1 decimal value: 2
B2	status.ERROR_AVAILABLE status.EAV Set summary bit indicates that an error or status message is present in the error queue. Bit B2 decimal value: 4
B3	status.QUESTIONABLE_SUMMARY_BIT status.QSB Set summary bit indicates that an enabled event in the Questionable Status Register has occurred. Bit B3 decimal value: 8
B4	status.MESSAGE_AVAILABLE status.MAV Set summary bit indicates that a response message is present in the output queue. Bit B4 decimal value: 16
B5	status.EVENT_SUMMARY_BIT status.ESB Set summary bit indicates that an enabled event in the Standard Event Status Register has occurred. Bit B5 decimal value: 32
B6	Not used
B7	status.OPERATION_SUMMARY_BIT status.OSB Set summary bit indicates that an enabled event in the Operation Status Register has occurred. Bit B7 decimal value: 128

In addition to the above constants, *requestEventRegister* can be set to the decimal value of the bits set. When more than one bit of the register is set, *requestEventRegister* contains the sum of their decimal values. For example, if 129 is returned, bits B0 and B7 are set (1 + 128).

Bit	B7	B6	B5	B4	B3	B2	B1	B0
Binary value	0/1	0/1	0/1	0/1	0/1	0/1	0/1	0/1
Decimal	128	64	32	16	8	4	2	1
Weights	(2 ⁷)	(2 ⁶)	(2 ⁵)	(2 ⁴)	(2 ³)	(2 ²)	(2 ¹)	(2 ⁰)

Example

```
requestEventRegister = status.request_event
print(requestEventRegister)
```

Reads the status request event register.

Sample output:

```
1.29000e+02
```

Converting this output (129) to its binary equivalent yields 1000 0001.

Therefore, this output indicates that the set bits of the status request event register are presently B0 (MSB) and B7 (OSB).

Also see

[status.condition](#) (on page 11-263)

[status.system.*](#) (on page 11-331)

[Status byte and service request \(SRQ\)](#) (on page 15-15)

status.reset()

This function resets all bits in the status model.

Type	TSP-Link accessible	Affected by	Where saved	Default value
Function	Yes			

Usage

```
status.reset()
```

Details

This function clears all status data structure registers (enable, event, NTR, and PTR) to their default values. For information about `.condition`, `.enable`, `.event`, `.ntr`, and `.ptr` registers, refer to [Status register set contents](#) (on page 15-1) and [Enable and transition registers](#) (on page 15-19).

Example

```
status.reset()
```

Resets the instrument status model.

Also see

[Status model](#) (on page 15-1)

status.standard.*

These attributes manage the standard event status register set of the status model.

Type	TSP-Link accessible	Affected by	Where saved	Default value
Attribute	--	--	--	--
.condition (R)	Yes	Not applicable	Not saved	Not applicable
.enable (RW)	Yes	Status reset	Not saved	0
.event (R)	Yes	Status reset	Not saved	0
.ntr (RW)	Yes	Status reset	Not saved	0
.ptr (RW)	Yes	Status reset	Not saved	253 (All bits set)

Usage

```

standardRegister = status.standard.condition
standardRegister = status.standard.enable
standardRegister = status.standard.event
standardRegister = status.standard.ntr
standardRegister = status.standard.ptr
status.standard.enable = standardRegister
status.standard.ntr = standardRegister
status.standard.ptr = standardRegister
    
```

<i>standardRegister</i>	The status of the standard event status register; a zero (0) indicates no bits set (also send 0 to clear all bits); other values indicate various bit settings
-------------------------	--

Details

These attributes are used to read or write to the standard event status registers. Reading a status register returns a value. The binary equivalent of the returned value indicates which register bits are set. The least significant bit of the binary number is bit B0, and the most significant bit is bit B15. For example, if a value of 1.29000e+02 (which is 129) is read as the value of the condition register, the binary equivalent is 0000 0000 1000 0001. This value indicates that bit B0 and bit B7 are set.

B15	B14	B13	B12	B11	B10	B9	B8	B7	B6	B5	B4	B3	B2	B1	B0
**	>	>	>	>	>	>	>	>	>	>	>	>	>	>	*
0	0	0	0	0	0	0	0	1	0	0	0	0	0	0	1

- * Least significant bit
- ** Most significant bit

For information about .condition, .enable, .event, .ntr, and .ptr registers, refer to [Status register set contents](#) (on page 15-1) and [Enable and transition registers](#) (on page 15-19). The individual bits of this register are defined in the following table.

Bit	Value
B0	status.standard.OPERATION_COMPLETE status.standard.OPC Set bit indicates that all pending selected instrument operations are completed and the instrument is ready to accept new commands. The bit is set in response to an *OPC command. The <code>opc ()</code> function can be used in place of the *OPC command. Bit B0 decimal value: 1
B1	Not used

Bit	Value
B2	<code>status.standard.QUERY_ERROR</code> <code>status.standard.QYE</code> Set bit indicates that you attempted to read data from an empty Output Queue. Bit B2 decimal value: 4
B3	<code>status.standard.DEVICE_DEPENDENT_ERROR</code> <code>status.standard.DDE</code> Set bit indicates that an instrument operation did not execute properly due to some internal condition. Bit B3 decimal value: 8
B4	<code>status.standard.EXECUTION_ERROR</code> <code>status.standard.EXE</code> Set bit indicates that the instrument detected an error while trying to execute a command. Bit B4 decimal value: 16
B5	<code>status.standard.COMMAND_ERROR</code> <code>status.standard.CME</code> Set bit indicates that a command error has occurred. Command errors include: IEEE Std 488.2 syntax error: Instrument received a message that does not follow the defined syntax of the IEEE Std 488.2 standard. Semantic error: Instrument received a command that was misspelled or received an optional IEEE Std 488.2 command that is not implemented. GET error: The instrument received a Group Execute Trigger (GET) inside a program message. Bit B5 decimal value: 32
B6	<code>status.standard.USER_REQUEST</code> <code>status.standard.URQ</code> Set bit indicates that the LOCAL key on the instrument front panel was pressed. Bit B6 decimal value: 64
B7	<code>status.standard.POWER_ON</code> <code>status.standard.PON</code> Set bit indicates that the instrument has been turned off and turned back on since the last time this register has been read. Bit B7 decimal value: 128
B8 to B15	Not used

As an example, to set bit B0 of the standard event status enable register, set `status.standard.enable = status.standard.OPC`.

In addition to the above constants, `standardRegister` can be set to the numeric equivalent of the bit to set. To set more than one bit of the register, set `standardRegister` to the sum of their decimal weights. For example, to set bits B0 and B4, set `standardRegister` to 17 (which is the sum of 1 + 16).

Bit	B7	B6	B5	B4	B3	B2	B1	B0
Binary value	0/1	0/1	0/1	0/1	0/1	0/1	0/1	0/1
Decimal	128	64	32	16	8	4	2	1
Weights	(2 ⁷)	(2 ⁶)	(2 ⁵)	(2 ⁴)	(2 ³)	(2 ²)	(2 ¹)	(2 ⁰)

Example 1

```
standardRegister = status.standard.OPC + status.standard.EXE
status.standard.enable = standardRegister
```

Uses constants to set the OPC and EXE bits of the standard event status enable register.

Example 2

```
-- decimal 17 = binary 0001 0001
standardRegister = 17
status.standard.enable = standardRegister
```

Uses the decimal value to set the OPC and EXE bits of the standard event status enable register.

Also see

[Standard Event Register](#) (on page 15-21)

status.system.*

These attributes manage the TSP-Link® system summary register of the status model for nodes 1 through 14.

Type	TSP-Link accessible	Affected by	Where saved	Default value
Attribute	--	--	--	--
.condition (R)	Yes	Not applicable	Not saved	Not applicable
.enable (RW)	Yes	Status reset	Not saved	0
.event (R)	Yes	Status reset	Not saved	0
.ntr (RW)	Yes	Status reset	Not saved	0
.ptr (RW)	Yes	Status reset	Not saved	32,767 (All bits set)

Usage

```
enableRegister = status.system.condition
enableRegister = status.system.enable
enableRegister = status.system.event
enableRegister = status.system.ntr
enableRegister = status.system.ptr
status.system.enable = enableRegister
status.system.ntr = enableRegister
status.system.ptr = enableRegister
```

<i>enableRegister</i>	The status of the system summary register; a zero (0) indicates no bits set; other values indicate various bit settings
-----------------------	---

Details

In an expanded system (TSP-Link), these attributes are used to read or write to the system summary registers. They are set using a constant or a numeric value but are returned as a numeric value. The binary equivalent of the value indicates which register bits are set. In the binary equivalent, the least significant bit is bit B0, and the most significant bit is bit B15. For example, if a value of 1.29000e+02 (which is 129) is read as the value of the condition register, the binary equivalent is 0000 0000 1000 0001. This value indicates that bit B0 and bit B7 are set.

B15	B14	B13	B12	B11	B10	B9	B8	B7	B6	B5	B4	B3	B2	B1	B0
**	>	>	>	>	>	>	>	>	>	>	>	>	>	>	*
0	0	0	0	0	0	0	0	1	0	0	0	0	0	0	1

* Least significant bit
 ** Most significant bit

For information about .condition, .enable, .event, .ntr, and .ptr registers, refer to [Status register set contents](#) (on page 15-1) and [Enable and transition registers](#) (on page 15-19). The individual bits of this register are defined in the following table.

Bit	Value	Decimal value
B0	status.system.EXTENSION_BIT status.system.EXT	1
B1	status.system.NODE1	2
B2	status.system.NODE2	4
B3	status.system.NODE3	8
B4	status.system.NODE4	16
B5	status.system.NODE5	32
B6	status.system.NODE6	64
B7	status.system.NODE7	128
B8	status.system.NODE8	256
B9	status.system.NODE9	512
B10	status.system.NODE10	1,024
B11	status.system.NODE11	2,048
B12	status.system.NODE12	4,096
B13	status.system.NODE13	8,192
B14	status.system.NODE14	16,384
B15	Not used	Not applicable

As an example, to set bit B0 of the system summary status enable register, set `status.system.enable = status.system.enable.EXT`.

In addition to the above constants, *enableRegister* can be set to the decimal value of the bit to set. To set more than one bit of the register, set *enableRegister* to the sum of their decimal values. For example, to set bits B11 and B14, set *enableRegister* to 18,432 (which is the sum of 2,048 + 16,384).

Bit	B7	B6	B5	B4	B3	B2	B1	B0
Binary value	0/1	0/1	0/1	0/1	0/1	0/1	0/1	0/1
Decimal	128	64	32	16	8	4	2	1
Weights	(2 ⁷)	(2 ⁶)	(2 ⁵)	(2 ⁴)	(2 ³)	(2 ²)	(2 ¹)	(2 ⁰)

Bit	B15	B14	B13	B12	B11	B10	B9	B8
Binary value	0/1	0/1	0/1	0/1	0/1	0/1	0/1	0/1
Decimal	32,768	16,384	8,192	4,096	2,048	1,024	512	256
Weights	(2 ¹⁵)	(2 ¹⁴)	(2 ¹³)	(2 ¹²)	(2 ¹¹)	(2 ¹⁰)	(2 ⁹)	(2 ⁸)

Example 1

```
enableRegister = status.system.NODE11 + status.system.NODE14
status.system.enable = enableRegister
```

Uses constants to set bits B11 and B14 of the system summary enable register.

Example 2

```
-- decimal 18432 = binary 0100 1000 0000 0000
enableRegister = 18432
status.system.enable = enableRegister
```

Uses the decimal value to set bits B11 and B14 of the system summary enable register.

Also see

- [status.system2.*](#) (on page 11-333)
- [System summary and standard event registers](#) (on page 15-6)

status.system2.*

These attributes manage the TSP-Link® system summary register of the status model for nodes 15 through 28.

Type	TSP-Link accessible	Affected by	Where saved	Default value
Attribute	--	--	--	--
.condition (R)	Yes	Not applicable	Not saved	Not applicable
.enable (RW)	Yes	Status reset	Not saved	0
.event (R)	Yes	Status reset	Not saved	0
.ntr (RW)	Yes	Status reset	Not saved	0
.ptr (RW)	Yes	Status reset	Not saved	32,767 (All bits set)

Usage

```
enableRegister = status.system2.condition
enableRegister = status.system2.enable
enableRegister = status.system2.event
enableRegister = status.system2.ntr
enableRegister = status.system2.ptr
status.system2.enable = enableRegister
status.system2.ntr = enableRegister
status.system2.ptr = enableRegister
```

<i>enableRegister</i>	The status of the system summary 2 register; a zero (0) indicates no bits set; other values indicate various bit settings
-----------------------	---

Details

In an expanded system (TSP-Link), these attributes are used to read or write to the system summary registers. They are set using a constant or a numeric value but are returned as a numeric value. The binary equivalent of the value indicates which register bits are set. In the binary equivalent, the least significant bit is bit B0, and the most significant bit is bit B15. For example, if a value of $1.29000e+02$ (which is 129) is read as the value of the condition register, the binary equivalent is 0000 0000 1000 0001. This value indicates that bit B0 and bit B7 are set.

B15	B14	B13	B12	B11	B10	B9	B8	B7	B6	B5	B4	B3	B2	B1	B0
**	>	>	>	>	>	>	>	>	>	>	>	>	>	>	*
0	0	0	0	0	0	0	0	1	0	0	0	0	0	0	1

* Least significant bit

** Most significant bit

For information about .condition, .enable, .event, .ntr, and .ptr registers, refer to [Status register set contents](#) (on page 15-1) and [Enable and transition registers](#) (on page 15-19). The individual bits of this register are defined in the following table.

Bit	Value	Decimal value
B0	status.system2.EXTENSION_BIT status.system2.EXT	1
B1	status.system2.NODE15	2
B2	status.system2.NODE16	4
B3	status.system2.NODE17	8
B4	status.system2.NODE18	16
B5	status.system2.NODE19	32
B6	status.system2.NODE20	64
B7	status.system2.NODE21	128
B8	status.system2.NODE22	256
B9	status.system2.NODE23	512
B10	status.system2.NODE24	1,024
B11	status.system2.NODE25	2,048
B12	status.system2.NODE26	4,096
B13	status.system2.NODE27	8,192
B14	status.system2.NODE28	16,384
B15	Not used	Not applicable

As an example, to set bit B0 of the system summary 2 enable register, set `status.system2.enable = status.system2.EXT`.

In addition to the above constants, `enableRegister` can be set to the decimal value of the bit to set. To set more than one bit of the register, set `enableRegister` to the sum of their decimal values. For example, to set bits B11 and B14, set `enableRegister` to 18,432 (which is the sum of 2,048 + 16,384).

Bit	B7	B6	B5	B4	B3	B2	B1	B0
Binary value	0/1	0/1	0/1	0/1	0/1	0/1	0/1	0/1
Decimal	128	64	32	16	8	4	2	1
Weights	(2 ⁷)	(2 ⁶)	(2 ⁵)	(2 ⁴)	(2 ³)	(2 ²)	(2 ¹)	(2 ⁰)

Bit	B15	B14	B13	B12	B11	B10	B9	B8
Binary value	0/1	0/1	0/1	0/1	0/1	0/1	0/1	0/1
Decimal	32,768	16,384	8,192	4,096	2,048	1,024	512	256
Weights	(2 ¹⁵)	(2 ¹⁴)	(2 ¹³)	(2 ¹²)	(2 ¹¹)	(2 ¹⁰)	(2 ⁹)	(2 ⁸)

Example 1

```
enableRegister = status.system2.NODE25 + status.system2.NODE28
status.system2.enable = enableRegister
```

Uses constants to set bits B11 and B14 of the system summary 2 enable register.

Example 2

```
-- decimal 18432 = binary 0100 1000 0000 0000
enableRegister = 18432
status.system2.enable = enableRegister
```

Uses the decimal value to set bits B11 and B14 of the system summary 2 enable register.

Also see

- [status.system.*](#) (on page 11-331)
- [status.system3.*](#) (on page 11-335)
- [System summary and standard event registers](#) (on page 15-6)

status.system3.*

These attributes manage the TSP-Link® system summary register of the status model for nodes 29 through 42.

Type	TSP-Link accessible	Affected by	Where saved	Default value
Attribute	--	--	--	--
.condition (R)	Yes	Not applicable	Not saved	Not applicable
.enable (RW)	Yes	Status reset	Not saved	0
.event (R)	Yes	Status reset	Not saved	0
.ntr (RW)	Yes	Status reset	Not saved	0
.ptr (RW)	Yes	Status reset	Not saved	32,767 (All bits set)

Usage

```
enableRegister = status.system3.condition
enableRegister = status.system3.enable
enableRegister = status.system3.event
enableRegister = status.system3.ntr
enableRegister = status.system3.ptr
status.system3.enable = enableRegister
status.system3.ntr = enableRegister
status.system3.ptr = enableRegister
```

<i>enableRegister</i>	The status of the system summary 3 register; a zero (0) indicates no bits set; other values indicate various bit settings
-----------------------	---

Details

In an expanded system (TSP-Link), these attributes are used to read or write to the system summary registers. They are set using a constant or a numeric value but are returned as a numeric value. The binary equivalent of the value indicates which register bits are set. In the binary equivalent, the least significant bit is bit B0 and the most significant bit is bit B15. For example, if a value of $1.29000e+02$ (which is 129) is read as the value of the condition register, the binary equivalent is 0000 0000 1000 0001. This value indicates that bit B0 and bit B7 are set.

B15	B14	B13	B12	B11	B10	B9	B8	B7	B6	B5	B4	B3	B2	B1	B0
**	>	>	>	>	>	>	>	>	>	>	>	>	>	>	*
0	0	0	0	0	0	0	0	1	0	0	0	0	0	0	1

* Least significant bit

** Most significant bit

For information about `.condition`, `.enable`, `.event`, `.ntr`, and `.ptr` registers, refer to [Status register set contents](#) (on page 15-1) and [Enable and transition registers](#) (on page 15-19). The individual bits of this register are defined in the following table.

Bit	Value	Decimal value
B0	<code>status.system3.EXTENSION_BIT</code> <code>status.system3.EXT</code>	1
B1	<code>status.system3.NODE29</code>	2
B2	<code>status.system3.NODE30</code>	4
B3	<code>status.system3.NODE31</code>	8
B4	<code>status.system3.NODE32</code>	16
B5	<code>status.system3.NODE33</code>	32
B6	<code>status.system3.NODE34</code>	64
B7	<code>status.system3.NODE35</code>	128
B8	<code>status.system3.NODE36</code>	256
B9	<code>status.system3.NODE37</code>	512
B10	<code>status.system3.NODE38</code>	1,024
B11	<code>status.system3.NODE39</code>	2,048
B12	<code>status.system3.NODE40</code>	4,096
B13	<code>status.system3.NODE41</code>	8,192

Bit	Value	Decimal value
B14	status.system3.NODE42	16,384
B15	Not used	Not applicable

As an example, to set bit B0 of the system summary 3 enable register, set `status.system3.enable = status.system3.EXT`.

In addition to the above constants, *enableRegister* can be set to the decimal value of the bit to set. To set more than one bit of the register, set *enableRegister* to the sum of their decimal values. For example, to set bits B11 and B14, set *enableRegister* to 18,432 (which is the sum of 2,048 + 16,384).

Bit	B7	B6	B5	B4	B3	B2	B1	B0
Binary value	0/1	0/1	0/1	0/1	0/1	0/1	0/1	0/1
Decimal	128	64	32	16	8	4	2	1
Weights	(2 ⁷)	(2 ⁶)	(2 ⁵)	(2 ⁴)	(2 ³)	(2 ²)	(2 ¹)	(2 ⁰)

Bit	B15	B14	B13	B12	B11	B10	B9	B8
Binary value	0/1	0/1	0/1	0/1	0/1	0/1	0/1	0/1
Decimal	32,768	16,384	8,192	4,096	2,048	1,024	512	256
Weights	(2 ¹⁵)	(2 ¹⁴)	(2 ¹³)	(2 ¹²)	(2 ¹¹)	(2 ¹⁰)	(2 ⁹)	(2 ⁸)

Example 1

```
enableRegister = status.system3.NODE39 + status.system3.NODE42
status.system3.enable = enableRegister
```

Uses constants to set bits B11 and B14 of the system summary 3 enable register.

Example 2

```
-- decimal 18432 = binary 0100 1000 0000 0000
enableRegister = 18432
status.system3.enable = enableRegister
```

Uses the decimal value to set bits B11 and B14 of the system summary 3 enable register.

Also see

- [status.system2.*](#) (on page 11-333)
- [status.system4.*](#) (on page 11-338)
- [System summary and standard event registers](#) (on page 15-6)

status.system4.*

These attributes manage the TSP-Link® system summary register of the status model for nodes 43 through 56.

Type	TSP-Link accessible	Affected by	Where saved	Default value
Attribute	--	--	--	--
.condition (R)	Yes	Not applicable	Not saved	Not applicable
.enable (RW)	Yes	Status reset	Not saved	0
.event (R)	Yes	Status reset	Not saved	0
.ntr (RW)	Yes	Status reset	Not saved	0
.ptr (RW)	Yes	Status reset	Not saved	32,767 (All bits set)

Usage

```
enableRegister = status.system4.condition
enableRegister = status.system4.enable
enableRegister = status.system4.event
enableRegister = status.system4.ntr
enableRegister = status.system4.ptr
status.system4.enable = enableRegister
status.system4.ntr = enableRegister
status.system4.ptr = enableRegister
```

<i>enableRegister</i>	The status of the system summary 4 register; a zero (0) indicates no bits set; other values indicate various bit settings
-----------------------	---

Details

In an expanded system (TSP-Link), these attributes are used to read or write to the system summary registers. They are set using a constant or a numeric value but are returned as a numeric value. The binary equivalent of the value indicates which register bits are set. In the binary equivalent, the least significant bit is bit B0, and the most significant bit is bit B15. For example, if a value of $1.29000e+02$ (which is 129) is read as the value of the condition register, the binary equivalent is 0000 0000 1000 0001. This value indicates that bit B0 and bit B7 are set.

B15	B14	B13	B12	B11	B10	B9	B8	B7	B6	B5	B4	B3	B2	B1	B0
**	>	>	>	>	>	>	>	>	>	>	>	>	>	>	*
0	0	0	0	0	0	0	0	1	0	0	0	0	0	0	1

* Least significant bit

** Most significant bit

For information about .condition, .enable, .event, .ntr, and .ptr registers, refer to [Status register set contents](#) (on page 15-1) and [Enable and transition registers](#) (on page 15-19). The individual bits of this register are defined in the following table.

Bit	Value	Decimal value
B0	status.system4.EXTENSION_BIT status.system4.EXT	1
B1	status.system4.NODE43	2
B2	status.system4.NODE44	4
B3	status.system4.NODE45	8
B4	status.system4.NODE46	16
B5	status.system4.NODE47	32

Bit	Value	Decimal value
B6	status.system4.NODE48	64
B7	status.system4.NODE49	128
B8	status.system4.NODE50	256
B9	status.system4.NODE51	512
B10	status.system4.NODE52	1,024
B11	status.system4.NODE53	2,048
B12	status.system4.NODE54	4,096
B13	status.system4.NODE55	8,192
B14	status.system4.NODE56	16,384
B15	Not used	Not applicable

As an example, to set bit B0 of the system summary 4 enable register, set `status.system4.enable = status.system4.enable.EXT`.

In addition to the above constants, `enableRegister` can be set to the decimal value of the bit to set. To set more than one bit of the register, set `enableRegister` to the sum of their decimal values. For example, to set bits B11 and B14, set `enableRegister` to 18,432 (which is the sum of 2,048 + 16,384).

Bit	B7	B6	B5	B4	B3	B2	B1	B0
Binary value	0/1	0/1	0/1	0/1	0/1	0/1	0/1	0/1
Decimal	128	64	32	16	8	4	2	1
Weights	(2 ⁷)	(2 ⁶)	(2 ⁵)	(2 ⁴)	(2 ³)	(2 ²)	(2 ¹)	(2 ⁰)

Bit	B15	B14	B13	B12	B11	B10	B9	B8
Binary value	0/1	0/1	0/1	0/1	0/1	0/1	0/1	0/1
Decimal	32,768	16,384	8,192	4,096	2,048	1,024	512	256
Weights	(2 ¹⁵)	(2 ¹⁴)	(2 ¹³)	(2 ¹²)	(2 ¹¹)	(2 ¹⁰)	(2 ⁹)	(2 ⁸)

Example 1

```
enableRegister = status.system4.NODE53 + status.system4.NODE56
status.system2.enable = enableRegister
```

Uses constants to set bit B11 and bit B14 of the system summary 4 enable register.

Example 2

```
-- decimal 18432 = binary 0100 1000 0000 0000
enableRegister = 18432
status.system4.enable = enableRegister
```

Uses a decimal value to set bit B11 and bit B14 of the system summary 4 enable register.

Also see

- [status.system3.*](#) (on page 11-335)
- [status.system5.*](#) (on page 11-340)
- [System summary and standard event registers](#) (on page 15-6)

status.system5.*

These attributes manage the TSP-Link® system summary register of the status model for nodes 57 through 64.

Type	TSP-Link accessible	Affected by	Where saved	Default value
Attribute	--	--	--	--
.condition (R)	Yes	Not applicable	Not saved	Not applicable
.enable (RW)	Yes	Status reset	Not saved	0
.event (R)	Yes	Status reset	Not saved	0
.ntr (RW)	Yes	Status reset	Not saved	0
.ptr (RW)	Yes	Status reset	Not saved	510 (All bits set)

Usage

```
enableRegister = status.system5.condition
enableRegister = status.system5.enable
enableRegister = status.system5.event
enableRegister = status.system5.ntr
enableRegister = status.system5.ptr
status.system5.enable = enableRegister
status.system5.ntr = enableRegister
status.system5.ptr = enableRegister
```

<i>enableRegister</i>	The status of the system summary 5 register; a zero (0) indicates no bits set; other values indicate various bit settings
-----------------------	---

Details

In an expanded system (TSP-Link), these attributes are used to read or write to the system summary registers. They are set using a constant or a numeric value, but are returned as a numeric value. The binary equivalent of the value indicates which register bits are set. In the binary equivalent, the least significant bit is bit B0, and the most significant bit is bit B15. For example, if a value of 1.30000e+02 (which is 130) is read as the value of the condition register, the binary equivalent is 0000 0000 1000 0010. This value indicates that bit B1 and bit B7 are set.

B15	B14	B13	B12	B11	B10	B9	B8	B7	B6	B5	B4	B3	B2	B1	B0
**	>	>	>	>	>	>	>	>	>	>	>	>	>	>	*
0	0	0	0	0	0	0	0	1	0	0	0	0	0	1	0

* Least significant bit

** Most significant bit

For information about .condition, .enable, .event, .ntr, and .ptr registers, refer to [Status register set contents](#) (on page 15-1) and [Enable and transition registers](#) (on page 15-19). The individual bits of this register are defined in the following table.

Bit	Value	Decimal value
B0	Not used	Not applicable
B1	status.system5.NODE57	2
B2	status.system5.NODE58	4
B3	status.system5.NODE59	8
B4	status.system5.NODE60	16

Bit	Value	Decimal value
B5	<code>status.system5.NODE61</code>	32
B6	<code>status.system5.NODE62</code>	64
B7	<code>status.system5.NODE63</code>	128
B8	<code>status.system5.NODE64</code>	256
B9 to B15	Not used	Not applicable

As an example, to set bit B1 of the system summary 5 enable register, set `status.system5.enable = status.system5.NODE57`.

In addition to the above constants, *enableRegister* can be set to the numeric equivalent of the bit to set. To set more than one bit of the register, set *enableRegister* to the sum of their decimal weights. For example, to set bits B1 and B4, set *enableRegister* to 18 (which is the sum of 2 + 16).

Bit	B7	B6	B5	B4	B3	B2	B1	B0
Binary value	0/1	0/1	0/1	0/1	0/1	0/1	0/1	0/1
Decimal	128	64	32	16	8	4	2	1
Weights	(2 ⁷)	(2 ⁶)	(2 ⁵)	(2 ⁴)	(2 ³)	(2 ²)	(2 ¹)	(2 ⁰)

Bit	B15	B14	B13	B12	B11	B10	B9	B8
Binary value	0/1	0/1	0/1	0/1	0/1	0/1	0/1	0/1
Decimal	32,768	16,384	8,192	4,096	2,048	1,024	512	256
Weights	(2 ¹⁵)	(2 ¹⁴)	(2 ¹³)	(2 ¹²)	(2 ¹¹)	(2 ¹⁰)	(2 ⁹)	(2 ⁸)

Example 1

```
enableRegister = status.system5.NODE57 + status.system5.NODE60
status.system2.enable = enableRegister
```

Uses constants to set bits B1 and B4 of the system summary 5 enable register.

Example 2

```
-- decimal 18 = binary 0000 0000 0001 0010
enableRegister = 18
status.system5.enable = enableRegister
```

Uses the decimal value to set bits B1 and B4 of the system summary 5 enable register.

Also see

[status.system4.*](#) (on page 11-338)

[System summary and standard event registers](#) (on page 15-6)

SweepLinMeasureV()

This KISweep factory script function performs a linear current sweep with voltage measured at every step (point).

Type	TSP-Link accessible	Affected by	Where saved	Default value
Function	No			

Usage

`SweepLinMeasureV(smua, starti, stopi, stime, points)`

<code>starti</code>	Sweep start current in amperes
<code>stopi</code>	Sweep stop current in amperes
<code>stime</code>	Settling time in seconds; occurs after stepping the source and before making a measurement
<code>points</code>	Number of sweep points (must be ≥ 2)

Details

Data for voltage measurements, current source values, and timestamps are stored in `smua.nvbuffer1`.

If all parameters are omitted when this function is called, this function is executed with the parameters set to the default values.

Performs a linear current sweep with voltage measured at every step (point):

1. Sets the SMU to output `starti` amperes, allows the source to settle for `stime` seconds, and then makes a voltage measurement.
2. Sets the SMU to output the next amperes step, allows the source to settle for `stime` seconds, and then makes a voltage measurement.
3. Repeats the above sequence until the voltage is measured on the `stopi` amperes step.

The linear step size is automatically calculated as follows:

$$step = (stopi - starti) / (points - 1)$$

Figure 145: SweepLinMeasureV()

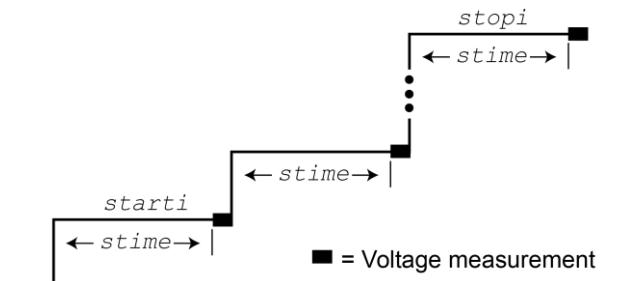

Example

```
SweepILinMeasureV(smua, -1e-3, 1e-3, 0, 100)
```

This function performs a 100-point linear current sweep starting at -1 mA and stopping at +1 mA. Voltage is measured at every step (point) in the sweep. Because *stime* is set for 0 s, voltage is measured as quickly as possible after each current step.

Also see

[KISweep factory script](#) (on page 9-21)

SweepIListMeasureV()

This KISweep factory script function performs a current list sweep with voltage measured at every step (point).

Type	TSP-Link accessible	Affected by	Where saved	Default value
Function	No			

Usage

```
SweepIListMeasureV(smua, ilist, stime, points)
```

<i>ilist</i>	Arbitrary list of current source values; <i>ilist</i> = {value1, value2, ...valueN}
<i>stime</i>	Settling time in seconds; occurs after stepping the source and before making a measurement
<i>points</i>	Number of sweep points (must be ≥ 2)

Details

Data for voltage measurements, current source values, and timestamps are stored in `smua.nvbuffer1`.

If all parameters are omitted when this function is called, this function is executed with the parameters set to the default values.

Performs a current list sweep with voltage measured at every step (point):

1. Sets the SMU to output *ilist* amperes value, allows the source to settle for *stime* seconds, and then performs a voltage measurement.
2. Sets the SMU to output the next *ilist* step, allows the source to settle for *stime* seconds, and then performs a voltage measurement.
3. Repeats the above sequence until the voltage is measured for the last amperes value. The last point in the list to be measured is *points*.

Example

```
testilist = {-100e-9, 100e-9, -1e-6, 1e-6, -1e-3, 1e-3}
```

```
SweepIListMeasureV(smua, testilist, 500e-3, 6)
```

This function performs a six-point current list sweep starting at the first point in `testilist`. Voltage is measured at every step (point) in the sweep. The source is allowed to settle on each step for 500 ms before a measurement is performed.

Also see

[KISweep factory script](#) (on page 9-21)

SweepILogMeasureV()

This KISweep factory script function performs a logarithmic current sweep with voltage measured at every step (point).

Type	TSP-Link accessible	Affected by	Where saved	Default value
Function	No			

Usage

```
SweepILogMeasureV(smua, starti, stopi, stime, points)
```

<i>starti</i>	Sweep start current in amperes
<i>stopi</i>	Sweep stop current in amperes
<i>stime</i>	Settling time in seconds; occurs after stepping the source and before making a measurement
<i>points</i>	Number of sweep points (must be ≥ 2)

Details

Data for voltage measurements, current source values, and timestamps are stored in `smua.nvbuffer1`.

If all parameters are omitted when this function is called, this function is executed with the parameters set to the default values.

Performs a logarithmic current sweep with voltage measured at every step (point):

1. Sets the SMU to output *starti* amperes value, allows the source to settle for *stime* seconds, and then performs a voltage measurement.
2. Sets the SMU to output the next amperes step, allows the source to settle for *stime* seconds, and then performs a voltage measurement.
3. Repeats the above sequence until the voltage is measured on the *stopi* amperes step.

The source level at each step (`SourceStepLevel`) is automatically calculated as follows:

$$\text{MeasurePoint} = \text{The step point number for a measurement}$$

For example, for a five-point sweep ($\text{points} = 5$), a measurement is performed at *MeasurePoint* 1, 2, 3, 4, and 5.

$$\text{LogStepSize} = (\log_{10}(\text{stopi}) - \log_{10}(\text{starti})) / (\text{points} - 1)$$

$$\text{LogStep} = (\text{MeasurePoint} - 1) * (\text{LogStepSize})$$

$$\text{SourceStepLevel} = \text{antilog}(\text{LogStep}) * \text{starti}$$

Figure 146: SweepLogMeasureV()

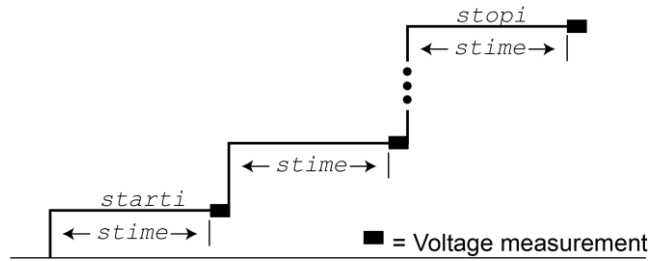

Example

```
SweepILogMeasureV(smua, 0.01, 0.1, 0.001, 5)
```

This function performs a five-point linear current sweep starting at 10 mA and stopping at 100 mA. Voltage is measured at every step (point) in the sweep. The source is allowed to settle on each step for 1 ms before a measurement is made.

The following table contains log values and corresponding source levels for the five-point logarithmic sweep:

MeasurePoint	LogStepSize	LogStep	SourceStepLevel
1	0.25	0.0	0.01 A
2	0.25	0.25	0.017783 A
3	0.25	0.5	0.031623 A
4	0.25	0.75	0.056234 A
5	0.25	1.0	0.1 A

Also see

[KISweep factory script](#) (on page 9-21)

SweepVLinMeasureI()

This KISweep factory script function performs a linear voltage sweep with current measured at every step (point).

Type	TSP-Link accessible	Affected by	Where saved	Default value
Function	No			

Usage

```
SweepVLinMeasureI(smua, startv, stopv, stime, points)
```

<i>startv</i>	Sweep start voltage in volts
<i>stopv</i>	Sweep stop voltage in volts
<i>stime</i>	Settling time in seconds; occurs after stepping the source and before making a measurement
<i>points</i>	Number of sweep points (must be ≥ 2)

Details

Data for current measurements, voltage source values, and timestamps are stored in `smua.nvbuffer1`.

If all parameters are omitted when this function is called, this function is executed with the parameters set to the default values.

Performs a linear voltage sweep with current measured at every step (point):

1. Sets the SMU to output *startv* amperes, allows the source to settle for *stime* seconds, and then makes a current measurement.
2. Sets the SMU to output the next amperes step, allows the source to settle for *stime* seconds, and then makes a voltage measurement.
3. Repeats the above sequence until the voltage is measured on the *stopv* amperes step.

The linear step size is automatically calculated as follows:

$$step = (stopv - startv) / (points - 1)$$

Figure 147: SweepVLinMeasureI()

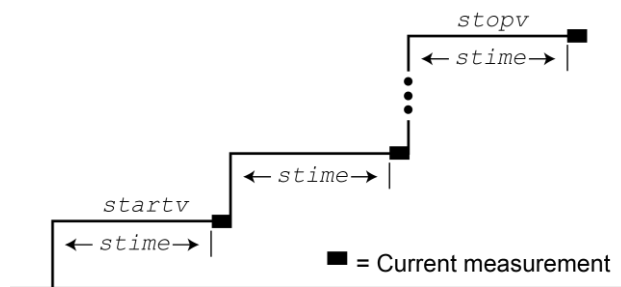

Example

```
SweepVLinMeasureI(smua, -1, 1, 1e-3, 1000)
```

This function performs a 1000-point linear voltage sweep starting at -1 V and stopping at +1 V. Current is measured at every step (point) in the sweep after a 1 ms source settling period.

Also see

[KISweep factory script](#) (on page 9-21)

SweepVListMeasureI()

This KISweep factory script function performs a voltage list sweep with current measured at every step (point).

Type	TSP-Link accessible	Affected by	Where saved	Default value
Function	No			

Usage

```
SweepVListMeasureI(smua, vlist, stime, points)
```

<i>vlist</i>	Arbitrary list of voltage source values; <i>vlist</i> = {value1, value2, ... valueN}
<i>stime</i>	Settling time in seconds; occurs after stepping the source and before making a measurement
<i>points</i>	Number of sweep points (must be ≥ 2)

Details

Data for current measurements, voltage source values, and timestamps are stored in `smua.nvbuffer1`.

If all parameters are omitted when this function is called, this function is executed with the parameters set to the default values.

Performs a voltage list sweep with current measured at every step (point):

1. Sets the SMU to output *vlist* volts value, allows the source to settle for *stime* seconds, and then performs a current measurement.
2. Sets the SMU to output the next *vlist* volts value, allows the source to settle for *stime* seconds, and then performs a current measurement.
3. Repeats the above sequence until the current is measured for the last volts value. The last point in the list to be measured is *points*.

Example

```
myvlist = {-0.1, 0.1, -1, 1, -6, 6, -40, 40, 0, 0}
SweepVListMeasureI(smua, myvlist, 500E-3, 10)
```

This function performs a 10-point voltage list sweep starting at the first point in `myvlist`. Current is measured at every step (point) in the sweep. The source will be allowed to settle on each step for 500 ms before a measurement is performed.

Also see

[KISweep factory script](#) (on page 9-21)

SweepVLogMeasureI()

This KISweep factory script function performs a logarithmic voltage sweep with current measured at every step (point).

Type	TSP-Link accessible	Affected by	Where saved	Default value
Function	No			

Usage

```
SweepVLogMeasureI(smua, startv, stopv, stime, points)
```

<i>startv</i>	Sweep start voltage in volts
<i>stopv</i>	Sweep stop voltage in volts
<i>stime</i>	Settling time in seconds; occurs after stepping the source and before making a measurement
<i>points</i>	Number of sweep points (must be ≥ 2)

Details

Data for current measurements, voltage source values, and timestamps are stored in `smua.nvbuffer1`.

If all parameters are omitted when this function is called, this function is executed with the parameters set to the default values.

Performs a logarithmic voltage sweep with current measured at every step (point):

1. Sets the SMU to output *startv* amperes, allows the source to settle for *stime* seconds, and then makes a current measurement.
2. Sets the SMU to output the next volts step, allows the source to settle for *stime* seconds, and then makes a current measurement.
3. Repeats the above sequence until the voltage is measured on the *stopv* volts step.

The source level at each step (*SourceStepLevel*) is automatically calculated as follows:

$$\text{MeasurePoint} = \text{The step point number for a measurement}$$

For example, for a five-point sweep (*points* = 5), a measurement is made at *MeasurePoint* 1, 2, 3, 4, and 5.

$$\text{LogStepSize} = (\log_{10}(\text{stopv}) - \log_{10}(\text{startv})) / (\text{points} - 1)$$

$$\text{LogStep} = (\text{MeasurePoint} - 1) * (\text{LogStepSize})$$

$$\text{SourceStepLevel} = \text{antilog}(\text{LogStep}) * \text{startv}$$

Figure 148: SweepVLogMeasure()

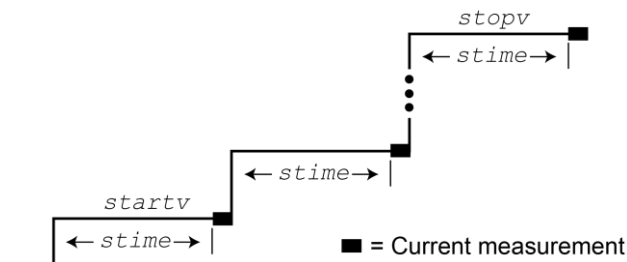

Example

```
SweepVLogMeasureI(smua, 1, 10, 0.001, 5)
```

This function performs a five-point logarithmic voltage sweep starting at 1 V and stopping at 10 V. Current is measured at every step (point) in the sweep after a 1 ms source settling period.

The following table contains log values and corresponding source levels for the five-point logarithmic sweep:

MeasurePoint	LogStepSize	LogStep	SourceStepLevel
1	0.25	0.0	1.0000 V
2	0.25	0.25	1.7783 V
3	0.25	0.5	3.1623 V
4	0.25	0.75	5.6234 V
5	0.25	1.0	10.000 V

Also see

[KISweep factory script](#) (on page 9-21)

timer.measure.t()

This function measures the elapsed time since the timer was last reset.

Type	TSP-Link accessible	Affected by	Where saved	Default value
Function	Yes			

Usage

```
time = timer.measure.t()
```

<code>time</code>	The elapsed time in seconds (1 μ s resolution)
-------------------	--

Example 1

```
timer.reset()
-- (intervening code)
time = timer.measure.t()
print(time)
```

This example resets the timer and measures the time since the reset.
Output:
 1.469077e+01
 The output will vary. The above output indicates that `timer.measure.t()` was executed 14.69077 seconds after `timer.reset()`.

Example 2

```
beeper.enable = beeper.ON
beeper.beep(0.5, 2400)
print("reset timer")
timer.reset()
delay(0.5)
dt = timer.measure.t()
print("timer after delay:", dt)
beeper.beep(0.5, 2400)
```

Enable the beeper.
 Emit a beep and set the beeper.
 Reset the timer.
 Set a delay.
 Verify the duration of the delay before emitting another beep.
Output:
 reset timer
 timer after delay: 5.00e-01

Also see

[timer.reset\(\)](#) (on page 11-349)

timer.reset()

This function resets the timer to zero (0) seconds.

Type	TSP-Link accessible	Affected by	Where saved	Default value
Function	Yes			

Usage

```
timer.reset()
```

Example

```
timer.reset()
-- (intervening code)
time = timer.measure.t()
print(time)
```

Resets the timer and then measures the time since the reset.
Output:
 1.469077e+01
 The above output indicates that `timer.measure.t()` was executed 14.69077 seconds after `timer.reset()`.

Also see

[timer.measure.t\(\)](#) (on page 11-349)

trigger.blender[N].clear()

This function clears the blender event detector and resets the overrun indicator of blender *N*.

Type	TSP-Link accessible	Affected by	Where saved	Default value
Function	Yes			

Usage

```
trigger.blender[N].clear()
```

<i>N</i>	The blender number (up to six)
----------	--------------------------------

Details

This command sets the blender event detector to the undetected state and resets the overrun indicator of the event detector.

Example

<code>trigger.blender[2].clear()</code>	Clears the event detector for blender 2.
---	--

Also see

None

trigger.blender[N].EVENT_ID

This constant contains the trigger blender event number.

Type	TSP-Link accessible	Affected by	Where saved	Default value
Constant	Yes			

Usage

```
eventID = trigger.blender[N].EVENT_ID
```

<i>eventID</i>	Trigger event number
<i>N</i>	The blender number (up to six)

Details

Set the stimulus of any trigger object to the value of this constant to have the trigger object respond to trigger events from this trigger blender.

Example

<code>digio.trigger[1].stimulus = trigger.blender[2].EVENT_ID</code>
Set the trigger stimulus of digital I/O trigger 1 to be controlled by the trigger blender 2 event.

Also see

None

trigger.blender[N].orenable

This attribute selects whether the blender performs OR operations or AND operations.

Type	TSP-Link accessible	Affected by	Where saved	Default value
Attribute (RW)	Yes	Instrument reset Trigger blender N reset Recall setup	Not saved	false (AND mode)

Usage

```
orenable = trigger.blender[N].orenable
trigger.blender[N].orenable = orenable
```

<i>orenable</i>	The type of operation: <ul style="list-style-type: none"> ▪ true: OR operation ▪ false: AND operation
<i>N</i>	The blender number (up to six)

Details

This command selects whether the blender waits for any one event (OR) or waits for all selected events (AND) before signaling an output event.

Example

```
trigger.blender[1].orenable = true
trigger.blender[1].stimulus[1] = digio.trigger[3].EVENT_ID
trigger.blender[1].stimulus[2] = digio.trigger[5].EVENT_ID
```

Generate a trigger blender 1 event when a digital I/O trigger happens on line 3 or 5.

Also see

[trigger.blender\[N\].reset\(\)](#) (on page 11-352)

trigger.blender[N].overrun

This attribute indicates whether or not an event was ignored because of the event detector state.

Type	TSP-Link accessible	Affected by	Where saved	Default value
Attribute (R)	Yes	Instrument reset Trigger blender <i>N</i> clear Trigger blender <i>N</i> reset	Not applicable	Not applicable

Usage

```
overrun = trigger.blender[N].overrun
```

<i>overrun</i>	Trigger blender overrun state (<code>true</code> or <code>false</code>)
<i>N</i>	The blender number (up to six)

Details

Indicates if an event was ignored because the event detector was already in the detected state when the event occurred. This is an indication of the state of the event detector that is built into the event blender itself.

This command does not indicate if an overrun occurred in any other part of the trigger model or in any other trigger object that is monitoring the event. It also is not an indication of an action overrun.

Example

```
print(trigger.blender[1].overrun)
```

If an event was ignored, the output is `true`.
If an event was not ignored, the output is `false`.

Also see

[trigger.blender\[N\].reset\(\)](#) (on page 11-352)

trigger.blender[N].reset()

This function resets some of the trigger blender settings to their factory defaults.

Type	TSP-Link accessible	Affected by	Where saved	Default value
Function	Yes			

Usage

```
trigger.blender[N].reset()
```

<i>N</i>	The trigger event blender (up to six)
----------	---------------------------------------

Details

The `trigger.blender[N].reset()` function resets the following attributes to their factory defaults:

- `trigger.blender[N].orenable`
- `trigger.blender[N].stimulus[M]`

It also clears `trigger.blender[N].overrun`.

Example

<code>trigger.blender[1].reset()</code>	Resets the trigger blender 1 settings to factory defaults.
---	--

Also see

- [trigger.blender\[N\].orenable](#) (on page 11-351)
- [trigger.blender\[N\].overrun](#) (on page 11-352)
- [trigger.blender\[N\].stimulus\[M\]](#) (on page 11-353)

trigger.blender[N].stimulus[M]

This attribute specifies the events that trigger the blender.

Type	TSP-Link accessible	Affected by	Where saved	Default value
Attribute (RW)	Yes	Trigger blender N reset	Not applicable	trigger.EVENT_NONE

Usage

```
eventID = trigger.blender[N].stimulus[M]
trigger.blender[N].stimulus[M] = eventID
```

<i>eventID</i>	The event that triggers the blender action; see Details
<i>N</i>	An integer representing the trigger event blender (up to six)
<i>M</i>	An integer representing the stimulus index (1 to 4)

Details

There are four stimulus inputs that can each select a different event. The *eventID* parameter can be the event ID of any trigger event.

Use zero to disable the blender input.

The *eventID* parameter may be one of the existing trigger event IDs shown in the following table.

Trigger event IDs*	
Event ID	Event description
<code>smua.trigger.SWEEPING_EVENT_ID</code>	Occurs when the source-measure unit (SMU) transitions from the idle state to the arm layer of the trigger model
<code>smua.trigger.ARMED_EVENT_ID</code>	Occurs when the SMU moves from the arm layer to the trigger layer of the trigger model
<code>smua.trigger.SOURCE_COMPLETE_EVENT_ID</code>	Occurs when the SMU completes a source action
<code>smua.trigger.MEASURE_COMPLETE_EVENT_ID</code>	Occurs when the SMU completes a measurement action
<code>smua.trigger.PULSE_COMPLETE_EVENT_ID</code>	Occurs when the SMU completes a pulse
<code>smua.trigger.SWEEP_COMPLETE_EVENT_ID</code>	Occurs when the SMU completes a sweep
<code>smua.trigger.IDLE_EVENT_ID</code>	Occurs when the SMU returns to the idle state
<code>digio.trigger[N].EVENT_ID</code>	Occurs when an edge is detected on a digital I/O line
<code>tsplink.trigger[N].EVENT_ID</code>	Occurs when an edge is detected on a TSP-Link line
<code>lan.trigger[N].EVENT_ID</code>	Occurs when the appropriate LXI trigger packet is received on LAN trigger object <i>N</i>
<code>display.trigger.EVENT_ID</code>	Occurs when the TRIG key on the front panel is pressed

Trigger event IDs*	
Event ID	Event description
<code>trigger.EVENT_ID</code>	Occurs when a *TRG command is received on the remote interface GPIB only: Occurs when a GET bus command is received USB only: Occurs when a USBTMC TRIGGER message is received VXI-11 only: Occurs with the VXI-11 command <code>device_trigger</code> ; reference the VXI-11 standard for additional details on the device trigger operation
<code>trigger.blender[N].EVENT_ID</code>	Occurs after a collection of events is detected
<code>trigger.timer[N].EVENT_ID</code>	Occurs when a delay expires
<code>trigger.generator[N].EVENT_ID</code>	Occurs when the <code>trigger.generator[N].assert()</code> function is executed
* Use the name of the trigger event ID to set the stimulus value rather than the numeric value. Using the name makes the code compatible for future upgrades (for example, if the numeric values must change when enhancements are added to the instrument).	

Example

```
digio.trigger[3].mode = digio.TRIG_FALLING
digio.trigger[5].mode = digio.TRIG_FALLING
trigger.blender[1].orenable = true
trigger.blender[1].stimulus[1] = digio.trigger[3].EVENT_ID
trigger.blender[1].stimulus[2] = digio.trigger[5].EVENT_ID
```

Generate a trigger blender 1 event when a digital I/O trigger happens on line 3 or 5.

Also see

[trigger.blender\[N\].reset\(\)](#) (on page 11-352)

trigger.blender[N].wait()

This function waits for a blender trigger event to occur.

Type	TSP-Link accessible	Affected by	Where saved	Default value
Function	Yes			

Usage

```
triggered = trigger.blender[N].wait(timeout)
```

<i>triggered</i>	Trigger detection indication for blender
<i>N</i>	The trigger blender (up to six) on which to wait
<i>timeout</i>	Maximum amount of time in seconds to wait for the trigger blender event

Details

This function waits for an event blender trigger event. If one or more trigger events were detected since the last time `trigger.blender[N].wait()` or `trigger.blender[N].clear()` was called, this function returns immediately.

After detecting a trigger with this function, the event detector automatically resets and rearms. This is true regardless of the number of events detected.

Example

```
digio.trigger[3].mode = digio.TRIG_FALLING
digio.trigger[5].mode = digio.TRIG_FALLING
trigger.blender[1].orenable = true
trigger.blender[1].stimulus[1] = digio.trigger[3].EVENT_ID
trigger.blender[1].stimulus[2] = digio.trigger[5].EVENT_ID
print(trigger.blender[1].wait(3))
```

Generate a trigger blender 1 event when a digital I/O trigger happens either on line 3 or 5. Wait three seconds while checking if trigger blender 1 event has occurred. If the blender trigger event has happened, then `true` is output. If the trigger event has not happened, then `false` is output after the timeout expires.

Also see

[trigger.blender\[N\].clear\(\)](#) (on page 11-350)

trigger.clear()

This function clears the command interface trigger event detector.

Type	TSP-Link accessible	Affected by	Where saved	Default value
Function	No			

Usage

```
trigger.clear()
```

Details

The trigger event detector indicates if a trigger event has been detected since the last `trigger.wait()` call. `trigger.clear()` clears the trigger event detector and discards the history of command interface trigger events.

Also see

[trigger.wait\(\)](#) (on page 11-364)

trigger.EVENT_ID

This constant contains the command interface trigger event number.

Type	TSP-Link accessible	Affected by	Where saved	Default value
Constant	Yes			

Usage

```
eventID = trigger.EVENT_ID
```

<code>eventID</code>	The event ID for the command interface triggers
----------------------	---

Details

You can set the stimulus of any trigger object to the value of this constant to have the trigger object respond to command interface trigger events.

Example

```
trigger.timer[1].stimulus = trigger.EVENT_ID
```

Sets the trigger stimulus of trigger timer 1 to the command interface trigger event.

Also see

None

trigger.generator[N].assert()

This function generates a trigger event.

Type	TSP-Link accessible	Affected by	Where saved	Default value
Function	Yes			

Usage

```
trigger.generator[N].assert()
```

<i>N</i>	The generator number (1 or 2)
----------	-------------------------------

Details

Use this function to directly trigger events from the command interface or a script. For example, you can trigger a sweep while the instrument is under script control.

Example

```
trigger.generator[2].assert()
```

Generates a trigger event on generator 2.

Also see

[trigger.generator\[N\].EVENT_ID](#) (on page 11-356)

trigger.generator[N].EVENT_ID

This constant identifies the trigger event generated by the trigger event generator.

Type	TSP-Link accessible	Affected by	Where saved	Default value
Constant	Yes			

Usage

```
eventID = trigger.generator[N].EVENT_ID
```

<i>eventID</i>	The trigger event number
<i>N</i>	The generator number (1 or 2)

Details

This constant is an identification number that identifies events generated by this generator.

To have another trigger object respond to trigger events generated by this generator, set the other object's stimulus attribute to the value of this constant.

Example

```
digio.trigger[5].stimulus = trigger.generator[2].EVENT_ID
Uses a trigger event on generator 2 to be the stimulus for digital I/O trigger line 5.
```

Also see

[trigger.generator\[N\].assert\(\)](#) (on page 11-356)

trigger.timer[N].clear()

This function clears the timer event detector and overrun indicator for the specified trigger timer number.

Type	TSP-Link accessible	Affected by	Where saved	Default value
Function	Yes			

Usage

```
trigger.timer[N].clear()
N Trigger timer number (1 to 8)
```

Details

This command sets the timer event detector to the undetected state and resets the overrun indicator.

Example

```
trigger.timer[1].clear() Clears trigger timer 1.
```

Also see

[trigger.timer\[N\].count](#) (on page 11-357)

trigger.timer[N].count

This attribute sets the number of events to generate each time the timer generates a trigger event.

Type	TSP-Link accessible	Affected by	Where saved	Default value
Attribute (RW)	Yes	Instrument reset Recall setup Trigger timer N reset	Not saved	1

Usage

```
count = trigger.timer[N].count
trigger.timer[N].count = count
count Number of times to repeat the trigger (0 to 1,048,575)
N Trigger timer number (1 to 8)
```

Details

If the count is set to a number greater than 1, the timer automatically starts the next trigger timer delay at the expiration of the previous delay.

Set the count to zero (0) to cause the timer to generate trigger events indefinitely.

If you use the trigger timer with a trigger model, make sure the count value is the same or more than any count values expected in the trigger model.

Example

```
print(trigger.timer[1].count)
```

Read trigger count for timer number 1.

Also see

[trigger.timer\[N\].clear\(\)](#) (on page 11-357)

[trigger.timer\[N\].delay](#) (on page 11-358)

[trigger.timer\[N\].reset\(\)](#) (on page 11-361)

trigger.timer[N].delay

This attribute sets and reads the timer delay.

Type	TSP-Link accessible	Affected by	Where saved	Default value
Attribute (RW)	Yes	Instrument reset Recall setup Trigger timer N reset	Not saved	10e-6 (10 μ s)

Usage

```
interval = trigger.timer[N].delay
trigger.timer[N].delay = interval
```

<i>interval</i>	Delay interval in seconds (0.5 μ s to 100 ks)
<i>N</i>	Trigger timer number (1 to 8)

Details

Once the timer is enabled, each time the timer is triggered, it uses this delay period.

Assigning a value to this attribute is equivalent to:

```
trigger.timer[N].delaylist = {interval}
```

This creates a delay list of one value.

Reading this attribute returns the delay interval that will be used the next time the timer is triggered.

Example

```
trigger.timer[1].delay = 50e-6
```

Set the trigger timer 1 to delay for 50 μ s.

Also see

[trigger.timer\[N\].reset\(\)](#) (on page 11-361)

trigger.timer[N].delaylist

This attribute sets an array of timer intervals.

Type	TSP-Link accessible	Affected by	Where saved	Default value
Attribute (RW)	Yes	Instrument reset Recall setup Trigger timer <i>N</i> reset	Not saved	10e-6 (10 μ s)

Usage

```
intervals = trigger.timer[N].delaylist
trigger.timer[N].delaylist = intervals
```

<i>intervals</i>	Table of delay intervals in seconds
<i>N</i>	Trigger timer number (1 to 8)

Details

Each time the timer is triggered after it is enabled, it uses the next delay period from the array. The default value is an array with one value of 10 μ s.

After all elements in the array have been used, the delays restart at the beginning of the list.

If the array contains more than one element, the average of the delay intervals in the list must be $\geq 50 \mu$ s.

Example

```
trigger.timer[3].delaylist = {50e-6, 100e-6, 150e-6}
```

```
DelayList = trigger.timer[3].delaylist
for x = 1, table.getn(DelayList) do
  print(DelayList[x])
end
```

Set a delay list on trigger timer 3 with three delays (50 μ s, 100 μ s, and 150 μ s).

Read the delay list on trigger timer 3.

```
Output:
5e-05
0.0001
0.00015
```

Also see

[trigger.timer\[N\].reset\(\)](#) (on page 11-361)

trigger.timer[N].EVENT_ID

This constant specifies the trigger timer event number.

Type	TSP-Link accessible	Affected by	Where saved	Default value
Constant	Yes			

Usage

```
eventID = trigger.timer[N].EVENT_ID
```

<i>eventID</i>	The trigger event number
<i>N</i>	Trigger timer number (1 to 8)

Details

This constant is an identification number that identifies events generated by this timer.

Set the stimulus of any trigger object to the value of this constant to have the trigger object respond to events from this timer.

Example

```
trigger.timer[1].stimulus = tsplink.trigger[2].EVENT_ID
```

Sets the trigger stimulus of trigger timer 1 to the TSP-Link trigger 2 event.

Also see

None

trigger.timer[N].overrun

This attribute indicates if an event was ignored because of the event detector state.

Type	TSP-Link accessible	Affected by	Where saved	Default value
Attribute (R)	Yes	Instrument reset Recall setup Trigger timer N clear Trigger timer N reset	Not applicable	false

Usage

```
overrun = trigger.timer[N].overrun
```

<i>overrun</i>	Trigger overrun state (true or false)
<i>N</i>	Trigger timer number (1 to 8)

Details

This command indicates if an event was ignored because the event detector was already in the detected state when the event occurred.

This is an indication of the state of the event detector built into the timer itself. It does not indicate if an overrun occurred in any other part of the trigger model or in any other construct that is monitoring the delay completion event. It also is not an indication of a delay overrun.

Delay overrun indications are provided in the status model.

Example

```
print(trigger.timer[1].overrun)
```

If an event was ignored, the output is `true`.
If the event was not ignored, the output is `false`.

Also see

[trigger.timer\[N\].reset\(\)](#) (on page 11-361)

trigger.timer[N].passthrough

This attribute enables or disables the timer trigger pass-through mode.

Type	TSP-Link accessible	Affected by	Where saved	Default value
Attribute (RW)	Yes	Instrument reset Recall setup Trigger timer N reset	Not saved	false (disabled)

Usage

```
passthrough = trigger.timer[N].passthrough
trigger.timer[N].passthrough = passthrough
```

<i>passthrough</i>	The state of pass-through mode; set to one of the following values: <ul style="list-style-type: none"> ▪ <code>true</code>: Enabled ▪ <code>false</code>: Disabled
<i>N</i>	Trigger timer number (1 to 8)

Details

When pass-through mode is enabled, triggers are passed through immediately and initiate the delay. When disabled, a trigger only initiates a delay.

Example

```
trigger.timer[1].passthrough = true
```

Enables pass-through mode on trigger timer 1.

Also see

[trigger.timer\[N\].reset\(\)](#) (on page 11-361)

trigger.timer[N].reset()

This function resets some of the trigger timer settings to their factory defaults.

Type	TSP-Link accessible	Affected by	Where saved	Default value
Function	Yes			

Usage

```
trigger.timer[N].reset()
```

<i>N</i>	Trigger timer number (1 to 8)
----------	-------------------------------

Details

The `trigger.timer[N].reset()` function resets the following attributes to their factory defaults:

- `trigger.timer[N].count`
- `trigger.timer[N].delay`
- `trigger.timer[N].delaylist`
- `trigger.timer[N].passthrough`
- `trigger.timer[N].stimulus`

It also clears `trigger.timer[N].overrun`.

Example

```
trigger.timer[1].reset()
```

Resets the attributes associated with timer 1 back to factory default values.

Also see

- [trigger.timer\[N\].count](#) (on page 11-357)
- [trigger.timer\[N\].delay](#) (on page 11-358)
- [trigger.timer\[N\].delaylist](#) (on page 11-359)
- [trigger.timer\[N\].overrun](#) (on page 11-360)
- [trigger.timer\[N\].passthrough](#) (on page 11-361)
- [trigger.timer\[N\].stimulus](#) (on page 11-362)

trigger.timer[N].stimulus

This attribute specifies which event starts the timer.

Type	TSP-Link accessible	Affected by	Where saved	Default value
Attribute (RW)	Yes	Instrument reset Recall setup Trigger timer N reset	Not saved	0

Usage

```
eventID = trigger.timer[N].stimulus
trigger.timer[N].stimulus = eventID
```

<i>eventID</i>	The event that triggers the timer delay
<i>N</i>	Trigger timer number (1 to 8)

Details

The *eventID* parameter may be one of the trigger event IDs shown in the following table.

Trigger event IDs*	
Event ID	Event description
<code>smua.trigger.SWEEPING_EVENT_ID</code>	Occurs when the source-measure unit (SMU) transitions from the idle state to the arm layer of the trigger model
<code>smua.trigger.ARMED_EVENT_ID</code>	Occurs when the SMU moves from the arm layer to the trigger layer of the trigger model
<code>smua.trigger.SOURCE_COMPLETE_EVENT_ID</code>	Occurs when the SMU completes a source action

Trigger event IDs*	
Event ID	Event description
smua.trigger.MEASURE_COMPLETE_EVENT_ID	Occurs when the SMU completes a measurement action
smua.trigger.PULSE_COMPLETE_EVENT_ID	Occurs when the SMU completes a pulse
smua.trigger.SWEEP_COMPLETE_EVENT_ID	Occurs when the SMU completes a sweep
smua.trigger.IDLE_EVENT_ID	Occurs when the SMU returns to the idle state
digio.trigger[N].EVENT_ID	Occurs when an edge is detected on a digital I/O line
tsplink.trigger[N].EVENT_ID	Occurs when an edge is detected on a TSP-Link line
lan.trigger[N].EVENT_ID	Occurs when the appropriate LXI trigger packet is received on LAN trigger object <i>N</i>
display.trigger.EVENT_ID	Occurs when the TRIG key on the front panel is pressed
trigger.EVENT_ID	Occurs when a *TRG command is received on the remote interface GPIB only: Occurs when a GET bus command is received USB only: Occurs when a USBTMC TRIGGER message is received VXI-11 only: Occurs with the VXI-11 command <code>device_trigger</code> ; reference the VXI-11 standard for additional details on the device trigger operation
trigger.blender[N].EVENT_ID	Occurs after a collection of events is detected
trigger.timer[N].EVENT_ID	Occurs when a delay expires
trigger.generator[N].EVENT_ID	Occurs when the <code>trigger.generator[N].assert()</code> function is executed
* Use the name of the trigger event ID to set the stimulus value rather than the numeric value. Using the name makes the code compatible for future upgrades (for example, if the numeric values must change when enhancements are added to the instrument).	

Set this attribute to the *eventID* of any trigger event to cause the timer to start when that event occurs.

Set this attribute to zero (0) to disable event processing.

Example

<pre>print(trigger.timer[1].stimulus)</pre>	Prints the event that will start a trigger 1 timer action.
---	--

Also see

[trigger.timer\[N\].reset\(\)](#) (on page 11-361)

trigger.timer[N].wait()

This function waits for a trigger.

Type	TSP-Link accessible	Affected by	Where saved	Default value
Function	Yes			

Usage

```
triggered = trigger.timer[N].wait(timeout)
```

<i>triggered</i>	Trigger detection indication
<i>N</i>	Trigger timer number (1 to 8)
<i>timeout</i>	Maximum amount of time in seconds to wait for the trigger

Details

If one or more trigger events were detected since the last time `trigger.timer[N].wait()` or `trigger.timer[N].clear()` was called, this function returns immediately.

After waiting for a trigger with this function, the event detector is automatically reset and rearmed. This is true regardless of the number of events detected.

Example

```
triggered = trigger.timer[3].wait(10)
print(triggered)
```

Waits up to 10 s for a trigger on timer 3.
If `false` is returned, no trigger was detected during the 10 s timeout.
If `true` is returned, a trigger was detected.

Also see

[trigger.timer\[N\].clear\(\)](#) (on page 11-357)

trigger.wait()

This function waits for a command interface trigger event.

Type	TSP-Link accessible	Affected by	Where saved	Default value
Function	No			

Usage

```
triggered = trigger.wait(timeout)
```

<i>triggered</i>	<code>true</code> : A trigger was detected during the timeout period <code>false</code> : No triggers were detected during the timeout period
<i>timeout</i>	Maximum amount of time in seconds to wait for the trigger

Details

This function waits up to *timeout* seconds for a trigger on the active command interface. A command interface trigger occurs when:

- A GPIB GET command is detected (GPIB only)
- A USBTMC TRIGGER message is received (USB only)
- A VXI-11 device_trigger method is invoked (VXI-11 only)
- A *TRG message is received

If one or more of these trigger events were previously detected, this function returns immediately.

After waiting for a trigger with this function, the event detector is automatically reset and rearmed. This is true regardless of the number of events detected.

Example

```
triggered = trigger.wait(10)
print(triggered)
```

Waits up to 10 seconds for a trigger.
If *false* is returned, no trigger was detected during the 10-second timeout.
If *true* is returned, a trigger was detected.

Also see

[trigger.clear\(\)](#) (on page 11-355)

tsplink.group

This attribute contains the group number of a TSP-Link node.

Type	TSP-Link accessible	Affected by	Where saved	Default value
Attribute (RW)	Yes	Power cycle	Not applicable	0

Usage

```
groupNumber = tsplink.group
tsplink.group = groupNumber
```

groupNumber The group number of the TSP-Link node (0 to 64)

Details

To remove the node from all groups, set the attribute value to 0.

When the node is turned off, the group number for that node changes to 0.

The master node can be assigned to any group. You can also include other nodes in the group that includes the master. Note that any nodes that are set to 0 are automatically included in the group that contains the master node, regardless of the group that is assigned to the master node.

Example

```
tsplink.group = 3
```

Assign the instrument to TSP-Link group number 3.

Also see

[Using groups to manage nodes on a TSP-Link system](#) (on page 10-53)

tsplink.master

This attribute reads the node number assigned to the master node.

Type	TSP-Link accessible	Affected by	Where saved	Default value
Attribute (R)	Yes	Not applicable	Not applicable	Not applicable

Usage

```
masterNodeNumber = tsplink.master
```

<code>masterNodeNumber</code>	The node number of the master node
-------------------------------	------------------------------------

Details

After doing a TSP-Link reset (`tsplink.reset()`), use this attribute to access the node number of the master in a set of instruments connected over TSP-Link.

Example

```
LinkMaster = tsplink.master
```

Store the TSP-Link master node number in a variable called LinkMaster.

Also see

[tsplink.reset\(\)](#) (on page 11-368)

tsplink.node

This attribute defines the node number.

Type	TSP-Link accessible	Affected by	Where saved	Default value
Attribute (RW)	Yes	Not applicable	Nonvolatile memory	1

Usage

```
nodeNumber = tsplink.node
tsplink.node = nodeNumber
```

<code>nodeNumber</code>	The node number of the instrument or enclosure (1 to 64)
-------------------------	---

Details

This command sets the TSP-Link node number and saves the value in nonvolatile memory.

Changes to the node number do not take effect until `tsplink.reset()` from an earlier TSP-Link instrument is executed on any node in the system.

Each node connected to the TSP-Link system must be assigned a different node number.

Example

```
tsplink.node = 3
```

Sets the TSP-Link node for this instrument to number 3.

Also see

[tsplink.reset\(\)](#) (on page 11-368)

[tsplink.state](#) (on page 11-369)

tsplink.readbit()

This function reads the state of a TSP-Link synchronization line.

Type	TSP-Link accessible	Affected by	Where saved	Default value
Function	Yes			

Usage

```
data = tsplink.readbit(N)
```

<i>data</i>	The state of the synchronization line
<i>N</i>	The trigger line (1 to 3)

Details

Returns a value of zero (0) if the line is low and 1 if the line is high.

Example

<pre>data = tsplink.readbit(3) print(data)</pre>	Assume line 3 is set high, and it is then read. Output: 1.000000e+00
--	--

Also see

[tsplink.readport\(\)](#) (on page 11-367)

[tsplink.writebit\(\)](#) (on page 11-377)

tsplink.readport()

This function reads the TSP-Link trigger lines as a digital I/O port.

Type	TSP-Link accessible	Affected by	Where saved	Default value
Function	Yes			

Usage

```
data = tsplink.readport()
```

<i>data</i>	Numeric value that indicates which lines are set
-------------	--

Details

The binary equivalent of the returned value indicates the input pattern on the I/O port. The least significant bit of the binary number corresponds to line 1 and the value of bit 3 corresponds to line 3. For example, a returned value of 2 has a binary equivalent of 010. This indicates that line 2 is high (1), and that the other two lines are low (0).

Example

<pre>data = tsplink.readport() print(data)</pre>	Reads state of all three TSP-Link lines. Assuming line 2 is set high, the output is: 2.000000e+00 (binary 010) The format of the output may vary depending on the ASCII precision setting.
--	--

Also see

[TSP-Link trigger lines](#) (on page 6-39)
[tsplink.readbit\(\)](#) (on page 11-367)
[tsplink.writebit\(\)](#) (on page 11-377)
[tsplink.writeport\(\)](#) (on page 11-378)

tsplink.reset()

This function initializes (resets) all nodes (instruments) in the TSP-Link system.

Type	TSP-Link accessible	Affected by	Where saved	Default value
Function	No			

Usage

```
nodesFound = tsplink.reset()
nodesFound = tsplink.reset(expectedNodes)
```

<i>nodesFound</i>	The number of nodes actually found on the system
<i>expectedNodes</i>	The number of nodes expected on the system (1 to 64)

Details

This function erases all information regarding other nodes connected on the TSP-Link system and regenerates the system configuration. This function must be called at least once before any remote nodes can be accessed. If the node number for any instrument is changed, the TSP-Link must be reset again.

If *expectedNodes* is not given, this function generates an error if no other nodes are found on the TSP-Link network.

If *nodesFound* is less than *expectedNodes*, an error is generated. Note that the node on which the command is running is counted as a node. For example, giving an expected node count of 1 will not generate any errors, even if there are no other nodes on the TSP-Link network.

Also returns the number of nodes found.

Example

```
nodesFound = tsplink.reset(2)
print("Nodes found = " .. nodesFound)
```

Perform a TSP-Link reset and indicate how many nodes are found.
 Sample output if two nodes are found:
 Nodes found = 2
 Sample output if fewer nodes are found and if `localnode.showerrors = 1`:
 1219, TSP-Link found fewer nodes
 than expected
 Nodes found = 1

Also see

[localnode.showerrors](#) (on page 11-146)
[tsplink.node](#) (on page 11-366)
[tsplink.state](#) (on page 11-369)

tsplink.state

This attribute describes the TSP-Link online state.

Type	TSP-Link accessible	Affected by	Where saved	Default value
Attribute (R)	Yes	Not applicable	Not applicable	Not applicable

Usage

```
state = tsplink.state
```

state	TSP-Link state (online or offline)
-------	------------------------------------

Details

When the instrument power is first turned on, the state is `offline`. After `tsplink.reset()` is successful, the state is `online`.

Example

```
state = tsplink.state
print(state)
```

Read the state of the TSP-Link system. If it is online, the output is: `online`

Also see

- [tsplink.node](#) (on page 11-366)
- [tsplink.reset\(\)](#) (on page 11-368)

tsplink.trigger[N].assert()

This function simulates the occurrence of the trigger and generates the corresponding event ID.

Type	TSP-Link accessible	Affected by	Where saved	Default value
Function	Yes			

Usage

```
tsplink.trigger[N].assert()
```

N	The trigger line (1 to 3)
---	---------------------------

Details

The set pulse width determines how long the trigger is asserted.

Example

<code>tsplink.trigger[2].assert()</code>	Asserts trigger on trigger line 2.
--	------------------------------------

Also see

- [tsplink.trigger\[N\].clear\(\)](#) (on page 11-370)
- [tsplink.trigger\[N\].mode](#) (on page 11-371)
- [tsplink.trigger\[N\].overrun](#) (on page 11-372)
- [tsplink.trigger\[N\].pulsewidth](#) (on page 11-373)
- [tsplink.trigger\[N\].release\(\)](#) (on page 11-374)
- [tsplink.trigger\[N\].stimulus](#) (on page 11-375)
- [tsplink.trigger\[N\].wait\(\)](#) (on page 11-376)

tsplink.trigger[N].clear()

This function clears the event detector for a LAN trigger.

Type	TSP-Link accessible	Affected by	Where saved	Default value
Function	Yes			

Usage

```
tsplink.trigger[N].clear()
```

<i>N</i>	The trigger line (1 to 3) to clear
----------	------------------------------------

Details

The trigger event detector enters the detected state when an event is detected.

`tsplink.trigger[N].clear()` clears a trigger event detector, discards the history of the trigger line, and clears the `tsplink.trigger[N].overrun` attribute.

Example

<code>tsplink.trigger[2].clear()</code>	Clears trigger event on synchronization line 2.
---	---

Also see

- [tsplink.trigger\[N\].mode](#) (on page 11-371)
- [tsplink.trigger\[N\].overrun](#) (on page 11-372)
- [tsplink.trigger\[N\].release\(\)](#) (on page 11-374)
- [tsplink.trigger\[N\].stimulus](#) (on page 11-375)
- [tsplink.trigger\[N\].wait\(\)](#) (on page 11-376)

tsplink.trigger[N].EVENT_ID

This constant identifies the number that is used for the trigger events.

Type	TSP-Link accessible	Affected by	Where saved	Default value
Constant	Yes			

Usage

```
eventID = tsplink.trigger[N].EVENT_ID
```

<i>eventID</i>	The trigger event number
<i>N</i>	The trigger line (1 to 3)

Details

This number is used by the TSP-Link trigger line when it detects an input trigger.

Set the stimulus of any trigger object to the value of this constant to have the trigger object respond to trigger events from this line.

Example

```
trigger.timer[1].stimulus = tsplink.trigger[2].EVENT_ID
```

Sets the trigger stimulus of trigger timer 1 to the TSP-Link trigger 2 event.

Also see

None

tsplink.trigger[N].mode

This attribute defines the trigger operation and detection mode.

Type	TSP-Link accessible	Affected by	Where saved	Default value
Attribute (RW)	Yes	Instrument reset Recall setup TSP-Link trigger N reset	Not saved	0 (tsplink.TRIG_BYPASS)

Usage

```
mode = tsplink.trigger[N].mode
tsplink.trigger[N].mode = mode
```

<i>mode</i>	The trigger mode
<i>N</i>	The trigger line (1 to 3)

Details

This attribute controls the mode in which the trigger event detector and the output trigger generator operate on the given trigger line.

The setting for the *mode* parameter can be one of the values shown in the following table.

Mode	Number value	Description
tsplink.TRIG_BYPASS	0	Allows direct control of the line as a digital I/O line.
tsplink.TRIG_FALLING	1	Detects falling-edge triggers as input. Asserts a TTL-low pulse for output.
tsplink.TRIG_RISING	2	If the programmed state of the line is high, the tsplink.TRIG_RISING mode behaves similarly to tsplink.TRIG_RISINGA. If the programmed state of the line is low, the tsplink.TRIG_RISING mode behaves similarly to tsplink.TRIG_RISINGM. Use tsplink.TRIG_RISINGA if the line is in the high output state. Use tsplink.TRIG_RISINGM if the line is in the low output state.
tsplink.TRIG_EITHER	3	Detects rising- or falling-edge triggers as input. Asserts a TTL-low pulse for output.
tsplink.TRIG_SYNCHRONOUSA	4	Detects the falling-edge input triggers and automatically latches and drives the trigger line low.
tsplink.TRIG_SYNCHRONOUS	5	Detects the falling-edge input triggers and automatically latches and drives the trigger line low. Asserts a TTL-low pulse as an output trigger.

Mode	Number value	Description
<code>tsplink.TRIG_SYNCHRONOUSM</code>	6	Detects rising-edge triggers as an input. Asserts a TTL-low pulse for output.
<code>tsplink.TRIG_RISINGA</code>	7	Detects rising-edge triggers as input. Asserts a TTL-low pulse for output.
<code>tsplink.TRIG_RISINGM</code>	8	Edge detection as an input is not available. Generates a TTL-high pulse as an output trigger.

When programmed to any mode except `tsplink.TRIG_BYPASS`, the output state of the I/O line is controlled by the trigger logic and the user-specified output state of the line is ignored.

When the trigger mode is set to `tsplink.TRIG_RISING`, the user-specified output state of the line is examined. If the output state selected when the mode is changed is high, the actual mode used will be `tsplink.TRIG_RISINGA`. If the output state selected when the mode is changed is low, the actual mode used will be `tsplink.TRIG_RISINGM`.

The *mode* parameter stores the trigger mode as a numeric value when the attribute is read.

To control the line state, use the `tsplink.TRIG_BYPASS` mode with the `tsplink.writebit()` and the `tsplink.writeport()` commands.

Example

```
tsplink.trigger[3].mode = tsplink.TRIG_RISINGM
```

Sets the trigger mode for synchronization line 3 to `tsplink.TRIG_RISINGM`.

Also see

[digio.writebit\(\)](#) (on page 11-52)
[digio.writeport\(\)](#) (on page 11-52)
[tsplink.trigger\[N\].assert\(\)](#) (on page 11-369)
[tsplink.trigger\[N\].clear\(\)](#) (on page 11-370)
[tsplink.trigger\[N\].overrun](#) (on page 11-372)
[tsplink.trigger\[N\].release\(\)](#) (on page 11-374)
[tsplink.trigger\[N\].reset\(\)](#) (on page 11-374)
[tsplink.trigger\[N\].stimulus](#) (on page 11-375)
[tsplink.trigger\[N\].wait\(\)](#) (on page 11-376)

tsplink.trigger[N].overrun

This attribute indicates if the event detector ignored an event while in the detected state.

Type	TSP-Link accessible	Affected by	Where saved	Default value
Attribute (R)	Yes	Instrument reset Recall setup TSP-Link trigger N clear TSP-Link trigger N reset	Not applicable	Not applicable

Usage

```
overrun = tsplink.trigger[N].overrun
```

<i>overrun</i>	Trigger overrun state
<i>N</i>	The trigger line (1 to 3)

Details

This command indicates whether an event has been ignored because the event detector was already in the detected state when the event occurred.

This is an indication of the state of the event detector built into the synchronization line itself.

It does not indicate if an overrun occurred in any other part of the trigger model, or in any other construct that is monitoring the event. It also is not an indication of an output trigger overrun. Output trigger overrun indications are provided in the status model.

Example

```
print(tsplink.trigger[1].overrun)
```

If an event was ignored, displays `true`; if an event was not ignored, displays `false`.

Also see

- [tsplink.trigger\[N\].assert\(\)](#) (on page 11-369)
- [tsplink.trigger\[N\].clear\(\)](#) (on page 11-370)
- [tsplink.trigger\[N\].mode](#) (on page 11-371)
- [tsplink.trigger\[N\].release\(\)](#) (on page 11-374)
- [tsplink.trigger\[N\].reset\(\)](#) (on page 11-374)
- [tsplink.trigger\[N\].stimulus](#) (on page 11-375)
- [tsplink.trigger\[N\].wait\(\)](#) (on page 11-376)

tsplink.trigger[N].pulsewidth

This attribute sets the length of time that the trigger line is asserted for output triggers.

Type	TSP-Link accessible	Affected by	Where saved	Default value
Attribute (RW)	Yes	Instrument reset TSP-Link trigger N reset Recall setup	Not saved	10e-6 (10 μs)

Usage

```
width = tsplink.trigger[N].pulsewidth
tsplink.trigger[N].pulsewidth = width
```

<i>width</i>	The pulse width (in seconds)
<i>N</i>	The trigger line (1 to 3)

Details

Setting the pulse width to 0 (seconds) asserts the trigger indefinitely.

Example

```
tsplink.trigger[3].pulsewidth = 20e-6
```

Sets pulse width for trigger line 3 to 20 μs.

Also see

- [tsplink.trigger\[N\].release\(\)](#) (on page 11-374)

tsplink.trigger[N].release()

This function releases a latched trigger on the given TSP-Link trigger line.

Type	TSP-Link accessible	Affected by	Where saved	Default value
Function	Yes			

Usage

```
tsplink.trigger[N].release()
```

<i>N</i>	The trigger line (1 to 3)
----------	---------------------------

Details

Releases a trigger that was asserted with an indefinite pulse width. It also releases a trigger that was latched in response to receiving a synchronous mode trigger.

Example

<code>tsplink.trigger[3].release()</code>	Releases trigger line 3.
---	--------------------------

Also see

- [tsplink.trigger\[N\].assert\(\)](#) (on page 11-369)
- [tsplink.trigger\[N\].clear\(\)](#) (on page 11-370)
- [tsplink.trigger\[N\].mode](#) (on page 11-371)
- [tsplink.trigger\[N\].overrun](#) (on page 11-372)
- [tsplink.trigger\[N\].pulsewidth](#) (on page 11-373)
- [tsplink.trigger\[N\].stimulus](#) (on page 11-375)
- [tsplink.trigger\[N\].wait\(\)](#) (on page 11-376)

tsplink.trigger[N].reset()

This function resets some of the TSP-Link trigger attributes to their factory defaults.

Type	TSP-Link accessible	Affected by	Where saved	Default value
Function	Yes			

Usage

```
tsplink.trigger[N].reset()
```

<i>N</i>	The trigger line (1 to 3)
----------	---------------------------

Details

The `tsplink.trigger[N].reset()` function resets the following attributes to their factory defaults:

- `tsplink.trigger[N].mode`
- `tsplink.trigger[N].stimulus`
- `tsplink.trigger[N].pulsewidth`

This also clears `tsplink.trigger[N].overrun`.

Example

```
tsplink.trigger[3].reset() Resets TSP-Link trigger line 3 attributes back to factory default values.
```

Also see

- [tsplink.trigger\[N\].mode](#) (on page 11-371)
- [tsplink.trigger\[N\].overrun](#) (on page 11-372)
- [tsplink.trigger\[N\].pulsewidth](#) (on page 11-373)
- [tsplink.trigger\[N\].stimulus](#) (on page 11-375)

tsplink.trigger[N].stimulus

This attribute specifies the event that causes the synchronization line to assert a trigger.

Type	TSP-Link accessible	Affected by	Where saved	Default value
Attribute (RW)	Yes	Instrument reset Recall setup TSP-Link trigger N reset	Not saved	0

Usage

```
eventID = tsplink.trigger[N].stimulus
tsplink.trigger[N].stimulus = eventID
```

<i>eventID</i>	The event identifier for the triggering event
<i>N</i>	The trigger line (1 to 3)

Details

To disable automatic trigger assertion on the synchronization line, set this attribute to zero (0).

Do not use this attribute when triggering under script control. Use `tsplink.trigger[N].assert()` instead.

The *eventID* parameter may be one of the existing trigger event IDs shown in the following table.

Trigger event IDs*	
Event ID	Event description
smua.trigger.SWEEPING_EVENT_ID	Occurs when the source-measure unit (SMU) transitions from the idle state to the arm layer of the trigger model
smua.trigger.ARMED_EVENT_ID	Occurs when the SMU moves from the arm layer to the trigger layer of the trigger model
smua.trigger.SOURCE_COMPLETE_EVENT_ID	Occurs when the SMU completes a source action
smua.trigger.MEASURE_COMPLETE_EVENT_ID	Occurs when the SMU completes a measurement action
smua.trigger.PULSE_COMPLETE_EVENT_ID	Occurs when the SMU completes a pulse
smua.trigger.SWEEP_COMPLETE_EVENT_ID	Occurs when the SMU completes a sweep
smua.trigger.IDLE_EVENT_ID	Occurs when the SMU returns to the idle state
digio.trigger[N].EVENT_ID	Occurs when an edge is detected on a digital I/O line
tsplink.trigger[N].EVENT_ID	Occurs when an edge is detected on a TSP-Link line
lan.trigger[N].EVENT_ID	Occurs when the appropriate LXI trigger packet is received on LAN trigger object <i>N</i>
display.trigger.EVENT_ID	Occurs when the TRIG key on the front panel is pressed

Trigger event IDs*	
Event ID	Event description
<code>trigger.EVENT_ID</code>	Occurs when a *TRG command is received on the remote interface GPIB only: Occurs when a GET bus command is received USB only: Occurs when a USBTMC TRIGGER message is received VXI-11 only: Occurs with the VXI-11 command <code>device_trigger</code> ; reference the VXI-11 standard for additional details on the device trigger operation
<code>trigger.blender[N].EVENT_ID</code>	Occurs after a collection of events is detected
<code>trigger.timer[N].EVENT_ID</code>	Occurs when a delay expires
<code>trigger.generator[N].EVENT_ID</code>	Occurs when the <code>trigger.generator[N].assert()</code> function is executed
* Use the name of the trigger event ID to set the stimulus value rather than the numeric value. Using the name makes the code compatible for future upgrades (for example, if the numeric values must change when enhancements are added to the instrument).	

Example

```
print(tsplink.trigger[3].stimulus)
```

Prints the event that will start TSP-Link trigger line 3 action.

Also see

[tsplink.trigger\[N\].assert\(\)](#) (on page 11-369)

[tsplink.trigger\[N\].reset\(\)](#) (on page 11-374)

tsplink.trigger[N].wait()

This function waits for a trigger.

Type	TSP-Link accessible	Affected by	Where saved	Default value
Function	Yes			

Usage

```
triggered = tsplink.trigger[N].wait(timeout)
```

<code>triggered</code>	Trigger detection indication; set to one of the following values: true: A trigger is detected during the timeout period false: A trigger is not detected during the timeout period
<code>N</code>	The trigger line (1 to 3)
<code>timeout</code>	The timeout value in seconds

Details

This function waits up to the timeout value for an input trigger. If one or more trigger events were detected since the last time `tsplink.trigger[N].wait()` or `tsplink.trigger[N].clear()` was called, this function returns immediately.

After waiting for a trigger with this function, the event detector is automatically reset and rearmed. This is true regardless of the number of events detected.

Example

```
triggered = tsplink.trigger[3].wait(10)
print(triggered)
```

Waits up to 10 seconds for a trigger on TSP-Link® line 3.
 If `false` is returned, no trigger was detected during the 10-second timeout.
 If `true` is returned, a trigger was detected.

Also see

[tsplink.trigger\[N\].clear\(\)](#) (on page 11-370)

tsplink.writebit()

This function sets a TSP-Link trigger line high or low.

Type	TSP-Link accessible	Affected by	Where saved	Default value
Function	Yes			

Usage

```
tsplink.writebit(N, data)
```

<i>N</i>	The trigger line (1 to 3)
<i>data</i>	The value to write to the bit: <ul style="list-style-type: none"> ■ Low: 0 ■ High: 1

Details

Use `tsplink.writebit()` and `tsplink.writeport()` to control the output state of the trigger line when trigger operation is set to `tsplink.TRIG_BYPASS`.

If the output line is write-protected by the `tsplink.writeprotect` attribute, this command is ignored.

The reset function does not affect the present states of the TSP-Link trigger lines.

Example

```
tsplink.writebit(3, 0)      Sets trigger line 3 low (0).
```

Also see

- [tsplink.readbit\(\)](#) (on page 11-367)
- [tsplink.readport\(\)](#) (on page 11-367)
- [tsplink.writeport\(\)](#) (on page 11-378)
- [tsplink.writeprotect](#) (on page 11-378)

tsplink.writeport()

This function writes to all TSP-Link synchronization lines.

Type	TSP-Link accessible	Affected by	Where saved	Default value
Function	Yes			

Usage

```
tsplink.writeport(data)
```

<i>data</i>	Value to write to the port (0 to 7)
-------------	-------------------------------------

Details

The binary representation of *data* indicates the output pattern that is written to the I/O port. For example, a data value of 2 has a binary equivalent of 010. Line 2 is set high (1), and the other two lines are set low (0).

Write-protected lines are not changed.

Use the `tsplink.writebit()` and `tsplink.writeport()` commands to control the output state of the synchronization line when trigger operation is set to `tsplink.TRIG_BYPASS`.

The `reset()` function does not affect the present states of the trigger lines.

Example

<code>tsplink.writeport(3)</code>	Sets the synchronization lines 1 and 2 high (binary 011).
-----------------------------------	---

Also see

- [tsplink.readbit\(\)](#) (on page 11-367)
- [tsplink.readport\(\)](#) (on page 11-367)
- [tsplink.writebit\(\)](#) (on page 11-377)
- [tsplink.writeprotect](#) (on page 11-378)

tsplink.writeprotect

This attribute contains the write-protect mask that protects bits from changes by the `tsplink.writebit()` and `tsplink.writeport()` functions.

Type	TSP-Link accessible	Affected by	Where saved	Default value
Attribute (RW)	Yes	Instrument reset Recall setup	Saved setup	0

Usage

```
mask = tsplink.writeprotect  
tsplink.writeprotect = mask
```

<i>mask</i>	An integer that specifies the value of the bit pattern for write-protect; set bits to 1 to write-protect the corresponding TSP-Link trigger line
-------------	--

Details

The binary equivalent of *mask* indicates the mask to be set for the TSP-Link trigger line. For example, a *mask* value of 5 has a binary equivalent of 101. This *mask* write-protects TSP-Link trigger lines 1 and 3.

Example

```
tsplink.writeprotect = 5
```

Write-protects TSP-Link trigger lines 1 and 3.

Also see

- [Controlling digital I/O lines](#) (on page 6-37)
- [tsplink.readbit\(\)](#) (on page 11-367)
- [tsplink.readport\(\)](#) (on page 11-367)
- [tsplink.writebit\(\)](#) (on page 11-377)
- [tsplink.writeport\(\)](#) (on page 11-378)

tspnet.clear()

This function clears any pending output data from the instrument.

Type	TSP-Link accessible	Affected by	Where saved	Default value
Function	No			

Usage

```
tspnet.clear(connectionID)
```

connectionID The connection ID returned from `tspnet.connect()`

Details

This function clears any pending output data from the device. No data is returned to the caller and no data is processed.

Example

```
tspnet.write(testdevice, "print([[hello]])")
print(tspnet.readavailable(testdevice))

tspnet.clear(testdevice)
print(tspnet.readavailable(testdevice))
```

Write data to a device, then print how much is available.
Output:
6.00000e+00

Clear data and print how much data is available again.
Output:
0.00000e+00

Also see

- [tspnet.connect\(\)](#) (on page 11-380)
- [tspnet.readavailable\(\)](#) (on page 11-384)
- [tspnet.write\(\)](#) (on page 11-390)

tspnet.connect()

This function establishes a network connection with another LAN instrument or device through the LAN interface.

Type	TSP-Link accessible	Affected by	Where saved	Default value
Function	No			

Usage

```
connectionID = tspnet.connect("ipAddress")
connectionID = tspnet.connect("ipAddress", portNumber, "initString")
```

<i>connectionID</i>	The connection ID to be used as a handle in all other <code>tspnet</code> function calls
<i>ipAddress</i>	IP address to which to connect in a string
<i>portNumber</i>	Port number (default 5025)
<i>initString</i>	Initialization string to send to <i>ipAddress</i>

Details

This command connects a device to another device through the LAN interface. If the *portNumber* is 23, the interface uses the Telnet protocol and sets appropriate termination characters to communicate with the device.

If a *portNumber* and *initString* are provided, it is assumed that the remote device is not TSP-enabled. The 2601B-PULSE does not perform any extra processing, prompt handling, error handling, or sending of commands. In addition, the `tspnet.tsp.*` commands cannot be used on devices that are not TSP-enabled.

If neither a *portNumber* nor an *initString* is provided, the remote device is assumed to be a Keithley Instruments TSP-enabled device. Depending on the state of the `tspnet.tsp.abortonconnect` attribute, the 2601B-PULSE sends an `abort` command to the remote device on connection.

The 2601B-PULSE also enables TSP prompts on the remote device and error management. The 2601B-PULSE places remote errors from the TSP-enabled device in its own error queue and prefaces these errors with `Remote Error`, followed by an error description.

Do not manually change either the prompt functionality (`localnode.prompts`) or show errors by changing `localnode.showerrors` on the remote TSP-enabled device. If you do this, subsequent `tspnet.tsp.*` commands using the connection may fail.

You can simultaneously connect to a maximum of 32 remote devices.

Example 1

```
instrumentID = tspnet.connect("192.0.2.1")
if instrumentID then
  -- Use instrumentID as needed here
  tspnet.disconnect(instrumentID)
end
```

Connect to a TSP-enabled device.

Example 2

```
instrumentID = tspnet.connect("192.0.2.1", 1394, "*rst\r\n")
if instrumentID then
  -- Use instrumentID as needed here
  tspnet.disconnect(instrumentID)
end
```

Connect to a device that is not TSP-enabled.

Also see

- [localnode.prompts](#) (on page 11-142)
- [localnode.showerrors](#) (on page 11-146)
- [tspnet.tsp.abortonconnect](#) (on page 11-387)
- [tspnet.disconnect\(\)](#) (on page 11-381)

tspnet.disconnect()

This function disconnects a specified TSP-Net session.

Type	TSP-Link accessible	Affected by	Where saved	Default value
Function	No			

Usage

```
tspnet.disconnect(connectionID)
```

<i>connectionID</i>	The connection ID returned from <code>tspnet.connect()</code>
---------------------	---

Details

This function disconnects the two devices by closing the connection. The *connectionID* is the session handle returned by `tspnet.connect()`.

For TSP-enabled devices, this aborts any remotely running commands or scripts.

Example

<pre>testID = tspnet.connect("192.0.2.0") -- Use the connection tspnet.disconnect(testID)</pre>	<p>Create a TSP-Net session.</p> <p>Close the session.</p>
---	--

Also see

- [tspnet.connect\(\)](#) (on page 11-380)

tspnet.execute()

This function sends a command string to the remote device.

Type	TSP-Link accessible	Affected by	Where saved	Default value
Function	No			

Usage

```
tspnet.execute("connectionID", "commandString")
value1 = tspnet.execute("connectionID", "commandString", formatString)
value1, value2 = tspnet.execute("connectionID", "commandString", formatString)
value1, ..., valueN = tspnet.execute("connectionID", "commandString", formatString)
```

<i>connectionID</i>	The connection ID returned from <code>tspnet.connect()</code>
<i>commandString</i>	The command to send to the remote device
<i>value1</i>	The first value decoded from the response message
<i>value2</i>	The second value decoded from the response message
<i>valueN</i>	The <i>N</i> th value decoded from the response message; there is one return value for each format specifier in the format string
...	One or more values separated with commas
<i>formatString</i>	Format string for the output

Details

This command sends a command string to the remote instrument. A termination is added to the command string when it is sent to the remote instrument (`tspnet.termination()`). You can also specify a format string, which causes the command to wait for a response from the remote instrument. The 2601B-PULSE decodes the response message according to the format specified in the format string and returns the message as return values from the function (see `tspnet.read()` for format specifiers).

When this command is sent to a TSP-enabled instrument, the 2601B-PULSE suspends operation until a timeout error is generated or until the instrument responds. The TSP prompt from the remote instrument is read and discarded. The 2601B-PULSE places any remotely generated errors into its error queue. When the optional format string is not specified, this command is equivalent to `tspnet.write()`, except that a termination is automatically added to the end of the command.

Example 1

```
tspnet.execute(instrumentID, "runScript()")
Command the remote device to run a script named runScript.
```

Example 2

```
tspnet.timeout = 5
id_instr = tspnet.connect("192.0.2.23", 23, "*rst\r\n")
tspnet.termination(id_instr, tspnet.TERM_CRLF)
tspnet.execute(id_instr, "*idn?")
print("tspnet.execute returns:", tspnet.read(id_instr))
Print the *idn? string from the remote device.
```

Also see

[tspnet.connect\(\)](#) (on page 11-380)
[tspnet.read\(\)](#) (on page 11-383)
[tspnet.termination\(\)](#) (on page 11-385)
[tspnet.write\(\)](#) (on page 11-390)

tspnet.idn()

This function retrieves the response of the remote device to *IDN?.

Type	TSP-Link accessible	Affected by	Where saved	Default value
Function	No			

Usage

```
idnString = tspnet.idn(connectionID)
```

<i>idnString</i>	The returned *IDN? string
<i>connectionID</i>	The connection ID returned from <code>tspnet.connect()</code>

Details

This function retrieves the response of the remote device to *IDN?.

Example

```
deviceID = tspnet.connect("192.0.2.1")
print(tspnet.idn(deviceID))
tspnet.disconnect(deviceID)
```

Assume the instrument is at IP address 192.0.2.1. The output that is produced when you connect to the instrument and read the identification string may appear as:
Keithley Instruments,Model 2601B-PULSE,
1398687, 1.0.0

Also see

[tspnet.connect\(\)](#) (on page 11-380)

tspnet.read()

This function reads data from a remote device.

Type	TSP-Link accessible	Affected by	Where saved	Default value
Function	No			

Usage

```
value1 = tspnet.read(connectionID)
value1 = tspnet.read(connectionID, formatString)
value1, value2 = tspnet.read(connectionID, formatString)
value1, ..., valueN = tspnet.read(connectionID, formatString)
```

<i>value1</i>	The first value decoded from the response message
<i>value2</i>	The second value decoded from the response message
<i>valueN</i>	The nth value decoded from the response message; there is one return value for each format specifier in the format string
...	One or more values separated with commas
<i>connectionID</i>	The connection ID returned from <code>tspnet.connect()</code>
<i>formatString</i>	Format string for the output, maximum of 10 specifiers

Details

This command reads available data from the remote instrument and returns responses for the specified number of arguments.

The format string can contain the following specifiers:

<code>%[width]s</code>	Read data until the specified length
<code>%[max width]t</code>	Read data until the specified length or until punctuation is found, whichever comes first
<code>%[max width]n</code>	Read data until a newline or carriage return
<code>%d</code>	Read a number (delimited by punctuation)

A maximum of 10 format specifiers can be used for a maximum of 10 return values.

If *formatString* is not provided, the command returns a string that contains the data until a new line is reached. If no data is available, the 2601B-PULSE pauses operation until the requested data is available or until a timeout error is generated. Use `tspnet.timeout` to specify the timeout period.

When the 2601B-PULSE reads from a TSP-enabled remote instrument, the 2601B-PULSE removes Test Script Processor (TSP®) prompts and places any errors it receives from the remote instrument into its own error queue. The 2601B-PULSE prefaces errors from the remote device with "Remote Error," followed by the error number and error description.

Example

```
tspnet.write(deviceID, "*idn?\r\n")
```

```
print("write/read returns:", tspnet.read(deviceID))
```

Send the "`*idn?\r\n`" message to the instrument connected as `deviceID`.

Display the response that is read from `deviceID` (based on the `*idn?` message).

Also see

[tspnet.connect\(\)](#) (on page 11-380)

[tspnet.readavailable\(\)](#) (on page 11-384)

[tspnet.timeout](#) (on page 11-386)

[tspnet.write\(\)](#) (on page 11-390)

tspnet.readavailable()

This function checks to see if data is available from the remote device.

Type	TSP-Link accessible	Affected by	Where saved	Default value
Function	No			

Usage

```
bytesAvailable = tspnet.readavailable(connectionID)
```

<i>bytesAvailable</i>	The number of bytes available to be read from the connection
<i>connectionID</i>	The connection ID returned from <code>tspnet.connect()</code>

Details

This command checks to see if any output data is available from the device. No data is read from the instrument. This allows TSP scripts to continue to run without waiting on a remote command to finish.

Example

```
ID = tspnet.connect("192.0.2.1")
tspnet.write(ID, "*idn?\r\n")
repeat bytes = tspnet.readavailable(ID) until bytes > 0
print(tspnet.read(ID))
tspnet.disconnect(ID)
```

Send commands that will create data.
Wait for data to be available.

Also see

[tspnet.connect\(\)](#) (on page 11-380)
[tspnet.read\(\)](#) (on page 11-383)

tspnet.reset()

This function disconnects all TSP-Net sessions.

Type	TSP-Link accessible	Affected by	Where saved	Default value
Function	No			

Usage

```
tspnet.reset()
```

Details

This command disconnects all remote instruments connected through TSP-Net. For TSP-enabled devices, this causes any commands or scripts running remotely to be terminated.

Also see

None

tspnet.termination()

This function sets the device line termination sequence.

Type	TSP-Link accessible	Affected by	Where saved	Default value
Function	No			

Usage

```
type = tspnet.termination(connectionID)
type = tspnet.termination(connectionID, termSequence)
```

<i>type</i>	An enumerated value indicating the termination type: <ul style="list-style-type: none"> ■ 1 or <code>tspnet.TERM_LF</code> ■ 4 or <code>tspnet.TERM_CR</code> ■ 2 or <code>tspnet.TERM_CRLF</code> ■ 3 or <code>tspnet.TERM_LFCR</code>
<i>connectionID</i>	The connection ID returned from <code>tspnet.connect()</code>
<i>termSequence</i>	The termination sequence

Details

This function sets and gets the termination character sequence that is used to indicate the end of a line for a TSP-Net connection.

Using the *termSequence* parameter sets the termination sequence. The present termination sequence is always returned.

For the *termSequence* parameter, use the same values listed in the table above for type. There are four possible combinations, all of which are made up of line feeds (LF or 0x10) and carriage returns (CR or 0x13). For TSP-enabled devices, the default is `tspnet.TERM_LF`. For devices that are not TSP-enabled, the default is `tspnet.TERM_CRLF`.

Example

```
deviceID = tspnet.connect("192.0.2.1")
if deviceID then
    tspnet.termination(deviceID, tspnet.TERM_LF)
end
```

Sets termination type for IP address 192.0.2.1 to `TERM_LF`.

Also see

[tspnet.connect\(\)](#) (on page 11-380)

[tspnet.disconnect\(\)](#) (on page 11-381)

tspnet.timeout

This attribute sets the timeout value for the `tspnet.connect()`, `tspnet.execute()`, and `tspnet.read()` commands.

Type	TSP-Link accessible	Affected by	Where saved	Default value
Attribute (RW)	No	Instrument reset Recall setup	Not saved	20.0 (20 s)

Usage

```
value = tspnet.timeout
tspnet.timeout = value
```

value The timeout duration in seconds (1 ms to 30.0 s)

Details

This attribute sets the amount of time the `tspnet.connect()`, `tspnet.execute()`, and `tspnet.read()` commands will wait for a response.

The time is specified in seconds. The timeout may be specified to millisecond resolution but is only accurate to the nearest 10 ms.

Example

```
tspnet.timeout = 2.0
```

Sets the timeout duration to 2 s.

Also see

[tspnet.connect\(\)](#) (on page 11-380)

[tspnet.execute\(\)](#) (on page 11-382)

[tspnet.read\(\)](#) (on page 11-383)

tspnet.tsp.abort()

This function causes the TSP-enabled instrument to stop executing any of the commands that were sent to it.

Type	TSP-Link accessible	Affected by	Where saved	Default value
Function	No			

Usage

```
tspnet.tsp.abort(connectionID)
```

<i>connectionID</i>	Integer value used as a handle for other <code>tspnet</code> commands
---------------------	---

Details

This function is appropriate only for TSP-enabled instruments.

Sends an abort command to the remote instrument.

Example

<code>tspnet.tsp.abort(testConnection)</code>	Stops remote instrument execution on <code>testConnection</code> .
---	--

Also see

None

tspnet.tsp.abortonconnect

This attribute contains the setting for abort on connect to a TSP-enabled instrument.

Type	TSP-Link accessible	Affected by	Where saved	Default value
Attribute (RW)	No	Instrument reset Recall setup	Not saved	1 (enable)

Usage

```
tspnet.tsp.abortonconnect = value
value = tspnet.tsp.abortonconnect
```

<i>value</i>	<ul style="list-style-type: none"> ▪ Enable: 1 ▪ Disable: 0
--------------	---

Details

This setting determines if the instrument sends an abort message when it attempts to connect to a TSP-enabled instrument using the `tspnet.connect()` function.

When you send the abort command on an interface, it causes any other active interface on that instrument to close. If you do not send an abort command (or if `tspnet.tsp.abortonconnect` is set to 0) and another interface is active, connecting to a TSP-enabled remote instrument results in a connection. However, the instrument will not respond to subsequent reads or executes because control of the instrument is not obtained until an abort command has been sent.

Example

```
tspnet.tsp.abortonconnect = 0
```

Configure the instrument so that it does not send an abort command when connecting to a TSP-enabled instrument.

Also see

[tspnet.connect\(\)](#) (on page 11-380)

tspnet.tsp.rhtablecopy()

This function copies a reading buffer synchronous table from a remote instrument to a TSP-enabled instrument.

Type	TSP-Link accessible	Affected by	Where saved	Default value
Function	No			

Usage

```
table = tspnet.tsp.rhtablecopy(connectionID, "name")
table = tspnet.tsp.rhtablecopy(connectionID, "name", startIndex, endIndex)
```

<i>table</i>	A copy of the synchronous table or a string
<i>connectionID</i>	Integer value used as a handle for other <code>tspnet</code> commands
<i>name</i>	The full name of the reading buffer name and synchronous table to copy
<i>startIndex</i>	Integer start value
<i>endIndex</i>	Integer end value

Details

This function is only appropriate for TSP-enabled instruments.

This function reads the data from a reading buffer on a remote instrument and returns an array of numbers or a string representing the data. The *startIndex* and *endIndex* parameters specify the portion of the reading buffer to read. If no index is specified, the entire buffer is copied.

The function returns a table if the table is an array of numbers; otherwise a comma-delimited string is returned.

This command is limited to transferring 50,000 readings at a time.

Example

```
t = tspnet.tsp.rhtablecopy(testConnection,
    "testRemotebuffername.readings", 1, 3)
print(t[1], t[2], t[3])
```

Copy the specified readings table for buffer items 1 through 3, then display the first three readings. Example output:

```
4.56534e-01
4.52675e-01
4.57535e-01
```

Also see

None

tspnet.tsp.runscript()

This function loads and runs a script on a remote TSP-enabled instrument.

Type	TSP-Link accessible	Affected by	Where saved	Default value
Function	Yes			

Usage

```
tspnet.tsp.runscript(connectionID, "script")
tspnet.tsp.runscript(connectionID, "name", "script")
```

<i>connectionID</i>	Integer value used as an identifier for other <code>tspnet</code> commands
<i>name</i>	The name that is assigned to the script
<i>script</i>	The body of the script as a string

Details

This function is appropriate only for TSP-enabled instruments.

This function downloads a script to a remote instrument and runs it. It automatically adds the appropriate `loadscript` and `endscript` commands around the script, captures any errors, and reads back any prompts. No additional substitutions are done on the text.

The script is automatically loaded, compiled, and run.

Any output from previous commands is discarded.

This command does not wait for the script to complete.

If you do not want the script to do anything immediately, make sure the script only defines functions for later use. Use the `tspnet.execute()` function to execute those functions later.

If no name is specified, the script is loaded as the anonymous script.

Example

```
tspnet.tsp.runscript(myconnection, "mytest",
"print([[start]]) for d = 1, 10 do print([[work]]) end print([[end]])")
```

Load and run a script entitled `mytest` on the TSP-enabled instrument connected with `myconnection`.

Also see

[tspnet.execute\(\)](#) (on page 11-382)

tspnet.write()

This function writes a string to the remote instrument.

Type	TSP-Link accessible	Affected by	Where saved	Default value
Function	No			

Usage

```
tspnet.write(connectionID, "inputString")
```

<i>connectionID</i>	The connection ID returned from <code>tspnet.connect()</code>
<i>inputString</i>	The string to be written

Details

The `tspnet.write()` function sends *inputString* to the remote instrument. It does not wait for command completion on the remote instrument.

The 2601B-PULSE sends *inputString* to the remote instrument exactly as indicated. The *inputString* must contain any necessary new lines, termination, or other syntax elements needed to complete properly.

Because `tspnet.write()` does not process output from the remote instrument, do not send commands that generate too much output without processing the output. This command can stop executing if there is too much unprocessed output from previous commands.

Example

```
tspnet.write(myID, "runscript()\r\n")
```

Commands the remote instrument to execute a command or script named `runscript()` on a remote device identified in the system as `myID`.

Also see

[tspnet.connect\(\)](#) (on page 11-380)

[tspnet.read\(\)](#) (on page 11-383)

userstring.add()

This function adds a user-defined string to nonvolatile memory.

Type	TSP-Link accessible	Affected by	Where saved	Default value
Function	No			

Usage

```
userstring.add("name", "value")
```

<i>name</i>	The name of the string; the key of the key-value pair
<i>value</i>	The string to associate with <i>name</i> ; the value of the key-value pair

Details

This function associates the string *value* with the string *name* and stores this key-value pair in nonvolatile memory.

Use the `userstring.get()` function to retrieve the *value* associated with the specified *name*.

You can use the `userstring` functions to store custom, instrument-specific information in the instrument, such as department number, asset number, or manufacturing plant location.

Example

```
userstring.add("assetnumber", "236")
userstring.add("product", "Widgets")
userstring.add("contact", "John Doe")
for name in userstring.catalog() do
  print(name .. " = " ..
        userstring.get(name))
end
```

Stores user-defined strings in nonvolatile memory and recalls them from the instrument using a for loop.
Example output:
 assetnumber = 236
 contact = John Doe
 product = Widgets

Also see

[userstring.catalog\(\)](#) (on page 11-391)

[userstring.delete\(\)](#) (on page 11-392)

[userstring.get\(\)](#) (on page 11-393)

userstring.catalog()

This function creates an iterator for the user-defined string catalog.

Type	TSP-Link accessible	Affected by	Where saved	Default value
Function	No			

Usage

```
for name in userstring.catalog() do body end
```

<i>name</i>	The name of the string; the key of the key-value pair
<i>body</i>	Code to execute in the body of the for loop

Details

The catalog provides access for user-defined string pairs, allowing you to manipulate all the key-value pairs in nonvolatile memory. The entries are enumerated in no particular order.

Example 1

```
for name in userstring.catalog() do
  userstring.delete(name)
end
```

Deletes all user-defined strings in nonvolatile memory.

Example 2

```

userstring.add("assetnumber", "236")
userstring.add("product", "Widgets")
userstring.add("contact", "John Doe")
for name in userstring.catalog() do
  print(name .. " = " ..
        userstring.get(name))
end

```

Prints all `userstring` key-value pairs.

Output:

```

product = Widgets
assetnumber = 236
contact = John Doe

```

Notice the key-value pairs are not listed in the order they were added.

Also see

[userstring.add\(\)](#) (on page 11-390)

[userstring.delete\(\)](#) (on page 11-392)

[userstring.get\(\)](#) (on page 11-393)

userstring.delete()

This function deletes a user-defined string from nonvolatile memory.

Type	TSP-Link accessible	Affected by	Where saved	Default value
Function	No			

Usage

```
userstring.delete("name")
```

name

The name (key) of the key-value pair of the user-defined string to delete

Details

This function deletes the string that is associated with *name* from nonvolatile memory.

Example

```

userstring.delete("assetnumber")
userstring.delete("product")
userstring.delete("contact")

```

Deletes the user-defined strings associated with the `assetnumber`, `product`, and `contact` names.

Also see

[userstring.add\(\)](#) (on page 11-390)

[userstring.catalog\(\)](#) (on page 11-391)

[userstring.get\(\)](#) (on page 11-393)

userstring.get()

This function retrieves a user-defined string from nonvolatile memory.

Type	TSP-Link accessible	Affected by	Where saved	Default value
Function	No			

Usage

```
value = userstring.get("name")
```

<i>value</i>	The value of the user-defined string key-value pair
<i>name</i>	The name (key) of the user-defined string

Details

This function retrieves the string that is associated with *name* from nonvolatile memory.

Example

```
userstring.add("assetnumber", "236")
value = userstring.get("assetnumber")
print(value)
```

Create the user-defined string `assetnumber`, set to a value of 236.
 Read the value associated with the user-defined string named `assetnumber`.
 Store it in a variable called `value`, then print the variable `value`.
 Output:
 236

Also see

- [userstring.add\(\)](#) (on page 11-390)
- [userstring.catalog\(\)](#) (on page 11-391)
- [userstring.delete\(\)](#) (on page 11-392)

waitcomplete()

This function waits for all previously started overlapped commands to complete.

Type	TSP-Link accessible	Affected by	Where saved	Default value
Function	No			

Usage

```
waitcomplete()
waitcomplete(group)
```

<i>group</i>	Specifies which TSP-Link group on which to wait
--------------	---

Details

There are two types of instrument commands:

- **Overlapped commands:** Commands that allow the execution of subsequent commands while instrument operations of the overlapped command are still in progress.
- **Sequential commands:** Commands whose operations must finish before the next command is executed.

The `waitcomplete()` command suspends the execution of commands until the instrument operations of all previous overlapped commands are finished. This command is not needed for sequential commands.

A group number may only be specified when this node is the master node.

If no *group* is specified, the local group is used.

If zero (0) is specified for the *group*, this function waits for all nodes in the system.

NOTE

Any nodes that are not assigned to a group (group number is 0) are part of the master node's group.

Example 1

```
waitcomplete()
```

Waits for all nodes in the local group.

Example 2

```
waitcomplete(G)
```

Waits for all nodes in group G.

Example 3

```
waitcomplete(0)
```

Waits for all nodes on the TSP-Link network.

Also see

None

Troubleshooting guide

In this section:

Introduction	12-1
Error levels	12-1
Effects of errors on scripts.....	12-1
Retrieving errors.....	12-2
Error summary list.....	12-2

Introduction

Troubleshooting information includes information on the Keithley Instruments 2601B-PULSE errors (including a complete listing of error messages) and LAN troubleshooting suggestions.

Error levels

Errors have one of the following error levels:

Number	Error level	Description
0	NO_SEVERITY	The message is information only. This level is used when the error queue is empty; the message does not represent an error.
10	INFORMATIONAL	The message is information only. This level is used to indicate status changes; the message does not represent an error.
20	RECOVERABLE	The error was caused by improper use of the instrument or by conditions that can be corrected. This message indicates that an error occurred. The instrument is still operating normally.
30	SERIOUS	There is a condition that prevents the instrument from functioning properly. The message indicates that the instrument is presently operating in an error condition. If the condition is corrected, the instrument will return to normal operation.
40	FATAL	There is a condition that cannot be corrected that prevents the instrument from functioning properly. Disconnect the DUT and turn the power off and then on again. If the error is a hardware fault that persists after cycling the power, the instrument must be repaired.

Effects of errors on scripts

Most errors do not abort a running script. The only time a script is aborted is when a Lua runtime error (error code -286, "TSP runtime error") is detected. Runtime errors are caused by actions such as trying to index into a variable that is not a table.

Syntax errors (error code -285, "Program syntax") in a script or command prevent execution of the script or command.

Retrieving errors

When errors occur, the error messages are placed in the error queue. Use `errorqueue` commands to request error message information. For example, the following commands request the complete set of information about the next message in the error queue. They return the code, message, severity, and node for that error:

```
errorCode, message, severity, errorNode = errorqueue.next()
print(errorCode, message, severity, errorNode)
```

The following table lists the commands associated with the error queue.

Remote commands associated with the error queue	
Command	Description
errorqueue.clear() (on page 11-76)	Clear error queue of all errors
errorqueue.count (on page 11-76)	Number of messages in the error queue
errorqueue.next() (on page 11-77)	Request next error message from queue

Error summary list

Error summary

Error number	Error level	Error message
-430	RECOVERABLE	Query DEADLOCKED
-420	RECOVERABLE	Query UNTERMINATED
-410	RECOVERABLE	Query INTERRUPTED
-363	RECOVERABLE	Input buffer overrun
-360	RECOVERABLE	Communications error
-350	RECOVERABLE	Queue overflow
-315	RECOVERABLE	Configuration memory lost
-314	RECOVERABLE	Save/recall memory lost
-292	RECOVERABLE	Referenced name does not exist
-286	RECOVERABLE	TSP Runtime error
-285	RECOVERABLE	Program syntax
-282	RECOVERABLE	Illegal program name
-281	RECOVERABLE	Cannot create program
-225	RECOVERABLE	Out of memory or TSP Memory allocation error
-224	RECOVERABLE	Illegal parameter value
-222	RECOVERABLE	Parameter data out of range
-221	RECOVERABLE	Settings conflict
-220	RECOVERABLE	Parameter error
-211	RECOVERABLE	Trigger ignored
-203	RECOVERABLE	Command protected
-154	RECOVERABLE	String too long
-151	RECOVERABLE	Invalid string data
-110	RECOVERABLE	Command header error
-109	RECOVERABLE	Missing parameter
-108	RECOVERABLE	Parameter not allowed
-105	RECOVERABLE	Trigger not allowed
-104	RECOVERABLE	Data type error

Error summary

Error number	Error level	Error message
0	NO_SEVERITY	Queue Is Empty
503	RECOVERABLE	Calibration overflow
601	RECOVERABLE	Reading buffer data lost
603	RECOVERABLE	Power on state lost
702	FATAL	Unresponsive digital FPGA
802	RECOVERABLE	OUTPUT blocked by interlock
819	RECOVERABLE	Error parsing exponent
820	RECOVERABLE	Error parsing value
900	FATAL	Internal system error
1100	RECOVERABLE	Command unavailable
1101	RECOVERABLE	Parameter too big
1102	RECOVERABLE	Parameter too small
1103	RECOVERABLE	Min greater than max
1104	RECOVERABLE	Too many digits for param type
1105	RECOVERABLE	Too many parameters
1107	RECOVERABLE	Cannot modify factory menu
1108	RECOVERABLE	Menu name does not exist
1109	RECOVERABLE	Menu name already exists
1110	FATAL	Analog supply failure: over temperature
1113	RECOVERABLE	Data too complex
1122	SERIOUS	Interlock or power supply failure
1200	RECOVERABLE	TSP-Link initialization failed
1202	RECOVERABLE	TSP-Link initialization failed
1203	RECOVERABLE	TSP-Link initialization failed (possible loop in node chain)
1204	RECOVERABLE	TSP-Link initialization failed
1205	RECOVERABLE	TSP-Link initialization failed (no remote nodes found)
1206	RECOVERABLE	TSP-Link initialization failed
1207	RECOVERABLE	TSP-Link initialization failed
1208	RECOVERABLE	TSP-Link initialization failed
1209	RECOVERABLE	TSP-Link initialization failed
1210	RECOVERABLE	TSP-Link initialization failed (node ID conflict)
1211	RECOVERABLE	Node NN is inaccessible
1212	RECOVERABLE	Invalid node ID
1213	RECOVERABLE	TSP-Link session expired
1215	RECOVERABLE	Code execution requested within the local group
1216	RECOVERABLE	Remote execution requested on node in group with pending overlapped operations
1217	RECOVERABLE	Remote execution requested on node outside the local group
1218	RECOVERABLE	Operation allowed only when TSP-Link master
1219	RECOVERABLE	TSP-Link found fewer nodes than expected
1400	RECOVERABLE	Expected at least NN parameters
1401	RECOVERABLE	Parameter NN is invalid
1402	RECOVERABLE	User scripts lost
1403	RECOVERABLE	Factory scripts lost
1404	RECOVERABLE	Invalid byte order
1405	RECOVERABLE	Invalid ASCII precision
1406	RECOVERABLE	Invalid data format
1500	RECOVERABLE	Invalid baud rate setting
1501	RECOVERABLE	Invalid parity setting
1502	RECOVERABLE	Invalid terminator setting
1503	RECOVERABLE	Invalid bits setting

Error summary

Error number	Error level	Error message
1504	RECOVERABLE	Invalid flow control setting
1600	RECOVERABLE	Maximum GPIB message length exceeded
1700	RECOVERABLE	Display area boundary exceeded
1800	RECOVERABLE	Invalid digital trigger mode
1801	RECOVERABLE	Invalid digital I/O line
2000	SERIOUS	Flash download error
2001	RECOVERABLE	Cannot flash with error in queue
2101	FATAL	Could not close socket
2102	RECOVERABLE	Lan configuration already in progress
2103	RECOVERABLE	Lan disabled
2104	RECOVERABLE	Socket error
2105	RECOVERABLE	Unreachable gateway
2106	RECOVERABLE	Could not acquire ip address
2110	RECOVERABLE	Could not resolve hostname
2111	RECOVERABLE	DNS name (FQDN) too long
2112	RECOVERABLE	Connection not established
2200	RECOVERABLE	File write error
2201	RECOVERABLE	File read error
2202	RECOVERABLE	Cannot close file
2203	RECOVERABLE	Cannot open file
2204	RECOVERABLE	Directory not found
2205	RECOVERABLE	File not found
2206	RECOVERABLE	Cannot read current working directory
2207	RECOVERABLE	Cannot change directory
2211	RECOVERABLE	File system error
2212	RECOVERABLE	File system command not supported
2213	RECOVERABLE	Too many open files
2214	RECOVERABLE	File access denied
2215	RECOVERABLE	Invalid file handle
2216	RECOVERABLE	Invalid drive
2217	RECOVERABLE	File system busy
2218	RECOVERABLE	Disk full
2219	RECOVERABLE	File corrupt
2220	RECOVERABLE	File already exists
2221	RECOVERABLE	File seek error
2222	RECOVERABLE	End-of-file error
2223	RECOVERABLE	Directory not empty
2400	RECOVERABLE	Invalid specified connection
2401	RECOVERABLE	Invalid timeout seconds (.001 to 30)
2402	RECOVERABLE	TSPnet remote error: XXX, where XXX explains the remote error
2403	RECOVERABLE	TSPnet failure
2404	RECOVERABLE	TSPnet read failure
2405	RECOVERABLE	TSPnet read failure, aborted
2406	RECOVERABLE	TSPnet read failure, timeout
2407	RECOVERABLE	TSPnet write failure
2408	RECOVERABLE	TSPnet write failure, aborted
2409	RECOVERABLE	TSPnet write failure, timeout
2410	RECOVERABLE	TSPnet max connections reached
2411	RECOVERABLE	TSPnet connection failed
2412	RECOVERABLE	TSPnet invalid termination
2413	RECOVERABLE	TSPnet invalid reading buffer table

Error summary

Error number	Error level	Error message
2414	RECOVERABLE	TSPnet invalid reading buffer index range
2415	RECOVERABLE	TSPnet feature only supported on TSP connections
2416	RECOVERABLE	TSPnet must specify both port and init
2417	RECOVERABLE	TSPnet disconnected by other side
2418	RECOVERABLE	TSPnet read input buffer overflow
2419	RECOVERABLE	Invalid format specifier
2420	RECOVERABLE	Termination locked while using TSP connection
2500	RECOVERABLE	Average delay must be at least NNN seconds
4900	RECOVERABLE	Reading buffer index NN is invalid
4903	RECOVERABLE	Reading buffer expired
4904	SERIOUS	ICX parameter count mismatch, %s (Line #%d)
4905	SERIOUS	ICX parameter invalid value, %s (Line #%d)
4906	SERIOUS	ICX invalid function id, %s (Line #%d)
5001	FATAL	SMU is unresponsive. Disconnect DUT and cycle power
5003	SERIOUS	Saved calibration constants corrupted
5004	RECOVERABLE	Operation conflicts with CALA sense mode
5005	RECOVERABLE	Value too big for range
5007	RECOVERABLE	Operation would exceed safe operating area of the instrument
5008	RECOVERABLE	Operation not permitted while OUTPUT is on
5009	SERIOUS	Unknown sourcing function
5010	SERIOUS	No such SMU function
5011	RECOVERABLE	Operation not permitted while cal is locked
5012	RECOVERABLE	Cal data not saved - save or restore before lock
5013	RECOVERABLE	Cannot save cal data - unlock before save
5014	RECOVERABLE	Cannot restore cal data - unlock before restore
5015	RECOVERABLE	Save to cal set disallowed
5016	RECOVERABLE	Cannot change cal date - unlock before operation
5017	RECOVERABLE	Cannot change cal constants - unlock before operation
5018	SERIOUS	Cal version inconsistency
5019	RECOVERABLE	Cannot unlock - invalid password
5021	SERIOUS	Cannot restore default calset. Using previous calset
5022	SERIOUS	Cannot restore previous calset. Using factory calset
5023	SERIOUS	Cannot restore factory calset. Using nominal calset
5024	SERIOUS	Cannot restore nominal calset. Using firmware defaults
5025	RECOVERABLE	Cannot set filter.count > 1 when measure.count > 1
5027	RECOVERABLE	Unlock cal data with factory password
5028	RECOVERABLE	Cannot perform requested operation while source autorange is enabled
5029	RECOVERABLE	Cannot save without changing cal adjustment date
5032	RECOVERABLE	Cannot change this setting unless buffer is cleared
5033	RECOVERABLE	Reading buffer not found within device
5038	RECOVERABLE	Index exceeds maximum reading
5040	RECOVERABLE	Cannot use same reading buffer for multiple overlapped measurements
5042	RECOVERABLE	Cannot perform requested action while an overlapped operation is in progress
5043	RECOVERABLE	Cannot perform requested operation while voltage measure autorange is enabled
5044	RECOVERABLE	Cannot perform requested operation while current measure autorange is enabled
5045	RECOVERABLE	Cannot perform requested operation while filter is enabled
5046	SERIOUS	SMU too hot

Error summary

Error number	Error level	Error message
5047	RECOVERABLE	Minimum timestamp resolution is 1us
5048	RECOVERABLE	Contact check not valid with HIGH-Z OUTPUT off
5049	RECOVERABLE	Contact check not valid while an active current source
5050	RECOVERABLE	I limit too low for contact check
5051	FATAL	Model number/SMU hardware mismatch. Disconnect DUT and cycle power
5053	RECOVERABLE	Unstable output detected - Measurements may not be valid
5055	RECOVERABLE	Cannot change adjustment date - change cal constants before operation
5059	RECOVERABLE	trigger.source.action enabled without configuration
5060	RECOVERABLE	trigger.measure.action enabled without configuration
5061	RECOVERABLE	Operation not permitted while OUTPUT is off
5062	SERIOUS	SMU overload. Automatic OUTPUT off.
5063	RECOVERABLE	Cannot perform requested operation while measure autozero is on
5064	RECOVERABLE	Cannot use reading buffer that collects source values
5065	RECOVERABLE	I range too low for contact check
5066	RECOVERABLE	source.offlimiti too low for contact check
5069	SERIOUS	Autorange locked for HighC mode
5108	RECOVERABLE	Maximum pulse width exceeded
5109	RECOVERABLE	Maximum duty cycle exceeded
5111	RECOVERABLE	Total measure time exceeds pulse width
5126	RECOVERABLE	Operation not permitted while pulser is enabled
5127	RECOVERABLE	Output protection level exceeded
5128	RECOVERABLE	Pulse width too small
5129	RECOVERABLE	Measure time exceeds measure interval
5130	RECOVERABLE	Filter type not permitted while pulser is enabled
5131	RECOVERABLE	Current source as off-function not permitted while pulser is enabled
5132	RECOVERABLE	Voltage sweeps not permitted while pulser is enabled
5133	RECOVERABLE	Measure stimulus not allowed with pulser measure delay when pulser is enabled
5134	RECOVERABLE	Measure stimulus requires asynchronous measure when pulser is enabled
5135	RECOVERABLE	Measure not permitted with output off when pulser is enabled
5136	RECOVERABLE	Measure count too big with pulser enabled
5137	RECOVERABLE	Measure interval too big with pulser enabled
5138	RECOVERABLE	trigger.source.action required when pulser is enabled
5139	RECOVERABLE	trigger.source.stimulus required when pulser is enabled
5140	RECOVERABLE	Measure stimulus or measure delay required when pulser is enabled
5141	RECOVERABLE	Pulse width not permitted when pulser is disabled
5142	RECOVERABLE	Measure count multiplied by filter count is too big
5143	RECOVERABLE	End pulse stimulus or pulse width required when pulser is enabled
5144	RECOVERABLE	Maximum measurement rate exceeded
5145	RECOVERABLE	Maximum pulse rate exceeded

Calibration

In this section:

Calibration 13-1
Adjustment 13-19

Calibration

WARNING

The information in this section is intended for qualified service personnel only, as described by the types of product users in the Safety Precautions pages, provided at the beginning of this document. Do not attempt these procedures unless you are qualified to do so.

Some of these procedures may expose you to hazardous voltages, that if contacted, could cause personal injury or death. Use appropriate safety precautions when working with hazardous voltages.

Use the procedures in this section to verify that the 2601B-PULSE accuracy is within the limits stated in the one-year accuracy specifications of the instrument. Perform the calibration procedures:

- When you first receive the instrument to make sure that it was not damaged during shipment.
- To verify that the instrument meets factory specifications.
- To determine if calibration adjustment is required.
- After performing a calibration adjustment to make sure the instrument was adjusted properly.

The 2601B-PULSE contains a SMU module and a pulse module. Each module requires separate calibration and adjustment. The instructions in this section for the SMU use the front panel. You can also use remote programming commands. The pulse module must be calibrated and adjusted using remote commands. Refer to [Instrument programming](#) (on page 10-1) for information on using commands to control the instrument.

NOTE

If the instrument is still under warranty and its performance is outside specified limits, contact your Keithley Instruments representative or the factory to determine the correct course of action.

Calibration test requirements

Be sure that you perform the calibration tests:

- Under the proper environmental conditions.
- After the specified warmup period.
- Using the correct line voltage.
- Using the proper test equipment.
- Using the specified output signal and reading limits.

NOTE

Product specifications are subject to change. Listed uncertainties and test limits are provided only as examples. Always verify values against the most recent product specifications.

Environmental conditions

Conduct your performance calibration procedures in a test environment with:

- An ambient temperature of 18 °C to 28 °C.
- A relative humidity of less than 70 percent unless otherwise noted.

NOTE

Product specifications that are listed as 18 °C to 28 °C assume adjustment has been done at 23 °C. If the 2601B-PULSE is adjusted at a different temperature, the specifications apply to ± 5 °C of that adjustment temperature.

Line power

The 2601B-PULSE requires a line voltage of 100 V to 240 V and a line frequency of 50 Hz or 60 Hz. Perform calibration tests in this range.

Warmup period

Allow the 2601B-PULSE to warm up for at least two hours before conducting the calibration procedures.

If the instrument has been subjected to temperature extremes (those outside the ranges stated above), allow additional time for the internal temperature of the instrument to stabilize. Typically, allow one extra hour to stabilize an instrument that is 10 °C outside the specified temperature range.

Also allow test equipment to warm up for the minimum time specified by the manufacturer.

Recommended calibration equipment

The following table summarizes recommended maximum allowable test equipment uncertainty for calibration points. Total test equipment measurement uncertainty should meet or be less than the listed values at each test point. Generally, test equipment uncertainty should be at least four times better than corresponding 2601B-PULSE specifications.

Recommended calibration equipment

Description	Manufacturer and model	Accuracy		
Digital multimeter	Keithley Instruments Model 2002 or Keysight 3458A	DC voltage ¹	90 mV:	±8 ppm
			0.9 V:	±5 ppm
			5.4 V:	±4 ppm
			36 V:	±6 ppm
		DC current ¹	90 nA:	±430 ppm
			0.9 mA:	±45 ppm
			9 µA:	±25 ppm
			90 µA:	±23 ppm
			0.9 mA:	±20 ppm
			9 mA:	±20 ppm
			90 mA:	±35 ppm
			0.9 A:	±110 ppm
0.5 Ω, 250 W, 0.1% precision resistor	Isotek RUG-Z-R500-0.1-TK3	Resistance ²	0.5 Ω:	±125 ppm
Digitizer	Keysight 3458A			
1 Ω, 10 V, 1% pulse load	N/A	Resistance ³	1 Ω:	±100 ppm
10 Ω, 10 V, 1% pulse load	N/A	Resistance ³	10 Ω:	±25 ppm
1. Ninety-day specifications show full-range accuracy of recommended model used for specified measurement point. 2. Resistor used to test 3 A range only should be characterized to uncertainty shown using resistance function of digital multimeter before use. 3. See Pulse loads (on page 13-3) for detail on creating pulse loads.				

Pulse loads

You will need pulse loads for the pulse accuracy and bias source accuracy calibrations and adjustments. The connections are the same for both pulse loads, but the resistor value is different. For the pulse accuracy procedures, R1 and R2 are 2 ohm resistors. For the bias accuracy procedures, R1 and R2 are 20 ohm resistors.

The connector to mate with the rear panel CHANNEL A: DC/PULSE connector is Phoenix Contact connector part number 1825378 (Tek part number 131930700). Recommended wire size is 22 AWG.

Figure 149: Pulse load schematic

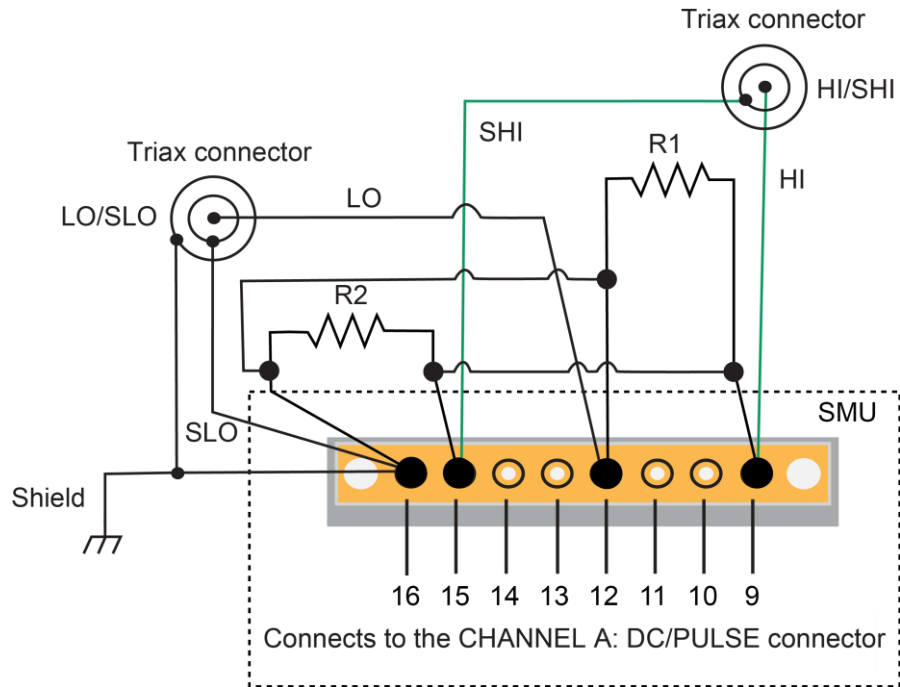

Calibration limits

The calibration limits stated in this section have been calculated using only the 2601B-PULSE one-year accuracy specifications. They do not include test equipment uncertainty. If a particular measurement falls outside the allowable range, recalculate new limits based both on the 2601B-PULSE specifications and corresponding test equipment specifications.

Source limit calculations

As an example of how calibration limits are calculated, assume you are testing the 2601B-PULSE 6 V dc output range using a 5.4 V output value. Using the one-year accuracy specification for 5.4 V dc output of $\pm (0.02\% \text{ of output} + 1.8 \text{ mV offset})$, the calculated output limits are:

$$\text{Output limits} = 5.4 \text{ V} \pm [(5.4 \text{ V} \times 0.02\%) + 1.8 \text{ mV}]$$

$$\text{Output limits} = 5.4 \text{ V} \pm (0.00108 \text{ V} + 0.0018 \text{ V})$$

$$\text{Output limits} = 5.4 \text{ V} \pm 0.00288 \text{ V}$$

$$\text{Output limits} = 5.39712 \text{ V to } 5.40288 \text{ V}$$

Measurement limit calculations

Measurement limits are calculated in the same way as the source limits, except that the limits are calculated with respect to the measurement of the external reference instrument.

Uninstalling the 2601B-P-INT

The 2601B-PULSE is normally operated with the 2601B-P-INT Interlock and Cable Connector Box installed on the rear panel of the instrument. To perform the calibration and adjust procedures, you must uninstall the 2601B-P-INT.

To uninstall the 2601B-P-INT:

1. Remove power connections from the 2601B-PULSE.
2. Use a Phillips head screwdriver to remove the screws that secure the 2601B-P-INT to the rear panel of the 2601B-PULSE.

Figure 150: 2601B-P-INT mounting screws

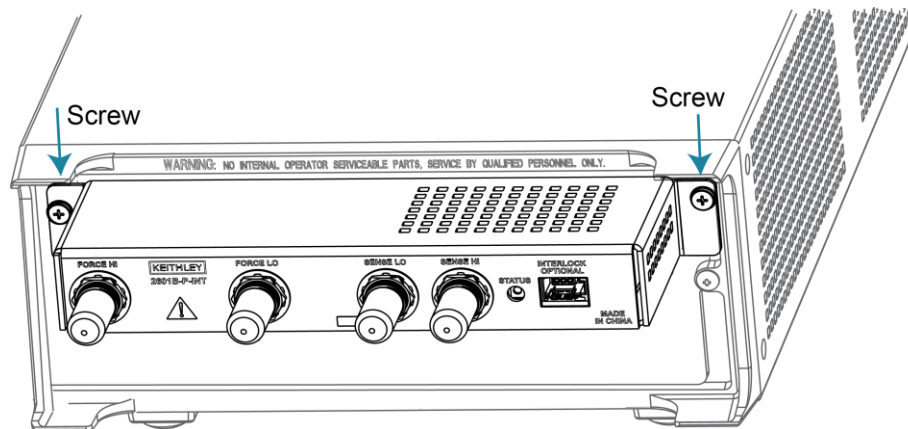

3. Pull the 2601B-P-INT straight back from the rear panel to detach it from the terminal strips.
4. Keep the screws and 2601B-P-INT for reinstallation.

Restoring factory defaults

Before performing the calibration procedures, restore the instrument to its factory defaults.

To restore the factory defaults:

1. Press the **MENU** key.
2. Scroll to the **SETUP** menu item, and then press the **ENTER** key.
3. Scroll to the **RECALL** menu item, and then press the **ENTER** key.
4. Scroll to the **INTERNAL** menu item, and then press the **ENTER** key.
5. Scroll to the **FACTORY** menu item.
6. Press the **ENTER** key to restore defaults.

Performing the calibration test procedures

Perform the following calibration tests to make sure the instrument is operating within specifications:

- [Current source accuracy](#) (on page 13-8)
- [Current measurement accuracy](#) (on page 13-10)
- [Voltage source accuracy](#) (on page 13-12)
- [Voltage measurement accuracy](#) (on page 13-14)
- [Pulse accuracy](#) (on page 13-15)
- [Bias source accuracy](#) (on page 13-18)

If the 2601B-PULSE is not within specifications and not under warranty, see the procedures in [Adjustment](#) (on page 13-19) for information on adjusting the instrument.

Test considerations

When performing the calibration procedures:

- Be sure to restore factory front panel defaults as described in [Restoring factory defaults](#) (on page 13-5).
- Make sure that the test equipment is properly warmed up and connected to the 2601B-PULSE output terminals. Use 4-wire sensing for voltage.
- Make sure the 2601B-PULSE SMU is set to the correct source range.
- Be sure the 2601B-PULSE SMU output is turned on before making measurements.
- Be sure the test equipment is set up for the proper function and range.
- Allow the 2601B-PULSE SMU output signal to settle before making a measurement.
- Do not connect test equipment to the 2601B-PULSE through a scanner, multiplexer, or other switching equipment.

WARNING

The FORCE and SENSE connectors of the 2601B-PULSE are rated for connection to circuits rated Measurement Category I only, with transients rated less than 1500 V_{PEAK}. Do not connect the 2601B-PULSE terminals to CAT II, CAT III, or CAT IV circuits. Connections of the input/output connectors to circuits higher than CAT I can cause damage to the equipment or expose the operator to hazardous voltages.



WARNING

Hazardous voltages may be present on all output and guard terminals. To prevent electrical shock that could cause injury or death, never make or break connections to the 2601B-PULSE while the instrument is powered on. Turn off the equipment from the front panel or disconnect the main power cord from the rear of the 2601B-PULSE before handling cables. Putting the equipment into standby does not guarantee that the outputs are powered off if a hardware or software fault occurs.

Setting the source range and output value

Before testing each calibration point, you must properly set the source range and output value.

To set the source range and output value:

1. Press the **SRC** key to select the appropriate source function.
2. Press the navigation wheel  to enable the edit mode (EDIT indicator on).
3. When the cursor in the source display field is flashing, set the source range to the range being calibrated. Use the up or down **RANGE** keys to select the range.
4. Use the navigation wheel  and **CURSOR** keys to set the source value to the required value.
5. Press the navigation wheel  to complete editing.

Setting the measurement range

When simultaneously sourcing and measuring either voltage or current, the measure range is coupled to the source range, and you cannot independently control the measure range. Thus, it is not necessary for you to set the range when testing voltage or [current measurement accuracy](#) (on page 13-10).

Current source accuracy

To verify the 2601B-PULSE output current accuracy is within specified limits, perform these steps:

1. With the power off, connect the digital multimeter to the 2601B-PULSE terminals as shown in the figure below.

Figure 151: Connections for 100 nA to 1 A current ranges

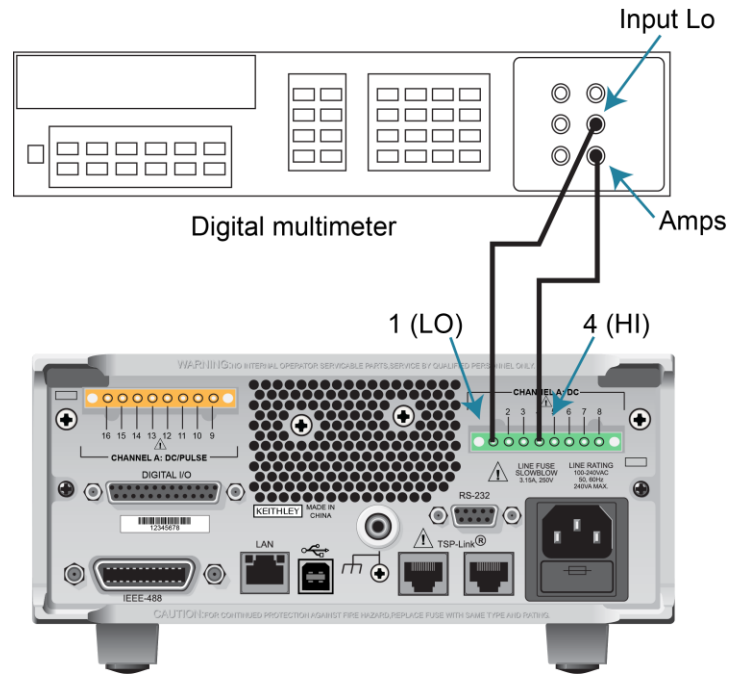

2. Select the multimeter DC current measuring function.
3. Press the **SRC** key to source current, and make sure the source output is turned on.
4. Verify output current accuracy for each of the currents for the 100 nA to 1 A ranges using the values in the following table. For each test point:
 - Select the correct source range.
 - Set the 2601B-PULSE output current to the correct value.
 - Verify that the multimeter reading is within the limits given in the following table.

2601B-PULSE output current accuracy limits

Source range	Output current setting	Output current limits (1 year, 18 °C to 28 °C)
100 nA	90.000 nA	89.846 nA to 90.154 nA
1 µA	0.90000 µA	0.89893 µA to 0.90107 µA
10 µA	9.0000 µA	8.9923 µA to 9.0077 µA
100 µA	90.000 µA	89.913 µA to 90.087 µA
1 mA	0.90000 mA	0.89943 mA to 0.90057 mA
10 mA	9.0000 mA	8.9913 mA to 9.0087 mA
100 mA	90.000 mA	89.943 mA to 90.057 mA
1 A	0.90000 A	0.89775 A to 0.90225 A

5. Repeat the procedure for negative output currents with the same magnitudes as those listed.
6. Turn the output off, and change connections as shown in the figure below.

Figure 152: Connections for the 3 A current range

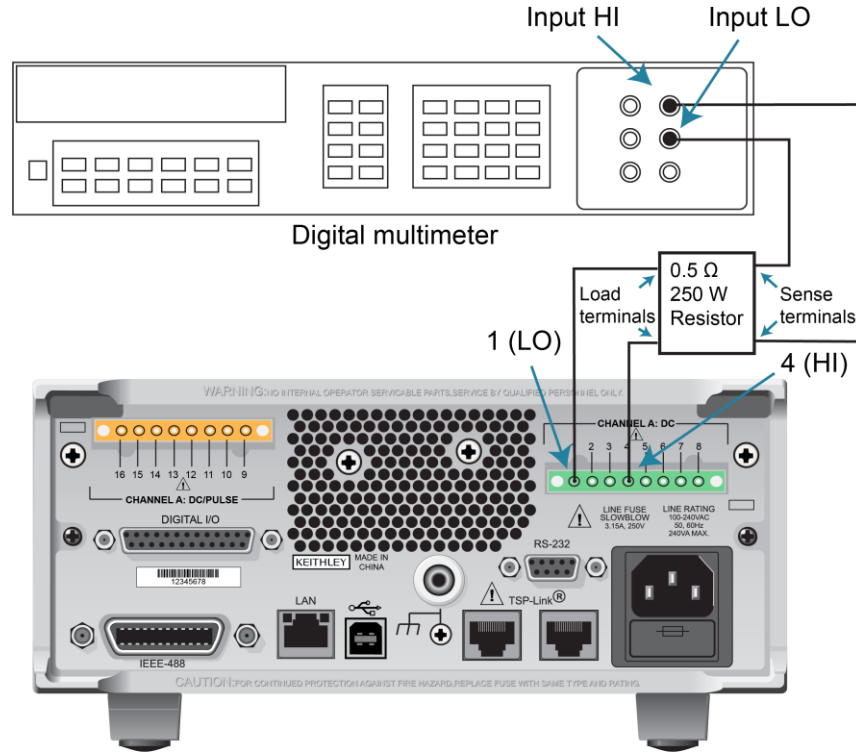

7. Select the DMM DC volts function.
8. Press the **SRC** key to source current, and make sure the source output is turned on.
9. Verify output current accuracy for the 3 A range using the values in the following table. For each test point:
 - Select the correct source range.
 - Set the 2601B-PULSE output current to the correct value.
 - Verify that the multimeter reading is within the limits in the following table.

2601B-PULSE output current accuracy limits

Source range	Output current setting	Output current limits (1 year, 18 °C to 28 °C)
3 A	2.40000 A	2.39456 A to 2.40544 A

10. Repeat the procedure for negative output currents with the same magnitudes as those listed.
11. Calculate the current from the DMM voltage reading and the characterized 0.5 Ω resistance value: $I=V/R$.

Current measurement accuracy

Follow the steps below to verify that 2601B-PULSE current measurement accuracy is within specified limits. The procedure involves applying accurate currents from the 2601B-PULSE current source and then verifying that 2601B-PULSE current measurements are within required limits.

To verify the current measurement accuracy:

1. With the power off, connect the digital multimeter to the 2601B-PULSE terminals as shown in the figure below.

Figure 153: Connections for 100 nA to 1 A current ranges

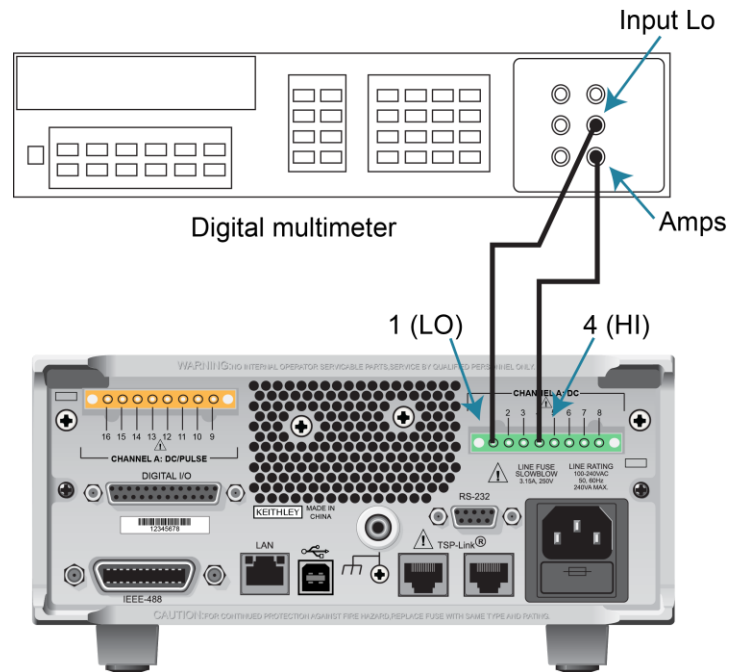

2. Select the multimeter DC current function.
3. Set the 2601B-PULSE SMU to both source and measure current by pressing the **SRC** and then the **MEAS** keys.
4. Make sure the source output is turned on.
5. Verify measure current accuracy for each of the currents listed using the values listed in the following table. For each measurement:
 - Select the correct source range.
 - Set the 2601B-PULSE output current such that the digital multimeter reading is the value indicated in the source current column of the table below. It may not be possible to set the current source to get exactly the required reading on the digital multimeter. Use the closest possible setting and modify the reading limits accordingly.
 - If necessary, press the **TRIG** key to display readings.
 - Verify that the 2601B-PULSE current reading is within the limits given in the table below.

Current measurement accuracy limits

Source and measure range ¹	Source current ²	Current reading limits (1 year, 18° C to 28° C)
100 nA	90.000 nA	89.855 nA to 90.145 nA
1 µA	0.9000 µA	0.89928 µA to 0.90073 µA
10 µA	9.0000 µA	8.9963 µA to 9.0038 µA
100 µA	90.000 µA	89.957 µA to 90.043 µA
1 mA	0.9000 mA	0.89962 mA to 0.90038 mA
10 mA	9.0000 mA	8.9957 mA to 9.0043 mA
100 mA	90.000 mA	89.962 mA to 90.038 mA
1 A	0.90000 A	0.89823 A to 0.90177 A

1. Measure range coupled to source range when simultaneously sourcing and measuring current.
 2. As measured by precision digital multimeter. Use closest possible value, and modify reading limits accordingly if necessary. See [Measurement limit calculations](#) (on page 13-4).

6. Repeat the procedure for negative calibrator currents with the same magnitudes as those listed.
7. Turn the output off.
8. Change connections as shown in the following figure, adding the 0.5 Ω 250 W resistor.

Figure 154: Connections for the 3 A current range

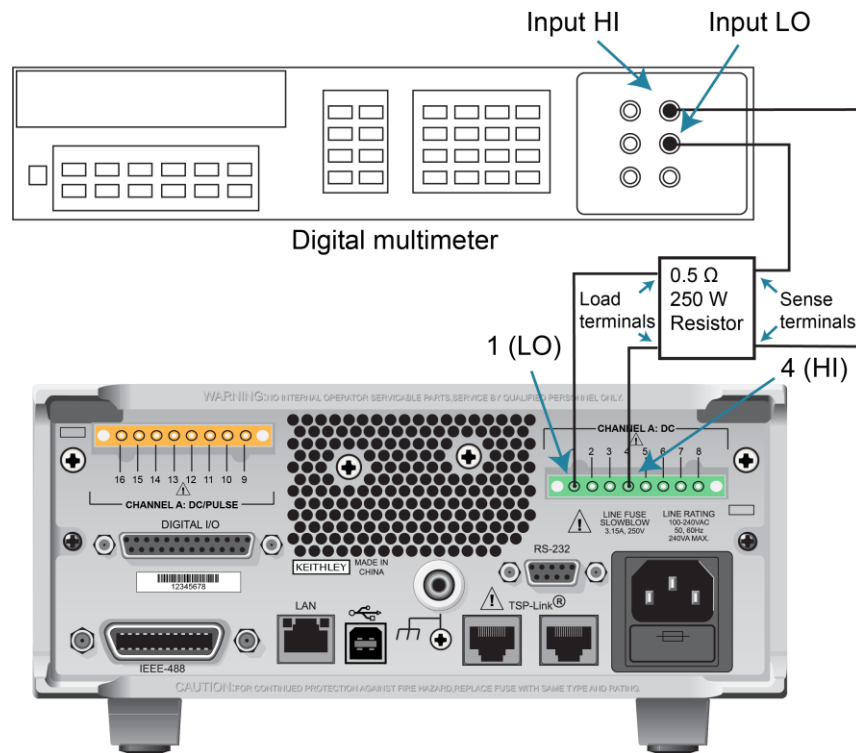

9. Select the DMM volts function.
10. Set the 2601B-PULSE SMU to both source and measure current by pressing the **SRC** and then the **MEAS** keys.
11. Make sure the source output is turned on.
12. Verify measure current accuracy for each of the currents listed using the values listed in the following table. For each measurement:
 - Select the correct source range.
 - Set the 2601B-PULSE output current such that the digital multimeter reading is the value indicated in the source current column of the table below. It may not be possible to set the current source to get exactly the required reading on the digital multimeter. Use the closest possible setting and modify the reading limits accordingly.
 - If necessary, press the **TRIG** key to display readings.
 - Verify that the 2601B-PULSE current reading is within the limits given in the table below.

Current measurement accuracy limits

Source and measure range ¹	Source current ²	Current reading limits (1 year, 18° C to 28° C)
3 A	2.4000 A	2.3953 A to 2.4047 A

1. Measure range coupled to source range when simultaneously sourcing and measuring current.
 2. As measured by precision digital multimeter. Use closest possible value, and modify reading limits accordingly if necessary. See [Measurement limit calculations](#) (on page 13-4).

8. Calculate the current from the DMM voltage reading and characterized 0.5 Ω resistance value.

Voltage source accuracy

Follow the steps below to verify that the 2601B-PULSE output voltage accuracy is within specified limits. To perform this test, you will set the output voltage to each full-range value and measure the voltages with a precision digital multimeter.

To verify voltage source accuracy:

1. With the power off, connect the digital multimeter (DMM) to the 2601B-PULSE output terminals using 4-wire connections, as shown in the following figure.

Figure 155: Connections for voltage verification

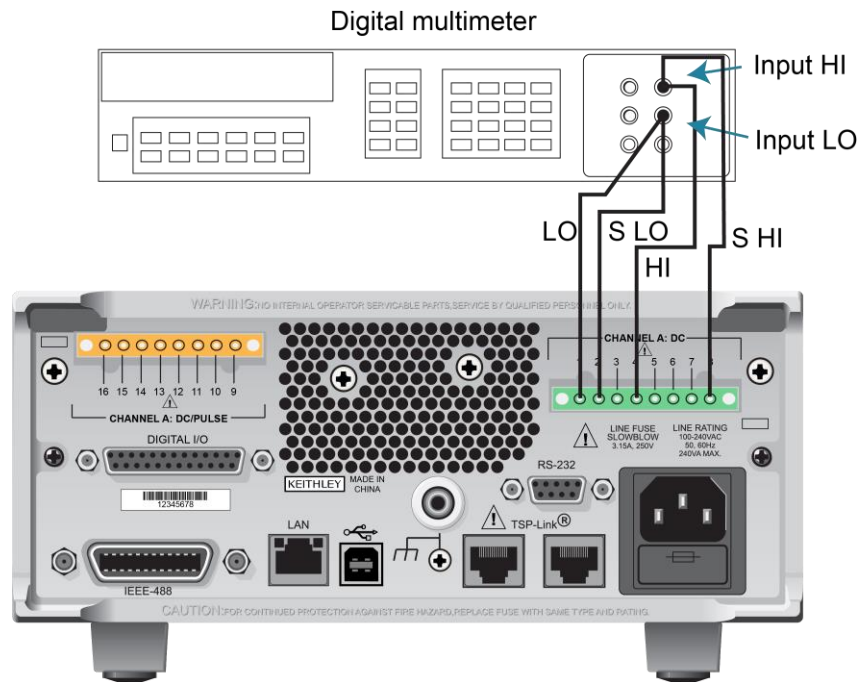

2. Set the multimeter measuring function to DC volts.
3. Press the **SRC** key to source voltage and make sure the source output is turned on.
4. Enable the 2601B-PULSE 4-wire (remote sense) mode:
 - a. Press the **CONFIG** key and then the **SRC** key.
 - b. Select **V-SOURCE > SENSE-MODE > 4-WIRE**.
5. Verify output voltage accuracy for each of the voltages listed in the following table. For each test point:
 - Select the correct source range.
 - Set the 2601B-PULSE output voltage to the indicated value.
 - Verify that the multimeter reading is within the limits given in the table.

Output voltage accuracy limits

Source range	Output voltage setting	Output voltage limits (1 year, 18 °C to 28 °C)
100 mV	90.000 mV	89.732 mV to 90.268 mV
1 V	0.90000 V	0.89942 V to 0.90058 V
6 V	5.4000 V	5.39712 V to 5.40288 V
40 V	36.000 V	35.9808 V to 36.0192 V

6. Repeat the procedure for negative output voltages with the same magnitudes as those listed in the previous table, as applicable.

Voltage measurement accuracy

Follow the steps below to verify that the 2601B-PULSE voltage measurement accuracy is within specified limits. To perform this test, you will set the source voltage, as measured by a precision digital multimeter, and then verify that the 2601B-PULSE voltage readings are within required limits.

To verify voltage measurement accuracy:

1. With the power off, connect the digital multimeter to the 2601B-PULSE output terminals using 4-wire connections. Use the same connections shown in the figure in [Voltage source accuracy](#) (on page 13-12).
2. Select the multimeter DC volts function.
3. Enable the 2601B-PULSE 4-wire (remote sense) mode:
 - a. Press the **CONFIG** key and then the **MEAS** key.
 - b. Select **V-MEAS > SENSE-MODE > 4-WIRE**.
4. Set the 2601B-PULSE SMU to both source and measure voltage by pressing the **SRC** and then the **MEAS** keys.
5. Make sure the source output is turned on.
6. Verify voltage measurement accuracy for each of the voltages listed in the table below. For each test point:
 - Select the correct source range.
 - Set the 2601B-PULSE output voltage such that the digital multimeter reading is the value indicated in the source voltage column of the table below. It may not be possible to set the voltage source to get exactly the required reading on the digital multimeter. Use the closest possible setting and modify the reading limits accordingly.
 - Verify that the 2601B-PULSE voltage reading is within the limits given in the table.
7. Repeat the procedure for negative source voltages with the same magnitudes as those listed in the table (see below).

2601B-PULSE voltage measurement accuracy limits

Source and measure range ¹	Source voltage ²	Voltage reading limits (1 year, 18 °C to 28 °C)
100 mV	90.000 mV	89.8365 to 90.1635 mV
1 V	0.90000 V	0.899665 to 0.900335 V
6 V	5.4000 V	5.39819 to 5.40181 V
40 V	36.000 V	35.9866 to 36.0134 V

1. Measure range coupled to source range when simultaneously sourcing and measuring voltage.
2. As measured by precision digital multimeter. Use closest possible value, and modify reading limits accordingly if necessary.

Pulse accuracy

These steps verify that the 2601B-PULSE pulse current, voltage measurement, and current measurement accuracy is within specified limits.

NOTE

For detail on wiring the pulse load, refer to [Pulse loads](#) (on page 13-3).

To verify current, voltage measurement, and current measurement accuracy, perform these steps:

1. Remove power from the 2601B-PULSE.
2. Connect the multimeter to the 2601B-PULSE terminals as shown in the figure below.

Figure 156: Pulse accuracy calibration and adjustment connections

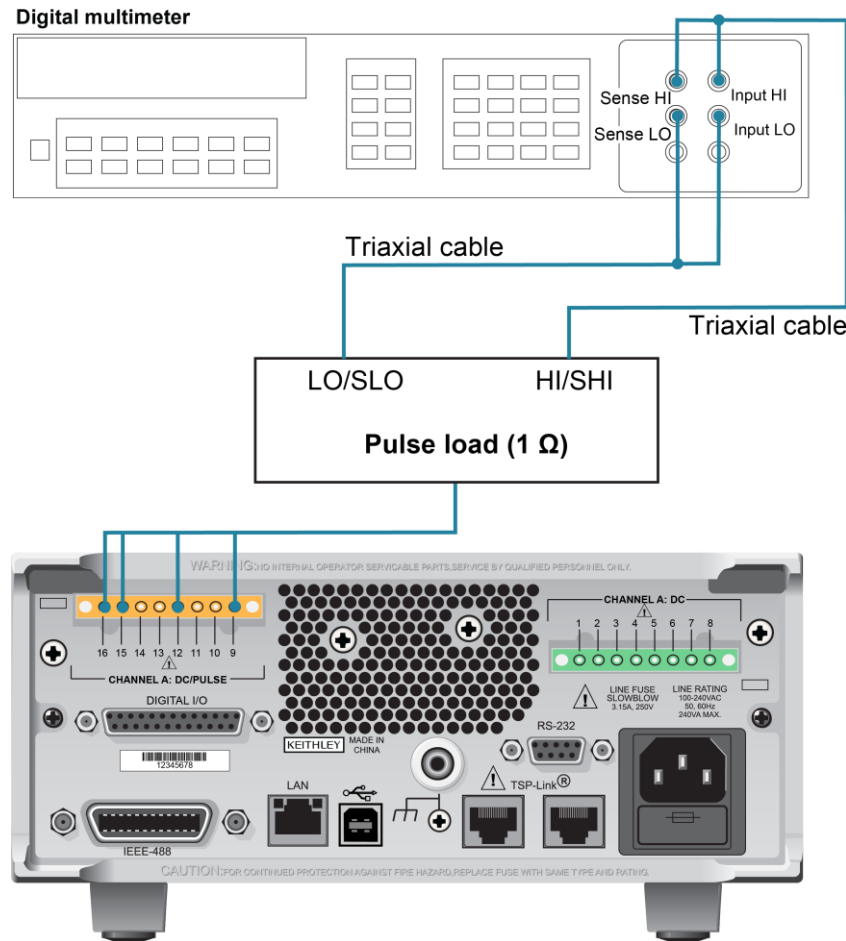

3. Select the digitizing function on the multimeter.
4. Reconnect power to the 2601B-PULSE and turn on the instrument.
5. Create a pulse using the code provided below (following the tables).
6. Verify the output pulse current, voltage measurement, and current measurement accuracy for each of the currents and voltages for the 1 A to 10 A ranges using the values in the following tables. For each test point:
 - Select the correct source range.
 - Set the 2601B-PULSE output current to the correct value.
 - Verify that the multimeter reading is within the limits for the source given in the following tables.
 - Verify that the 2601B-PULSE readings are within the measure limits.
7. Repeat the procedure for negative output currents with the same magnitudes as those listed.
8. Calculate the current from the DMM voltage reading and the characterized 1 Ω resistance value: $I=V/R$.

2601B-PULSE pulse output current accuracy limits

Source range	Output current setting	Output current limits (1 year, 18 °C to 28 °C)
1 A	0.9 A	0.8965 A to 0.9035 A
5 A	4.5 A	4.4899 A to 4.5102 A
10 A	9 A	8.9772 A to 9.0228 A

2601B-PULSE pulse measure current accuracy limits

Source range	Output current setting	Output current limits (1 year, 18 °C to 28 °C)
1 A	0.9 A	0.898420 A to 0.901580 A
5 A	4.5 A	4.493600 A to 4.506400 A
10 A	9 A	8.98820 A to 9.01180 A

2601B-PULSE pulse measure voltage accuracy limits

Source range	Output voltage setting	Output current limits (1 year, 18 °C to 28 °C)
5 V	4.5 V	4.495250 A to 4.504750 A
10 V	9 V	8.99150 A to 9.00850 A

To generate a pulse, send the following code:

```
-- Set the current range and level.
pulseLevel = 4.5
pulseRange = 5
smua.pulser.rangei = pulseRange
smua.reset()
```

```
-- Set the bias level.
smua.source.level1 = 0

-- Set up the pulser.
smua.measure.autozero = smua.AUTOZERO_OFF
smua.source.offmode = smua.OUTPUT_HIGH_Z
smua.pulser.protect.sensev = 10
smua.pulser.protect.sourcev = 20

--Set the voltage range.
if (pulseRange > 5) then
    smua.pulser.rangev = 10
else
    smua.pulser.rangev = 5
end

--Configure the trigger model.
digio.trigger[1].mode = digio.TRIG_RISING
digio.trigger[1].pulsewidth = 10e-6
digio.trigger[1].stimulus = smua.trigger.SOURCE_COMPLETE_EVENT_ID

smua.trigger.source.action = smua.ENABLE
smua.trigger.measure.action = smua.ENABLE
trigger.timer[1].delay = 500e-6
trigger.timer[1].count = 1
trigger.timer[1].passthrough = false
trigger.timer[1].stimulus = smua.trigger.ARMED_EVENT_ID
smua.trigger.source.stimulus = trigger.timer[1].EVENT_ID
smua.trigger.endpulse.action = smua.SOURCE_IDLE
smua.trigger.count = 1
smua.trigger.arm.count = 1

--Configure the pulse.
smua.trigger.source.listi({pulseLevel})
smua.trigger.source.pulsewidth = 400e-6
smua.pulser.measure.delay = 30e-6
smua.pulser.measure.aperture = 50e-6
smua.measure.interval = 60e-6
smua.measure.count = 1
smua.measure.filter.enable = smua.FILTER_OFF

-- Use the dedicated buffers to receive measurements.
smua.nvbuffer1.clear()
smua.nvbuffer2.clear()
-- Use nvbuffer1 for current and nvbuffer2 for volts.
smua.trigger.measure.iv(smua.nvbuffer1, smua.nvbuffer2)

--Enable the output.
smua.pulser.enable = 1
smua.source.output = 1
delay(250e-3)

--Enter the trigger model state machine.
smua.trigger.initiate()
waitcomplete()
```

```
-- Pulse is done. Turn off the output.
smua.source.output = 0
smua.pulser.enable = 0

-- Retrieve measurements as a comma-separated list.
format.data = format.ASCII
printbuffer(1, 1, smua.nvbuffer1) -- current measurements
printbuffer(1, 1, smua.nvbuffer2) -- voltage measurements
```

Bias source accuracy

NOTE

For detail on wiring the pulse load, refer to [Pulse loads](#) (on page 13-3).

To verify the 2601B-PULSE output bias source accuracy is within specified limits, perform these steps:

1. With the power off, connect the digitizer to the 2601B-PULSE terminals as shown in the following figure.

Figure 157: Bias connections

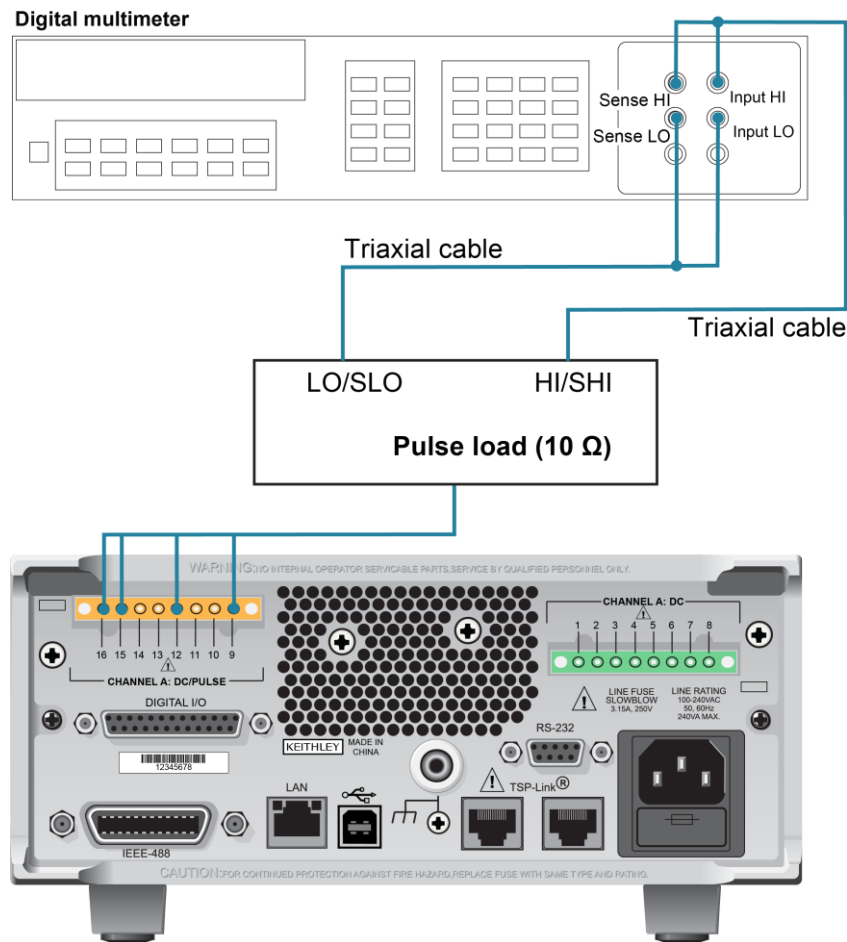

2. Select the multimeter DC current measuring function.
3. Reconnect power to the 2601B-PULSE and turn on the instrument.
4. Enable the pulser output using the code below.
5. Verify bias source accuracy for each of the currents using the values in the following table. For each test point:
 - Set the 2601B-PULSE output current to the correct value.
 - Verify that the multimeter reading is within the limits given in the following table.

2601B-PULSE output current accuracy limits

Source range	Output current setting	Output current limits (1 year, 18 °C to 28 °C)
250 mA	225 mA	223.61750 mA to 226.38250 mA

6. Calculate the current from the DMM voltage reading and the characterized 10 Ω resistance value: $I=V/R$.

```
-- Enable the output.
smua.reset()
smua.pulser.enable = 1
smua.source.output = 1
-- Set up ranges.
smua.pulser.rangei = 1
smua.pulser.rangev = 10
smua.pulser.protect.sensev = 20
smua.pulser.protect.sourcev = 40
-- Set the bias to 225 mA.
smua.source.level1 = 225e-3
```

Adjustment

WARNING

The information in this section is intended for qualified service personnel only, as described by the types of product users in the Safety Precautions pages, provided at the beginning of this document. Do not attempt these procedures unless you are qualified to do so.

Some of these procedures may expose you to hazardous voltages, that if contacted, could cause personal injury or death. Use appropriate safety precautions when working with hazardous voltages.

Use the procedures in this section to adjust the 2601B-PULSE.

These procedures require accurate test equipment to measure precise DC voltages and currents.

NOTE

Product specifications are subject to change. Listed uncertainties and test limits are provided only as an example. Always verify values against actual product specifications.

Environmental conditions

Temperature and relative humidity

Conduct the adjustment procedures at an ambient temperature of 18 °C to 28 °C, with relative humidity of less than 70 percent (unless otherwise noted).

NOTE

Product specifications that are listed as 18 °C to 28 °C assume adjustment has been done at 23 °C. If the 2601B-PULSE is adjusted at a different temperature, the specifications apply to ± 5 °C of that temperature.

Line power

The 2601B-PULSE requires a line voltage of 100 V to 240 V at a line frequency of 50 Hz or 60 Hz. The instrument must be adjusted within this range.

Warmup period

Allow the 2601B-PULSE to warm up for at least two hours before adjusting the instrument.

If the instrument has been subjected to temperature extremes (those outside the ranges stated above), allow additional time for the internal temperature of the instrument to stabilize. Typically, allow one extra hour to stabilize an instrument that is 10 °C outside the specified temperature range.

Allow the test equipment to warm up for the minimum time specified by the manufacturer.

Adjustment considerations

When performing the adjustment procedures:

- Make sure that the test equipment is properly warmed up and connected to the correct 2601B-PULSE terminals.
- Always allow the source signal to settle before adjusting each point.
- Do not connect test equipment to the 2601B-PULSE through a scanner or other switching equipment.
- If an error occurs during adjustment, the 2601B-PULSE generates an appropriate error message. See the [Error summary list](#) (on page 12-2) for more information.

⚠ WARNING

The FORCE and SENSE connectors of the 2601B-PULSE are rated for connection to circuits rated Measurement Category I only, with transients rated less than 1500 V_{PEAK}. Do not connect the 2601B-PULSE terminals to CAT II, CAT III, or CAT IV circuits. Connections of the input/output connectors to circuits higher than CAT I can cause damage to the equipment or expose the operator to hazardous voltages.

⚠ WARNING

Hazardous voltages may be present on all output and guard terminals. To prevent electrical shock that could cause injury or death, never make or break connections to the 2601B-PULSE while the instrument is powered on. Turn off the equipment from the front panel or disconnect the main power cord from the rear of the 2601B-PULSE before handling cables. Putting the equipment into standby does not guarantee that the outputs are powered off if a hardware or software fault occurs.

Adjustment cycle

Perform an adjustment at least once a year to make sure the instrument meets or exceeds its specifications.

Recommended adjustment equipment

The table below contains the recommended equipment for the adjustment procedures. You can use alternate equipment if that equipment has specifications equal to or greater than those listed in the table. When possible, test equipment specifications should be at least four times better than corresponding 2601B-PULSE specifications.

Recommended adjustment equipment

Description	Manufacturer/Model	Accuracy		
Digital multimeter	Keithley Instruments Model 2002 or Keysight 3458A	DC voltage ¹	90 mV:	±8 ppm
			0.9 V:	±5 ppm
			5.4 V:	±4 ppm
			36 V:	±6 ppm
		DC current ¹	90 nA:	±430 ppm
			0.9 A:	±45 ppm
			9 A:	±25 ppm
			90 A:	±23 ppm
			0.9 mA:	±20 ppm
			9 mA:	±20 ppm
			90 mA:	±35 ppm
			0.9 A:	±110 ppm
0.5 Ω, 250 W, 0.1% precision resistor	Isotek RUG-Z-R500-0.1-TK3	Resistance ²	0.5 Ω:	±125 ppm
50 Ω resistors (two)	Any suitable ³			

Recommended adjustment equipment

Description	Manufacturer/Model	Accuracy		
1 Ω , 10 V, 1% pulse load ⁴		Resistance	1 Ω :	± 100 ppm
10 Ω , 10 V, 1% pulse load ⁴		Resistance	10 Ω :	± 25 ppm
1. 90-day specifications show full-range accuracy of recommended model used for specified point. 2. Resistor used to adjust 3 A and 10 A ranges should be characterized to uncertainty shown using resistance function of a digital multimeter before use. 3. Used for contact check adjustment. Characterize resistors using ohms function of digital multimeter before use. 4. Refer to Pulse loads (on page 13-3).				

Adjustment overview

Adjustment steps must be performed in a specific sequence, as shown in the following table. Each range is adjusted using four points:

- + ZERO
- + FULL SCALE
- – ZERO
- – FULL SCALE

The full-scale parameters are 90 percent of full-scale unless otherwise noted (see the table in [Step sequence](#) (on page 13-22)). Note that you cannot send a value of 0 for the two zero parameters. Instead, you must send a very small value, such as 1e-30 or -1e-30.

The following table lists the sense modes for the adjustment steps.

2601B-PULSE adjustment steps

Function ¹	Adjustment steps ²	Adjustment points ⁴	Sense mode
Voltage source and measure	100 mV	$\pm 1e-30, \pm 90$ mV	smua.SENSE_LOCAL
	100 mV	$\pm 1e-30, \pm 90$ mV	smua.SENSE_REMOTE
	1 V	$\pm 1e-30, \pm 0.9$ V	smua.SENSE_LOCAL
	1 V	$\pm 1e-30, \pm 0.9$ V	smua.SENSE_CALA
	6 V	$\pm 1e-30, \pm 5.4$ V	smua.SENSE_LOCAL
	40 V	$\pm 1e-30, \pm 36$ V	smua.SENSE_LOCAL
Current source and measure	100 nA	$\pm 1e-30, \pm 90$ nA	smua.SENSE_LOCAL
	1 μ A	$\pm 1e-30, \pm 0.9$ μ A	smua.SENSE_LOCAL
	10 μ A	$\pm 1e-30, \pm 9$ μ A	smua.SENSE_LOCAL
	100 μ A	$\pm 1e-30, \pm 90$ μ A	smua.SENSE_LOCAL
	1 mA	$\pm 1e-30, \pm 0.9$ mA	smua.SENSE_LOCAL
	1 mA	$\pm 1e-30, \pm 0.9$ mA	smua.SENSE_CALA
	10 mA	$\pm 1e-30, \pm 9$ mA	smua.SENSE_LOCAL
	100 mA	$\pm 1e-30, \pm 90$ mA	smua.SENSE_LOCAL
	1 A	$\pm 1e-30, \pm 0.9$ A	smua.SENSE_LOCAL
	3 A	$\pm 1e-30, \pm 2.4$ A	smua.SENSE_LOCAL
10 A ³	$\pm 1e-30, \pm 2.4$ A	smua.SENSE_LOCAL	
Pulser bias source	250 mA	$\pm 2.5, \pm 225$ mA	smua.SENSE_REMOTE
Pulse source and measure	1 A ⁵	$\pm 0.01, \pm 0.75$ A	smua.SENSE_REMOTE
	5 A ⁵	$\pm 0.01, \pm 4$ A	smua.SENSE_REMOTE
	10 A	$\pm 0.01, \pm 9$ A	smua.SENSE_REMOTE
	5 V ⁵	$\pm 0.01, \pm 4$ V	smua.SENSE_REMOTE
	10 V ⁵	$\pm 0.01, \pm 9$ V	smua.SENSE_REMOTE

1. Adjust only the source for the CALA sense steps.
2. Steps must be performed in the order shown.
3. 10 A range for changing adjustment of range only and is not available for normal use.
4. Do not use actual 0 values for zero adjustment points. Send very small values such as $\pm 1e-30$. Adjustment polarities must also be set as shown in the procedures.
5. The 1 A source, 1 A measure, and 1 V measure ranges use 75% for full scale. The 5 A source, 5 A measure, and 5 V measure ranges use 80% for full scale.

Calibration and adjustment command quick reference

The following table summarizes remote calibration and adjustment commands. For a more complete description of these commands, refer to the [TSP command reference](#) (on page 11-1).

Command	Description
<code>smua.cal.adjustdate = adjustDate</code>	Stores the date of the last calibration adjustment.
<code>smua.cal.date = calDate</code>	Stores the calibration date of the active calibration set.
<code>smua.cal.due = calDue</code>	Stores the calibration due date for the next calibration (<i>calDue</i> of 0 indicates date not set).
<code>smua.cal.lock()</code>	Disables the commands that change calibration settings.
<code>smua.cal.password = "newPassword"</code>	Stores the password required to enable calibration (<i>newPassword</i> will be the new password).
<code>smua.cal.polarity = calPolarity</code>	Controls which calibration constants are used for all subsequent measurements: <code>smua.CAL_AUTO</code> (automatic polarity). <code>smua.CAL_NEGATIVE</code> (negative polarity). <code>smua.CAL_POSITIVE</code> (positive polarity).
<code>smua.cal.restore(calset)</code>	Loads a stored set of calibration constants: <code>smua.CALSET_NOMINAL</code> (nominal constants). <code>smua.CALSET_FACTORY</code> (factory constants). <code>smua.CALSET_DEFAULT</code> (normal constants). <code>smua.CALSET_PREVIOUS</code> (previous constants).
<code>smua.cal.save()</code>	Stores the active calibration constants to nonvolatile memory as the DEFAULT calibration set.
<code>calstate = smua.cal.state</code>	Returns the present calibration state: <code>smua.CALSTATE_CALIBRATING</code> <code>smua.CALSTATE_LOCKED</code> <code>smua.CALSTATE_UNLOCKED</code>
<code>smua.cal.unlock("password")</code>	Unlocks calibration (default password: KI0026XX)
<code>smua.measure.calibratei(range, cp1Measured, cp1Reference, cp2Measured, cp2Reference)</code>	Adjusts the current measurement range*: \pm <i>range</i> (measurement range to adjust). <i>cp1Measured</i> (2601B-PULSE measured value for point 1). <i>cp1Reference</i> (reference measurement for point 1). <i>cp2Measured</i> (2601B-PULSE measured value for point 2). <i>cp2Reference</i> (reference measurement for point 2).
<code>smua.measure.calibratev(range, cp1Measured, cp1Reference, cp2Measured, cp2Reference)</code>	Adjusts the voltage measurement range*: \pm <i>range</i> (measurement range to adjust). <i>cp1Measured</i> (2601B-PULSE measured value for point 1). <i>cp1Reference</i> (reference measurement for point 1). <i>cp2Measured</i> (2601B-PULSE measured value for point 2). <i>cp2Reference</i> (reference measurement for point 2).
<code>smua.source.calibratei(range, cp1Expected, cp1Reference, cp2Expected, cp2Reference)</code>	Adjusts the current source range*: \pm <i>range</i> (source range to adjust). <i>cp1Expected</i> (source value programmed for point 1). <i>cp1Reference</i> (reference measurement for point 1). <i>cp2Expected</i> (source value programmed for point 2). <i>cp2Reference</i> (reference measurement for point 2).

Command	Description
<code>smua.source.calibratev(range, cp1Expected, cp1Reference, cp2Expected, cp2Reference)</code>	Adjusts the voltage source range*: $\pm range$ (source range to adjust). <i>cp1Expected</i> (source value programmed for point 1). <i>cp1Reference</i> (reference measurement for point 1). <i>cp2Expected</i> (source value programmed for point 2). <i>cp2Reference</i> (reference measurement for point 2).
<code>smua.contact.calibratelo(cp1Measured, cp1Reference, cp2Measured, cp2Reference)</code>	Adjusts the low/sense low contact check measurement. <i>cp1Measured</i> (value measured by the SMU for point 1). <i>cp1Reference</i> (the reference measurement for point 1). <i>cp2Measured</i> (value measured by SMU for point 2). <i>cp2Reference</i> (reference measurement for point 2).
<code>smua.contact.calibratehi(cp1Measured, cp1Reference, cp2Measured, cp2Reference)</code>	Adjusts the high/sense high contact check measurement. <i>cp1Measured</i> (value measured by SMU for point 1). <i>cp1Reference</i> (reference measurement for point 1). <i>cp2Measured</i> (value measured by SMU for point 2). <i>cp2Reference</i> (reference measurement for point 2).
<code>smua.pulser.source.calibratebiasi(range, cp1Expected, cp1Reference, cp2Expected, cp2Reference)</code>	Adjusts the new bias source calibration constants for the pulser. $range$ (pulse current range to adjust). <i>cp1Expected</i> (source value set for point 1). <i>cp1Reference</i> (reference measurement for point 1). <i>cp2Expected</i> (source value set for point 2). <i>cp2Reference</i> (reference measurement for point 2).
<code>smua.pulser.source.calibratei(range, cp1Expected, cp1Reference, cp2Expected, cp2Reference)</code>	Adjusts the current source calibration constants for the pulser. $range$ (pulse current range to adjust). <i>cp1Expected</i> (source value set for point 1). <i>cp1Reference</i> (reference measurement for point 1). <i>cp2Expected</i> (source value set for point 2). <i>cp2Reference</i> (reference measurement for point 2).
<code>smua.pulser.measure.calibratei(range, cp1Measured, cp1Reference, cp2Measured, cp2Reference)</code>	Adjusts the current measurement calibration constants for the pulser. $\pm range$ (measurement range to adjust). <i>cp1Measured</i> (2601B-PULSE measured value for point 1). <i>cp1Reference</i> (reference measurement for point 1). <i>cp2Measured</i> (2601B-PULSE measured value for point 2). <i>cp2Reference</i> (reference measurement for point 2).
<code>smua.pulser.measure.calibratev(range, cp1Measured, cp1Reference, cp2Measured, cp2Reference)</code>	Adjusts the voltage measurement calibration constants for the pulser. $\pm range$ (measurement range to adjust). <i>cp1Measured</i> (2601B-PULSE measured value for point 1). <i>cp1Reference</i> (reference measurement for point 1). <i>cp2Measured</i> (2601B-PULSE measured value for point 2). <i>cp2Reference</i> (reference measurement for point 2).

* Point 1 should be performed at approximately 0% of range; point 2 should be performed at approximately 90% of range. See [Step sequence](#) (on page 13-22) for points.

Adjustment procedure

Use the following procedure to perform remote calibration adjustment by sending commands over a communications interface. The remote commands and appropriate parameters are separately summarized for each step.

Step 1. Prepare the 2601B-PULSE for adjustment

- A. Connect the 2601B-PULSE to the controller IEEE-488 interface, RS-232 port, USB interface, or LAN using an appropriate interface cable.
- B. Turn on the 2601B-PULSE and the test equipment. Allow them to warm up for at least two hours before performing adjustment.
- C. Make sure the IEEE-488, RS-232, or LAN interface parameters are set up properly. To configure the interface, press the **MENU** key, and then select **RS232**, **LAN**, or **GPIB**, as applicable; configuration of the USB interface is not necessary so it is not available.

Step 2. Voltage adjustment

- A. Connect the 2601B-PULSE SMU to the digital multimeter using the 4-wire connections shown in the figure below, and select the multimeter DC volts function.

Figure 158: Connections for voltage calibration

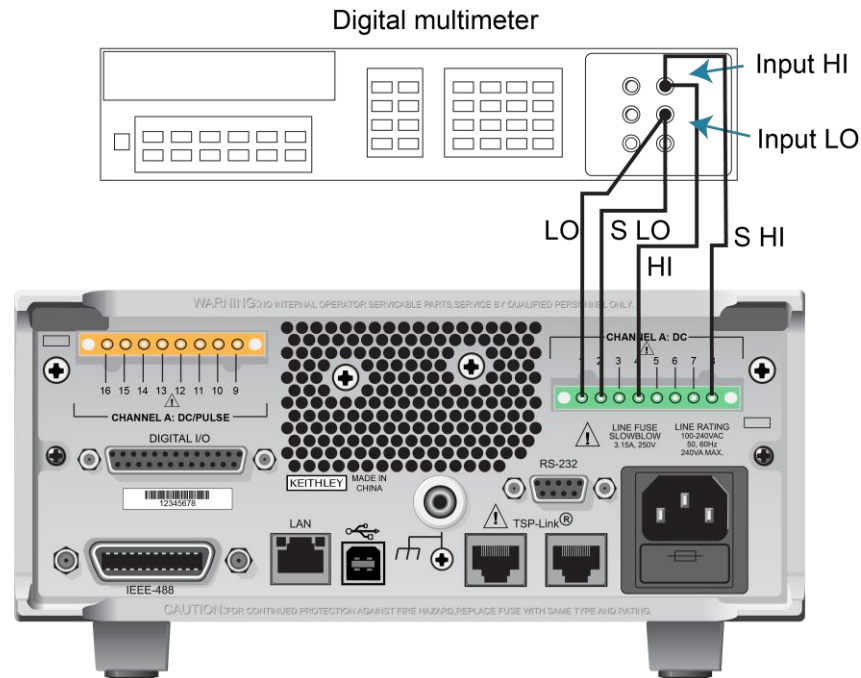

B. Send the following commands to initialize voltage adjustment:

```
smua.cal.unlock("KI0026XX")  
smua.reset()  
smua.source.func = smua.OUTPUT_DCVOLTS
```

NOTE

It is not necessary to set the measure range when following this procedure for adjustment because the measure range is locked to the source range when measuring the source function.

C. Perform each adjustment for the voltage source and measure function step listed in [Adjustment overview](#) (on page 13-22) as follows:**1. Select the range being adjusted with this command:**

```
smua.source.rangev = range
```

2. Select the correct sense mode based on the adjustment step for the voltage source and measure function from the step sequence, for example:

```
smua.sense = smua.SENSE_LOCAL
```

3. Select positive polarity, and then set the source output to the positive zero value. For example:

```
smua.cal.polarity = smua.CAL_POSITIVE  
smua.source.levelv = 1e-30
```

4. Turn on the output:

```
smua.source.output = smua.OUTPUT_ON
```

5. Allow the readings to settle, then get both the multimeter and 2601B-PULSE voltage readings at the positive zero value (the 2601B-PULSE measurement is not necessary if this step is being done on the CALA sense mode). The two measurements should be made as close as possible in time. Use this command for the 2601B-PULSE:

```
Z_rdg = smua.measure.v()
```

6. Turn off the output:

```
smua.source.output = smua.OUTPUT_OFF
```

7. Set the source output to the positive full-scale value for the present range, for example:

```
smua.source.levelv = 0.9
```

8. Turn on the output:

```
smua.source.output = smua.OUTPUT_ON
```

9. Allow the readings to settle, then get both the multimeter and 2601B-PULSE voltage readings at the positive full-scale output value (the 2601B-PULSE measurement is not necessary if this calibration step is being done on the CALA sense mode). The two measurements should be made as close as possible in time. Use this command for the 2601B-PULSE:

```
FS_rdg = smua.measure.v()
```

10. Turn off the output:

```
smua.source.output = smua.OUTPUT_OFF
```

11. Send the source calibration command using the range, +zero and +FS multimeter readings, and +zero and +FS source values for the parameters:

```
smua.source.calibratev(range, src_Z, DMM_Z_rdg, src_FS, DMM_FS_rdg)
```

Where:

range = The present adjustment range
src_Z = The +zero 2601B-PULSE programmed source output value
DMM_Z_rdg = The +zero DMM measurement
src_FS = The +FS 2601B-PULSE programmed source output value
DMM_FS_rdg = The +FS DMM measurement

Typical values for the 1 V range:

```
smua.source.calibratev(1, 1e-30, 1e-5, 0.9, 0.903)
```

12. If this step is not on the CALA sense mode, send the measure calibration command using the multimeter and 2601B-PULSE readings, and the range setting for the parameters. For example:

```
smua.measure.calibratev(range, Z_rdg, DMM_Z_rdg, FS_rdg, DMM_FS_rdg)
```

Where:

range = The present adjustment range
Z_rdg = The +zero 2601B-PULSE measurement
DMM_Z_rdg = The +zero DMM measurement
FS_rdg = The +FS 2601B-PULSE measurement
DMM_FS_rdg = The +FS DMM measurement

Typical 1 V range values:

```
smua.measure.calibratev(1, 1e-4, 1e-5, 0.92, 0.903)
```

13. Select negative polarity, then set the source output to the negative zero value, for example:

```
smua.cal.polarity = smua.CAL_NEGATIVE  
smua.source.levelv = -1e-30
```

14. Turn on the output:

```
smua.source.output = smua.OUTPUT_ON
```

15. Allow the readings to settle, then get both the multimeter and 2601B-PULSE voltage readings at the negative zero value (the 2601B-PULSE measurement is not necessary if this step is done on the CALA sense mode). The two measurements should be made as close as possible in time. Use this command for the 2601B-PULSE:

```
Z_rdg = smua.measure.v()
```

16. Turn off the output:

```
smua.source.output = smua.OUTPUT_OFF
```

17. Set the source output to the negative full-scale value, for example:

```
smua.source.levelv = -0.9
```

18. Turn on the output:

```
smua.source.output = smua.OUTPUT_ON
```

19. Allow the readings to settle, then get both the multimeter and 2601B-PULSE voltage readings at the negative full-scale output value (the 2601B-PULSE measurement is not necessary if this step is being done on the CALA sense mode). The two measurements should be made as close as possible in time. Use this command for the 2601B-PULSE:

```
FS_rdg = smua.measure.v()
```

20. Turn off the output:

```
smua.source.output = smua.OUTPUT_OFF
```

21. Send the source calibration command using the range, -zero and -FS multimeter readings, and -zero and -FS source values for the parameters:

```
smua.source.calibratev(-range, src_Z, DMM_Z_rdg, src_FS, DMM_FS_rdg)
```

Where:

-range = The negative of the present adjustment range
src_Z = The -zero 2601B-PULSE programmed source output value
DMM_Z_rdg = The -zero DMM measurement
src_FS = The -FS 2601B-PULSE programmed source output value
DMM_FS_rdg = The -FS DMM measurement

Typical values for the 1 V range:

```
smua.source.calibratev(-1, -1e-30, -1e-4, -0.9, -0.896)
```

22. If this step is not on the CALA sense mode, send the measure calibration command using the multimeter and 2601B-PULSE readings and range setting for the parameters:

```
smua.measure.calibratev(-range, Z_rdg, DMM_Z_rdg, FS_rdg, DMM_FS_rdg)
```

Where:

-range = The negative of the present adjustment range
Z_rdg = The -zero 2601B-PULSE measurement
DMM_Z_rdg = The -zero DMM measurement
FS_rdg = The -FS 2601B-PULSE measurement
DMM_FS_rdg = The -FS DMM measurement

Typical 1 V range values:

```
smua.measure.calibratev(-1, -1e-4, -1e-6, -0.89, -0.896)
```

- D. Be sure to complete each of the steps of C for all six voltage steps in [Adjustment overview](#) (on page 13-22) before performing current adjustment.
- E. Select automatic polarity mode:

```
smua.cal.polarity = smua.CAL_AUTO
```

Step 3. Current adjustment

- A. Connect the 2601B-PULSE SMU to the digital multimeter (see the following figure), and then select the multimeter DC current function.
- B. Send this command to initialize current adjustment:

```
smua.source.func = smua.OUTPUT_DCAMPS
```

Figure 159: Connections for 100 nA to 1 A current ranges

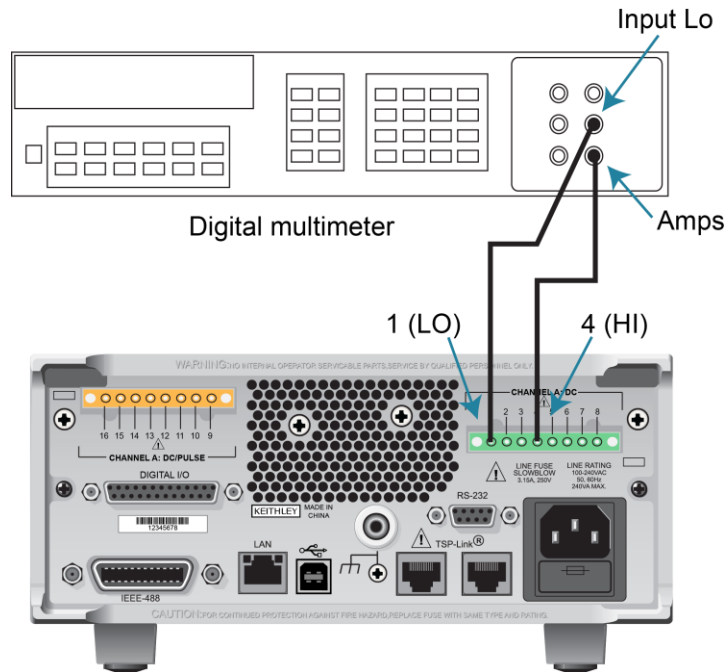

NOTE

It is not necessary to set the measure range when following this procedure for adjustment because the measure range is locked to the source range when measuring the source function.

- C. Perform each step listed in the step sequence for the 100 nA through 1 A ranges as follows:

1. Select the range being adjusted:

```
smua.source.rangei = range
```

2. Select the correct sense mode based on the step sequence, for example:

```
smua.sense = smua.SENSE_LOCAL
```

3. Select positive polarity, then set the source output to the positive zero value:

```
smua.cal.polarity = smua.CAL_POSITIVE
```

```
smua.source.leveli = 1e-30
```

4. Turn on the output:

```
smua.source.output = smua.OUTPUT_ON
```

5. Allow the readings to settle, then get both the multimeter and 2601B-PULSE current readings at the positive zero value (the 2601B-PULSE measurement is not necessary if this step is being done on the CALA sense mode). The two measurements should be made as close as possible in time. Use this command for the 2601B-PULSE:

```
Z_rdg = smua.measure.i()
```

6. Turn off the output:

```
smua.source.output = smua.OUTPUT_OFF
```

7. Set the source output to the positive full-scale value for the present range, for example:

```
smua.source.level1 = 90e-3
```

8. Turn on the output:

```
smua.source.output = smua.OUTPUT_ON
```

9. Allow the readings to settle, then get both the multimeter and 2601B-PULSE current readings at the positive full-scale output value (the 2601B-PULSE measurement is not necessary if adjustment is being done on the CALA sense mode). The two measurements should be made as close as possible in time. Use this command for the 2601B-PULSE:

```
FS_rdg = smua.measure.i()
```

10. Turn off the output:

```
smua.source.output = smua.OUTPUT_OFF
```

11. Send the source calibration command using the range, zero and +FS multimeter readings, and zero and +FS source values for the parameters:

```
smua.source.calibratei(range, src_Z, DMM_Z_rdg, src_FS, DMM_FS_rdg)
```

Where:

range = The present adjustment range
src_Z = The +zero 2601B-PULSE source output value
DMM_Z_rdg = The +zero DMM measurement
src_FS = The +FS 2601B-PULSE source output value
DMM_FS_rdg = The +FS DMM measurement

Typical values for the 100 mA range:

```
smua.source.calibratei(100e-3, 1e-30, 1e-5, 90e-3, 88e-3)
```

12. If this step is not on the CALA sense mode, send the measure calibration command using the multimeter and 2601B-PULSE readings, and range setting for the parameters:

```
smua.measure.calibratei(range, Z_rdg, DMM_Z_rdg, FS_rdg, DMM_FS_rdg)
```

Where:

range = The present adjustment range
Z_rdg = +zero 2601B-PULSE measurement
DMM_Z_rdg = The +zero DMM measurement
FS_rdg = +FS 2601B-PULSE measurement
DMM_FS_rdg = The +FS DMM measurement

Typical 100 mA range values:

```
smua.measure.calibratei(100e-3, 1e-6, 1e-5, 0.089, 0.088)
```

13. Select negative polarity, then set the source output to the negative zero value, for example:

```
smua.cal.polarity = smua.CAL_NEGATIVE  

smua.source.level1 = -1e-30
```

14. Turn on the output:

```
smua.source.output = smua.OUTPUT_ON
```

15. Allow the readings to settle, then get both the multimeter and 2601B-PULSE current readings at the negative zero value (the 2601B-PULSE measurement is not necessary if this step is being done on the CALA sense). The two measurements should be made as close as possible in time. Use this command for the 2601B-PULSE:

```
Z_rdg = smua.measure.i()
```

16. Turn off the output:

```
smua.source.output = smua.OUTPUT_OFF
```

17. Set the source output to the negative full-scale value, for example:

```
smua.source.level1 = -90e-3
```

18. Turn on the output:

```
smua.source.output = smua.OUTPUT_ON
```

19. Allow the readings to settle, then get both the multimeter and 2601B-PULSE current readings at the negative full-scale output value (the 2601B-PULSE measurement is not necessary if this step is being done on the CALA sense mode). The two measurements should be made as close as possible in time. Use this command for the 2601B-PULSE:

```
FS_rdg = smua.measure.i()
```

20. Turn off the output:

```
smua.source.output = smua.OUTPUT_OFF
```

21. Send the source calibration command using the *-range*, *-zero* and *-FS* multimeter readings, and *-zero* and *-FS* source values for the parameters:

```
smua.source.calibratei(-range, src_Z, DMM_Z_rdg, src_FS, DMM_FS_rdg)
```

Where:

-range = The negative of the present adjustment range
src_Z = The zero 2601B-PULSE source output value
DMM_Z_rdg = The zero DMM measurement
src_FS = The FS 2601B-PULSE source output value
DMM_FS_rdg = The FS DMM measurement

Typical values for the 100 mA range:

```
smua.source.calibratei(-100e-3, -1e-30, -1e-6, -90e-3, -89.2e-3)
```

22. If this step is not on the CALA sense mode, send the measure calibration command using the multimeter and 2601B-PULSE readings, and range setting for the parameters:

```
smua.measure.calibratei(-range, Z_rdg, DMM_Z_rdg, FS_rdg, DMM_FS_rdg)
```

Where:

-range = The negative of the present adjustment range
Z_rdg = The zero 2601B-PULSE measurement
DMM_Z_rdg = The zero DMM measurement
FS_rdg = The FS 2601B-PULSE measurement
DMM_FS_rdg = The FS DMM measurement

Typical 100 mA range values:

```
smua.measure.calibratei(-100e-3, -1e-5, -1e-6, -91e-3, -89.2e-3)
```

- D. Before continuing, be sure to complete all steps for the 100 nA to 1 A ranges before continuing with 3 A and 10 A range adjustment.
- E. Change connections as shown in the following figure.

Figure 160: Connections for 1.5 A and 3 A current ranges

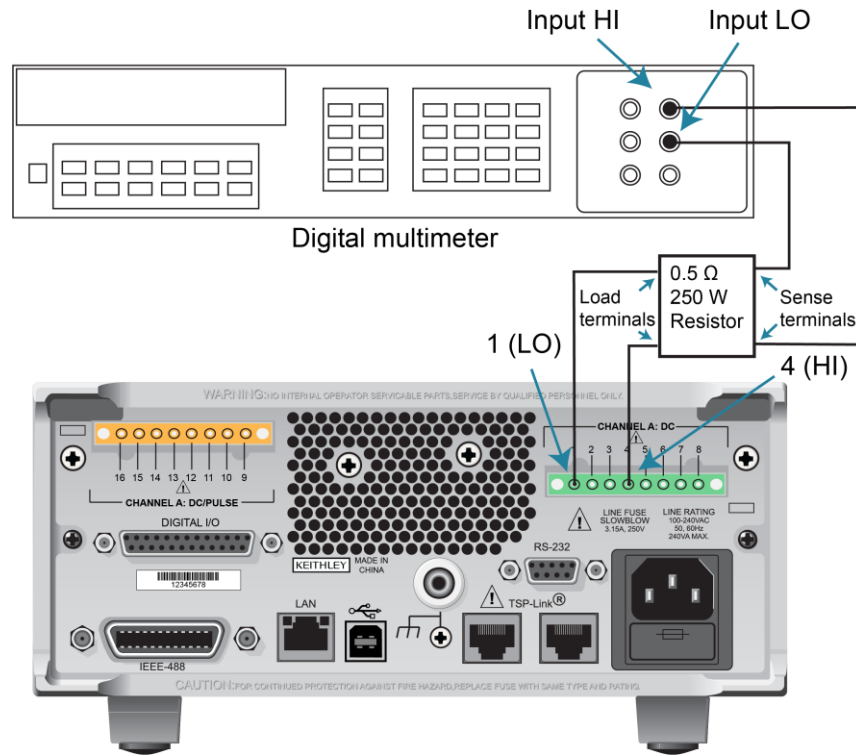

- F. Select the DMM DC volts function.
- G. Repeat the 22 steps of C for the 3 A and 10 A ranges. Compute the current reading from the DMM voltage reading and characterized 0.5 Ω resistance value: $I = V/R$.
- H. Select automatic polarity mode:
`smua.cal.polarity = smua.CAL_AUTO`

NOTE

The 2601B-PULSE can be adjusted with this method for the 100 nA setting.

Step 4. Contact check adjustment

- A. As illustrated in the following figure:
- Short the 2601B-PULSE SENSE LO and LO terminals together.
 - Short the SENSE HI and HI terminals together.

Figure 161: Connections for contact check 0 Ω calibration

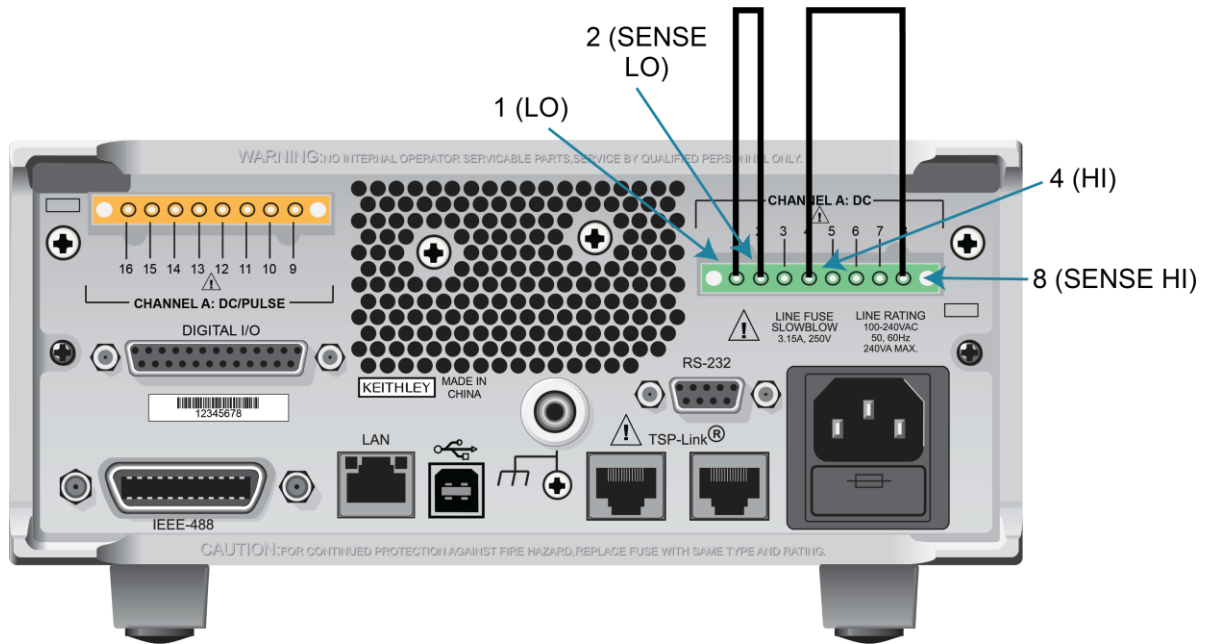

- B. Allow the readings to settle, then get the 2601B-PULSE readings:
- ```
r0_hi, r0_lo = smua.contact.r()
```
- C. Characterize both 50  $\Omega$  resistors using the resistance function of the digital multimeter.
- D. As illustrated in the following figure:
- Characterize both 50  $\Omega$  resistors using the resistance function of the digital multimeter.
  - Connect a 50  $\Omega$  resistor between the SENSE LO and LO terminals.
  - Connect the second 50  $\Omega$  resistor between the SENSE HI and HI terminals.



**Figure 162: Connections for contact check 50 Ω calibration**

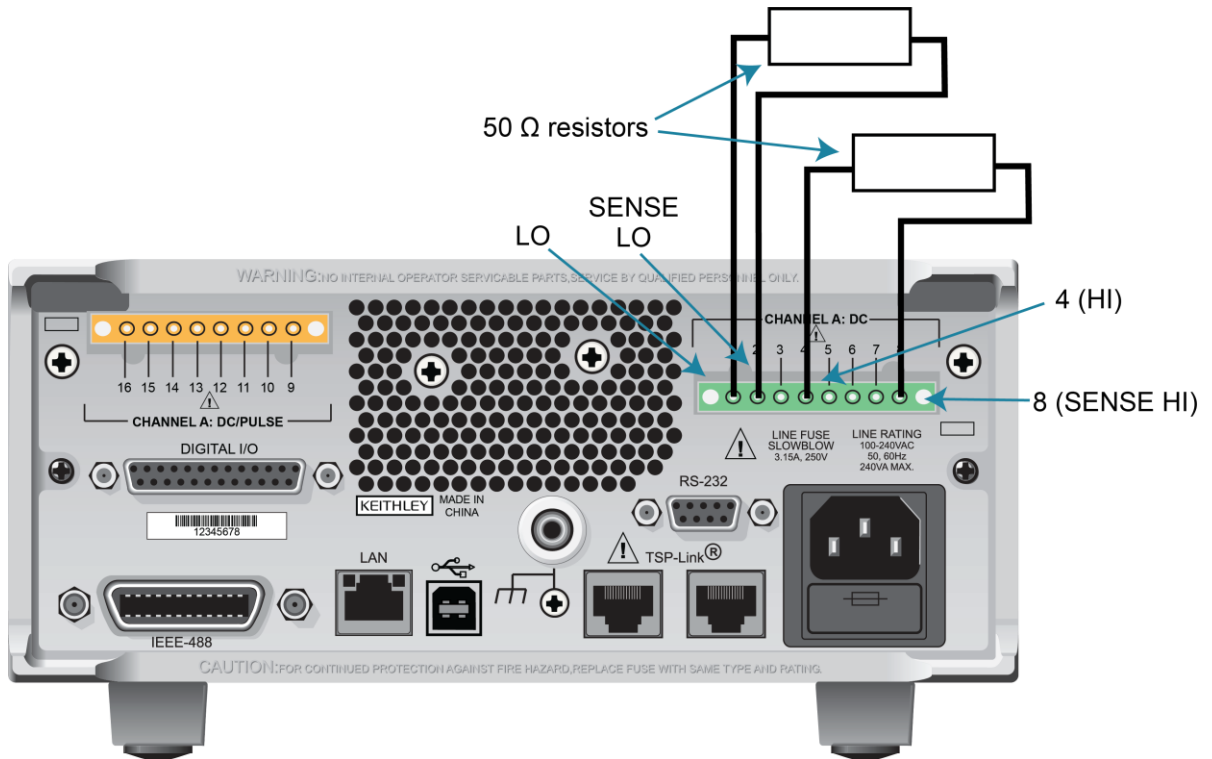

E. Allow the readings to settle, then get the 2601B-PULSE readings:

```
r50_hi, r50_lo = smua.contact.r()
```

F. Send the contact check low calibration command:

```
smua.contact.calibratelo(r0_lo, Z_actual, r50_lo, 50_ohm_actual)
```

**Where:**

- r0\_lo* = 2601B-PULSE 0 Ω low measurement
- Z\_actual* = Actual zero value; the resistance of the short between the SENSE LO and LO terminals
- r50\_lo* = 2601B-PULSE 50 Ω low measurement
- 50\_ohm\_actual* = Actual 50 Ω resistor value; the actual value of the resistor between the SENSE LO and LO terminals

**Typical values:**

```
smua.contact.calibratelo(r0_lo, 0, r50_lo, 50.15)
```

Where *r0\_lo* is the same value as measured in step B, and *r50\_lo* is the same value as measured in step E.

G. Send the contact check high calibration command:

```
smua.contact.calibratehi(r0_hi, Z_actual, r50_hi, 50_ohm_actual)
```

Where:

- r0\_hi* = 2601B-PULSE 0 Ω high measurement
- Z\_actual* = Actual zero value; the resistance of the short between the SENSE HI and HI terminals
- r50\_hi* = 2601B-PULSE 50 Ω high measurement
- 50\_ohm\_actual* = Actual 50 Ω resistor value; the value of the resistor between the SENSE HI and HI terminals

Typical values:

```
smua.contact.calibratehi(r0_hi, 0, r50_hi, 50.15)
```

Where *r0\_hi* is the same value as measured in step B, and *r50\_hi* is the same value as measured in step E.

### Step 5. Bias current adjustment

#### NOTE

For detail on wiring the pulse load, refer to [Pulse loads](#) (on page 13-3).

- A. Connect the 2601B-PULSE to the multimeter, as shown in the following figure.
- B. Select the multimeter DC current function.

Figure 163: Bias connections

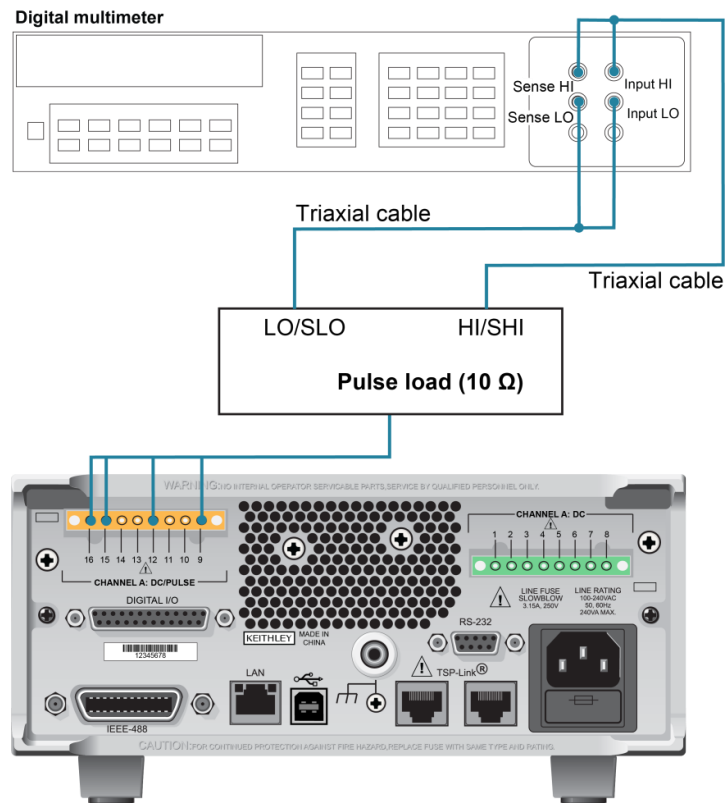

C. Perform each step listed in the step sequence for the 250 mA range as follows:

1. Characterize the resistor.

2. Reset the instrument.

3. Set the High-Z output-off mode.

```
smua.reset()
```

```
smua.source.offmode = smua.OUTPUT_HIGH_Z
```

4. Select the range being adjusted:

```
smua.pulser.rangev = 5
```

```
smua.pulser.rangei = 5
```

5. Enable the pulser.

```
smua.pulser.enable = 1
```

6. Select positive polarity, then set the bias source output to the positive zero value:

```
smua.cal.polarity = smua.CAL_POSITIVE
```

```
smua.source.leveli = 2.5e-3
```

7. Turn on the output:

```
smua.source.output = smua.OUTPUT_ON
```

8. Allow the readings to settle.

9. Get the multimeter and 2601B-PULSE current readings at the positive zero value. The two measurements should be made as close as possible in time. Use this command for the 2601B-PULSE:

```
Z_rdg = smua.measure.i()
```

10. Turn off the output and disable the pulser:

```
smua.source.output = smua.OUTPUT_OFF
```

```
smua.pulser.enable = 0
```

11. Set the source output to the positive full-scale value for the present range:

```
smua.source.leveli = 225e-3
```

12. Enable the pulser and turn on the output:

```
smua.pulser.enable = 1
```

```
smua.source.output = smua.OUTPUT_ON
```

13. Allow the readings to settle.

14. Get both the multimeter and 2601B-PULSE current readings at the positive full-scale output value. The two measurements should be made as close as possible in time. Use this command for the 2601B-PULSE:

```
FS_rdg = smua.measure.i()
```

15. Turn off the output and disable the pulser:

```
smua.source.output = smua.OUTPUT_OFF
```

```
smua.pulser.enable = 0
```

16. Send the source calibration command using the range, zero and +FS multimeter readings, and zero and +FS source values for the parameters:

```
smua.pulser.source.calibratebiasi(range, src_Z, DMM_Z_rdg, src_FS, DMM_FS_rdg)
```

**Where:**

*range* = The present adjustment range  
*src\_Z* = The +zero 2601B-PULSE source output value  
*DMM\_Z\_rdg* = The +zero DMM measurement  
*src\_FS* = The +FS 2601B-PULSE source output value  
*DMM\_FS\_rdg* = The +FS DMM measurement

Typical values for the 250 mA range:

```
smua.source.calibratebiasi(250e-3, 2.5e-3, 2.4e-3, 225e-3, 223e-3)
```

17. Select negative polarity, then set the source output to the negative zero value, for example:

```
smua.cal.polarity = smua.CAL_NEGATIVE
```

```
smua.source.level1 = -2.5e-3
```

18. Enable the pulser and turn on the output:

```
smua.pulser.enable = 1
```

```
smua.source.output = smua.OUTPUT_ON
```

19. Allow the readings to settle.

20. Get both the multimeter and 2601B-PULSE current readings at the negative zero value.

---

## NOTE

The 2601B-PULSE measurement is not necessary if this step is being done on the CALA sense mode.

---

The two measurements should be made as close as possible in time. Use this command for the 2601B-PULSE:

```
Z_rdg = smua.measure.i()
```

21. Turn off the output and disable the pulser:

```
smua.source.output = smua.OUTPUT_OFF
```

```
smua.pulser.enable = 0
```

22. Set the source output to the negative full-scale value, for example:

```
smua.source.level1 = -225e-3
```

23. Enable the pulser and turn on the output:

```
smua.pulser.enable = 1
```

```
smua.source.output = smua.OUTPUT_ON
```

24. Allow the readings to settle.

25. Get the multimeter and 2601B-PULSE current readings at the negative full-scale output value.

---

## NOTE

The 2601B-PULSE measurement is not necessary if this step is being done on the CALA sense mode.

---

The two measurements should be made as close as possible in time. Use this command for the 2601B-PULSE:

```
FS_rdg = smua.measure.i()
```

26. Turn off the output and disable the pulser:

```
smua.source.output = smua.OUTPUT_OFF
```

```
smua.pulser.enable = 0
```

27. Send the source calibration command using the `-range`, `-zero` and `-FS` multimeter readings, and `-zero` and `-FS` source values for the parameters:

```
smua.source.calibratebiasi(-range, src_Z, DMM_Z_rdg, src_FS, DMM_FS_rdg
```

**Where:**

`-range` = The negative of the present adjustment range

`src_Z` = The zero 2601B-PULSE source output value

`DMM_Z_rdg` = The zero DMM measurement

`src_FS` = The FS 2601B-PULSE source output value

`DMM_FS_rdg` = The FS DMM measurement

Typical values for the 250 mA range:

```
smua.source.calibratebiasi(-250e-3, -2.5e-3, -2.4e-3, -225e-3, -223e-3)
```

## Step 6. Pulse adjustment

This procedure adjusts the pulse source and current and voltage measurements.

If you do not need to adjust all three, only send the command for the area you want to adjust:

- Pulse source: `smua.pulser.source.calibratei()`
- Pulse current measure: `smua.pulser.measure.calibratei()`
- Pulse voltage measure: `smua.pulser.measure.calibratev()`

---

## NOTE

For detail on wiring the pulse load, refer to [Pulse loads](#) (on page 13-3).

---

**To adjust the pulse:**

A. Connect the 2601B-PULSE to the digitizer as shown in the following figure.

**Figure 164: Pulse accuracy calibration and adjustment connections**

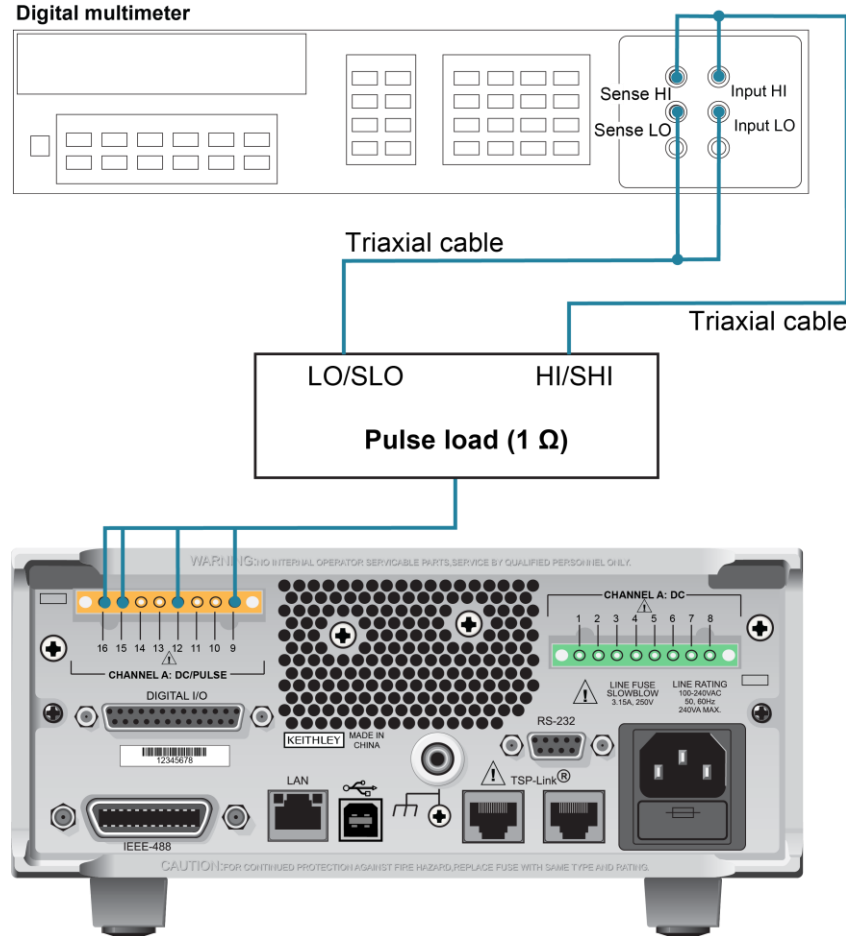

B. Select the multimeter DC current function.

C. Characterize the resistor.

D. Perform each step listed in the step sequence for the 1 A range as follows:

1. Reset the unit:

```
smua.reset()
```

2. Select the range being adjusted. For the 1 A and 5 A ranges, use the 5 V range. For 10 A, use the 10 V range.

```
smua.pulser.rangev = 5
```

```
smua.pulser.rangei = 1
```

3. Enable the pulser:

```
smua.pulser.enable = 1
```

4. Select positive polarity, set the bias source output to 5 mA, and turn autozero off:  

```
smua.cal.polarity = smua.CAL_POSITIVE
smua.source.level1 = 5e-3
smua.measure.autozero = smua.AUTOZERO_OFF
```
5. Configure the trigger so the external digitizer can synchronize measurements:  

```
digio.trigger[1].mode = digio.TRIG_RISING
digio.trigger[1].pulsewidth = 10e-6
digio.trigger[1].stimulus = smua.trigger.SOURCE_COMPLETE_EVENT_ID
smua.trigger.source.action = smua.ENABLE
smua.trigger.measure.action = smua.ENABLE
trigger.timer[1].delay = 500e-6
trigger.timer[1].count = 1
trigger.timer[1].passthrough = false
trigger.timer[1].stimulus = smua.trigger.ARMED_EVENT_ID
smua.trigger.source.stimulus = trigger.timer[1].EVENT_ID
smua.trigger.endpulse.action = smua.SOURCE_IDLE
smua.trigger.count = 1
smua.trigger.arm.count = 1
```
6. Configure the pulse:  

```
smua.trigger.source.listi({0.01})
smua.trigger.source.pulsewidth = 400e-6
smua.pulser.measure.delay = 30e-6
smua.pulser.measure.aperture = 50e-6
smua.measure.interval = 60e-6
smua.measure.count = 1
smua.measure.filter.enable = smua.FILTER_OFF
```
7. Configure the buffers:  

```
smua.nvbuffer1.clear()
smua.nvbuffer2.clear()
smua.trigger.measure.iv(smua.nvbuffer1, smua.nvbuffer2)
```
8. Enable the pulser and turn on the output:  

```
smua.pulser.enable = 1
smua.source.output = smua.OUTPUT_ON
```
9. Initiate the trigger and wait for it to complete:  

```
smua.trigger.initiate()
waitcomplete()
```
10. Turn off the output and disable the pulser:  

```
smua.source.output = smua.OUTPUT_OFF
smua.pulser.enable = 0
```

11. Read out the buffer:

```
ZS_IRdg = printbuffer(1, 1, smua.nvbuffer1)
ZS_VRdg(1, 1, smua.nvbuffer2) -- voltage measurements.
```

12. Do this 10 times and average the results.

13. Set the source output to the positive full-scale value for the present range, for example:

```
smua.trigger.source.listi({0.75})
```

14. Clear the buffers:

```
smua.nvbuffer1.clear()
smua.nvbuffer2.clear()
```

15. Enable the pulser and turn on the output:

```
smua.pulser.enable = 1
smua.source.output = smua.OUTPUT_ON
```

16. Initiate the trigger and wait for it to complete:

```
smua.trigger.initiate()
waitcomplete()
```

17. Turn off the output and disable the pulser:

```
smua.source.output = smua.OUTPUT_OFF
smua.pulser.enable = 0
```

18. Read out the buffer:

```
FS_IRdg = printbuffer(1, 1, smua.nvbuffer1)
FS_VRdg = printbuffer(1, 1, smua.nvbuffer2)
```

19. Do this 10 times and average the results.

20. Send the source calibration command using the range, averaged zero and averaged full scale digitizer readings, and zero and full scale source values for the parameters:

```
smua.pulser.source.calibratei(range, ZS_IRdg, digi_Z_rdg, FS_IRdg, digi_FS_rdg)
```

**Where:**

*range* = The present adjustment range  
*ZS\_IRdg* = The +zero scale 2601B-PULSE source output value  
*digi\_Z\_rdg* = The +zero scale digitizer measurement  
*FS\_IRdg* = The +full scale 2601B-PULSE source output value  
*digi\_FS\_rdg* = The +full scale digitizer measurement

Typical values for the 1 A source range:

```
smua.pulser.source.calibratei(1, 0.01, 0.011, 0.75, 0.76)
```



21. Send the current measure calibration command using the range, averaged zero and averaged full scale digitizer readings, and averaged zero and averaged full scale source values for the parameters:

```
smua.pulser.source.calibratei(range, ZS_IRdg, digi_Z_rdg, FS_IRdg, digi_FS_rdg)
```

**Where:**

*range* = The present adjustment range  
*ZS\_IRdg* = The +zero scale 2601B-PULSE measurement value  
*digi\_Z\_rdg* = The +zero scale digitizer measurement  
*FS\_IRdg* = The +full scale 2601B-PULSE measurement value  
*digi\_FS\_rdg* = The +full scale digitizer measurement

Typical values for the 1 A measurement range:

```
smua.pulser.measure.calibratei(1, 0.01, 0.011, 0.75, 0.76)
```

22. Send the voltage measure calibration command using the range, averaged zero and averaged full scale digitizer readings, and averaged zero and averaged full scale source values for the parameters:

```
smua.pulser.source.calibratei(range, ZS_VRdg, digi_Z_rdg, FS_VRdg, digi_FS_rdg)
```

**Where:**

*range* = The present adjustment range  
*ZS\_VRdg* = The +zero scale 2601B-PULSE measurement value  
*digi\_Z\_rdg* = The +zero scale digitizer measurement  
*FS\_VRdg* = The +full scale 2601B-PULSE measurement value  
*digi\_FS\_rdg* = The +full scale digitizer measurement

Typical values for the 1 A measurement range:

```
smua.pulser.measure.calibratei(1, 0.01, 0.011, 0.75, 0.76)
```

23. Enable the pulser:

```
smua.pulser.enable = 1
```

24. Select positive polarity and set the bias source output to -5 mA:

```
smua.cal.polarity = smua.CAL_NEGATIVE
smua.source.level1 = -5e-3
```

25. Configure the pulse:

```
smua.trigger.source.listi({-0.01})
```

26. Clear the buffers:

```
smua.nvbuffer1.clear()
smua.nvbuffer2.clear()
```

27. Turn on the output:

```
smua.source.output = smua.OUTPUT_ON
```

28. Initiate the trigger and wait for it to complete:

```
smua.trigger.initiate()
waitcomplete()
```

29. Turn off the output and disable the pulser:

```
smua.source.output = smua.OUTPUT_OFF
smua.pulser.enable = 0
```

30. Read out the buffer:

```
ZS_IRdg = printbuffer(1, 1, smua.nvbuffer1)
ZS_VRdg(1, 1, smua.nvbuffer2) -- voltage measurements.
```

31. Do this 10 times and average the results.

32. Set the source output to the positive full-scale value for the present range, for example:

```
smua.trigger.source.listi({-0.75})
```

33. Clear the buffers:

```
smua.nvbuffer1.clear()
smua.nvbuffer2.clear()
```

34. Enable the pulser and turn on the output:

```
smua.pulser.enable = 1
smua.source.output = smua.OUTPUT_ON
```

35. Initiate the trigger and wait for it to complete:

```
smua.trigger.initiate()
waitcomplete()
```

36. Turn off the output and disable the pulser:

```
smua.source.output = smua.OUTPUT_OFF
smua.pulser.enable = 0
```

37. Read out the buffer:

```
FS_IRdg = printbuffer(1, 1, smua.nvbuffer1)
FS_VRdg = printbuffer(1, 1, smua.nvbuffer2)
```

38. Do this 10 times and average the results

39. Send the source calibration command using the range, averaged zero and averaged full scale digitizer readings, and zero and full scale source values for the parameters:

```
smua.pulser.source.calibratei(range, ZS_IRdg, digi_Z_rdg, FS_IRdg, digi_FS_rdg)
```

**Where:**

*range* = The present adjustment range  
*ZS\_IRdg* = The -zero scale 2601B-PULSE source output value  
*digi\_Z\_rdg* = The -zero scale digitizer measurement  
*FS\_IRdg* = The -full scale 2601B-PULSE source output value  
*digi\_FS\_rdg* = The -full scale digitizer measurement

Typical values for the -1 A source range:

```
smua.source.calibratei(-1, -0.01, -0.011, -0.75, -0.76)
```

40. Send the current measure calibration command using the range, averaged zero and averaged full scale digitizer readings, and averaged zero and averaged full scale source values for the parameters:

```
smua.pulser.measure.calibratei(range, DMM_Z_Rdg, digi_Z_rdg, FS_IRdg, digi_FS_rdg)
```

**Where:**

*range* = The present adjustment range  
*DMM\_Z\_Rdg* = The -zero scale 2601B-PULSE measurement value  
*digi\_Z\_rdg* = The -zero scale digitizer measurement  
*FS\_IRdg* = The -full scale 2601B-PULSE measurement value  
*digi\_FS\_rdg* = The -full scale digitizer measurement

Typical values for the -1 A measurements range:

```
smua.pulser.measure.calibratei(-1, -0.01, -0.011, -0.75, -0.76)
```

41. Send the voltage measure calibration command using the range, averaged zero and averaged full scale digitizer readings, and averaged zero and averaged full scale source values for the parameters:

```
smua.pulser.source.calibratei(range, ZS_VRdg, digi_Z_rdg, FS_VRdg, digi_FS_rdg)
```

**Where:**

*range* = The present adjustment range  
*ZS\_VRdg* = The -zero scale 2601B-PULSE measurement value  
*digi\_Z\_rdg* = The -zero scale digitizer measurement  
*FS\_VRdg* = The -full scale 2601B-PULSE measurement value  
*digi\_FS\_rdg* = The -full scale digitizer measurement

Typical values for the -1 A measurements range:

```
smua.pulser.measure.calibratei(-1, -0.01, -0.011, -0.75, -0.76)
```

- E. Select automatic polarity mode:

```
smua.cal.polarity = smua.CAL_AUTO
```

## Step 7. Program calibration dates

Use the following command to set the calibration adjustment date:

```
smua.cal.adjustdate = os.time{year=2019, month=12, day=1}
```

Optionally, it is possible to set the calibration date and calibration due date with the following commands:

```
smua.cal.date = os.time{year=2019, month=12, day=1}
```

```
smua.cal.due = os.time{year=2020, month=12, day=1}
```

If you do not wish to set a calibration date or calibration due date and want to clear the previous values, use the following commands:

```
smua.cal.date = 0
```

```
smua.cal.due = 0
```

The actual year, month, day, and (optional) hour and minute should be used (seconds can be given but are essentially ignored due to the precision of the internal date storage format). The allowable range for the year is from 1970 to 2037, the month is from 1 to 12, and the day is from 1 to 31.

## Step 8. Save calibration constants

Calibration adjustment is now complete, so you can store the calibration constants in nonvolatile memory by sending the following command:

```
smua.cal.save()
```

---

### NOTE

Unless you send the save command, the calibration adjustment you just performed is temporary.

---

## Step 9. Lock out calibration adjustment

To lock out further calibration adjustment, send the following command after completing the adjustment procedure:

```
smua.cal.lock()
```

## Reinstall the 2601B-P-INT

When the calibration and adjustment procedures are complete, reinstall the 2601B-P-INT.

Refer to [Installing the 2601B-P-INT](#) (on page 2-6) for detail.

---

## Common commands

### In this section:

|                                  |      |
|----------------------------------|------|
| Command summary .....            | 14-1 |
| Script command equivalents ..... | 14-2 |
| Command reference .....          | 14-3 |

## Command summary

The IEEE Std 488.2 common commands that are supported by the 2601B-PULSE are summarized in the following table. Although commands are shown in uppercase, common commands are not case sensitive, and either uppercase or lowercase can be used. Note that although these commands are essentially the same as those defined by the IEEE Std 488.2 standard, the 2601B-PULSE does not strictly conform to that standard.

---

### NOTE

Unlike other commands, like those listed in [TSP commands](#) (on page 11-8), each common command must be sent in a separate message.

The common commands cannot be used in scripts.

---

| Command          | Name                        | Description                                                                                                                                                                                                                                         |
|------------------|-----------------------------|-----------------------------------------------------------------------------------------------------------------------------------------------------------------------------------------------------------------------------------------------------|
| *CLS             | Clear status                | Clears all event registers and Error Queue. For detailed information including status commands, see the <a href="#">Status model</a> (on page 15-1).                                                                                                |
| *ESE <i>mask</i> | Event enable command        | Program the Standard Event Status Enable Register. For detailed information including status commands, see the <a href="#">Status model</a> (on page 15-1).                                                                                         |
| *ESE?            | Event enable query          | Read the Standard Event Status Enable Register. For detailed information including status commands, see the <a href="#">Status model</a> (on page 15-1).                                                                                            |
| *ESR?            | Event status register query | Read/clear the Standard Event Enable Register. For detailed information including status commands, see the <a href="#">Status model</a> (on page 15-1).                                                                                             |
| *IDN?            | Identification query        | Returns the manufacturer, model number, serial number, and firmware revision levels of the unit. For detailed information, see <a href="#">Identification query: *IDN?</a> (on page 14-3).                                                          |
| *OPC             | Operation complete command  | Set the Operation Complete bit in the Standard Event Register after all pending commands, including overlapped commands, have completed. For detailed information, see <a href="#">Operation complete and query: *OPC and *OPC?</a> (on page 14-3). |

| Command          | Name                           | Description                                                                                                                                                                                              |
|------------------|--------------------------------|----------------------------------------------------------------------------------------------------------------------------------------------------------------------------------------------------------|
| *OPC?            | Operation complete query       | Places an ASCII "1" into the output queue when all selected device operations have completed. For detailed information, see <a href="#">Operation complete and query: *OPC and *OPC?</a> (on page 14-3). |
| *RST             | Reset command                  | Returns the 2601B-PULSE to default conditions. For detailed information, see <a href="#">Reset: *RST</a> (on page 14-3).                                                                                 |
| *SRE <i>mask</i> | Service request enable command | Programs the Service Request Enable Register. For detailed information including status commands, see the <a href="#">Status model</a> (on page 15-1).                                                   |
| *SRE?            | Service request enable query   | Reads the Service Request Enable Register. For detailed information including status commands, see the <a href="#">Status model</a> (on page 15-1).                                                      |
| *STB?            | Status byte query              | Reads the status byte register. For detailed information including status commands, see the <a href="#">Status model</a> (on page 15-1).                                                                 |
| *TRG             | Trigger command                | Generates the <code>trigger.EVENT_ID</code> trigger event for use with the trigger model. For detailed information, see <a href="#">Trigger: *TRG</a> (on page 14-4).                                    |
| *TST?            | Self-test query                | Returns a 0. For detailed information, see <a href="#">Self-test query: *TST?</a> (on page 14-4).                                                                                                        |
| *WAI             | Wait-to-continue command       | Waits until all previous commands have completed. For detailed information, see <a href="#">Wait-to-continue: *WAI</a> (on page 14-4).                                                                   |

## Script command equivalents

The TSP commands that can be included in scripts that are equivalent to the common commands are defined in the table below.

| Common command   | Script command equivalent                                                                                                   |
|------------------|-----------------------------------------------------------------------------------------------------------------------------|
| *CLS             | <code>status.reset()</code>                                                                                                 |
| *ESE?            | <code>print(tostring(status.standard.enable))</code>                                                                        |
| *ESE <i>mask</i> | <code>status.standard.enable = mask</code>                                                                                  |
| *ESR?            | <code>print(tostring(status.standard.event))</code>                                                                         |
| *IDN?            | <code>print([[Keithley Instruments, Model]]..localnode.model..[[, ]].localnode.serialno.. [[, ]].localnode.revision)</code> |
| *OPC?            | <code>waitcomplete() print([[1]])</code>                                                                                    |
| *OPC             | <code>opc()</code>                                                                                                          |
| *RST             | <code>reset()</code>                                                                                                        |
| *SRE?            | <code>print(tostring(status.request_enable))</code>                                                                         |
| *SRE <i>mask</i> | <code>status.request_enable = mask</code>                                                                                   |
| *STB?            | <code>print(tostring(status.condition))</code>                                                                              |
| *TRG             | N/A                                                                                                                         |
| *TST?            | <code>print([[0]])</code>                                                                                                   |
| *WAI             | <code>waitcomplete()</code>                                                                                                 |

## Command reference

Details of all common commands (except those associated with the status model) are described below.

---

### NOTE

Status command usage is in the [Status model](#) (on page 15-1).

---

### Identification query: \*IDN?

Retrieves the identification string.

\*IDN?      Command that reads ID information

The identification string includes the manufacturer, model number, serial number, and firmware revision levels. This string is sent in the following format:

```
Keithley Instruments, Model 2601B-PULSE, xxxxxxxx, yyyy
```

Where:

xxxxxxx is the serial number

yyyy is the firmware revision level

### Operation complete and query: \*OPC and \*OPC?

Wait for pending overlapped commands to complete.

\*OPC      Operation complete command that sets the OPC bit

\*OPC?     Operation complete query that places a "1" in the output queue

When \*OPC is sent, the OPC bit in the Standard Event Register (see [Status model](#) (on page 15-1)) is set when all overlapped commands complete. The \*OPC? command places an ASCII "1" in the output queue when all previous overlapped commands complete.

### Reset: \*RST

Returns the instrument to default conditions.

\*RST      Command that returns the instrument to default conditions

When the \*RST command is sent, the instrument returns to the default conditions. This performs the same actions as [reset\(\)](#) (on page 11-156).

## Self-test query: \*TST?

Requests self-test results.

\*TST?      Places a zero (0) in the output queue

This command always places a zero (0) in the output queue. This command is included for common command compatibility only; the 2601B-PULSE does not actually perform a self-test.

## Trigger: \*TRG

Generates a command interface trigger event for the trigger model.

\*TRG      This command generates the `trigger.EVENT_ID` trigger event for the trigger model

The `trigger.EVENT_ID` is a constant that contains the command interface trigger event number. You can set the stimulus of any trigger object to the value of this constant to have the trigger object respond to the trigger events generated by this command. See [trigger.EVENT\\_ID](#) (on page 11-355) and [Using the remote trigger model](#) (on page 6-3).

## Wait-to-continue: \*WAI

Suspends the execution of subsequent commands until all previous overlapped commands are finished.

\*WAI      This pauses until overlapped commands are complete

Two types of device commands exist:

- **Overlapped commands.** Commands that allow the execution of subsequent commands while instrument operations of the overlapped command are still in progress.
- **Sequential commands.** Commands whose operations finish before the next command is executed.

The \*WAI command suspends the execution of subsequent commands until the instrument operations of all previous overlapped commands are finished. The \*WAI command is not needed for sequential commands.



---

## Status model

### In this section:

|                                                  |       |
|--------------------------------------------------|-------|
| Overview .....                                   | 15-1  |
| Clearing registers .....                         | 15-13 |
| Programming enable and transition registers..... | 15-14 |
| Reading registers .....                          | 15-15 |
| Status byte and service request (SRQ) .....      | 15-15 |
| Status register sets .....                       | 15-20 |
| TSP-Link system status .....                     | 15-25 |

## Overview

Each Keithley Instruments 2601B-PULSE provides status registers and queues that are collectively referred to as the status model. Through manipulation and monitoring of these registers and queues, you can view and control various instrument events. You can include commands in your test program that can determine if a service request (SRQ) event has occurred and the cause of the event.

The heart of the status model is the Status Byte Register. All status model registers and queues flow into the Status Byte Register.

The entire status model is illustrated in the [Status model diagrams](#) (on page 15-5).

## Status register set contents

Typically, a status register set contains the following registers:

- **Condition** (`.condition`): A read-only register that is constantly updated to reflect the present operating conditions of the instrument.
- **Enable Register** (`.enable`): A read-write register that allows a summary bit to be set when an enabled event occurs.
- **Event Register** (`.event`): A read-only register that sets a bit to 1 when the applicable event occurs. If the enable register bit for that event is also set, the summary bit of the register will set to 1.
- **Negative Transition Register (NTR)** (`.ntr`): When a bit is set in this read-write register, it enables a 1 to 0 change in the corresponding bit of the condition register to cause the corresponding bit in the event register to be set.
- **Positive Transition Register (PTR)** (`.ptr`): When a bit is set in this read-write register, it enables a 0 to 1 change in the corresponding bit of the condition register to cause the corresponding bit in the event register to be set.

An event is represented by a condition register bit changing from a 1 to 0 or 0 to 1. When an event occurs and the appropriate NTR or PTR bit is set, the corresponding event register bit is set to 1. The event bit remains latched to 1 until the event register is read or the status model is reset. When an event register bit is set and its corresponding enable bit is set, the summary bit of the register is set to 1. This, in turn, sets a bit in a higher-level condition register, potentially cascading to the associated summary bit of the Status Byte Register.

## Queues

The 2601B-PULSE uses queues to store messages. The queues include:

- Command queue: Holds commands that are available for execution.
- Output queue: Holds response messages.
- Error queue: Holds error and status messages.

When a queue contains data, it sets the condition bit for that queue in one of the registers. The condition bits are:

- Command queue: CAV in the Operation Status Remote Summary Register
- Output queue: MAV in the Status Byte Register
- Error queue: EAV in the Status Byte Register

The CAV, MAV, and EAV bits in the registers are cleared when the queue is empty. Queues empty when:

- Commands are executed
- Errors are read from the error queue
- Response messages are read from the instrument

All 2601B-PULSE queues are first-in, first-out (FIFO).

The [Status model diagrams](#) (on page 15-5) shows how the queues are structured with the other registers.

## Command queue

The command queue holds commands that have been received from a remote interface that are available for execution. This allows the 2601B-PULSE to accept multiple commands and queue them for execution.

When a command is received from a remote interface, the command available (CAV) bit in the Operation Status Remote Summary Register is set. For additional detail, see [status.operation.remote.\\*](#) (on page 11-308).

## Output queue

Response messages, such as those generated from print commands, are placed in the output queue. All remote command interfaces share the same output queue.

The output queue sets the message available (MAV) bit in the status model.

The data in the output queue is cleared by the \*CLS command.

## Error queue

The error queue holds error and status messages. As programming errors and status messages occur, a message that defines the error or status is placed in the error queue.

An error or status message is cleared from the error queue when it is read. You can also clear the error queue by sending the command `errorqueue.clear()`. An empty error queue clears the error available (EAV) bit in the Status Byte Register.

Messages in the error queue include a code number, message text, severity, and TSP-Link® node number. See [Error summary list](#) (on page 12-2) for a list of the messages.

When you read a single message from the error queue, the oldest message is read. If you attempt to read the error queue when it is empty, the error number 0 and “No Error” is returned.

The commands that can be used to control the error queue are listed below.

### Error queue commands

| Error queue command                                                      | Description                                                           |
|--------------------------------------------------------------------------|-----------------------------------------------------------------------|
| <code>errorqueue.clear()</code>                                          | Clear error queue of all errors.                                      |
| <code>errorqueue.count</code>                                            | Number of messages in the error/event queue.                          |
| <code>errorCode, message, severity, errorNode = errorqueue.next()</code> | Request error code, text message, severity, and TSP-Link node number. |

## Status function summary

The following functions and attributes control and read the various registers. Additional information for the various register sets is included later in this section. Also, refer to the specific command as listed in [TSP commands](#) (on page 11-8).

### Status function summary

| Type           | Function or attribute                                                                                                                                                                                      |
|----------------|------------------------------------------------------------------------------------------------------------------------------------------------------------------------------------------------------------|
| Status summary | <code>status.condition</code><br><code>status.node_enable</code><br><code>status.node_event</code><br><code>status.request_enable</code><br><code>status.request_event</code><br><code>status.reset</code> |

**Status function summary**

| Type                | Function or attribute                                                                                                                                                                                                                                                                                                                                                                                                                                                                                                                                                                                                                                                                                                                                                                                                                                                    |
|---------------------|--------------------------------------------------------------------------------------------------------------------------------------------------------------------------------------------------------------------------------------------------------------------------------------------------------------------------------------------------------------------------------------------------------------------------------------------------------------------------------------------------------------------------------------------------------------------------------------------------------------------------------------------------------------------------------------------------------------------------------------------------------------------------------------------------------------------------------------------------------------------------|
| Measurement event   | status.measurement.*<br>status.measurement.buffer_available.*<br>status.measurement.current_limit.*<br>status.measurement.instrument.*<br>status.measurement.instrument.smua.*<br>status.measurement.protection.*<br>status.measurement.reading_overflow.*<br>status.measurement.voltage_limit.*                                                                                                                                                                                                                                                                                                                                                                                                                                                                                                                                                                         |
| Operation status    | status.operation.*<br>status.operation.calibrating.*<br>status.operation.instrument.*<br>status.operation.instrument.digio.*<br>status.operation.instrument.digio.trigger_overrun.*<br>status.operation.instrument.lan.*<br>status.operation.instrument.lan.trigger_overrun.*<br>status.operation.instrument.smua.*<br>status.operation.instrument.smua.trigger_overrun.*<br>status.operation.instrument.trigger_blender.*<br>status.operation.instrument.trigger_blender.trigger_overrun.*<br>status.operation.instrument.trigger_timer.*<br>status.operation.instrument.trigger_timer.trigger_overrun.*<br>status.operation.instrument.tsplink.*<br>status.operation.instrument.tsplink.trigger_overrun.*<br>status.operation.measuring.*<br>status.operation.remote.*<br>status.operation.sweeping.*<br>status.operation.trigger_overrun.*<br>status.operation.user.* |
| Questionable status | status.questionable.*<br>status.questionable.calibration.*<br>status.questionable.instrument.*<br>status.questionable.instrument.smua.*<br>status.questionable.over_temperature.*<br>status.questionable.unstable_output.*                                                                                                                                                                                                                                                                                                                                                                                                                                                                                                                                                                                                                                               |
| Standard event      | status.standard.*                                                                                                                                                                                                                                                                                                                                                                                                                                                                                                                                                                                                                                                                                                                                                                                                                                                        |
| System summary      | status.system.*<br>status.system2.*<br>status.system3.*<br>status.system4.*<br>status.system5.*                                                                                                                                                                                                                                                                                                                                                                                                                                                                                                                                                                                                                                                                                                                                                                          |

\* = .condition, .event, .ntr, .ptr and .enable

## Status model diagrams

The following figures graphically describe the status model:

- [Status byte and service request enable register](#) (on page 15-5)
- [System summary and standard event registers](#) (on page 15-6)
- [Measurement event registers](#) (on page 15-7)
- [Operation status registers](#) (on page 15-8)
- [Operation status trigger overrun registers](#) (on page 15-9)
- [Operation status trigger timer, trigger blender, and remote registers](#) (on page 15-10)
- [Operation status digital I/O and TSP-Link registers](#) (on page 15-11)
- [Questionable status registers](#) (on page 15-13)

Figure 165: Status byte and service request enable register

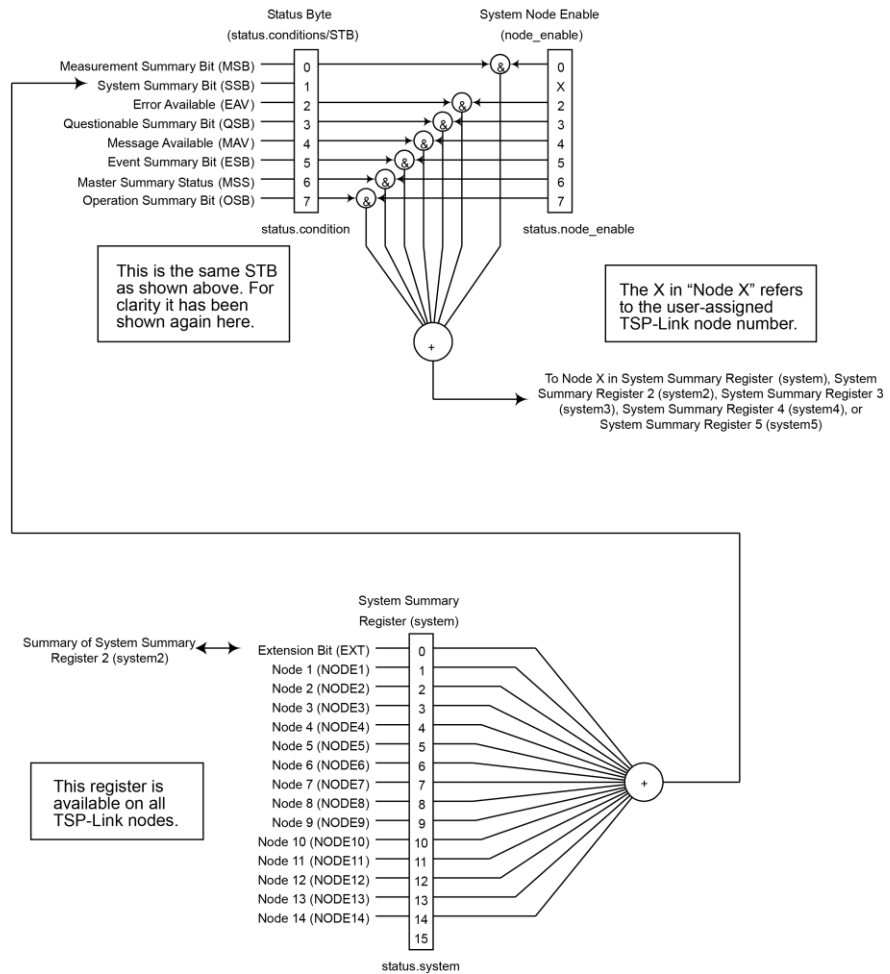
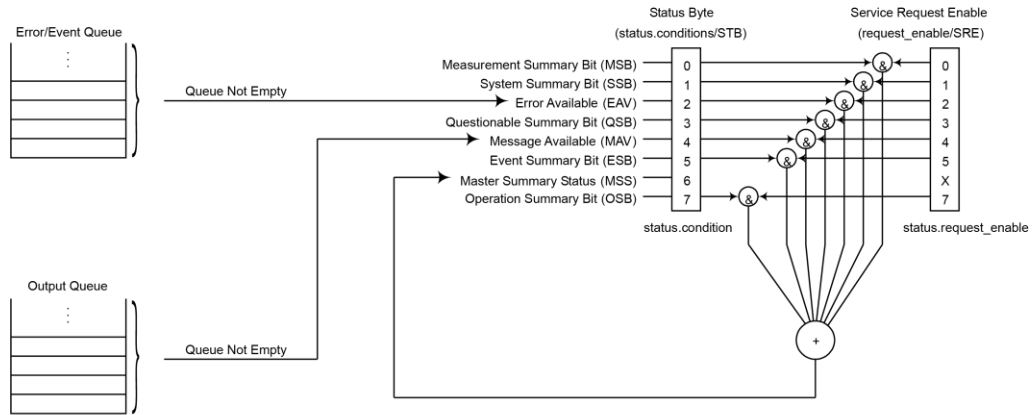

Figure 166: System summary and standard event registers

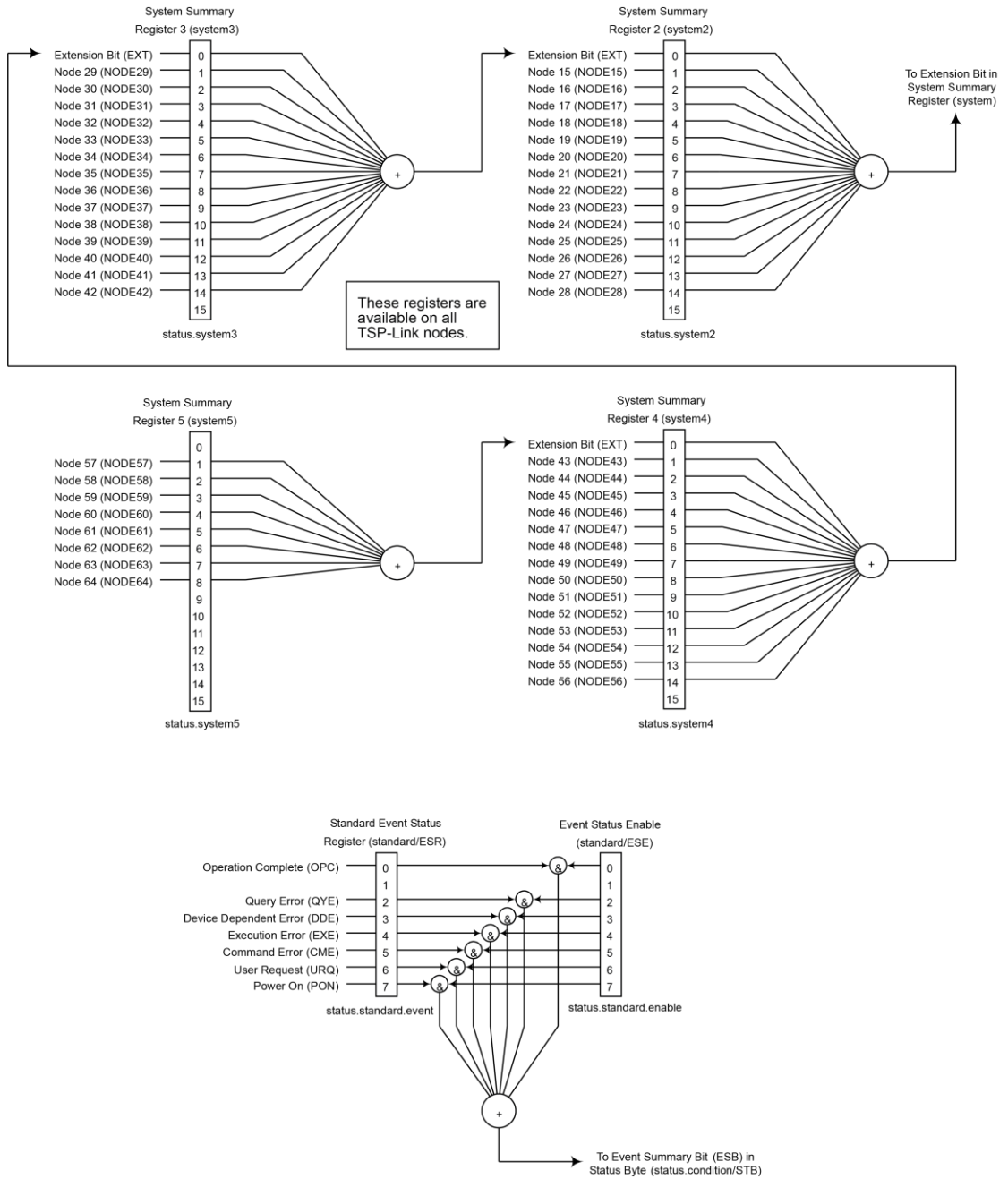

Figure 167: Measurement event registers

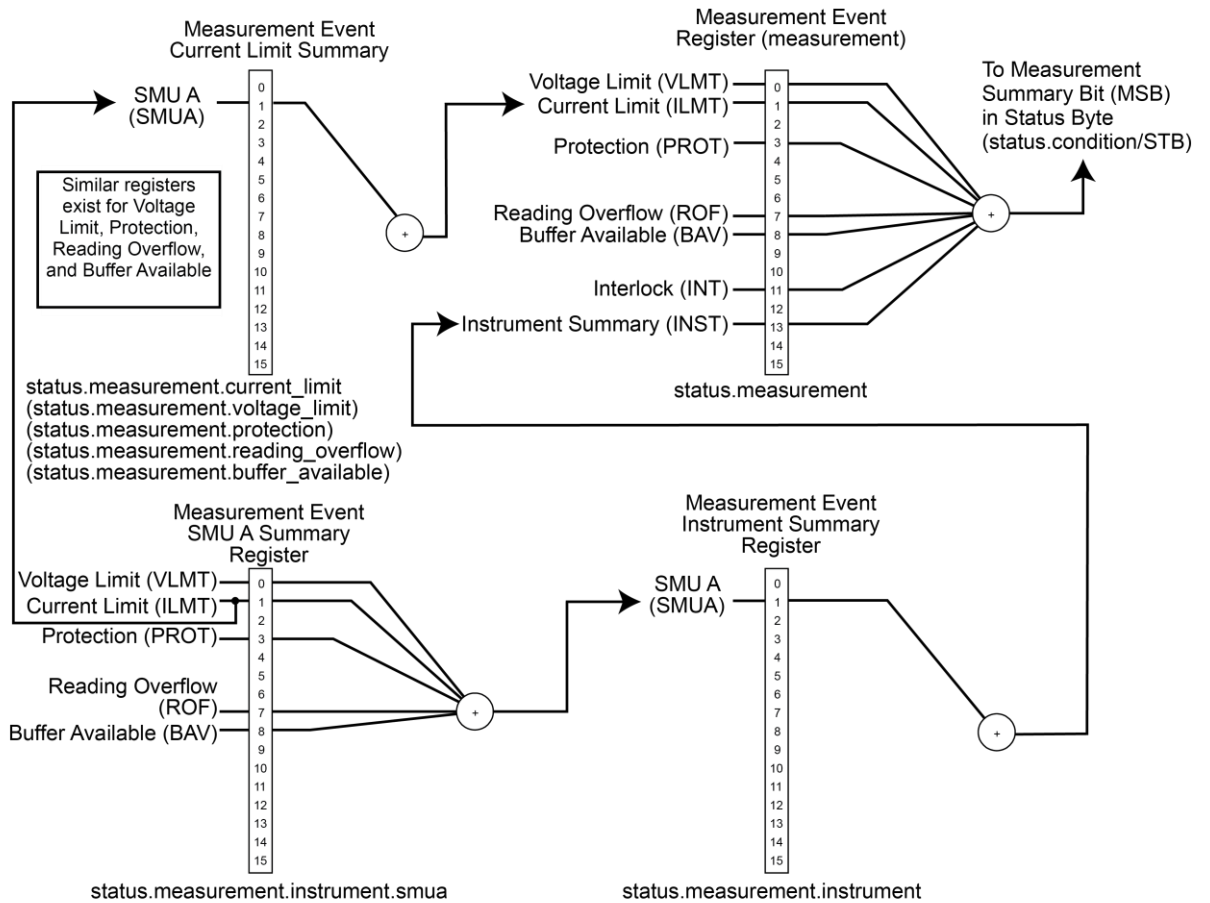
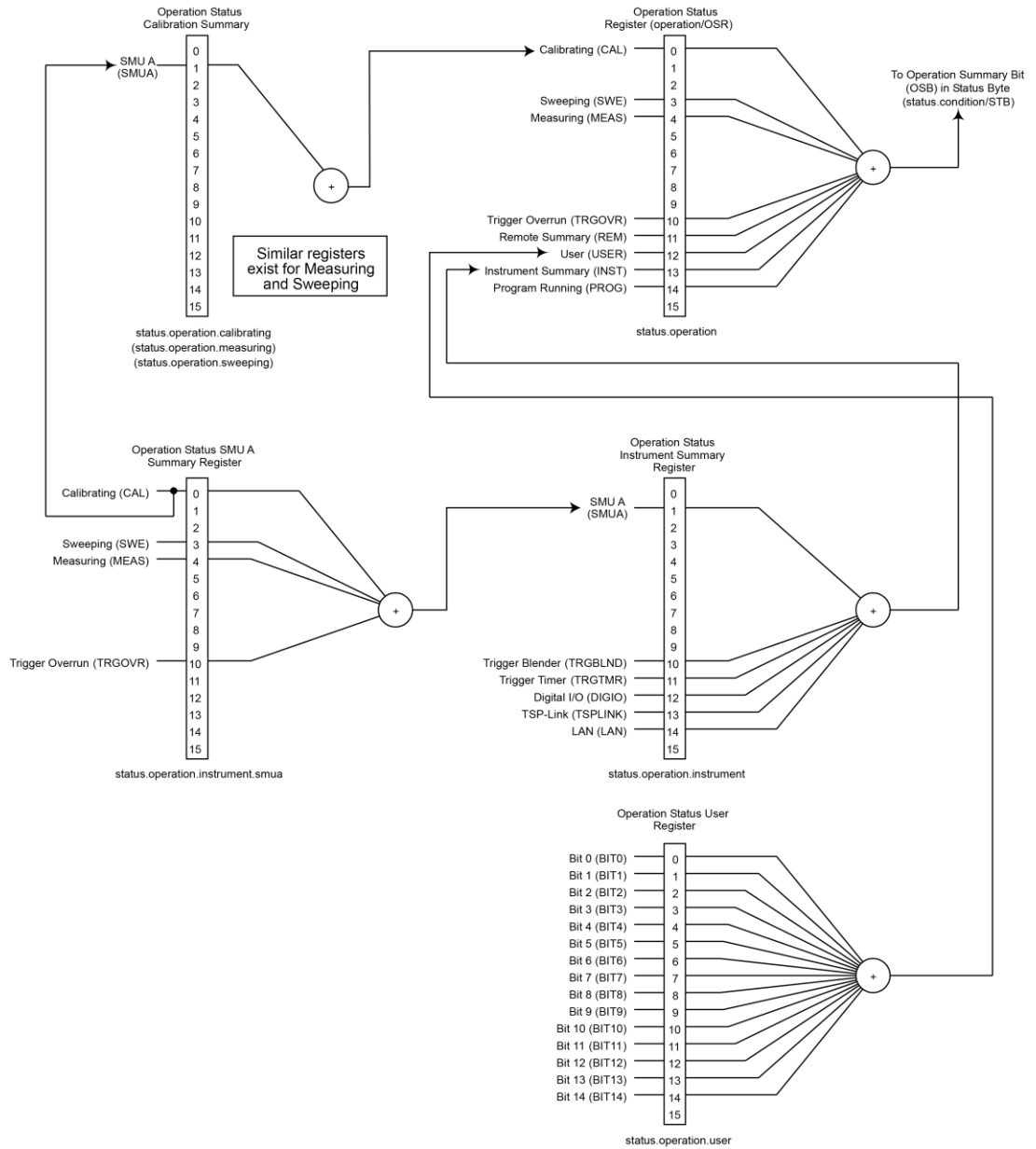
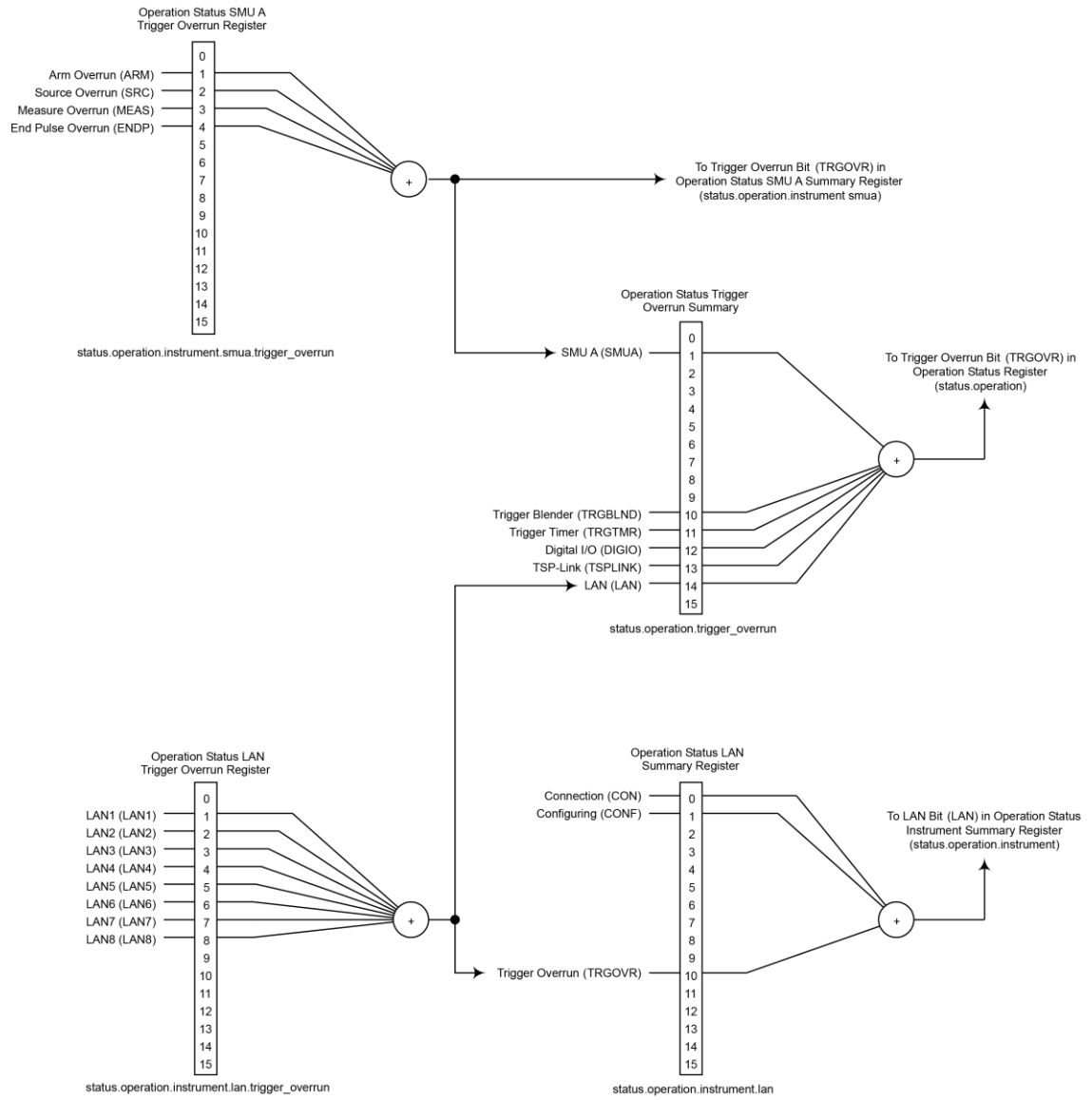



Figure 168: Operation Status Registers



**Figure 169: Operation status trigger overrun registers**



**Figure 170: Operation status trigger timer, trigger blender, and remote registers**

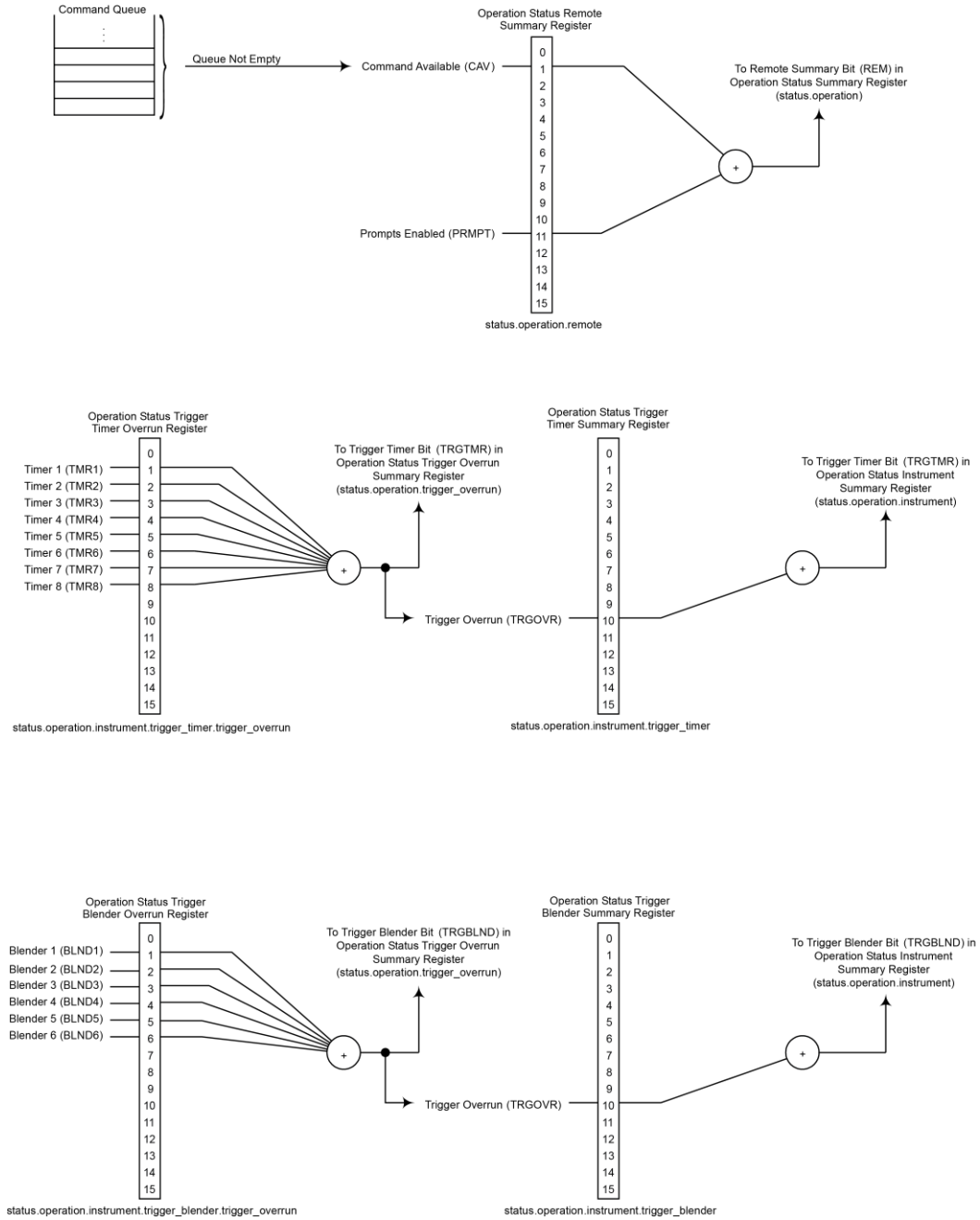

**Figure 171: Operation status digital I/O and TSP-Link registers**

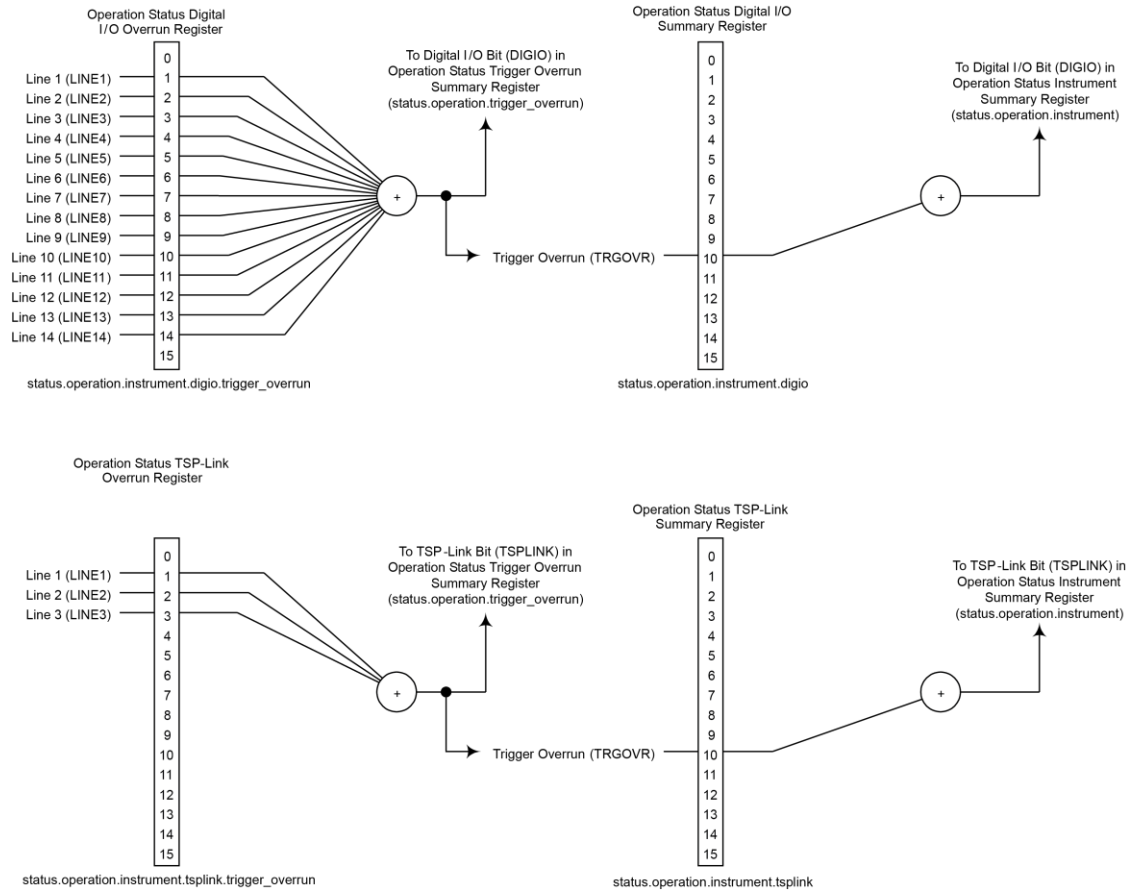
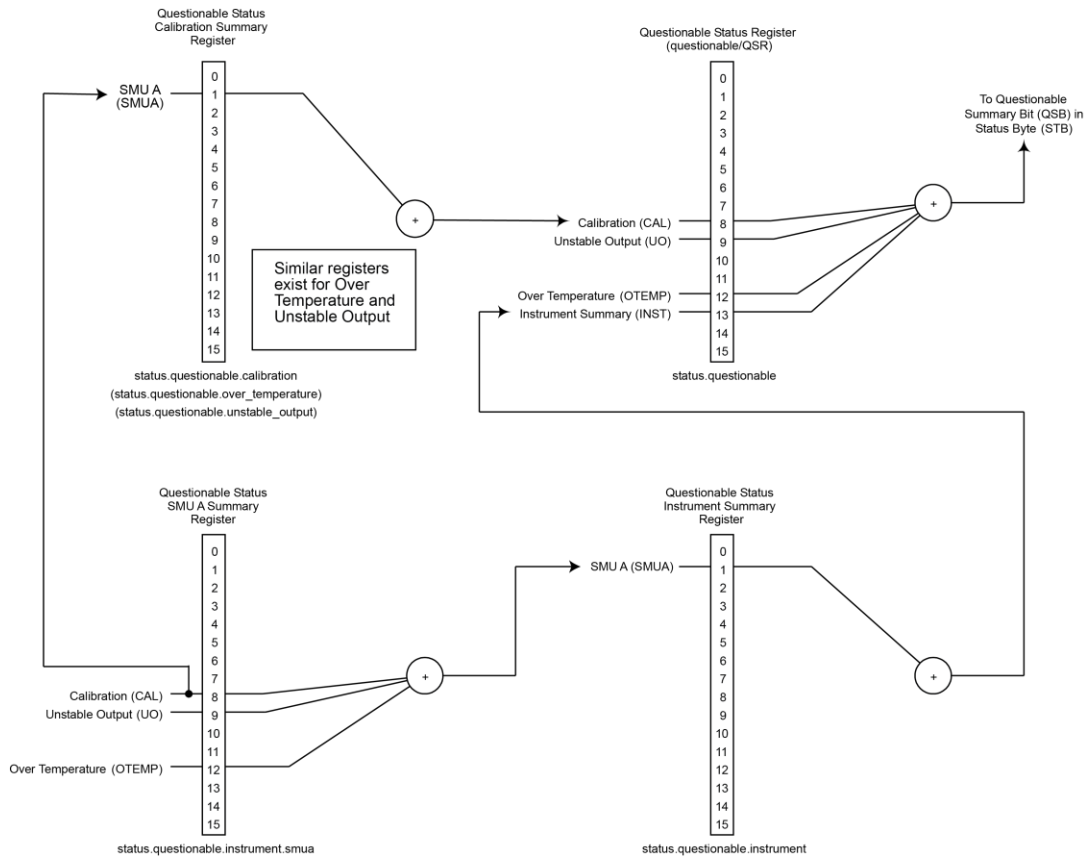

Figure 172: Questionable Status Registers



## Clearing registers

You can use commands to reset the status registers.

\*CLS resets the bits of the event and NTR registers to 0 and sets all PTR register bits on. This command also clears the output queue.

status.reset() resets bits of the event and NTR registers to 0 and sets all PTR register bits on. Refer to [status.reset\(\)](#) (on page 11-328) for additional information.

In addition to these commands, you can reset the enable registers and the NTR to 0. To do this, send the individual command to program the register with a 0 as its parameter value. The PTR registers can be reset to their defaults by programming them with all bits on. Note that the event registers are not programmable but can be cleared by reading them.

## Programming enable and transition registers

The only registers that you can program are the enable and transition registers. All other registers in the status structure are read-only registers. The following explains how to determine the parameter values for the various commands used to program enable registers. The actual commands are summarized in [Common commands](#) (on page 14-1) and [Status function summary](#) (on page 15-3).

A command to program an event enable or transition register is sent with a parameter value that determines the state (0 or 1) of each bit in the appropriate register. The bit positions of the register (see the following tables) indicate the binary parameter value and decimal equivalent. To program one of the registers, send the decimal value for the bits to be set. The registers are discussed further in [Enable and transition registers](#) (on page 15-19).

|                     |                   |                   |                   |                   |                   |                   |                   |                   |
|---------------------|-------------------|-------------------|-------------------|-------------------|-------------------|-------------------|-------------------|-------------------|
| <b>Bit</b>          | <b>B7</b>         | <b>B6</b>         | <b>B5</b>         | <b>B4</b>         | <b>B3</b>         | <b>B2</b>         | <b>B1</b>         | <b>B0</b>         |
| <b>Binary value</b> | 0/1               | 0/1               | 0/1               | 0/1               | 0/1               | 0/1               | 0/1               | 0/1               |
| <b>Decimal</b>      | 128               | 64                | 32                | 16                | 8                 | 4                 | 2                 | 1                 |
| <b>Weights</b>      | (2 <sup>7</sup> ) | (2 <sup>6</sup> ) | (2 <sup>5</sup> ) | (2 <sup>4</sup> ) | (2 <sup>3</sup> ) | (2 <sup>2</sup> ) | (2 <sup>1</sup> ) | (2 <sup>0</sup> ) |

|                     |                    |                    |                    |                    |                    |                    |                   |                   |
|---------------------|--------------------|--------------------|--------------------|--------------------|--------------------|--------------------|-------------------|-------------------|
| <b>Bit</b>          | <b>B15</b>         | <b>B14</b>         | <b>B13</b>         | <b>B12</b>         | <b>B11</b>         | <b>B10</b>         | <b>B9</b>         | <b>B8</b>         |
| <b>Binary value</b> | 0/1                | 0/1                | 0/1                | 0/1                | 0/1                | 0/1                | 0/1               | 0/1               |
| <b>Decimal</b>      | 32,768             | 16,384             | 8,192              | 4,096              | 2,048              | 1,024              | 512               | 256               |
| <b>Weights</b>      | (2 <sup>15</sup> ) | (2 <sup>14</sup> ) | (2 <sup>13</sup> ) | (2 <sup>12</sup> ) | (2 <sup>11</sup> ) | (2 <sup>10</sup> ) | (2 <sup>9</sup> ) | (2 <sup>8</sup> ) |

When using a numeric parameter, registers are programmed by including the appropriate *mask* value. For example:

```
*ese 1169
status.standard.enable = 1169
```

To convert from decimal to binary, use the information shown in the above figure. For example, to set bits B0, B4, B7, and B10, a decimal value of 1169 would be used for the mask parameter (1169 = 1 + 16 + 128 + 1024).

## Reading registers

Any register in the status structure can be read either by sending the common command query (where applicable), or by including the script command for that register in either the `print()` or `print(tostring())` command. The `print()` command outputs a numeric value; the `print(tostring())` command outputs the string equivalent. For example, any of the following commands requests the Service Request Enable Register value:

```
*SRE?
print(tostring(status.request_enable))
print(status.request_enable)
```

The response message will be a decimal value that indicates which bits in the register are set. That value can be converted to its binary equivalent using the information in [Programming enable and transition registers](#) (on page 15-14). For example, for a decimal value of 37 (binary value of 100101), bits B5, B2, and B0 are set.

## Status byte and service request (SRQ)

Service requests (SRQs) allow an instrument to indicate that it needs attention or that some event has occurred. When the controller receives an SRQ, it allows the controller to interrupt tasks to perform other tasks in order to address the request for service.

For example, you might program your instrument to send an SRQ when:

- All instrument operations are complete
- An instrument error occurs
- A specific operation has occurred

Two 8-bit registers control service requests: The Status Byte Register and the Service Request Enable Register. The [Status Byte Register](#) (on page 15-16) topic describes the structure of these registers.

Service requests affect GPIB, USB, and VXI-11 connections. On a GPIB connection, the SRQ line is asserted. On a VXI-11 or USB connection, an SRQ event is generated.

## Status Byte Register

The summary messages from the status registers and queues are used to set or clear the appropriate bits (B0, B1, B2, B3, B4, B5, and B7) of the Status Byte Register. These summary bits do not latch, and their states (0 or 1) are dependent upon the summary messages (0 or 1). For example, if the Standard Event Register is read, its register is cleared. As a result, its summary message resets to 0, which then resets the ESB bit in the Status Byte Register.

The Status Byte Register also receives summary bits from itself, which sets the Master Summary Status, or MSS, bit.

**Figure 173: Status byte and service request (SRQ)**

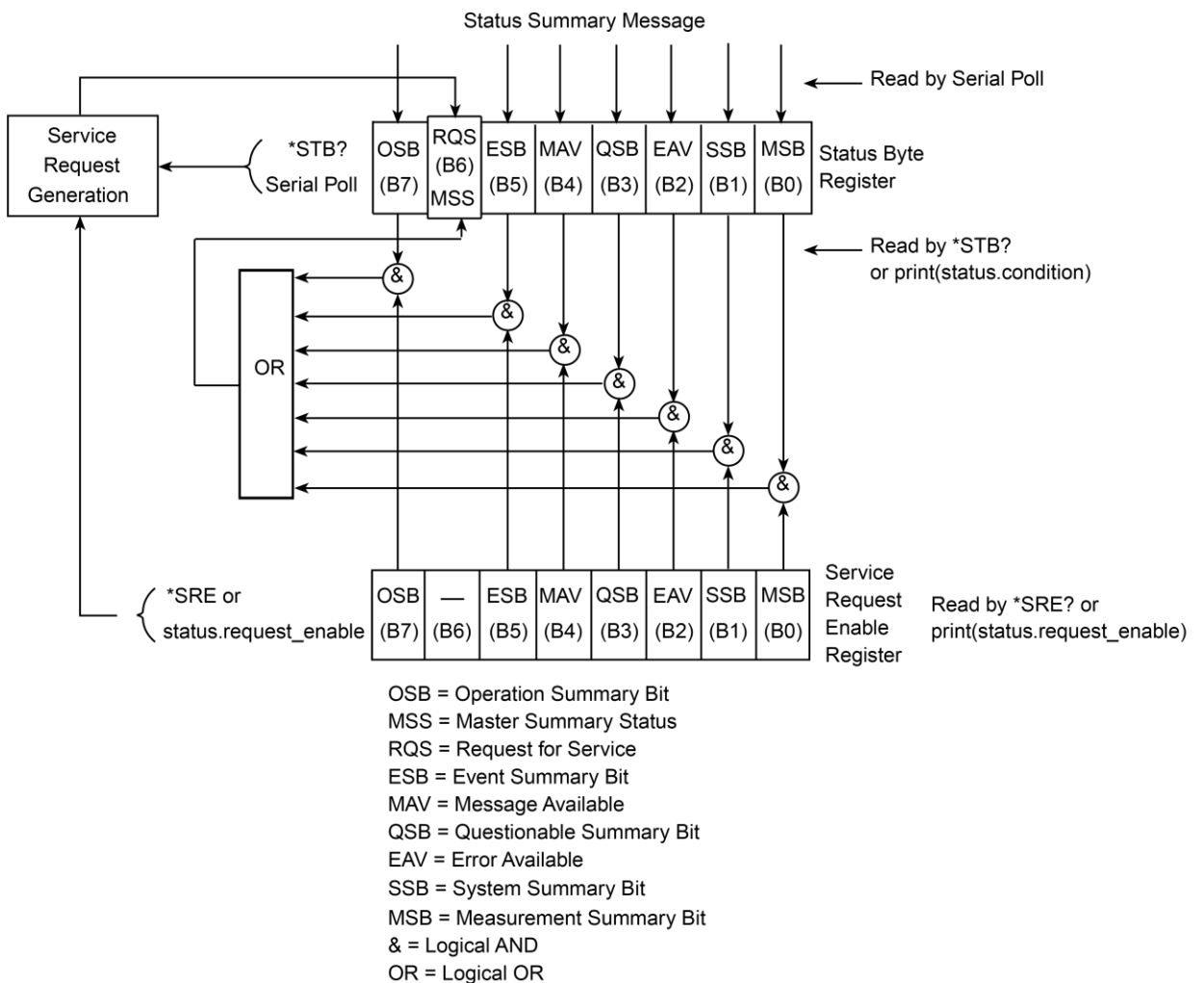



The bits of the Status Byte Register are described as follows:

- **Bit B0, Measurement Summary Bit (MSB):** Set summary bit indicates that an enabled measurement event has occurred.
- **Bit B1, System Summary Bit (SSB):** Set summary bit indicates that an enabled system event has occurred.
- **Bit B2, Error Available (EAV):** Set bit indicates that an error or status message is present in the error queue.
- **Bit B3, Questionable Summary Bit (QSB):** Set summary bit indicates that an enabled questionable event has occurred.
- **Bit B4, Message Available (MAV):** Set bit indicates that a response message is present in the output queue.
- **Bit B5, Event Summary Bit (ESB):** Set summary bit indicates that an enabled standard event has occurred.
- **Bit B6, Request Service (RQS)/Master Summary Status (MSS):** Set bit indicates that an enabled summary bit of the Status Byte Register is set. Depending on how it is used, bit B6 of the Status Byte Register is either the Request for Service (RQS) bit or the Master Summary Status (MSS) bit:
  - When using the GPIB, USB, or VXI-11 serial poll sequence of the 2601B-PULSE to obtain the status byte (serial poll byte), B6 is the RQS bit. See [Serial polling and SRQ](#) (on page 15-18) for details on using the serial poll sequence.
  - When using the \*STB? common command or status.condition [Status byte and service request commands](#) (on page 15-19) to read the status byte, B6 is the MSS bit.
- **Bit B7, Operation Summary (OSB):** Set summary bit indicates that an enabled operation event has occurred.

## Service Request Enable Register

The Service Request Enable Register controls the generation of a service request. This register is programmed by the user and is used to enable or disable the setting of bit B6 (RQS/MSS) by the Status Summary Message bits (B0, B1, B2, B3, B4, B5, and B7) of the Status Byte Register. As shown in the [Status Byte Register](#) (on page 15-16) topic, a logical AND operation is performed on the summary bits (&) with the corresponding enable bits of the Service Request Enable Register. When a logical AND operation is performed with a set summary bit (1) and with an enabled bit (1) of the enable register, the logic “1” output is applied to the input of the logical OR gate and, therefore, sets the MSS/RQS bit in the Status Byte Register.

The individual bits of the Service Request Enable Register can be set or cleared by using the `*SRE` common command or `status.request_enable`. To read the Service Request Enable Register, use the `*SRE?` query or `print(status.request_enable)`. The Service Request Enable Register clears when power is cycled or a parameter value of 0 is sent with a status request enable command (for example, a `*SRE 0` or `status.request_enable = 0` is sent). The commands to program and read the SRQ Enable Register are listed in [Status byte and service request commands](#) (on page 15-19).

## Serial polling and SRQ

Any enabled event summary bit that goes from 0 to 1 sets bit B6 and generates a service request (SRQ).

In your test program, you can periodically read the Status Byte to check if an SRQ occurred and what caused it. If an SRQ occurred, the program can, for example, branch to an appropriate subroutine that will service the request.

SRQs can be managed by the serial poll sequence of the instrument. If an SRQ does not occur, bit B6 (RQS) of the Status Byte Register remains cleared, and the program proceeds normally after the serial poll is performed. If an SRQ does occur, bit B6 of the Status Byte Register is set, and the program can branch to a service subroutine when the SRQ is detected by the serial poll.

The serial poll automatically resets RQS of the Status Byte Register. This allows subsequent serial polls to monitor bit B6 for an SRQ occurrence that is generated by other event types.

The serial poll does not clear the low-level registers that caused the SRQ to occur. You must clear the low-level registers explicitly. Refer to [Clearing registers](#) (on page 15-13).

For common commands and TSP commands, B6 is the MSS (Message Summary Status) bit. The serial poll does not clear the MSS bit. The MSS bit remains set until all enabled Status Byte Register summary bits are reset.

## SPE, SPD (serial polling)

For the GPIB interface only, the SPE and SPD general bus commands are used to serial poll the System SourceMeter® Instrument. Serial polling obtains the serial poll byte (status byte). Typically, serial polling is used by the controller to determine which of several instruments has requested service with the SRQ line.

## Status byte and service request commands

The commands to program and read the Status Byte Register and Service Request Enable Register are listed in the table below. Note that the table includes both common commands and their script command equivalents. For details on programming and reading registers, see [Programming enable and transition registers](#) (on page 15-14) and [Reading registers](#) (on page 15-15).

To reset the bits of the Service Request Enable Register to 0, use 0 as the parameter value for the command (for example, `*SRE 0` or `status.request_enable = 0`).

### Status Byte and Service Request Enable Register commands

| Command                                                                   | Description                                                               |
|---------------------------------------------------------------------------|---------------------------------------------------------------------------|
| <code>*STB?</code><br>or<br><code>print(status.condition)</code>          | Read the Status Byte Register.                                            |
| <code>*SRE mask</code><br>or<br><code>status.request_enable = mask</code> | Program the Service Request Enable Register where <i>mask</i> = 0 to 255. |
| <code>*SRE?</code><br>or<br><code>print(status.request_enable)</code>     | Read the Service Request Enable Register.                                 |

## Enable and transition registers

In general, there are three types of user-writable registers that are used to configure which bits feed the register summary bit and when it occurs. The registers are identified in each applicable command (as listed in [TSP commands](#) (on page 11-8)) as follows:

- **Enable register** (identified as `.enable` in the command listing of each attribute): Allows various associated events to be included in the summary bit for the register.
- **Negative-transition register** (identified as `.ntr` in the command listing of each attribute): A particular bit in the event register will be set when the corresponding bit in the NTR is set, and the corresponding bit in the condition register transitions from 1 to 0.
- **Positive-transition register** (identified as `.ptr` in the command listing of each attribute): A particular bit in the event register will be set when the corresponding bit in the PTR is set, and the corresponding bit in the condition register transitions from 0 to 1.

## Controlling node and SRQ enable registers

Attributes to control system node and service request (SRQ) enable bits and read associated registers are summarized in the [Status byte and service request enable registers](#) (on page 15-5). For example, either of the following commands set the system node QSB enable bit:

```
status.node_enable = status.QSB
status.node_enable = 8
```

## Status register sets

There are five status register sets in the status structure of a System SourceMeter® Instrument:

- System Summary
- Standard Event Status
- Operation Status
- Questionable Status
- Measurement Event

## System Summary Registers

As shown in [Status model diagrams](#) (on page 15-5), there are five register sets associated with system status events. These registers summarize the system status for various nodes connected to the TSP-Link® network (see [TSP-Link system expansion interface](#) (on page 10-45)). Note that all nodes on the TSP-Link network share a copy of the system summary registers once the TSP-Link system has been initialized. This feature allows all nodes to access the status models of other nodes, including service request (SRQ).

In a TSP-Link system, you can configure the status model so that a status event in any node in the system can set the RQS (request for service) bit of the Master Node Status Byte. See [TSP-Link system status](#) (on page 15-25) for details on using the status model in a TSP-Link system.

Commands for the system summary registers are summarized in the [Status function summary](#) (on page 15-3) table.

For example, either of the following commands will set the EXT enable bit:

```
status.system.enable = status.system.EXT
status.system.enable = 1
```

When reading a register, a numeric value is returned. The binary equivalent of this value indicates which bits in the register are set. For details, see [Reading registers](#) (on page 15-15). For example, the following command will read the System Enable Register:

```
print(status.system.enable)
```

The used bits of the system event registers are described as follows:

- **Bit B0, Extension Bit (EXT):** Set bit indicates that an extension bit from another system status register is set.
- **Bits B1 to B14 NODE<sub>*n*</sub>:** Indicates a bit on TSP-Link node *n* has been set (*n* = 1 to 64) (note that `status.system5` does not use bits B9 through B15).

## Standard Event Register

The bits used in the Standard Event Register are described as follows:

- **Bit B0, Operation Complete (OPC):** Set bit indicates that all pending selected device operations are completed and the 2601B-PULSE instrument is ready to accept new commands. The bit is set in response to an \*OPC command. The `opc()` function can be used in place of the \*OPC command. See [Common commands](#) (on page 14-1) for details on the \*OPC command.
- **Bit B1:** Not used.
- **Bit B2, Query Error (QYE):** Set bit indicates that you attempted to read data from an empty output queue.
- **Bit B3, Device-Dependent Error (DDE):** Set bit indicates that an instrument operation did not execute properly due to some internal condition.
- **Bit B4, Execution Error (EXE):** Set bit indicates that the 2601B-PULSE instrument detected an error while trying to execute a command.
- **Bit B5, Command Error (CME):** Set bit indicates that a command error has occurred. Command errors include:
  - IEEE Std 488.2 syntax error: The 2601B-PULSE instrument received a message that does not follow the defined syntax of IEEE Std 488.2.
  - Semantic error: 2601B-PULSE instrument received a command that was misspelled or received an optional IEEE Std 488.2 command that is not implemented.
  - The instrument received a Group Execute Trigger (GET) inside a program message.
- **Bit B6, User Request (URQ):** Set bit indicates that the LOCAL key on the 2601B-PULSE instrument front panel was pressed.
- **Bit B7, Power ON (PON):** Set bit indicates that the 2601B-PULSE instrument has been turned off and turned back on since the last time this register was read.

Commands to program and read the register are summarized below and also in the [Status function summary](#) (on page 15-3) table.

**Figure 174: Standard Event Register**

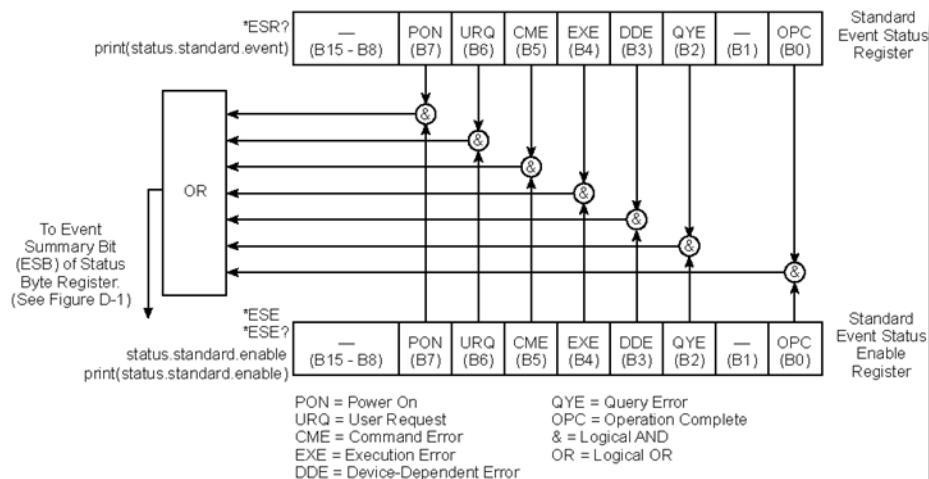

**Standard event commands**

| Command                                                              | Description                                                                                                                             |
|----------------------------------------------------------------------|-----------------------------------------------------------------------------------------------------------------------------------------|
| *ESR?<br>or<br><code>print(status.standard.event)</code>             | Read Standard Event Status Register.                                                                                                    |
| *ESE <i>mask</i><br>or<br><code>status.standard.enable = mask</code> | Program the Event Status Enable Register:<br><i>mask</i> = 0 to 255<br>See <a href="#">Status register set contents</a> (on page 15-1). |
| *ESE?<br>or<br><code>print(status.standard.enable)</code>            | Read Event Status Enable Register.                                                                                                      |

## Operation Status Registers

As shown in the [Operation status registers](#) (on page 15-8) diagram of the status model, there are 22 register sets associated with operation status. Commands are summarized in the [Status register set contents](#) (on page 15-1) topic. Note that bits can also be set by using numeric parameter values. For details, see [Programming enable and transition registers](#) (on page 15-14).

For example, either of the following commands will set the CAL enable bit (B0):

```
status.operation.enable = status.operation.CAL
status.operation.enable = 1
```

When reading a register, a numeric value is returned. The binary equivalent of this value indicates which bits in the register are set. For details, see [Reading registers](#) (on page 15-15). For example, the following command will read the Operation Status Enable Register:

```
print(status.operation.enable)
```

Commands to program and read the register are summarized in the [Status function summary](#) (on page 15-3) table.

This register set feeds to bit B7 (OSB) of the Status Byte. The bits used in the Operation Status Register set are described as follows:

- **Bit B0, Calibrating (CAL):** Set bit indicates that a channel is calibrating.
- **Bit B3, Sweeping (SWE):** Set bit indicates that a channel is sweeping.
- **Bit B4, Measuring (MEAS):** Bit is set when making an overlapped measurement, but it is not set when making a normal synchronous measurement.
- **Bit B10, Trigger Overrun (TRGOVR):** Set bit indicates that an enabled bit in the Operation Status Trigger Overrun Summary Register is set.
- **Bit B11, Remote Summary (REM):** Set bit indicates that an enabled bit in the Operation Status Remote Summary Register is set.
- **Bit B12, User (USER):** Set bit indicates that an enabled bit in the Operation Status User Register is set.

- **Bit B13, Instrument Summary (INST):** Set bit indicates that an enabled bit in the Operation Status Instrument Summary Register is set.
- **Bit B14, Program Running (PROG):** Set bit indicates that a program is running.

For more information on the Operation Status Registers, refer to [Status register set contents](#) (on page 15-1) and the figures in this section.

## Questionable Status Registers

This register set feeds to bit B3 (QSB) of the Status Byte. The bits used in the Questionable Status Register set are described as follows:

- **Bit B8, Calibration (CAL):** Set bit indicates that calibration is questionable.
- **Bit B9, Unstable Output (UO):** Set bit indicates that an unstable output condition was detected.
- **Bit B12, Over Temperature (OTEMP):** Set bit indicates that an over temperature condition was detected.
- **Bit B13, Instrument Summary (INST):** Set bit indicates that a bit in the Questionable Status Instrument Summary Register is set.

For more information on the Questionable Status Register, refer to [Status register set contents](#) (on page 15-1) and the figures in this appendix.

## Questionable Status Registers

As shown in the [Operation event, I/O, and TSP-Link registers](#) (on page 15-11) of the status model, there are seven register sets associated with Questionable Status. Commands are summarized in the [Status byte and service request \(SRQ\)](#) (on page 15-15) topic. Note that bits can also be set by using numeric parameter values. For details, see [Programming enable and transition registers](#) (on page 15-14).

For example, either of the following commands will set the CAL enable bit (B8):

```
status.questionable.enable = status.questionable.CAL
status.questionable.enable = 256
```

When reading a register, a numeric value is returned. The binary equivalent of this value indicates which bits in the register are set. For details, see [Reading registers](#) (on page 15-15). For example, the following command will read the Questionable Status Enable Register:

```
print(status.questionable.enable)
```

For more information about the Questionable Status Registers, refer to [Status register set contents](#) (on page 15-1) and the figures in this section.

## Measurement Event Registers

As shown in the [Measurement event registers](#) (on page 15-7) of the status model, there are eight register sets associated with measurement event status. Commands are summarized in the [Status register set contents](#) (on page 15-1) topic. Note that bits can also be set by using numeric parameter values. For details, see [Programming enable and transition registers](#) (on page 15-14).

For example, either of the following commands sets the VOLTAGE\_LIMIT enable bit:

```
status.measurement.enable = status.measurement.VOLTAGE_LIMIT
status.measurement.enable = 1
```

When reading a register, a numeric value is returned. The binary equivalent of this value indicates which bits in the register are set. For details, see [Reading registers](#) (on page 15-15). For example, the following command reads the Measurement Event Enable Register:

```
print(status.measurement.enable)
```

This register set feeds to bit B0 (MSB) of the Status Byte. The bits used in the Measurement Event Registers are:

- **Bit B0, Voltage Limit (VLMT):** Set bit indicates that the voltage limit was exceeded. This bit is updated only when either a measurement is made or the `smua.source.compliance` attribute is read.
- **Bit B1, Current Limit (ILMT):** Set bit indicates that the current limit was exceeded. This bit is updated only when either a measurement is made or the `smua.source.compliance` attribute is read.
- **Bit B3, Protection (PROT):** Set bit indicates that one of the pulser protect circuits has been tripped.
- **Bit B7, Reading Overflow (ROF):** Set bit indicates that an overflow reading has been detected.
- **Bit B8, Buffer Available (BAV):** Set bit indicates that there is at least one reading stored in either or both nonvolatile reading buffers.
- **Bit B11, Interlock (INT):** Set bit indicates that interlock was asserted.
- **Bit B13, Instrument Summary (INST):** Set bit indicates that a bit in the Measurement Instrument Summary Register is set.

Commands to program and read the register are summarized in the [Status function summary](#) (on page 15-3) table. For more information about the Measurement Event Registers, refer to [Status register set contents](#) (on page 15-1) and the figures in this appendix.



## Register programming example

The command sequence below programs the instrument to generate a service request (SRQ) and set the system summary bit in all TSP-Link nodes when the current limit on channel A is exceeded.

```
-- Clear all registers.
status.reset()

-- Enable current limit bit in current limit register.
status.measurement.current_limit.enable = status.measurement.current_limit.SMUA

-- Enable status measure current limit bit.
status.measurement.enable = status.measurement.ILMT

-- Set system summary; enable MSB.
status.node_enable = status.MSB

-- Enable status SRQ MSB.
status.request_enable = status.MSB
```

## TSP-Link system status

The TSP-Link® expansion interface allows instruments to communicate with each other. The test system can be expanded to include up to 32 TSP-enabled instruments. In a TSP-Link system, one node (instrument) is the master and the other nodes are the subordinates. The master can control the other nodes (subordinates) in the system. See [TSP-Link system expansion interface](#) (on page 10-45) for details about the TSP-Link system.

The system summary registers, shown in the [Status byte and service request enable register](#) (on page 15-5) and the [System summary and standard event registers](#) (on page 15-6), are shared by all nodes in the TSP-Link system. A status event that occurs at a subordinate node can generate an SRQ (service request) in the master node. After detecting the service request, your program can then branch to an appropriate subroutine that will service the request. See [Status byte and service request \(SRQ\)](#) (on page 15-15) for details.

## Status model configuration example

In this example, a current limit (compliance) event in node 15 will set the RQS bit of the Status Byte of the master node. The commands to configure the status model for this example are provided in [Status configuration \(enable\) commands](#) (on page 15-26).

When a current limit (compliance) condition occurs in node 15, the following sequence of events occurs:

- Node 15: Bit B1 or B2 of the Measurement Event Current Limit Summary Register sets when the current limit (compliance) event occurs.
- Node 15: Bit B1 (ILMT) of the Measurement Event Register sets.
- Node 15: Bit B0 (MSB) of the Status Byte sets.
- System Summary Registers: Bit B1 (node 15) of the System Summary Register 2 sets.

---

## NOTE

The System Summary Registers are shared by all nodes in the TSP-Link system. When a bit in a system register of node 15 sets, the same bit in the master node system register also sets.

---

- System Summary Registers: Bit B0 (Extension) of the System Summary Register sets.
- Master Node: Bit B0 (MSB) of the Status Byte sets.
- Master Node: With service request enabled, bit B6 (RQS) of the Status Byte sets. When your program performs the next serial poll of the master node, it will detect the current limit event and can branch to a routine to service the request.

The figure in [Status configuration \(enable\) commands](#) (on page 15-26) demonstrates the flow of information through the status model of node 15 and the master node.

## Status configuration (enable) commands

For the following registers, the commands listed, which are sent from the master node, enable the appropriate register bits for the status model configuration example.

Node 15 status registers: The following commands enable the current limit events for node 15:

```
node[15].status.measurement.current_limit.enable = 6
node[15].status.measurement.enable = 2
node[15].status.node_enable = 1
```

The affected status registers for the above commands are indicated by labels A, B and C (see following figure).

Master node system summary registers: The following commands enable the required system summary bits for node 15:

```
status.system2.enable = 2
status.system.enable = 1
```

The affected system summary registers for the above commands are indicated by labels D and E (see following figure).

Master node service request: The following command enables the service request for the measurement event:

```
status.request_enable = 1
```

The affected status register for the above command is indicated by label E (see the following figure).

**Figure 175: TSP-Link status model configuration example**

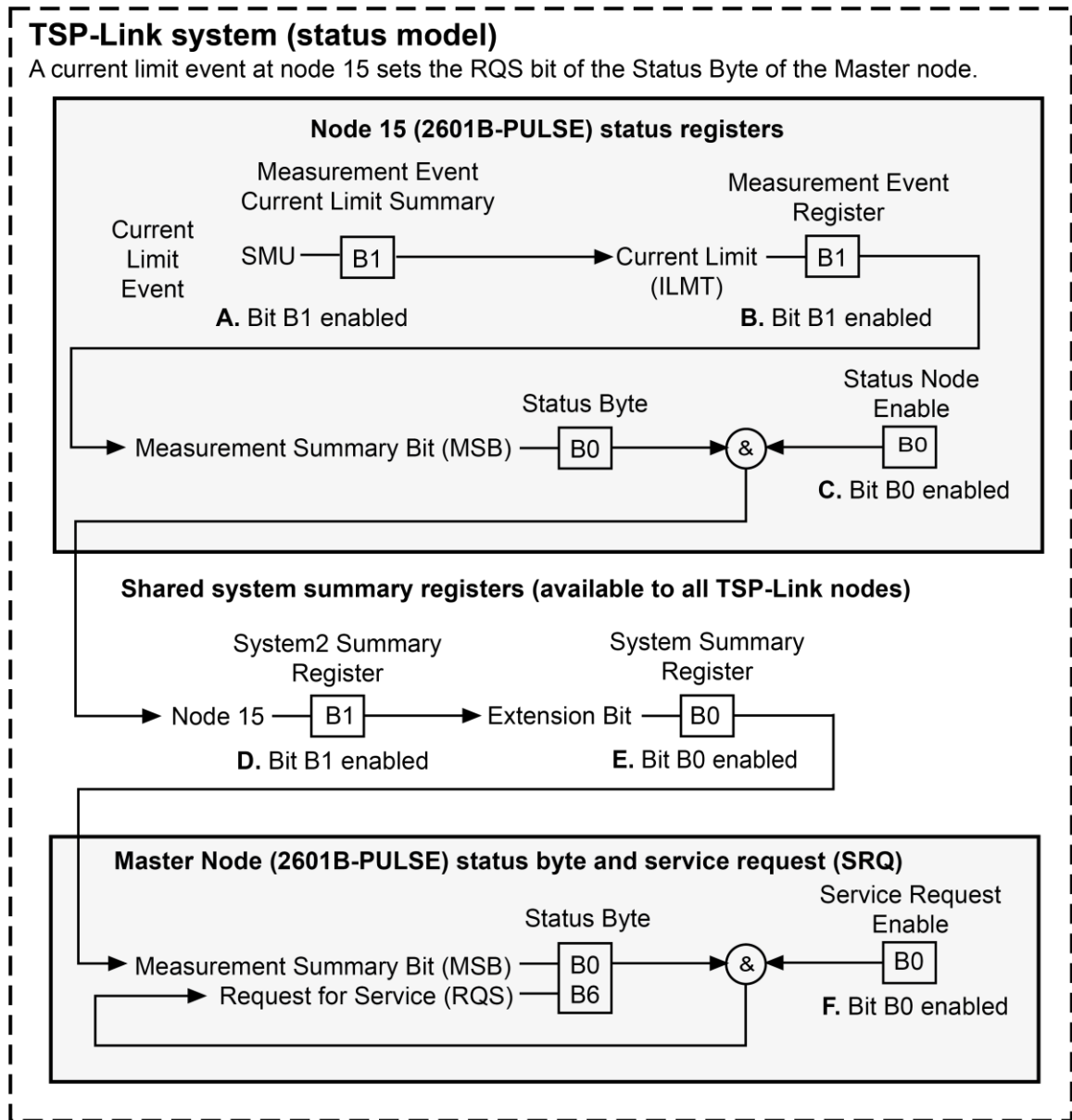

## Display character codes









### In this section:

[2601B-PULSE display character codes ..... 16-1](#)

## 2601B-PULSE display character codes

The following tables contain the display character codes (decimal values) and their corresponding display.













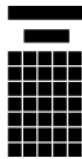

















**Display character codes (decimal 0 to 39)**

| Decimal | Display  | Decimal | Display                                                                             | Decimal | Display                                                                               |
|---------|----------|---------|-------------------------------------------------------------------------------------|---------|---------------------------------------------------------------------------------------|
| 000     | reserved | 012     | reserved                                                                            | 026     | ▲                                                                                     |
| 001     | reserved | 013     | reserved                                                                            | 027     | ▼                                                                                     |
| 002     | reserved | 014     | reserved                                                                            | 028     | ◀                                                                                     |
| 003     | reserved | 015     | reserved                                                                            | 029     | ▶                                                                                     |
| 004     | reserved | 016     | μ                                                                                   | 030     |  |
| 005     | reserved | 017     | ±                                                                                   | 031     |  |
| 006     | reserved | 018     | Ω                                                                                   | 032     | (space)                                                                               |
| 007     | reserved | 019     | °                                                                                   | 033     | !                                                                                     |
| 008     | reserved | 020     |  | 034     | "                                                                                     |
| 009     | reserved | 021     |  | 035     | #                                                                                     |
| 010     | reserved | 022     |  | 036     | \$                                                                                    |
| 011     | reserved | 023     |  | 037     | %                                                                                     |
| 012     | reserved | 024     |  | 038     | &                                                                                     |
| 013     | reserved | 025     |  | 039     | ' (apostrophe)                                                                        |

**Display character codes (decimal 40 to 102)**

| Decimal | Display   | Decimal | Display | Decimal | Display               |
|---------|-----------|---------|---------|---------|-----------------------|
| 040     | (         | 061     | =       | 082     | R                     |
| 041     | )         | 062     | >       | 083     | S                     |
| 042     | *         | 063     | ?       | 084     | T                     |
| 043     | +         | 064     | @       | 085     | U                     |
| 044     | , (comma) | 065     | A       | 086     | V                     |
| 045     | -         | 066     | B       | 087     | W                     |
| 046     | .         | 067     | C       | 088     | X                     |
| 047     | /         | 068     | D       | 089     | Y                     |
| 048     | 0         | 069     | E       | 090     | Z                     |
| 049     | 1         | 070     | F       | 091     | [                     |
| 050     | 2         | 071     | G       | 092     | \                     |
| 051     | 3         | 072     | H       | 093     | ]                     |
| 052     | 4         | 073     | I       | 094     | ^                     |
| 053     | 5         | 074     | J       | 095     | _                     |
| 054     | 6         | 075     | K       | 096     | ' (open single quote) |
| 055     | 7         | 076     | L       | 097     | a                     |
| 056     | 8         | 077     | M       | 098     | b                     |
| 057     | 9         | 078     | N       | 099     | c                     |
| 058     | :         | 079     | O       | 100     | d                     |
| 059     | ;         | 080     | P       | 101     | e                     |
| 060     | <         | 081     | Q       | 102     | f                     |











**Display character codes (decimal 103 to 165)**

| Decimal | Display | Decimal | Display                                                                             | Decimal | Display                                                                               |
|---------|---------|---------|-------------------------------------------------------------------------------------|---------|---------------------------------------------------------------------------------------|
| 103     | g       | 124     |                                                                                     | 145     |    |
| 104     | h       | 125     | }                                                                                   | 146     |    |
| 105     | i       | 126     | ~                                                                                   | 147     |    |
| 106     | j       | 127     |    | 148     |    |
| 107     | k       | 128     | (space)                                                                             | 149     |    |
| 108     | l       | 129     |    | 150     |    |
| 109     | m       | 130     |    | 151     |    |
| 110     | n       | 131     |    | 152     |    |
| 111     | o       | 132     |  | 153     |  |
| 112     | p       | 133     |  | 154     |  |
| 113     | q       | 134     |  | 155     |  |
| 114     | r       | 135     |  | 156     |  |
| 115     | s       | 136     |  | 157     |  |
| 116     | t       | 137     |  | 158     |  |
| 117     | u       | 138     |  | 159     | ¼                                                                                     |
| 118     | v       | 139     |  | 160     | 0                                                                                     |
| 119     | w       | 140     |  | 161     | 1                                                                                     |
| 120     | x       | 141     |  | 162     | 2                                                                                     |
| 121     | y       | 142     |  | 163     | 3                                                                                     |
| 122     | z       | 143     |  | 164     | 4                                                                                     |
| 123     | {       | 144     |  | 165     | 5                                                                                     |

**Display character codes (decimal 166 to 228)**

| Decimal | Display      | Decimal | Display        | Decimal | Display |
|---------|--------------|---------|----------------|---------|---------|
| 166     | <sup>6</sup> | 187     | Φ              | 208     | æ       |
| 167     | <sup>7</sup> | 188     | ∩              | 209     | Æ       |
| 168     | <sup>8</sup> | 189     | ∪              | 210     | â       |
| 169     | <sup>9</sup> | 190     | ÷              | 211     | ä       |
| 170     | α            | 191     | ≤              | 212     | á       |
| 171     | β            | 192     | ≥              | 213     | à       |
| 172     | γ            | 193     | ≠              | 214     | â       |
| 173     | δ            | 194     | ≡              | 215     | ä       |
| 174     | ε            | 195     | ≈              | 216     | Ä       |
| 175     | η            | 196     | ∞              | 217     | Å       |
| 176     | θ            | 197     | >>             | 218     | ê       |
| 177     | λ            | 198     | <<             | 219     | è       |
| 178     | π            | 199     | ¿              | 220     | é       |
| 179     | ρ            | 200     | ¡              | 221     | è       |
| 180     | σ            | 201     | ¢              | 222     | É       |
| 181     | τ            | 202     | £              | 223     | î       |
| 182     | φ            | 203     | ¥              | 224     | ï       |
| 183     | ω            | 204     | P <sub>†</sub> | 225     | í       |
| 184     | Γ            | 205     | f              | 226     | ì       |
| 185     | Δ            | 206     | Ç              | 227     | ô       |
| 186     | Σ            | 207     | ç              | 228     | ö       |

**Display character codes (decimal 229 to 255)**

| Decimal | Display | Decimal | Display                                                                            | Decimal | Display                                                                             |
|---------|---------|---------|------------------------------------------------------------------------------------|---------|-------------------------------------------------------------------------------------|
| 229     | ó       | 238     | ñ                                                                                  | 247     |  |
| 230     | ò       | 239     | Ñ                                                                                  | 248     |  |
| 231     | ô       | 240     | ÿ                                                                                  | 249     |  |
| 232     | Ö       | 241     |   | 250     |  |
| 233     | û       | 242     |   | 251     | †                                                                                   |
| 234     | ü       | 243     |   | 252     | ↑                                                                                   |
| 235     | ú       | 244     |   | 253     | ↓                                                                                   |
| 236     | ù       | 245     |   | 254     | ←                                                                                   |
| 237     | Û       | 246     |  | 255     | →                                                                                   |



---

## Frequently asked questions

### In this section:

|                                                         |      |
|---------------------------------------------------------|------|
| How do I display the instrument's serial number? .....  | 17-1 |
| How do I optimize performance?.....                     | 17-2 |
| How do I upgrade the firmware? .....                    | 17-2 |
| How do I use the digital I/O port? .....                | 17-3 |
| How do I trigger other instruments? .....               | 17-3 |
| How do I generate a GPIB service request? .....         | 17-4 |
| How do I store measurements in nonvolatile memory?..... | 17-5 |
| When should I change the output-off state?.....         | 17-6 |
| How do I make contact check measurements?.....          | 17-6 |
| How can I change the line frequency or voltage?.....    | 17-7 |
| Where can I get the LabVIEW driver? .....               | 17-7 |
| What should I do if I get an 802 interlock error?.....  | 17-7 |
| Why is the reading value 9.91e37? .....                 | 17-7 |

## How do I display the instrument's serial number?

The instrument serial number is on a label on the rear panel of the instrument. You can also access the serial number from the front panel using the front-panel keys and menus.

### *To display the serial number on the front panel:*

1. If the 2601B-PULSE is in remote operation, press the **EXIT (LOCAL)** key once to place the instrument in local operation.
2. Press the **MENU** key.
3. Use the navigation wheel  to scroll to the **SYSTEM-INFO** menu item.
4. Press the **ENTER** key. The SYSTEM INFORMATION menu is displayed.
5. Scroll to the **SERIAL#** menu item.
6. Press the **ENTER** key. The 2601B-PULSE serial number is displayed.

## How do I optimize performance?

The primary factors that affect measurement accuracy and speed are:

- **Warm-up:** For rated measurement accuracy, allow the 2601B-PULSE to warm up for at least two hours before use.
- **Speed setting:** The speed setting affects both speed and accuracy. For more information, see [Setting speed](#) (on page 4-60).
- **Autozero:** Autozero can be disabled to increase speed at the expense of accuracy (for more information, see [Disabling autozero to increase speed](#) (on page 17-2)).

### Disabling autozero to increase speed

Disabling autozero (setting it to OFF) can increase measurement speed. If autozero is disabled, accuracy will drift with time and temperature.

---

#### NOTE

Turning autozero OFF will disable the autozero function and possibly increase measurement speed. To minimize drift, setting autozero to ONCE will perform an autozero operation one time (at the time when it is selected), and then disable the autozero function. For a more detailed discussion of autozero, see [Autozero](#) (on page 4-41).

---



---

#### NOTE

When the pulser is enabled, autozero is automatically disabled.

---

#### *To configure autozero from the front panel:*

1. Press the **CONFIG** key, and then select **MEAS** from the menu.
2. Select **AUTO-ZERO**, and then press the **ENTER** key or the navigation wheel .
3. Select the mode (**OFF**, **ONCE**, or **AUTO**), and then press the **ENTER** key or the navigation wheel .
4. Press the **EXIT (LOCAL)** key to the normal display.

Refer to [Remote command autozero](#) (on page 4-42) for details about configuring autozero from a remote interface.

## How do I upgrade the firmware?

For information on upgrading the firmware, see [Upgrading the firmware](#) (on page 8-5).

## How do I use the digital I/O port?

You can use the 2601B-PULSE digital input/output with the trigger model or to control an external digital circuit, such as a device handler used to perform binning operations. To control or configure any of the six digital input/output lines, send commands to the 2601B-PULSE over a remote interface.

Use a cable equipped with a male DB-25 connector (Keithley Instruments part number CA-126-1A; L-com part number CSMN25MF-5) to connect the digital I/O port to other Keithley Instruments models equipped with a Trigger Link (TLINK).

For more information about the 2601B-PULSE digital I/O port, see [Digital I/O](#) (on page 6-36).

## How do I trigger other instruments?

You can use the 2601B-PULSE digital input/output to control an external digital circuit, such as a device handler used to perform binning operations. For more information about the 2601B-PULSE digital I/O port, see [Digital I/O](#) (on page 6-36).

Another option is the Keithley Instruments TSP-Link® interface, a high-speed trigger synchronization and communication bus that you can use to connect multiple instruments in a master and subordinate configuration. See [TSP-Link System Expansion Interface](#) (on page 10-45) for additional information.

### Triggering a scanner

A typical test scenario might call for using the 2601B-PULSE with a scanner to test a number of devices under test (DUTs) in sequence. A basic example of this uses the 2601B-PULSE digital I/O port to trigger a scanner (shown in the figure below). In this example, line 1 of the digital I/O port is used as a trigger output and connected to the scanner mainframe trigger input, and line 2 of the digital I/O port is used as a trigger input.

**Figure 176: Triggering a scanner**

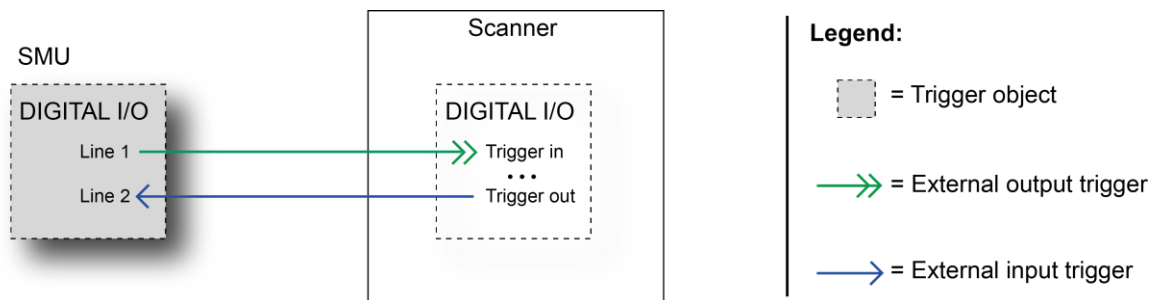

## Interactive trigger programming

The programming example below illustrates how to set up interactive triggering. The example sets the output trigger pulse width on line 1, then programs both lines 1 and 2 for falling edge triggers. Digital I/O line 1 trigger asserts, and then line 2 waits for the input trigger up to the timeout period specified.

```
-- Set line 1 pulse width to 10 us.
digio.trigger[1].pulsewidth = 10e-6
-- Set line 1 mode to falling edge.
digio.trigger[1].mode = digio.TRIG_FALLING
-- Set line 2 mode to falling edge.
digio.trigger[2].mode = digio.TRIG_FALLING
-- Assert trigger on line 1.
digio.trigger[1].assert()
-- When complete, wait for trigger on line 2.
digio.trigger[2].wait(2)
```

## More information about triggering

To obtain precise timing and synchronization between instruments, use the remote trigger model. For more information about the remote trigger model and interactive triggering using other trigger objects, see [Triggering](#) (on page 6-1).

## How do I generate a GPIB service request?

---

### NOTE

For detailed information about this topic, see the [Status model](#) (on page 15-1) section of this manual.

---

## Setting up a service request

The exact programming steps necessary to generate a GPIB service request (SRQ) vary, depending on the events intended to generate the SRQ. In general, these steps are:

1. Clear all status registers to prevent anomalous events from generating an SRQ.
2. Set the appropriate bits in the appropriate status model enable registers.
3. Set the proper bits in the service request enable register. At least one bit in this register must always be set, but the exact bits to be set will depend on the desired SRQ events.

## Service request programming example

The example below shows how to program the 2601B-PULSE to generate a service request (SRQ) when the current limit is exceeded.

```
-- Clear all registers.
status.reset()
-- Enable the current limit bit in the current limit register.
status.measurement.current_limit.enable = status.measurement.current_limit.SMUA
-- Enable the status measure current limit bit.
status.measurement.enable = status.measurement.ILMT
-- Enable the status SRQ MSB.
status.request_enable = status.MSB
```

## Polling for SRQs

To determine if the 2601B-PULSE is the GPIB device that generated the service request (SRQ), serial poll the instrument for the status byte, and test to see if the corresponding summary bits are set.

## How do I store measurements in nonvolatile memory?

After the measurements are complete, you can save the reading buffer data to the nonvolatile memory in the instrument.

### *To save the reading buffer data:*

1. From the front panel, press the **STORE** key, and then select **SAVE**.
2. Select **INTERNAL** to save to internal nonvolatile memory.
3. Select one of the following:
  - **SMUA\_BUFFER1**
  - **SMUA\_BUFFER2**
4. The front panel displays *Saving...* This may take awhile.
5. Press the **EXIT (LOCAL)** key to return to the main menu.

For additional information, see [Saving reading buffers](#) (on page 5-4).

## When should I change the output-off state?

### CAUTION

Carefully consider and configure the appropriate output-off state, source function, and compliance limits before connecting the 2601B-PULSE to a device that can deliver energy (for example, other voltage sources, batteries, capacitors, solar cells, or other 2601B-PULSE instruments). Configure recommended instrument settings before making connections to the device. Failure to consider the output-off state, source, and compliance limits may result in damage to the instrument or to the device under test (DUT).

The 2601B-PULSE instrument provides multiple output-off states. The multiple states are required because different types of connected devices (or loads) require different behaviors from the 2601B-PULSE when its output is turned off. Therefore, careful selection of the proper output-off state is important to prevent damage to devices and instruments. This is especially true when the device can deliver energy to the 2601B-PULSE, such as a battery or capacitor or when another SourceMeter instrument is connected across the output terminals. In these situations, you should use an output-off state that isolates the instrument from the device by either setting `smua.source.offfunc = smua.OUTPUT_DCAMPS` or `smua.source.offfunc = smua.OUTPUT_DCVOLTS`, as applicable.

For example, a passive device such as a diode is not affected by a 0 V source connected across its terminals when the output is turned off. However, connecting a 0 V source to the terminals of a battery causes the battery to discharge.

There are other guidelines to follow when connecting the output of multiple 2601B-PULSE instruments to get a larger current or voltage. Please refer to the following references for more information:

- [Combining SMU outputs](#) (on page 4-14)
- Keithley application notes on [tek.com/keithley](http://tek.com/keithley)

## How do I make contact check measurements?

For information about making contact check measurements, see [Contact check measurements](#) (on page 4-12) and [Contact check](#) (on page 7-23).

### NOTE

Contact check is not available when the pulser is enabled. If you need to use the contact check function in a pulser application, you can disable the pulser, run the contact check measurements, then enable the pulser.

## How can I change the line frequency or voltage?

The 2601B-PULSE requires a line voltage of 100 V AC to 240 V AC ( $\pm 10\%$ ) and a line frequency of 50 Hz or 60 Hz. The factory configures the 2601B-PULSE to automatically detect and operate at the appropriate power line frequency each time the instrument power is turned on. In noisy environments, it may be necessary to manually configure the instrument to match the actual line frequency. For more information, see [Line frequency configuration](#) (on page 2-11).

## Where can I get the LabVIEW driver?

The latest NI™ LabVIEW™ driver is available on [tek.com/keithley](http://tek.com/keithley).

## What should I do if I get an 802 interlock error?

You will receive error code 802, "OUTPUT blocked by interlock," if you:

- Disengage the interlock when the 2601B-PULSE output is already on.
- Attempt to turn on the 2601B-PULSE output when the interlock is disengaged.
- Have `smua.interlock.enable` set to `smua.ENABLE` with the interlock jumper in the 2601B-P-INT installed incorrectly. Refer to [Installing the 2601B-P-INT](#) (on page 2-6) for information.
- Have `smua.interlock.enable` set to `smua.ENABLE` but do not have the 2601B-P-INT installed. Refer to [Installing the 2601B-P-INT](#) (on page 2-6) for information.

To recover from this error, properly engage the interlock using a safe test fixture, and then turn on the 2601B-PULSE output.

## Why is the reading value 9.91e37?

This value indicates that there is a measurement overflow error. This error occurs when:

- A measurement performed on a fixed range has a measured value greater than the specified range
- The measured value is larger than the maximum current or voltage range of the instrument (exceeds the instrument rating)

If the instrument displays the overflow message on a particular range, select a higher range until an on-range reading is displayed. To ensure the best accuracy and resolution, use the lowest range possible that does not cause an overflow.

#### In this section:

[Additional 2601B-PULSE information .....](#) 18-1

### Additional 2601B-PULSE information

For additional information about the 2601B-PULSE, refer to the Keithley Instruments website ([tek.com/keithley](http://tek.com/keithley)), which contains the most up-to-date information. From the website, you can access:

- *The Low Level Measurements Handbook: Precision DC Current, Voltage, and Resistance Measurements*
- *Semiconductor Device Test Applications Guide*
- Application notes
- Updated drivers
- Information about related products, including:
  - Series 2600B System SourceMeter® Instruments
  - The Model 4200-SCS Semiconductor Characterization System
  - The 2651A High Power System SourceMeter® Instrument
  - The 2657A High Power System SourceMeter® Instrument
  - The 2400 Series SMU SourceMeter Instruments with touchscreen user interface

In addition, your local Field Applications Engineer can help you with product selection, configuration, and usage. Check the website for contact information.



Specifications are subject to change without notice.  
All Keithley trademarks and trade names are the property of Keithley Instruments, LLC.  
All other trademarks and trade names are the property of their respective companies.

---

Keithley Instruments • 28775 Aurora Road • Cleveland, Ohio 44139 • 440-248-0400 • 1-800-833-9200 • [tek.com/keithley](http://tek.com/keithley)

