

# SOLAR PERFECTION

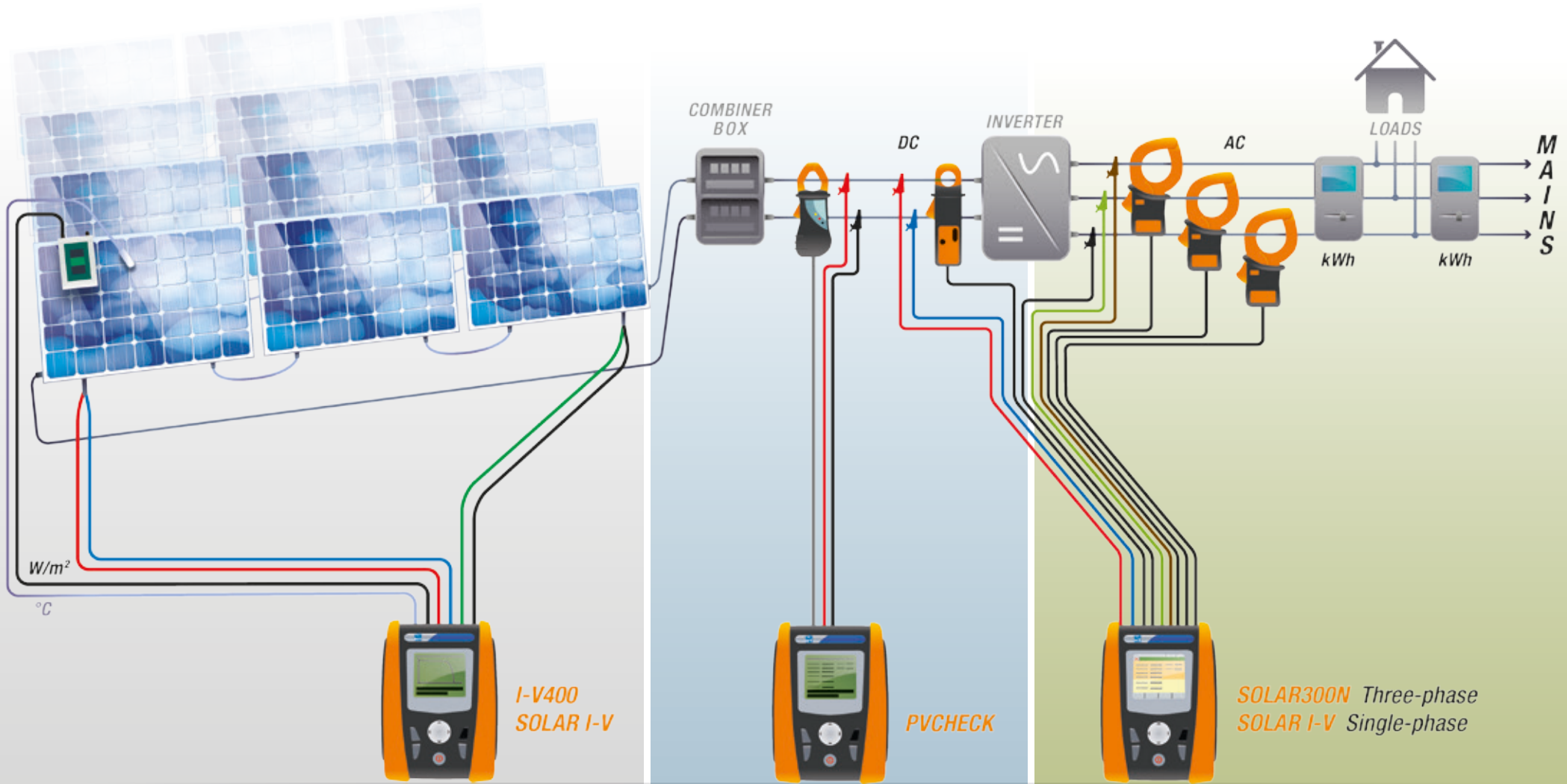



Troubleshooting

Commissioning tests

Performance

# SOLAR PERFECTION

**Photovoltaic installations: new HT solutions for commissioning tests, performance recording and troubleshooting.**

Thanks to the decreasing cost of components, and considerable increase in related performance, installing PV systems on roofs or even on the ground has become more and more common. It is necessary, however, to consider problems of **installation safety, performance recording and maintenance** that may affect any PV installation.



## Troubleshooting

- › It may happen that during the operation of a plant, some modules could fail compromising the performance of the whole system. When the efficiency of the system is lower than expected, it is necessary to troubleshoot the system to detect the broken modules, for further replacement. **SOLAR I-V** and **I-V 400** are the ideal solution for troubleshooting.

## Commissioning tests

- › Commissioning tests are carried out to prove that the systems operate and perform to the safety specification. The standard IEC 62446 states the minimum testing and commissioning requirements to be carried out on PV installation each time they are connected to the grid. **PV CHECK** is the ideal solution for commissioning tests, as well as pre-start-up system checks.

## Performance

- › Performance recording is a necessary pre-requisite to make maintenance programs effective. To monitor the performance of the system allows for detection of loss of production, to be corrected by troubleshooting and fixing the damage. **SOLAR300N**, **SOLAR I-V** and **MPP300** are the ideal solution for scheduled performance recording, as well as for loss of production investigation

# SOLAR I-V

Multifunction instrument for **testing single-phase PV installations**.  
(THREE-PHASE with accessory MPP300)

- › **Designed to meet any requirement of PV installation testers**
- › **Single phase efficiency measurement**
- › **I-V curve tracer**
- › **Voc and Isc measurement**
- › **Database of 30.000 PV modules curve types**

**Easy identification of problems on systems which are not complying with the specifications declared by the manufacturer.**

**SOLAR I-V** measures the **efficiency of single-phase PV systems** and also measures the **I-V characteristic both of a single module and of module strings on PV plants** (up to a maximum of 1000V and 10A).

## **Remote irradiation and temperature measurement**

Irradiation and temperature measurements play an essential role for extrapolation of the I-V characteristic under standard test conditions. **SOLAR I-V carries out such measurements directly or under remote mode** through the unit **SOLAR-02, synchronized with main unit**. **SOLAR I-V** can effect measurements at the inverter, while **SOLAR-02 simultaneously detects environmental values close to modules without using long cable extensions**.

**No more wasting time. It contemporarily carries out tests/recordings of 3 PV arrays.**

**SOLAR I-V** can be interfaced with optional accessory **MPP300** capable of carrying out **simultaneously tests and recordings on max 3 separate arrays**, typical of multi-MPPT systems and multi-inverter systems (with MPP300).

## **Testing outcome: OK or NOT OK**

**SOLAR I-V** compares the measured values with the values declared by the module manufacturer, **immediately providing the test result**.



## Functions

### Maintenance of a PV plant

- Measurement of output voltage from module/string up to 1000V DC
- Measurement of output current from module/string up to 10A DC
- Measurement of solar irradiation [W/m<sup>2</sup>] with reference cell HT304N
- Measurement of temperature, automatic or by means of probe PT300N
- Measurement of output DC and nominal power from module/string
- I-V curve test with direct measurement of Irr/Temp parameters
- I-V curve test by using of SOLAR-02 unit
- Measurement of the resistance of photovoltaic module series
- Mechanical inclinometer to detect correct solar irradiation
- 4-terminal measuring method
- Comparison with standard conditions (STC 1000 W/m<sup>2</sup>, 25°C)
- Evaluation of testing result: OK / NO
- Management of up to 30 types of PV modules (30000 managed by PC software)
- Internal memory for data saving
- Recalling results on the display
- Optical/USB port for PC connection
- Online Help on the display

### Performance of a PV plant

- DC/AC TRMS Voltage
- DC/AC TRMS Current
- DC power
- AC active power on single-phase systems
- Solar irradiation [W/m<sup>2</sup>] with reference cell
- Temperature environmental and module by means of probe PT300N
- Synchronization with remote unit SOLAR-02
- Display of real-time irradiation and temperature
- Use of relationship to correct DC efficiency through Temperature and Irradiance measuring
- Recording of parameters with programmable IP (5s – 60min)

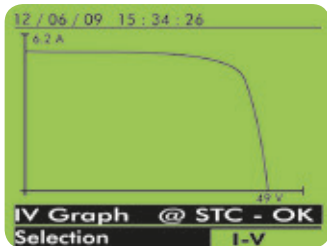

I-V curve: OK

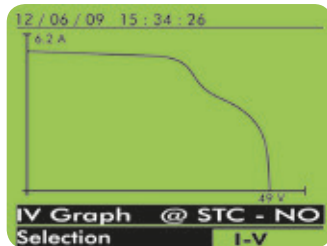

I-V curve NOT OK

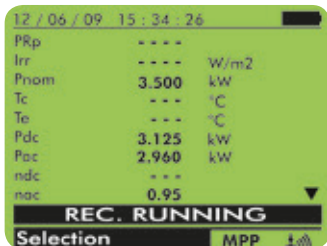

Performance Analysis running.

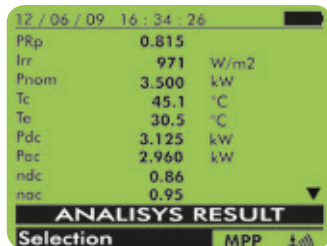

Performance outcome.

## SOLAR I-V 1

Detection of IV characteristic on a string of PV modules through remote measurement of radiation and temperature

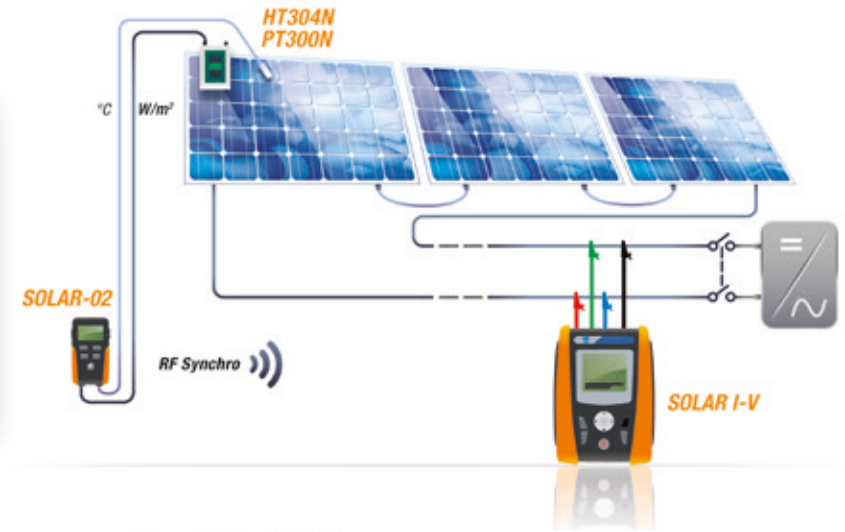

## SOLAR I-V 2

Direct measurement of IV characteristic on a string of PV modules



## SOLAR I-V 3

Testing of single-phase PV installation



# I-V 400

Multifunction instrument for **I-V curve test** of PV strings and modules.

- › **I-V Curve tracer**
- › **Voc and Isc measurement**
- › **Database of 30.000 PV modules curve types**

## Immediate recording of the I-V characteristic and of the characteristic parameters

**I-V400** carries out the field measurement of the **I-V characteristic** and of the main characteristic parameters both of a **single module** and of **module strings on PV plants** (up to a maximum of 1000V and 10A).

## Immediate compliance test result

The acquired data are then processed **to extrapolate the I-V characteristic** under standard test conditions (**STC**) in order to proceed comparing them with the rated data declared by the modules' manufacturer, thus immediately **determining whether or not the string or the module under test comply with the characteristics declared by the manufacturer**. On the other hand the analysis of **IV curve** permits to detect any fault condition on each single module composing the string under test.

## Remote irradiation and temperature measurement

**Irradiation and temperature measurements** play an essential role for extrapolation of the I-V characteristic under standard test conditions. **I-V 400** carries out such measurements directly or under remote mode through the optional unit **SOLAR-02, synchronized with main unit**. **I-V 400** can effect measurements at the inverter, while **SOLAR-02** simultaneously detects environmental values close to modules **without using long cable extensions**.

## Friendly use with possibility of continuous updating of PV modules

**I-V 400** manages a **database of PV modules**, which can be updated at any time both via the management software and directly on the instrument through the user interface.

## Very accurate measurements even using cable extensions

Current and voltage measurements on modules or strings are effected with the 4-terminal method, which allows extending measuring cables without requiring any resistance compensation, so providing **accurate and precise measurements**.



## Test outcome: OK or NOT OK

I-V 400 compares the measured values with the values declared by the module manufacturer, **immediately providing the test result**.

## Functions

- Measurement of output voltage from module/string up to 1000V DC
- Measurement of output current from module/string up to 10A DC
- Measurement of solar irradiation [W/m<sup>2</sup>] with reference cell HT304N
- Measurement of temperature, automatic or by means of probe PT300N
- Measurement of output DC and nominal power from module/string
- Numerical and graphical display of I-V characteristic
- Measurement of the resistance of photovoltaic module series
- Mechanical inclinometer for incidence angle of solar irradiation
- 4-terminal measuring method
- Comparison with standard conditions (STC 1000 W/m<sup>2</sup>, 25°C)
- Evaluation of testing result: OK / NO
- Management of up to 30 types of modules in the internal database
- Internal memory for data saving
- Recalling results on the display
- Optical/USB port for PC connection
- Help on line on the display

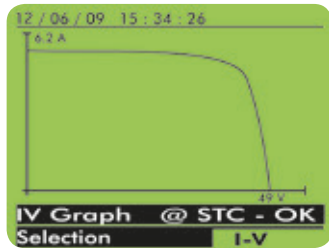

I-V curve

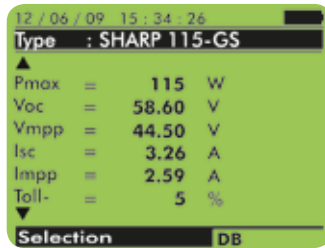

Settings PV module parameters

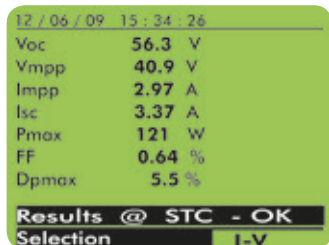

I-V outcome

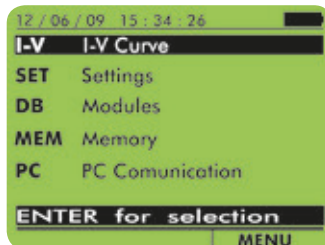

General menu

## I-V 400 1

Detection of IV characteristic on a string of PV modules through remote measurement of radiation and temperature

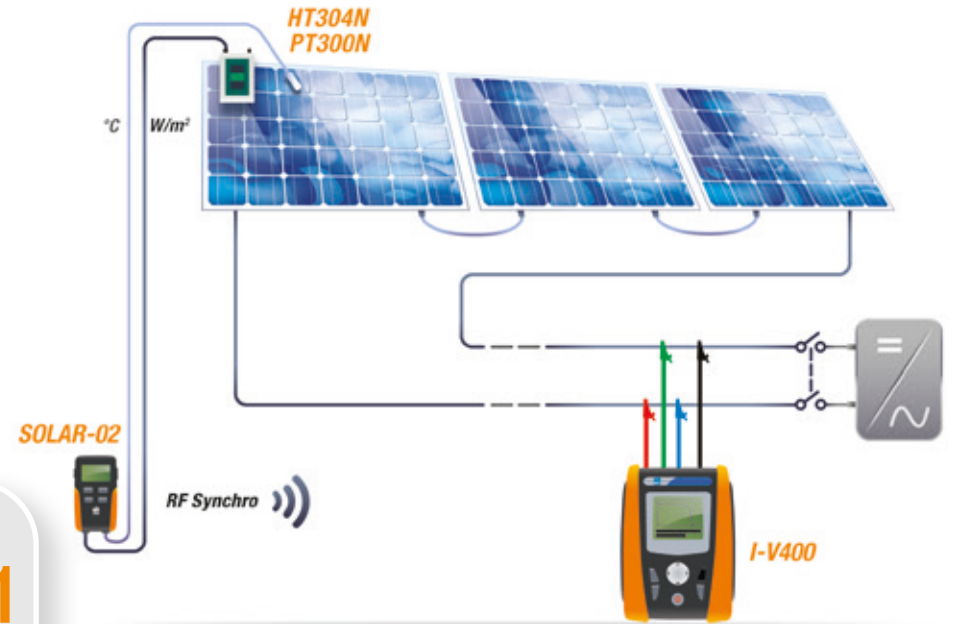

## I-V 400 2

Direct measurement of IV characteristic on a string of PV modules

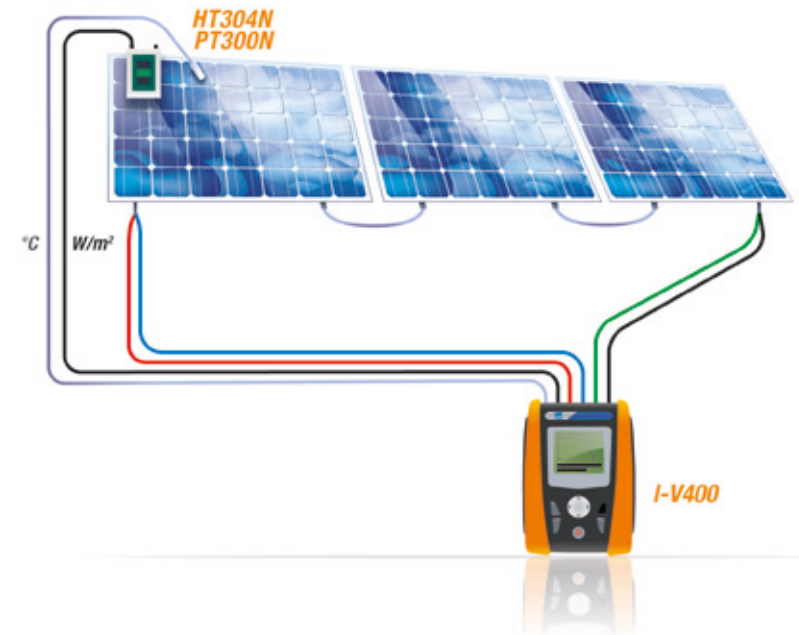

# SOLAR300N

Multifunction instrument for **testing efficiency on single-phase and three-phase PV plants** with **single/multi strings** and **analysis of power quality** according to EN50160.

- › **New touchscreen interface**
- › **Efficiency of PV installation**
- › **Power and energy consumption analyzer**



## Efficiency is the word.

SOLAR300N carries out **all tests required** for **check of DC and AC efficiency single-phase and three-phase photovoltaic systems**.

## Simultaneous measurements of electrical and environmental parameters according to standards.

HT introduced a **remote measurement device** model **SOLAR-02** capable of acquiring the values of quantities such as **irradiation [W/m<sup>2</sup>]**, **temperature of modules [°C]**, and **environment temperature [°C]**.

## Long cables are not required.

The remote unit **is synchronized with SOLAR300N** and can be positioned **close to PV modules** so **avoiding use of long measuring cables**. The **values of environmental parameters** measured by the remote unit can be **transferred via USB to SOLAR300N** and combined with the values of electrical parameters.

## No waste of time: it contemporarily carries out tests/recordings of 3 PV arrays.

SOLAR300N can be interfaced with optional accessory **MPP300** capable of carrying out **simultaneously tests and recordings** on **max 3 separate arrays**, typical of **multi-MPPT systems** and **multi-inverter systems**.

## Power analysis.

SOLAR300N is a powerful instrument to **check power quality** according to **EN50160** (harmonic analysis, voltage anomalies, flicker, voltage unbalance, etc.) so allowing to investigate on real reasons for inverter disconnection from mains power. The management software TopView provides the possibility of creating **professional reports**, which can be customized by adding the company's logo, the customer's data, comments, etc.



## Functions

- DC/AC TRMS (single-phase and three-phase) current measurement
- DC/AC (single-phase and three-phase) power measurement
- AC (single-phase and three-phase) energy measurement
- DC Measurement of power factor (cosphi) single-phase and three-phase
- Measurement of solar irradiation [W/m<sup>2</sup>] with reference cell HT304N
- Measurement of temperature by means of probe PT300N
- Recording of voltage and current harmonics up to the 49<sup>th</sup> order
- Recording of voltage anomalies (dips, peaks)
- Flicker analysis in compliance with standard EN50160
- Recording of inrush currents with a resolution of 10ms
- Recording of voltage fast transients (spikes) with a resolution of 5us
- Complete analysis of mains quality in compliance with standard EN50160
- Numerical and graphical display of each quantity
- Recalling results on the display
- TFT colour display with touch screen
- Power supply with rechargeable Li-ION battery
- Memory extension by means of compact flash (CF card)
- Data transfer to external USB memory (memory stick)
- USB port for PC connection
- Help on line at display

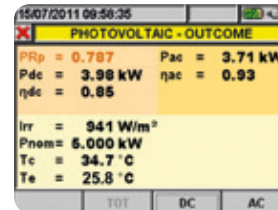

PV plant performance outcome on instrument display



PV plant performance outcome on PC

### SOLAR300N 1 SOLAR300N connection scheme (three-phase)

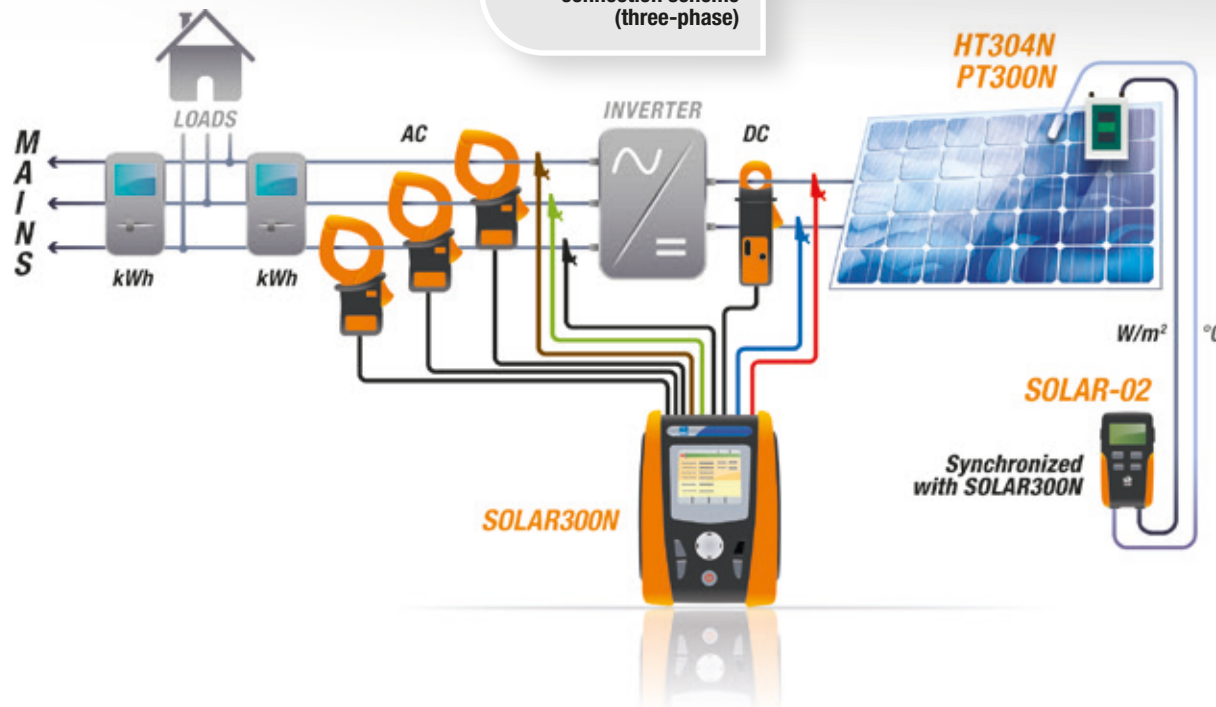

## SOLAR300N is an advanced power and energy consumption analyzer

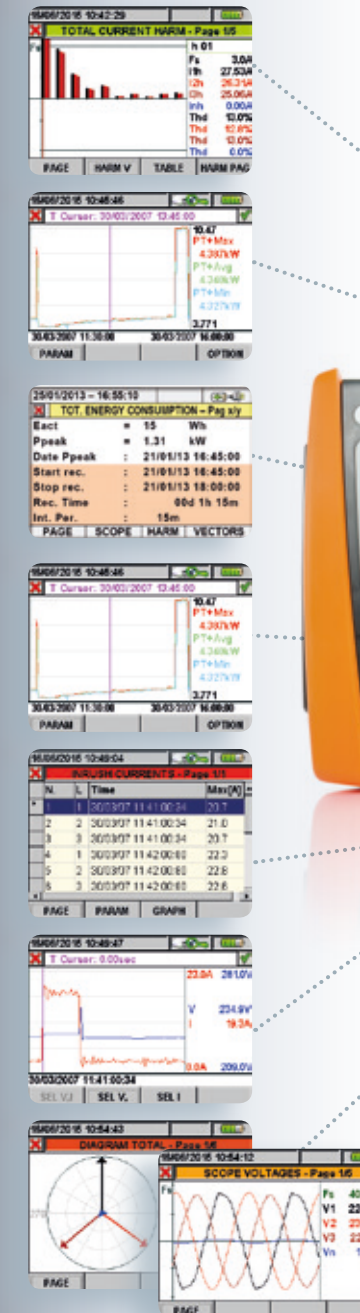

1 HARMONICS

2 RECORDING ANALYSIS

3 ENERGY CONSUMPTION

4 FLICKER

5 VOLTAGE ANOMALIES & FAST TRANSIENTS

6 INRUSH CURRENTS

7 VECTOR DIAGRAM AND WAVE FORMS

# PV CHECK

Multifunction instrument to check **safety, parameters** and **performance** of a PV plant.



- › **Automatic test sequence (IVCK):**
  - › **Insulation check**
  - › **Isc and Voc measurement**
  - › **Continuity check of protective conductor**

## The perfect check-up

- **Quick and safe testing** of electrical safety on a PV installation (DC section).
- Control on working of modules/strings in accordance with IEC/EN62446 guidelines.
- **PV CHECK** carries out insulation resistance measurement of active conductors of a module, **a string** or **a PV array** according to guidelines **without the need of using an external switch to short-circuit positive and negative terminals**.
- **PV CHECK** is provided with “**IV Check**” mode capable of evaluating **insulation**, values for **open circuit voltage Voc** and **short circuit current Isc** (both referred to **STC** through radiation measurement) as well as continuity of protective conductors on each string, with a single measurement.

## Check of PV array performance under operating conditions

- **PV CHECK** carries out **performance analysis** of PV array (DC) under operating conditions (connected to the inverter) providing an indication of the power generated and **the efficiency of the PV field** depending on irradiation condition and temperature measured by the very instrument.

## Testing outcome: OK or NOT OK

- **PV CHECK** compares test results with the values required by standards, so **granting immediate testing outcome**.

## Functions

- Safety test of PV installation
- Continuity test on protective conductors with 200mA
- Insulation test with test voltage of 250, 500, 1000VDC
- DC voltage - DC current - DC Power
- Solar irradiation [W/m<sup>2</sup>] with reference cell HT304N
- Environmental and module temperature by means of PT300N probe
- SOLAR-02: remote unit for irradiance and temperature measurements (RF connection).
- Recording of PV plant parameters (DC side) with programmable IP (5s – 60min)
- Use of PDC compensation ratios according to environmental and module temperature
- Use of relationship to maximize the DC efficiency
- Outcome OK/NO
- Check of PV string's working
- Measurement of open circuit voltage up to 1000V DC
- Measurement of short circuit current up to 10A DC
- Measurement of temperature, automatic or by means of PT300N probe
- Mechanical inclinometer for the detection of solar radiation incidence angle
- Comparison with standard conditions (STC 1000 W/m<sup>2</sup>, 25°C)
- Database to manage up to 30 types of photovoltaic modules (30000 managed by PC software)
- Internal memory for data saving
- Optical/USB port for PC connection
- Help on line on display

12/06/09 14:52:47
RPE max 2 Ω
Rcal 0.01 Ω
Rpe 0.23 Ω
Itest 210 mA
<b>Outcome: OK</b>
Selection <b>LOW</b> Ω

Continuity Test

12/06/09 14:52:47
RPE max 2 Ω
Rcal 0.01 Ω
Rpe > 200 Ω
Itest 0 mA
<b>Outcome: NO</b>
Selection <b>LOW</b> Ω

Continuity Test

12/06/09 14:52:47
Ins.Test 1000 V
Ri min 1.0 MΩ
Mode Field
Vtest 1025 V 1020 V
Ri (+) >100 MΩ
Ri (-) >100 MΩ
Rp 69 MΩ
<b>Outcome: OK</b>
Selection <b>M</b> Ω

Insulation test

12/06/09 14:52:47
Module: SUNPOWER210
Vdc 548.0 V
Irr 0 W/m <sup>2</sup>
Tc Auto °C
Voc, Isc OK
Ri (1000V) 116 MΩ OK
Rpe (Cal) 2.00 Ω OK
<b>Outcome: OK</b>
Selection <b>IVCK</b>

IVCK: automatic test sequence

## PVCHECK 1 Insulation measurement in a PV field

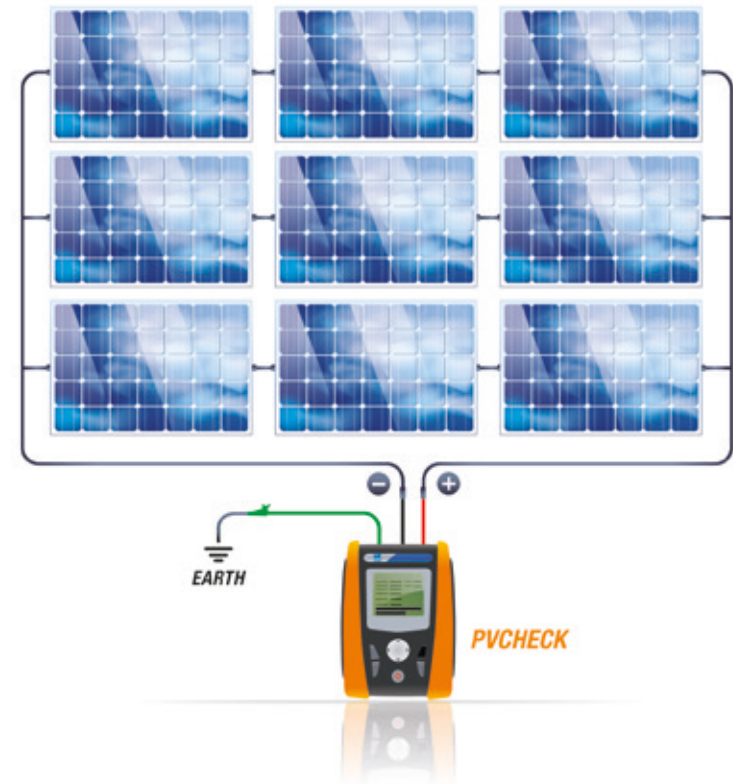

## PVCHECK 2 Measurement of DC efficiency on PV installations

# MPP300

Accessory for **measuring and recording the efficiency** of **single-phase** and **three-phase multi-string systems**

- › **Simultaneous analysis of 3 strings**
- › **For connection with SOLAR300N and SOLAR I-V**
- › **Lowering of testing times**

**MPP300** is an innovative accessory allowing **measuring and recording** the main parameters which characterize **single-phase and three-phase, single-string and multi-string** (up to three MPPTs) photovoltaic systems.

Provided with a practical **anti-shock hard carrying case**, its **light weight** and **small size** make it ideal for the field use.

**MPP300** interfaces with **SOLAR300N** and **SOLAR I-V** for settings, to start/stop **recording electrical and environmental parameters** and to **enable the download of the recorded values**. The master instrument **SOLAR300N** or **SOLAR I-V** is only used in the initial and final phase of recording, and it does not play any active role while recording electrical and environmental parameters.

The remote unit **SOLAR-02** (synchronized with **MPP300**) is positioned next to the photovoltaic modules for measuring environmental parameters (irradiation and temperature). Thanks to the **synchronism**, **it is not necessary to lay long connection cables** between the environmental probes and the instrument, hampering the operator's movements, being a hindrance, etc., **nor to use a wireless connection** between the environmental probes and the instrument, usually impossible, because of signal attenuation due to the presence of floors, of reinforced concrete or metal structures, etc. The **synchronization between the two units** guarantees the necessary contemporaneity of measurements, the two separate and independent units **make measurements comfortable and safe under any condition**.

**MPP300** finds its best partner in **SOLAR I-V**: while **MPP300** is recording the electrical and environmental parameters, it is possible to measure the **I-V characteristics** of strings and modules **with SOLAR I-V**, **saving time and money**.



## Functions

- DC/AC TRMS voltage meas. (single-phase and three-phase)
- DC/AC TRMS current meas. (single-phase and three-phase)
- DC/AC power measurement (single-phase and three-phase)
- Simultaneous measurements up to 3 strings (max 3 MPPT)
- Connection with master unit SOLAR300N and SOLAR I-V
- Power supply with rechargeable LI-ION battery and power adapter
- LED operating indications
- USB port for connection to unit SOLAR300N
- RF connection for connection to SOLAR-02 and SOLAR I-V
- Internal memory for saving recordings

### MPP300 1

- Connection diagram**
- › MPP300 + SOLAR300N via USB connection
  - › MPP300 + SOLAR I-V via RF connection

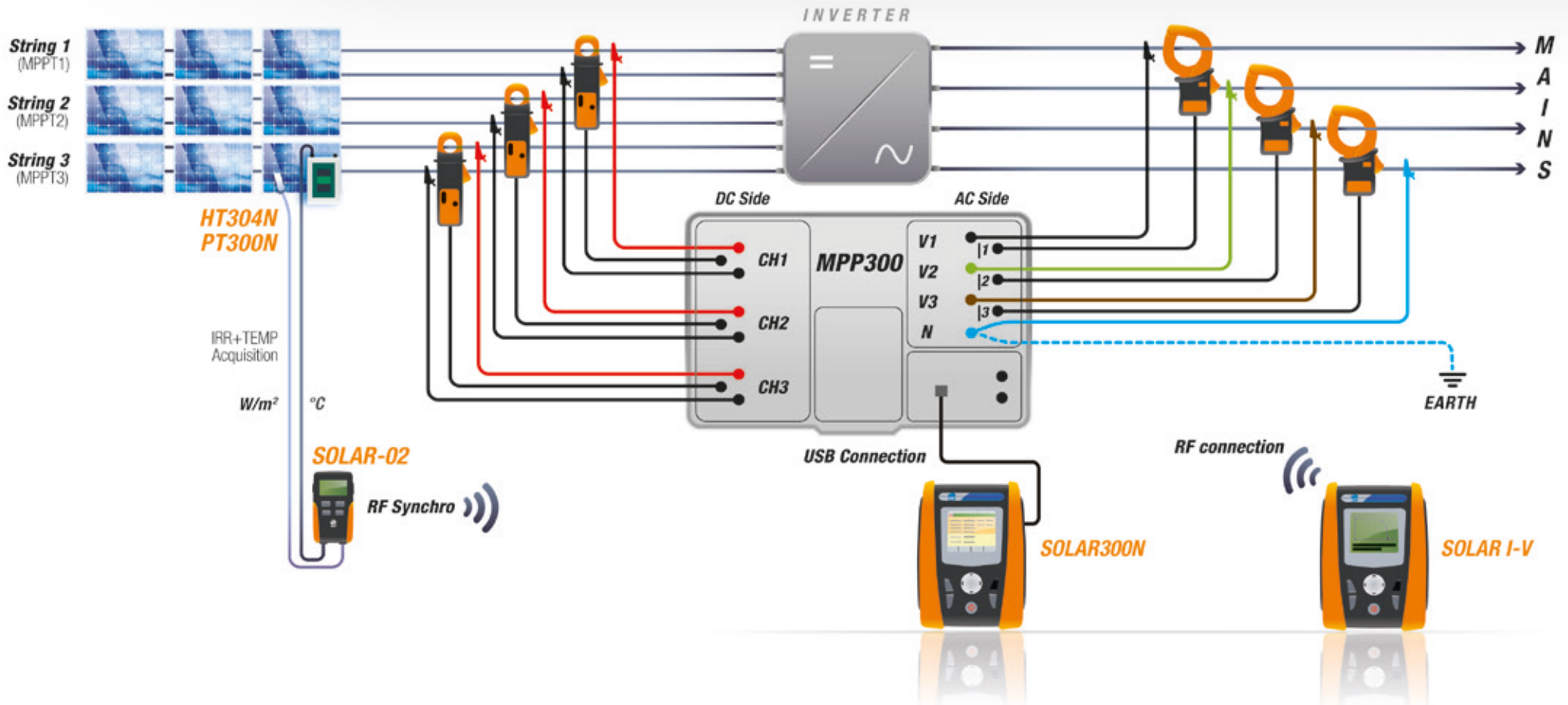

H T S ( ) L A R

# THT 70 | 60 | 47

DIGITAL INFRARED CAMERAS



\* THT70 and THT60 only. \*\* THT47 and THT60: 0,06 °C

- Light capacitive Touch Screen
- Optical Interchangeable\* Lenses
- Laser Pointer\*
- Visual image camera\*
- Built-in Flash LED\*
- Up to 3 independent cursors
- Areas with independent cursors
- 50 hz High resolution even for moving elements
- 384x288 160x120 pixel High resolution for very clear pictures
- P.I.P. fusion overlay of thermal graphical + visual picture\*
- Memory Micro™
- Connectivity USB™ UNIVERSAL SERIAL BUS
- Temperature Range -20 → +400 °C
- Automatic SPAN adjustment
- 0,06 °C Top thermal sensitivity\*\*
- 2 rechargeable batteries + charger\*
- IR video recording
- Audio notes recording
- Text notes
- Preset selection of material properties

## Infrared cameras in PV installation testing and maintenance

The **new THT range** is based on a **highly innovative and reliable technology**. These cameras are headed to **different sectors** ranging from industrial to safety, building sector etc. Thanks to **innovative wide capacitive touch screen** and **icon display** as well as **high infrared resolution 384x288 pixel and 160x120pixel**, it is easier and more intuitive to detect problems which are not visible to the naked eye. New THT cameras are provided with **Flash LED, laser pointer, camera for visual and PIP pictures**, interchangeable optional lenses. Hundreds of photos can be taken as cameras are provided with 4 GB memory so enabling to draw up **reports complete with pictures, sound and text notes**. Thermal graphical analysis will be simple and fast from now on.

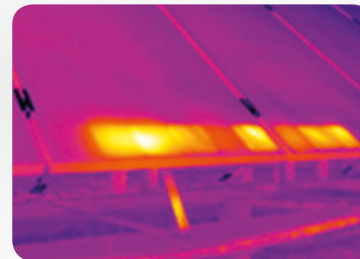

# Tech specs

## › 1. IMAGING PERFORMANCE



### Thermal

Detector type	UFPA	UFPA	UFPA
Spectral range	8 ÷ 14µm	8 ÷ 14µm	8 ÷ 14µm
Resolution / Pxl size	384 x 288 pxl / 25µm	160 x 120 pxl / 25µm	160 x 120 pxl / 25µm
Thermal sensitivity	<0.06 °C @ 30°C	<0.08 °C @ 30°C	<0.08 °C @ 30°C
Field of view (FOV)	24.6° x 18.6° (22mm lens)	29,8° x 22,6° (7.5 mm lens)	29.8° x 22.6° (7.5 mm lens)
Minimum focal distance	0.3m	0.2m	0.2m
IFOV (@1m)	1.14mrad	3.33mrad	3.33mrad
Focusing	Manual on lens	Manual on lens	Manual on lens
Image frequency	50Hz	50Hz	50Hz
Color palettes	8 (Standard) + 10 (Customized)	8 (Standard) + 10 (Customized)	8 (Standard) + 10 (Customized)

### Visible

Integrated camera	CMOS sensor 640x480 pxl, FOV 62.3°	CMOS sensor 640x480 pxl, FOV 62.3°	-----
-------------------	------------------------------------	------------------------------------	-------

## › 2. IMAGING / IR VIDEO DISPLAY

Display type	3.5" TFT color, capacitive touch-screen, high brightness	3.5" TFT color, capacitive touch-screen, high brightness	3.5" TFT color, capacitive touch-screen, high brightness
Infra PIP Fusion	IR image inside visible & visible image inside IR	IR image inside visible & visible image inside IR	-----
IR Video	Recording and saving on Micro SD card MPEG4 file format	Recording and saving on Micro SD card MPEG4 file format	Recording and saving on Micro SD card MPEG4 file format
Video output	PAL / NTSC	PAL / NTSC	PAL / NTSC
Electronic zoom	x1 ÷ x20 in continuous way	x1 ÷ x20 in continuous way	x1 ÷ x20 in continuous way
Image rotation	0° ÷ 360° in step of 1°	0° ÷ 360° in step of 1°	0° ÷ 360° in step of 1°

## › 3. MEASUREMENT

Temperature range	-20°C ÷ 400°C	-20°C ÷ 400°C	-20°C ÷ 400°C
Measurement unit	°C, °F, °K	°C, °F, °K	°C, °F, °K
Accuracy	±2 % reading or ±2°C	±2% reading or ±2°C	±2% reading or ±2°C
Measurement cursors	3 (selection temperature MIN, MAX, Customized position on image)	3 (selection temperature MIN, MAX, Customized position on image)	3 (selection temperature MIN, MAX, Customized position on image)
Laser pointer	Class 2 according to IEC 60825-1	Class 2 according to IEC 60825-1	-----
Built-in illuminator	White light LED	White light LED	-----
Measurement modes	Automatic / Manual / Histogram	Automatic / Manual / Histogram	Automatic / Manual / Histogram
Emissivity correction	0.01 ÷ 1.00 + built-in table with common materials	0.01 ÷ 1.00 + built-in table with common materials	0.01 ÷ 1.00 + built-in table with common materials
Measurement features	Automatic correction based on distance, relative humidity, atmospheric temperature, offset	Automatic correction based on distance, relative humidity, atmospheric temperature, offset	Automatic correction based on distance, relative humidity, atmospheric temperature, offset
Advanced analysis	Spots (max 3), Lines (max 2), Areas (max 3), Isotherm	Spots (max 3), Lines (max 2), Areas (max 3), Isotherm	Spots (max 3), Lines (max 2), Areas (max 3), Isotherm
Alarm on temperature	Associated to measurements spots	Associated to measurements spots	Associated to measurements spots

# Tech specs



SOLAR I-V



I-V 400



SOLAR300N



PV CHECK



MPP300

## DISPLAY AND MEMORY

Display Features	128x128pxl LCD with backlight	128x128pxl LCD with backlight	Graphic 64k color TFT touch screen with backlight and adjustable contrast	128x128pxl LCD with backlight	-----
Internal Memory capacity	256 kbytes	256 kbytes	15MB	256 kbytes	2Mbytes
External memory	-----	-----	USB memory stick / CF Card	-----	-----
Saved data	Max 99 yield tests; 249 curves (I-V curve test), 999 IVCK	249 curves (I-V curve test), 999 IVCK	1 month @ IP=15min, 251 par	Max 999 tests	-----

## POWER SUPPLY

Internal power supply	6x1.5V alkaline batteries type LR6, AA, AM3, MN 1500	6x1.5V alkaline batteries type LR6, AA, AM3, MN 1500	Li-ION, 3.7V rechargeable battery	6x1.5V alkaline batteries type LR6, AA, AM3, MN 1500	Li-ION, 3.7V rechargeable battery
External power supply	-----	-----	110V/230V AC 50/60Hz to 5V DC adapter	-----	110V/230V AC 50/60Hz to 5V DC adapter
Battery duration	> 249 curves (I-V curve test), 999 IVCK tests, approx. 120 h (yield test)	> 249 curves (I-V curve test), 999 IVCK tests	> 6 hours	Approx. 120 hours (DC efficiency test)	> 3 hours
SOLAR-02 max recording time	Approx 1.5h (@ IP=5s)	Approx 1.5h (@ IP=5s)	Approx 1.5h (@ IP=5s)	Approx 1.5h (@ IP=5s)	Approx 1.5h (@ IP=5s); approx 8 days (@ IP=600s)
Auto power Off idleness	After 5 mins.	After 5 mins.	After 5 mins. (no external power)	After 5 mins.	-----

## CHARACTERISTICS OF RADIO MODULE

Frequency range	2.400 ÷ 2.4835 GHz	2.400 ÷ 2.4835 GHz	-----	2.400 ÷ 2.4835 GHz	2.400 ÷ 2.4835 GHz
R&TTE category	Class 1	Class 1	-----	Class 1	Class 1
Max transmission power	30µW	30µW	-----	30µW	30µW
Max RF connection distance	1m	1m	-----	1m	1m

## OUTPUT INTERFACE

PC communication port	Optical/USB	Optical/USB	USB	Optical/USB	-----
Wireless RF interface (max distance 1m)	Connection with SOLAR-02	Connection with SOLAR-02	Connection with SOLAR-02	Connection with SOLAR-02	Connection with SOLAR I-V and SOLAR-02
USB interface	-----	-----	For USB memory sticks	-----	Connection with SOLAR300N
Integration Period (IP)	5s to 60min	-----	1s to 60min	5s to 60min	5s to 60min
Operative system	-----	-----	Windows CE	-----	-----

## MECHANICAL FEATURES

Dimensions (L x W x H) and weight	235 x165 x 75 mm - 1.2 kg	235 x165 x 75 mm - 1.2 kg	235 x165 x 75 mm - 1.0 kg	235 x165 x 75 mm - 1.2 kg	300 x265 x 140 mm - 2.3 kg
Encapsulation	IP40	IP40	IP40	IP40	IP65

## ENVIRONMENTAL CONDITIONS

Reference temperature	23°C ± 5°C	23°C ± 5°C	23°C ± 5°C	23°C ± 5°C	23°C ± 5°C
Working temperature	0° ÷ 40°C	0° ÷ 40°C	0° ÷ 40°C	0° ÷ 40°C	0° ÷ 40°C
Working humidity	< 80% HR	< 80% HR	< 80% HR	< 80% HR	< 80% HR
Storage temperature (batt. not incl.)	-10 ÷ 60°C	-10 ÷ 60°C	-10 ÷ 60°C	-10 ÷ 60°C	-10 ÷ 60°C
Storage humidity	< 80% HR	< 80% HR	< 80% HR	< 80% HR	< 80% HR

## REFERENCE STANDARDS

Safety	IEC/EN 61010-1	IEC/EN 61010-1	IEC/EN 61010-1	IEC/EN 61010-1	IEC/EN 61010-1
Safety of measurement accessories	IEC/EN 61010-031	IEC/EN 61010-031	IEC/EN 61010-031, IEC/EN 61010-2-032	IEC/EN 61010-031	IEC/EN 61010-031
Measurements	IEC/EN 60891 (I-V curve) IEC/EN 60904-5 (Temperature measurement)	IEC/EN 60891 (I-V curve) IEC/EN 60904-5 (Temperature measurement)	-----	IEC/EN 62446 (IVCK) IEC/EN 60904-5 (Temperature measurement) IEC/EN 61557-1,-2,-4 (LOWΩ, MΩ)	-----
Insulation	Double insulation	Double insulation	Double insulation	Double insulation	Double insulation
Pollution degree	2	2	2	2	2
Overvoltage category	CAT II 1000V DC, CAT III 300V AC to ground Max 1000V between inputs P1,P2,C1,C2	CAT II 1000V DC, CAT III 300V AC to ground Max 1000V between inputs P1,P2,C1,C2	CAT IV 600V to ground, Max 1000V between inputs	CAT III 1000V DC, Max 1000V DC among inputs P, N, E, C	CAT III 1000V DC, Max 1000V between DC inputs CAT IV 300V AC to ground, Max 600V between AC inputs
Max altitude of use	2000 m	2000 m	2000 m	2000 m	2000 m
Power quality	-----	-----	IEC/EN50160	-----	-----
Measurement performance	-----	-----	IEC/EN61000-4-30 class B	-----	-----
Flicker	-----	-----	IEC/EN61000-4-15, IEC/EN50160	-----	-----
Unbalance	-----	-----	IEC/EN61000-4-7, IEC/EN50160	-----	-----





# Cross references

	SOLAR I-V	I-V 400	SOLAR300N	PV CHECK	MPP300
Continuity of protective conductors with 200mA				•	
Insulation with test voltages of 50, 100, 250, 500, 1000V DC				• (250, 500, 1000)	
String mode and field mode insulation				•	
Phase sequence			•		
DC/AC TRMS voltage/current on single-phase systems	•		•	• (DC only)	•
DC/AC TRMS voltage/current on three-phase systems			•	• (DC only)	•
DC/AC powers on single-phase systems	•		•	• (DC only)	•
DC/AC powers on three-phase systems			•	• (DC only)	•
Power factor (cos ) on single-/three-phase systems			•		
Energies on single-phase and three-phase systems			•		
Recording of mains parameters with programmable IP	• (5s - 60m)		• (1s-60m)	• (5s-60m)	
Maximum number of quantities contemporarily selectable	9		251	5	
Harmonic analysis of voltages/currents up to the 49th order			•		
Detection of voltage anomalies (dips, peaks) in 10ms			•		
Complete analysis according to EN50160			•		
Inrush current of electric motors			•		
Voltage fast transients (spikes) with a resolution of 5µs (200kHz)			•		
Voltage unbalance (NEG%, ZERO%) and Flicker (Pst, Plt)			•		
Display of vector diagrams and waveforms of voltages/currents			•		
Indication of recording autonomy			•		
Default and customizable recordings			•		
TFT touch-screen colour display			•		
LCD custom backlit display	•	•		•	
Power supply by rechargeable battery and by means of external power supplier			•		•
Use of remote unit	•	•	•	•	•
Efficiency measurement/recording of single-string system	•	•	•	• (DC only)	•
Efficiency measurement/recording of multi-string system up to 3 MPPTs	• (with MPP300)		• (with MPP300)		•
Efficiency measurement/recording of single-phase system	•		•		•
Efficiency measurement/recording of three-phase system	• (with MPP300)		•		•
Irradiation measurement with reference solar cell	•	•	•	•	
Temperature measurement of modules and environment	•	•	•	•	
Detection of I-V curve of modules and strings	• (1000V, 10A)	• (1000V, 10A)			
Quick test mode	• (1000V, 10A)	• (1000V, 10A)		• (1000V, 10A)	
Internal database of PV modules	•	•		•	
Measurement of modules and strings data (Voc, Vmpp, Impp, Isc, Pmax, FF, Dpmax)	•	•		• (Voc, Isc)	
Auto power off	•	•	•	•	•
Memory capacity	> 200 curves 8 days @ PI=10 min	> 200 curves	1 month @ PI=15 min, 251 par	999 locations	2 Mbyte
Extension of internal memory with external Compact Flash			•		
USB port for connection of external memory sticks			•		
PC interface with software for Windows	• (optical/USB)	• (optical/USB)	• (USB)	• (optical/USB)	
Context-sensitive help on the display	•	•	•	•	
Saving of recordings and instant values	•	•	•	•	
Dimensions (L x W x H) (mm)	235x165x75	235x165x75	235x165x75	235x165x75	300x265x140
Weight (batteries included)	1,3 Kg	1,2 Kg	1 Kg	1,2 Kg	2,3 kg
Safety in compliance with IEC/EN61010-1	•	•	•	•	•

# Accessories

	SOLAR I-V	I-V 400	SOLAR300N	PV CHECK	MPP300
PT300N PT1000 probe for cell temperature measurement	S	0	S	0	0
SOLAR-02 Remote unit for irradiance/temperature	S	0	S	0	0
KITGSC4 Set 4 cables + 4 alligator clips	S	S	S	S	--
KITPVMC3 Set of 2 adapters MC3 compliance	S	S	S	S	--
KITPVMC4 Set of 2 adapters MC4 compliance	S	S	S	S	--
KIT800 Set of 5 cables + 5 alligator clips	--	--	S	--	--
KITMPPACC Set of 4 alligator clips for AC voltage measure	--	--	--	--	S
KITMPPACW Set of 4 cables for AC voltage measurement, 2m	--	--	--	--	S
KITMPPDCC Set of 2 alligator clips for DC voltage, 3 pcs	--	--	--	--	S
KITMPPDCW Set of 2 cables for DC voltage measurement, 3 pcs	--	--	--	--	S
A0055 External adapter AC/DC recharging battery	--	--	S	--	S
YABAT0003HT0 Li-ION rechargeable battery	--	--	S	--	S
PT400 Stylus	--	--	S	--	--
HT304N Reference cell for radiation measurements	S	S	S	0	0
M304 Mechanical inclinometer	S	S	S	0	--
HT4004N Transducer clamp 10-100A DC	S	--	S	--	0
HT4005K Transducer clamp for AC current up to 200A	S	--	S	--	0
TOPVIEW2006 Windows softw. + optical/USB cable C2006	S	S	--	S	--
TOPVIEW2007 Windows softw. + optical/USB cable	--	--	S	--	S
C2007 USB Cable	--	--	--	--	S
BORSA2051 Soft carrying bag	--	--	--	S	--
ISO9000 calibration certificate	S	S	S	S	S
User Manual	S	S	S	S	S
Quick reference guide	S	S	S	S	S
SP-0400 Set of straps for use of meter on neck	0	0	0	0	--
KITPVEXT25M Set of 2 4mm banana cables, Green/Black, 25m l.	--	0	--	--	--
VA400 Hard carrying case	0	0	0	--	--
VA500 Hard carrying case	S	S	S	--	--
MPP300 Accessory for checks of SP/TP multi-string plants	0	--	0	--	--
HT96U Standard clamp 1-100-1000A AC, diameter 54mm	0	--	0	--	0
HT97U Standard clamp 10-100-1000A AC, diameter 54mm	0	--	0	--	0
HT98U Standard clamp 1000A DC, diameter 50mm	0	--	0	--	0
HTFLEX33D Flex clamp 3000A, for use as analyzer only	--	--	0	--	0
HP30D1 Standard clamp with wide jaws up to 1000A DC	0	--	0	--	0
HP30C3 Standard clamp 3000A AC, diameter 70mm	--	--	0	--	0
HP30C2 Standard clamp 200-2000A AC, diameter 70mm	--	--	0	--	0
HT4004P Standard clamp 10-100A DC, only for use with MPP300	0	--	0	--	0
HT903 Accessory for connection to external CTs	--	--	0	--	--
606-IECN Connector with magnetic test lead	0	--	0	--	0
ACON3F4M Adapter for connection of DC clamps to MPP300	0	--	0	--	0
HT4004 Standard clamp for DC current up to 100A	--	--	--	S	--

S = STANDARD    0 = OPTIONAL

# Accessories

Standard & Optional

SOLAR-02



HT304N



VA400



M304



KITPVMC3 & KITPVMC4



HT4004



HP30C2



HT4004N



HT4005K



HT98U



HP30D1



PT300N



606-IECN



HT96U





 **HT ITALIA S.R.L.**

Via della Boaria, 40  
48018 Faenza (RA) Italia  
T **+39 0546 621002**  
F **+39 0546 621144**  
E-mail [export@htitalia.it](mailto:export@htitalia.it)  
**ht-instruments.it**

 **HT INSTRUMENTS AMERICAS LLC**

3145 Bordentown Avenue  
W3, Parlin, NJ 08879  
USA  
Tel. **1 719 421 9323**  
E-mail: [sales@ht-instruments.us](mailto:sales@ht-instruments.us)  
**ht-instruments.us**

 **HT INSTRUMENTS GMBH**

Am Waldfriedhof, 1b  
D-41352 Korschenbroich, Deutschland  
Tel. **+ 49 (0)2161 564 581**  
Fax **+ 49 (0)2161 564 583**  
E-mail: [info@ht-instruments.de](mailto:info@ht-instruments.de)  
**ht-instruments.de**

 **HT INSTRUMENTS SA**

C/ Legalitat, 89  
08024 Barcelona, España  
Tel. **+34 93 4081777**  
Fax **+34 93 4083630**  
E-mail: [info@htinstruments.es](mailto:info@htinstruments.es)  
**ht-instruments.es**