

User's manual FLIR Si124

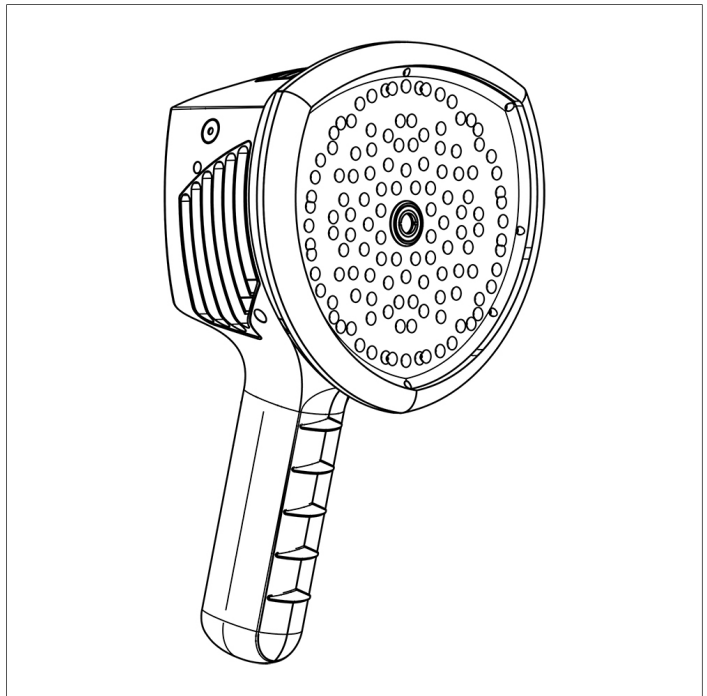

Table of contents

1	Disclaimers	1
	1.1 Legal disclaimer	1
	1.2 Third-party licenses.....	1
	1.3 U.S. Government Regulations	1
	1.4 Copyright.....	1
	1.5 Patents.....	1
	1.6 Usage statistics.....	1
2	Safety information	2
3	Notice to user	3
	3.1 Thank you!	3
	3.2 List of contents.....	3
	3.3 Read the manual before use	3
	3.4 Register your product	4
	3.5 Customer help	4
	3.6 Disposal of electronic waste.....	4
4	Introduction	5
5	Camera parts	6
6	Battery parts	8
7	Getting started	9
	7.1 Charging	9
	7.2 Fuel gauge.....	9
	7.3 Startup	10
	7.4 Shutdown	11
8	User interface	12
	8.1 Heatmap	12
	8.2 Take snapshot.....	13
	8.3 Snapshot browser.....	14
	8.4 Zoom	15
	8.5 Single-source / multi-source mode	15
	8.6 Screen brightness.....	15
	8.7 Settings.....	16
	8.7.1 Network settings	16
	8.7.2 Change modes.....	17
	8.7.3 Advanced settings.....	17
	8.8 Filter	17
	8.9 Distance	18

Table of contents

8.10	Frequency.....	18
8.11	Real-time analysis	19
8.12	Cloud upload	19
8.13	USB export	19
8.14	Remote update	20
8.15	USB update.....	20
9	Usage techniques	21
9.1	General usage	21
9.2	Locating sound sources and taking snapshots	21
10	FLIR Acoustic Camera Viewer	24
10.1	Browse through snapshots	24
10.2	Snapshot view	25
10.3	Color mode	26
10.4	Offline file upload.....	26
10.5	Report generation.....	27
10.6	Camera selection	27

1 Disclaimers

1.1 Legal disclaimer

Terms of use is available in the user interface of the product.

For warranty terms, refer to <https://www.flir.com/warranty>.

1.2 Third-party licenses

Information about third-party licenses is available in the user interface of the product.

1.3 U.S. Government Regulations

This product may be subject to U.S. Export Regulations. Send any inquiries to exportquestions@flir.com.

1.4 Copyright

© 2020, FLIR Systems, Inc. All rights reserved worldwide. No parts of the software including source code may be reproduced, transmitted, transcribed or translated into any language or computer language in any form or by any means, electronic, magnetic, optical, manual or otherwise, without the prior written permission of FLIR Systems.

The documentation must not, in whole or part, be copied, photocopied, reproduced, translated or transmitted to any electronic medium or machine readable form without prior consent, in writing, from FLIR Systems.

Names and marks appearing on the products herein are either registered trademarks or trademarks of FLIR Systems and/or its subsidiaries. All other trademarks, trade names or company names referenced herein are used for identification only and are the property of their respective owners.









1.5 Patents

This product is protected by patents, design patents, patents pending, or design patents pending.

1.6 Usage statistics

FLIR Systems reserves the right to gather anonymous usage statistics to help maintain and improve the quality of our software and services.

2 Safety information

 CAUTION
Do not touch the heatsinks when the camera is powered on. The heatsinks become hot when the power is on.
 CAUTION
Take special care around heavy machinery when carrying the camera bag. The strap of the bag is rigid and does not have a separate safety release mechanism.
 CAUTION
Protect the camera and accessories from dirt, dust, impacts, and liquids.
 CAUTION
Always keep the USB port covered. If water enters the camera, damage to the electronics inside can occur.
 CAUTION
Do not disassemble the camera. Damage to the camera can occur.
 CAUTION
Only use the accessories that are provided with the camera.
 CAUTION
Only use spare parts provided by FLIR Systems.
 CAUTION
Do not use any damaged camera, battery, or accessories.

Note For safety information related to the battery, refer to the supplied printed documentation for the battery.

3 Notice to user

3.1 Thank you!

Thank you for choosing a product from FLIR Systems. We hope that the product will meet your expectations and that you will consider us again for your future needs.

3.2 List of contents

- Camera
- Battery
- Battery cable
- Battery charger
- Battery pouch
- Camera hand strap
- Camera pouch
- Printed documentation
- USB memory stick

3.3 Read the manual before use

Before operating the device, you must read, understand, and follow all instructions, warnings, cautions, and legal disclaimers. Misuse can cause damage to the camera or false sensor readings.

To access online documentation and technical data specifications for the FLIR Si124, go to:

<http://support.flir.com/resources/g9wc>

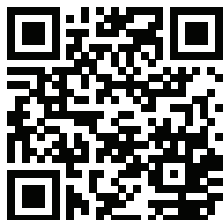

3.4 Register your product

By registering your product you gain easy access to updates, product notifications, the status of any pending service cases, and more.

To register your product, go to <http://support.flir.com/camreg/>.

3.5 Customer help

Do not hesitate to contact our Customer Support Center if you experience problems or have any questions about your product.

For customer help, go to <http://support.flir.com>.

3.6 Disposal of electronic waste

Electrical and electronic equipment (EEE) contains materials, components and substances that may be hazardous and present a risk to human health and the environment when waste electrical and electronic equipment (WEEE) is not handled correctly.

Equipment marked with the below crossed-out wheeled bin is electrical and electronic equipment. The crossed-out wheeled bin symbol indicates that waste electrical and electronic equipment should not be discarded together with unseparated household waste, but must be collected separately.

For this purpose all local authorities have established collection schemes under which residents can dispose waste electrical and electronic equipment at a recycling centre or other collection points, or WEEE will be collected directly from households. More detailed information is available from the technical administration of the relevant local authority.



4 Introduction

The FLIR Si124 is a standalone system for acoustic image measurements and signal analysis. As a standalone system, no additional equipment is needed for basic usage of the device.

The FLIR Si124 uses 124 microphones to form a very precise acoustic image in the desired direction. This acoustic image is transposed in real-time on top of a digital camera picture, which allows the user to accurately see from which directions sound is arriving to the camera. Interesting sound sources can then be separated from background noise and saved for deeper analysis and problem classification, using the FLIR Acoustic Camera Viewer service.

The FLIR Si124 is a lot more sensitive and accurate than the human ear, which means that it can locate both sound sources that are inaudible to the human ear, as well as sound sources that the human ear cannot reliably locate. The FLIR Si124 has a frequency range that extends to ultrasonic frequencies, which is a huge benefit since many interesting problems and phenomena can be located precisely using ultrasound.

5 Camera parts

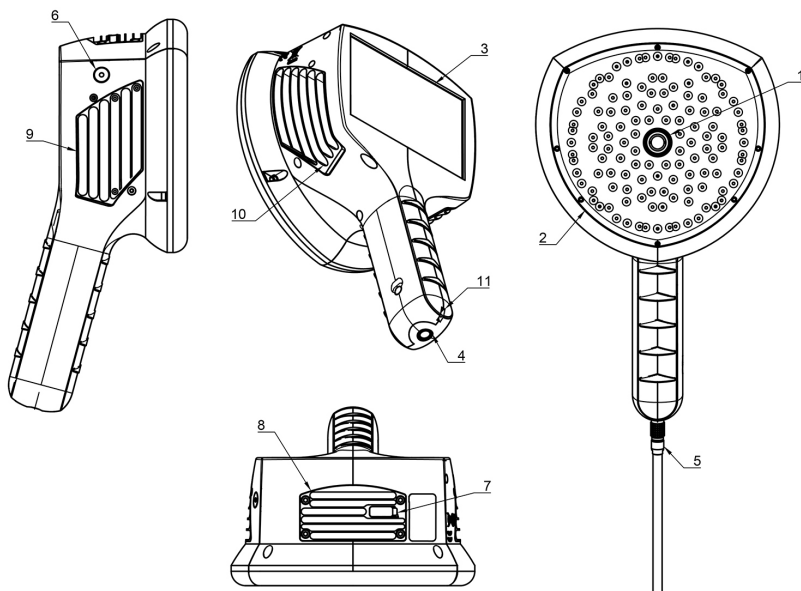

1. Video camera
2. Microphone array
3. LCD screen
4. Power connector
5. Battery cable
6. Power LED
7. USB port
8. Top heatsink
9. Right side heatsink
10. Left side heatsink
11. Lanyard attachment point



CAUTION

Do not touch the heatsinks when the camera is powered on. The three heatsinks (8, 9, and 10) become hot while the power is on.

The front side of the camera consists of a video image sensor (1) and the microphone array (2). The video shown on the display is monochromatic (black and white) and the acoustic image is colored.

The camera has a resistive touch screen (3). The screen can also be used with gloves. Only touch the screen using your finger - do not use the touch screen with anything sharp or with hard objects, which may damage the surface. Do not exert excessive force when pressing the screen as it will affect the durability of the touch screen.

The main power source is an external battery which is connected to the bottom of the handle (4). The camera comes with a battery cable (5) which can be attached to the camera. Only use batteries and cables provided with the camera or otherwise approved for use with the camera.

The status of the internal power supply unit is indicated by the power LED (6), which is red when the power is on. While the power is on the camera dissipates heat through the three heatsinks (8, 9, 10) which are located on both sides and the top. While using the camera the heatsinks must be uncovered to ensure that the heat dissipation works properly. Do not bag the device while the Power LED is on. Please note that the heatsinks sometimes get hot after prolonged usage, so be careful when touching the heatsinks.

There are two ways to export the results from the camera - using the included FLIR Acoustic Camera Viewer service which requires a secure wifi connection, or through USB export (if available on your unit). The USB port is located under the cover on top of the device (7). Please use the included USB memory stick for result export.

Note Protect the camera lens and the microphone array from any kind of foreign objects, dust, and liquids.

6 Battery parts

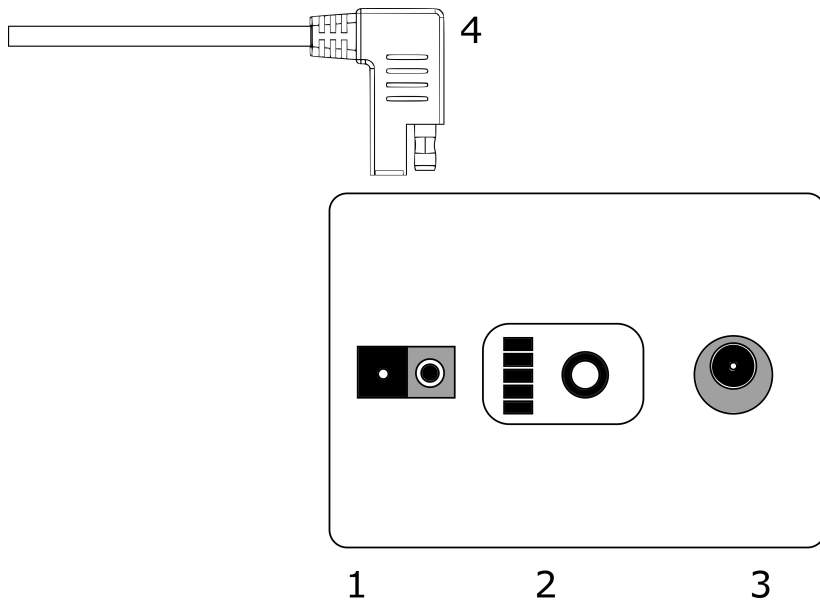

- 1. Connector for the battery cable
- 2. Fuel gauge
- 3. Charging connector
- 4. Battery cable connector

7 Getting started

7.1 Charging

The main power source of the camera is the battery. It should be charged fully before usage - also make sure the battery is charged before prolonged storage. To charge an empty battery fully usually takes 4-6 hours. Please note that the battery should be charged at temperatures between 0°C and +40°C (+32°F to +104°F). A new battery used in optimal environment conditions yields over 7 hours of usage.

The battery and the charger is delivered with the camera. Only use the provided battery charger. Plug the mains cable of the charger into the wall socket and the DC connector to the charging connector of the battery (2). When the status LED of the charger is red the battery is being charged. When the status LED of the charger is green while the DC connector is connected to the battery the charge is complete. The status LED is also green when the DC connector is disconnected.

Mains cable connected	Charge cable connected	Status LED on charger
No	No	Off
Yes	No	Green
Yes	Yes	Red, Charging
Yes	Yes	Green, Fully Charged

7.2 Fuel gauge

Press the fuel gauge button to test the state of the battery charge. This is approximate only and the most accurate results is after 2 minutes of no load.

LEDs	State of the battery charge
3 green, 2 red	Full
2 green, 2 red	Over 50 %
1 green, 2 red	Over 20 %
2 red	Less than 20 % (recharge soon)
1 red	Less than 10 % (near self switch off)
No lights	Empty (recharge within 12 hours)

Nominally the battery yields 7-8 hours of usage. Though the battery usage depends on multiple variables which may decrease the usage time. These are the cell temperatures, the load and the age (cycles) of the battery.

7.3 Startup

The camera will start automatically when the power supply is connected. The camera will shut down automatically when the battery is disconnected.

If the battery is disconnected accidentally and immediately reconnected to the camera the unit will reboot. When shutting the device down, it is recommended to wait until the power LED is off before connecting the battery power supply again.

1. Attach the battery cable to the battery. The connector of the battery cable can be attached to the battery connector (1) only one way.
2. Attach the connector to the camera according to the following instructions, with the orientation markings facing the same way:

Both the camera and the battery cable have **red orientation markings**. They indicate the position of the key and the slot of the connectors which ensures the proper connection orientation. **Hold the battery cable connector by the locking ring** and make sure that the orientation markings of both connectors are aligned before inserting the battery cable. **Then carefully insert the battery cable connector to the camera**. The connectors should lock audibly.

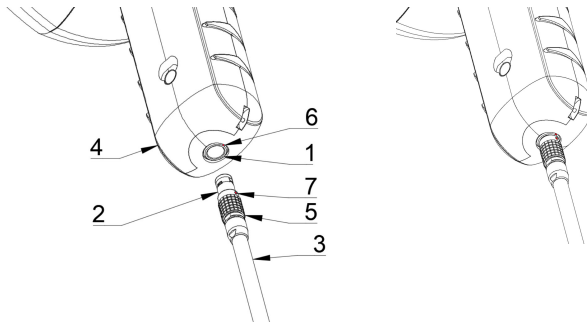

1. Power input
2. Battery cable connector
3. Battery cable
4. Camera handle
5. Locking ring
6. Orientation marking 1
7. Orientation marking 2

7.4 Shutdown

To turn off the camera, simply disconnect the battery connector from the camera.

Note Do not pull by the cord or use any kind of tool to disconnect the cable.

1. Hold the battery cable connector by the locking ring and pull it outwards. The locking ring will slide until it releases the connection. Alternatively disconnect the cable from the battery.
2. The FLIR logo will appear and the system will safely perform a shutdown.
3. The red Power LED will turn off when the shutdown is complete.

If you encounter a problem with the system, a hard shutdown is performed by disconnecting the battery power and waiting longer until the power led will turn off. If the shutdown takes more than a 5 minutes after disconnecting the battery, contact FLIR Systems for service.

8 User interface

The camera supports the following application modes:

- *Air* mode is used for localization of pressurized air leaks.
- *Power* mode is used for localization and classification of high-voltage partial discharges.

The available functions, settings, and real-time analysis information in the user interface depend on the selected application mode.

An example of the graphical user interface of the camera is shown below.

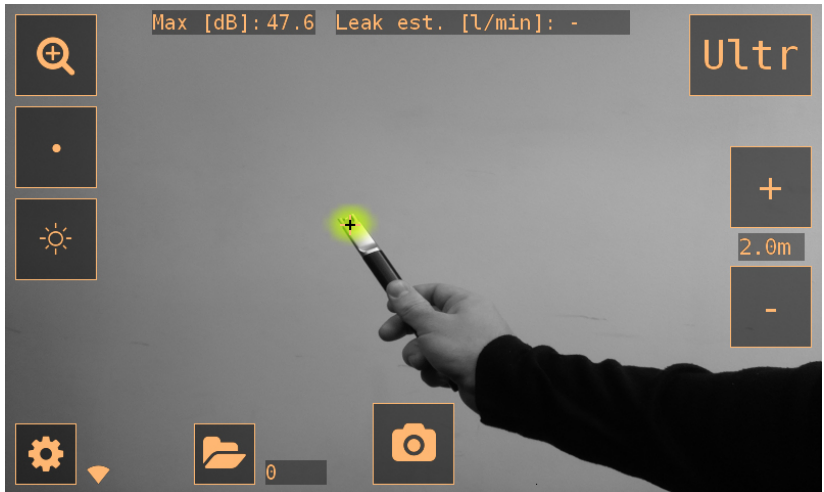

8.1 Heatmap

The main view of the user interface shows the camera image with a heatmap overlaid on top. The heatmap shows the location of the strongest sound source (single-source mode) or multiple sound sources (multi-source mode). There are two different types of color modes for displaying the heatmap.



Location color mode



Strength color mode

The *location* color mode shows each sound source with several different colors, ranging from blue to red. The center of the sound sources is shown with red color, while the color gradually changes via yellow, green, and cyan to blue outwards from the center of the sound source. The *location* color mode is active in the *Power* application mode.

The *strength* color mode shows each sound source with a single color according to the intensity of the sound source. The *strength* color mode is active in the *Air* application mode. (Exception: When the SLM filter is enabled in *Air* application mode, the location color mode is active.)

In addition to the heatmap, the location of the strongest sound source is shown with a small crosshair. When taking a snapshot, the sound arriving from the direction of the crosshair will be recorded. Application-specific real-time analysis will also use the sound arriving from the direction of the crosshair.

8.2 Take snapshot



Press the *snapshot* button to take a snapshot containing the current camera image and heatmap as well as a short recording of the strongest sound source. The direction of the strongest sound source is shown with a crosshair.

The record time is by default 2 seconds and can be selected by the user. When pressing the *snapshot* button, the previous 2 seconds of the sound from the strongest source will be saved. This means, that if you are observing a sporadic event, you can press the *snapshot* button immediately after you have observed it. This also means that it is recommended to keep the camera stable for a few seconds before taking a snapshot in order to get a clear signal from the source of interest.

When taking a snapshot, a keyboard will be displayed, which you can use to enter optional comments about the snapshot. After entering comments, press the button in the upper right corner to save the comments and the snapshot. If you at this stage choose not to save the snapshot, press the *garbage bin* button in the upper left corner instead.

8.3 Snapshot browser



The number of snapshots currently saved on the camera is shown to the right of the *snapshot browser* button. If there are two dots visible next to the number, snapshots are currently being uploaded to the FLIR Acoustic Camera Viewer.

Press the button to browse through the snapshots. On the bottom of the screen, thumbnails of the snapshots are shown, and you can scroll through these horizontally. When you press a thumbnail, the snapshot will be shown together with additional information.

Note Note that snapshots are not available in the snapshot browser after they have been uploaded to the FLIR Acoustic Camera Viewer service or exported to a USB memory stick.

8.4 Zoom



The camera is equipped with a 2x digital zoom, which can be used for close-up snapshots. Press the *zoom* button to zoom in or zoom out.

8.5 Single-source / multi-source mode



Press the *single-source / multi-source* button to toggle between the two modes. In single-source mode, the camera shows only the sound source with the highest intensity (with a crosshair on top). If there are multiple sound sources with the same or almost the same intensity, they will all be shown.

In multi-source mode, the camera shows multiple sound sources with different intensities. The sound source with the highest intensity will be shown with a crosshair on top. Not all sound sources will be shown. For example, if there is a very strong sound source shown, very weak sound sources will not be visible at the same time.

To see weaker sound sources (in either single-source or multi-source mode), position and rotate the camera so that stronger sound sources are outside the field of view. You can also use the *zoom* button to limit the field of view.

8.6 Screen brightness



The brightness of the display can be adjusted by pressing the *brightness* button. This is useful to make the display readable under different lighting conditions (indoors/outdoors).

8.7 Settings



Press the *settings* button to show the available settings:

- Network settings
- Change mode
- Advanced settings

8.7.1 Network settings

Press the *Upload snapshots* button to enable/disable automatic upload of snapshots to the FLIR Acoustic Camera Viewer cloud service. For more information, see section 8.12 *Cloud upload*.

Press the *Enable wifi* button to show the available wifi settings.

When pressing the *Select wifi* button, the camera will scan for nearby wifi networks. After the scan, a list of the found networks will be shown. In case the wifi network you wish to connect to doesn't show up, try moving closer to the wifi access point. Once you find and select the desired network, you will be asked to enter the wifi password. Please note that public wifi networks are not supported, only secure wifi networks are supported. The camera accepts wifi networks that require password input (not networks that require both user name and password).

An icon representing the wifi connection status and strength is shown to the right of the *settings* button:



Excellent wifi connection strength.



Good wifi connection strength.



Satisfactory wifi connection strength.



Poor wifi connection strength.



No wifi connection.

8.7.2 Change modes

Press the *Change mode* button to select the application mode; *Air* or *Power*.

8.7.3 Advanced settings

Press the *Advanced settings* button to access parameter settings for real-time analysis calculations, such as leak size and cost estimation.

8.8 Filter



Press the *filter* button to switch between different filters. The available filters depends on the selected application mode. The filters typically change the frequency range that the camera uses for showing sound sources. The same frequency range is also used when taking a snapshot and the sound is recorded.

Try the different available filter settings to see which filter serves your application best. Remember that the most appropriate filter might vary from case to case, and depend not only on the sound source of interest, but also on the background noise. For more information on choosing filters, see section 9.2 *Locating sound sources and taking snapshots*.

8.9 Distance

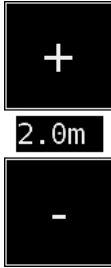

In *Air* application mode, you can use the + and - buttons to select the distance that you think is closest to the real distance of the sound source. The distance is used to compensate for the fact that the intensity of sound is reduced over distance. This information is utilized in the application-specific real-time analysis, for the calculation of the leak size estimate.

8.10 Frequency

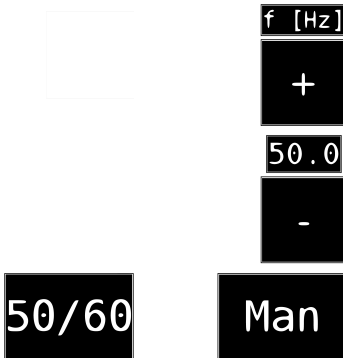

The camera automatically recognizes the power line frequencies 50 and 60 Hz. In *Power* application mode, it is possible to manually set other frequencies. Press the *frequency* button to switch between automatic and manual settings. Use the + and - buttons to select the frequency.

8.11 Real-time analysis

Real-time analysis results are shown at the top of the graphical user interface. The level in decibels of sound arriving from the strongest source (shown with a crosshair) is presented. The real-time analysis also provides additional information about problems related to the specific application.

8.12 Cloud upload

When connected to the Internet via wifi, the camera will automatically upload any snapshots on the device to the FLIR Acoustic Camera Viewer cloud service. Next to the *snapshot browser* button, the number of snapshots currently on the device is shown. Two dots next to the number indicate that snapshots are currently being uploaded to the cloud.

8.13 USB export

Snapshots on the camera can be exported to a USB memory stick. Open the USB port cover on top of the camera and insert the memory stick in the USB port. Check that the orientation of the memory stick and the port is correct before inserting the stick.

The camera will recognize the inserted memory stick and ask if you want to transfer snapshots to the USB device. If you press *Yes*, the transfer will begin. During the transfer, the progress will be displayed, and the transfer can be aborted by pressing the *Stop* button. Snapshots already transferred to the memory stick will remain on the stick and snapshots not transferred will remain on the camera. **Do not remove the memory stick from the USB port while the transfer is in progress**, as this may corrupt the file system on the memory stick. Once the transfer has been successfully completed (or aborted if the *Stop* button was pressed), the main view of the graphical user interface is shown, and the memory stick can be removed from the USB port. Remember to put the USB port cover back in place.

The snapshots transferred to the memory stick can be browsed on a computer. On the USB stick, the snapshots are organized into subfolders which can be browsed.

Snapshots transferred to a memory stick will not be automatically uploaded to the FLIR Acoustic Camera Viewer. The snapshots can, however, be uploaded at a later point in time from the memory stick or other storage location using the *Offline files* upload feature of the FLIR Acoustic Camera Viewer.

Note The top heatsink will get hot when using the camera. It is recommended that USB export is done directly after starting the device, as attempting to export the results after prolonged use might be problematic due to the hot heatsink.

8.14 Remote update

When connected to the Internet via wifi, the camera will automatically download software updates available in the FLIR Acoustic Camera Viewer. If an update has been downloaded, it will be applied the next time the camera is started. The current software version is visible when pressing the *settings* button.

8.15 USB update

In case the remote update feature cannot be used, the camera can also be updated using a USB memory stick. Place the software update file provided by FLIR Systems in the root directory of the the memory stick (i.e., not in any folder). Open the USB port cover on top of the camera and insert the memory stick in the USB port. Check that the orientation of the memory stick and the port is correct before inserting the stick.

The camera will detect the software update present on the memory stick and ask if you want to apply the update. Press *Yes* to copy the update to the camera. **Do not remove the memory stick while the update is being copied.** Once the update is on the camera, you will be asked to restart the device to apply the update. Remove the memory stick and put the USB port cover back in place. Shut the camera down by unplugging the battery cable and start it again by connecting the battery cable. The update will now be applied.

9 Usage techniques

9.1 General usage

Keep the battery inside of the carrying bag and carry the bag with the strap over your shoulder to free your hands for using the camera.

When you are not carrying the camera in your hand, always put it securely inside the carrying bag to prevent it from falling. Always put the camera inside the carrying bag when you need both hands for other tasks, such as climbing ladders. Ensure that the camera is placed in such a way inside the bag that it does not fall out.

Consult your safety officer about using the camera and the carrying bag with the strap in your facility or working environment. The strap is rigid and does not have a separate safety release mechanism, so special care should be applied around heavy machinery.

Always keep the USB port covered. Water must not enter the camera, as this will damage the electronics inside.

9.2 Locating sound sources and taking snapshots

The camera has different filters that are useful for finding different types of sound sources. These filters limit the frequency range of the sound sources that are displayed. The higher the frequency range is, the more local the sources of interest are - even in the presence of a lot of background noise. Background noise (for example traffic or factory noise) is often dominant at low frequencies, while many interesting phenomena have a lot of energy at high frequencies.

More in depth analysis is always done on the **location of the crosshair** on the screen.

In the *single-source* mode, the camera will always show the strongest sound source in the field of view. The strongest source will depend on the currently selected filter; different filters might display different sound sources. In order to see weaker sound sources in the presence of a strong sound source, move or rotate the camera so that the strong sound source is clearly outside the field of view. You can also use the *zoom* button to limit the field of view.

In the *multi-source* mode, the camera will show not only the strongest sound source, but also weaker sound sources. Note that sound sources considerably weaker than the strongest source will not be shown. The *multi-source* model is useful in finding weaker sound sources. If you want to examine these sources closer, you can move and rotate the camera as well as use the *zoom* button. Always keep in mind that any analysis is done in the direction of the crosshair on the display.

The camera will not only show actual physical sound sources, but also reflections from these sound sources. In order to verify that a source shown on the display is an actual sound source and not a reflection, move around to look at the source from different directions. If the location of the source remains the same from all different directions, the source is an actual sound source. If the location of the source moves along a surface (or completely disappears) when you move around, the source is probably a reflection.

The *multi-source* mode might also be useful when determining whether a source shown on the display is an actual sound source or a reflection. With the multi-source mode, you might be able to see both the actual sound source and one or several reflections, and by moving the camera around you might be able to tell which of the sources are reflections.

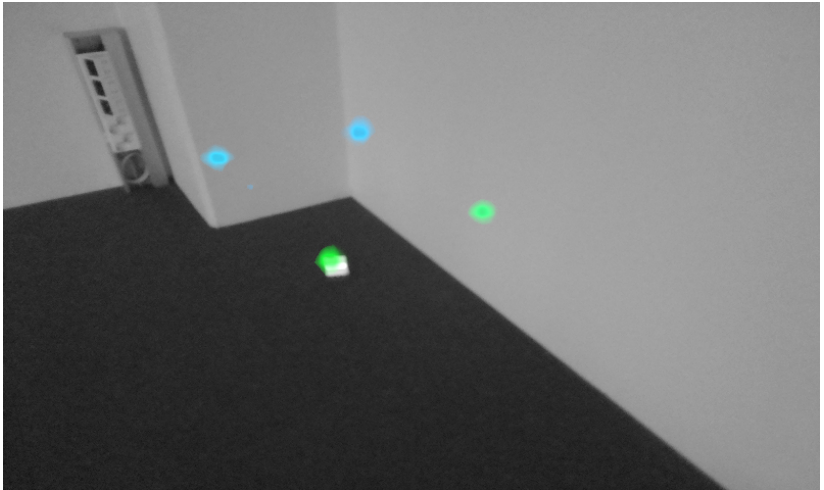

The image shows an example of one actual sound source and three reflections shown by the camera in *multi-source* mode. The actual sound source lies on the floor, while there are three reflections shown on the walls. When the camera is moved around, the location of the actual sound source remains the same, while the reflections move around on the walls, and are not seen from all angles.

Note, that if an actual sound source is large (for example a large vibrating surface), the source shown on the display might be smaller than the actual source. The source might in this case also move around as you move around the surface, depending on which point of the surface is closest to the camera. In this case, taking a snapshot and viewing it in the FLIR Acoustic Camera Viewer might help. In the FLIR Acoustic Camera Viewer, it is possible to adjust the dynamic range of the heatmap with the slider below the image. By increasing the dynamic range, you might be able to tell how large the sound source actually is.

It is often useful to take snapshots of interesting sound sources from several different directions. The exact location of the source is easier to find when viewed from different angles. Sound sources can also be directional, meaning that the sound level will differ depending on the direction.

When pressing the *snapshot* button, the sound coming from the direction of the crosshair will be saved. The default is to save 2 seconds of sound, from the moment that the *snapshot* button is pressed backwards. This means that you should keep the camera steady for a few seconds before taking a snapshot, in order to get a clear signal from the source of interest. If you observe a sporadic event, take a snapshot directly when or after you observe the event in order to record the signal of the event.

The minimum recommended sound source distance for the camera is approximately 0.3 meters. If the distance is shorter than this, the location of sound sources will not be accurately displayed. In addition, the optical camera will not be focused at such short distances.

There is no specific upper limit for the distance at which the camera can be used. In practical cases, the distance is often limited to approximately 100 meters, but strong sound sources in an otherwise quiet environment can be detected at even larger distances. Respectively, weak sound sources usually require closer proximity.

10 FLIR Acoustic Camera Viewer

The FLIR Acoustic Camera Viewer cloud service expands your sound imaging experience by offering various analysis methods for the sound image and the signal. It also serves as a storage for snapshots taken, and can be used for generating reports.

To access the FLIR Acoustic Camera Viewer services, use a modern web browser and enter the following address:

<https://si124viewer.flir.com/>

Log in using the username and password provided with the camera. If you have lost your login information, please contact FLIR Customer Support Center.

10.1 Browse through snapshots

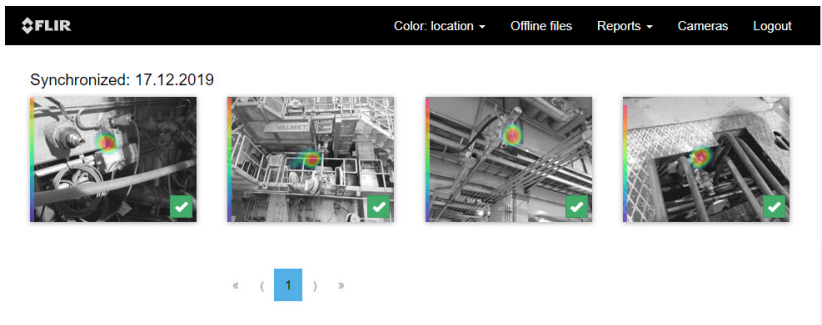

Once logged in to the FLIR Acoustic Camera Viewer, the main view lists the snapshots taken with the currently selected camera or cameras. The snapshots are ordered by date, from newest to oldest. Each page shows a limited number of snapshots, and you can navigate back and forth through the pages using the number and arrow links at the bottom of the page. When moving the cursor on top of a snapshot, you will see the comments that were entered when the snapshot was taken. If no comments were entered when the snapshot was taken, the device-generated label will be shown instead. Symbols that might be displayed on top of the snapshots are related to application-specific analysis. On the left side of the each snapshot a colorbar is shown. The height of the colorbar represents the sound level.

10.2 Snapshot view

Color: location ▾ Offline files Reports ▾ Cameras Logout

[List](#) / Snapshot

pk8

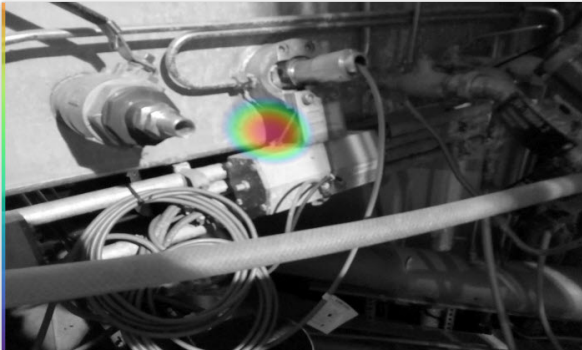

Range:

Measured dB(Z):
73.6 dB

Signal last 100ms:

Time ▾

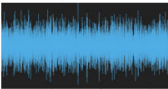

0 ms 30 ms 60 ms 90 ms
Δf: 15000Hz — 31250Hz

Possible leak

Distance: m away

17 l/min
€ 170 €/y
For pressurized air.

Comments

Save comments

Properties:

When clicking on a snapshot in the main view of the FLIR Acoustic Camera Viewer, a view of that snapshot will be opened. On the upper left you can see the camera image and the acoustic heatmap overlaid on top of it. Above the image, the comments entered when taking the snapshot are shown. If no comments were entered, the device-generated label is shown instead. On the left side of the image a colorbar is shown. The height of the colorbar represents the sound level, which also is shown to the right of the image (*Measured dB(Z)*).

Underneath the image, there is a range slider that can be used to adjust the dynamic range of the acoustic heatmap. Increase the range to the left to view the extent of large sound sources, or to see weaker sound sources when

there are stronger sound sources present. More exact estimates of the sound source location are shown when the range is adjusted to the right.

Below the image, there is a field for entering and updating comments. Click on *Save comments* to save the new or updated comments.

Below the field for comments, additional properties of the snapshot are listed. Below these, there is a button for deleting the snapshot.

To the right of the image, below the sound level, there is a view of the last 100 ms of the sound signal from the dominant source in the image (i.e. the location of the crosshair when taking the picture). You can choose between five different ways to visualize the signal:

- Time: amplitude of the signal as a function of time
- FFT: magnitude spectrum of the signal
- Spect: magnitude spectrum of the signal as a function of time
- Cepstrum: cepstrum of the signal
- Autocorrelation: autocorrelation of the signal

Below the signal view, application-specific analysis results are shown, if available.

10.3 Color mode

On top of the screen, there is the possibility to choose between two different color modes for displaying the snapshot heatmap: *location* and *strength*.

The *location* color mode shows each sound source with several different colors, ranging from blue to red. The center of the sound sources is shown with red color, while the color gradually changes via yellow, green, and cyan to blue outwards from the center of the sound source.

The *strength* color mode shows each sound source with a single color according to the intensity of the sound source.

10.4 Offline file upload

To upload snapshots from a USB memory stick to the FLIR Acoustic Camera Viewer for storage and further analysis, click on the *Offline files* button on top of the screen. Either drag and drop the files into the designated area or select the files to upload by first clicking the link. The snapshot files that should be uploaded have the *nlz* extension on the USB memory stick.

Once you have selected the files you want to upload, click on the *Upload Files* button to start the upload. Once the upload is done, it might take a few minutes until the new snapshots are visible in the snapshot list.

10.5 Report generation

To generate a PDF report of a group of snapshots, first select the snapshots by clicking on the checkbox in the lower right corner of each snapshot shown in the list. By clicking on the *Reports* menu on top of the screen, you also have the possibility to select all snapshots taken with the currently selected cameras, or to deselect all snapshots.

Once you have selected the snapshots you want to include in the report, click on the *Reports* menu and then choose *Generate...* A list of the selected snapshots will be shown, and you can choose how the snapshots should be ordered and which date format should be used. Click on *Generate Report* to create the PDF report. The report generation will take some time, depending on the number of snapshots, and the progress will be shown. Once the report has been generated, click on the *Save* button to download the report.

10.6 Camera selection

At the top of the screen, click on the *Cameras* menu to show a dialog where you can select all or some of the cameras available for you. Select one or several cameras to browser through the snapshots taken with these cameras.



Website

<http://www.flir.com>

Customer support

<http://support.flir.com>

Copyright

© 2020, FLIR Systems, Inc. All rights reserved worldwide.

Disclaimer

Specifications subject to change without further notice. Models and accessories subject to regional market considerations. License procedures may apply. Products described herein may be subject to US Export Regulations. Please refer to exportquestions@flir.com with any questions.

Publ. No.: T810536
Release: AB
Commit: 63437
Head: 63437
Language: en-US
Modified: 2020-02-03
Formatted: 2020-02-03



T810536