



California Instruments

BPS Series AC Power Source User Manual

User Manual

California Instruments - AC Power Source

AMETEK Programmable Power.

Models:

- BPS30-1
- BPS30-3
- BPS45-1
- BPS45-3
- BPS75-3
- BPS90-3
- BPS150-3
- BPS180-3

About AMETEK

AMETEK Programmable Power, Inc., a Division of AMETEK, Inc., is a global leader in the design and manufacture of precision, programmable power supplies for R&D, test and measurement, process control, power bus simulation and power conditioning applications across diverse industrial segments. From bench top supplies to rack-mounted industrial power subsystems, AMETEK Programmable Power is the proud manufacturer of Elgar, Sorensen, California Instruments and Power Ten brand power supplies.

AMETEK, Inc. is a leading global manufacturer of electronic instruments and electromechanical devices with annualized sales of \$3.3 billion. The Company has over 11,000 colleagues working at more than 80 manufacturing facilities and more than 80 sales and service centers in the United States and around the world.

Trademarks

AMETEK is a registered trademark of AMETEK, Inc. California Instruments is a trademark owned by AMETEK, Inc. Other trademarks, registered trademarks, and product names are the property of their respective owners and are used herein for identification purposes only.

Notice of Copyright

BPS Series User Manual © 2013 AMETEK Programmable Power, Inc. All rights reserved.

Exclusion for Documentation

UNLESS SPECIFICALLY AGREED TO IN WRITING, AMETEK PROGRAMMABLE POWER, INC. ("AMETEK"):

- (a) MAKES NO WARRANTY AS TO THE ACCURACY, SUFFICIENCY OR SUITABILITY OF ANY TECHNICAL OR OTHER INFORMATION PROVIDED IN ITS MANUALS OR OTHER DOCUMENTATION.
- (b) ASSUMES NO RESPONSIBILITY OR LIABILITY FOR LOSSES, DAMAGES, COSTS OR EXPENSES, WHETHER SPECIAL, DIRECT, INDIRECT, CONSEQUENTIAL OR INCIDENTAL, WHICH MIGHT ARISE OUT OF THE USE OF SUCH INFORMATION. THE USE OF ANY SUCH INFORMATION WILL BE ENTIRELY AT THE USER'S RISK, AND
- (c) REMINDS YOU THAT IF THIS MANUAL IS IN ANY LANGUAGE OTHER THAN ENGLISH, ALTHOUGH STEPS HAVE BEEN TAKEN TO MAINTAIN THE ACCURACY OF THE TRANSLATION, THE ACCURACY CANNOT BE GUARANTEED. APPROVED AMETEK CONTENT IS CONTAINED WITH THE ENGLISH LANGUAGE VERSION, WHICH IS POSTED AT WWW.PROGRAMMABLEPOWER.COM.

Date and Revision

June 2013, Revision A

Part Number

M440077-01

Contact Information

Telephone: 800 733 5427 (toll free in North America)
858 450 0085 (direct)



Fax: 858 458 0267

Email: sales.ppd@ametek.com
service.ppd@ametek.com

Web: www.programmablepower.com

Important Safety Instructions

Before applying power to the system, verify that your product is configured properly for your particular application.

 WARNIN G	<p>Hazardous voltages may be present when covers are removed. Qualified personnel must use extreme caution when servicing this equipment. Circuit boards, test points, and output voltages also may be floating above (below) chassis ground.</p>
 WARNIN G	<p>The equipment used contains ESD sensitive parts. When installing equipment, follow ESD Safety Procedures. Electrostatic discharges might cause damage to the equipment.</p>

Only *qualified personnel* who deal with attendant hazards in power supplies, are allowed to perform installation and servicing.

Ensure that the AC power line ground is connected properly to the Power Rack input connector or chassis. Similarly, other power ground lines including those to application and maintenance equipment *must* be grounded properly for both personnel and equipment safety.













Always ensure that facility AC input power is de-energized prior to connecting or disconnecting any cable.

In normal operation, the operator does not have access to hazardous voltages within the chassis. However, depending on the user's application configuration, **HIGH VOLTAGES HAZARDOUS TO HUMAN SAFETY** may be normally generated on the output terminals. The customer/user must ensure that the output power lines are labeled properly as to the safety hazards and that any inadvertent contact with hazardous voltages is eliminated.

Guard against risks of electrical shock during open cover checks by not touching any portion of the electrical circuits. Even when power is off, capacitors may retain an electrical charge. Use safety glasses during open cover checks to avoid personal injury by any sudden component failure.

Neither AMETEK Programmable Power Inc., San Diego, California, USA, nor any of the subsidiary sales organizations can accept any responsibility for personnel, material or inconsequential injury, loss or damage that results from improper use of the equipment and accessories.

SAFETY SYMBOLS

	<p>WARNING Risk of Electrical Shock</p>		<p>CAUTION Refer to Accompanying Documents</p>
	<p>Off (Supply)</p>		<p>Direct Current (DC)</p>
	<p>Standby (Supply)</p>		<p>Alternating Current (AC)</p>
	<p>On (Supply)</p>		<p>Three-Phase Alternating Current</p>
	<p>Protective Conductor Terminal</p>		<p>Earth (Ground) Terminal</p>
	<p>Fuse</p>		<p>Chassis Ground</p>

Product Family: BPS Series AC Power Source

Warranty Period: 1 Year

WARRANTY TERMS

AMETEK Programmable Power, Inc. ("AMETEK"), provides this written warranty covering the Product stated above, and if the Buyer discovers and notifies AMETEK in writing of any defect in material or workmanship within the applicable warranty period stated above, then AMETEK may, at its option: repair or replace the Product; or issue a credit note for the defective Product; or provide the Buyer with replacement parts for the Product.

The Buyer will, at its expense, return the defective Product or parts thereof to AMETEK in accordance with the return procedure specified below. AMETEK will, at its expense, deliver the repaired or replaced Product or parts to the Buyer. Any warranty of AMETEK will not apply if the Buyer is in default under the Purchase Order Agreement or where the Product or any part thereof:

- is damaged by misuse, accident, negligence or failure to maintain the same as specified or required by AMETEK;
- is damaged by modifications, alterations or attachments thereto which are not authorized by AMETEK;
- is installed or operated contrary to the instructions of AMETEK;
- is opened, modified or disassembled in any way without AMETEK's consent; or
- is used in combination with items, articles or materials not authorized by AMETEK.

The Buyer may not assert any claim that the Products are not in conformity with any warranty until the Buyer has made all payments to AMETEK provided for in the Purchase Order Agreement.

PRODUCT RETURN PROCEDURE

Request a Return Material Authorization (RMA) number from the repair facility (**must be done in the country in which it was purchased**):

- **In the USA**, contact the AMETEK Repair Department prior to the return of the product to AMETEK for repair:
Telephone: 800-733-5427, ext. 2295 or ext. 2463 (toll free North America)
858-450-0085, ext. 2295 or ext. 2463 (direct)
- **Outside the United States**, contact the nearest Authorized Service Center (ASC). A full listing can be found either through your local distributor or our website, www.programmablepower.com, by clicking Support and going to the Service Centers tab.

When requesting an RMA, have the following information ready:

- Model number
- Serial number
- Description of the problem

NOTE: Unauthorized returns will not be accepted and will be returned at the shipper's expense.

NOTE: A returned product found upon inspection by AMETEK, to be in specification is subject to an evaluation fee and applicable freight charges.

Table of Contents

1.	Introduction	11
1.1	General Description.....	11
1.2	Manual Organization and Format.....	11
2.	Specifications.....	12
2.1	Electrical.....	12
2.1.1	<i>Input</i>	12
2.1.2	<i>Output</i>	13
2.1.3	<i>AC Measurements</i>	15
2.1.4	<i>System Specification</i>	16
2.1.5	<i>Unit Protection</i>	17
2.2	Mechanical.....	17
2.3	Environmental	18
2.4	Regulatory.....	18
2.5	Front Panel Controls.....	18
2.6	Special Features and Options.....	19
2.6.1	<i>-HV Option Specifications</i>	20
2.6.2	<i>-LF Option Specifications</i>	22
2.7	Supplemental Specifications.....	22
2.7.1	<i>Output</i>	22
2.7.2	<i>Acoustic Noise Levels</i>	22
3.	Unpacking and Installation – BPS30 and BPS45 Models.....	23
3.1	Unpacking.....	23
3.2	Power Requirements.....	23
3.3	Mechanical Installation.....	24
3.4	AC Input Connections and Wiring	24
3.5	AC On/Off Circuit Breaker on BPS Series front panel.....	28
3.6	Output Connections.....	30
3.6.1	<i>Output Wiring</i>	30
3.6.2	<i>Output Terminal Blocks</i>	32
3.6.3	<i>BPS30-1, BPS45-1 - 1 ϕ mode Output Wiring Diagram</i>	33
3.6.4	<i>BPD30-3, BPS45-3 3ϕ mode Output Wiring Diagram</i>	34
4.	Unpacking and Installation – BPS75 / BPS90 / BPS150 and BPS180 Models.....	35
4.1	Unpacking.....	35
4.2	Power Requirements.....	35
4.3	Mechanical Installation.....	37
4.4	AC Input Connections and Wiring	37
4.5	AC On/Off Circuit Breaker on BPS Series front panel.....	40
4.6	Output Connections.....	42
4.6.1	<i>Output Wiring</i>	42
4.6.2	<i>Output Terminal Blocks</i>	44
4.6.3	<i>Output Wiring Diagram</i>	45
4.6.4	<i>BPS150-3 or BPS180-3 Parallel Output Wiring Diagram</i>	46
4.6.5	<i>Multi-Chassis Output Connections</i>	47
4.7	Connectors - Rear Panel.....	48
4.7.1	<i>System Interface</i>	48
4.7.2	<i>Analog Input Connector</i>	49
4.7.3	<i>BNC Connectors</i>	50
4.7.4	<i>External Sense Connector</i>	50
4.7.5	<i>RS232C Serial Interface Connector</i>	51
4.7.6	<i>USB Interface</i>	52
4.7.7	<i>LAN Interface – RJ45</i>	53
4.8	Multiple Cabinet Power Up/Down Procedures	54
4.8.1	<i>Power Up Procedure</i>	54
4.8.2	<i>Power Down Procedure</i>	54

4.9	Basic Initial Functional Test	55
4.10	Remote Inhibit / Remote Shutdown	56
5.	Front Panel Operation	58
5.1	Tour of the Front Panel	58
5.1.1	<i>Front Panel Controls and Indicators</i>	58
5.1.2	<i>System On/Off Circuit Breaker</i>	58
5.1.3	<i>Status Indicator Lights</i>	59
5.1.4	<i>The Shuttle Knob</i>	60
5.1.5	<i>FUNCTION Keypad</i>	61
5.1.6	<i>DECIMAL KEYPAD</i>	63
5.1.7	<i>LCD Display</i>	64
5.2	Menu Structure	65
5.2.1	<i>MAIN Menus</i>	65
5.2.2	<i>Overview of Menu 1</i>	67
5.2.3	<i>Overview of Menu 2 and 3</i>	68
5.2.4	<i>PROGRAM Menu</i>	69
5.2.5	<i>MEASUREMENTS Screens</i>	71
5.2.6	<i>TRANSIENTS Menu</i>	73
5.2.7	<i>SETUP REGISTERS Menu</i>	80
5.2.8	<i>UTILITY Menus</i>	82
5.2.9	<i>MEASUREMENT CAL FACTORS Menu</i>	91
5.2.10	<i>OUTPUT CAL FACTORS Menu</i>	92
5.3	Output Programming	93
5.3.1	<i>Set the Output</i>	93
5.3.2	<i>Slewing Output Values with the Knob in IMMEDIATE Mode</i>	93
5.3.3	<i>Change Output Values with the Knob in SET Mode</i>	93
5.3.4	<i>Change Output Values with the shuttle knob from the MEASUREMENT 1 screen</i>	94
5.4	Standard Measurements	94
5.4.1	<i>Standard Controller Measurements</i>	94
5.4.2	<i>Controller Measurements</i>	96
5.4.3	<i>Accuracy Considerations</i>	96
5.4.4	<i>Triggering Measurements</i>	97
5.5	Transient Programming	102
5.5.1	<i>Introduction</i>	102
5.5.2	<i>Using Transient Modes</i>	102
5.5.3	<i>Step Transients</i>	102
5.5.4	<i>Pulse Transients</i>	103
5.5.5	<i>List Transients</i>	104
5.5.6	<i>Programming Slew Rates</i>	106
5.5.7	<i>Transient Execution</i>	107
5.5.8	<i>Saving Transient List Programs</i>	107
6.	Principle of Operation	108
6.1	General	108
6.2	Overall Description	109
6.3	Controller Assembly	110
6.3.1	<i>CPU Controller</i>	110
6.3.2	<i>Keyboard / Display Board</i>	110
6.3.3	<i>GPIB / RS232 or GPIB / RS232 / USB / LAN IO Board</i>	110
6.4	System Interface Board	113
6.5	Current / Voltage Sensor Board	113
6.6	Low Voltage Power Supply	113
6.7	Power Module	113
6.7.1	<i>PFC Input Power Converter</i>	115
6.7.2	<i>Modulator Board</i>	115
6.7.3	<i>Amplifier Boards</i>	116
6.7.4	<i>Filter Boards</i>	117
6.7.5	<i>Fan Supply Board</i>	117

6.7.6	<i>Output Snubber Board</i>	117
7.	Calibration	119
7.1	Recommended Calibration Equipment	119
7.2	Front Panel Calibration Screens	120
7.3	Routine Measurement Calibration	121
7.3.1	<i>Measurement Cal - AC</i>	125
7.3.2	<i>Measurement Calibration Summary</i>	125
7.4	Routine Output Calibration	126
7.4.1	<i>Output Cal</i>	127
7.4.2	<i>Three Phase Mode</i>	128
7.4.3	<i>Phase Angle Calibration</i>	128
7.4.4	<i>Output Calibration Summary</i>	128
7.5	Non-Routine Calibration	129
7.5.1	<i>Power Source Gain Adjustment</i>	129
8.	Service	131
8.1	Cleaning	131
8.2	General	131
8.3	Basic operation	131
8.3.1	<i>Excessive Output Voltage</i>	131
8.3.2	<i>Poor Output Voltage Regulation</i>	131
8.3.3	<i>Overload Light is On</i>	132
8.3.4	<i>Distorted Output</i>	132
8.3.5	<i>Unit Shuts Down after 1-2 Seconds</i>	132
8.3.6	<i>No Output and No Lights on Front Panel</i>	132
8.3.7	<i>No Output But Front Panel controller is active</i>	132
8.4	Advanced Troubleshooting	133
8.4.1	<i>Switch Off Unit</i>	133
8.4.2	<i>Removing Covers</i>	133
8.4.3	<i>Initial Inspection</i>	133
8.4.4	<i>Fuse Check</i>	133
8.4.5	<i>Power-on Troubleshooting Using the LED's</i>	134
8.4.6	<i>Other No Output Conditions</i>	134
8.5	Factory Assistance	135
8.6	Fuses	136
8.7	Firmware Updates	137
8.7.1	<i>Requirements</i>	137
8.7.2	<i>Download Instructions</i>	137
8.7.3	<i>Flash download Messages</i>	139
9.	Top Assembly Replaceable Parts – BSP30 and BPS45 Models	140
10.	Top Assembly Replaceable Parts – BPS75, BPS90, BPS150 and BPS180 Models	143
11.	Options	145
11.1	Introduction	145
11.1.1	<i>Option -HV: Additional AC Voltage Range</i>	145
11.1.2	<i>Option -ES: Emergency Stop Push Button</i>	145
12.	Error Messages	146

List of Figures

Figure 2-1: Sample BPS90 Voltage / Current Rating Chart for 150/300 V AC Ranges – Derated. 15

Figure 2-2: Sample BPS90 Voltage / Current Rating Chart, -HV Option – Max. Rating..... 21

Figure 2-3: Sample BPS90 Voltage / Current Rating Chart, -HV Option – Derated..... 21

Figure 3-1: The BPS30 or BPS45 Power Source 23

Figure 3-2: Location of BPS30 and BPS45 AC Input Fuse Block and Chassis Ground Connection - Front View, Panel
Removed..... 25

Figure 3-3: BPS30 and BPS45 Series AC Input Connection Diagram (Rear view)..... 27

Figure 3-4: BPS30 or BSP45 Rear Panel 29

Figure 3-5: External sense cable shield connection to chassis ground 30

Figure 3-6: Location of BPS30 and BPS45 Output Terminals (Front view) 32

Figure 3-7: BPS30-1 / BPS45-1 Output Wiring (**Rear view**)..... 33

Figure 3-8: BPS30-3 / BPS45-3 Output Wiring (**Rear view**)..... 34

Figure 4-1: BPS75/BPS90 Power Source Photo..... 36

Figure 4-2: Location of BPS75 and BPS90 AC Input Connection Block (TB3) and Chassis Ground Connection 38

Figure 4-3: BPS75-3 or BPS90-3 AC Input Connection Diagram (Rear view)..... 39

Figure 4-4: BPS75-3 or BPS90-3 Rear Panel – External Sense connector location. 41

Figure 4-5: External sense cable shield connection to chassis ground 42

Figure 4-6: Location of Output Terminals (Rear view)..... 44

Figure 4-7: BPS75-3 or BPS90-3 Output Wiring (Rear panel view)..... 45

Figure 4-8: BPS150-3 or BPS180-3 - 2 Chassis Output Wiring (Rear view) 46

Figure 4-9: Ship kit Terminal Block dimensions..... 47

Figure 4-10: USB Connector pin orientation..... 52

Figure 4-11: Functional Test Setup. 56

Figure 5-1: Shuttle Knob..... 60

Figure 5-2: FUNCTION Keypad..... 61

Figure 5-3: Entering Values from the Decimal Keypad 63

Figure 5-4: Cursor UP Key Movement 63

Figure 5-5: Cursor DOWN key Movement 64

Figure 5-6: Main Menu 1 Screen..... 64

Figure 5-7: Menu 1 through 3 65

Figure 5-8: PROGRAM Menu 69

Figure 5-9: MEASUREMENTS Screen, Single Phase and Three Phase Modes..... 71

Figure 5-10: TRANSIENTS Menu..... 73

Figure 5-11: VOLTAGE SURGE/SAG SETUP Screen 74

Figure 5-12: VOLTAGE SWEEP/STEP SETUP Screen 76

Figure 5-13: FREQUENCY SWEEP/STEP SETUP Screen 78

Figure 5-14 VOLTAGE/FREQUENCY SWEEP/STEP SETUP Screen..... 79

Figure 5-15:START/VIEW TRANSIENT SEQUENCE Screen..... 80

Figure 5-16: SETUP REGISTERS Menu..... 80

Figure 5-17: UTILITY Menus..... 82

Figure 5-18: GPIB/RS232 SETUP Menu..... 85

Figure 5-19: VOLTAGE/CURRENT CONTROL SETUP Menu..... 86

Figure 5-20: INITIAL SETUP Menus..... 87

Figure 5-21: LIMIT SETUP Menu..... 89

Figure 5-22: CONFIGURATION SETUP Menus..... 90

Figure 5-23: MEASUREMENT CAL FACTORS Menu 91

Figure 5-24: OUTPUT CAL FACTORS Menu (Series II only)..... 92

Figure 5-26: SET VOLT Trigger Source Acquisition 98

Figure 5-27: Positive Trigger Delay (Post Trigger Data) 100

Figure 5-28: Negative Trigger Delay (Pre-Trigger Data)..... 101

Figure 5-29: Pulse Transients 103

Figure 5-30: List Transients 104

Figure 5-31: START/VIEW TRANSIENT SEQUENCE Menu 107

Figure 6-1: BPS Series Functional Block Diagram 108

Figure 6-2: BPS90 Series Detailed Block Diagram..... 111

Figure 6-3: Power Module Detailed Block Diagram..... 112

Figure 6-4: Power Module Layout 114

Figure 6-5: Amplifier Board Layout 116

Figure 7-1: Sample Voltage Calibration Setup BPS75 or BPS90 (Rear view)..... 121

Figure 7-2: Sample BPS 90 Current Measurement Calibration Setup (Rear view) 123

Figure 7-3: DC offset AC filter 126

List of Tables

Table 3-1: Suggested Input Wiring Sizes for each BPS Cabinet *	28
Table 3-2: Suggested Output Wiring Sizes *	31
Table 3-3: Output Terminal connections.	32
Table 4-1: Suggested Input Wiring Sizes for each RS Cabinet *	40
Table 4-2: Suggested Output Wiring Sizes*	43
Table 4-3: Output Terminal connections.	44
Table 4-4: System Interface Connectors	49
Table 4-5: Analog Interface Connector	49
Table 4-6: BNC Connectors	50
Table 4-7: BNC Connectors	50
Table 4-8: External Sense Connector	50
Table 4-9: RS232 Connector pin out – BPS Series with RS232 and USB.	51
Table 4-10: USB Connector pin out.	52
Table 4-11: RJ45 LAN Connector pin out.	53
Table 4-12: Remote Inhibit Mode Settings	57
Table 7-1: Sample BPS45/90/180 Calibration Load Resistance and Power Values	124
Table 7-2: Measurement Calibration Table -	125
Table 7-3: Output Calibration Table – BPS Series	128
Table 8-1: Basic Symptoms	131
Table 8-2: BPS75 and BPS90 Fuse Ratings	136
Table 8-3: Flash Down load Messages	139
Table 9-1: Replaceable Parts	140
Table 9-2: Fuses	Error! Bookmark not defined.
Table 10-1& 8-2: Replaceable Parts & Fuses	143
Table 12-1: Error Messages	150

1. Introduction

This instruction manual contains information on the installation, operation, calibration and maintenance for the California Instruments BPS Series power sources with the programmable controller.

1.1 General Description

The BPS Series AC power source systems are high efficiency, floor standing AC bulk power sources that provide a precise output with low distortion. Available voltage ranges are 0-150 Vac, 0-300 Vac and 0-400 Vac in AC mode. Various models are available that can provide either single or three phase output power levels in an AC only mode of operation.

All BPS models provide interface features such as a standard RS232C, USB, IEEE-488 interfaces and an available LAN option.

The BPS Series units are contained in a floor standing enclosure on casters. This allows the units to be moved around more easily.

Read the installation instructions carefully before attempting to install and operate the BPS Series power systems. If you have any questions or concerns please contact the factory prior to applying power to the system.

1.2 Manual Organization and Format

All user documentation for California Instruments power sources is provided on CDROM in electronic format. (Adobe Portable Document Format) The required Adobe PDF viewer is available for download from the www.adobe.com website. This manual may be printed for personal use if a hardcopy is desired. To request a hardcopy from AMETEK Programmable Power, contact customer service at service.ppd@ametek.com. There will be a charge for providing printed manuals.

This manual contains sections on installation, normal use, maintenance and calibration. If the BPS system is equipped with a GPIB, RS232C, USB or LAN interface, refer to the BPS Programming manual for information on using the remote control interfaces and command syntax. The programming manual is provided on the same CDROM as this user manual.

2. Specifications

Specifications shown are valid over an ambient temperature range of $25 \pm 5^\circ \text{C}$ and apply after a 30 minute warm-up time. Unless otherwise noted, all specifications are per phase for sine wave output into a resistive load. For three phase configurations or mode of operation, all specifications are for Line to Neutral (L-N) and phase angle specifications are valid under balanced load conditions only.

2.1 Electrical

2.1.1 Input

Parameter	BPS30	BPS45	BPS75	BPS90	BPS150	BPS180
Line Voltage: (3 phase, 3 wire + ground (PE))	208 V _{LL} $\pm 10\%$ 230 V _{LL} $\pm 10\%$ 400 V _{LL} $\pm 10\%$ 480 V _{LL} $\pm 10\%$					
Line VA:	37 KVA	53 KVA	88 KVA	106 KVA	176KVA	212 KVA
Line Current:	116 A _{RMS} @ 187 V _{LL} 105 A _{RMS} @ 207 V _{LL} 60 A _{RMS} @ 360 V _{LL} 50 A _{RMS} @ 432 V _{LL}	175 A _{RMS} @ 187 V _{LL} 157 A _{RMS} @ 207 V _{LL} 90 A _{RMS} @ 360 V _{LL} 75 A _{RMS} @ 432 V _{LL}	292 A _{RMS} @ 187 V _{LL} 261 A _{RMS} @ 207 V _{LL} 150 A _{RMS} @ 360 V _{LL} 125 A _{RMS} @ 432 V _{LL}	350 A _{RMS} @ 187 V _{LL} 314 A _{RMS} @ 207 V _{LL} 180 A _{RMS} @ 360 V _{LL} 150 A _{RMS} @ 432 V _{LL}	Each BPS150 chassis requires its own AC service. Total Line currents are 2 x BPS150	Each BPS180 chassis requires its own AC service. Total Line currents are 2 x BPS90
Line Frequency:	47-63 Hz					
Efficiency:	85 % (typical) depending on line and load					
Power Factor:	0.95 (typical) / 0.99 at full power.					
Inrush Current:	230 A _{pk} @ 208 V _{LL} 220 A _{pk} @ 230 V _{LL} 132 A _{pk} @ 400 V _{LL} 110 A _{pk} @ 480 V _{LL}	230 A _{pk} @ 208 V _{LL} 220 A _{pk} @ 230 V _{LL} 132 A _{pk} @ 400 V _{LL} 110 A _{pk} @ 480 V _{LL}	460 A _{pk} @ 208 V _{LL} 440 A _{pk} @ 230 V _{LL} 264 A _{pk} @ 400 V _{LL} 220 A _{pk} @ 480 V _{LL}	460 A _{pk} @ 208 V _{LL} 440 A _{pk} @ 230 V _{LL} 264 A _{pk} @ 400 V _{LL} 220 A _{pk} @ 480 V _{LL}	Each BPS150 chassis requires its own AC service. Total Peak currents are 2 x BPS75	Each BPS180 chassis requires its own AC service. Total Peak currents are 2 x BPS90
Hold-Up Time:	> 10 ms					
Isolation Voltage:	2200 VAC input to output 1350 VAC input to chassis					

2.1.2 Output

Note: All specifications are for AC unless otherwise indicated.

Output Parameter	BPS30	BPS45	BPS75	BPS90	BPS150	BPS180
Modes:	Single or three phase depending on model.					
Voltage:						
Ranges (L-N):						
AC Mode	Low: 0 - 150 V / High: 0 - 300 V, (0-400V optional)					
Resolution:						
AC Mode	0.1 V					
Accuracy:	± 0.3 V < 100Hz, ± 0.6 V > 100Hz, AC mode ± 1 V DC mode From 5% V range to 100% of V range, RMS bandwidth < 10KHz					
Distortion THD ¹ : (Resistive full load, normal mode)	< 0.5 % @ 16 - 66 Hz < 1.00 % @ 66 - 500 Hz < 1.25 % @ > 500 Hz					
Load Regulation:	0.25 % FS @ DC - 100 Hz 0.5 % FS @ > 100 Hz					
Line Regulation:	0.1% for 10% input line change					
DC Offset Voltage:	< 20 mV					
Output Noise: (20 kHz to 1 MHz)	< 2 V _{RMS} low V Range < 3 V _{RMS} high V Range					
Output Coupling	AC coupled all voltage ranges.					
Power: (total power for all phases, either range, at full scale voltage, maximum ambient T = 35° C)						
AC Mode	30 KVA	45 KVA	75 KVA	90 KVA	150 KVA	180 KVA
Current:						
Note: Current, maximum amps indicated per phase available between 50 and 100 % of voltage range. Maximum ambient temperature for full power operation at full-scale voltage is 35° C.						
AC Mode Single Phase	BPS30-1, single phase V Lo: 200A V Hi: 100A	BPS45-1, single phase V Lo: 300A V Hi: 150A	N/A	N/A	N/A	N/A
AC Mode Three Phase	BPS30-3, per phase V Lo: 67A V Hi: 34A	BPS45-3, per phase V Lo: 100A V Hi: 50A	BPS75-3, per phase V Lo: 167A V Hi: 83A	BPS90-3, per phase V Lo: 200A V Hi: 100A	BPS150-3, per phase V Lo: 333A V Hi: 167A	BPS180-3, per phase V Lo: 400A V Hi: 200A
Constant Power Mode: Operation at higher currents but constant power is possible from 80% of Voltage range (125% of max. current) declining to 100% of maximum current at 100 % of voltage range for short periods of time or at reduced ambient temp. (< 15 mins @ 30° C). See Figure 2-1 and Figure 2-4.						
Note: Current derates linearly from 50% of voltage range to 20% of specified current at 5% of voltage range						

¹ The distortion specification for the BPS Series is valid for pure (inductance < 12 uH) resistive load conditions and using a 30 KHz LP filter on distortion meter.

Output Parameter	BPS30	BPS45	BPS75	BPS90	BPS150	BPS180
Current Limit Accuracy	0.5% of full scale					
Current Limit mode	Programmable, CC or CV mode					
Repetitive Peak Current:						
<p>Note: Maximum Peak Current shown. Value shown reflects absolute peak current protection level. This level may not be reached under all load conditions. Depending on load conditions, peak current may max out at lower levels due to amplifier output impedance.</p> <p>Note: A repetitive peak current limit function is provided which will generate a fault and shut off the power supply if the peak current drawn by the load exceeds the maximum level for more than 30 seconds. During this time, the amplifier will limit the peak current at a somewhat level above the maximum level but it is not allowable to run in this mode indefinitely. This should provide sufficient time to ride through any startup/inrush load conditions.</p>						
AC Mode Single Phase	BPS30-1, single phase V Lo: 600A V Hi: 300A	BPS45-1, single phase V Lo: 900A V Hi: 450A	N/A	N/A	N/A	N/A
AC Mode Three Phase	BPS30-3, per phase V Lo: 200A V Hi: 100A	BPS45-3, per phase V Lo: 300A V Hi: 150A	BPS75-3, per phase V Lo: 500A V Hi: 250A	BPS90-3, per phase V Lo: 600A V Hi: 300A	BPS150-3, per phase V Lo:1000A V Hi: 500A	BPS180-3, per phase V Lo:1200A V Hi: 600A
Frequency						
Range:	Standard: 16 Hz - 819.0 Hz (for -HV option range, 45 Hz – 819.0 Hz) -LF option: 16 Hz - 500.0 Hz					
Resolution:	0.01 Hz from 16.00 to 81.91 Hz 0.1 Hz from 82.0 to 819.0 Hz					
Accuracy:	± 0.01 %					
Phase Relationship: (3 phase mode)						
Range:	Phase B/C relative to phase A 0.0 to 360.0°					
Resolution:	0.1°					
Accuracy:	16 Hz - 100 Hz: < 1.5° 100 Hz - 500 Hz: < 2° > 500 Hz: < 4°					
Ext. Sync Mode						
Input:	Isolated TTL input for external frequency control. Requires 5V at 5 mA for logic high.					
Accuracy:	Ext. Sync to phase A with fixed Ext. Sync Frequency input: 16 Hz - 100 Hz: < 2° 100 Hz - 500 Hz: < 3° > 500 Hz: < 4°					

Note: Output specifications apply below the Current / Voltage rating lines shown in the V/I rating chart below.

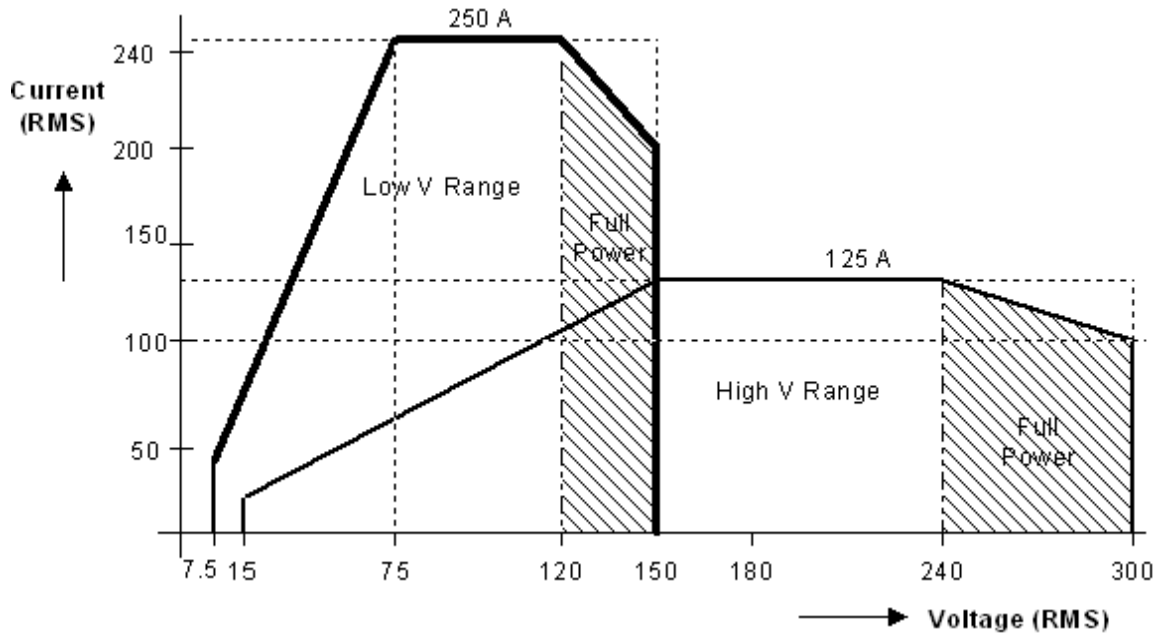

Figure 2-1: Sample BPS90 Voltage / Current Rating Chart for 150/300 V AC Ranges – Derated.

2.1.3 AC Measurements

Listed measurement specifications apply to BPS90 model only. See notes for other models and configurations.

Parameter	Range	Accuracy (±)	Resolution
Frequency	16.00 - 820.0 Hz	0.01% + 0.01 Hz	0.01 to 81.91 Hz 0.1 to 500 Hz 1 Hz above 500 Hz
RMS Voltage	0 - 300 Volts	0.1% FS, < 100 Hz 0.2% FS, > 100 Hz	0.01 Volt
RMS Current	0 - 250 Amps	0.5% FS, < 100 Hz 1.0% FS, > 100 Hz	0.1 Amp
Peak Current	0 - 750 Amps	2% FS, < 100 Hz 4% FS, > 100 Hz	0.1 Amp
VA Power per Phase	0 - 30 KVA	1% FS, < 100 Hz 2% FS, > 100 Hz	10 VA
Real Power per Phase	0 - 30 KW	1% FS, < 100 Hz 2% FS, > 100 Hz	10 W
Power Factor (>0.2kVA)	0.00 - 1.00	0.01, <100 Hz 0.02, 100-820 Hz	0.01
Note: Accuracy specifications are valid above 100 counts. For current and power measurements, specifications apply from 2% to 100% of measurement range.			
Note: Power factor accuracy applies for PF > 0.5 and VA > 50 % of max.			

2.1.4 System Specification

Parameter	Specification
External Modulation:	0 to 10%
Synchronization Input:	Isolated TTL input for external frequency control. Requires 5V at 5 mA for logic high.
Trigger Input:	External trigger source input. Requires TTL level input signal. Triggers on negative edge. Response time 80 - 100 μ s.
Trigger Output:	Programmable through transient list system. 400 μ s pulse for voltage or frequency change. Isolated TTL output. Output reverts to Function strobe when not used as Trig Out. This function is mutually exclusive with the Function Strobe output.
Function Strobe:	Active for any voltage or frequency program change. 400 μ s pulse for voltage or frequency change. Isolated TTL output. This function is mutually exclusive with the Trigger Output. Same output is used for Trigger Output if Trigger Output is programmed as part of list system.
Output Status:	Monitors status of output relay. Isolated TTL output. High if output relay is closed, low if output relay is open.
Non volatile memory storage:	16 complete instrument setups and transient lists, 100 events per list.
Waveforms	Sinewave only
Transients	Voltage: drop, step, sag, surge, sweep Frequency: step, sag, surge, sweep Voltage and Frequency: step, sweep
IEEE-488 Interface:	SH1, AH1, T6, L3, SR1, RL2, DC1, DT1 Syntax: IEEE 488.2 and SCPI Response time is 10 ms (typical)
RS232C Interface:	Bi-directional serial interface 9 pin D-shell connector Handshake: CTS, RTS Data bits: 7, 8 Stop bits: 1,2 Baud rate: 9600 to 115,200 bps Syntax: IEEE 488.2 and SCPI. Note: Disconnect any USB connection when using the RS232 interface.
USB Interface:	Standard USB 1.1 peripheral. Data transfer rate: 460,800 bps Syntax: IEEE 488.2 and SCPI. Note: Use of the USB port to control more than one power source from a single PC is not recommended, as communication may not be reliable. Use GPIB interface for multiple power source control.
LAN Interface:	Option –LAN. When the LAN interface is installed, the RS232 interface is disabled. RJ45 Connector, 10BaseT, 100BaseT or 1000BaseT, Data transfer rate: 460,800 bps Protocol: TCP/IP. Syntax: IEEE 488.2 and SCP Note: Disconnect any USB connection when using the LAN interface.
Current Limit Modes:	Two selectable modes of operation: <ol style="list-style-type: none">1. Constant current mode (voltage folds back with automatic recovery)2. Constant voltage mode with trip-off (Relays open).

2.1.5 Unit Protection

Input Over current:	In-line fast acting fuses. Check fuse rating in Service and Maintenance section. Ratings will depend on AC input configuration settings. Circuit breaker for LV supply.
Input Over voltage:	Automatic shutdown.
Input Over voltage Transients:	Surge protection to withstand EN50082-1 (IEC 801-4, 5) levels.
Output Over current:	Adjustable level constant current mode with programmable set point.
Output Short Circuit:	Peak and RMS current limit.
Over temperature:	Automatic shutdown.

2.2 Mechanical

Parameter	Specification
Dimensions: (for each BPS 30 / BPS45 chassis)	Height: 50.0" 1270 mm Width: 28.75" 731 mm Depth: 34.5" 876 mm
Unit Weight: (for each BPS30/BPS45 chassis)	Net: 1150 lbs / 522 Kg <i>approximately</i> Shipping: 1231 lbs / 560 Kg <i>approximately</i>
Dimensions: (for each BPS75 / BPS90 chassis)	Height: 74.5" 1892.3 mm Width: 30.3" 769.6 mm Depth: 38.3" 972.8 mm
Unit Weight: (for each BPS75 / BPS90 chassis)	Net: 2150 lbs / 975 Kg <i>approximately</i> 2475 lbs / 1123 Kg <i>approximately</i> Shipping: 2450 lbs / 1111 Kg <i>approximately</i> 2775 lbs / 1258 Kg <i>approximately</i>
Material:	Steel or aluminum chassis, panels and covers.
Finish:	Light textured painted external surfaces. Panels semi-gloss polyurethane color no. 26440 (medium gray)
Cooling:	Fan cooled with air intake on the front and exhaust to the rear. Fans: 14 x 225CFM. Air displacement 50 Cu Ft/sec. Max.
Internal Construction:	Modular sub assemblies.
Rear Panel Connections:	(See section 3 and 4 for description of connections) <ul style="list-style-type: none"> • Cable entry and strain relieve for AC input wiring • Cable entry and strain relieve for AC output wiring • External sense terminal block (Remote voltage sense) • System interface (2x) • RS232, USB, GPIB, LAN (option) • Trigger In BNC • Trigger Out BNC • Function Strobe BNC • Output Status

2.3 Environmental

Parameter	Specification
Operating Temp:	0° to +35° C. (Except in CP mode). +32° to +104° F.
Storage Temp:	-40° to +85 °C. -40° to +185° F.
Altitude:	< 2000 meters
Relative Humidity:	0-95 % RAH, non-condensing maximum for temperatures up to 31°C decreasing linearly to 50% at 40°C.
Installation/Over voltage Category:	II
Pollution Degree:	2
Indoor Use Only	Dry and non-conductive particulate environment.
Vibration:	Designed to meet NSTA 1A transportation levels.
Shock:	Designed to meet NSTA 1A transportation levels.

2.4 Regulatory

Electromagnetic Emissions and Immunity:	Designed to meet EN50081-2 and EN50082-2 European Emissions and Immunity standards as required for the “CE” mark.
Acoustic Noise:	75 dBA maximum at 0% to 50% load, 80 dBA maximum greater than 50% load to 100% load. Measured at one meter.
Safety:	Designed to EN 61010-1 European safety standards as required for the “CE” mark.

2.5 Front Panel Controls

Controls:	
Shuttle knob:	Allows continuous change of all values including output calibration and range change.
Decimal keypad:	A conventional decimal keypad facilitates quick entry of numerical values such as voltage, current limit, etc. The large blue enter key will make the value you enter effective. Using the SET key allows the user to preset all parameter values and update them all at once by pressing the Enter key.
Up/down arrow keys:	A set of up and down arrow keys is used to move the cursor position in all menus. This allows quick selection of the desired function or parameter.
Function keys:	Measure key will display most measurement values. Program key will show all program parameters. Output on/off key for output relay control. Phase key will switch display to show program and measured values for each phase.

Displays:	
LCD graphics display:	A large high contrast LCD display with backlight provides easy to read guidance through all setup operations. An adjustable viewing angle makes it easy to read from all practical locations.
Status indicators:	Large and bright status indicators inform the user of important power source conditions. The Remote lamp informs the user that the unit is under remote control. The Overload lamp indicates that excessive current is being drawn at the output. The Over temperature lamp illuminates when internal heat sink temperatures are too high. The Hi Range indicator is lit any time the unit is switched to the high voltage range. The Output On/Off indicator is on when the power source output relays are closed.

2.6 Special Features and Options

Controller Features	
Parallel Operation:	Two BPS75 or BPS90 units can be paralleled in a three-phase configuration (with one master controller and one auxiliary unit) for 150KVA and 180KVA systems. Only the master unit requires a controller in this setup. The auxiliary units are controlled through the system interface connector.
Controller:	Programmable controller front panel assembly.
Output Relay:	Standard output relay feature to isolate power source from the load.
Output On/Off:	The output relay can be used to quickly disconnect the load. A green status indicator displays the status of the output relay.
Firmware / Software / Hardware Options	
- HV	Adds 400 V AC only output range.
-ES	Emergency Shut off switch. This option key lock push button is installed on the front panel of the master BPS if ordered with the BPS system. When pushed in, the main AC contactor is opened disconnecting the AC input power to the BPS input transformer. Note that the controller (and LCD display) will still be powered up but no power is available to the amplifiers and there will be no output power either. The controller runs off the LV supply, which must be turned off with the front panel breaker. After the ES has been pushed, the provided key will be required to release it. Once the ES button has been released, the BPS must be powered down using the front panel circuit breaker and turned back on to start up again. Note: Do not misplace the 2 keys provided, as no duplicates are available from CI. If lost, the ES switch must be replaced. In that case, contact AMETEK Programmable Power customer service. (service.ppd@ametek.com).
-LAN	Adds Ethernet interface (RJ45 connector) for local area network connection.
-LF	Limits maximum output frequency to 500 Hz.

2.6.1 -HV Option Specifications

The -HV option provides an AC only output range of 0 to 400 Vac L-N. Specifications unique to the -HV option are shown in the table below.

Output Parameter	BPS30	BPS45	BPS75	BPS90	BPS150	BPS180
Modes:	Single or three phase depending on model.					
Voltage:						
Ranges (L-N):	0 -400 V					
Resolution:	0.1 V					
Accuracy:	± 0.25% of Full Scale / ± 1.0 Vac rms					
Output Coupling	AC only					
Power: (total power for all phases, either range, at full scale voltage)						
AC Mode	30 KVA	45 KVA	75 KVA	90 KVA	150 KVA	180 KVA
Current:						
Note: Current, maximum amps per phase available between 50 and 100 % of voltage range.						
AC Mode Single Phase	BPS30-1, 400V, single phase V Hi: 75A	BPS45-1, 400V, single phase VHi:112.5A	N/A	N/A	N/A	N/A
AC Mode Three Phase	BPS30-3, 400V, per phase V Hi: 25A	BPS45-3, 400V, per phase V Hi: 37.5A	BPS75-3, 400V, per phase V Hi: 62.5A	BPS90-3, 400V, per phase V Hi: 75A	BPS150-3, 400V, per phase V Hi: 125A	BPS180-3, 400V, per phase V Hi: 150A
Peak Current:						
AC Mode Single Phase	BPS30-1, 400V, single phase VHi: 225A	BPS45-1, 400V, single phase VHi:337.5A	N/A	N/A	N/A	N/A
AC Mode Three Phase	BPS30-3, 400V, per phase V Hi: 75A	BPS45-3, 400V, per phase VHi:112.5A	BPS75-3, 400V, per phase VHi:187.5A	BPS90-3, 400V, per phase V Hi: 225A	BPS150-3, 400V, per phase V Hi: 375A	BPS180-3, 400V, per phase V Hi: 450A
Frequency:						
Range:	45 Hz – 819 Hz with -LF option: 45 Hz – 500 Hz					

Note: Output specifications apply below the Current / Voltage rating lines shown in the following V/I rating charts.

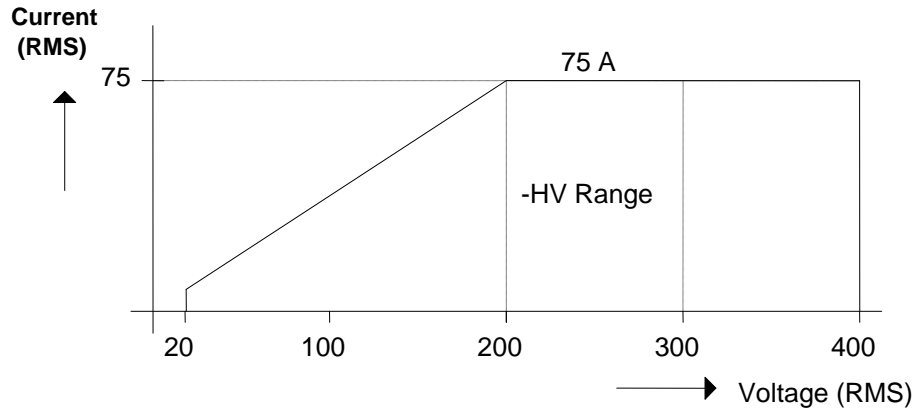

Figure 2-2: Sample BPS90 Voltage / Current Rating Chart, -HV Option – Max. Rating.

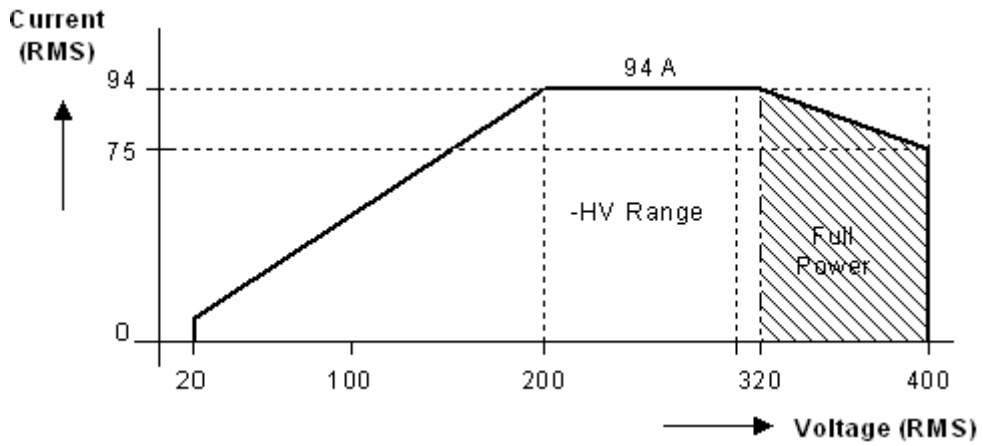

Figure 2-3: Sample BPS90 Voltage / Current Rating Chart, -HV Option – Derated.

2.6.2 -LF Option Specifications

The -LF option limits the maximum available output frequency to 500 Hz. All other specifications of the BPS system remain unchanged if this option is installed.

2.7 Supplemental Specifications

Supplemental specifications are not warranted and generally reflect typical performance characteristics. These characteristics have been checked on a type test basis only and are not verified on each unit shipped. They are provided for reference only.

2.7.1 Output

Output Parameter	BPS30 – BPS180
Voltage:	
Slew rate:	> 0.5 V/micro sec
Stability:	0.25 % over 24 hour period at constant line, load and temperature.
Settling time:	< 0.5 msec
Frequency:	
Temperature coefficient:	± 5ppm per degree C
Stability:	± 15 ppm per year
Current:	
Constant Power Mode:	Operation at higher currents but constant power is possible from 80% of Voltage range (125% of max. current) declining to 100% of maximum current at 100 % of voltage range for short periods of time or at reduced ambient temperatures. (< 15 mins @ 30° C). See Figure 2-1 and Figure 2-4.

2.7.2 Acoustic Noise Levels

Acoustic Noise:	Measured at a distance of one meter. (3 ft.)
Front	63 dBA at no load to 68 dBA at full load.
Back	65 dBA at no load to 72 dBA at full load

3. Unpacking and Installation – BPS30 and BPS45 Models.



CAUTION: *There are two basic hardware configuration models of the BPS Series power source with different hookup instructions. Verify that the model being installed is one of the models indicated above. See section 3.0 for BPS75, BPS90, BPS150 and BPS180 versions.*

3.1 Unpacking

Inspect the unit for any possible shipping damage immediately upon receipt. If damage is evident, notify the carrier. **DO NOT** return an instrument to the factory without prior approval. Do not destroy the packing container until the unit has been inspected for damage in shipment. If possible, **retain the container** (wooden crate) in the event the system ever has to be returned to the factory for either repair or upgrades



WARNING: *This version power source weighs approximately*

2150 lbs / 975 Kg

approximately 2475 lbs / 1123 Kg. Obtain adequate help when moving the unit. Make sure the location (floor) in which the BPS Series unit will be installed can support the weight of the unit.

3.2 Power Requirements

The BPS Series power Source has been designed to operate from a three-phase, three wire (Wye or Delta) AC input line. A protective earth connection is required as well. (PE).

Available three-phase input settings are 208 V_{LL} (option -208), 230 V_{LL} (option -230), 400 V_{LL} (option -400), or 480 V_{LL} (option -480).



Figure 3-1: The BPS30 or BPS45 Power Source



CAUTION: *Do not connect 400 or 480V into a unit set for 208 or 230V unit, the result could be a severely damaged unit. Always check the input rating on the model number tag before connecting AC input power. Consult factory if input settings have to be changed.*

3.3 Mechanical Installation

The BPS power source is completely self-contained power sources. They are to be used free standing on a solid surface. The units are fan cooled, drawing air in from the front and exhausting at the rear. The front and back of each unit must be kept clear of obstruction and a 6" clearance must be maintained to the rear. Special consideration of overall airflow characteristics and the resultant internal heat rise must be considered at all times to avoid self heating and over temperature problems.

3.4 AC Input Connections and Wiring

Three-phase Delta or Y AC input voltage of sufficient amperage (consult AC input specifications for maximum AC current per phase) is required to power the BPS Series.

Note: *AC power should be routed through a properly sized and rated three-phase PROTECTIVE CIRCUIT BREAKER or similar branch circuit protection device with disconnect capability. This will protect building wiring and other circuits from possible damage or shutdown in case of a system problem. It will also facilitate removing AC input power to the BPS system in case of service or reconfiguration requirements.*

Note: *AC input wiring and connections must conform to local electrical safety codes that apply. Always consult a qualified electrician prior to installation of any BPS System.*

AC input connections are to be made directly to the input fuse block. The input fuse block is located on the lower left hand corner of the front of the BPS30 and BPS45 chassis. To access the input fuse connection block, the protective front cover needs to be removed first.



CAUTION: *Always disconnect any input power completely when removing any protective cover and allow the internal capacitors to fully discharge (minimum of 15 mins) before removing any cover.) See Figure 4-2 for details.*

No wiring for AC input connections is provided with the BPS Series and must be provided by the end user or installer. Input wiring should be entered through the right hand side (when facing the back of the BPS cabinet, see Figure 4-4) wire access opening located at the rear bottom of the BPS chassis. A wire channel (marked as [2] in figure below) is provided below the input transformer to allow the input wiring to be routed to the front of the unit where the connections are to be made.



WARNING: *The power source's input connection wiring gage (size) must be sized for the maximum input current rating to ensure user safety and avoid possible power source damage, regardless of the actual output load.*

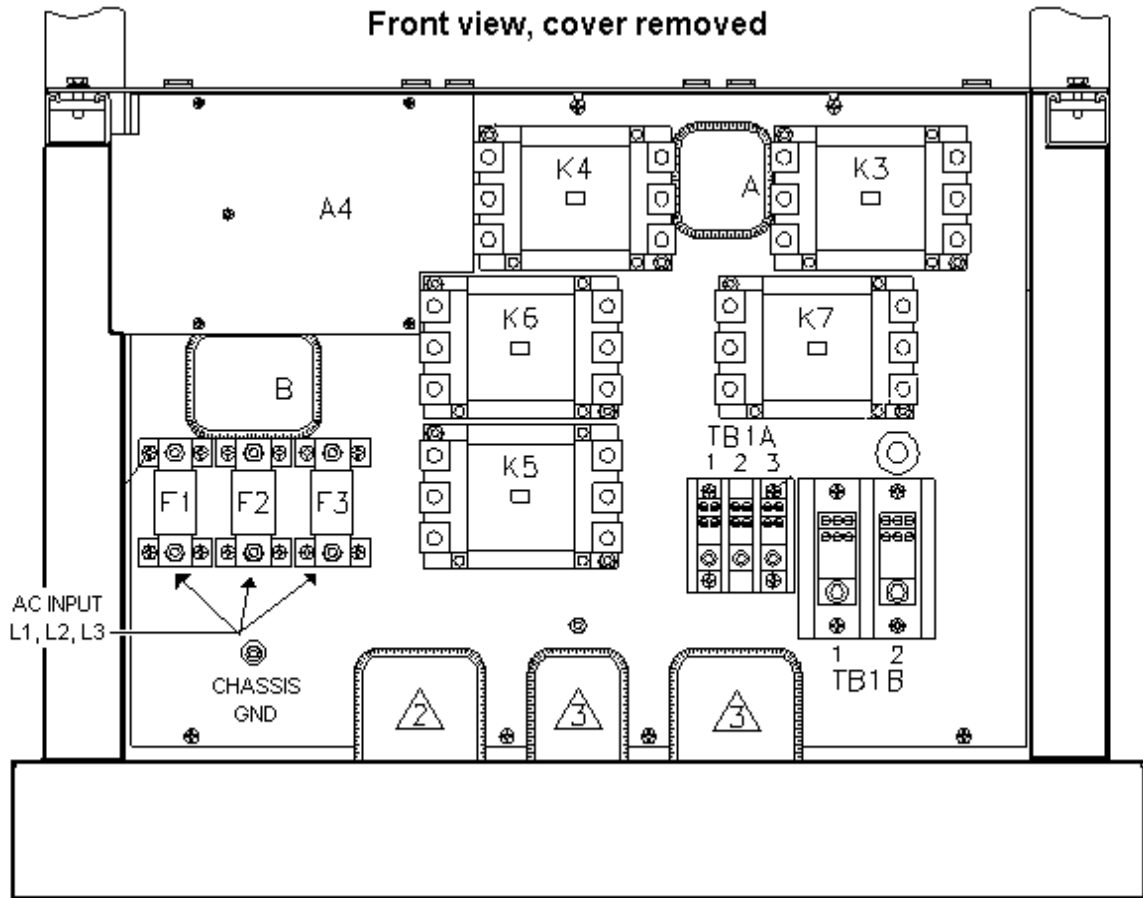

Figure 3-2: Location of BPS30 and BPS45 AC Input Fuse Block and Chassis Ground Connection - Front View, Panel Removed

Note: To comply with product safety requirements, **EARTH GROUND** must be connected to the chassis of the AC power system using the ground stud located directly below the AC input fuse block. Use a Green/Yellow ground wire.

Note: **DO NOT USE THE NEUTRAL CONNECTION OF A 3 PHASE Y AC POWER CONNECTION IN PLACE OF A TRUE EARTH GROUND CONNECTION. AC power system neutrals cannot be used for protective earth ground.**

The mains source must have a current rating equal to or greater than the input fuses and the input wiring must be sized to satisfy the applicable electrical codes. The front cover must be re-installed prior to use and the strain relief provisions located at the rear bottom of the unit must be used to maintain protection against hazardous conditions.

WARNING:

**DELTA INPUT WIRING CONNECTION ONLY.
NO NEUTRAL CONNECTION IS NEEDED.**

**DO NOT USE AN AC NEUTRAL CONDUCTOR FOR
GROUNDING THE MX CHASSIS. USE A SEPARATE
PROTECTIVE EARTH GROUND CONNECTION ONLY.**

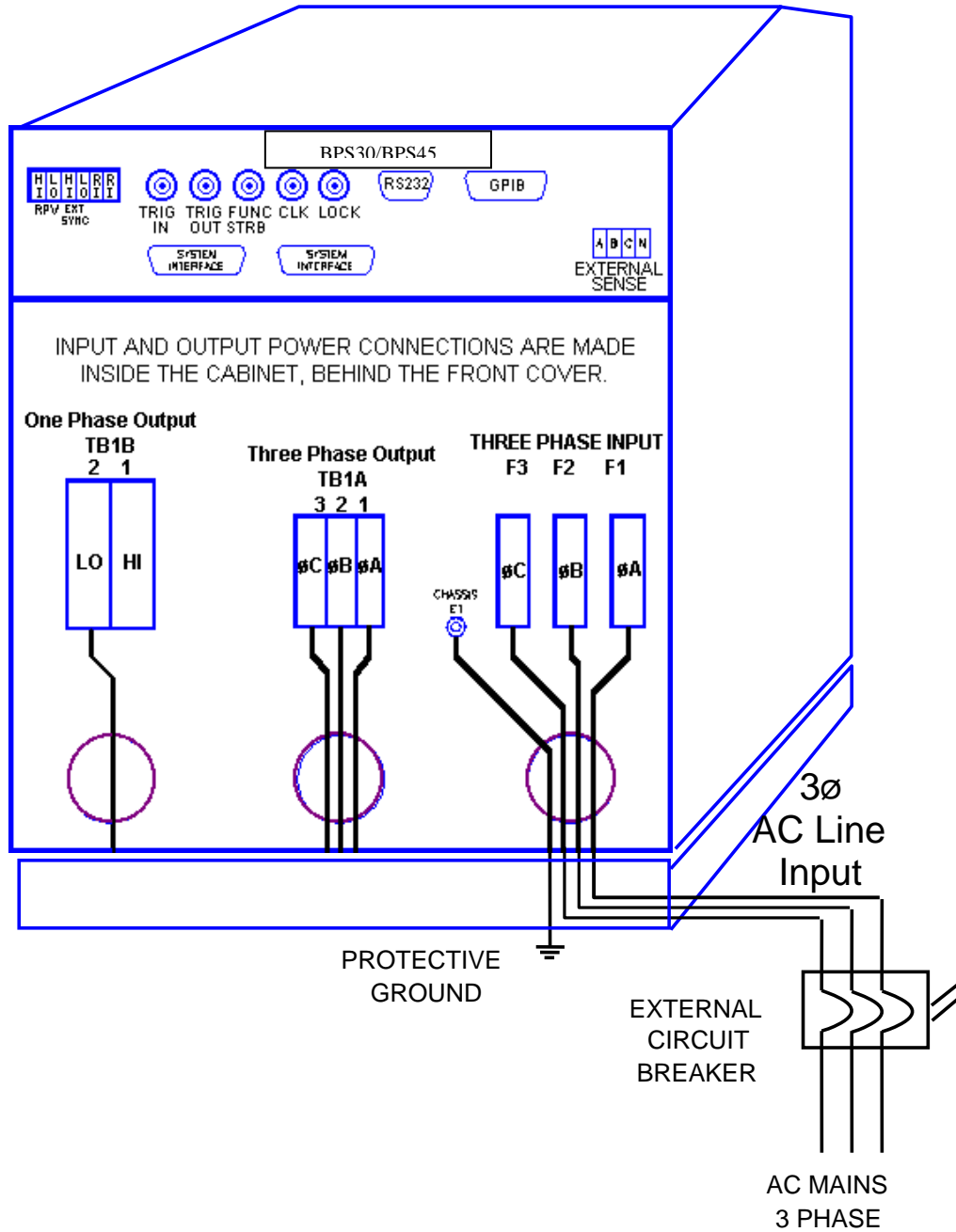

Figure 3-3: BPS30 and BPS45 Series AC Input Connection Diagram (Rear view)

The input power cables and protective circuit breaker used must be large enough to handle the input current and input voltage of the power source and must conform to local electrical codes. Consult a qualified electrician prior to installation. Table 3-1 shows the size of the cables that may be used per BPS cabinet. Note that wires must be sized to accommodate the worst-case maximum current that may occur under low line conditions. Local electrical codes may also require different wire types and sizes. These ratings should also be used when selecting a circuit breaker or equivalent disconnect device.

Cable lengths must not exceed twenty-five (25) feet. For lengths greater than 25 feet, calculate the voltage drop from the following formula:

$$2 \times \text{DISTANCE} \times \text{CABLE RESISTANCE PER FT.} \times \text{CURRENT} = \text{VOLT DROP}$$

Table 3-1: Suggested Input Wiring Sizes for each BPS Cabinet *

Nominal Line Voltage	Load Current @ low line	Wire Gauge (US)	Circular Mils (Kcmils)	Metric (mm2)
480 V	75 A _{RMS}	6 AWG	26.24	13.3
400 V	90 A _{RMS}	4 AWG	41.74	21.1
230 V	157 A _{RMS}	2 AWG	66.36	33.6
208 V	175 A _{RMS}	1 AWG	83.69	42.4

* Using high temperature rated wire. Always consult the National Electrical Code and local code regulations for proper rating and size of wire cabling prior to installation.



CAUTION: *Capacitors in the power source may hold a hazardous electrical charge even if the power source has been disconnected from the mains supply. Allow capacitors to discharge to a safe voltage before touching exposed pins of mains supply connectors. Power modules need at least 15 Minutes to discharge to safe levels before they can be removed.*

3.5 AC On/Off Circuit Breaker on BPS Series front panel.

It is important to understand the purpose and operation of the On/Off circuit breaker of the BPS Series located on the lower left side of the front panel. This is a 2A rated breaker that is used to engage and protect the LV Power supply of the BPS chassis only. The LV Power supply provides DC bias power to the entire BPS system. The AC input power is routed through a set of three AC line fuses (F1, F2 and F3) located in the lower left bottom corner of the BPS. (See Figure 4-2 for fuse locations). These fuses protect the three BPS amplifiers and the AC input transformer from excessive input currents. The AC input power is connected to the input transformer through a large three-pole contactor. Removing AC power to the LV Power Supply by opening the front panel circuit breaker (moving the lever to the down (OFF) position) will cause this contactor to lose its coil voltage and will result in it opening and disconnecting the input transformer and amplifier from AC mains input.

Note: *If any system failure has occurred on any part of the BPS system, AC input power must be removed immediately and not restored until the system has been inspected by a qualifier service technician. Repeatedly applying power may cause further damage. Always turn off the On/Off Circuit breaker before re-applying AC input power.*



CAUTION: *The AC input fuses can only be checked is the BPS unit is completely de-energized and disconnected from any AC power input.*

Note: Under no circumstances should AC input power be applied if one or more of the AC input line fuses have failed and opened up.

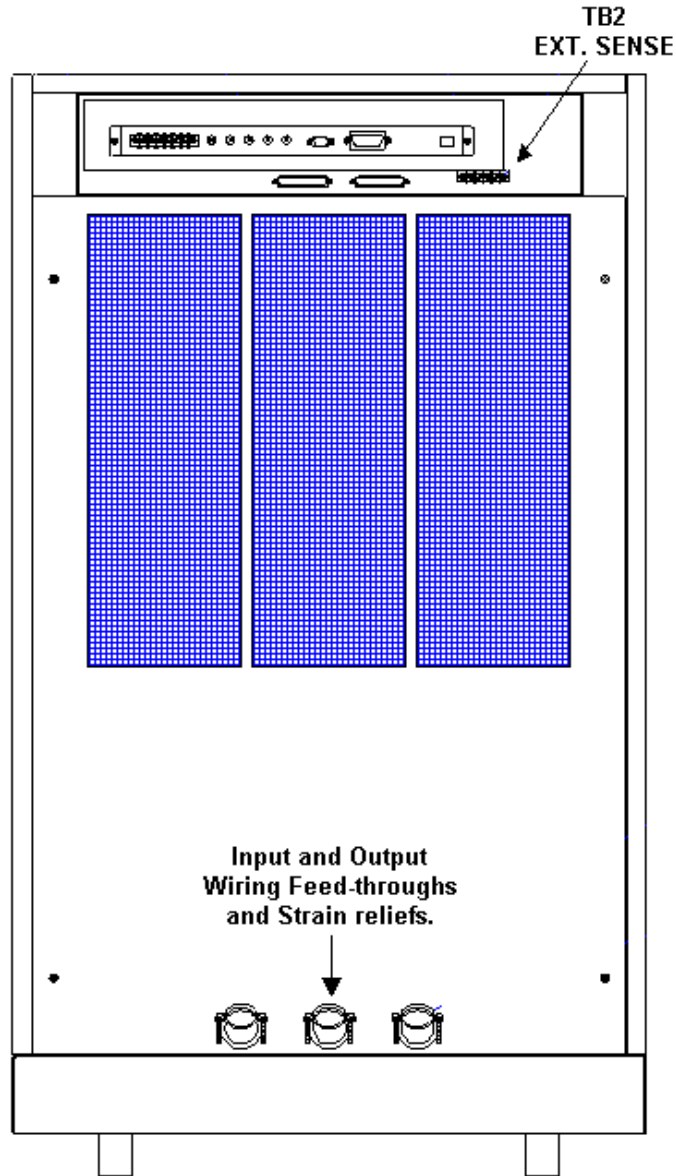

Figure 3-4: BPS30 or BSP45 Rear Panel

3.6 Output Connections

3.6.1 Output Wiring

The output terminal blocks, TB1A and TB1B are located at the front of the unit behind the bottom access panel. See Figure 4-2 for details.

Three phase output line connections are made to terminal block TB1A. The phase outputs are labeled A, B and C. The neutral connection (if needed) can be made on terminal block TB1B. If the model used is a BPS30-1 or BPS45-1 with single-phase capability, the single phase A output connection is available on TB1B as well. Note that the neutral for either single or three-phase mode is always located on TB1B. The neutral connection is always required for single-phase output BPS30-1 or BPS30-3 and may be used if needed for the EUT for BPS30-3 and BPS45-3 models with three-phase output modes.

The external sense inputs allow the power system output voltages to be monitored directly at the load and must be connected at TB2 when the sense is programmed for external. The external sense input does not have to be connected when Internal Sense is programmed. The external sense wires are to be connected to TB2 on the rear panel and should be run using a twisted shielded cable. See Figure 4-4 for location of TB2 and Figure 4-5 for shield connection detail.

Note: *For External Sense connection, a shielded cable MUST be used with the shield connected to chassis ground at the Ext. Sense connector. (See Figure 4-5).*

External sense is recommended for multi-cabinet systems is the output wiring from the cabinets to the common output terminal block supplied is not of equal length.

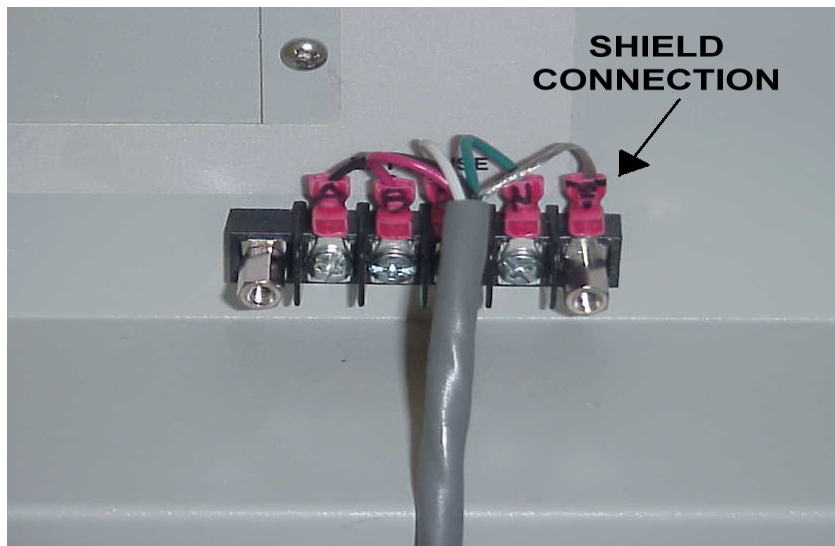

Figure 3-5: External sense cable shield connection to chassis ground

Note: *The output of the power source is isolated from the input line and floating with respect to chassis ground. If needed, either side (HI or LO) may be grounded.*

If the EUT changes frequently, you may want to consider using some quick disconnect scheme external to the BPS so it will not be necessary to power down the BPS and remove the front covers. This can take the form of a panel-mounted socket (1 or 3 phase) of sufficient current and voltage rating. (Not supplied with BPS)

The output power cables must be large enough to prevent a total voltage drop exceeding 1% of the rated output voltage between the power source and the load. Table 4-2 shows the size of the cables that may be used. Note that wires must be sized to accommodate the maximum current that is available. This may

be a function of the voltage range and phase mode on some BPS models. If the BPS has more than one output voltage range, size the wires for the lowest available voltage range as the currents will be highest in that range.

Cable lengths must not exceed twenty-five (25) feet. For lengths greater than 25 feet, calculate the voltage drop from the following formula:

$$2 \times \text{DISTANCE} \times \text{CABLE RESISTANCE PER FT.} \times \text{CURRENT} = \text{VOLT DROP}$$

*Table 3-2: Suggested Output Wiring Sizes **

Load Current	Wire Gauge (US)	Circular Mils (kcmils)	Metric (mm ²)
65 AMPS	6 AWG	26.24	13.3
130 AMPS	4 AWG	41.74	21.1
260 AMPS	1/0 AWG	105.6	53.5
400 AMPS	2/0 AWG	133.1	67.4

Note: *Use high temperature rated wire. Always consult the National Electrical Code and local code regulations for proper rating and size of wire cabling prior to installation.*

3.6.2 Output Terminal Blocks

The BPS30-3 and BPS45-3 have two output terminal blocks, TB1A and TB1B. The BPS30-1 and BPS45-1 only has one output terminal block, TB1B. The terminal blocks are large enough to accommodate the recommended wire gauge sizes shown in Table 4-2. The terminal blocks are located in the lower right corner on the front of the unit. The front panel needs to be removed to access these terminal blocks.



CAUTION: REMOVE ALL INPUT POWER TO THE BPS BEFORE REMOVING THE FRONT PANEL.

The correct standard size Allen wrenches for connecting output wiring to TB1A and/or TB1B are supplied with each BPS in the ship kit. Look for a brown envelope. If the correct tools cannot be found, contact AMETEK Programmable Power customer service at service@programmablepower.com.

Terminal block TB1B always provides the output neutral connection, regardless of the phase mode (1 or 3 phase output mode).

In single-phase mode, phase A output is provided through terminal 1 of TB1B.

In three-phase mode, phase A, B and C outputs are provided through terminals 1, 2 and 3 of TB1A respectively.

Connector	Terminal	Mode	Output
TB1A	1	3 Phase	Phase A
	2	3 Phase	Phase B
	3	3 Phase	Phase C
TB1B	1	1 Phase	Phase A
	2	1 and 3 Phase	Neutral

Table 3-3: Output Terminal connections.

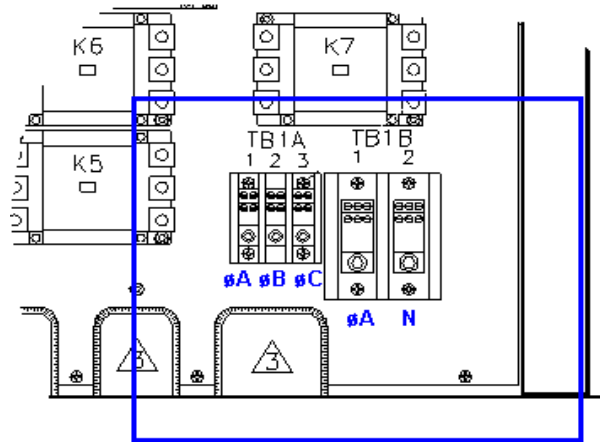

Figure 3-6: Location of BPS30 and BPS45 Output Terminals (Front view)

3.6.3 BPS30-1, BPS45-1 - 1 ϕ mode Output Wiring Diagram

Figure 3-7 shows the required output connections for a BPS30-1, BPS45-1 in single-phase mode output configuration (rear-view perspective). See section 3.6.3 for the BPS30-3 or BPS45-3 in three-phase mode.

Always disconnect all input power from the BPS before removing the front panel cover that provides access to the input and output terminal connections. Route the wires from the back of the BPS to the front in the provided cable guides.

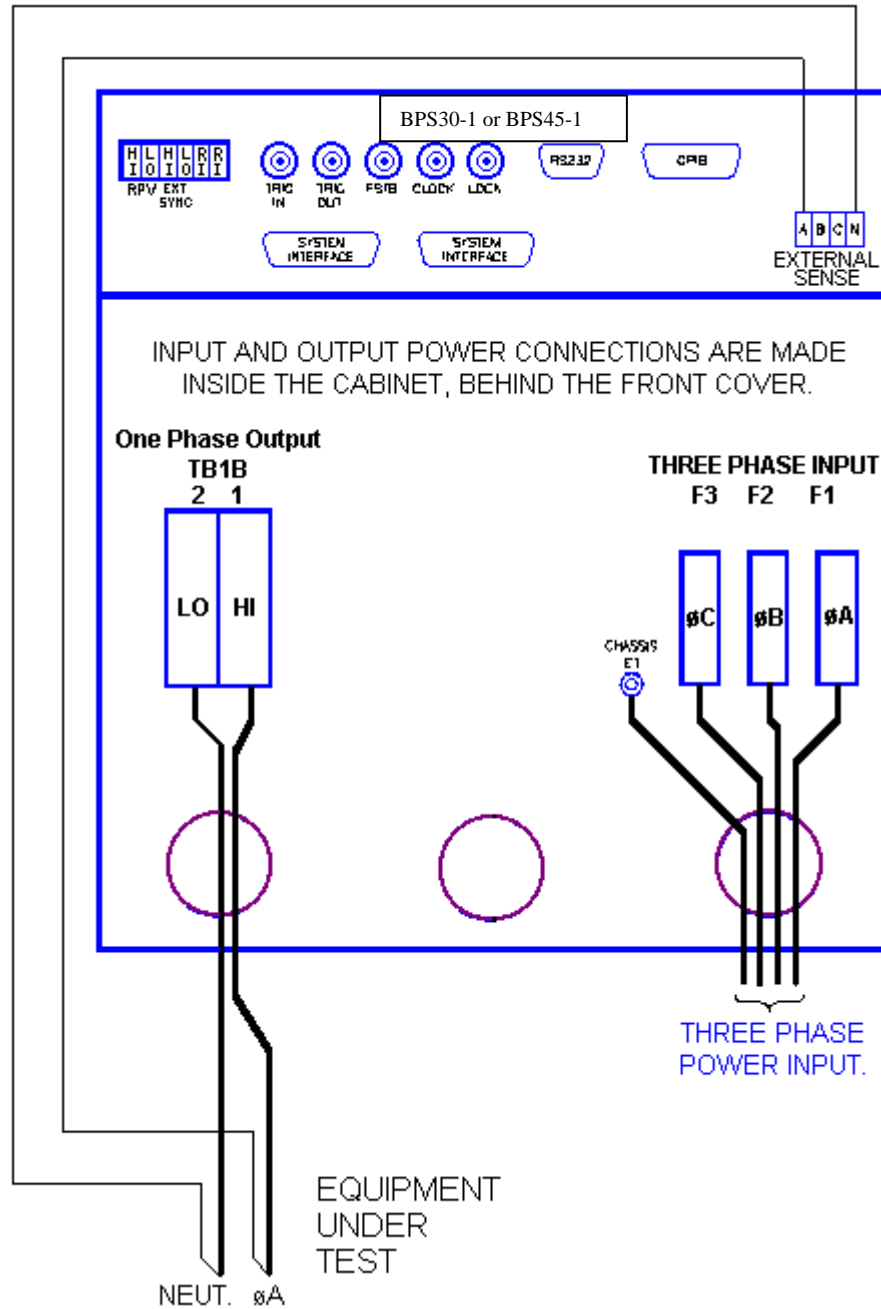

Figure 3-7: BPS30-1 / BPS45-1 Output Wiring (Rear view)

3.6.4 BPD30-3, BPS45-3 3 ϕ mode Output Wiring Diagram

Figure 4-7 shows the required output connections for a BPS30-3 and BPS45-3 ordered in three-phase mode output configuration (rear-view perspective). See section 3.6.2 for the BPS30-1 and BPS45-1 ordered in single-phase mode.

Always disconnect all input power from the BPS before removing the front panel cover that provides access to the input and output terminal connections. Route the wires from the back of the BPS to the front in the provided cable guides.

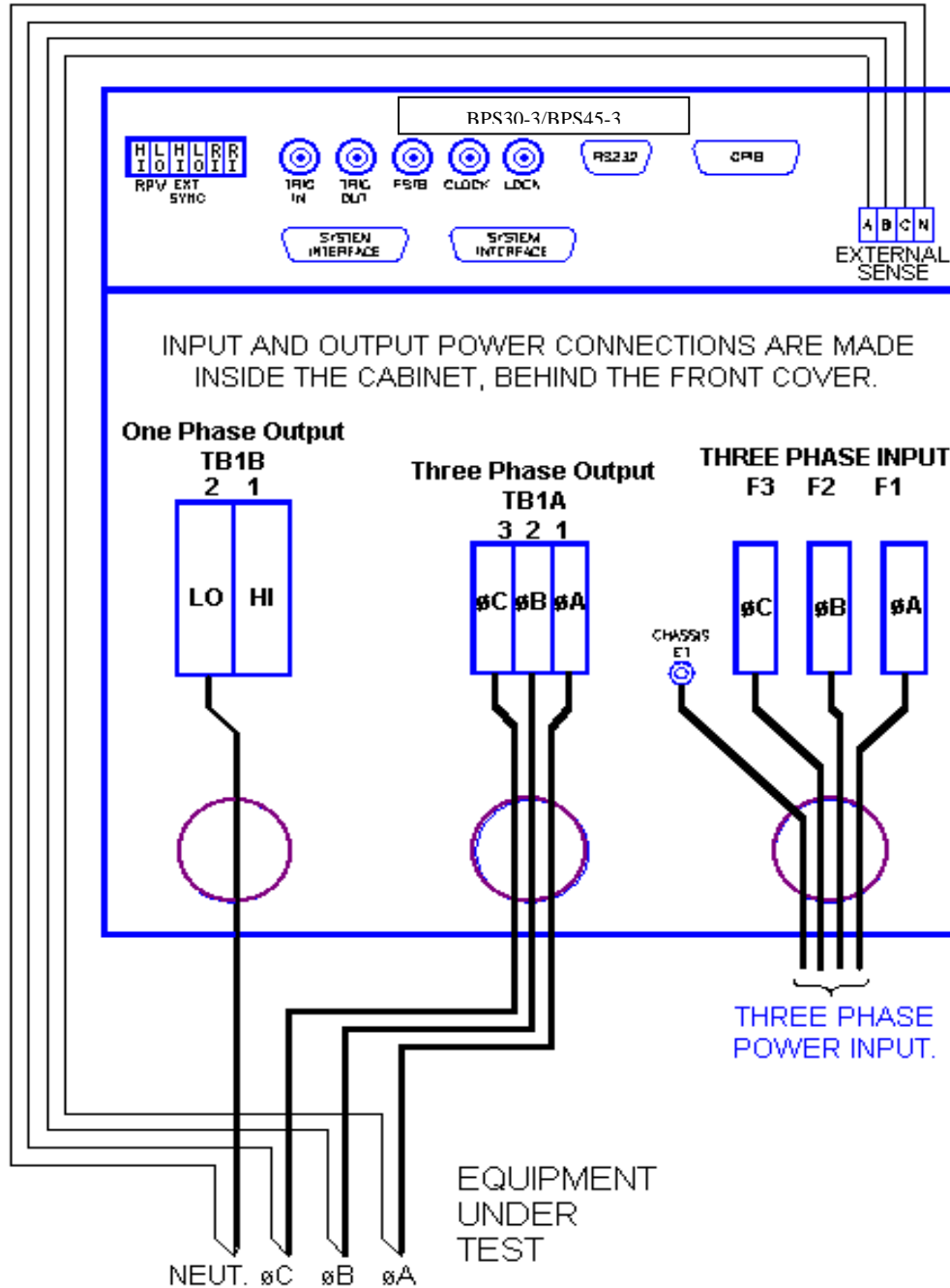

Figure 3-8: BPS30-3 / BPS45-3 Output Wiring (Rear view)

4. Unpacking and Installation – BPS75 / BPS90 / BPS150 and BPS180 Models.



CAUTION: *There are two basic models of the BPS Series power source hardware with different hookup instructions. Verify that the model being installed is one of the models indicated above. See section 3.0 for BPS30 and BPS45 versions.*

4.1 Unpacking

Inspect the unit for any possible shipping damage immediately upon receipt. If damage is evident, notify the carrier. **DO NOT** return an instrument to the factory without prior approval. Do not destroy the packing container until the unit has been inspected for damage in shipment. If possible, **retain the container** (wooden crate) in the event the system ever has to be returned to the factory for either repair or upgrades



WARNING: *This version BPS power source weighs approximately 2150 lbs / 975 Kg approximately 2475 lbs / 1123 Kg). Obtain adequate help and proper equipment when moving the unit. Make sure the location (floor) in which the BPS Series unit(s) will be installed can support the weight of the unit(s).*

4.2 Power Requirements

The BPS Series power Source has been designed to operate from a three-phase, three wire (Wye or Delta) AC input line. A protective earth connection is required as well. (PE).

Available three-phase input settings are 208 V_{LL} (option -208), 230 V_{LL} (option -230), 400 V_{LL} (option -400), or 480 V_{LL} (option -480).



CAUTION: *Do not connect 400 or 480V into a unit set for 208 or 230V unit, the result could be a severely damaged unit. Always check the input rating on the model number tag before connecting AC input power. Consult factory if input settings have to be changed.*



Figure 4-1: BPS75/BPS90 Power Source Photo

4.3 Mechanical Installation

The BPS75 and BPS90 products are completely self-contained power sources. They are to be used free standing on a solid surface. The units are fan cooled, drawing air in from the front and exhausting at the rear. The front and back of each unit must be kept clear of obstruction and a 6" clearance must be maintained to the rear. Special consideration of overall airflow characteristics and the resultant internal heat rise must be considered at all times to avoid self heating and over temperature problems.

4.4 AC Input Connections and Wiring

Three-phase Delta or Y AC input voltage of sufficient amperage (consult AC input specifications for maximum AC current per phase) is required to power the BPS Series.

Note: *AC power should be routed through a properly sized and rated three-phase PROTECTIVE CIRCUIT BREAKER or similar branch circuit protection device with disconnect capability. This will protect building wiring and other circuits from possible damage or shutdown in case of a system problem. It will also facilitate removing AC input power to the BPS system in case of service or reconfiguration requirements.*

Note: *AC input wiring and connections must conform to all national and local electrical safety codes that may apply. Always consult a qualified electrician prior to installation of any BPS System.*

AC input connections are to be made directly to the input fuse block. The input fuse block is located on the lower left hand corner of the front of the BPS chassis. To access the input fuse connection block, the protective front cover needs to be removed first.



CAUTION: *Always disconnect any input power completely when removing any protective cover and allow the internal capacitors to fully discharge (minimum of 15 mins) before removing any cover.) See Figure 4-2 for details.*

No wiring for AC input connections is provided with the BPS Series and must be provided by the end user or installer. Input wiring should be entered through the right hand side (when facing the back of the BPS cabinet, see Figure 4-4) wire access opening located at the rear bottom of the BPS chassis. A wire channel (marked as [2] in figure below) is provided below the input transformer to allow the input wiring to be routed to the front of the unit where the connections are to be made.



WARNING: *The power source's input connection wiring gage (size) must be sized for the maximum input current rating to ensure user safety and avoid possible power source damage, regardless of the actual output load.*

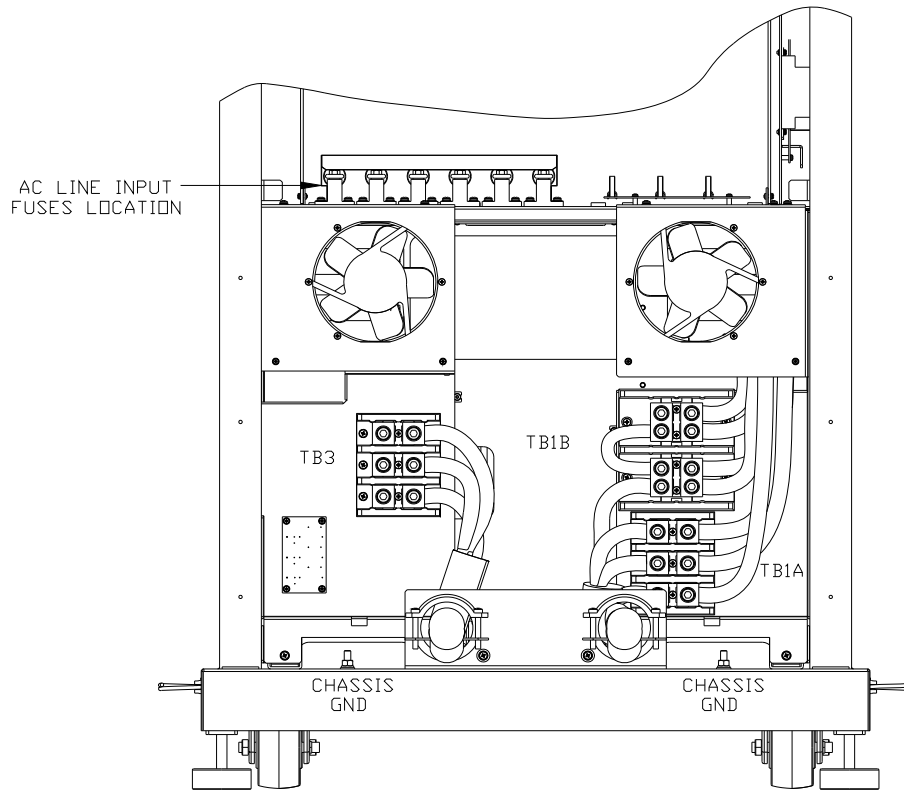

Figure 4-2: Location of BPS75 and BPS90 AC Input Connection Block (TB3) and Chassis Ground Connection

Note: *To comply with product safety requirements, EARTH GROUND must be connected to the chassis of the AC power system using the ground stud located directly below the AC input fuse block. Use a Green/Yellow ground wire.*

Note: *DO NOT USE THE NEUTRAL CONNECTION OF A 3 PHASE Y AC POWER CONNECTION IN PLACE OF A TRUE EARTH GROUND CONNECTION. AC power system neutrals cannot be used for protective earth ground.*

The mains source must have a current rating equal to or greater than the input fuses and the input wiring must be sized to satisfy the applicable electrical codes. All covers must be re-installed prior to use and the strain relief provisions located at the rear bottom of the unit must be used to maintain protection against hazardous conditions.

WARNING

**DELTA INPUT WIRING CONNECTION ONLY.
NO NEUTRAL CONNECTION IS NEEDED.**

**DO NOT USE AN AC NEUTRAL CONDUCTOR FOR
GROUNDING THE CHASSIS. USE A SEPARATE
PROTECTIVE EARTH GROUND CONNECTION ONLY.**

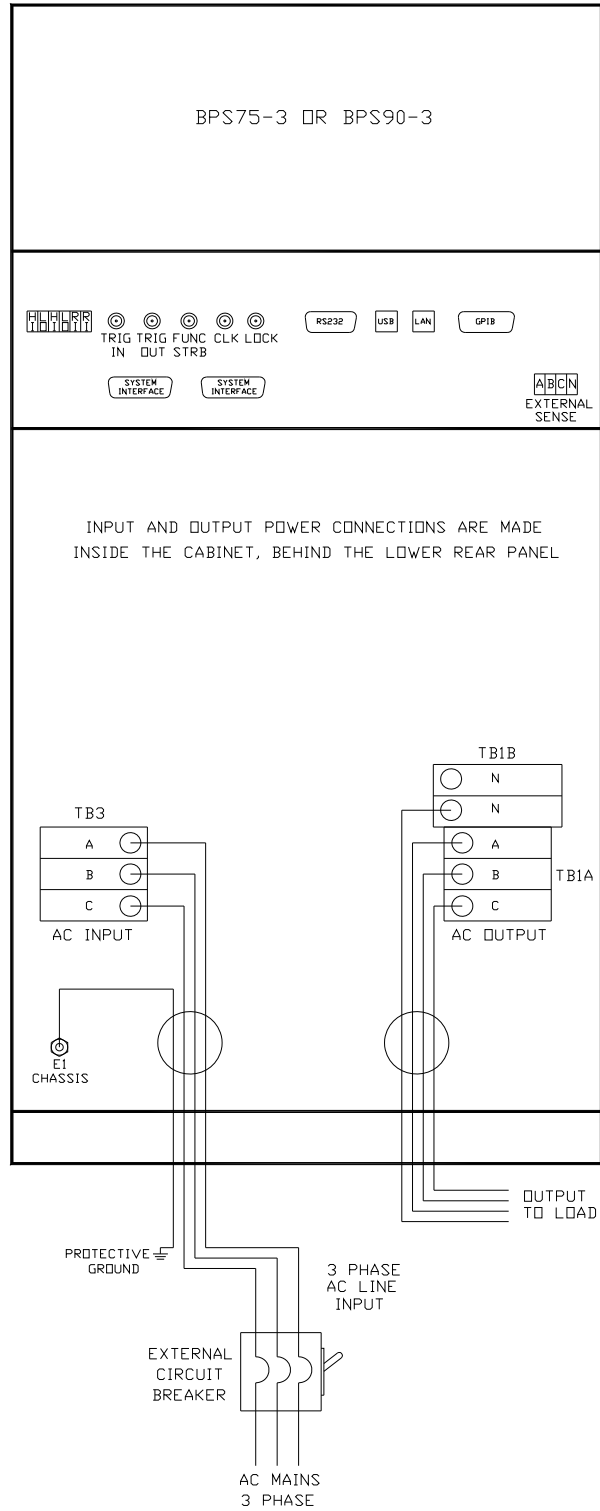

Figure 4-3: BPS75-3 or BPS90-3 AC Input Connection Diagram (Rear view)

The input power cables and protective circuit breaker used must be large enough to handle the input current and input voltage of the power source and must conform to national and local electrical codes. Consult a qualified electrician prior to installation. **Error! Reference source not found.** shows the size of the cables that may be used per each BPS cabinet. Note that wires must be sized to accommodate the worst-case maximum current that may occur under low line conditions. Local electrical codes may also require different wire types and sizes. These ratings should also be used when selecting a circuit breaker or equivalent disconnect device.

Cable lengths must not exceed twenty-five (25) feet. For lengths greater than 25 feet, calculate the voltage drop from the following formula:

$$2 \times \text{DISTANCE} \times \text{CABLE RESISTANCE PER FT.} \times \text{CURRENT} = \text{VOLT DROP}$$

Table 4-1: Suggested Input Wiring Sizes for each RS Cabinet *

Nominal Line Voltage	Load Current @ low line	Wire Gauge (US)	Circular Mils (Kcmils)	Metric (mm2)
480 V	75 A _{RMS}	2 AWG	66.4	33.6
400 V	90 A _{RMS}	1 AWG	83.7	42.4
230 V	157 A _{RMS}	3/0 AWG	168.0	85.0
208 V	175 A _{RMS}	4/0 AWG	212.0	107.0

* Data shown for use of high temperature (100° C) rated stranded copper wire, unbundled and not installed in conduit. Adjust wire gauge for Aluminum wire type. Always consult the National Electrical Code and local code regulations for proper rating and size of wire cabling prior to installation.



CAUTION: *Capacitors in the power source may hold a hazardous electrical charge even if the power source has been disconnected from the mains supply. Allow capacitors to discharge to a safe voltage before touching exposed pins of mains supply connectors. Power modules need at least 15 minutes to discharge to safe levels before they can be removed.*

4.5 AC On/Off Circuit Breaker on BPS Series front panel.

It is important to understand the purpose and operation of the On/Off circuit breaker of the BPS Series located on the lower left side of the front panel. This is a 2.5A rated breaker that is used to engage and protect the two LV Power supplies of the BPS chassis only. The LV Power supplies provide DC bias power to the entire BPS system. The AC input power is routed through a set of six AC line fuses (F1 – F6) located in the lower rear left bottom corner of the BPS. (See Figure 4-2 for fuse locations). These fuses protect the six BPS amplifiers and the AC input transformer from excessive input currents. The AC input power is connected to the input transformer through a large three-pole contactor. Removing AC power to the LV Power Supply by opening the front panel circuit breaker (moving the lever to the down (OFF) position) will cause this contactor to lose its coil voltage and will result in it opening and disconnecting the input transformer and amplifier from AC mains input.

Note: *If any BPS system failure has occurred on any part of the BPS system, AC input power must be removed immediately and not restored until the system has been inspected by a qualifier service technician. Continued attempts to restart system can lead to further damage. Always turn off the On/Off Circuit breaker before re-applying AC input power.*



CAUTION: The AC input fuses can only be checked if the BPS unit is completely de-energized and disconnected from any AC power input.

Note: Under no circumstances should AC input power be applied if one or more of the AC input line fuses have failed and opened up.

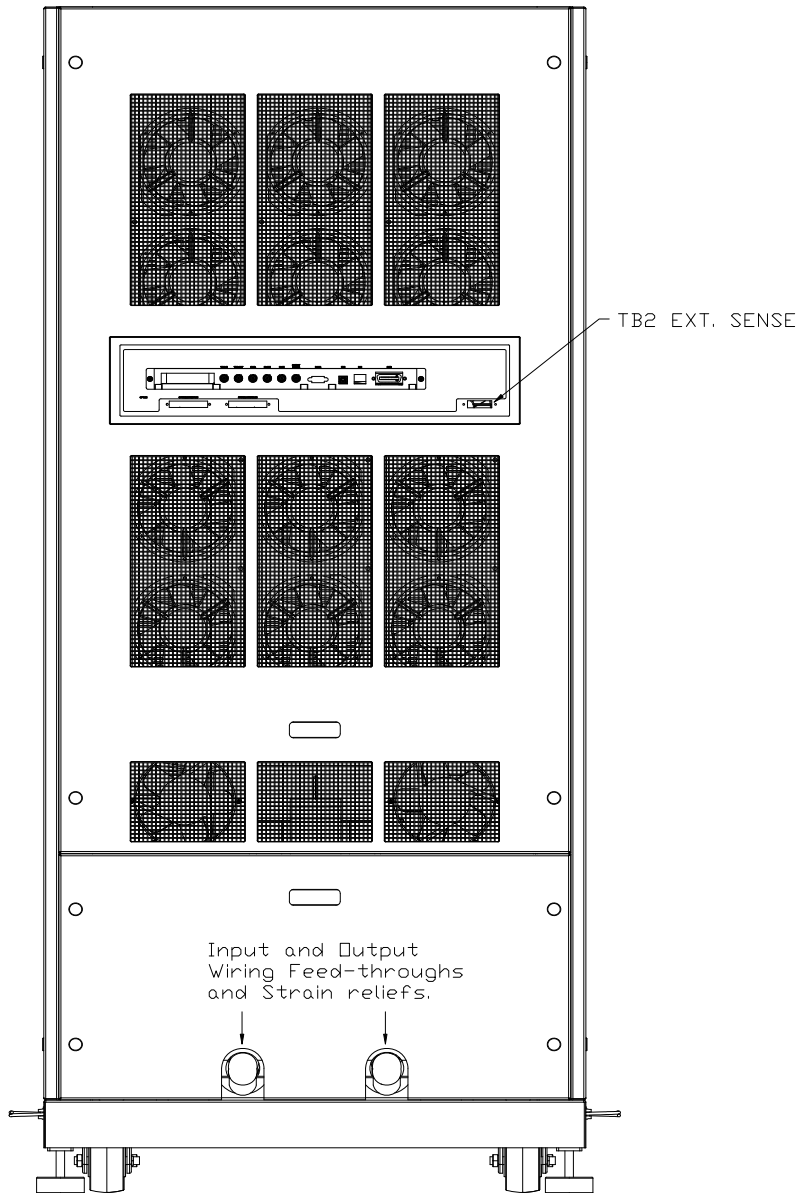

Figure 4-4: BPS75-3 or BPS90-3 Rear Panel – External Sense connector location.

4.6 Output Connections

4.6.1 Output Wiring

The output terminal blocks, TB1A and TB1B are located at the lower rear of the unit behind the bottom access panel. See Figure 4-2 for details.

Three phase output line connections are made to terminal block TB1A. The phase outputs are labeled A, B and C. The neutral connection (if needed) can be made on terminal block TB1B. The neutral connection is always required to connect Y loads or for connecting a single phase load to Phase A only.

The external sense inputs allow the power system output voltages to be monitored directly at the load and must be connected at TB2 when the sense is programmed for external. The external sense input does not have to be connected when Internal Sense is programmed. The external sense wires are to be connected to TB2 on the rear panel and should be run using a twisted shielded cable. See Figure 4-4 for location of TB2 and Figure 4-5 for shield connection detail.

Note: *For External Sense connection, a shielded cable MUST be used with the shield connected to chassis ground at the Ext. Sense connector. (See Figure 4-5).*

External sense is recommended for multi-cabinet systems is the output wiring from the cabinets to the common output terminal block supplied is not of equal length.

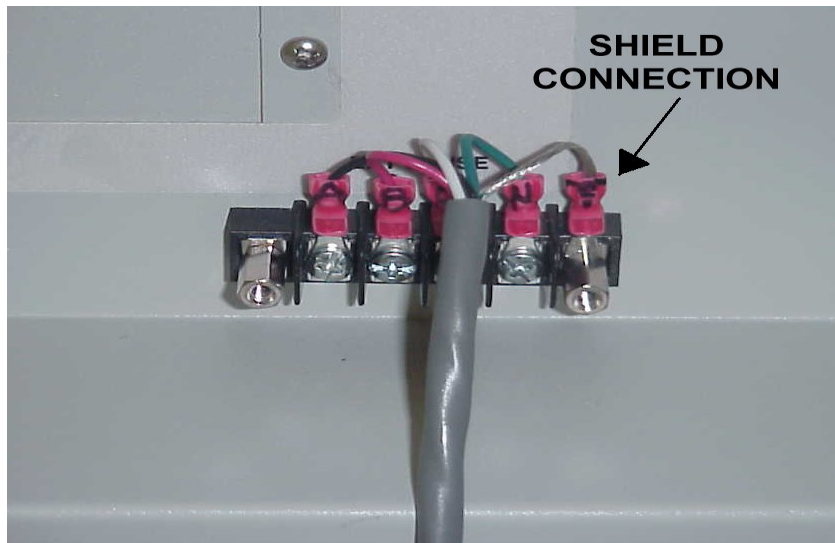

Figure 4-5: External sense cable shield connection to chassis ground

Note: *The output of the power source is isolated from the input line and floating with respect to chassis ground. If needed, either side (HI or LO) may be grounded.*

If the EUT changes frequently, you may want to consider using some quick disconnect scheme external to the BPS so it will not be necessary to power down the BPS and remove the rear covers. This can take the form of a panel-mounted socket (1 or 3 phase) of sufficient current and voltage rating. (Not supplied with BPS)

The output power cables must be large enough to prevent a total voltage drop exceeding 1% of the rated output voltage between the power source and the load. Table 4-2 shows the size of the cables that may be used. Note that wires must be sized to accommodate the maximum current that is available. This may be a function of the voltage range and phase mode on some BPS models. If the BPS has more than one output voltage range, size the wires for the lowest available voltage range as the currents will be highest in that range.

Cable lengths must not exceed twenty-five (25) feet. For lengths greater than 25 feet, calculate the voltage drop from the following formula:

$$2 \times \text{DISTANCE} \times \text{CABLE RESISTANCE PER FT.} \times \text{CURRENT} = \text{VOLT DROP}$$

*Table 4-2: Suggested Output Wiring Sizes**

Load Current	Wire Gauge (US)	Circular Mils (kcmils)	Metric (mm ²)
65 AMPS	8 AWG	16.5	8.37
130 AMPS	4 AWG	41.7	21.2
260 AMPS	2/0 AWG	133.0	67.4
400 AMPS	4/0 AWG	212.0	107.0

* Data shown for use of high temperature (100° C) rated stranded copper wire, unbundled and not installed in conduit. Adjust wire gauge for Aluminum wire type.

Note: *Use high temperature rated wire. Always consult the National Electrical Code and local code regulations for proper rating and size of wire cabling prior to installation.*

4.6.2 Output Terminal Blocks

The BPS has two output terminal blocks, TB1A and TB1B. The terminal blocks are large enough to accommodate the recommended wire gauge sizes shown in Table 4-2. The terminal blocks are located in the lower right corner on the back of the unit when facing the rear. The rear access panel at the bottom of the chassis needs to be removed to access these terminal blocks.



CAUTION: REMOVE ALL INPUT POWER TO THE BPS BEFORE REMOVING THE REAR ACCESS PANEL.

The correct standard size Allen wrenches for connecting output wiring to TB1A and/or TB1B are supplied with each BPS in the ship kit. Look for a brown envelope. If the correct tools cannot be found, contact AMETEK Programmable Power customer service at service.ppd@ametek.com.

Terminal block TB1B provides the output neutral connection of the three phase WYE output.

Phase A, B and C outputs are provided through terminals 1, 2 and 3 of TB1A respectively.

Connector	Terminal	Mode	Output
TB1A	1	3 Phase	Phase A
	2	3 Phase	Phase B
	3	3 Phase	Phase C
TB1B	1 - 4	3 Phase	Neutral

Table 4-3: Output Terminal connections.

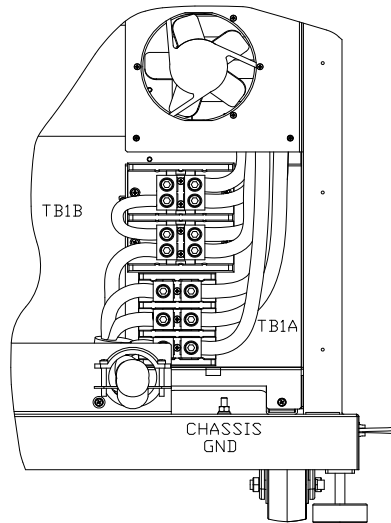

Figure 4-6: Location of Output Terminals (Rear view)

4.6.3 Output Wiring Diagram

Figure 4-7 shows the required output wiring connections for a BPS75 or BPS90 (rear panel view).

Always disconnect all input power from the BPS before removing the rear terminal block access panel. Route the load wires through the strain relief clamps. Depending on wire size required, it may be necessary to use two strain relief holes with 2 wires through each as shown.

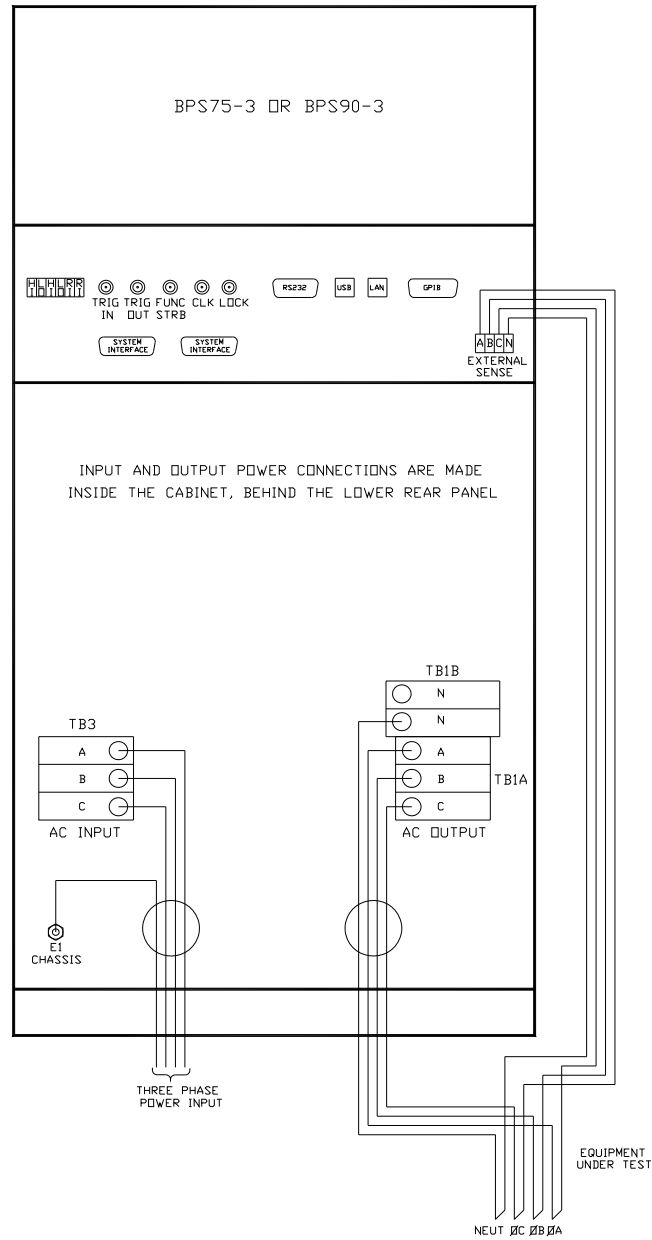

Figure 4-7: BPS75-3 or BPS90-3 Output Wiring (Rear panel view)

4.6.4 BPS150-3 or BPS180-3 Parallel Output Wiring Diagram

Figure 4-8 shows the required output connections for a two chassis dual chassis parallel mode output configuration (rear view). Always disconnect all input power from the BPS system before removing the rear panel cover that provides access to the input and output terminal connections. Two chassis BPS systems are shipped with external output terminal blocks that enable the output wiring from two chassis to be combined, providing a single point of connection to the EUT. These blocks must be installed in a suitable safety enclosure. It is important to match the length of the output wiring to the common output terminal block to ensure current sharing between the two power supplies.

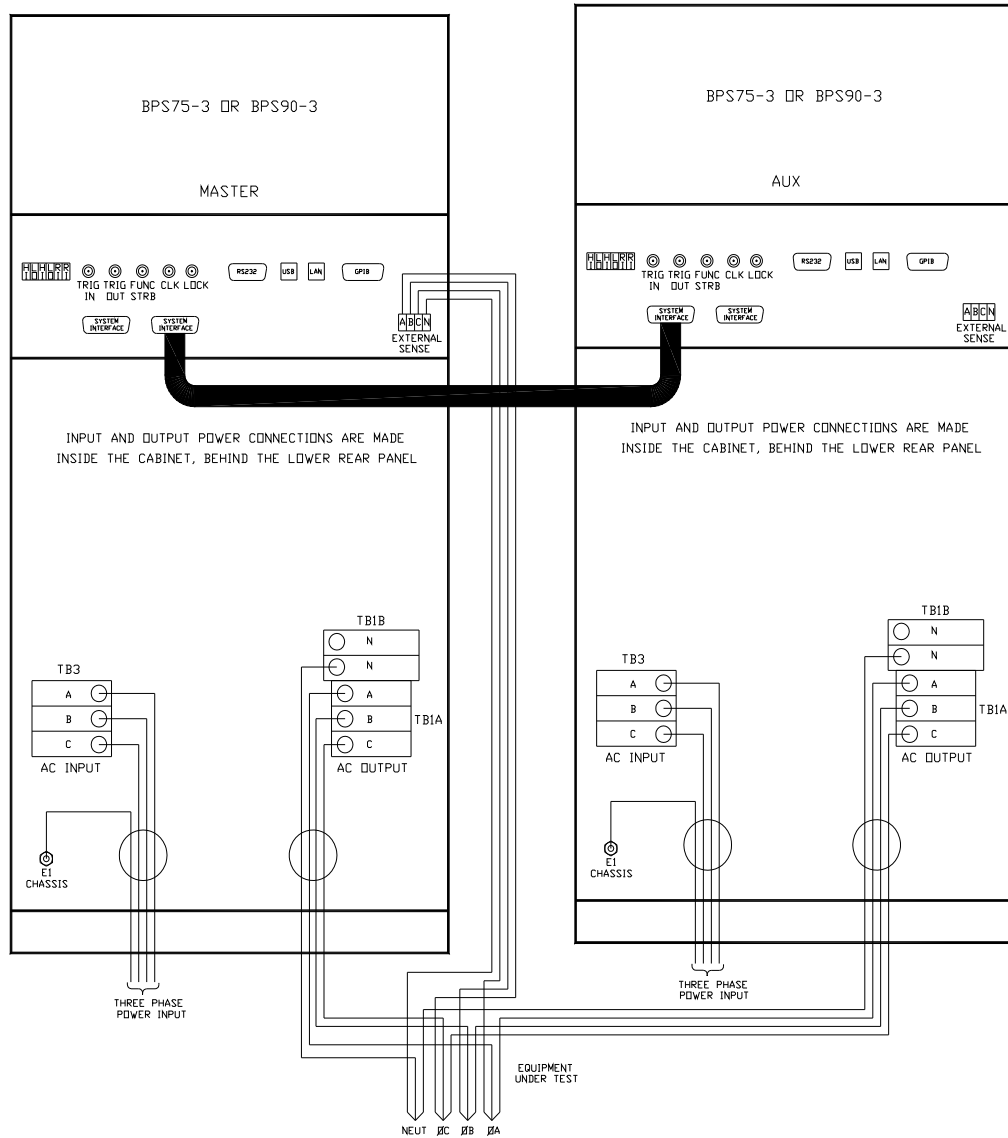

Figure 4-8: BPS150-3 or BPS180-3 - 2 Chassis Output Wiring (Rear view)

4.6.5 Multi-Chassis Output Connections

If two or more BPS chassis are used to form a single power system, the outputs of all chassis need to be combined (paralleled by phase). This can be done directly at the EUT if convenient or using the provided heavy-duty terminal blocks. Two blocks are provided with multi-chassis systems, one 2-position block and one 3-position block. These blocks allow up to four wires to be combined into one larger wire gauge size wire. The outputs of the 2 or 3 BPS chassis are connected on one side of these blocks (Phase A,B and C into the 3 position terminal and the neutral into the 2 position terminal.). The EUT can be connected to the other side. Note that the wire size to the EUT should be sized up to accommodate the double or triple currents per phase.

The dimensions of the typical supplied terminal blocks are shown in Figure 4-9.

Note: Even if the EUT is a three-phase delta input, the output neutrals of the BPS chassis' must be connected together for the system to work correctly.

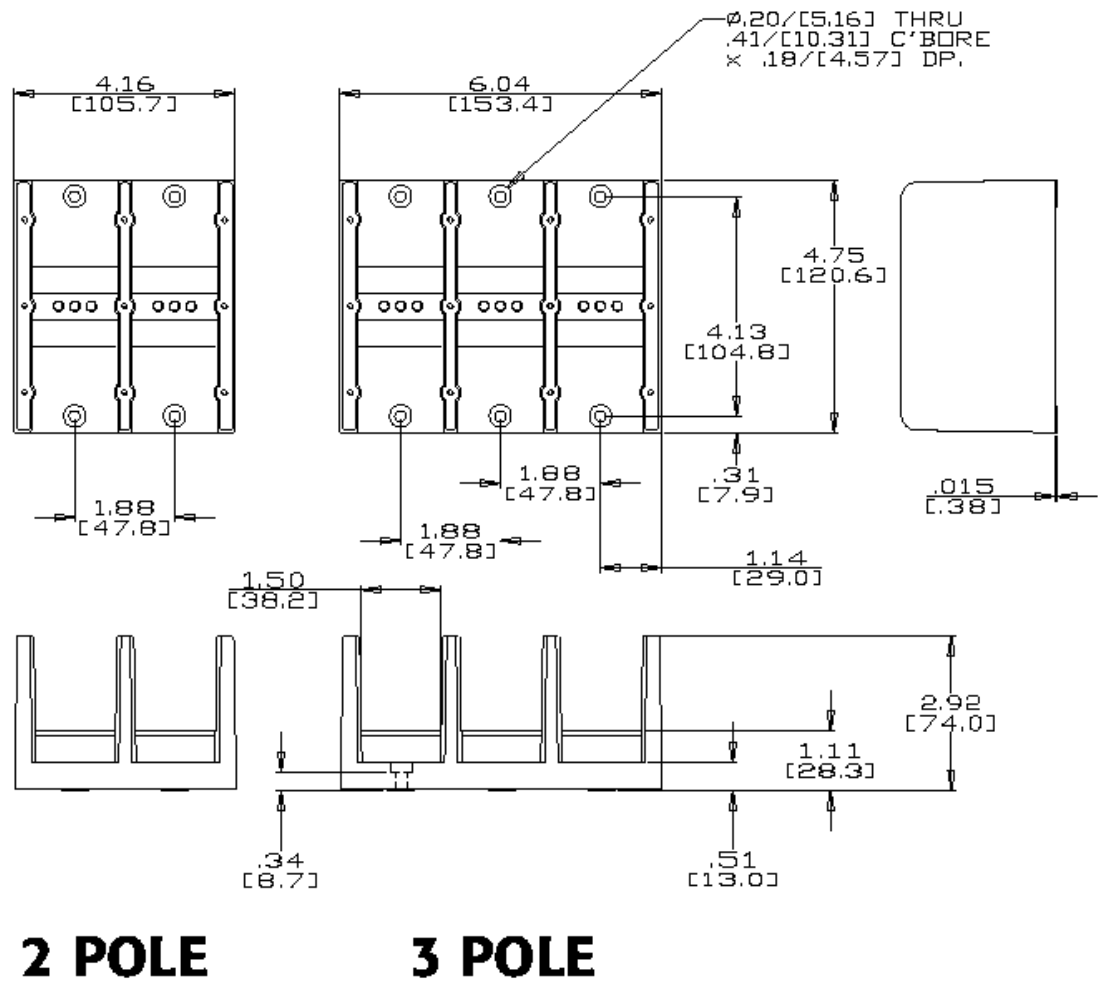

Figure 4-9: Ship kit Terminal Block dimensions

4.7 Connectors - Rear Panel

A number of connectors are located along the center rear panel. These connectors are in a recessed area to protect them from shipment damage.

4.7.1 System Interface



WARNING: *The system interface connectors are for use with AMETEK Programmable Power supplied cables, and only between California Instruments equipment.*

A set of two identical System Interface connectors, P8 and P9 (TBD) is located on the rear panel of each BPS chassis. The system interface is used to connect the multiple BPS power sources in a Master/Auxiliary configuration to create BPS150 or BPS180 models. In these configurations, only the Master BPS power source has a built-in controller and front panel.

P8 / P9	Description
1	OUTP: Output ON. Controls state of output relay
2	N/C
3	N/C
4	N/C
5	COM: Common. Signal return.
6	OT: Over temperature. Indicates over temperature condition.
7	N/C
8	CLB: Current Limit B. Programmed current limit reference for phase B
9	CSA: Current Sum Phase A
10	CSC: Current Sum Phase C
11	FLT A: Amplifier Fault Phase A
12	FLT C: Amplifier Fault Phase C
13	XFMR: Optional voltage range select. (-HV or -XV option)
14	PARALLEL: Parallel operation control.
15	INPUT ON: Input power status
16	A ERR LO: Error Signal Phase A, low
17	B ERR HI: Error Signal Phase B, high
18	N/C
19	C ERR LO: Error Signal Phase C, Low
20	300 VRNG: 300 V AC Range Select
21	COM: Common. Signal return.
22	/REM OFF: Remote Off Control not
23	COM: Common. Signal return
24	FLK/BYP: Flicker / Bypass OMNI control
25	/OVL: Overload not

P8 / P9	Description
26	CLA: Current Limit A. Programmed current limit reference for phase A
27	CLC: Current Limit C. Programmed current limit reference for phase C
28	CSB: Current Sum Phase B.
29	N/C
30	FLT B: Amplifier Fault Phase B
31	N/C
32	DC: DC mode control
33	INP OFF: Input power control
34	A ERR HI: Error Signal Phase A, high
35	N/C
36	B ERR LO: Error Signal Phase B, low
37	C ERR HI: Error Signal Phase C, high

Table 4-4: System Interface Connectors

4.7.2 Analog Input Connector

Input screw-terminal strip. Functions are called out on rear panel decal. Table shows connections from left to right when standing at the rear of the BPS cabinet.

Pin	Description
1	RPV HI. INPUT: Analog input for External Modulation
2	RPV Lo. INPUT: return.
3	EXT SYNC HI INPUT: Analog input for external sync mode.
4	EXT SYNC Lo INPUT: return.
5	RI: INPUT: Remote Inhibit. (See paragraph 4.10.)
6	RI: INPUT: return.

Table 4-5: Analog Interface Connector

4.7.3 BNC Connectors

BNC connectors. Functions are called out on rear panel decal. Table shows connections from left to right when standing at the rear of the BPS cabinet.

Table 4-6: BNC Connectors

BNC	Description
1	Trigger Input (TTL input)
2	Trigger Output (TTL output) (Same signal connection as Function Strobe. Some units may not have this output connected. If you don't get an output trigger on this BNC, use the Function Strobe BNC instead.)
3	Function Strobe (TTL output) (Same signal connection as Trigger Output)
4	Clock (TTL output on Master / TTL input on Auxiliary). Not available on all models.
5	Lock (TTL output on Master / TTL input on Auxiliary) .Not available on all models.
6	Emergency Shut off inter connect. Not required on single master systems.

Table 4-7: BNC Connectors

4.7.4 External Sense Connector

Pin	Description
1	Phase A sense
2	Phase B sense
3	Phase C sense
4	Neutral sense

Table 4-8: External Sense Connector

4.7.5 RS232C Serial Interface Connector

An RS232 serial interface connector is located on the rear panel on all models.

Pin	Name	Direction
1	N/C	
2	TxD	Output
3	RxD	Input
4	N/C	
5	Common	Common
6	N/C	
7	CTS	Input
8	RTS	Output
9	N/C	

Table 4-9: RS232 Connector pin out – BPS Series with RS232 and USB.

The BPS Series models RS232 interface use a straight through DB9 male to DB9 female serial cable, which is supplied in the BPS ship kit for these models.

4.7.6 USB Interface

A standard USB Series B device connector is located on the rear panel for remote control. A standard USB cable between the AC Source and a PC or USB Hub may be used.

Note: *Use of the USB port to control more than one power source from a single PC is not recommended, as communication may not be reliable. Use GPIB interface for multiple power source control.*



Figure 4-10: USB Connector pin orientation.

Pin	Name	Description
1	VBUS	+5 VDC
2	D-	Data -
3	D+	Data +
4	GND	Ground

Table 4-10: USB Connector pin out.

4.7.7 LAN Interface – RJ45

An optional RJ45 Ethernet 10BaseT connector is located on the rear panel for remote control. A standard RJ45 UTP patch cord between the AC Source and a network Hub may be used to connect the AC source to a LAN. For direct connection to a PC LAN card, a crossover RJ45 cable is required. Consult your network administrator for directions on connecting the AC source to any corporate LAN.

If the –LAN Ethernet interface option is present, the MAC Address (Media Access Control) of the Ethernet port is printed on the serial tag of the power source. The serial tag is located on the rear panel of the unit.

For information on how to set up a network connection or a direct PC connection using the LAN interface, refer to the BPS Series Programming Manual distributed in Adobe PDF format on the CD ROM provided.

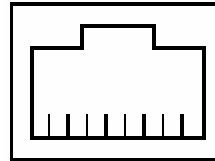

8 7 6 5 4 3 2 1

LAN

Pin	Ethernet TPE 10BaseT/100BastT/1000BaseT	EIA/TIA 568A	EIA/TIA 568B Crossover
1	Transmit/Receive Data 0 +	White with green stripe	White with orange stripe
2	Transmit/Receive Data 0 -	Green with white stripe or solid green	Orange with white stripe or solid orange
3	Transmit/Receive Data 1 +	White with orange stripe	White with green stripe
4	Transmit/Receive Data 2 +	Blue with white stripe or solid blue	Blue with white stripe or solid blue
5	Transmit/Receive Data 2 -	White with blue stripe	White with blue stripe
6	Transmit/Receive Data 1 -	Orange with white stripe or solid orange	Green with white stripe or solid
7	Transmit/Receive Data 3 +	White with brown stripe or solid brown	White with brown stripe or solid brown
8	Transmit/Receive Data 3 -	Brown with white stripe or solid brown.	Brown with white stripe or solid brown

Table 4-11: RJ45 LAN Connector pin out.

4.8 Multiple Cabinet Power Up/Down Procedures

For all multi-cabinet BPS Series configurations (BPS150 through BPS180), the following Power Up (Turn on) and Power Down (Turn off) procedures should be observed for best performance.

4.8.1 Power Up Procedure

Follow these steps:

1. Turn on each of the Auxiliary units using the front panel circuit breaker, one at a time. The exact order for turning on the auxiliary units is not important. Note that the bias supplies of each of the auxiliary cabinets will power up but not the actual amplifiers. This is because the auxiliary units are waiting for the turn on signal from the master unit.
2. Once all auxiliary units are on, **turn on** the **MASTER** unit **LAST** using the front panel circuit breaker. The master unit will go through an initialization process and power up itself plus the auxiliary units.
3. Allow 20 to 30 seconds for the turn on sequence to complete before attempting to communicate with the system.

4.8.2 Power Down Procedure

The power-down / shutdown sequence for the system is the reverse of the power-up / turn-on sequence. This means the MASTER unit is turned off **FIRST**. Once the MASTER shuts down, all auxiliary units' main AC input power contactors will open up automatically. They still need to be turned off individually using the front panel circuit breaker. This will shut down their bias supplies as well.

Follow these steps:

1. Disconnect the EUT by opening the BPS output relay. Use the Output On/Off button on the master unit front panel or send the "OUTPUT 0" command over the bus to do so.
2. **Turn off** the **MASTER** unit **FIRST** using the front panel circuit breaker. The master unit will disengage the main AC power input contactors of all auxiliary units at this time.
3. Next, turn off each of the Auxiliary units using the front panel circuit breaker, one at a time. The exact order for turning off the auxiliary units is not important.

4.9 Basic Initial Functional Test



CAUTION: *Work carefully when performing these tests; hazardous voltages are present on the input and output during this test.*

Refer to Figure 4-11 for the required functional test set up. Proceed as follows to perform a basic function check of the power system:

1. Verify the correct AC line input rating on the nameplate of the BPS unit(s) and make sure the correct three-phase line voltage is wired to the input of the BPS before applying input power.
2. Connect a suitable resistive or other type load to the output of the BPS. The load resistance value will depend on the voltage range you plan to check. Make sure the power resistor has sufficient power dissipation capability - up to 30 KW for full load test on one phase of BPS90 models and that the load used does not exceed the maximum power rating of the BPS. For three phase configurations, this test can be performed on one phase at a time if needed.
3. Connect an oscilloscope and DMM / voltmeter to the AC source output. Set both for AC mode.
4. If the correct voltage is present, turn on the BPS unit(s) by closing the On/Off circuit breaker on the front panel. For multi-cabinet systems, turn on the auxiliary unit first and wait for them to cycle on, then turn on the master unit.
5. If the BPS has more than one available output voltage range, go to the PROGRAM 1 screen and select the desired voltage range. The output mode can be set from the PROGRAM 2 screen (use the MORE soft key or press the PROGR function key again). Select AC mode.
6. Set the output voltage to 0 volt and close the output relay with the OUTPUT ON/OFF button. There should be little or no output although the DMM may show a noise level, especially if the DMM is in auto ranging mode.
7. Move the cursor to the VOLTAGE field in the PROGRAM 1 screen and either use the keyboard to program a small voltage (20 VAC) or slew the voltage up slowly with the knob. Observe the DMM reading. The reading should track the programmed voltage.
8. Also monitor the scope. The output should be a sinusoidal voltage waveform.
9. If the output tracks, increase the voltage till you reach 80 % of the voltage range or more. Check the output voltage reading and waveform.
10. Select the MEASUREMENT 1 screen by pressing the MEAS button. The output voltage, current and power will be displayed. For three phase configurations, use the PHASE button to select the \emptyset ABC display mode. This will show the voltage, current and power for all three phases. If all phases are loaded equally, the same current and power should be visible for all three unless the voltages are not programmed to the same level. If only one phase is loaded, current and power will only be shown for the loaded phase.

In the unlikely event the power source does not pass the functional test, refer to the calibration procedure in Section 7 or call AMETEK Programmable Power customer service department for further assistance.

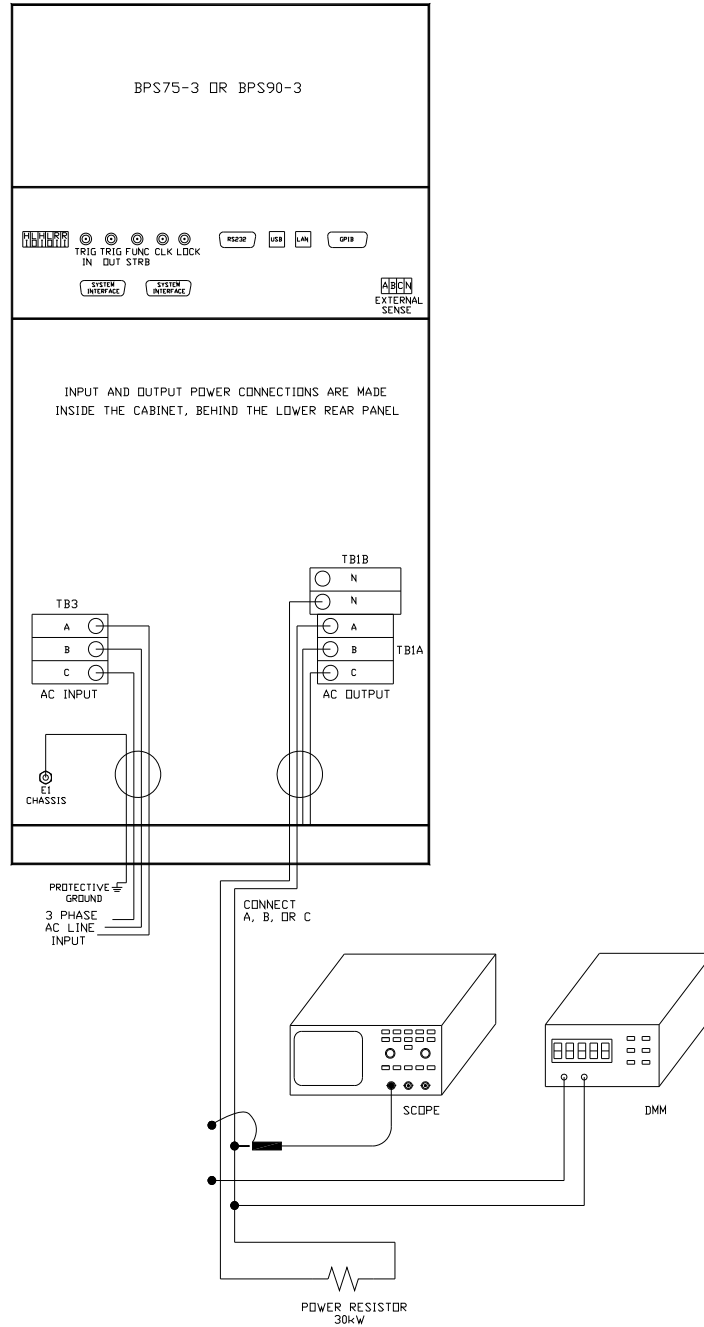

Figure 4-11: Functional Test Setup.

4.10 Remote Inhibit / Remote Shutdown

It may be necessary to provide a remote shutdown of the AC output of the BPS. The external remote inhibit input may be used for this purpose (RI). This input is also referred to as remote shutdown.

The default mode of operation for the RI input is a contact closure between pins 5 and 6 (return) of the rear panel screw-terminal strip. This will open the output relay of the BPS.

It is possible to reverse the polarity of the RI input. This requires the use of the following bus command:

OUTPut:RI[:LEVel] HIGH /* Sets RI polarity to active high.

OUTPut:RI[:LEVel] LOW /* Sets RI polarity to active low (Factory default)

The remote control interface must be used to change this setting. Once set, the polarity setting remains in effect.

The way the BPS responds to a remote inhibit event can be programmed over the remote control interface using the OUTP:RI:MODE command. See BPS Programming Manual for details on changing modes. The mode set is retained at power off and recalled at power up so stays in effect till changed again over the bus.

The following modes are supported.

MODE	OPERATION
LATCHING	A TTL low at the RI input latches the output in the protection shutdown state. This state can only be cleared by sending a OUTPut:PROTection:CLEAr command over the bus.
LIVE	The output state follows the state of the RI input. A TTL low or contact closure at the RI input turns the output off; a TTL high or open contact turns the output on. This mode is equivalent to using the Output On/Off button on the front panel. Default mode. Units are shipped in this mode.
OFF	The instrument ignores the RI input.

Table 4-12: Remote Inhibit Mode Settings

NOTE: When using the Remote Inhibit input, it will be necessary to disconnect any RI connection to the BPS master unit when turning on the BPS master unit. During initialization, the RI connection must be OPEN or initialization will be halted with the message **WARING FOR AUXILIARY** displayed on the LCD screen.

5. Front Panel Operation

5.1 Tour of the Front Panel

The BPS Series controllers have identical front panels although some of the keys found on the front panel are only used by certain BPS models. Unused keys will be “don’t cares” in their functions. This chapter provides information on operating the BPS front panel controls.

Before operating the AC source using the front panel, it helps to understand the operation of the front panel controls. Specifically, the operation of the knob, keyboard and the menu layout are covered in the next few paragraphs.

5.1.1 Front Panel Controls and Indicators

The front panel can be divided in a small number of functional areas:

- Mains circuit breaker
- Status Indicator lights
- Shuttle knob
- LCD display
- FUNCTION keypad
- DATA ENTRY keypad

5.1.2 System On/Off Circuit Breaker

The circuit breaker located on the bottom left side of the front panel disconnects the low voltage supply of the BPS Source from the three phase Line input. This will remove power from the mains AC input contactor and thus remove input power from the BPS Series power source. As such, the circuit breaker acts as an indirect power on/off switch for the BPS Series unit. Note however that AC input power remains applied to the primary side of the input transformer.

When the input current rating of the BPS Series AC power source is exceeded, the protective fuses (F1 through F3 or F1 through F6 depending on model) will blow. In this case, power to the low voltage supply may still remain through the front panel circuit breaker. In this case, the on/off circuit breaker should be opened (power off) first followed by a complete disconnect of all ac input power through an installed main circuit breaker.

Note that in multi-box BPS150 and BPS180 system configurations, each chassis has its own on/off circuit breaker and set of line input fuses.

5.1.3 Status Indicator Lights

Four LED status indicators are located directly above the mains circuit breaker. These LED's correspond to the following conditions:

REMOTE	The REMOTE LED indicates that the unit is in remote control mode. If the IEEE-488 interface is used, this indicator will be lit whenever the REM line (REMOTE ENABLE) line is asserted by the IEEE controller. If the RS232, USB or LAN interface is used, the REMOTE state can be enabled by the controller using the SYST:REM command. Any time the REMOTE LED is lit, the front panel of the BPS Series unit is disabled. There is no LOCAL button that allows the user to regain control of the front panel. This prevents accidental change of settings in ATE applications.
OVERLOAD	The OVERLOAD LED indicates an output overload condition. This condition can be controlled by setting the current limit value in the PROGRAM menu. Removing the load using the OUTPUT ON/OFF button will recover from an overload condition.
OVER TEMPERATURE	The OVER TEMPERATURE LED indicates an overheating problem inside the unit. This is an abnormal condition, which will cause the unit to shut off. Check the air openings to make sure they are not blocked.
HI RANGE	The HI RANGE LED is on when the high voltage output range has been selected.

5.1.4 The Shuttle Knob

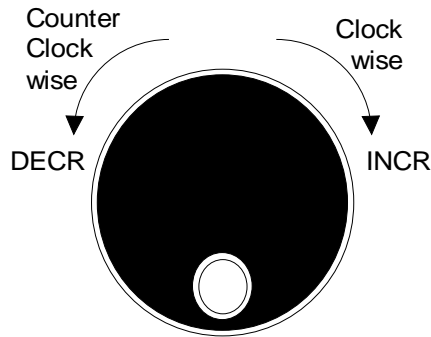

Figure 5-1: Shuttle Knob

The shuttle knob is located to the right of the LCD screen and is used to change setup parameters. Note that it cannot be used to move the cursor position between menu fields. Use the UP and DOWN arrow keys in the FUNCTION keypad for this.

The shuttle knob can operate in one of two distinct modes of operation:

MODE	DESCRIPTION
IMMEDIATE mode	Any time the ENTER key is pressed, the BPS Series returns to its normal mode of operation. In this mode, changes made with the shuttle knob or the data entry keypad will take immediate effect. The IMMEDIATE mode is useful for slewing output values such as voltage and frequency and observing the effect on the load.
SET mode	When the SET key located in the FUNCTION keypad is pressed, changes made with the shuttle to any output parameter will not take effect until the ENTER key is pressed. In this mode, any changes made to a setup menu will be blinking to indicate the pending change condition. This mode allows changes to be made to all output parameters and executing them all at once by pressing the ENTER key.

5.1.5 FUNCTION Keypad

The function keypad provides access to all menus and measurement screens.

Note: Not all screen functions indicated in this section of this manual are available on the BPS model power source. Consult factory for further information about any additional options.

The following keys are located in the FUNCTION keypad:

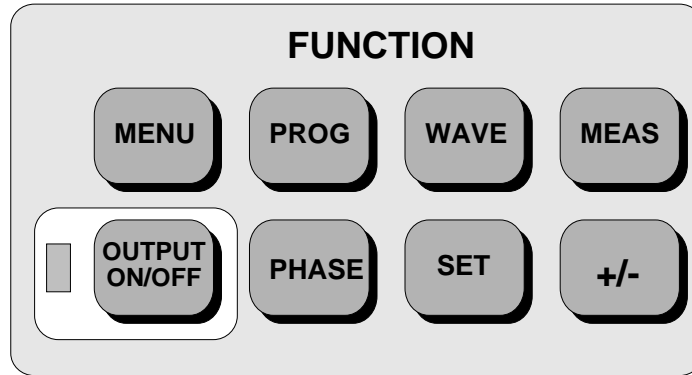

Figure 5-2: FUNCTION Keypad

KEY	DESCRIPTION
MENU	The top level menu is accessed by pressing the MENU key. Three shortcut keys are used to provide direct access to the PROGRAM, WAVEFORM, and MEASUREMENT screens as these are among the most frequently used screens. Thus, instead of going through the main menu to reach the PROGRAM, WAVEFORM, and MEASUREMENT screens, they can be accessed directly by pressing the PROG, WAVE, and MEAS keys respectively. A map of the Main menu is provided on the next few pages. There are three top level menus in the BPS Series.
PROG	The PROG key is a shortcut to access the PROGRAM menu directly. The PROGRAM menu is one of the most frequently used menus. Thus, instead of going through the main menu to reach the PROGRAM menu, it can be accessed directly by pressing the PROG key.
WAVE	The WAVE key is a shortcut to access the WAVEFORM screen directly. The WAVEFORM screen is used to select a user defined arbitrary waveform.
MEAS	The MEAS key is a shortcut to access the MEASUREMENT screen directly. The MEASUREMENT screen is one of the most frequently used screens. Thus, instead of going through the main menu to reach the MEASUREMENT screen, it can be accessed directly by pressing the MEAS key.

OUTPUT ON/OFF	The OUTPUT ON/OFF key toggles the output relay on or off. The state of the output relay is reflected by the green LED located directly to the left of the OUTPUT ON/OFF key. If the green LED is lit, the output relay is enabled (closed) and the programmed output voltage is present at the output terminals. If the green LED is off, the output relay is open and both the HIGH and LO terminal of the output terminal block are disconnected from the power source. In this mode, the output is floating. The ON/OFF button provides a convenient way to disconnect the load without having to remove any wires.
PHASE	The PHASE key is used to select the phase on a BPS power source. Pressing the PHASE key will toggle phase A, B, C or ABC. Some screens may not support the ABC or show all phase information in which case this mode is skipped.
SET	The SET key is used to select the mode of operation of the shuttle. Refer to section 5.1.1 for details on its operation and the use of the SET key.
+/-	The +/- key can be used to toggle the sign for those parameters for which it is relevant. This is typically the output voltage when in DC mode of operation. For fields that have only two possible values such as the voltage range field, the +/- key can be used to toggle between these two values.

5.1.6 DECIMAL KEYPAD

The decimal keypad may be used to enter any numeric parameter required in any of the menu fields. Several fields accept input from either the keypad or the knob. Data entered from the keypad is normally accepted once the ENTER key is pressed unless the front panel mode is in the SET mode. The following keys are available on the decimal keypad:

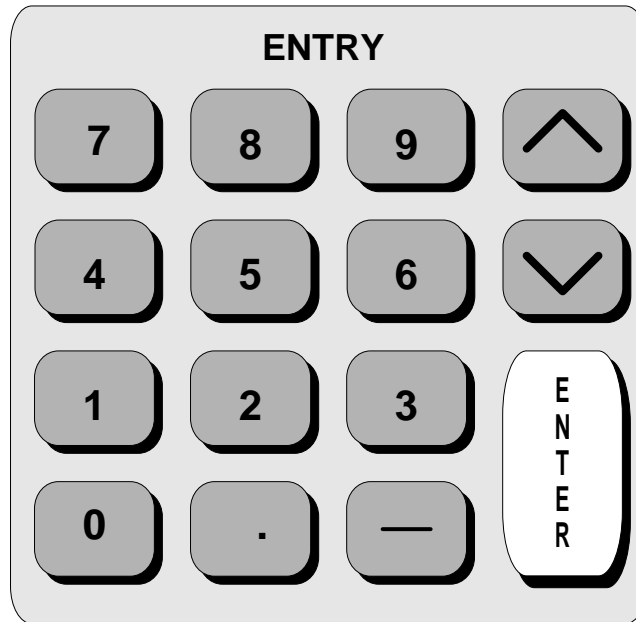

Figure 5-3: Entering Values from the Decimal Keypad

CURSOR UP

The UP key moves the cursor position upwards one position to the previous available cursor position. If the present cursor position is at the top of the right hand column, the cursor is moved to the bottom position of the left hand column. If the present cursor is at the top of the left hand column, the cursor is moved to the bottom of the right hand column. Figure 5-4 depicts the cursor movement through a two column menu.

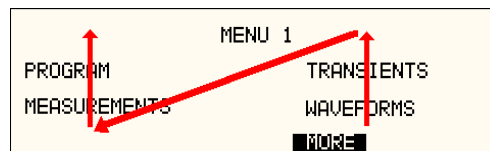

Figure 5-4: Cursor UP Key Movement

CURSOR DOWN

The DOWN key moves the cursor position downwards one position to the next available cursor position. If the present cursor position is at the bottom of the left hand column, the cursor is moved to the top position of the right hand column. If the present cursor is at the bottom of the right hand column, the cursor is moved to the top of the left hand column. Figure 5-5 depicts the cursor movement through a two-column menu.

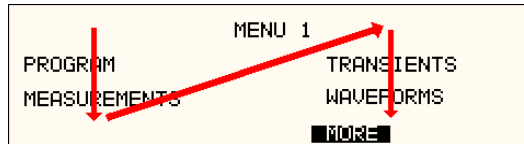

Figure 5-5: Cursor DOWN key Movement

The decimal keypad can be used at any time in lieu of the shuttle knob to change output parameters. Direct data entry is often faster to effect large changes in values than using the shuttle knob. Note that pressing the ENTER key while in SET mode of operation will cause the AC source to revert back to IMMEDIATE mode. Thus, to change all parameters in SET mode, enter a value for each field and then proceed to the next field without pressing the ENTER key.

- 0 through 9. The numeric keys provide all decimal number for entry of parameters.
- DECIMAL POINT The decimal point key is used to enter fractional parts of values for fields that have a resolution less than 1. The amount of resolution for each menu field is normally visible on the LCD. If more digits are entered after the decimal point than can be accepted by a field, the value is automatically rounded to the available resolution when the ENTER key is pressed.
- BACKSPACE The BACKSPACE (←) key can be used to erase one digit at a time if you make a data entry error.

5.1.7 LCD Display

The LCD display of the BPS Series power source provides information on instrument settings and also guides the user through the various menus. To ease reading of the displayed information, most screens are widely spaced. A sample of the main menu 1 screen that appears when the BPS Series source is powered up is shown in Figure 5-6. Due to the amount of space available on each screen, some menus have been split into parts. The MORE selection located at the bottom right hand side provides access to menu choices at the same level that did not fit on a single screen. Thus, to access MENU 2, the cursor should be placed on the 'MORE' selection followed by pressing the 'ENTER' key. Alternatively, the MENU key may be pressed to move to the MENU 2 screen.

The present cursor position is always shown with a inverse bar. The cursor is located on the 'MORE' selection in Figure 5-6. Pressing ENTER would cause MENU 2 to be displayed.

The cursor position can be moved by using the UP and DOWN keys located in the **DECIMAL** keypad.

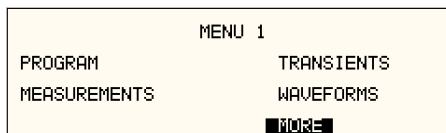

Figure 5-6: Main Menu 1 Screen

5.2 Menu Structure

The next few pages show a map of the available menus in the BPS Series. There are three main level (level 1) menus from which all other menus can be reached. Frequently used (level 2) menus have a short cut key that provides direct access. Examples of such menus are Program, Measurements, and Waveform. In any case, there are never more than three levels of menus although some menus may be spread across more than one screen.

Note: Not all features and options shown are available on the BTS Series product. Please consult the date sheet for further information and the availability of upgrades.

5.2.1 MAIN Menus

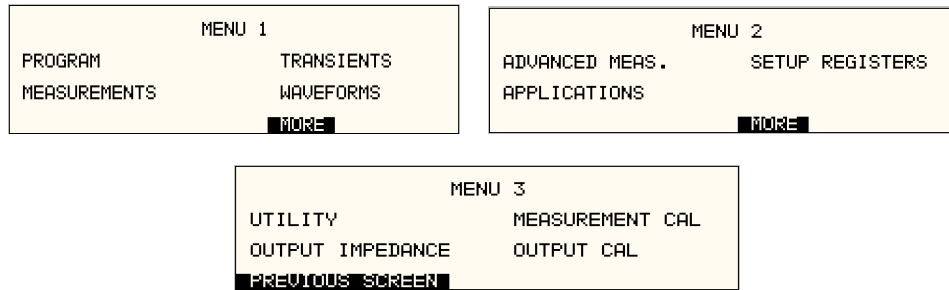

Figure 5-7: Menu 1 through 3

The top-level menu is split in three parts, MENU 1 through MENU 3 to allow spacing between menu entries. MENU 2 and 3 can be reached from MENU 1 by selecting the MORE entry or by pressing the MENU key repeatedly, which will toggle from MENU 1 to 2 to 3 and back to 1. The division of menu choices between the two screens is graphically illustrated in 5.2.2 by the boxes in level 1. Each box represents one screen. Subsequent screens can be reached using the MORE entry.

The following top-level menu choices can be accessed from the MENU key:

Entry	Description
<i>MENU 1</i>	
PROGRAM	The PROGRAM menu allows output parameters to be changed.
MEASUREMENTS	The MEASUREMENTS screens are not menus in that no user entries are required.
TRANSIENTS	The TRANSIENTS menu allows output transients to be programmed.
WAVEFORMS	The WAVEFORMS menu allows different waveforms to be selected from the waveform library. Not available on all models.
MORE	The MORE selection causes the second part of the MENU screen to be displayed. (MENU 2)
<i>MENU 2</i>	
ADVANCED MEAS.	The ADVANCED MEAS. screens are for display only. No user entries are required. Not available on all models.
APPLICATIONS	The APPLICATIONS menu provides access to the optional firmware application programs that may be installed in the BPS Series AC source. Not all applications are available on this model power source.
SETUP REGISTERS	The SETUP REGISTERS menu allows complete instrument settings and transient list programs to be saved to nonvolatile memory.
MORE	The MORE selection causes the third part of the MENU screen to be displayed. (MENU 3)
<i>MENU 3</i>	
UTILITY	The UTILITY menu provides access to less commonly used setup screens such as those for the GPIB and RS232C (also applies to USB and LAN) interface settings, initial startup values, etc.
MEASUREMENT CAL	The MEASUREMENT CAL menu allows for calibration of the AC source measurement system.
OUTPUT CAL	The OUTPUT CAL menu allows for calibration of the AC source output.

Following the Menu overview pages is a detailed description of each menu and sub menu.

5.2.2 Overview of Menu 1

	level 1	level 2	level 3			
MENU 1	PROGRAM	PROGRAM1 VOLTAGE FREQ VOLT RANGE CURR LIMIT MORE				
		PROGRAM2 PHASE CLOCK MODE VOLT MODE DC OFFSET START ϕ				
	MEASUREMENTS	MEASUREMENTS1 VOLTAGE CURRENT FREQ POWER MORE	MEASUREMENTS 2 VA POWER PEAK CURR POWER FACT CREST FACT PEAK CURR RESET	MEASUREMENTS 3 VOLT THD CURR THD INST PK CURR PHASE	HARMONICS/TRACE ANALYSIS FUNCTION VIEW DATA MODE SCALE TRIG MODE TRIG SOURCE TRIG PHASE TRIG DELAY START	
TRANSIENTS	VOLT SURGE/SAG VOLT SWEEP/STEP FREQ SWEEP/STEP VOLT/FREQ SWEEP/STEP START/VIEW SEQUENCE PREVIOUS SCREEN	START PAUSE REPEAT #0 CLEAR SEQ #1 #2 .. #98 #99 PREVIOUS SCREEN	DURATION END VOLT END FREQ END DELAY FUNCTION REPEAT SEQUENCE# PREVIOUS SCREEN	DURATION END FREQ END DELAY FUNCTION REPEAT EVENT# PREVIOUS SCREEN	START ϕ END VOLT DUR SCALE DURATION END DELAY FUNCTION REPEAT EVENT# PREVIOUS SCREEN	START ϕ GO TO VOLT DUR SCALE DURATION END VOLT END DELAY FUNCTION REPEAT EVENT# PREV. SCREEN
WAVEFORMS	CLIP LEVEL GROUP MODE SINE SQUARE CLIPPED USER WAVE USER WAVE					
MORE						

5.2.3 Overview of Menu 2 and 3

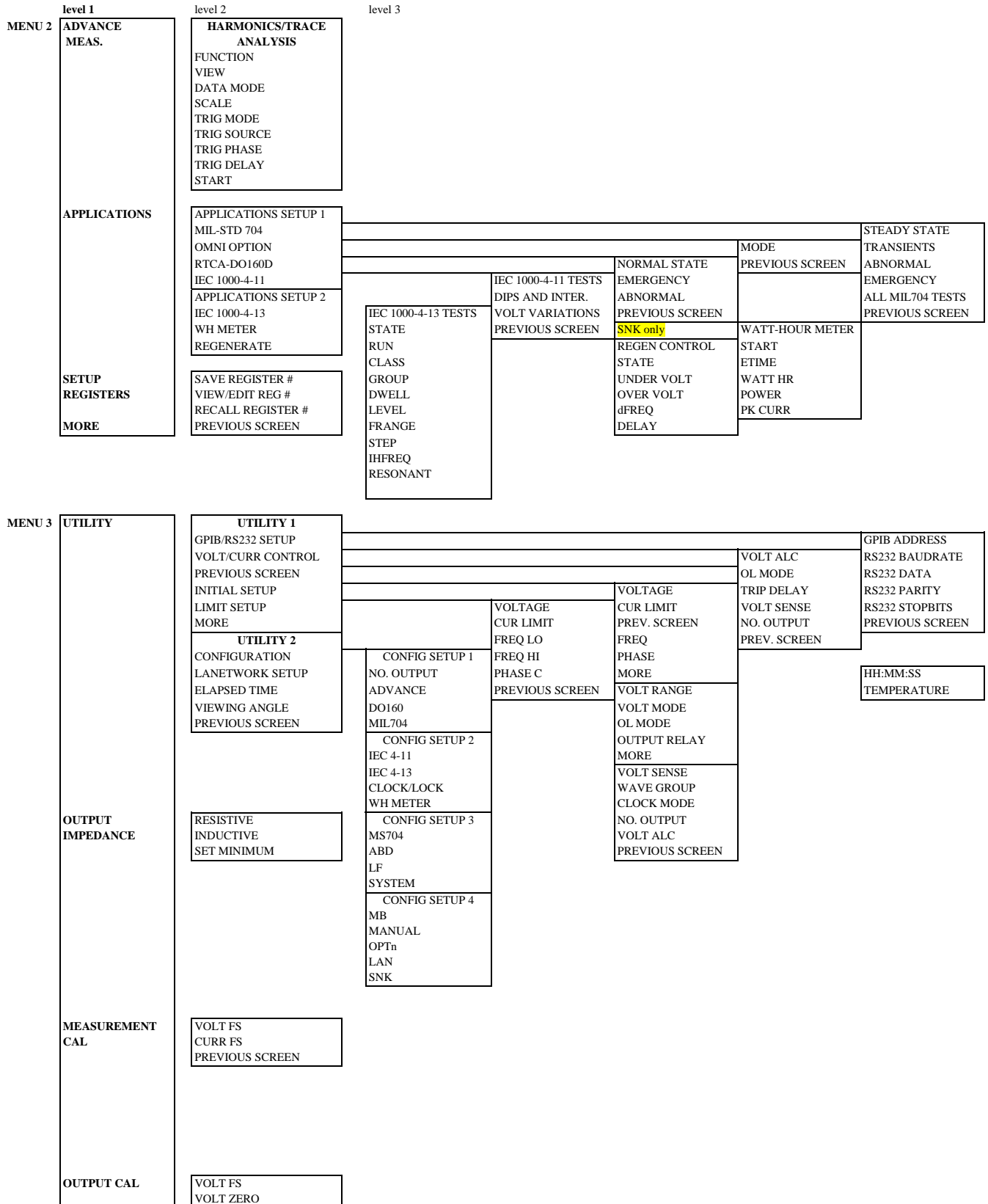

	PHASE OFST IHARM FS IMP. REAL FS IMP. REACT FS IMP. REAL MIN IMP. REACT MIN PREVIOUS SCREEN
--	---

5.2.4 PROGRAM Menu

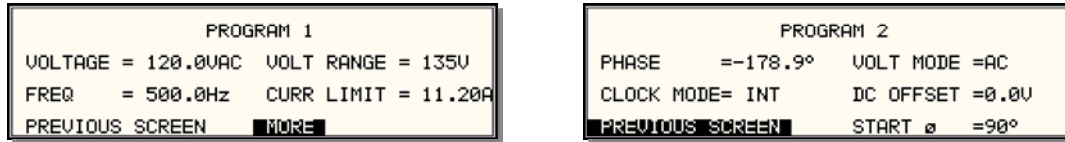

Figure 5-8: PROGRAM Menu

The PROGRAM menu is shown in Figure 5-8. It can be reached in one of two ways:

1. by selecting the PROGRAM entry in the MENU screen and pressing the ENTER key
2. by pressing the PROG key in the FUNCTION keypad

The PROGRAM menu is used to change output parameters. The most commonly used parameters are all located in PROGRAM 1. The PREVIOUS SCREEN entry, when selected, will return the user to the most recently selected menu. This is normally the MENU screen unless the PROGRAM menu was selected using the PROG key on the FUNCTION keypad. Less frequently used parameters are located in PROGRAM 2, which can be reached from the PROGRAM 1 screen using the MORE selection, or by pressing the PROGRAM key twice.

The following choices are available in the PROGRAM menus:

Entry	Description
PROGRAM 1	
VOLTAGE	Programs the output voltage in Vrms while in AC mode or absolute voltage when in DC mode. In DC mode, negative values can be entered.
FREQ	Programs the output frequency when in AC mode. If the unit is in DC mode, the value for FREQ will be set to DC and cannot be changed until AC mode is selected. When in AC mode, the frequency can be changed from 16 Hz to 500 Hz. Values entered that fall outside this range will generate a -200 RANGE ERROR and will not be accepted.
VOLT RANGE	Selects 150V, 300V or optional 400V range in AC mode and 200V or 400V range in DC mode. The actual range values may be different depending on the configuration. The value of this field can only be changed with the shuttle or the +/- key.
CURR LIMIT	Sets the current limit value for the current detection system. When the load current value exceeds the set current limit, a fault condition is generated. The actual response of the AC Source to a current limit fault is determined by the protection mode selected in the CONFIGURATION menu. (CC = Constant Current, CV = Constant Voltage).

PROGRAM 2

PHASE	Selects the phase angle between the external clock and the output of the AC source. If the clock source is internal, this parameter has no effect.
CLOCK MODE	Selects internal or external clock source. The BPS Series controller uses an open-air crystal time base with an accuracy of 100 ppm. To improve output frequency stability and accuracy, an external clock generator may be used.
VOLT MODE	The BPS Series offers three output modes, AC, DC and AC+DC. The VOLT MODE field can be used to toggle between these three output modes. Both the Knob and the +/- key may be used to toggle through these three selections. In DC mode, no frequency selection is possible and all maximum current and power ratings are divided by two.
DC OFFSET	When the AC+DC mode is selected, the VOLTAGE field in the PROGRAM 1 screen is used to set the AC portion of the output voltage. The DC OFFSET field in the PROGRAM 2 screen can be used to set the DC offset level. Either the knob or the decimal keypad may be used to set the DC offset level.
START ϕ	Selects the start phase angle for output changes made to either voltage or frequency. This allows changing the output at a specific phase angle. The output on key also uses this phase angle setting to program the output voltage up to the set level after the output relay is closed. The default value for this field is RANDOM.

5.2.5 MEASUREMENTS Screens

The BPS Series uses a DSP based data acquisition system to provide extensive information regarding the output of the Source. This data acquisition system digitizes the voltage and current waveforms and calculates several parameters from this digitized data. The result of these calculations is displayed in a series of measurement data screens. The actual digitized waveforms can also be displayed by selecting the Harmonics/Trace Analysis screen. A total of four measurement screens are used to display all this information.

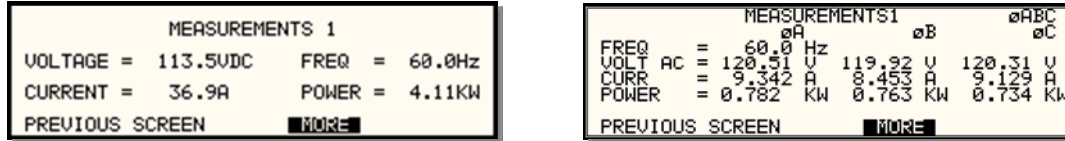

Figure 5-9: MEASUREMENTS Screen, Single Phase and Three Phase Modes

The first three Measurement screens available on the BPS Series are not menus in that no changes can be made anywhere. Instead, these three screens provide load parameter readouts. The fourth measurement screen provides access to the advanced measurements and does offer several user accessible fields. The measurement screens can be reached by successively pressing the MEAS key, which will toggle to all four available screens.

In three-phase mode, measurements are available for each phase individually. To select the desired phase, use the PHASE key to toggle through phase A, B, C, or ABC. The ABC mode displays the data for all three phases simultaneously.

The following parameters are available in the first three measurement screens:

Entry	Description
MEASUREMENT 1	
VOLTAGE	When in AC or AC+DC mode, this value is the true rms output voltage measured at the voltage sense lines. In DC only mode, the voltage is the DC voltage including polarity.
CURRENT	When in AC or AC+DC mode, this value is the true rms output current drawn by the load. In DC only mode, the current is the DC current including polarity.
FREQ	When in AC or AC+DC mode, the output frequency is measured at the sense lines. When in DC only mode, this value always reads "DC".
POWER	In both AC and DC mode, this value is the real rms. power consumed by the load.
MEASUREMENT 2	
VA POWER	In AC or AC+DC mode, this value is the apparent rms. power consumed by the load. In DC mode, this value is always the same as the POWER readout.
PEAK CURR	This readout reflects the peak current value detected at the output. To measure inrush current for a unit under test, open the output relay and reset the peak current value using the PEAK CURR RESET entry. Then program the output voltage and frequency and turn on the output relay. The peak current measurement will continuously track the maximum current value detected until reset.
POWER FACTOR	This readout shows the power factor of the load.
CREST FACTOR	This readout displays the ratio between peak current and rms current.

MEASUREMENT 3

VOLT THD	This readout displays the total voltage distortion for the selected phase. The distortion calculation is based on the H2 through H50 with the fundamental voltage (H1) in the denominator. Note that other common definitions of THD use the RMS value of the voltage as the denominator. This may result in different readings between instruments depending on the implementation chosen. The mode used by the power source is selectable over the bus.
CURR THD	This readout displays the total current distortion for the selected phase. The distortion calculation is based on the H2 through H50 with the fundamental current (H1) in the denominator. Note that other common definitions of THD use the RMS value of the current as the denominator. This may result in different readings between instruments depending on the implementation chosen. The mode used by the power source is selectable over the bus.
INST PK CURR	This readout reflects the instantaneous peak current value detected at the output. This value is updated continuously and does not require a reset operation like the PEAK CURR readout. The instantaneous peak current does not use a track and hold mechanism like the PEAK CURR measurement in the MEASUREMENT 2 screen. Instead, it tracks the peak current on a cycle-by-cycle basis. The INST PK CURR typically tracks the rms current and the crest factor.

Update Program Functions from Measurement Screen

The Shuttle can be used to update program parameters such as voltage, frequency or current from the measurement screen. This can be achieved with the following sequence:

1. Select the program 1 screen using the PROG key.
2. Use the up and down key to select the desired function to update. (Selects parameter that will be changed by the shuttle once in the MEAS1 screen)
3. Select the measurement 1 screen by pressing the MEAS key.
4. The pointer symbol (▶) points to the programmed parameter (V, F or CL) that will be affected by turning the shuttle.

5.2.6 TRANSIENTS Menu



Figure 5-10: TRANSIENTS Menu

The transient menu provides access to the transient list data. Available list length is:100 data points. This is represented by 100 transient step numbers from 0 through 99.

From the Transient menu, the desired transient step type can be selected. Based on the user's choice, the relevant transient type sub menu will be shown. The START/EDIT SEQUENCE sub menu allows the user to review and change any transient step or execute the transient list. When executing a transient list, transient steps are executed in a ascending numerical order. Steps that are not defined are skipped.

The following entries can be found in the TRANSIENTS menu:

Entry	Description
VOLT SURGE/SAG	Voltage surges and sags are temporary changes in amplitude. The output voltage will change from its present value to a user specified value for a specified duration. (Sag if the value is lower, surge if the value is higher.) After this period has expired, the output voltage returns to a user specified end value. This value may or may not be the same as the value present prior to the start of the sag or surge.
VOLT SWEEP/STEP	Voltage sweeps cause the output voltage to change from the present value to a user specified end value at a specified rate of change. A voltage step on the other hand is an instantaneous change in output voltage. The new value will be held for the duration period specified by the user. The final output voltage value of a sweep and a step transient step should be different than the value at the start of the transient step or no change in output value will occur.
FREQ SWEEP/STEP	This transient type is similar to a voltage sweep/step except it affects the frequency. Refer to the previous paragraph.
VOLT/FREQ SWEEP/STEP	This transient type combines the previous two types into a single step. The effect is that of changing the output voltage and frequency simultaneously. Note: While this transient is programmed as a single transient step, two list entries are required to store this information. As such, every VOLT/FREQ SWEEP/STEP used will consume two list entries at a time.
START/VIEW SEQUENCE	This entry allows the user to switch to the transient execution menu. This menu provides a list of all available transient list steps and their sequence numbers. From this menu, transient list execution can be started. The same menu can be used to view or edit any available transient list step or erase a step using the backspace key.

5.2.6.1 VOLT SURGE/SAG sub menu

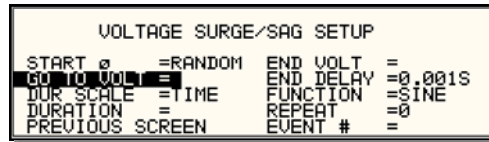

Figure 5-11: VOLTAGE SURGE/SAG SETUP Screen

The Voltage surge and sag screen shown in Figure 5-11 can be reached from the transient screen as follows:

1. Scroll to the VOLT SURGE/SAG entry using the up and down cursor keys.
2. Press the ENTER key to bring up the VOLT SURGE/SAG screen.

The VOLT SURGE/SAG screen has several data fields. All data fields that are blank to the right of the equal sign must be filled or an error message will occur when trying to leave this screen. The EVENT # is the last data field to be filled. Entering the event data field will cause the display to return to the TRANSIENT screen where a new selection can be made.

The VOLT/SURGE/SAG screen has the following fields:

START ϕ	This field will show the start phase angle of the voltage transient in degrees. Only one start phase angle per transient sequence is allowed. The start phase angle must be in the first transient event in the list. The start phase angle is not valid for DC transients. If no start phase angle is required, this field can be set to RANDOM by pressing the BACKSPACE (<-) key on the decimal keypad.
GO TO VOLT	This field will set the voltage level during the transient duration in volts
DUR SCALE	Duration scale default is time in seconds. Use the Shuttle knob to select CYCLES if desired. Note that durations expressed in cycles may cause rounding errors if the period of the selected frequency setting is not an integer number of mss. Thus, for 50 Hz applications, no rounding errors occur but for 60 Hz, the 16.66 ms period will cause a rounding error when converted. The Duration scale selection affects both the DURATION and END DELAY parameters.
DURATION	Duration is the time the output voltage level will dwell at the GO TO VOLT level. The DUR SCALE defines the time scale of this parameter in CYCLES or SECONDS
END VOLT	This is the output voltage level at the end of the transient EVENT and after a time specified by the DURATION
END DELAY	This is the time delay the voltage level will stay at the END VOLT level before it proceeds with the next transient event or completes the transient.
FUNCTION	This field can be used to select the wave shape to be used during this step of the transient sequence. Each step can use a different wave shape from the available library of 50 user-defined waveforms or the three standard waveforms. The output wave shape changes upon entry into each step and remains in effect for the duration of the step. The default wave shape is always the SINE (sine wave).

REPEAT	This is the number of times the SURGE/SAG transient event will repeat before it will proceed to the next event or exit the transient program. Note that the number of times the transient event is generated is equal to the REPEAT + 1. Leave this value at zero if only one execution of this event in the list is required.
EVENT #	This must be the last item in the transient edit screen. All data fields must be entered before inserting the EVENT #. The EVENT # takes a value from 1 to 99. The EVENT # defines the order of execution of the transient events in a multiple event transient. It is a good practice to enter spaced EVENT #'s to allow insertion of an EVENT later if needed. (For example, space them by 5.) Entry of a sequence EVENT # number will cause the display to return to the TRANSIENT screen.

5.2.6.2 VOLTAGE SWEEP/STEP sub menu



Figure 5-12: VOLTAGE SWEEP/STEP SETUP Screen

The Voltage sweep and step screen shown in Figure 5-12 can be reached from the transient screen as follows:

1. Scroll to the VOLT SWEEP/STEP entry using the up and down keys.
2. Press the ENTER key to bring up the VOLTAGE SWEEP/STEP screen.

The VOLTAGE SWEEP/STEP screen has several data fields. All data fields that are blank to the right of the equal sign must be filled or an error message will occur when trying to leave this screen. The EVENT # is the last data field to be filled. Entering the event data field will cause the display to return to the TRANSIENT screen where a new selection can be made.

The VOLTAGE SWEEP/STEP screen has the following fields:

START	This field will show the start phase angle of the voltage transient in degrees. Only one start phase angle per transient sequence is allowed. The start phase angle must be in the first transient event in the list. The start phase angle is not valid for DC transient.
END VOLT	This is the output voltage level at the end of the transient event in volts.
DUR SCALE	Duration scale default is time in seconds. Use the Shuttle knob to select CYCLES if desired. Note that durations expressed in cycles may cause rounding errors if the period of the selected frequency setting is not an integer number of mss. Thus, for 50 Hz applications, no rounding errors occur but for 60 Hz, the 16.66 ms period will cause a rounding error when converted. The Duration scale selection affects both the DURATION and END DELAY parameters.
DURATION	Duration is the time it will take for the output voltage to reach the END VOLT level. As such, "Duration" will define the slew rate of the output voltage for the event. A duration of 0 seconds will cause the output voltage to reach the end voltage immediately. The DUR SCALE defines the time parameter CYCLES or SECONDS
END DELAY	This is the time delay the voltage level will stay at END VOLT before it proceeds with the next transient event or completes the transient.
FUNCTION	This field can be used to select the wave shape to be used during this step of the transient sequence. Each step can use a different wave shape from the available library of 50 user-defined waveforms or the three standard waveforms. The output wave shape changes upon entry into each step and remains in effect for the duration of the step. The default wave shape is always the SINE (sine wave).
REPEAT	This is the number of times the VOLTAGE SWEEP/STEP transient event will repeat before it will proceed to the next event or exit the transient program. Note that the number of times the transient event is generated is equal to the REPEAT + 1. Leave this value at zero if only one execution of this event in the list is required.

EVENT #

This must be the last item in the transient edit screen. All data fields must be entered before inserting the EVENT #. The EVENT # takes a value from 1 to 99. The EVENT # defines the order of execution of the transient events in a multiple event transient. It is a good practice to enter spaced EVENT #'s to allow insertion of an EVENT later if needed. (For example, space them by 5.) Entry of a sequence EVENT # number will cause the display to return to the TRANSIENT screen.

5.2.6.3 FREQUENCY SWEEP/STEP sub menu

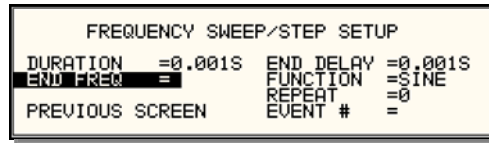

Figure 5-13: FREQUENCY SWEEP/STEP SETUP Screen

The Voltage sweep and step screen shown in Figure 5-13 can be reached from the transient screen as follows:

1. Scroll to the FREQ SWEEP/STEP entry using the up and down cursor keys.
2. Press the ENTER key to bring up the FREQ SWEEP/STEP screen.

The FREQ SWEEP/STEP screen has several data fields. All data fields that are blank to the right of the equal sign must be filled or an error message will occur when trying to leave this screen. The EVENT # is the last data field to be filled. Entering the event data field will cause the display to return to the TRANSIENT screen where a new selection can be made.

The FREQ SWEEP/STEP screen has the following fields:

DURATION	Duration is amount of the time the output frequency will take to reach the END FREQ level. Duration will define the slew rate of the output frequency for the event. A duration of 0 seconds will cause the output frequency to reach the end frequency immediately.
END FREQ	This is the output frequency at the end of the transient event in Hz.
END DELAY	This is the time delay the frequency will stay at END FREQ before it proceeds with the next transient event or completes the transient.
FUNCTION	This field can be used to select the wave shape to be used during this step of the transient sequence. Each step can use a different wave shape from the available library of 50 user-defined waveforms or the three standard waveforms. The output wave shape changes upon entry into each step and remains in effect for the duration of the step. The default wave shape is always the SINE (sine wave).
REPEAT	This is the number of times the FREQUENCY SWEEP/STEP transient will repeat before it will proceed to the next event or exit the transient. The number of times the transient event is generated is equal to the REPEAT + 1. Leave this value at zero if only one execution of this event in the list is required.
EVENT #	This must be the last item in the transient edit screen. All data fields must be entered before inserting the EVENT #. The EVENT # takes value from 1 to 99. The EVENT # defines the order of execution of the transient events in a multiple event transient. It is a good practice to enter spaced EVENT #'s to allow insertion of an EVENT later if needed. (For example, space them by 5.) Entry of a sequence EVENT # number will cause the display to return to the TRANSIENT screen.

5.2.6.4 VOLTAGE/FREQUENCY SWEEP/STEP sub menu

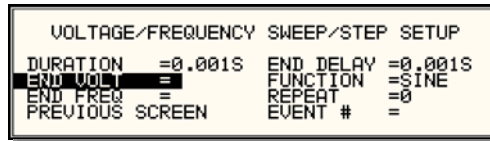

Figure 5-14 VOLTAGE/FREQUENCY SWEEP/STEP SETUP Screen

The Volt/freq sweep/step screen shown in Figure 5-14 can be reached from the transient screen as follows:

1. Scroll to the VOLT/FREQ SWEEP/STEP entry using the up and down cursor keys.
2. Press the ENTER key to bring up the VOLT/FREQ SWEEP/STEP screen.

The VOLT/FREQ SWEEP/STEP screen has several data fields. All data fields that are blank to the right of the equal sign must be filled or an error message will occur when trying to leave this screen. The EVENT # is the last data field to be filled. Entering the event data field will cause the display to return to the TRANSIENT screen where a new selection can be made.

The VOLT/FREQ SWEEP/STEP screen has the following fields:

DURATION	Duration is the amount of time the output voltage and frequency will take to reach the END FREQ and END VOLT levels. Duration will define the slew rate of the output voltage and frequency for the event. A duration of 0 seconds will cause the output voltage and frequency to reach their end value immediately.
END FREQ	This is the output frequency at the end of the transient event in Hz.
END VOLT	This is the output voltage at the end of the transient event in volts.
END DELAY	This is the time delay the output frequency and voltage will stay at END FREQ and END VOLT before proceeding with the next transient event or completing the transient.
FUNCTION	This field can be used to select the wave shape to be used during this step of the transient sequence. Each step can use a different wave shape from the available library of 50 user-defined waveforms or the three standard waveforms. The output wave shape changes upon entry into each step and remains in effect for the duration of the step. The default wave shape is always the SINE (sine wave).
REPEAT	This is the number of times the VOLTAGE/FREQUENCY SWEEP/STEP transient will repeat before it will proceed to the next event or exit the transient. The number of times the transient event is generated is equal to the REPEAT + 1. Leave this value at zero if only one execution of this event in the list is required.
EVENT #	This must be the last item in the transient edit screen. All data fields must be entered before inserting the EVENT #. The EVENT # takes value from 1 to 99. The EVENT # defines the order of execution of the transient events in a multiple event transient. It is a good practice to enter spaced EVENT #'s to allow insertion of an EVENT later if needed. (For example, space them by 5.) Entry of a sequence EVENT # number will cause the display to return to the TRANSIENT screen.

5.2.6.5 *START/VIEW TRANSIENT SEQUENCE sub menu*

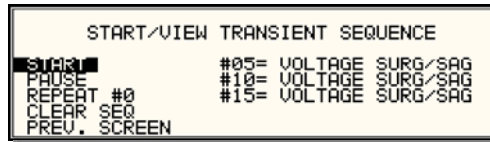

Figure 5-15: START/VIEW TRANSIENT SEQUENCE Screen

The START/VIEW TRANSIENT SEQUENCE screen is used to control transient execution. It also provides an overview of available transient list events. This list appears in the order they were assigned event numbers. Editing an existing event can be accomplished from this screen by positioning the cursor on the event to be edited and pressing the ENTER key. This method can also be used to review the parameters of a previously entered event.

The START/VIEW TRANSIENT SEQUENCE screen has the following fields:

- START / ABORT** The START field is used to start a transient execution. When the cursor is positioned on the START field and the ENTER key is pressed, transient execution starts. The output relay must be closed or an error message will appear and the transient will not start.

Once a transient is in progress, this field changes to ABORT and can be used to abort a transient in progress. If the transient completes execution, the field reverts back to START.
- PAUSE / RESUME** The PAUSE field may be used to suspend execution of a transient list in progress. If the cursor is on the PAUSE field and the ENTER key is pressed, the transient is suspended and this field changes to RESUME. Pressing the ENTER key again will cause the transient list to resume execution from the point where it was suspended.
- REPEAT #** This field determines the number of times a transient list is repeated. The default value is zero, which means the programmed list runs only once. The range for this field is from 0 through 99999. This repeat function should not be confused with the REPEAT function available for individual events. The event specific repeat value will cause only that event to be repeated, not the entire list.
- CLEAR SEQ** Moving the cursor to this field and pressing the ENTER key will cause the entire programmed transient list to be erased. Be careful not to press ENTER accidentally while on this field as you will lose the programmed transient list. Note that a list may be stored as part of the front panel setup in the nonvolatile memory registers.

5.2.7 **SETUP REGISTERS Menu**

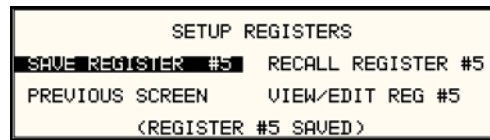

Figure 5-16: SETUP REGISTERS Menu

The SETUP REGISTERS menu allows the user to store and recall complete instrument setups, including transient program lists. A total of 16 non-volatile setup registers is available, numbered sequentially from 0 through 15.

The following entries can be found in the SETUP REGISTERS menu:

Entry	Description
--------------	--------------------

SAVE REGISTER	Save present instrument setup to a register number selected by the user. The numeric data entry keypad should be used to enter a number between 0 and 15. Once the ENTER key is pressed, all settings are saved. A message will appear at the bottom of the screen to confirm the save operation.
RECALL REGISTER	Recall instrument setup from a register number selected by the user. The numeric data entry keypad should be used to enter a number between 0 and 15. Once the ENTER key is pressed, all settings are recalled. A message will appear at the bottom of the screen to confirm the recall operation.
VIEW/EDIT REGISTER	The View/Edit entry can be used to display the contents of a setup register before it is recalled. After the user enters a register number to view or edit and presses the ENTER key, the PROGRAM screen will appear. All parameters that will be changed by recalling the register will be blinking. If ENTER is pressed again, the register will be recalled and the new values take effect. To edit the register content, change all parameters that need to be changed. Pressing ENTER will save the new values and make them active.

5.2.8 UTILITY Menus

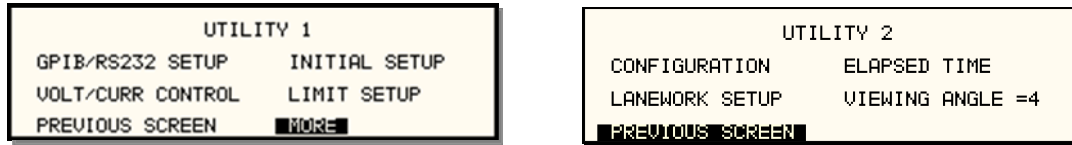

Figure 5-17: UTILITY Menus

The UTILITY menus provide access to less frequently used setup items. There is no connection between the various entries in the UTILITY menu other than there is no other logical place to put them. The following entries can be found in the UTILITY menu:

Entry	Description
UTILITY 1	
GPIB/RS232 SETUP	This entry provides access to the setup parameters for either the IEEE-488, RS232, USB or LAN interface. All parameters are saved in non-volatile memory so there is rarely a need to change these values.
VOLT/CURR CONTROL	<p>The voltage and current control menu can be used to select the current limit method, the voltage sense source.</p> <p>The standard available voltage range pairs are 150 Vac and 300 Vac in AC mode or 200 Vdc and 400 Vdc in DC mode.</p> <p>The two current limit choices are Constant Voltage and Constant Current. Constant Voltage mode will maintain the set voltage at the output until the load current exceeds the current limit setting at which time the voltage will be dropped to zero. This effectively shuts off the AC source output in case of an overload condition. This mode has user programmable trip delay, which is located in the same menu.</p> <p>Constant Current mode will maintain the load current at the maximum level set by the current limit value, even if the maximum power level is exceeded. This is done by reducing the voltage as needed. As such, the voltage will be reduced from the set level down to zero depending on the load requirement. This mode is useful for starting up motor or capacitor loads that may require a high inrush current. This mode also has a user programmable trip delay.</p> <p>Voltage sensing for regulation and measurement can be selected for internal or external. External voltage sensing can compensate for voltage drops caused by load cable impedance. To achieve the best output regulation select external sense and connect the voltage sense wires at the load.</p>
INITIAL SETUP	The initial setup menu can be used to determine the AC source settings at power up. CAUTION: The initial setup can be used to power up the AC source with the output on and a high voltage present at the output. For normal situations, this is not recommended due to the potential danger to operators. It is recommended that the initial voltage be set low and/or the output relay be programmed to OFF for most situations.
LIMIT SETUP	The Limit menu shows the frequency, voltage and current limit capabilities of the AC source. Any attempt to program the output beyond these limits will result in a “-222 Data Out of Range error”. Note that these limits are hardware determined and cannot be changed by the user. They are shown for reference only.

UTILITY 2

CONFIGURATION

The Configuration menu shows the installed options. This screen is for reference only and typically, no fields can be changed by the user.

LANETWORK SETUP

Displays or sets LAN interface settings. If the LAN option is present, this screen may be used to view or change LAN parameters. The MAC address is fixed and cannot be changed. IP and Gateway addresses are normally assigned by the network DHCP server. Changes to the other fields can be made by pressing the SET button first. The indicator in the top right hand of the screen will change from "NC" to "SET". Note that any setting changes made won't take effect till after the unit has been powered down and back up.

To set the LAN interface to AUTO IP mode, set the IP and Gateway address to all zeros. This will cause the IP to be requested from the network the next time power is cycled. To manually set the IP and Gateway address, enter the address from the keypad.

The Port address is normally set to 5025. The number of host bits is a function of the network address range.

```
LANetwork Setup          NC
MAC Address =00:00:00:00:00:00
IP Address   =69.35.221.81
GWAddress    =27.205.119.223
PORT Address =5025      HostBits =24
PREVIOUS SCREEN
```

ELAPSED TIME

The elapsed time screen, when selected from the UTILITY menu, will appear for about 3 seconds. The elapsed time shown is the cumulative amount of time the power source has been on from its initial build. This value is read only and cannot be changed by the user.

The same screen also displays the internal AC source ambient temperature in degrees C.

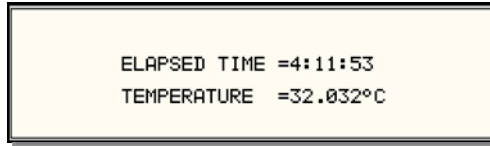
**VIEWING ANGLE**

The viewing angle can be used to change the contrast ratio of the LCD display. The range of the viewing angle parameter is from -10 to +10. Setting the right viewing angle is matter of personal taste. Set this parameter to a value that is most comfortable for the user. To save a new viewing angle setting, change the number to the desired value using the knob or the keypad and press the **ENTER** key. The new value will blink. To save it permanently, press the **SET** key.

5.2.8.1 GPIB/RS232 (incl. USB/LAN) SETUP menu

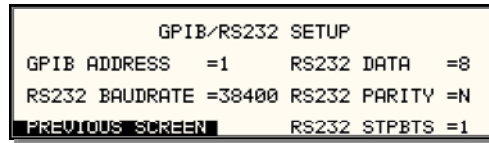

Figure 5-18: GPIB/RS232 SETUP Menu

The GPIB/RS232 SETUP menu may be used to change the interface parameter settings for both the IEEE-488 interface and the RS232, USB or LAN interface. The number of interfaces available will depend on the specific model and options as well as the time of manufacture. Older BPS models do not offer USB or LAN interfaces. Newer models can be equipped with as many as 4 different interfaces although only one can be used at the same time.

Refer to the BPS Series Programming Manual P/N 7003-961 distributed in Adobe PDF format on the same CD ROM as this user manual for more details on using the RS232, USB or LAN interface.

The following parameters can be set from this menu:

GPIB ADDRESS	Sets the IEEE-488 address used by the AC source. The address value can be set from 0 through 31. Address 0 is often reserved for the IEEE-488 controller. The factory setting is address 1. Once changed, the IEEE-488 address is retained in nonvolatile memory.
RS232 BAUDRATE	This field can be used to set the RS232 baud rate to either 9600, 19,200, 38,400, 57600 or 115,200 baud. The baud rate set on the AC source must match the one programmed for the communications port of the controller. Baud rates higher than 115200 are provided for the USB and LAN interface modes only. The same setting is used for USB and LAN modes. For use with either USB or LAN, the baud rate in this screen must be set to 460800 . See UTILITY 2 screen for other LAN setup parameters.
RS232 DATA	This field is used to set the number of data bits to either 7 or 8. Factory setting is 8 bits. This value must match the number of data bits set on the communications port of the controller. For USB or LAN use, always use factory settings.
RS232 PARITY	This field is used to set the parity. Available options are Even (E), Odd (O) or no parity (N). Factory setting is No parity. This value must match the parity set on the communications port of the controller. For USB or LAN use, always use factory settings.
RS232 STPBITS	This field is used to set the number of stop bits used on the serial port. Available options are 1 or 2 bits. Factory setting is 1 stop bit. This value must match the parity set on the communications port of the controller. For USB or LAN use, always use factory settings.

The number of start bits is always fixed to 1 bit.

5.2.8.2 VOLTAGE/CURRENT CONTROL SETUP menu

VOLTAGE/CURRENT CONTROL SETUP			
ALC MODE	=ON	TRIP DELAY	=0.10S
OL MODE	=CC	VOLT SENSE	=INT
PREVIOUS SCREEN		NO. OUTPUT	=THREE

Figure 5-19: VOLTAGE/CURRENT CONTROL SETUP Menu

The VOLTAGE/CURRENT CONTROL SETUP menu may be used to set output voltage and current control parameters. These parameters are not frequently changed in the normal operation of the AC source and are thus located on the UTILITY rather than the PROGRAM menu.

The following options are available in this menu:

ALC MODE	Automatic Level Control of programmed output voltage. This mode will use the internal voltage measurements to adjust the output voltage continuously as needed. This effectively increases the output accuracy and regulation beyond what is possible with ALC off.
OL MODE	This field is used to select constant current (CC) or constant voltage (CV) mode. The constant current mode will limit the maximum amount of current drawn by the load to the set value. The voltage will be reduced as needed after the trip delay time to maintain the level of programmed current. The constant voltage mode will maintain the set voltage as long as the current drawn by the load does not exceed the current limit programmed. If the current limit is exceeded, the output will be shut off after the trip delay time.
TRIP DELAY	The trip delay field may be used to set the amount of time to hold off the current limit trip point. The minimum amount of time is 100 ms or 0.1 sec. The maximum amount of time is 5.00 sec.
VOLT SENSE	This field selects the internal or external sense line inputs. Internal sense does not require the external sense lines to be connected as sensing occurs at the output relay of the AC source. For best results, connect the external sense lines and select the EXT sense mode in this field. This will compensate for voltage drop in the cables to the load. The measurements are also taken at the sense points, so the external sense mode should be used for best measurement results.
NO. OUTPUT	This field is always set to three to indicate the 3 phase output configuration of the BPS Series.

5.2.8.3 INITIAL SETUP menu

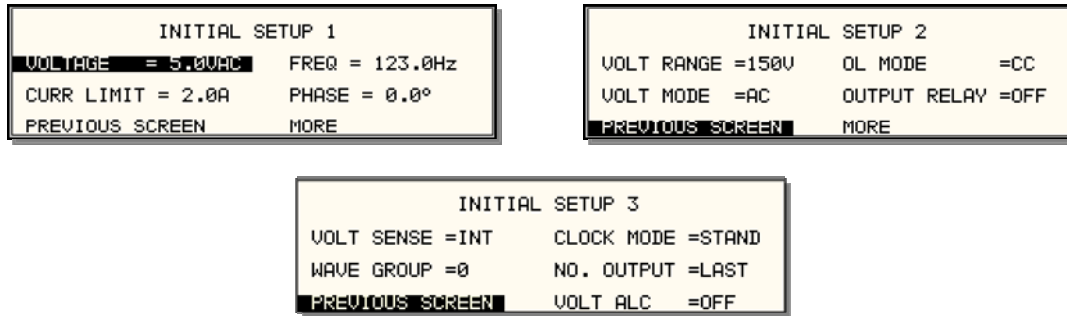

Figure 5-20: INITIAL SETUP Menus

Any time the power source is powered up, the output will reflect the values stored as the INITIAL setup values. This allows the unit to be powered up in a known state at all times. The INITIAL values can be set in the INITIAL SETUP menus.

The initial setup can be used to power up the power source with the output on and a high voltage present at the output. For normal situations, this is not recommended due to the potential danger to the operator. It is recommended that the initial voltage be set low and/or the output relay be programmed to OFF for most situations.

The following fields are provided in the INITIAL SETUP menus:

Entry	Description
INITIAL SETUP 1	
VOLTAGE	Sets the power-on AC voltage for AC and AC+DC modes or the DC voltage for DC mode.
CURR LIMIT	Sets the power-on current limit value.
FREQ	Sets the power-on frequency value.
PHASE	Sets the power-on frequency for phase A with respect to an external sync signal. If the internal oscillator is used (default) this setting has no effect.
INITIAL SETUP 2	
VOLT RANGE	Sets the power-on voltage range value.
VOLT MODE	Sets the power-on voltage mode. Available settings are AC mode, DC mode or AC+DC mode.
OL MODE	Sets the power-on overload mode. Available settings are Constant Current (CC) or Constant Voltage (CV) mode.
OUTPUT RELAY	Sets the power-on state of the output relay. Available settings are ON or OFF.
INITIAL SETUP 3	
VOLT SENSE	Sets the power-on state of the voltage sense mode. Available settings are Internal (INT) or External (EXT).

WAVE GROUP	Sets the user defined waveform group that will be loaded at power on. Available groups are 0, 1, 2 and 3. Each group can contain up to 50 user-defined waveforms. A waveform group can only be loaded at power up. To change groups, you must change this field to the desired new group and cycle the power to the AC source or issue a *RST command over one bus.
CLOCK MODE	Sets the clock source used at power up. Available settings are Stand Alone (STAND), MASTER (-LKM clock and lock master), and AUX (-LKS clock and lock auxiliary).
NO. OUTPUT	This field is always set to THREE and cannot be changed. It reflects the three phase output configuration of the BPS Series.
VOLT ALC	Determines ALC mode at power on. The ALC mode adjusts the output voltage based on internal voltage measurement system and provides enhanced output regulation and accuracy. Available settings are ON, OFF or REG.

5.2.8.4 LIMIT SETUP screen

LIMIT SETUP	
VOLTAGE =300.0V	FREQ LO =16.00Hz
CUR LIMIT =111A	FREQ HI =500.0Hz
PREVIOUS SCREEN	PHASE C =120°

Figure 5-21: LIMIT SETUP Menu

The limit setup screen is not a menu but only serves to inform the user of the hardware capabilities of the AC source. The cursor can be moved to any of the fields in this screen but none of these fields can be changed. The following information is provided on this screen:

Entry	Description
VOLTAGE	Maximum AC rms or DC voltage available in the high voltage range.
CUR LIMIT	Maximum AC rms current limit available in the low voltage range.
FREQ LO	Lowest possible fundamental frequency that can be programmed.
FREQ HI	Highest possible fundamental frequency that can be programmed.
PHASE C	Phase angle of phase C with respect to phase A in three phase mode. If the AC source is a single phase model, this field will shown 0°. If the AC source is a split phase model, this field will shown 180°.

5.2.8.5 CONFIGURATION SETUP screens

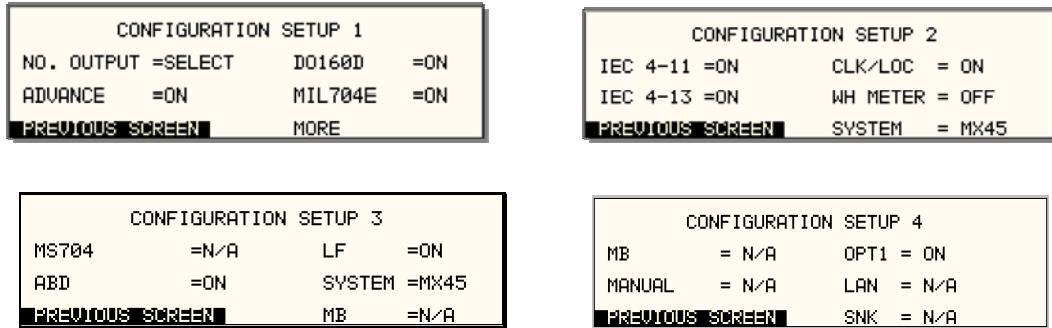

Figure 5-22: CONFIGURATION SETUP Menus

The configuration setup screens are not menus but only serve to inform the user of the software options installed in the AC source. The cursor can be moved to any of the fields in this screen but none of these fields can be changed. The following information is provided on this screen:

Entry	Description																				
CONFIGURATION SETUP 1																					
NO. OUTPUT	Displays the phase mode option. SELECT indicates the phase mode option is installed and the user can select between single and three phase modes of operation. FIXED indicates the phase mode option is not installed and only single phase or three phase mode of operation is possible.																				
CONFIGURATION SETUP 2																					
LF	Indicates the presence of the Low Frequency limit option. If this option is set, the maximum frequency that can be programmed is 500 Hz.																				
SYSTEM	This field sets the controller for the correct BPS system configuration. Available settings are: <table border="0" style="width: 100%;"> <tr> <td>BPS30-1</td> <td>Single phase BPS30 system Master</td> </tr> <tr> <td>BPS30-3</td> <td>Three phase BPS30 system Master</td> </tr> <tr> <td>BPS45-1</td> <td>Single phase BPS45 system Master</td> </tr> <tr> <td>BPS45-3</td> <td>Three phase BPS90 system Master</td> </tr> <tr> <td colspan="2"> </td> </tr> <tr> <td>BPS75-3</td> <td>Three phase BPS75 system Master</td> </tr> <tr> <td>BPS90-3</td> <td>Three phase BPS90 system Master</td> </tr> <tr> <td>BPS150-3</td> <td>Three phase BPS150 system Master</td> </tr> <tr> <td>BPS180-3</td> <td>Three phase BPS180 system Master</td> </tr> <tr> <td>AUX</td> <td>Three phase Auxiliary System.</td> </tr> </table>	BPS30-1	Single phase BPS30 system Master	BPS30-3	Three phase BPS30 system Master	BPS45-1	Single phase BPS45 system Master	BPS45-3	Three phase BPS90 system Master			BPS75-3	Three phase BPS75 system Master	BPS90-3	Three phase BPS90 system Master	BPS150-3	Three phase BPS150 system Master	BPS180-3	Three phase BPS180 system Master	AUX	Three phase Auxiliary System.
BPS30-1	Single phase BPS30 system Master																				
BPS30-3	Three phase BPS30 system Master																				
BPS45-1	Single phase BPS45 system Master																				
BPS45-3	Three phase BPS90 system Master																				
BPS75-3	Three phase BPS75 system Master																				
BPS90-3	Three phase BPS90 system Master																				
BPS150-3	Three phase BPS150 system Master																				
BPS180-3	Three phase BPS180 system Master																				
AUX	Three phase Auxiliary System.																				

If this field is set incorrectly, the current limit scaling and current measurement will be off by a factor of three. Changes made to the SYSTEM field will not take effect until **AFTER** power on the BPS system is cycled. (Off, then back on).

LAN

CONFIGURATION SETUP 4

This field indicates the presence of the LAN Ethernet interface option. ON indicates the option is present, N/A indicates the option is not installed. Not all features indicated are available on this model.

5.2.9 MEASUREMENT CAL FACTORS Menu



Figure 5-23: MEASUREMENT CAL FACTORS Menu.

The MEASUREMENT CAL FACTORS menu provides access to the measurement calibration parameters. The parameters apply to the selected mode of operation (AC mode only). For three phase configurations, the PHASE keys toggle between the three calibration screens for each phase. These parameters are password protected and can only be changed after the calibration password has been entered. Refer to the calibration section in this manual for details on performing a calibration.

Entry	Description
VOLT FS	Full scale voltage measurement calibration factor.
CURR FS	Full scale current measurement calibration factor.

5.2.10 OUTPUT CAL FACTORS Menu

```

      OUTPUT CAL FACTORS      mA
VOLT FS   =20000  IMP REAL FS =50
VOLT ZERO =60    IMP REACT FS =100
PHASE OFST=0.0°  IMP REAL MIN =10
IHARM FS  =200   IMP REACT MIN=60
PREVIOUS SCREEN
  
```

Figure 5-24: OUTPUT CAL FACTORS Menu (Series II only)

The OUTPUT CAL FACTORS menu provides access to the output calibration parameters. These parameters are password protected and can only be changed after the calibration password has been entered. For three phase configurations, the PHASE keys toggle between the three calibration screens for each phase. Refer to the calibration section in this manual for details on performing a calibration.

The following calibration factors are available from this menu:

Entry	Description
VOLT FS	Full scale voltage output calibration factor.
VOLT ZERO	Zero offset voltage calibration factor.
PHASE OFST	Phase offset calibration factor. Compensates for phase shift caused by AC amplifier.

5.3 Output Programming

5.3.1 Set the Output

Output parameters are all set from the PROGRAM screen.

1. Use the MENU key and select the PROGRAM entry.
2. Press the ENTER key to bring up the PROGRAM menu.

or

2. Use the PROG key to directly bring up the PROGRAM menu.

There are two methods for programming output parameters:

IMMEDIATE mode

SET mode

5.3.2 Slewing Output Values with the Knob in IMMEDIATE Mode

The default mode of operation is an immediate mode in which changes to output parameters made with the knob or the entry keypad are immediately reflected at the output.

To change the output voltage:

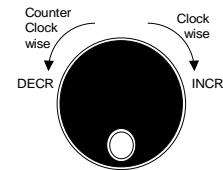
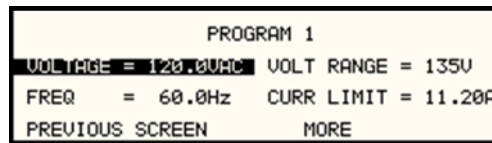

1. Place the cursor on the VOLTAGE entry
2. Rotate the knob clockwise to increase the value, counterclockwise to decrease the value

These changes take effect immediately.

To change the output frequency:

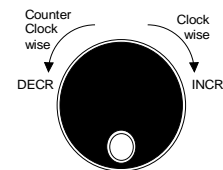
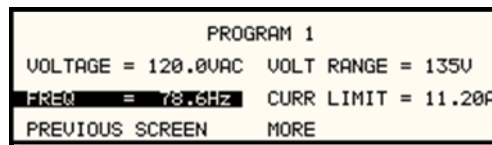

1. Place the cursor on the FREQ entry
2. Rotate the knob clockwise to increase the value, counterclockwise to decrease the value

These changes take effect immediately.

5.3.3 Change Output Values with the Knob in SET Mode

The SET mode of operation is a mode in which changes to output parameters made with the knob or the entry keypad do not affect the output until the ENTER key is pressed. The AC source is put in this SET mode by pressing the SET key.

To change the output voltage:

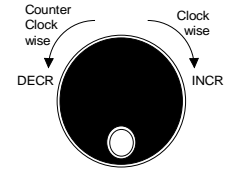
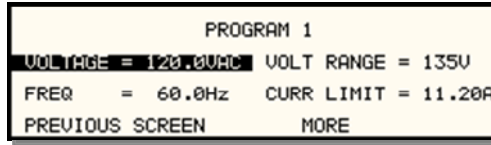

1. Press the SET key
2. Place the cursor on the VOLTAGE entry
3. Rotate the knob clockwise to increase the value, counterclockwise to decrease the value
4. The VOLTAGE field will be blinking to indicate a change in settings but the output remains unchanged.
5. Place the cursor on the FREQ entry
6. Rotate the knob clockwise to increase the value, counterclockwise to decrease the value
7. The FREQ field will be blinking to indicate a change in settings but the output remains unchanged.
8. Press the ENTER key.

Both new voltage and frequency output values are now present at the output. The unit has returned to immediate mode of operation until the SET key is pressed again.

5.3.4 Change Output Values with the shuttle knob from the MEASUREMENT 1 screen

Basic output settings such as voltage and frequency can be changed from the MEAS 1 screen by using the following procedure:

1. Select the PROGRAM 1 screen by pressing the PROG key and position the cursor on either the Voltage or Frequency setting field.
2. Select the MEASUREMENT 1 screen by pressing the MEAS key. A small arrow will be showing in front of either the Voltage or Frequency measurement readout.
3. The shuttle knob can now be used to increment or decrement the selected parameter.

If three-phase mode is selected in the MEASUREMENT 1 screen, slewing the knob while the voltage is selected will change the output voltage on all three phases. If only one phase is selected, only the output of the selected phase will be affected.

5.4 Standard Measurements

Standard measurements are always available through the MEAS key on the front panel. These measurements are spread across two to four screens to enhance readability. Switching between these screens can be done by successively pressing the MEAS button on the front panel. This will cause the screen to cycle through all available measurement screens.

5.4.1 Standard Controller Measurements

For BPS Series power sources, the following two measurement screens are available:

Mode	AC	DC	
MEASUREMENTS 1			
VOLTAGE	AC rms voltage	DC Voltage	
CURRENT	AC rms current	DC Current	
FREQUENCY	Frequency	n/a	

Mode	AC	DC	
POWER	Real power	power	
MEASUREMENTS 2			
VA POWER	Apparent power	power	
PEAK CURR	Highest AC current found	Highest DC current found	
POWER FACT	Power factor	n/a	
CREST FACT	Crest factor	n/a	

5.4.2 Controller Measurements

For BPS Series the following four measurement screens are available:

Mode	AC		
MEASUREMENTS 1			
VOLTAGE	AC rms voltage		
CURRENT	AC rms current		
FREQUENCY	Frequency		
POWER	Real power		
MEASUREMENTS 2			
VA POWER	Apparent power		
PEAK CURR	Highest AC current found		
POWER FACT	Power factor		
CREST FACT	Crest factor		
MEASUREMENTS 3			
VOLT THD	Voltage distortion		
CURR THD	Current distortion		
INST PK CURR	Instantaneous peak current		
PHASE	Phase angle		

Note: The V and I distortion calculations are based on H2 through H50 with the RMS current in the denominator. Note that some definitions of THD use the fundamental component (H1) as the denominator. This may result in different readings between instruments depending on the implementation chosen.

Measurements are always running in the background. When the user selects a measurement screen for display, the AC source first updates all the measurement parameters before displaying the requested screen. This process may take up to a second. Consequently, pressing the MEAS key may not always bring up the selected screen immediately. There will be a perceptible delay. This will prevent the screen from appearing with invalid or blank readouts.

The measurement method for voltage and current will depend on the power source's operating mode. The following table shows the return value type (rms or average) and method of coupling when the measurement command is initiated with a different extension in AC operating mode.

Measurement Extension and Coupling	Operating Mode		
	AC		
AC	rms		
DC	rms		
Coupling	AC		

5.4.3 Accuracy Considerations

Any measurement system has a finite accuracy specification. Measurement specifications are listed in Section 2. When using the AC source for measurement purposes, always consider these specifications when interpreting results. Measurement inaccuracies become more pronounced as the signal being measured is at the low end of the measurement range. This is particularly relevant for low current measurements. The BPS Series is a high power AC source optimized for providing and measuring high

load currents. When powering low power loads, measurement inaccuracies on rms and peak current measurements will greatly affect derived measurements such as power, power factor and crest factor.

The measurement system on the BPS Series uses a data acquisition system with a 16 kHz bandwidth. This means that high frequency components of the measured signal are filtered out. Any contribution to the rms value of voltage and current above this cutoff frequency will not be reflected in the BPS Series measurements. When using an external measurement reference, this may account for discrepancies in readings.

5.4.4 Triggering Measurements

Both FFT results and waveform acquisitions may have to be positioned at a specific moment in time. To allow the data acquisition to coincide with user specified events, the measurement system can be triggered in different ways. Trigger modes are available from both the bus and the front panel. If one of the remote control interfaces is used, acquisitions may also be triggered from the transient list system. Refer to the programming manual for details on this mode of operation.

5.4.4.1 Trigger mode

The following trigger modes are supported by the BPS Series controller:

Single (SINGLE)	<p>This mode causes the acquisition system to be armed only once. The BPS source waits for the user to press the ENTER key while on the START field. As soon as the trigger event specified occurs, data is acquired and the acquisition system is put in an idle state. A new user initiated START event must be given to trigger a new acquisition.</p> <p>This mode is appropriate for capturing events that occur only once such as the inrush current when turning on a load.</p>
Continuous (CONT)	<p>This mode causes the trigger system to re-arm itself after each trigger event. Every time a new trigger event occurs, new data is acquired and the LCD display is updated. No user intervention is required after the initial START event.</p> <p>This mode is appropriate for capturing repetitive events or to monitor the source output continuously. Display updates will occur about once per second.</p>

5.4.4.2 Trigger source

The BPS Series controller offers a choice of trigger sources in front panel operation mode. The following trigger sources are available from the TRIG SOURCE field:

Immediate (IMM)	<p>This mode causes a trigger to occur as soon as the ENTER key is pressed with the cursor on the START field. No trigger source needs to be specified for this trigger mode. This mode is equivalent to the INIT:IMM:ACQ bus command.</p> <p>This trigger source is appropriate if no trigger condition is known or desired. When using this trigger source, the acquisition is always triggered.</p>
Phase (PHASE A)	<p>This mode causes the BPS acquisition system to wait for a specified phase angle on the phase A voltage output. This allows the acquisition to be positioned in time with respect to any phase angle on phase A, B or C. Note that phase A, B and C are typically at 0°, 240° and 120° with respect to the specified trigger phase in this field. An example of this trigger source mode is shown in Figure 5-26.</p>

When selecting this trigger source, the field below the TRIG SOURCE field changed to “TRIG PHASE =“. Use this field to enter the desired voltage phase angle to trigger the measurement on.

This mode is appropriate when capturing analyzing events at a specific phase angle such as the zero crossing of the voltage. Note that the phase angle of the current with respect to the voltage is determined by the load, so triggering at a specific phase current angle is not possible as it is not controlled by the AC source. However, when capturing current waveform data, the phase relationship to the voltage can be determined easily by triggering at the 0° point on the voltage.

Voltage step (SET VOLT)

This mode performs two functions. It programs the output voltage for the selected phase or phases to the rms or DC value specified and it triggers the measurement acquisition at the same moment in time.

When selecting this trigger source, the field below the TRIG SOURCE field changed to “SET VOLT =“. Use this field to enter the desired voltage to program the output to and trigger the measurement on. If only one phase in a three phase system is selected, only that phase’s output will be programmed. If all phases are selected, all three phases’ outputs will be programmed. Use the PHASE key to select the desired phase or all phases. Figure 5-25 shows an example of using the SET VOLT trigger source to capture the turn-on of the voltage. In this case, a negative trigger delay was specified and the voltage start phase angle was set to 90° in the PROGRAM 2 screen.

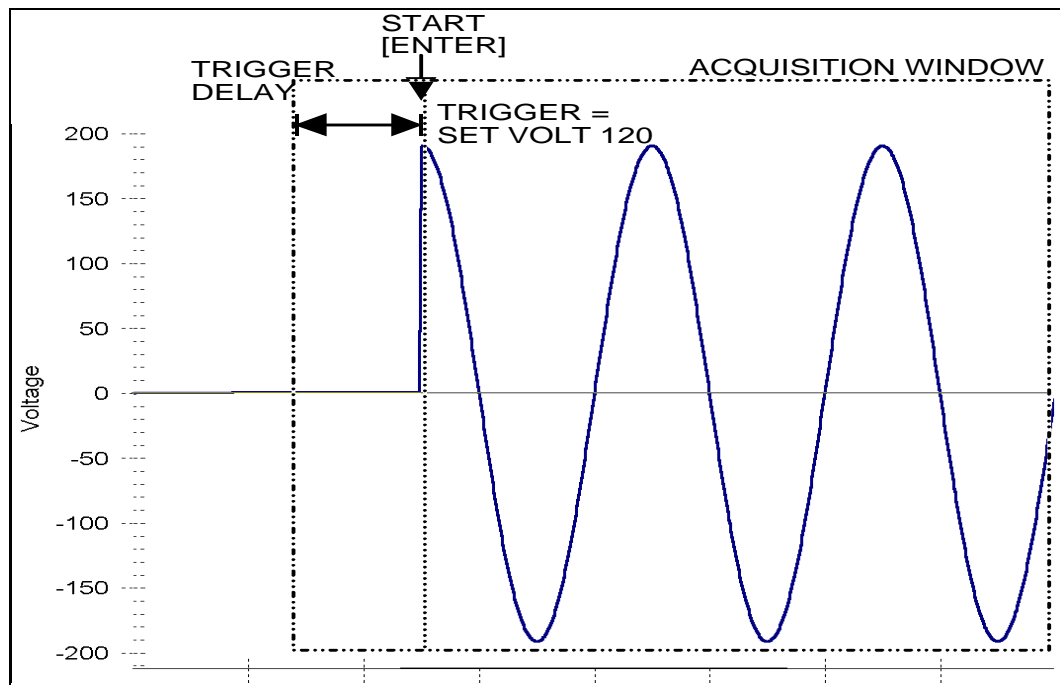

Figure 5-25: SET VOLT Trigger Source Acquisition

This mode is appropriate for capturing the inrush current of a load by programming the voltage to a specified value and capturing the voltage and current at that moment in time. A further refinement can be made by specifying the voltage start phase angle in the PROGRAM 2 screen. If this field is changed from RANDOM to 90°, the inrush current can be captured under worst case conditions. In this case, the voltage should be programmed to 0 volt before triggering the acquisition using the START field.

Note: *When using the SET VOLT trigger source, the output relay MUST be closed to generate a trigger. If the output is open, the acquisition will be armed when the START [ENTER] key is pressed but will wait for the trigger event. Closing the output relay will generate the trigger event. If the output relay was already closed when the START [ENTER] key is pressed, the trigger will occur immediately.*

5.4.4.3 Trigger delay

The trigger delay field allows the user to set the amount of pre- or post-trigger data that should be used when positioning the data acquisition window with respect to the trigger moment.

POST-TRIGGER DELAY

A positive trigger delay value means the acquisition window is delayed by the amount of time specified. In this case, the actual trigger moment itself is no longer present in the acquisition buffer. This situation is shown in Figure 5-26 where a 20 ms trigger delay is used after triggering on phase A = 180°. The fundamental frequency of the output is 50 Hz. The dashed line indicates the trigger point. It occurs on the first 180 degree point that occurs after the user presses the ENTER key while on the START field. Once the trigger occurs, the acquisition holds off the specified 20 ms at which point the data requested is captured. Using a positive trigger delay value always yields post trigger data.

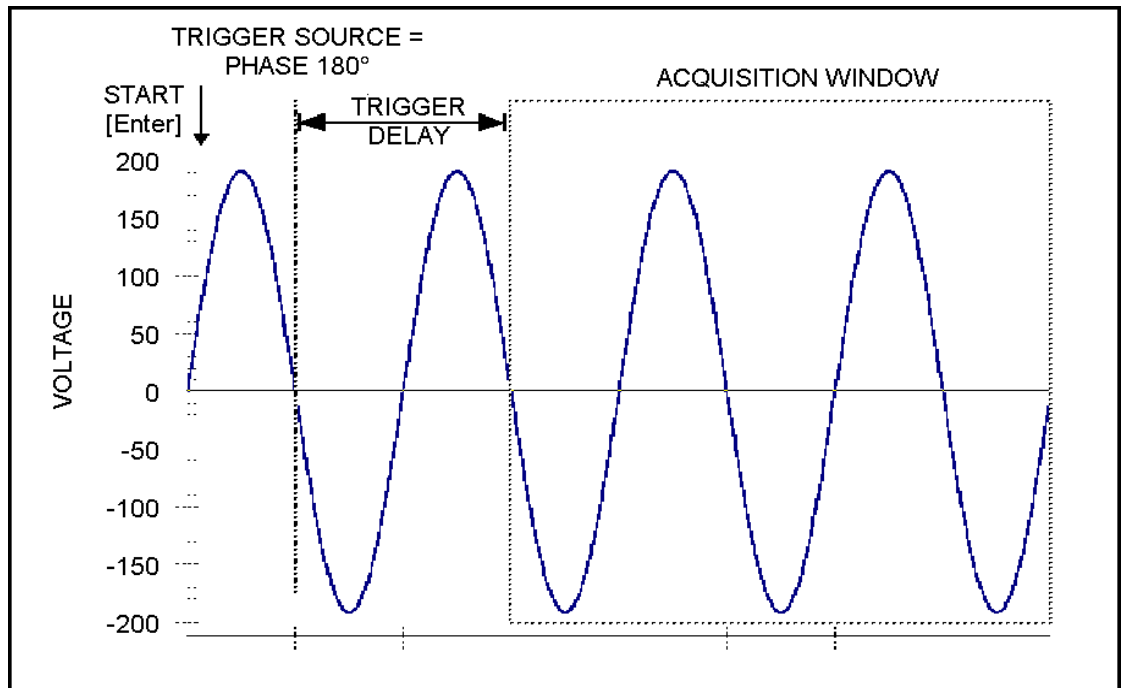

Figure 5-26: Positive Trigger Delay (Post Trigger Data)

Positive trigger delay values may be set from 0.0 ms to 1000.0 ms (1 second) in 0.1 ms increments. The value may be entered directly from the keyboard or using the knob.

PRE TRIGGER DELAY

Alternatively, a negative trigger delay value may be specified up to the maximum time window depth of the acquisition window. The value may be entered directly from the keyboard or using the knob. The following time interval range is available:

128 msec to 1280 msec.

This situation is shown in Figure 5-27. The example shows a similar scenario as before, only this time the trigger delay was set a -20 ms. Notice that the data acquisition window now contains data that occurred before the user pressed the ENTER key to start the acquisition.

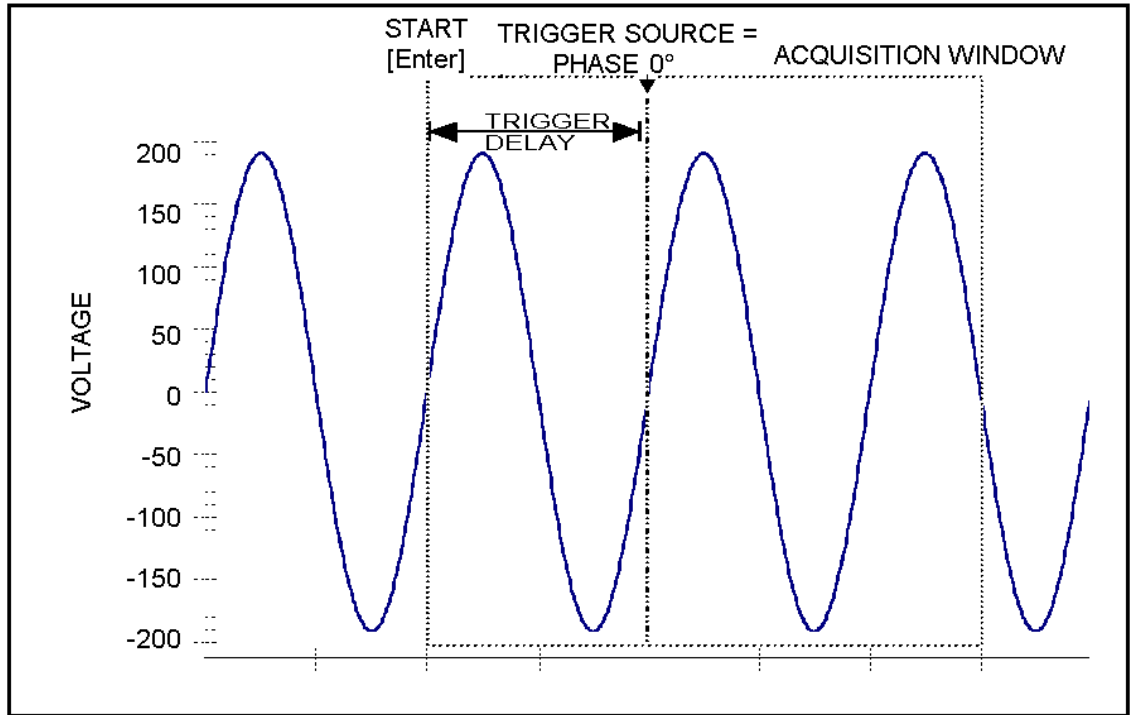

Figure 5-27: Negative Trigger Delay (Pre-Trigger Data)

5.5 Transient Programming

5.5.1 Introduction

Transient programming provides a precise timing control over output voltage and frequency changes. This mode of operation can be used to test a product for susceptibility to common AC line conditions such as surges, sags, brownouts and spikes. By combining transient programming with custom waveforms, virtually any AC condition can be simulated on the output of the AC source.

The default voltage mode is FIXED which means the output voltage is constant and remains at the level set by the user. Changes made to the output voltage made from the PROGRAM 1 menu take effect immediately. In front panel operation mode, the voltage and frequency slew rates (rate of change) are always at their maximum of 1E9 V/s and 1E9 Hz/s. Slew rate programming is only possible over the remote control interface. On power up, the AC source always reverts to the maximum slew rate for both voltage and frequency.

5.5.2 Using Transient Modes

The voltage can be programmed in the following transient operating modes:

- STEP causes the output to permanently change to its triggered value.
- PULSE causes the output to change to its triggered value for a specific time, as determined by the Pulse menu parameters.
- LIST causes the output to sequence through a number of values, as determined by points entered in the List menu.
- FIXED disables transient operation for the selected function.

5.5.3 Step Transients

Step transients let you specify an alternate or triggered voltage level that the AC source will apply to the output when it receives a trigger. Because the default transient voltage level is zero volts, you must first enter a triggered voltage before you can trigger the AC source to change the output amplitude. Step transients can only be programmed through the bus, not the front panel. Refer to the SCPI Programming Manual for more information about programming Step transients and triggers.

5.5.4 Pulse Transients

Pulse transients let you program the output to a specified value for a predetermined amount of time. At the end of the Pulse transient, the output voltage returns to its previous value. Parameters required to set up a Pulse transient include the pulse count, pulse period, and pulse duty cycle. An example of a Pulse transient is shown in Figure 5-28. In this case, the count is 4, the pulse period is 16.6 ms or 60 Hz and the duty cycle is 33%.

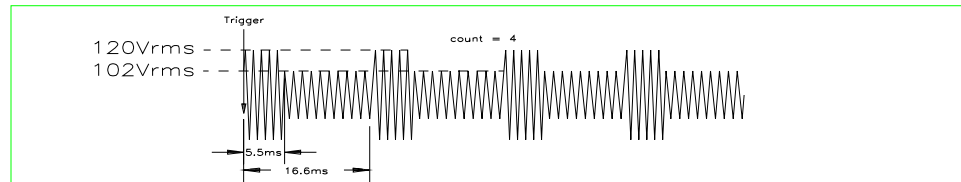

Figure 5-28: Pulse Transients

Note that Pulse transients can only be programmed over the bus, not the front panel. Refer to the SCPI Programming Manual for more information about programming Pulse transients and triggers.

5.5.5 List Transients

List transients provide the most versatile means of controlling the output in a specific manner as they allow a series of parameters to be programmed in a timed sequence. The following figure shows a voltage output generated from a list. The output shown represents three different AC voltage pulses (160 volts for 33 milliseconds, 120 volts for 83 milliseconds, and 80 volts for 150 milliseconds) separated by 67 millisecond, zero volt intervals.

Transient list programming is supported from the front panel and may be accessed by selecting the TRANSIENTS entry in the MENU 1 screen. Transient lists can also be programmed over the bus. Refer to the SCPI Programming Manual for more information about programming List transients and triggers over the bus.

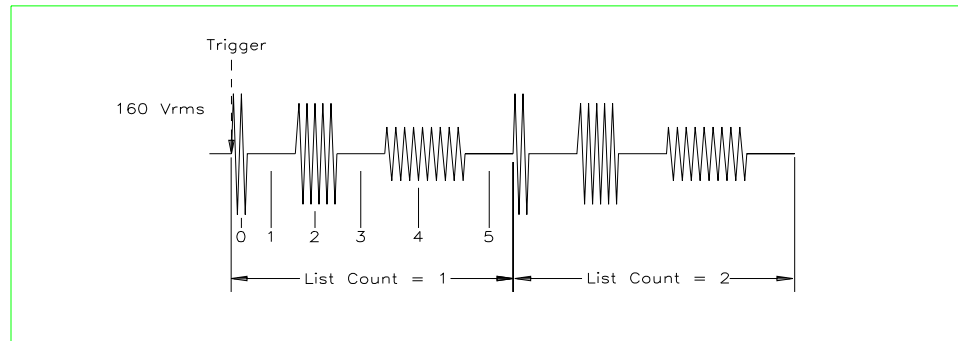

Figure 5-29: List Transients

The list specifies the pulses as three voltage points (point 0, 2, and 4), each with its corresponding dwell point. The intervals are three zero-voltage points (point 1, 3, and 5) of equal intervals. The count parameter causes the list to execute twice when started by a single trigger.

To set up this type of transient list, proceed as follows:

1. Press the PROG key to bring up the PROGRAM 1 menu.
2. Move the cursor to the VOLTAGE field and enter 0 Volt. Press ENTER to confirm your setting.
3. Make sure you are in the HIGH voltage range as we will program a surge to 160 V rms. The low range would only allow 150 V rms.

PROGRAM 1		øABC
VOLTAGE = 0.00AC	VOLT RANGE = 300V	
FREQ = 60.0Hz	CURR LIMIT = 11.1A	
PREVIOUS SCREEN	MORE	

4. Press the MENU key to bring up MENU 1.
5. Move the cursor to the TRANSIENTS entry and press the ENTER key. You are now in the TRANSIENTS menu.
6. Move the cursor to the VOLT SURGE/SAG entry and press the ENTER key. You are now in the VOLT SURGE/SAG SETUP menu.
7. If you have a three-phase configuration and are in the three-phase mode, use the PHASE key to select all three phases. (øABC will be displayed in the top right corner of the screen.)
8. The START ø may be left at RANDOM as we are not interested in starting at a specific phase angle. If a number is already present in this field, use the BACKSPACE (<-) key to clear it.

9. Move the cursor to the GO TO VOLT field and enter 160.0
10. Move the cursor to the DUR SCALE field and set this field to TIME. We will be entering delays in time rather than cycles since this example was stated in ms.
11. Move the cursor to the DURATION field and enter 0.033 seconds. Be sure not to enter 33 as this field is specified in seconds, not milliseconds. The highest time resolution available for list transients is 1 ms or 0.001 s.
12. Move to the END VOLT field and enter 0.0. We want the voltage to return to 0 Volt after the first burst.
13. Move the cursor to the END DELAY field and enter 0.067 for a interval delay of 67 ms. Notice that we effectively combined steps 0 and 1 from Figure 5-29 into a single list event.
14. If you have an BPS Series AC source, move down to the FUNCTION field and use the knob to select SINE. The knob will allow you to scroll through all available wave shapes in the active WAVE GROUP. If you have a -1 or -3 standard controller, this field will not be visible.
15. Move the cursor to the REPEAT field and enter 0. This means this event will be executed once and not repeated. Do not confuse this event level repeat capability with the entire list level repeat field, which we will use later.
16. Move the cursor down to the EVENT # field and enter a number from 1 through 99. The transient list will be executed in order of event number. Leaving a gap between event numbers allows you to insert events at different places later in the sequence. Deleting events is always possible regardless of the event number. For the purpose of this exercise, we will start with EVENT # 5. Enter 5 and press the ENTER key. This brings you back to the TRANSIENTS menu.

```

VOLT SURGE/SAG SETUP      ABC
START  =RANDOM             END VOLT =0.0
GO TO VOLT=160.0         END DELAY =0.067S
DUR SCALE =TIME          FUNCTION =SINE
DURATION  =0.033S       REPEAT    =0
PREVIOUS SCREEN          EVENT #  =5
  
```

17. Repeat steps 6 through 16 two more times using 120 V, 83 ms and 80 V, 150 ms as values for EVENT # 10 and EVENT #15.
18. Once you have programmed these three events, move the cursor in the TRANSIENTS menu to the START/VIEW SEQUENCE field and press the ENTER key. This will get you to the START/VIEW TRANSIENT SEQUENCE menu from which you can run transient programs. This screen shows all available events in the transient list on the right hand side. If more than five events are programmed, you can scroll through the list using the UP and DOWN arrow keys. To edit an existing event, move the cursor to the relevant event number and press the ENTER key.
19. Move the cursor to the REPEAT #0 field and enter 1. This will cause the transient program to repeat once and thus run two times total. Do not confuse this global list level repeat capability with the list event level repeat field we skipped in step 15.
20. Make sure the output relay is closed using the OUTPUT ON/OFF key. If you start a transient program with the relay open, an error message will appear.
21. Move the cursor to the START field and press the ENTER key. The transient program you just created will execute two times. If you have an oscilloscope connected to the output, you may be able to see the output voltage change per Figure 5-29.

```

START/VIEW TRANSIENT SEQUENCE
START  #05= VOLTAGE SURG/SAG
PAUSE  #10= VOLTAGE SURG/SAG
REPEAT #0 #15= VOLTAGE SURG/SAG
CLEAR SEQ
PREV. SCREEN
  
```

Note: *The AC source output remains at the last programmed values at the completion of the list.*

In three-phase mode, the voltage lists are phase selectable. You can set up a different voltage list for each phase. To do this, use the PHASE key to choose the desired phase, as described in the example. Note that fields common to all phases such as DURATION, END DELAY and REPEAT always apply to all three phases in three-phase mode. When the cursor is moved to any of these fields, the phase enunciator in the top right-hand corner always reverts to \emptyset ABC. Frequency transients are identical to voltage transients except they apply to all three phases at all times in a three-phase configuration.

5.5.6 Programming Slew Rates

As shown in the previous examples there are a number of ways that you can generate custom waveforms. Programmable slew rates provide additional flexibility when customizing waveforms. Slew rates determine how fast the voltage or frequency is changed by the controller when a step, pulse, or list transient is triggered. Slew rates cannot be programmed from the front panel and are always set to their maximum values at power on. To use programmable slew rates, the AC source must be programmed over the bus. Refer to the SCPI Programming Manual for more information about programming slew rates.

5.5.7 Transient Execution

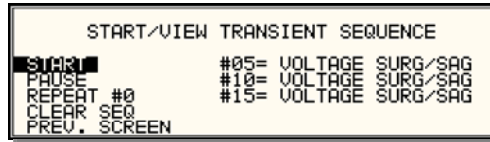

Figure 5-30: START/VIEW TRANSIENT SEQUENCE Menu

A transient list can be executed from the START/VIEW TRANSIENT SEQUENCE menu. To start a transient list, position the cursor on the START field as shown in Figure 5-30 and press the ENTER key. Transients may be aborted by pressing the ENTER key again while on the same field as the field changes to ABORT while a transient execution is in progress. For short duration transients, this will likely not be visible, as the transient will complete before the screen is updated. Longer duration transients however may be aborted in this fashion.

Longer duration transients may also be suspended using the PAUSE field located below the START/ABORT field. Pressing the ENTER key while on the PAUSE field will suspend the transient execution. Once suspended, it can be resumed using the same field as the field changes to RESUME while the transient execution is suspended. Suspending a transient may be useful when running slowly changing output transients to 'hold' the output at a specific setting while observing the effect on the unit under test.

5.5.8 Saving Transient List Programs

When the AC source is turned off, the transient list that was programmed is not automatically retained. Thus, if you turn the unit off, you will lose your programmed transient list. However, transient programs may be saved in nonvolatile memory for later recall. This allows multiple transient list programs to be recalled quickly without the need to enter all parameters each time. Transient lists are stored as part of the overall instrument front panel setup in any of the available setup registers.

To save the transient list you created in the previous example, proceed as follows:

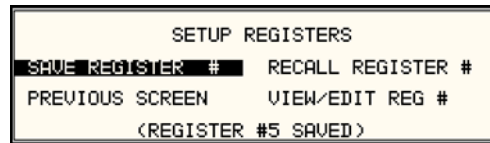

1. Press the MENU key two times to bring up the MENU 2 screen.
2. Move the cursor to the SETUP REGISTERS entry and press the ENTER key.
3. The cursor will default to the SAVE REGISTER # position. Enter a number from 0 through 7 and press the ENTER key.
4. A message will appear at the bottom of the screen indicating that the front panel settings and the transient list data have been saved in the setup register you selected.

6. Principle of Operation

6.1 General

An explanation of the circuits in the BPS Series is given in this section. Refer to Figure 6-1 for a basic functional block diagram of the system.

Figure 6-2 shows a more detailed system interconnect for a BPS90-3 three-phase output unit. Other models have slightly different output configurations.

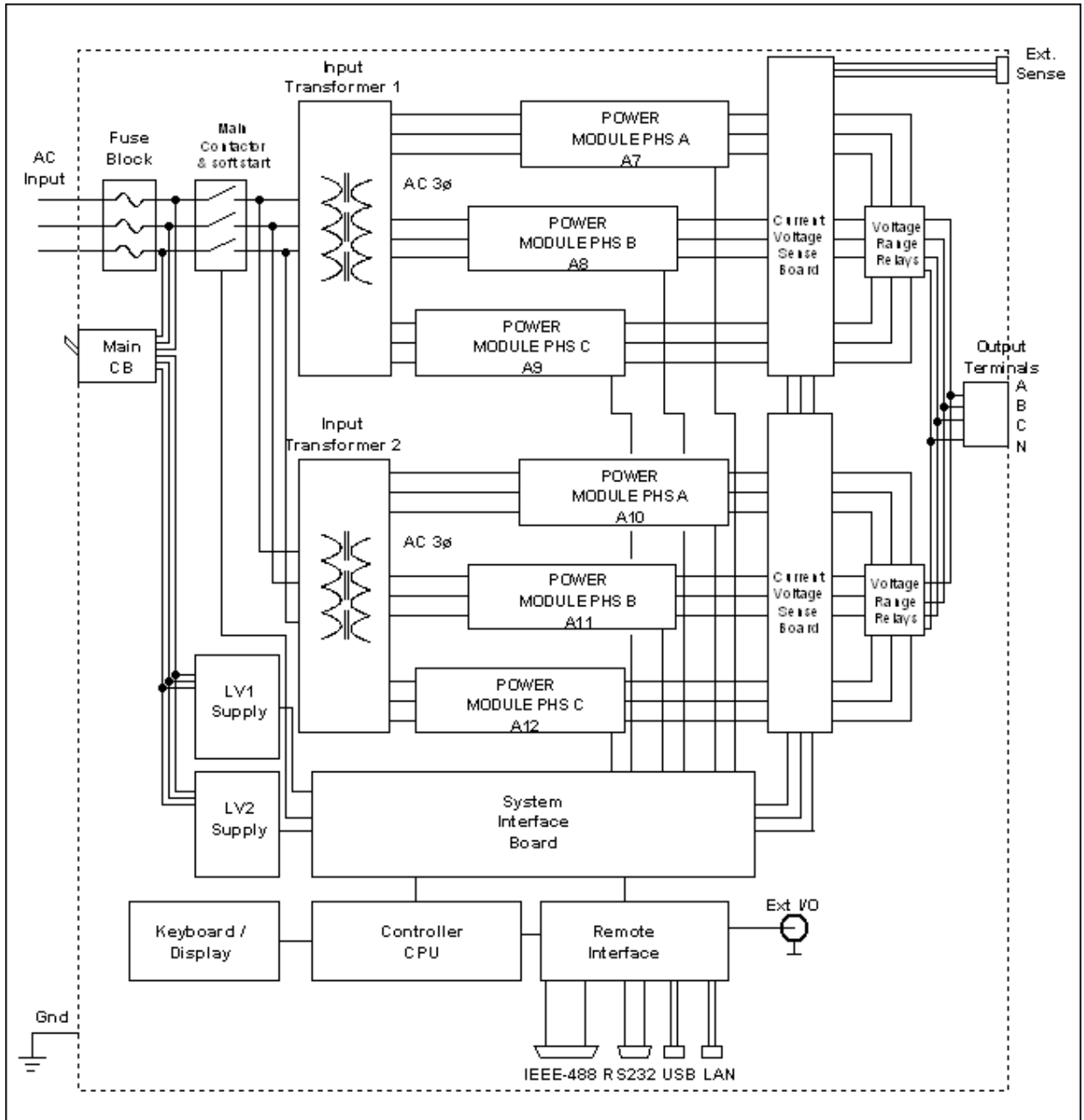

Figure 6-1: BPS Series Functional Block Diagram

6.2 Overall Description

Three-phase input power is routed from the back of the cabinet to a fuse holder terminal block located in the bottom front of the unit. The lower front access panel has to be removed to gain access to the AC input connection fuse block. From the fuse block, the AC input is connected to the three-phase input transformer primary. The input transformer provides the required isolation between input and output of the BPS and accommodates various input voltage ranges by employing multiple taps. Three sets of three-phase output secondaries are provided by the transformer to produce three 140 VAC unregulated output AC buses. Each of these outputs is fed into one of the power modules. (A, B and C) The power modules can be individually removed although for most configurations, all three are required. The power modules are located in the middle of the BPS chassis and can be pulled out from the front after removing the top access panel and disconnecting the power input and output wiring.

Each power module contains a three-phase PFC power input module. The PFC module acts as a boost converter using a PWM converter topology to generate a 450 VDC regulated bus. A bank of high capacity electrolytic capacitors for each DC bus ensures ride through capability during brown-outs and high current demands.

The DC bus provides power to the AC amplifier. Each amplifier in turn consists of four amplifier modules labeled #1 (A1, A2) and #2 (A1, A2). These four amplifier modules are identical and interchangeable but all four must always be present.

The output of the amplifier is AC. This is set by the CPU controller based on this models features. All four amplifier modules within each power module are controlled by a single Modulator board. The modulator board contains a high frequency PWM modulator and additional control circuitry.

The CPU controller / oscillator assembly generates the reference waveforms and provides frequency, amplitude, and impedance control. A current and voltage sense board is located at the left bottom of the unit and is used to sense all output current and voltage for both control and measurement purposes. The current sensor board, in conjunction with the CPU controller, also supports the programmable RMS current limit function.

The system interface board controls all interaction between controller, power modules and current sensor board. The system interface board is located in the top compartment of the BPS along with the controller.

Low voltage Power to the controller, amplifiers, system interface board and sensor board is provided by a separate Low Voltage DC supply (LV Supply). This LV Supply takes three-phase AC input directly from the AC input line through circuit breaker CB1 located on the front on the BPS. This circuit breaker functions as the main power on/off switch of the BPS unit.

The LV Power Supply board converts the AC input into a number of isolated low voltage regulated DC supplies that are distributed throughout the BPS chassis. The LV power supply also supplies coil power for all contactors, including the AC mains contactor (K2). A small fan is located near the LV Supply to provide sufficient cooling of the supply and the other modules in the top section of the RS.

The individual assemblies are described in more detail in the following paragraphs. Refer to Figure 6-1 for an overall functional block diagram.

6.3 Controller Assembly

The Controller Assembly is located in the top section of the BPS unit. To access this assembly, the top cover needs to be removed. The controller assembly consists of three printed circuit boards connected by a ribbon cable. The controller contains the main oscillator, which generates the sine wave signal setting the frequency, amplitude and current limit level. It also senses the output voltage to provide closed loop control of the output. The controller also handles all user interface and remote control related tasks.

The controller uses a two board set assembly. The function of each of the boards that make up the controller module is described in the following paragraphs.

6.3.1 CPU Controller

This board assembly, A2-A7, consists of the components for the CPU (DSP), generating the Phase waveform signal to the power amplifier and all of the program, waveform and data memory. In addition, the waveform board contains the circuits for all measurements. The clock and lock circuit required to support the clock and lock mode of operation of multiple BPS units is also on this board assembly.

6.3.2 Keyboard / Display Board

The keyboard/display assembly is assembly A2-A9. It is mounted to the front panel and holds the 23 rubber keys. It also has the LCD graphics display. A shaft encoder is mounted on the board that is used as a shuttle input to allow slewing of setup parameters. If the BPS system is used over one of the remote control interfaces, the keyboard functions can be locked out by asserting the REMOTE state. See the BPS Series Programming Manual (P/N 9003-961) for details.

6.3.3 GPIB / RS232 or GPIB / RS232 / USB / LAN IO Board

This board assembly is identified as A1. It has the IEEE 488, RS232 and USB transceivers and optionally an Ethernet interface (-LAN option). USB and LAN are available on specific top assembly BPS models only. It also has isolators to provide safety isolation for both interfaces and additional user accessible I/O lines. Additional user accessible inputs and outputs available through this assembly are:

- Trigger Input BNC
- Trigger Output BNC
- Function Strobe BNC
- Remote Inhibit (terminal strip)
- External Sync (terminal strip)
- Output Status (specific top assembly models only)

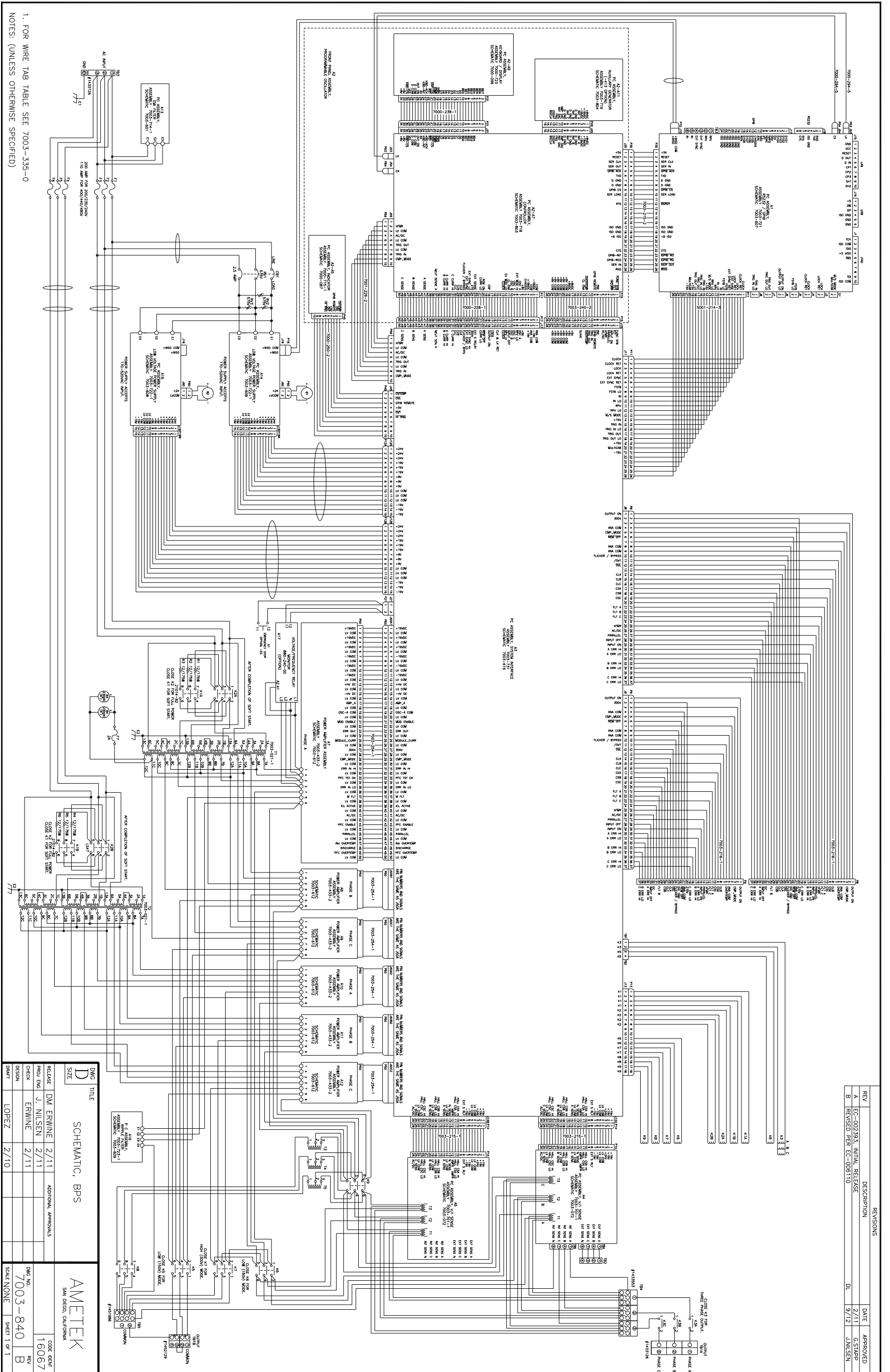

1. FOR WIRE TAB TABLE SEE 7003-335-0
NOTES: (UNLESS OTHERWISE SPECIFIED)

REVISIONS		DATE	APPROVED
REV	DESCRIPTION		
A	EC-002393, INITIAL RELEASE	2/11	G.S.M.P.P.
B	REVISION PER EC-006110	9/12	J.NILSEN

DWG TITLE	SCHEMATIC, BPS	
SIZE	D	
RELEASE	DATE	ADDITIONAL APPROVALS
PROJ ENG	J. NILSEN	2/11
CHECK	ERWINE	2/11
DESIGN	LOPEZ	2/10
DWG NO.	7003-840	ISSUE NO.
SCALE	NONE	SHEET 1 OF 1

Figure 6-2: BPS90 Series Detailed Block Diagram

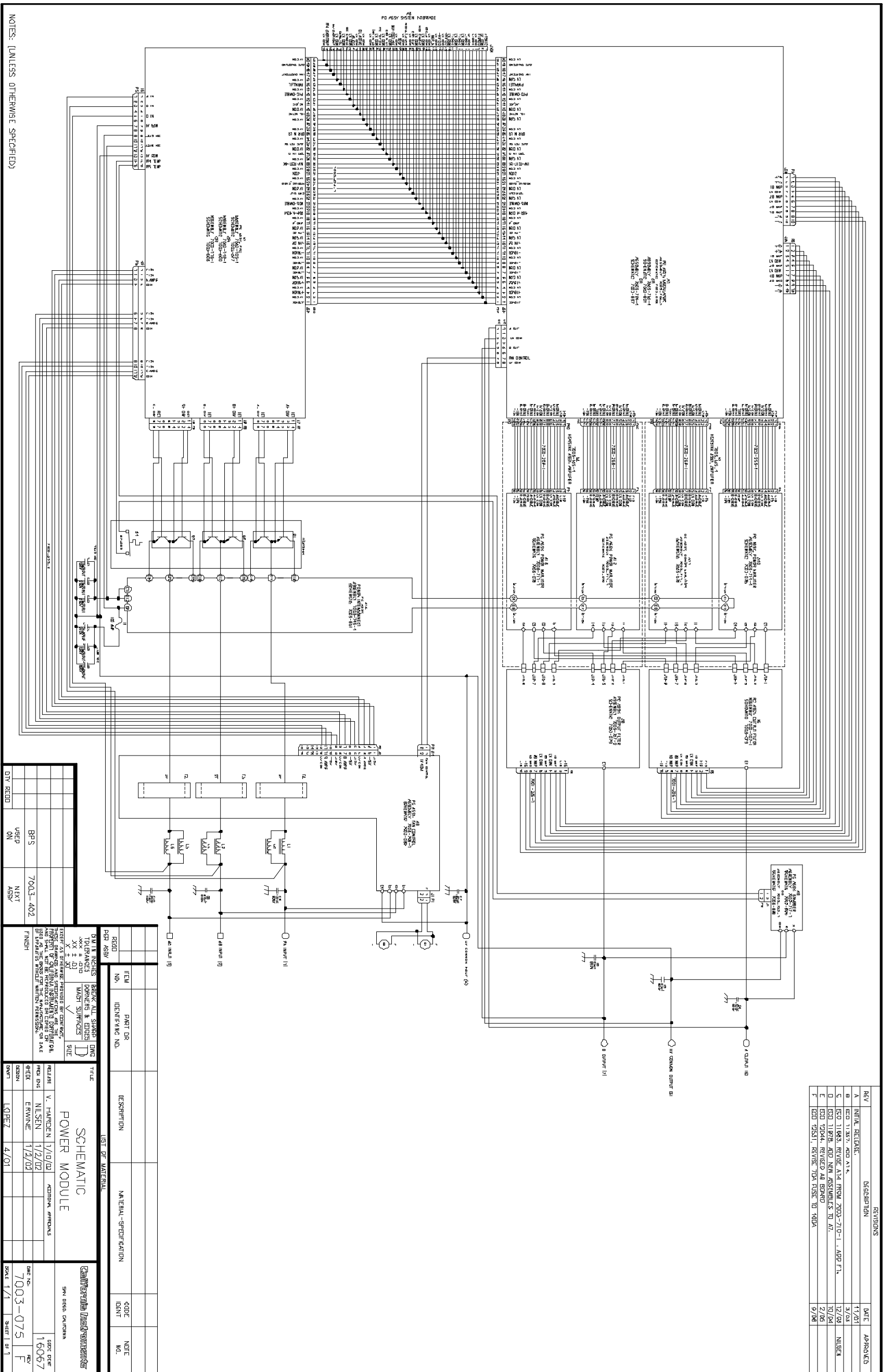

Figure 6-3: Power Module Detailed Block Diagram

6.4 System Interface Board

The System Interface Board is located in the top section of the BPS unit. To access this assembly, the side and front covers need to be removed. The System Interface board, A6, receives the oscillator signal from the CPU controller assembly for all phases and passes it through to all amplifiers whose gains are controlled by a signal from the over current circuit. The over current circuit senses the RMS value of the current. If the load current exceeds the programmed value, the output of this sensing circuit reduces the amplitude of the oscillator drive signal. The output of the unit then becomes a constant current output, with the output voltage dropping as the load increases.

The System interface also monitors a variety of status signals from the amplifiers. This includes PFC good, over temperature signals and DC bus regulation good signals. If any status signal is false, the system interface board will shut down the BPS. At power on, all status signals have to return good (TRUE) or the BPS system power up sequence will be halted.

Finally, the System interface assembly also routes the required system interface bus signals between multiple BPS75 and BPS90 chassis for multi-box configurations. A DB-37 to DB-37 system interface cable is used to connect two BPS units in a multi-box configuration. This connection is required for proper operation of the system.

6.5 Current / Voltage Sensor Board

The current and voltage sensor boards, A4 & A5, sense the output current and voltage of all amplifiers and feeds this information back to the system interface board. These same signals are also used by the controller for all measurement functions. Voltage sense is accomplished either internally or externally. For best voltage regulation at the EUT, external sense connections should be made using the External Sense terminal block located at the top of the back-panel.

Alternatively, internal sense mode may be selected. In this case, the voltage is sensed at the sensor board.

6.6 Low Voltage Power Supply

The Low Voltage power supplies A14 & A15 are mounted behind the system interface board in the center section of the BPS chassis. These two assemblies generate all required low voltage DC outputs. These outputs from the LV Power supplies provide analog and logic power to all the modules.

- a) +/- 19 V to the System Interface board and power modules.
- b) + 9 V to the oscillator.
- c) + 24 V to all contactors and LV cooling fan.
- d) Isolated + 8 V for the GPIB/RS232 board.

Four green LED's on the system interface board are lit when the ± 15 V and ± 19 V are in regulation. If an overload condition causes the output to drop more than 10% or the output has failed, the corresponding LED will extinguish. This feature is helpful in troubleshooting the unit. See Service section 7.

6.7 Power Module

Each BPS chassis accommodates three power modules. These power modules are located in the center of the chassis and can be removed from the front after removing the front cover. Each power module is fully self-contained and forms a complete AC to AC or AC to DC converter. The three power modules are identical and can be interchanged if needed although this is not recommended under normal use.

The power module is depicted in Figure 6-4.

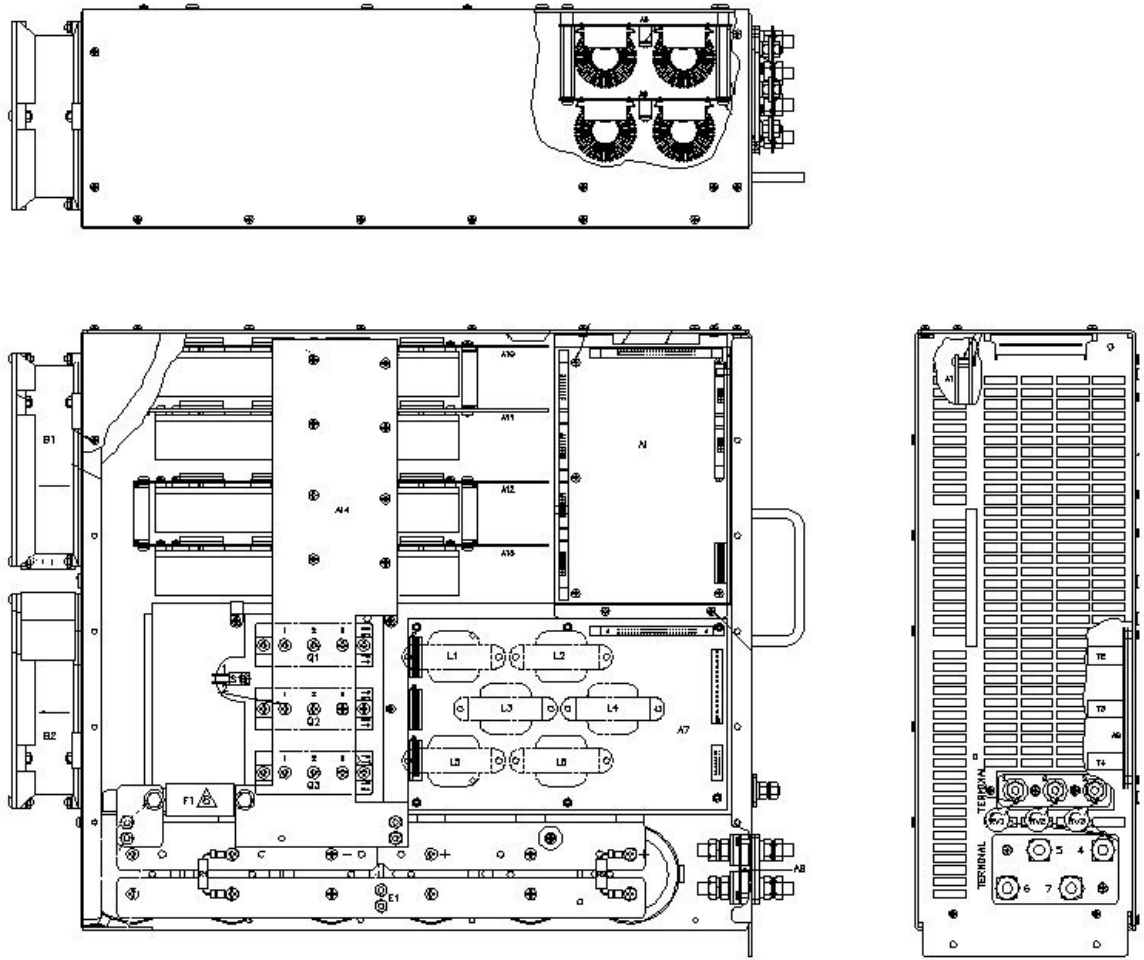

Figure 6-4: Power Module Layout

6.7.1 PFC Input Power Converter

The PFC section is located at the bottom of each power module. AC power enters the power module at the PFC input section. The PFC section using a PWM boost converter to turn the unregulated three phase 140 VAC into a regulated ± 225 V DC bus. A bank of capacitors is used to provide ride-through and to support high peak current demands from the amplifier boards. The PFC PWM circuit drives a set of three high capacity IGBT's. These IGBT's connect directly to the DC bus bars, which connect the PFC output to the Amplifier boards.

The condition of the PFC section is constantly monitored and reported to the system interface board. If the DC bus goes out of acceptable operating range, a fault is generated. Furthermore, in any of the three AC input phases fails, the BPS will shut itself down.

6.7.2 Modulator Board

The modulator board is located directly above the PFC board and next to the four-board Amplifier stack. The modulator board accepts an oscillator output reference signal as input and drives the four amplifier boards using a high frequency PWM technique. The modulator has the ability to drive the amplifiers in either parallel or series configuration, thus producing either a high (300 Vac ./ 400 Vdc) or low (150 Vac / 200 Vdc) output voltage range. Note that some configurations of the BPS Series may be hardwired for single range use.

The modulator contains several feedback loops that control the current sharing and output regulation of the four power amplifier boards. The Modulator boards connects to one of the three connectors on the System interface through a 50 pin ribbon cable located at the top front of each power module.

6.7.3 Amplifier Boards

The Amplifier boards are each attached to a heat sink and stacked on top of each other at the top portion of the power module enclosure. Sets of two boards are held together by a bracket which screws into the back wall of the power module enclosure. Power to each amplifier board is supplied from the PFC section through a set of DC bus bars. Each amplifier board connects to the modulator board via a small ribbon cable. Each Amplifier board has four outputs (A+, A-, B+ and B-). These four outputs connect to a set of Inductor boards using stranded wires with Anderson style connectors. The connection between the Amplifier boards and the Inductor boards is specific and should not be reversed or damage could result. The output wire connectors of each amplifier board are color coded to help identify the correct connections. The connections between the Modulator board and the Amplifier boards are one to one. (Connectors line up with amplifier boards).

The layout of the Amplifier board is shown in Figure 6-5.

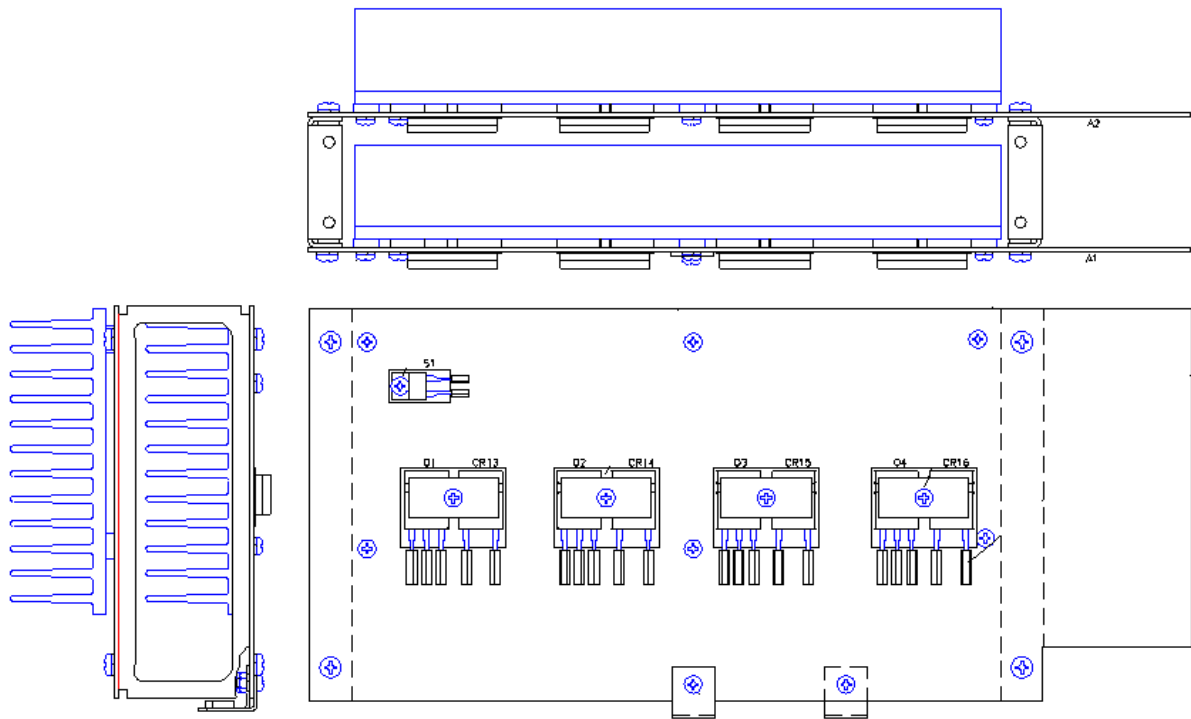

Figure 6-5: Amplifier Board Layout

6.7.4 Filter Boards

A set of two identical inductor boards is located behind the Modulator board and next to the four amplifier boards. One filter board handles the "A" output, the other handles the "B" output. In addition to the filtering function performed by these boards, the inductor boards also contain current sensors that are used in the feedback loop of the amplifier. The output of these current sensors is routed to the modulator board to regulate current sharing and peak current limiting.

6.7.5 Fan Supply Board

The Fan Supply board is located in the wind tunnel of the PFC section at the bottom of the power module. This board provides variable speed control for the dual fans of the power module. Fan speed is a function of the load current sensed. This provides for lower levels of audible noise during minimal load conditions.

6.7.6 Output Snubber Board

A small output snubber board is attached to the output terminals of each power module. This snubber provides the required operating stability of the amplifiers.

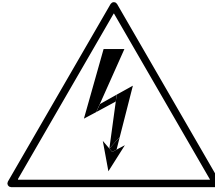

CAUTION

VOLTAGES UP TO 480 VAC AND 450 VDC ARE PRESENT IN CERTAIN SECTIONS OF THIS POWER SOURCE. THIS EQUIPMENT GENERATES POTENTIALLY LETHAL VOLTAGES.



DEATH

ON CONTACT MAY RESULT IF PERSONNEL FAIL TO OBSERVE SAFETY PRECAUTIONS. DO NOT TOUCH ELECTRONIC CIRCUITS WHEN POWER IS APPLIED.

7. Calibration

The Routine Calibration should be performed every 12 months. Non-routine Calibration is only required if a related assembly is replaced or if the periodic calibration is unsuccessful. Calibration of the BPS system can be performed from the front panel or over the bus. The BPSGUI program provides several calibration screens for this routine calibration but not for non-periodic calibration. This section covers calibration from the front panel. Refer to the BPSGUI on line help for information on using the BPSGUI program to perform routine calibration.

Full-scale output calibration is done using the internal measurement system. As such, it is important to calibrate the AC voltage measurements before performing an AC full-scale output calibration.

Note: *Perform the Measurement calibration first.*

The cardinal calibration points used during calibration are chosen to obtain optimal performance at the typical operating points of the BPS Series. If the typical application in which the BPS system is used is unusual, it may be better to calibrate it at different operating points than the ones used in this manual. Also, if the required load values for current calibration are not available, the programmed voltage may be adjusted to obtain the approximate current (typically close to maximum available current per phase).

7.1 Recommended Calibration Equipment

Digital Multimeter:	Agilent 3458A or equivalent / better.
1 mOhm Current Shunt:	Isotek Model RUG-Z-R001-0.1.
Load Bank:	Various high power load resistors or a resistive load bank will be needed. (E.g. Avtron) Size of the load bank depends on model and phase mode. A load is required to perform the current measurement calibration near full scale. Current measurement calibration should be done on the lowest available voltage range. The accuracy and value of the load resistor is not critical as long as the current drawn is sufficient to operate the AC Source in the upper current range (80-100 %). Suggested values of load bank settings are shown in Table 7-1.
PC with CI BPSGUI:	Optional. Consult factory for further information.

7.2 Front Panel Calibration Screens

The calibration screens for output or measurement calibration can be selected from the MENU 3 screen. (Press MENU button several times to toggle to MENU 3 screen.)

To select the OUTPUT CALIBRATION screen press the ↑ or ↓ key several times to highlight OUTPUT CAL. Then press the ENTER key. This will bring up the PASSWORD screen. To prevent unauthorized access to calibration data, a password must be entered to access any calibration screen. The calibration password is always "5000" and may be entered using the numeric keypad. Once entered, the calibration screens remain accessible until the BPS unit is powered down.

Type 5000 and press the ENTER key to show the OUTPUT CALIBRATION screen.

On BPS systems with three-phase output capability, use the PHASE key on the front panel to select the phase to be calibrated.

To select the MEASUREMENT CALIBRATION screen, follow the same steps as outlined above but select the MEASUREMENT CAL entry instead of OUTPUT CAL. If another CALIBRATION screen has been accessed since power-up, no password is needed. Otherwise, enter the same password as indicated above.

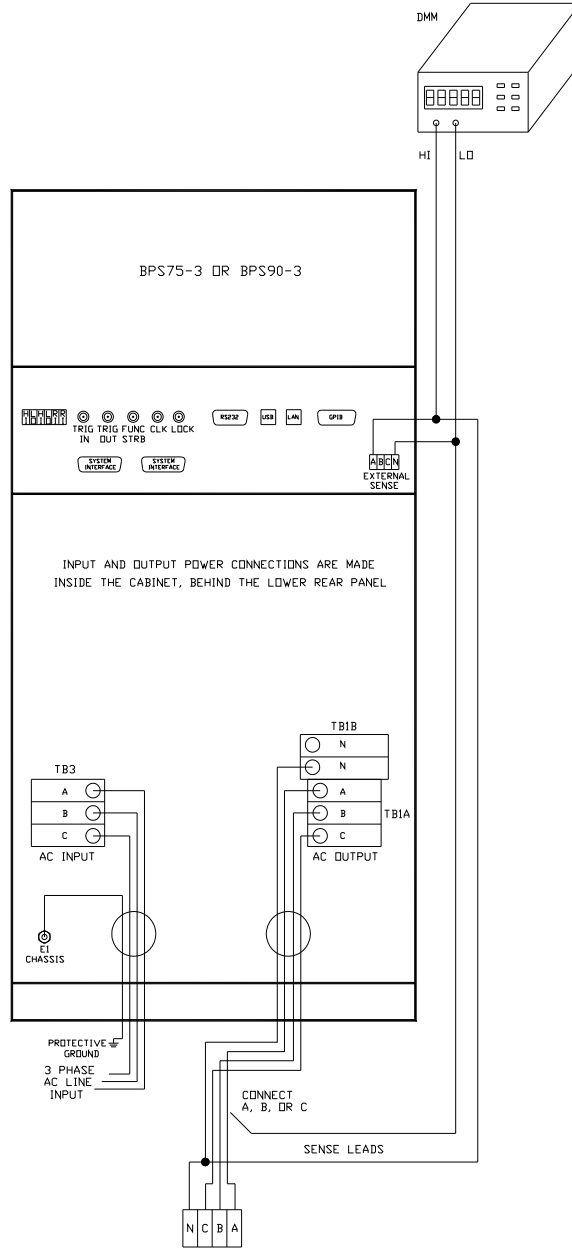

Figure 7-1: Sample Voltage Calibration Setup BPS75 or BPS90 (Rear view)

7.3 Routine Measurement Calibration

The BPS Series controller measures voltage and current by digitizing both voltage and current waveforms on each available output phase. This data is subsequently processed and use to calculate all measurement parameters such as VRMS, IRMS, Power, VA, Frequency etc. To calibrate all measurements, only the voltage and current measurement functions need to be calibrated. All other measurements are derived from these.

Connect the test equipment to the power source as shown in Figure 7-1. The DVM for calibrating the measurement voltage should always be connected to the Remote Sense connector on the Master cabinet.

Note: The Agilent 3458A Digital Multimeter or equivalent must be used for the following calibration.

The shunt must be connected to the power source as shown in Figure 7-2. If the Current Measurement can't be successfully performed, adjust the Current Measurement Pot on the System Interface board. This adjustment is described in the Non-routine Calibration section of this manual. If the DC current measurement displays more than 70 counts on the display, perform the non-routine current monitor adjustment.

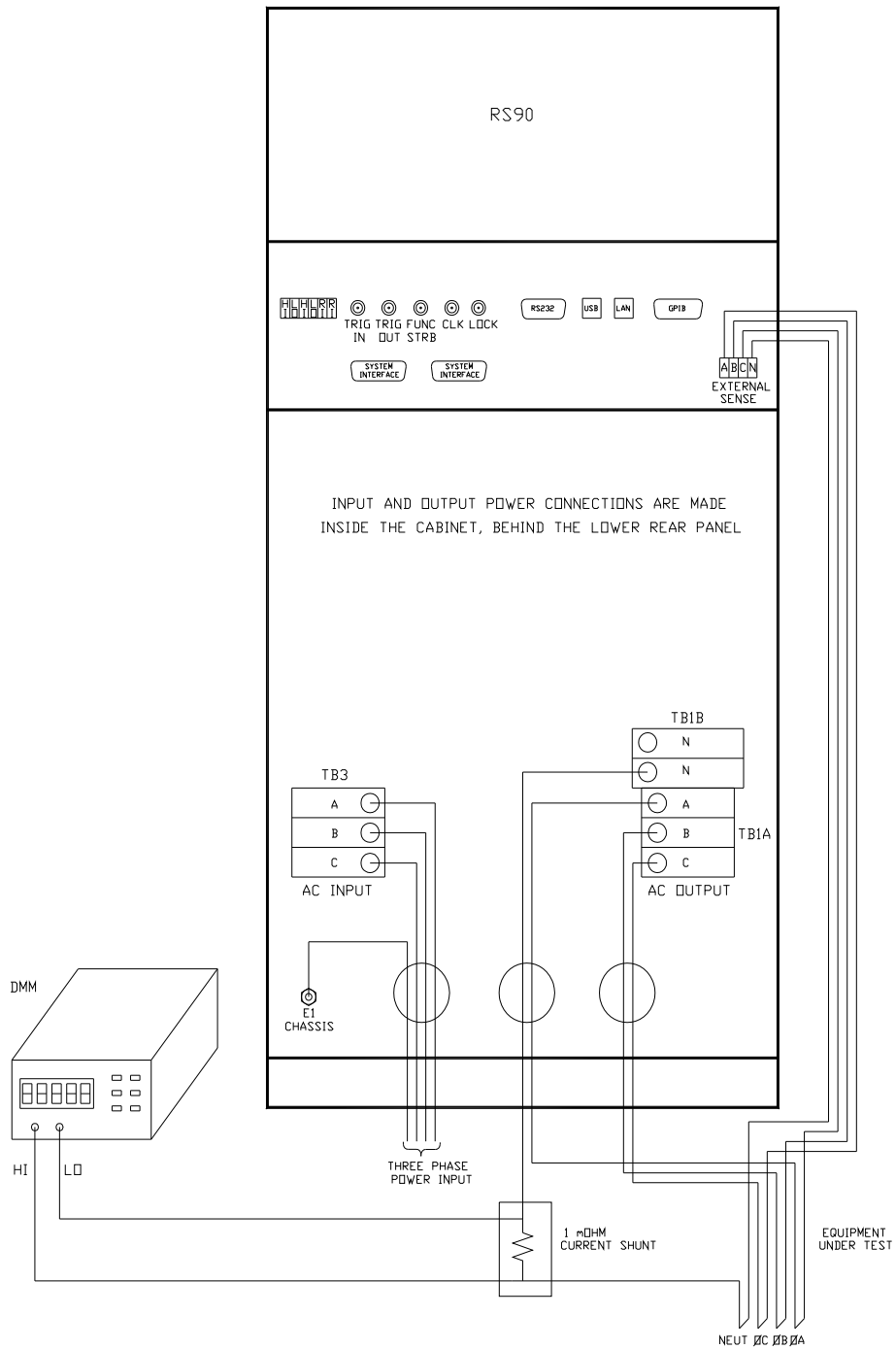

Figure 7-2: Sample BPS 90 Current Measurement Calibration Setup (Rear view)

Connect the load to the output. Use the 1 mOhm current shunt in series with the load to measure the AC and DC load current. When programming a DC load always program the output voltage to 0 volts before changing the output load. This will prevent load switch contacts from being damaged.

To calibrate all measurement functions, the desired value for the measurement value of current or voltage must be entered for the corresponding calibration value. Make the indicated adjustments by typing in the desired display value. This should be the value indicated by the external DVM. If a 1 mOhm current shunt is used for current, 300 mV represents 300 amps.

The Calibration Load Table shows required load bank settings for the current measurement calibration procedure. The following text is a detailed explanation of the procedure.

Note that the voltage measurement calibration is only required on the high voltage range. The same voltage measurement calibration coefficients are used on both voltage ranges.

Note that the current measurement calibration is only required on the low voltage range – maximum available current range. The same current measurement calibration coefficients are used on both voltage ranges (if available). Suggested load values are shown for either voltage range in case the BPS is only used in a single voltage range.

PARAMETER	BPS POWER SYSTEM		
<p>Model ---> Lowest Range <u>150 VAC</u> AC Current Full Scale</p>	<p><u>BPS45-3</u> 1.0 Ω, 15KW</p>	<p><u>BPS90-3</u> 0.5 Ω, 30KW</p>	<p><u>BPS180-3</u> 0.25 Ω, 60KW</p>
<p><u>300 VAC</u> AC Current Full Scale</p>	<p>4.0 Ω, 15KW</p>	<p>2.0 Ω, 30KW</p>	<p>1.0 Ω, 60KW</p>

Table 7-1: Sample BPS45/90/180 Calibration Load Resistance and Power Values

7.3.1 Measurement Cal - AC

To calibrate AC measurements, set the power source to the AC mode. Select the MEASUREMENT CAL entry from the MENU 3 screen. Refer to section 5.2.9 for relevant LCD screen.

Note: For the following calibration steps put the external Digital Multimeter into AC mode.

- AC Volt Full-scale: Program the output to the 300 VAC range. Close the output relay. Program the output to 240 VAC and 60 Hz. Go to the MEASUREMENT CALIBRATION screen. Enter the actual AC output voltage for the VOLT FS parameter and press the ENTER key.
- AC Current Full-scale: Apply a load to the output. Refer to Table 7-1. Program the output to 120 VAC on the 150 VAC range and 60 Hz. (If a 150 VAC range is not available, select the 300 VAC range and program the same 120 VAC output.) Observe the actual output current and enter this value for the CURR FS parameter. Press the ENTER key.

7.3.2 Measurement Calibration Summary

The following Table is a summary of the preceding calibration steps. The value indicated by the External DVM is called V_{AC} or V_{DC} . The current measured by the current shunt is called I_{AC} or I_{DC} .

TITLE	PROGRAM/LOAD PARAMETERS	PARAMETER	ADJUST TO
AC MODE			
AC Volt Full-scale	300 VAC Range, 240 VAC, 60 Hz, no load	VOLT FS	V_{AC}
AC Current Full-scale	150 VAC Range, 120 VAC, 60 Hz, full load to 90% of max current range.	CURR FS	I_{AC}

Table 7-2: Measurement Calibration Table -

Repeat Paragraph 7.3 for each phase. Move the external test equipment to the phase that is being calibrated. Refer to Figure 7-2..

While viewing the calibration screen, press the PHASE key to select the respective phase.

7.4 Routine Output Calibration

For best results, it is recommended to perform the measurement calibration procedure first. See section 7.3.

Follow the steps outlined in this section to perform a routine output calibration. Note that each available output range (except -HV option) has its own output calibration coefficients and must be calibrated. Table 7-3 shows the individual calibration points in a summary format. The following text is a more detailed explanation of the procedure.

The full-scale calibration should be done in the AC mode for both the low and high range if available. The option -HV range can be done only if the high range (300VAC) is not available. If both the standard high range and the -HV optional range is available, calibrate the standard range.

Note: Selecting the calibration screen (by entering the Cal Password) will turn off the ALC mode. Conversely, turning on the ALC mode will turn off the Calibration mode. If the ALC mode is turned off during calibration, the cal password will have to be re-entered to allow calibration.

Setup:

Connect the test equipment to the power source depending on model configurations as shown in Figure 7-1. For multi-phase systems, each phase has to be calibrated individually. Note that no load is required for most output calibrations.

DC Offset measurements:

If the DMM used to perform DC offset calibration has trouble rejecting AC noise in VDC mode (measurement not stable), it may be necessary to use a small filter circuit at the output of the amplifier to measure the DC offset. A 100Kohm RN60 1/4W (CI P/N 560131) and 22uF, 35V (CI P/N 611267) series network can be used in this case as shown below. Use this circuit only while performing DC offset checks and remove for other calibrations.

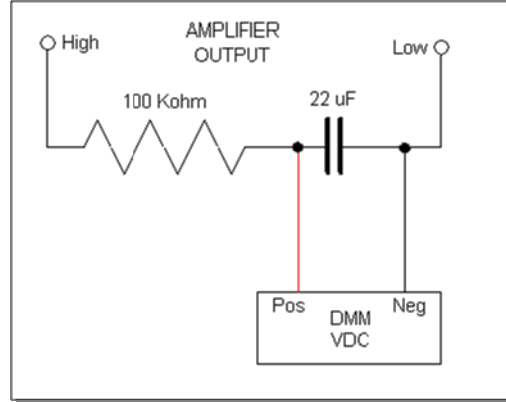

Figure 7-3: DC offset AC filter

7.4.1 Output Cal

300 VAC Range DC Zero: Program the output to the 300 VAC Range by pressing and selecting the 300 Range with the shuttle. Program the output to 0.0 volts and 60 Hz. Go to the OUTPUT CAL screen, select the VOLT ZERO parameter and adjust the output to 0.0 ± 0.005 VDC. *Save this value by pressing the ENTER key.*

300 VAC Range High Freq DC Zero: Required for Series II models with –HF option only. Program the output to the 300 VAC Range by pressing and selecting the 300 Range with the shuttle. Program the output to 0.0 volts and **820** Hz. Go to the OUTPUT CAL screen, select the VOLT ZERO parameter and adjust the output to 0.0 ± 0.005 VDC. *Save this value by pressing the ENTER key.*

To calibrate AC output, set the power source to the AC mode, high voltage range. For BPS units with the –HV optional range, use the 300V range for all calibrations. Select the OUTPUT CAL entry from the MENU 3 screen. Refer to section 5.2.10 for relevant LCD screen.

300 VAC Range Full-scale: Before programming the output voltage, first set the **ALC** mode to **OFF** in the UTILITY, VOLT/CURR CONTROL screen. Then select the 300 VAC Range from the Program 1 screen. Program the output to 240.0 volts and 60 Hz and close the output relay. Go to the OUTPUT CAL screen, select the VOLT FS and enter 20000. With the shuttle, adjust this value to obtain 240 ± 0.05 volts at the output as measured with an external DMM. Use the ENTER key to save this value.

7.4.2 Three Phase Mode

As indicated earlier, for 3-Phase power system (BPS30-3, BPS45-3, BPS75-3, BPS90-3, BPS150-3 and BPS180-3), repeat the preceding steps for the Phase B and C outputs. The order in which the outputs for each phase are calibrated is not important.

Press the PHASE key to select each output to be calibrated. Monitor the output of the respective phase by moving the HI input of the Digital Multimeter. The LO input should remain connected to the common LO of the sense connector.

7.4.3 Phase Angle Calibration

Output phase angle calibration is required only on BPS Series models capable of three-phase mode operation. A phase meter is required to perform this calibration.

This calibration can be done in either high or low voltage range as long as the maximum input voltage of the phase meter input is not exceeded. Select AC mode, three-phase mode, 120Vac, 60 Hz. Program all three-phase outputs to the same voltage.

For best results, the output of all amplifiers should be loaded to at least 80% of full scale voltage current on all phases at the same time. This requires a three-phase load. If no such load is available, perform this calibration with no load.

Proceed as follows:

1. Program AC mode, 3 phase, low voltage range, 120Vac, 50 or 60 Hz. Close output relay.
2. Select the OUTPUT CAL screen.
3. Connect phase meter between phase A and B outputs.
4. Use the PHASE key to select phase B in the upper right corner of the CAL screen.
5. Close output relay and measure the phase angle between phase A and Phase B.
6. Adjust PHASE OFST cal coefficient up or down and press ENTER key until phase B offset is $240^\circ \pm 0.5^\circ$ or better.
7. Connect phase meter between phase A and C outputs.
8. Use PHASE key to select phase C in the upper right corner of the CAL screen.
9. Adjust PHASE OFST cal coefficient up or down and press ENTER key until phase C offset is $120^\circ \pm 0.5^\circ$ or better.

7.4.4 Output Calibration Summary

The following Table is a summary of the preceding calibration steps. Program the following values in the table and make the adjustments in the OUTPUT CALIBRATION screen. Select the phase to be calibrated by pressing the PHASE key.

CALIBRATION	PROGRAM VALUES	CALIBRATION VALUE	ADJUST TO
300 VAC range DC Zero	300 VAC range, 0.0 V, 60 Hz	VOLT ZERO	0 ± 5 mV DC
300 VAC range High Freq DC Zero, -HF models only.	300 VAC range, 0.0 V, 820 Hz	VOLT ZERO	0 ± 5 mV DC
300 VAC range Volt FS	240.0 V, 60 Hz	VOLT FS	240 ± 0.05 VAC
Phase Offset B, C	150 VAC range, 120V, 60 Hz	PHASE OFST	$\pm 0.5^\circ$

Table 7-3: Output Calibration Table – BPS Series

7.5 Non-Routine Calibration



WARNING: THIS EQUIPMENT GENERATES POTENTIALLY LETHAL VOLTAGES. DEATH ON CONTACT MAY RESULT IF PERSONNEL FAIL TO OBSERVE SAFETY PRECAUTIONS. DO NOT TOUCH ELECTRONIC CIRCUITS WHEN POWER IS APPLIED

The non-routine calibration may involve removing the front or top cover of the power source. Use extreme caution when performing any of these tasks while the system is connected to AC mains and/or powered up.

7.5.1 Power Source Gain Adjustment

For any BPS configuration that requires two or more amplifiers to be operated in parallel for increased current output, the amplifier gains have to be matched as closely as possible to ensure equal current sharing. If an unbalance exists between amplifier outputs, one or the other amplifier will deliver more current and may run into its current limit protection before full output power can be attained.

This procedure details the gain adjustment. Generally, BPS units are shipped with the gains already set correctly so this task should only be undertaken if an amplifier has been replaced or if two BPS units are to be combined that were not originally shipped from the factory as such.

To make this adjustment the front cover must first be removed in order to get access to the power module output terminals.

If the power system to be adjusted is a BPS150 or BPS180 model, the procedure involves matching the output voltage of the A, B and C power modules in the master cabinet to the A, B and C power modules in the auxiliary cabinet. Proceed as follows:

1. Shut off all power to the cabinets. Disconnect the two wires going to Terminal 6 and Terminal 7 on the lower front of the power modules. Do this to module A, A', B, B', C and C' in the auxiliary cabinet(s) only. Place some temporary insulation over the lug ends.
2. Connect a DMM between terminals 6 and 7 on the A module in the **master cabinet**. Power up the cabinet. Set the controller to the 300V range, program 230V at 60Hz. Enable the output by pressing the OUTPUT ON/OFF key. Measure the A module output voltage and write it down. Press the OUTPUT ON/OFF key to disable the output.
3. Move DMM leads to the B module terminals 6 and 7. Press the OUTPUT ON/OFF key to enable the output. Measure the B module output and write it down, Press the OUTPUT ON/OFF key to disable the output.
4. Move DMM leads to the C module terminals 6 and 7. Press the OUTPUT ON/OFF key to enable the output. Measure the C module output and write it down, Press the OUTPUT ON/OFF key to disable the output.
5. Move the DMM leads to the A module terminals 6 and 7 in the **auxiliary cabinet**. Press the OUTPUT ON/OFF key again to enable the output. Verify the phase A module output is within 50mVolts of the A module in the master cabinet. If it is not, adjust the pot behind the hole in the upper left corner of the module so the A output matches the A master output within 50mVolts. Repeat for the A' module. Press the OUTPUT ON/OFF key to disable the output.
6. Move the DMM leads to the B module terminals 6 and 7 in the **auxiliary cabinet**. Press the OUTPUT ON/OFF key again to enable the output. Verify the phase B module output is within 50mVolts of the B module in the master cabinet. If it is not, adjust the pot behind the hole in the upper left corner of the module so the B output matches the B master output within 50mVolts. Repeat for the B' module. Press the OUTPUT ON/OFF key to disable the output.

7. Move the DMM leads to the C module terminals 6 and 7 in the **auxiliary cabinet**. Press the OUTPUT ON/OFF key again to enable the output. Verify the phase C module output is within 50mVolts of the C module in the master cabinet. If it is not, adjust the pot behind the hole in the upper left corner of the module so the C output matches the C master output within 50mVolts. Repeat for the C' module. Press the OUTPUT ON/OFF key to disable the output.
8. Power down system and replace the wires to terminals 6 and 7 on the auxiliary power modules.

8. Service

8.1 Cleaning

The exterior of the power source may be cleaned with a cloth dampened with a mild detergent and wrung out. Disconnect mains power to the source before cleaning. Do not spray water or other cleaning agents directly on the power source.

8.2 General

This section describes the suggested maintenance and troubleshooting procedures. The troubleshooting procedure is divided into two sections. The first section deals with basic operation and connection of the equipment. The second section requires opening the unit and using LED indicators and a simple multimeter to troubleshoot the unit down to the module level. Only a qualified electronic technician should attempt this level troubleshooting.

8.3 Basic operation

PARAGRAPH	PROBLEM
0	Excessive Output Voltage
8.3.2	Poor Output Voltage Regulation
8.3.3	Overload Light On
8.3.4	Distorted Output
8.3.5	Unit Shuts Down After 1-2 Seconds
8.3.6	No Output and no lights on front panel
8.3.7	No output, but front panel controller is active.

Table 8-1: Basic Symptoms

8.3.1 Excessive Output Voltage

CAUSE	SOLUTION
External sense not connected (If used)	Connect external sense wires from TB2 on rear panel to the AC power outputs on TB1A and TB1B

8.3.2 Poor Output Voltage Regulation

CAUSE	SOLUTION
Unit is overloaded	Remove overload
Unit is programmed to wrong voltage range.	Select correct voltage range.
Input line has fallen below spec. limit.	Check input supply voltage.

8.3.3 Overload Light is On

CAUSE	SOLUTION
Unit is overloaded	Remove overload or check CL setting
Unit is switched to high voltage range.	Select correct voltage range.

8.3.4 Distorted Output

CAUSE	SOLUTION
Power source is grossly overloaded.	Reduce load
The crest factor of the load exceeds 3:1 on the low range or 5:1 on the high range.	Reduce load current peaks by reducing load.

8.3.5 Unit Shuts Down after 1-2 Seconds

CAUSE	SOLUTION
Output shorted	Remove output short
Output grossly overloaded.	Remove overload.
PFC IGBT module failure	Have power module serviced
Operating load with too high inrush or start up currents.	Consult factory for application advice.

8.3.6 No Output and No Lights on Front Panel

CAUSE	SOLUTION
Input circuit breaker switched off.	Switch the breaker on.
No input power to F1 – F3 or F1 - F6 (model dependent).	Ensure 3 phase power is getting to input fuses.
LV Power Supply failure	Have LV supply serviced.

8.3.7 No Output But Front Panel controller is active

CAUSE	SOLUTION
“OUTPUT ON” button is turned off.	Press OUTPUT ON so that “ON” LED is lit.
REMOTE INHIBIT pins 5 & 6 at TB3 on rear panel are shorted together.	Check polarity setting or RI Mode. Use OUTPUT:RI[:LEVel] LOW/HIGH command to set RI mode to high or low.
Current limit programmed down or to zero.	Program current limit higher.
Voltage programmed down or to zero.	Turn amplitude control up.

8.4 Advanced Troubleshooting.



WARNING: *Do not connect 400-480V into the 208-240V unit, the result could be a severely damaged unit.*



CAUTION: *VOLTAGES UP TO 480 VAC AND 450 VDC ARE PRESENT IN CERTAIN SECTIONS OF THIS POWER SOURCE.*



WARNING: *THIS EQUIPMENT GENERATES POTENTIALLY LETHAL VOLTAGES. DEATH ON CONTACT MAY RESULT IF PERSONNEL FAIL TO OBSERVE SAFETY PRECAUTIONS. DO NOT TOUCH ELECTRONIC CIRCUITS WHEN POWER IS APPLIED*

8.4.1 Switch Off Unit

Switch off the unit at the circuit breaker on the front panel as well as removing the input power from the unit.



WARNING: *Wait 10 minutes for all internal capacitors to discharge.*

8.4.2 Removing Covers

Remove the screws securing the front cover and remove it.

Remove the screws securing the top cover and remove it.

8.4.3 Initial Inspection

Make a visual inspection of the unit and ensure all the connectors are properly mated and there are no loose wires.

8.4.4 Fuse Check

Using an ohmmeter, check input fuses F1 through F6 for continuity.

8.4.5 Power-on Troubleshooting Using the LED's.



WARNING: *Do not touch any parts inside the unit during this test as they will be live and dangerous. Always wear safety glasses.*

If the three input fuses are OK, then reconnect the main AC input power to the cabinet.

LV Supply (CI P/N 7003-722):

Turn the main breaker on and check green LED DS2 and DS3 on the system interface board. Both LEDs should be lit indicating the +/-19Vdc and +/-15Vdc supplies are OK.

If one or both of the LEDs is not lit, then there is something wrong with the LV power supply and it will have to be serviced.

Oscillator (Front Panel):

If LV supply appears good, then program 150Vac on the low range and connect a DMM to TP2 (phase A) on the system interface board with the low side of the meter connected to TP1. There should be a 2 – 3 volt rms signal present on TP2. Check TP3 (phase B) for the same signal. Check TP4 (phase C) for the same signal.

AC power module (CI P/N 7003-433-X):

If the oscillator drive signals are present on the system interface board, connect the DMM to brass terminals 5 & 6 located near the bottom of the power module. Program 100 Volts.

There should be about 100Vac between terminals 5 and 6. If no voltage at all is measured it is possible that the AC power stage inside the module has failed and it will be necessary to remove the power module from the chassis for closer inspection.



WARNING: *Wait 10 minutes for all internal capacitors to discharge.*

To remove the power module proceed as follows:

1. Disconnect the 7 wires going to the brass terminals on the lower front panel of the module. Label the wires so they can be reinstalled correctly later.
2. Remove screws securing the upper and lower straps holding the module in the chassis slot.
3. Remove the 50-pin ribbon connector at J50A, B or C.
4. Carefully slide module outward and lift out of cabinet. Use caution, module weighs 66 LBS (30Kg).
5. With the power module out of the cabinet and lying flat on a bench, remove the screws on the bottom and sides of the left hand cover as seen from the front when module is installed normally.
6. Inspect the three IGBT transistor modules Q1, Q2 and Q3 for any visible damage.
7. Using an ohmmeter check the 30A fuses on the positive and negative side of the power distribution board that connects the four amplifier modules to the DC bus. If any of them are open, then one or more of the amplifier sections has a damaged device on the heat sink assemblies and the power module assembly will have to be serviced.

8.4.6 Other No Output Conditions

If one or more outputs (phase A, B or C) do not produce an output, it may be caused by an amplifier failure. Amplifier failures can either be input (PFC) or output related (Amp). To determine if this is the case, the cover of the amplifier has to be removed. Contact customer service service.ppd@ametek.com before attempting to diagnose on your own.

PFC failure denotes one or all three of the IGBT power modules on the large PFC heat sink have shorted, and damaged the devices. This type of failure is sometimes accompanied by a popping sound as the large PFC power devices give out. To diagnose this failure mode, the amplifiers must be removed and the cover removed for inspection.

If there is any sign of damage, the PFC power devices must be replaced. If not, they need to be checked for continuity using a DMM or diode checker.

In case of a PFC failure, older generation PFC control boards (7003-705 or 7003-712) may have sustained damaged in the isolated gate drive section of the board and the board itself may have to be replaced. BPS Systems with later generation 7003-716 PFC control boards generally will only require replacement of the 2A gate fuses to restore functionality.

If the PFC section looks intact, one of the output amplifier switches may have shorted.

The usual scenario is one or two of the IGBT switch devices on one of the 4 heat sinks get shorted. Usually if the B+ device is failed, the B- device will also short. When these devices short, one or more of the 30A fuses (F1 through F8) on the DC power distribution board will be open.

An amplifier device failure is not audible at all so there may be no indication of this other than checking as follows:

1. Measure the output voltage with Zero AC volts programmed.
2. Remove any EUT from the output connections.
3. Turn output ON and measure the AC and DC output. It should be close to zero.
4. If the output reads -225VDC on the low range and close to 0 Vdc on the high range, then it is almost certain that the fuse is blown and 1 or 2 IGBT devices are shorted.

Note that the measurement screen will not report the DC faulty output voltage in the AC mode, as the measurements in this mode are AC coupled. Therefore, it is necessary to measure at the output terminals with a DMM to determine the actual output. Alternatively, the BPS can be switched to AC+DC mode in which case the internal measurements can be used instead.

If it is determined that it is an amplifier failure, the affected power MOSFET's need to be replaced. If no local service support is available, the amplifier may be exchanged completely. Contact customer service service.ppd@ametek.com for module exchange information.

8.5 Factory Assistance

If the problem with the cabinet or one of the power modules cannot be isolated, contact the factory for assistance.

8.6 Fuses

FUSE #	FUNCTION	FUSE VALUE	CI #
F1 thru F6	AC mains input, 208 - 240V.	200A	270246
F1 thru F6	AC mains input, 400 - 480V	110A	270226
F1	Power Module PFC Fuse	100A	270249
F1 – F8	AMP Heat Sink Fuses	30A	270168
F7	Fan Fuse, 250V	2A	270134

Table 8-2: BPS75 and BPS90 Fuse Ratings

8.7 Firmware Updates

All BPS Series units support firmware updates over the RS232C interface. Units that support firmware updates over the RS232 interface will have a longer initial delay at power up. This additional time delay at power-up allows the firmware erase and upload process to be engaged if needed.

8.7.1 Requirements

This section provides basic instructions for updating firmware on BPS series AC power sources. The following items are required to download new firmware:

- A copy of the new firmware in HEX format. Typically named “cic637rn.nn.hex” where “n.nn” represents the revision of the firmware. The file may be downloaded from the AMETEK Programmable Power website (www.programmablepower.com) or may have been distributed through email. If the file is archived to a zip, it must be unzipped to its original HEX format (.hex extension) before it can be used.
- The FlashLoaderComm utility program. This Windows program can be downloaded from the AMETEK Programmable Power website (www.programmablepower.com) under GUI/Software. You need to be a registered user to do so.
- A Windows 2000/XP PC with available RS232 serial port (COM port).
- A RS232² serial cable, CI P/N 7000-263-2. This cable is provided in the BPS Series ship kit. If lost, refer to the BPS Series programming manual (PN 7003-961) for cable pin-out information or contact customer service (service.ppd@ametek.com) to order a replacement.

8.7.2 Download Instructions

Copy both FlashLoaderComm.exe and cic637rn.nn.hex files to a temporary folder on your PC. If the FlashLoaderComm.exe was downloaded from the CI web site, it will have to be installed. This is a self-extracting program installation. Just double click on the exe file to perform the installation and follow the user prompts.

Cic637rn.nn.exe is the hex file that contains the firmware update. The n.nn will be the revision number of the firmware. The hex file may be distributed as a WinZip archive with a .zip extension. In that case, unzip the .zip file to its native .hex format before attempting to upgrade the BPS unit.

Please record the revision of the previous firmware before the update for reference. The firmware revision is displayed during power up sequence of the BPS AC source.

Connect the 7000-263-2 RS232 cable (9 pin to 9 pin) between the power source and an available COM port of the PC.

² The GPIB interface cannot be used for this purpose, as the Flash boot loader is a small resident program that does not support GPIB communications.

Power up the AC source using its on/off switch. A message will appear on the LCD once the power comes on:

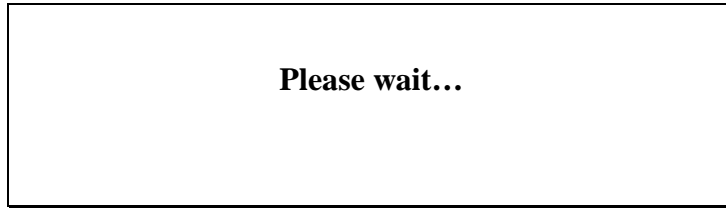

After about 30 seconds, this message changes to:

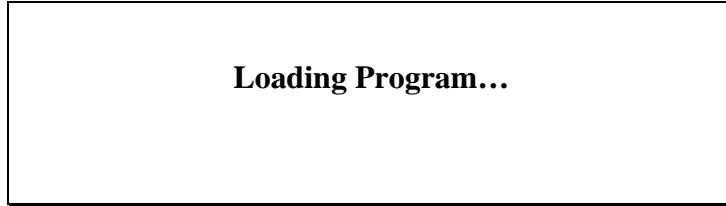

When this “Loading Program...” message appears on the LCD of the BPS front panel, **press the ENTER key on the keypad of the BPS unit once**. If you wait too long, you may have missed the window and you will have to recycle power on the AC source and try again.

This will put the source controller into the Flash down load mode. Wait until the screen shown below appears. This screen shows the RS232 setup parameters that are used in the boot loader mode.

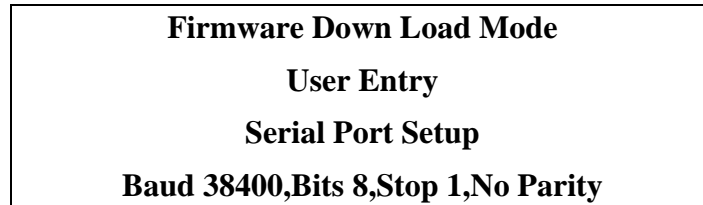

Now launch the Flash Loader utility program “FlashLoaderComm.exe”.

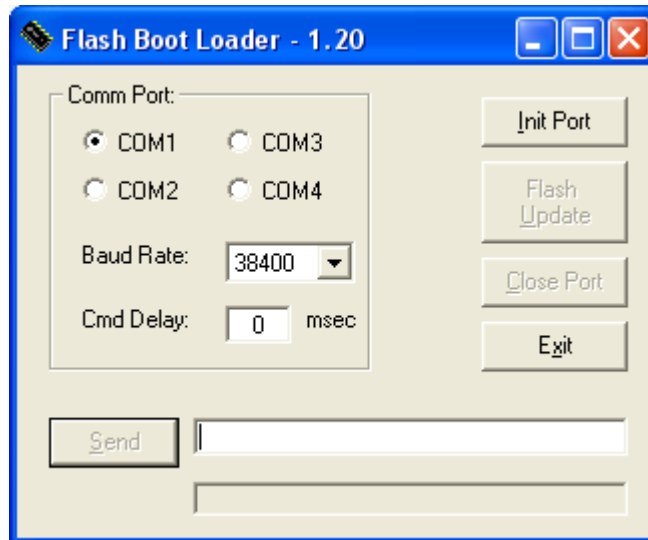

Select the COM port to be used (default is COM1). Leave “Baud rate” and “Cmd Delay” set to their default values of 38400 baud and 0 msec.

Click on the “Init Port” button. If the selected port can be initialized, the “Flash Update” button will be enabled. If not, check the selected COM port and make sure it is the one connected to the BPS.

Press the “Flash Update” button. This will display the file download screen shown below.

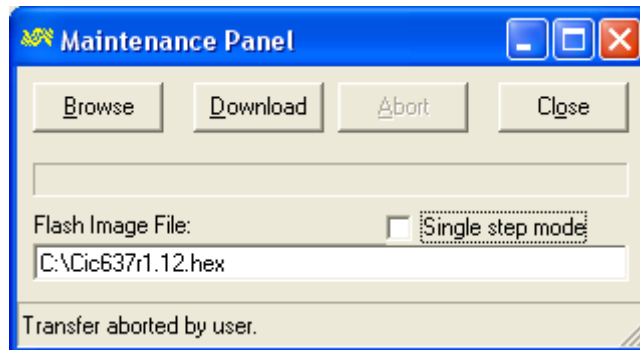

Select Browse and locate the file Cic637rn.nn.hex at the location on the PC where you stored it before.

Click on the “Download” button. This will start the firmware update procedure. The front panel display for the AC source will display the message “Erasing Flash” first, followed by “Flash erase complete” and “Programming Flash”. The download will be completed in about 5 to 10 minutes depending on the size of the .hex file.

After the download completes successfully, the power source will initialize with the new firmware. Observe the LCD display for the firmware revision displayed during initialization to confirm the new firmware is now installed.

8.7.3 Flash down load Messages

One or more messages may appear during this process. The table below shows some of the possible message and their meaning.

Message	Description	Remedy
Flash erase complete	Erase operation successful.	
Flash erase fail	Firmware download capability not supported by CPU board..	Refer to Service Bulletin SB-0043
Flash write fail	Unable to write to flash. This message is unlikely as it generally is preceded by the Flash Erase Fail message.	Refer to Service Bulletin SB-0043
Firmware down load fail	Data error. Incorrect checksum read-back from Flash block. Communication interrupted or problem with RS232 interface.	1. Check cable connection. 2. Try setting CmdDelay in Flash loader program to 100 msec and try again.

Table 8-3: Flash Down load Messages

9. Top Assembly Replaceable Parts – BSP30 and BPS45 Models

Note that different generation and model BPS units may use different sub assemblies. Check the serial tag on the back of the MX to determine the applicable top assembly number to determine the correct sub assembly or part required. For amplifiers, refer to the amplifier serial tag for the relevant amplifier top assembly part number.

Table 9-1: BPS 30 and BPS45 - Replaceable Parts and Fuses

Ref.	CI P/N	Description	Vendor	Qty	Location
Top Assembly 7003-427 / 7003-422					
A2	7003-421-1	Front Panel Assy. Prog. Osc.	AMETEK PP	1	
	7003-718-2	CPU board assy. All 3 phase MX.	AMETEK PP	1	
	7003-718-4	CPU board assy. MX30-1, MX45-1 only.	AMETEK PP	1	
	7000-723-4	Keyboard/Display assy.	AMETEK PP	1	
Top Assembly 7003-400					
A2	7003-401-1	Front Panel Assy. Prog. Osc.	AMETEK PP	1	
	5100-707-2	CPU / Phase A board assy.	AMETEK PP	1	
	7000-722-2	Phase B/C board assy.	AMETEK PP	1	
	7000-723-1	Keyboard/Display assy.	AMETEK PP	1	
Top Assembly 7003-427					
A1	7003-721-1	PC Assy. RS232 / GPIB / USB	AMETEK PP	1	
A1	7003-721-2	PC Assy. RS232 / GPIB / USB / LAN	AMETEK PP	1	
A6	7003-722-1	PC Assy., Low Volt PSU	AMETEK PP	1	
	7003-723-1	Ripple Filter	AMETEK PP	1	
Top Assembly 7003-422 / 7003-400					
A1	7003-703-1	PC Assy. RS232 / GPIB	AMETEK PP	1	
A1	7003-703-2	PC Assy. RS232 / GPIB	AMETEK PP	1	
A6	7003-702-1	PC Assy., Low Volt PSU	AMETEK PP	1	
Top Assembly 7003-427 / 7003-422 / 7003-400					
A2	7003-408-1	Front Panel Assy., Auxiliary	AMETEK PP	1	
A3	7003-728-1	PC Assy., System Interface	AMETEK PP	1	
A4	7003-701-1	PC Assy., V / I Sense	AMETEK PP	1	
A10	7003-714-1	PC Assy., EMI Filter	AMETEK PP	1	
A7	7003-448-1	Amplifier Assy., 15kVA	AMETEK PP	1	
A8	7003-448-1	Amplifier Assy., 15kVA	AMETEK PP	1	
A9	7003-448-1	Amplifier Assy., 15kVA	AMETEK PP	1	
B1	241186	Fan, 3", 24VDC	NMB Technology 3110KLO5WB50-P00	1	
CB1	270224	Circuit Breaker, 2.5A, 300V	AIRPAX IELH111-1-61-2-50-D-01-V	1	
K1	245235	Relay, 3C, 30A, 24VDC	Deltrol Controls 21014 - 82	1	
K8	245235	Relay, 3C, 30A, 24VDC	Deltrol Controls 21014 - 82	1	
K2	245247	Relay, 3C, 90A, 24VDC	ABB AF50-30-00-72	1	
K6	245247	Relay, 3C, 90A, 24VDC	ABB AF50-30-00-72	1	
K7	245247	Relay, 3C, 90A, 24VDC	ABB AF50-30-00-72	1	
K9	245247	Relay, 3C, 90A, 24VDC	ABB AF50-30-00-72	1	

Ref.	CI P/N	Description	Vendor	Qty	Location
K3	245248	Relay, 3C, 100A, 24VDC	ABB AF75-30-00-72	1	
K5	245248	Relay, 3C, 100A, 24VDC	ABB AF75-30-00-72	1	
K4	245248	Relay, 3C, 100A, 24VDC	ABB AF75-30-00-72	1	

Ref.	CI P/N	Description	Vendor	Qty	Location
Amplifier Assy. 15Kva 7003-448-1					
A1	7003-730-1	PC Assy., Modulator	AMETEK PP	1	A7 thru A12
A2	7003-716-1	PC Assy, PFC	AMETEK PP	1	A7 thru A12
A5	7003-726-1	PC Assy., Output Filter	AMETEK PP	1	A7 thru A12
A6	7003-726-2	PC Assy., Output Filter	AMETEK PP	1	A7 thru A12
A8	7003-708-1	PC Assy, Fan Control	AMETEK PP	1	A7 thru A12
A14	7003-729-1	PC Assy, Pwr Interconnect	AMETEK PP	1	A7 thru A12
Q1	330450	Transistor, FET	INFINEON, IPW60R045CPXK	4	A7 thru A12
Q2	330450	Transistor, FET	INFINEON, IPW60R045CPXK	4	A7 thru A12
Q3	330450	Transistor, FET	INFINEON, IPW60R045CPXK	4	A7 thru A12
Q4	330450	Transistor, FET	INFINEON, IPW60R045CPXK	4	A7 thru A12
CR13	845-360-60	Rec, Pwr, 600V, 30A	Fairchild, RHRG3060	1	A7 thru A12
CR14	845-360-60	Rec, Pwr, 600V, 30A	Fairchild, RHRG3060	1	A7 thru A12
CR15	845-360-60	Rec, Pwr, 600V, 30A	Fairchild, RHRG3060	1	A7 thru A12
CR16	845-360-60	Rec, Pwr, 600V, 30A	Fairchild, RHRG3060	1	A7 thru A12
Q1	330437	Transistor, IGBT	FUJI, 2MBI150TA-060	1	A7-PFC
Q2	330437	Transistor, IGBT	FUJI, 2MBI150TA-060	1	A8-PFC
Q3	330437	Transistor, IGBT	FUJI, 2MBI150TA-060	1	A9-PFC

Seq #	CI P/N	Description	Vendor	Qty	Assy. Number and Location
Top Assembly 7003-400-01					
F1	270246	FUSE, 200A, 600V	Ferraz Shawmut A6T200 Littlefuse JLLS 200	1	For 208V / 230V Input
F2	270246	FUSE, 200A, 600V	Ferraz Shawmut A6T200 Littlefuse JLLS 200	1	
F3	270246	FUSE, 200A, 600V	Ferraz Shawmut A6T200 Littlefuse JLLS 200	1	
F1	270226	FUSE, 110A, 600V	Ferraz Shawmut A6T110 Littlefuse JLLS 110	1	For 400V / 480V Input
F2	270226	FUSE, 110A, 600V	Ferraz Shawmut A6T110 Littlefuse JLLS 110	1	
F3	270226	FUSE, 110A, 600V	Ferraz Shawmut A6T110 Littlefuse JLLS 110	1	
Amplifier Assy. 15kVA 7003-448-1					
F1	270249	FUSE, 100A, 500V	Ferraz Shawmut A50QS100-4	3	A7, A8, A9
F1-F8	270168	FUSE, 30A, 600V	Bussmann KTK-30 Littlefuse KLK-30	24	A7, A8, A9 7003-729-1
Low Voltage Power Supply 7003-722-1					
F1	270192	FUSE, Poly switch	Raychem RUE250	1	A6
F2	270192	FUSE, Poly switch	Raychem RUE250	1	A6
F3	270189	FUSE, Poly switch	Raychem RXEF110	1	A6
Fan Control 7003-708-1					
F1	270183	FUSE, 3A, 250V	Bussmann PCC3	1	A7-A8
F1	270183	FUSE, 3A, 250V	Bussmann PCC3	1	A8-A8
F1	270183	FUSE, 3A, 250V	Bussmann PCC3	1	A9-A8
F2	270192	FUSE, Poly switch	Raychem RUE250	1	A7-A8
F2	270192	FUSE, Poly switch	Raychem RUE250	1	A8-A8
F2	270192	FUSE, Poly switch	Raychem RUE250	1	A9-A8

10. Top Assembly Replaceable Parts – BPS75, BPS90, BPS150 and BPS180 Models.

Note that different generation and model BPS units may use different sub assemblies. Check the serial tag on the back of the BPS to determine the applicable top assembly number to determine the correct sub assembly or part required. For amplifiers, refer to the amplifier serial tag for the relevant amplifier top assembly part number.

Table 10-1: BPS75/BPS90, BPS150 and BPS180 - Replaceable Parts & Fuses

Ref.	CI P/N	Description	Vendor	Qty	Location
Oscillator Assembly 7003-442					
A2	7003-442-1	Front Panel Assy. Prog. Osc.	AMETEK PP	1	
A2-A9	7000-723-4	Keyboard/Display assy.	AMETEK PP	1	
A2-A5	7003-715-3	PC Assy. Indicator	AMETEK PP	1	
A2-A7	7003-718-7	CPU board assy. All 3 phase	AMETEK PP	1	
A2-A11	7003-719-1	PC Assy. Aux Generator	AMETEK PP	1	
Top Assembly 5440001					
A1	7003-721-6	PC Assy, RS232/GPIB/USB	AMETEK PP	1	
A14	7003-722-1	PC Assy, Low Volt PSU	AMETEK PP	1	
A15	7003-722-1	PC Assy, Low Volt PSU	AMETEK PP	1	
A16	7003-723-1	Ripple Filter	AMETEK PP	1	
A3	7003-731-1	PC Assy., System Interface	AMETEK PP	1	
A4,A5	7003-701-1	PC Assy., V / I Sense	AMETEK PP	2	
A13	7003-714-1	PC Assy., EMI Filter	AMETEK PP	1	
A7	7003-448-1	Amplifier Assy., 15kVA	AMETEK PP	1	
A8	7003-448-1	Amplifier Assy., 15kVA	AMETEK PP	1	
A9	7003-448-1	Amplifier Assy., 15kVA	AMETEK PP	1	
A10	7003-448-1	Amplifier Assy., 15kVA	AMETEK PP	1	
A11	7003-448-1	Amplifier Assy., 15kVA	AMETEK PP	1	
A12	7003-448-1	Amplifier Assy., 15kVA	AMETEK PP	1	
B1, B2	241186	Fan, 3", 24VDC	NMB Technology 3110KLO5WB50-P00	2	
B3, B4	853-230-77	Fan, 6-3/4", 230VAC	Orion OA172SAP-22-1TB	2	
CB1	270224	Circuit Breaker, 2.5A, 300V	AIRPAX IELH111-1-61-2-50-D-01-V	1	
K1A K1B	245235	Relay, 3C, 30A, 24VDC	Deltrol Controls 21014 - 82	2	
K8	245235	Relay, 3C, 30A, 24VDC	Deltrol Controls 21014 - 82	1	
K2A K2B K6, K7, K9	245248	Relay, 3C, 100A, 24VDC	ABB AE75-30-00-81	5	
K5	852-145-00	Contactora, 3 Pole, 230A	ABB AF145-30-00-72	1	
K3	5440065-01	Relay Assy, 250A	Ametek PP		
R1-R6	811-12R-17	Res, 12 ohm, 175W, Rib-wound	Milwaukee Resistor 061807212.000EBRKT	6	

Ref.	CI P/N	Description	Vendor	Qty	Location
Amplifier Assy. 15Kva 7003-433-5					
A1	7003-730-1	PC Assy., Modulator	AMETEK PP	1	A7 thru A12
A2	7003-716-1	PC Assy, PFC	AMETEK PP	1	A7 thru A12
A5	7003-726-1	PC Assy., Output Filter	AMETEK PP	1	A7 thru A12
A6	7003-726-2	PC Assy., Output Filter	AMETEK PP	1	A7 thru A12
A8	7003-708-1	PC Assy, Fan Control	AMETEK PP	1	A7 thru A12
A14	7003-729-1	PC Assy, Pwr Interconnect	AMETEK PP	1	A7 thru A12
Q1	330450	Transistor, FET	INFINEON, IPW60R045CPXK	4	A7 thru A12
Q2	330450	Transistor, FET	INFINEON, IPW60R045CPXK	4	A7 thru A12
Q3	330450	Transistor, FET	INFINEON, IPW60R045CPXK	4	A7 thru A12
Q4	330450	Transistor, FET	INFINEON, IPW60R045CPXK	4	A7 thru A12
CR13	845-360-60	Rec, Pwr, 600V, 30A	Fairchild, RHRG3060	1	A7 thru A12
CR14	845-360-60	Rec, Pwr, 600V, 30A	Fairchild, RHRG3060	1	A7 thru A12
CR15	845-360-60	Rec, Pwr, 600V, 30A	Fairchild, RHRG3060	1	A7 thru A12
CR16	845-360-60	Rec, Pwr, 600V, 30A	Fairchild, RHRG3060	1	A7 thru A12
Q1	330437	Transistor, IGBT	FUJI, 2MBI150TA-060	1	A7-PFC
Q2	330437	Transistor, IGBT	FUJI, 2MBI150TA-060	1	A8-PFC
Q3	330437	Transistor, IGBT	FUJI, 2MBI150TA-060	1	A9-PFC

Seq #	CI P/N	Description	Vendor	Qty	Assy. Number and Location
Top Assembly 5440001					
F1-F2	270246	FUSE, 200A, 600V	Ferraz Shawmut A6T200 Littelfuse JLLS 200	2	For 208V / 230V Input
F3-F4	270246	FUSE, 200A, 600V	Ferraz Shawmut A6T200 Littelfuse JLLS 200	2	
F5-F6	270246	FUSE, 200A, 600V	Ferraz Shawmut A6T200 Littelfuse JLLS 200	2	
F1-F2	270226	FUSE, 110A, 600V	Ferraz Shawmut A6T110 Littelfuse JLLS 110	2	For 400V / 480V Input
F3-F4	270226	FUSE, 110A, 600V	Ferraz Shawmut A6T110 Littelfuse JLLS 110	2	
F5-F6	270226	FUSE, 110A, 600V	Ferraz Shawmut A6T110 Littelfuse JLLS 110	2	
F7	270134	FUSE, 2A, 250V	Littelfuse, 313002	1	
Amplifier Assy. 15kVA 7003-448-5					
F1	270249	FUSE, 100A, 500V	Ferraz Shawmut A50QS100-4	6	A7 thru A12
F1-F8	270168	FUSE, 30A, 600V	Bussmann KTK-30 Littlefuse KLK-30	48	A7 thru A12 7003-729-1
Low Voltage Power Supply 7003-722-1					
F1	270192	FUSE, Poly switch	Raychem RUE250	2	A14,A15
F2	270192	FUSE, Poly switch	Raychem RUE250	2	A14,A15
F3	270189	FUSE, Poly switch	Raychem RXEF110	2	A14,A15
Fan Control 7003-708-1					
F1	270183	FUSE, 3A, 250V	Bussmann PCC3	1	A7-A8
F1	270183	FUSE, 3A, 250V	Bussmann PCC3	1	A8-A8
F1	270183	FUSE, 3A, 250V	Bussmann PCC3	1	A9-A8
F2	270192	FUSE, Poly switch	Raychem RUE250	1	A7-A8
F2	270192	FUSE, Poly switch	Raychem RUE250	1	A8-A8
F2	270192	FUSE, Poly switch	Raychem RUE250	1	A9-A8

11. Options

11.1 Introduction

There are a number of options available for the BPS Series, both hardware and software. While not all or no options may be present on your specific unit, this section of the manual incorporates the user documentation for all available options. There is no separate manual for these options except possible manual addenda for special engineering request (SER) systems. If your system has an SER number as part of the model number, refer to any manual addendum that was shipped with the unit.

11.1.1 Option -HV: Additional AC Voltage Range

The -HV option provides an alternate AC only output voltage range of 0-400 VRMS. There is no equivalent 200 VRMS range associated with the -HV option but the standard 0-150 V RMS and 0-300 V RMS remain available even if the -HV option is installed.

If the -HV option is installed, there will be three voltage ranges that can be selected from the PROGRAM 1 menu. (150/300/400). Other than the range values, all other operations remain the same. Note however that the -HV range is AC coupled and as such offers no DC output capability. Thus, whenever the 400 V range is selected, the output mode is automatically set to AC MODE and other modes cannot be selected.

Since the -HV option range is AC coupled, the lower frequency limit on the -HV range is 45 Hz and not the 16 Hz that applies to the standard 150/300V ranges. The upper frequency limit remains the same.

11.1.2 Option -ES: Emergency Stop Push Button

This red emergency stop push button is installed on the front panel of the master BPS chassis at the factory when this option is ordered with a BPS power source system. When pushed in, the main AC contactor is opened disconnecting the AC input power to the BPS input transformer which causes the power source's output power to be removed. Note that the controller (and LCD display) will still be powered up but no power is available to the amplifiers and there will be no output power as well. The controller runs off the LV supply, which must be turned off with the front panel breaker.

After the ES has been pushed, the provided key will be required to release it. Once the ES button has been released, the BPS power source **must** be powered down using the front panel circuit breaker and turned back on to start up again.

Note: For two chassis BPS power source systems (BPS150 and BPS180) a BNC cable connects between the cabinets for the ES shut down system connection.

Note: Do not misplace the 2 keys provided, as no duplicates are available from CI. If lost, the ES switch must be replaced. In this case, contact AMETEK Programmable Power customer service. (service.ppd@ametek.com).

12. Error Messages

Any errors that occur during operation from either the front panel or the remote control interface will result in error messages. Error messages are displayed in the upper left hand corner of the LCD display. They are also stored in the error message queue from which they can be queried using the SYST:ERR? Query. The error queue has a finite depth. If more error messages are generated than can be held in the queue, a queue overflow message will be put in the last queue location. To empty the queue, use the error query until the No Error result is received.

Errors appearing on the LCD will generally remain visible until the user moves to another screen. If multiple error messages are generated in succession, only the last message will be visible as there is only space for one error message on the LCD display.

The same area of the display is also used to display status messages. While error messages always have a negative error number, status messages have a positive number.

The table below displays a list of possible error and status messages along with their possible cause and remedy.

Number	Message String	Cause	Remedy
0	"No error"	No errors in queue	
-100	"Command error"	Unable to complete requested operation	Unit may be in a mode inconsistent with request.
-102	"Syntax error"	Command syntax incorrect.	Misspelled or unsupported command
-103	"Invalid separator"	SCPI separator not recognized	See SCPI section of programming manual.
-104	"Data type error"	Data type invalid.	Check command for supported data types
-108	"Parameter not allowed"	One or more additional parameters were received.	Check programming manual for correct number of parameters
-109	"Missing parameter"	Too few parameters received for requested operation	Check programming manual for correct number of parameters
-110	"Command header error"	Command header incorrect	Check syntax of command.
-111	"header separator error"	Invalid command separator used.	Use semi-colon to separate command headers
-112	"Program mnemonic too long"	Syntax error	Check programming manual for correct command syntax
-113	"Undefined header"	Command not recognized error	Check programming manual for correct command syntax
-120	"Numeric data error"	Data received is not a number	Check programming manual for correct command syntax
-121	"Invalid character in number"	Number received contains non-numeric character(s)	Check programming manual for correct command syntax
-123	"Exponent too large"	Exponent in number exceeds limits	Check programming manual for correct parameter range
-128	"Numeric data not allowed"	Number received when number is not allowed.	Check programming manual for correct command syntax
-168	"Block data not allowed"	Block data was sent.	Check programming manual for correct command syntax
-200	"Execution error"	Command could not be executed	Command may be inconsistent with mode of operation such as programming frequency when in

Number	Message String	Cause	Remedy
			DC mode.
-201	"Invalid while in local"	Command issued but unit is not in remote state	Put instrument in remote state before issuing GPIB commands.
-203	"Command protected"	Command is locked out	Some commands are supported by the unit but are locked out for protection of settings and are not user accessible.
-210	"Trigger error"	Problem with trigger system.	Unit could not generate trigger for transient execution or measurement.
-211	"Trigger ignored"	Trigger request has been ignored.	Trigger setup incorrect or unit was not armed when trigger was received. Check transient system or measurement trigger system settings.
-213	"Init ignored"	Initialization request has been ignored	Unit was told to go to armed state but was unable to do so. Could be caused by incorrect transient system or measurement acquisition setup.
-220	"Parameter error"	Parameter not allowed.	Incorrect parameter or parameter value. Check programming manual for allowable parameters
-221	"Setting conflict"	Requested setting conflicts with other setting in effect.	Check other settings. E.g. trying to program a DC offset while in AC mode
-222	"Data out of range"	Parameter data outside of allowable range.	Check programming manual for allowable parameter values
-223	"Too much data"	More data received than expected	Check programming manual for number of parameters or data block size
-224	"Illegal parameter value"	Parameter value is not supported	Check programming manual for correct parameters
-226	"Lists not same length"	One or more transient lists programmed has different length.	All lists must be of same length or transient cannot be compiled and executed.
-241	"Hardware missing"	N/A	N/A
-254	"Media full"	No storage space left to save settings or data.	Delete other settings or data to make room.
-255	"Directory full"	Too many waveform directory entries	Delete one or more waveforms from waveform memory to make room.
-256	"File name not found"	Waveform requested not in directory	Check waveform directory for waveform names present.
-257	"File name error"	Incorrect filename	Too many or non ASCII characters used in waveform file definition.
-283	"Illegal variable name"	Variable name illegal.	Use ASCII characters only
-300	"Device specific error"	Hardware related error	Check hardware for proper operation.
-311	"Memory error"	Waveform memory checksum error.	May be the result of incomplete user-defined waveform download. Check interface and try

Number	Message String	Cause	Remedy
			downloading waveform again. Successful download may clear this error condition. Alternatively, use TRAC:DEL:ALL command to clear waveform memory.
-314	"Save/recall memory lost"	User setup register contents lost	Store setup in same register again.
-315	"Configuration memory lost"	Hardware configuration settings lost.	Contact CI service department at service.ppd@ametek.com to obtain instructions on restoring configuration data.
-330	"Self-test failed"	Internal error	Contact CI service department at service.ppd@ametek.com
-350	"Queue overflow"	Message queue full.	Too many messages. Read status using SYST:ERR query until 0, "No Error" is received indicating queue empty.
-400	"Query error"	Unable to complete query.	Check programming manual for correct query format and parameters
-410	"Query INTERRUPTED"	Query issued but response not read.	Check application program for correct flow. Response must be read after each query to avoid this error.
-420	"Query UNTERMINATED"	Query incomplete.	Check for terminator after query command.
-430	"Query DEADLOCKED"	Query cannot be completed	Check application program for multiple queries
-440	"Query UNTERMINATED"	Query incomplete.	Check for terminator after query command.
1	"Output volt fault"	Output voltage does not match programmed value.	Load exceeds current limit and unit is in Constant Voltage (CV) mode of operation. Reduce load or increase CL setting. Output voltage is driven above programmed voltage by external influence (Load, voltage kickback, etc.)
2	"Current limit fault"	Current limit exceeded.	Load exceeds current limit and unit is in Constant Voltage (CV) mode of operation. Reduce load or increase CL setting
3	"Temperature fault"	Temperature of heat sink too high.	Reduce load. Ensure proper airflow and exhaust clearance. Check fan(s) for operation.
4	"External sync. error"	Could not sync to external sync signal.	External sync signal missing, disconnected or out of range.
5	"Initial memory lost"	Power on settings could not be recalled.	Save power on settings again to overwrite old content.
6	"Limit memory lost"	Hardware configuration settings lost.	Contact CI service department at service.ppd@ametek.com to obtain instructions on restoring

Number	Message String	Cause	Remedy
			configuration data.
7	"System memory lost"	Memory corrupted.	Recycle power.
8	"Calibration memory lost"	Calibration data lost.	Contact CI service department at service.ppd@ametek.com to obtain instructions on restoring calibration data or recalibrate unit.
9	"Start angle must be first sequence"	Start phase angle in wrong place..	Start phase angles can only programmed at the start of a transient list. Once a transient is in progress, phase angle cannot be changed.
10	"Illegal for DC"	Operation not possible in DC mode.	Switch to AC or AC+DC mode.
11	"Duplicate sequence"	Transient list sequence number already used.	User new or available sequence number instead.
12	"Too many sequence"	Number of transient list steps exceeds maximum.	Reduce the number of steps in the transient list. (Max = 32 for Series I or 100 for Series II).
13	"Missing list parameter"	One or more transient list parameters missing.	Check programmed lists.
14	"Voltage peak error "	Peak voltage exceeds internal bus voltage	This error may occur when selecting user defined wave shapes with higher crest factors. Reduce programmed RMS value.
15	"Slew time exceed dwell"	Time needed to slew to final value is less than dwell time.	Check dwell times in transient list settings. Increase dwell time or change slew rate for affected parameter.
16	"Illegal during transient"	Operation requested not available while transient is running.	Wait till transient execution is completed or abort transient execution first.
17	"Output relay must be closed"	Operation not possible with open relay	Close relay before attempting operation. E.g. transient execution requires output relay to be closed.
18	"Trans. duration less then 1msec"	Dwell time below minimum or 1 msec	Increase dwell time to at least 1 msec.
19	"Clock and sync must be internal"	Operation not possible with external clock	Switch to internal sync. (Default)
20	"Input buffer full"	Too much data received.	Break up data in smaller blocks.
21	"EOS Fault"	Hardware error reported by EOS option. This option is not available on BPS Series products.	Cycle power on EOS to reset error. If error persists, contact CI service at service.ppd@ametek.com for repair.
22	"Waveform harmonics limit"	Harmonic contents of user defined wave shape are too high and could damage amplifier.	Reduce harmonic content or reduce fundamental frequency programmed.
23	"ALC or Impedance must be off"	Conflict between ALC and programmable impedance mode.	Turn off ALC to use programmable impedance. Turn off programmable impedance to use ALC.
24	"Output relay must be open"	Attempting to change voltage range while output relay is	Open output relay first, then change range. This ensures the load

Number	Message String	Cause	Remedy
		closed.	is physically disconnected during voltage range change.
25	“Over voltage prot trip	Over voltage protection trip.	Output voltage exceeds voltage range value. Check sense connections if external sense mode is used.
26	“Peak curr prot trip”	Maximum available peak current capability of power source exceeded. Note: Firmware rev 4.52 or higher.	This error will trip if PONS:CURR:PEAK:PROT status is set to 1 and the peak current drawn by the load exceeds the maximum specified peak current capability for more than 30 seconds. To avoid this error, reduce the load on the power source or upgrade to a larger power configuration.
27	“Frequency error”	Frequency is out of allowable range.	Indicates a problem with programmable controller.
28	“Phase error”	Incorrect phase	
29	“DC component exceeds limit”	The waveform selected contains a DC offset that exceeds the AC mode capability.	Select AC+DC mode.
30	“Amplifier fault”	Amplifier fault.	Contact customer service.
31	“Warning negative power near limit”	Approaching limit on the amount of power that can be fed back into the supply by an active load. This is a warning only.	Stop increasing power feedback into the power supply. Typically occurs when using AC inverters. If power increases further, an error 32 will be generated.
32	“Negative power fault”	Too much power fed back. Power source output disconnected.	Reduce the amount of power being fed back into the power source.

Table 12-1: Error Messages

Index

+	
+/- key	62
A	
AC	
input.....	24, 37
Acoustic.....	18, 22
arrow keys.....	60
B	
blinking	
parameter entry	60
C	
calibration	
password	120
calibration factors	92
CE mark.....	18
circuit breaker.....	58
clock mode.....	70
constant current	113
Constant Power.....	22
Construction	
internal.....	17
controller assembly	110
Controllers	
programable.....	19
Cooling.....	17
current / voltage sensor.....	113
current limit.....	109
D	
DC offset	70
-HV range.....	145
Dimensions	17
Distorted output	132
DVM	113
E	
Efficiency.....	12
Emissions.....	18
error messages	146
-ES	19
Ethernet	85
F	
Finish	
paint.....	17
firmware	
downloads	137
Frequency Range	14
front panel.....	58
Front panel	
Lock.....	59
Function Strobe.....	16
Functional Test	55
Fuse check.....	133
Fuses	
Input.....	109
G	
GPIB.....	85
H	
Hold-Up Time	12
-HV	
restrictions	145
I	
IEEE-488	16, 85
Immunity.....	18
Inrush Current.....	12
installation.....	24, 37
Introduction	11
Isolation Voltage.....	12
K	
keypad	61
function	61
Keys	
ES Option	19, 145
knob.....	60
L	
LAN	16, 85
Configuration	83
connector	53
MAC Address	53
Settings.....	83
-LAN option	19
LCD display	64
LED.....	113, 131
LED indicators.....	131
-LF	19
Line Current:	12
Line Frequency	12
Line VA:	12
list transient	104
Low Voltage PS	113
M	
MAC Address.....	53
maintenance.....	131
Material	
chassis	17

MEAS key	61	wiring	30, 42
measurement calibration	91	SET key	62
MENU key	61	SET mode	60
Modulator	109	Shock	18
N		Short Circuit	
Noise	13	current	17
O		shutdown	54
Offset Voltage		shuttle	60
DC	13	SET mode	60
oscillator	109	Shuttle	
output		IMMEDIATE mode	60
frequency	69	slew rates	106
voltage	69	status	59
output calibration	92	step transient	102
Output Coupling	13, 20	system interconnect	108
output mode	70	System Interface	113
OUTPUT ON/OFF key	62	T	
Output Status	16	temperature	
over current	113	over	59
Overcurrent	17	Temperature	
overload	59	operating, storage	18
Overtemperature	17	Three phase	109
Overvoltage	17	top cover	
P		removal	133
Parallel	19	transient	
password		execution	107
calibration	120	transient execution	80
phase angle	70	transients	
PHASE key	62	list	104
Power Factor	12	pulse	103
power-down	54	slew rate	106
PROG key	61	step	102
Programming manual	11	Transients	
pulse transient	103	Input	17
R		Trigger	
registers	80	input BNC	16
Relay		output BNC	16
output	19	troubleshooting	131
Remote control	59	Turn on	54
Remote Inhibit	56	U	
repeat	80	UP key	63
replacement parts	140, 143	USB	16, 85
RJ45		connector	52
connector	53	V	
RS232	85	Vibration	18
RS232 connector	51	viewing angle	19, 84
RS232C	16	volt mode	70
S		voltage drop	
Safety	18	cables	28, 31, 40, 43
sense	131	voltage rating	23, 35
		W	
		WAVE key	61

waveform group..... 88
Weight..... 17
Wire Sizes..... 28, 31, 40, 43
wiring
 input..... 24, 37

X
-XV range
 restrictions 145