



Revision J
November 2017
Copyright © 2006-2017
AMETEK Programmable Power Division
All rights reserved.
P/N 6005-962

2253i / 2253iX
AC and DC Power Source
User Manual

AMETEK[®]
PROGRAMMABLE POWER

TEL: +1 (858) 450-0085

FAX: +1 (858) 458-0267

Email: sales@programmablepower.com

Web Site: <http://www.programmablepower.com>

Refers to:

Models:

2253i AC and DC Power Source

2253iX AC and DC Power Source/Analyzer

About AMETEK

AMETEK Programmable Power, Inc., a Division of AMETEK, Inc., is a global leader in the design and manufacture of precision, programmable power supplies for R&D, test and measurement, process control, power bus simulation and power conditioning applications across diverse industrial segments. From bench top supplies to rack-mounted industrial power subsystems, AMETEK Programmable Power is the proud manufacturer of Elgar, Sorensen, California Instruments and Power Ten brand power supplies.

AMETEK, Inc. is a leading global manufacturer of electronic instruments and electromechanical devices with annualized sales of \$2.5 billion. The Company has over 11,000 colleagues working at more than 80 manufacturing facilities and more than 80 sales and service centers in the United States and around the world.

Trademarks

AMETEK is a registered trademark of AMETEK, Inc. California Instruments is a trademark owned by AMETEK, Inc. Other trademarks, registered trademarks, and product names are the property of their respective owners and are used herein for identification purposes only.

Notice of Copyright

2253i/iX Series User Manual © 2006-2014 AMETEK Programmable Power, Inc. All rights reserved.

Exclusion for Documentation

UNLESS SPECIFICALLY AGREED TO IN WRITING, AMETEK PROGRAMMABLE POWER, INC.

("AMETEK"):

- (a) MAKES NO WARRANTY AS TO THE ACCURACY, SUFFICIENCY OR SUITABILITY OF ANY TECHNICAL OR OTHER INFORMATION PROVIDED IN ITS MANUALS OR OTHER DOCUMENTATION.
- (b) ASSUMES NO RESPONSIBILITY OR LIABILITY FOR LOSSES, DAMAGES, COSTS OR EXPENSES, WHETHER SPECIAL, DIRECT, INDIRECT, CONSEQUENTIAL OR INCIDENTAL, WHICH MIGHT ARISE OUT OF THE USE OF SUCH INFORMATION. THE USE OF ANY SUCH INFORMATION WILL BE ENTIRELY AT THE USER'S RISK, AND
- (c) REMINDS YOU THAT IF THIS MANUAL IS IN ANY LANGUAGE OTHER THAN ENGLISH, ALTHOUGH STEPS HAVE BEEN TAKEN TO MAINTAIN THE ACCURACY OF THE TRANSLATION, THE ACCURACY CANNOT BE GUARANTEED. APPROVED AMETEK CONTENT IS CONTAINED WITH THE ENGLISH LANGUAGE VERSION, WHICH IS POSTED AT WWW.PROGRAMMABLEPOWER.COM.

Date and Revision

November 2017, Revision J

Part Number



6005-962

Contact Information

Telephone: 800 733 5427 (toll free in North America)
858 450 0085 (direct)
Fax: 858 458 0267
Email: sales@programmablepower.com
service@programmablepower.com
Web: www.programmablepower.com

Important Safety Instructions

Before applying power to the system, verify that your product is configured properly for your particular application.

 WARNING	Hazardous voltages may be present when covers are removed. Qualified personnel must use extreme caution when servicing this equipment. Circuit boards, test points, and output voltages also may be floating above (below) chassis ground.
 WARNING	The equipment used contains ESD sensitive parts. When installing equipment, follow ESD Safety Procedures. Electrostatic discharges might cause damage to the equipment.

Only *qualified personnel* who deal with attendant hazards in power supplies, are allowed to perform installation and servicing.

Ensure that the AC power line ground is connected properly to the Power Rack input connector or chassis. Similarly, other power ground lines including those to application and maintenance equipment *must* be grounded properly for both personnel and equipment safety.

Always ensure that facility AC input power is de-energized prior to connecting or disconnecting any cable.

In normal operation, the operator does not have access to hazardous voltages within the chassis. However, depending on the user's application configuration, **HIGH VOLTAGES HAZARDOUS TO HUMAN SAFETY** may be normally generated on the output terminals. The customer/user must ensure that the output power lines are labeled properly as to the safety hazards and that any inadvertent contact with hazardous voltages is eliminated.

Guard against risks of electrical shock during open cover checks by not touching any portion of the electrical circuits. Even when power is off, capacitors may retain an electrical charge. Use safety glasses during open cover checks to avoid personal injury by any sudden component failure.

Neither AMETEK Programmable Power Inc., San Diego, California, USA, nor any of the subsidiary sales organizations can accept any responsibility for personnel, material or inconsequential injury, loss or damage that results from improper use of the equipment and accessories.

SAFETY SYMBOLS

WARNING
Risk of Electrical Shock



CAUTION
Refer to Accompanying Documents



Off (Supply)



Direct Current (DC)



Standby (Supply)



Alternating Current (AC)



On (Supply)



Three-Phase Alternating Current



Protective Conductor Terminal



Earth (Ground) Terminal



Fuse



Chassis Ground

WARRANTY TERMS

AMETEK Programmable Power, Inc. (“AMETEK”), provides this written warranty covering the Product stated above, and if the Buyer discovers and notifies AMETEK in writing of any defect in material or workmanship within the applicable warranty period stated above, then AMETEK may, at its option: repair or replace the Product; or issue a credit note for the defective Product; or provide the Buyer with replacement parts for the Product.

The Buyer will, at its expense, return the defective Product or parts thereof to AMETEK in accordance with the return procedure specified below. AMETEK will, at its expense, deliver the repaired or replaced Product or parts to the Buyer. Any warranty of AMETEK will not apply if the Buyer is in default under the Purchase Order Agreement or where the Product or any part thereof:

- is damaged by misuse, accident, negligence or failure to maintain the same as specified or required by AMETEK;
- is damaged by modifications, alterations or attachments thereto which are not authorized by AMETEK;
- is installed or operated contrary to the instructions of AMETEK;
- is opened, modified or disassembled in any way without AMETEK’s consent; or
- is used in combination with items, articles or materials not authorized by AMETEK.

The Buyer may not assert any claim that the Products are not in conformity with any warranty until the Buyer has made all payments to AMETEK provided for in the Purchase Order Agreement.

PRODUCT RETURN PROCEDURE

Request a Return Material Authorization (RMA) number from the repair facility (**must be done in the country in which it was purchased**):

- **In the USA**, contact the AMETEK Repair Department prior to the return of the product to AMETEK for repair:
Telephone: 800-733-5427, ext. 2295 or ext. 2463 (toll free North America)
858-450-0085, ext. 2295 or ext. 2463 (direct)
- **Outside the United States**, contact the nearest Authorized Service Center (ASC). A full listing can be found either through your local distributor or our website, www.programmablepower.com, by clicking Support and going to the Service Centers tab.

When requesting an RMA, have the following information ready:

- Model number
- Serial number
- Description of the problem

NOTE: Unauthorized returns will not be accepted and will be returned at the shipper’s expense.

NOTE: A returned product found upon inspection by AMETEK, to be in specification is subject to an evaluation fee and applicable freight charges.

Table of Contents

1.	Introduction	11
1.1	General Description	11
1.2	iX and i Model Differences	12
1.3	Manual organization and format.....	12
2.	Specifications	13
2.1	Electrical	13
2.2	Mechanical	23
2.3	Environmental	24
2.4	Regulatory.....	24
2.5	Front Panel Controls, Indicators and Display.....	25
2.6	Special Features	26
2.7	Available Options – i Series	27
2.8	Available Options – iX Series.....	28
2.9	EXT Option - Supplemental Specifications	29
2.10	LKM / LKS Options - Supplemental Specifications	31
2.11	RPF Option - Supplemental Specifications	31
2.12	WHM Option - Supplemental Specification.....	31
2.13	Supplemental Specifications.....	32
3.	Unpacking and Installation.....	34
3.1	Unpacking	34
3.2	AC Input Power Requirements.....	34
3.3	Mechanical Installation.....	34
3.4	Rear Panel Connectors.....	36
3.5	AC Input Wiring - INPUT	37
3.6	Output Connections	38
3.7	Connectors - Rear Panel.....	40
3.8	Basic Initial Functional Test	46
3.9	Clock and Lock Mode (-LKM/-LKS Option)	48
3.10	Remote Control Interfaces	49
4.	Front Panel Operation	50
4.1	Tour of the Front Panel	50
4.2	Menu Structure.....	55
4.3	Output Programming.....	79
4.4	Waveform Management.....	81
4.5	Measurements	84
4.6	Harmonic Analysis	85
4.7	Transient Programming.....	85
4.8	Setting the Power-on Initialization Values	90
4.9	Remote Inhibit Function	91
5.	Principle of Operation	92
5.1	Overall Description.....	92
5.2	Amplifier Assemblies.....	92
5.3	PFC and Rectifier Assembly	92
5.4	EMI Filter Assembly	92
5.5	Auxiliary DC bias Supply	92
5.6	Range/Relay Assembly.....	93
5.7	Interface Assembly	93
5.8	Front Panel Assembly.....	93

6.	Calibration.....	95
6.1	Recommended Calibration Equipment	95
6.2	Calibration Screens.....	95
6.3	Measurement Calibration.....	95
6.4	Non-Routine Output Calibration	97
6.5	Non-Routine Output Offset and Gain Calibration.....	98
7.	Service.....	100
7.1	Cleaning.....	100
7.2	General	100
7.3	Basic operation	100
7.4	Self test.....	102
7.5	Advanced Troubleshooting.....	102
7.6	Amplifier Module Data.....	103
7.7	Factory Assistance.....	105
7.8	Fuses	105
7.9	Replaceable Parts.....	106
8.	Miscellaneous Options	108
8.1	IEEE488 Interface (-GPIB).....	108
8.2	Atlas Based Language Extensions (-ABL)	108
8.3	External Sync (-EXS)	108
8.4	External Input (-EXT).....	109
8.5	RPV Input (-RPV).....	110
8.6	Ethernet Interface (-LAN).....	110
8.7	Clock and Lock (-LKM / -LKS).....	110
8.8	Rack Mount Slides (-RMS).....	111
9.	Option -160: RTCA / DO-160 Rev D, E.....	112
9.1	General	112
9.2	Initial Setup	112
9.3	Available DO160 Tests	113
9.4	Front Panel Operation -160.....	114
9.5	AC Test Mode	115
9.6	DC Test Mode	128
10.	Option -704: MIL-STD 704 Rev D & E (MIL704 Mode)	132
10.1	General	132
10.2	Initial Setup	132
10.3	Test Revision	132
10.4	Available MIL-STD 704 Tests.....	133
10.5	Front Panel Operation MIL704.....	134
10.6	AC Test Mode	135
10.7	DC Test Mode	142
11.	Option –ABD: Airbus ABD0100.1.8 Test	146
12.	Option –A350: Airbus ABD0100.1.8.1 Test	147
13.	Option –AMD: Airbus AMD24 Test.....	148
14.	Option –B787: Boeing B787-0147 Test.....	149
15.	Option –WHM: Watt Hour Meter measurements.....	150
16.	Error Messages.....	151
17.	Index.....	156

List of Figures

Figure 1-1: Model 2253iX AC Source	11
Figure 2-1: 2253i / iX Voltage / Current Rating Chart for 150V AC Range per phase – 230Vac in	17
Figure 2-2: 2253i / iX Voltage / Current Rating Chart for 300V AC Range per phase – 230Vac in	17
Figure 2-3: 2253i / iX Voltage / Current Rating Chart for 150V AC Range per phase – 115Vac in	18
Figure 2-4: 2253i / iX Voltage / Current Rating Chart for 300V AC Range per phase – 115Vac in	18
Figure 2-5: 2253i / iX Voltage / Current Rating Chart for 200V DC Range per phase	19
Figure 2-6: 2253i / iX Voltage / Current Rating Chart for 400V DC Range per phase	19
Figure 2-7: EXT Option Frequency response 300VAC Range	30
Figure 2-8: Typical frequency response, low Vrange, ALC off.....	32
Figure 3-1: Rack Mount Slides (-RMS option) position	35
Figure 3-2: Rear Panel Connector Locations – i Models	36
Figure 3-3: Rear Panel Connector Locations – iX Models (Shown with –LAN option).....	36
Figure 3-4: USB Connector pin orientation	43
Figure 3-5: Functional Test Setup.....	47
Figure 3-6: Clock and Lock Connections	48
Figure 4-1: Front Panel controls and indicators	50
Figure 4-2: Shuttle Knob	52
Figure 4-3: Menu Keys.....	53
Figure 4-4: Measurement Screen	54
Figure 4-5: PROGRAM Menu	60
Figure 4-6: CONTROL Menus	62
Figure 4-7: MEASUREMENT Screen.....	65
Figure 4-8: Selecting a Waveform	81
Figure 4-9: Waveform Crest Factor Affects Max. rms Voltage	82
Figure 4-10: Pulse Transients.....	86
Figure 4-11: List Transients	86
Figure 4-12: Sample Transient Output Sequence	87
Figure 4-13: Switching Waveforms in a Transient List.....	88
Figure 4-14: TRANSIENT Menu.....	88
Figure 6-1: Internal adjustment locations.....	99
Figure 8-1: Rack Mount Slides (-RMS option) position	111
Figure 9-1: Application Menu	114
Figure 9-2: DO160 Main Menus.....	114
Figure 9-3: Normal state screens.....	115
Figure 9-4: Voltage Modulation - Frequency characteristics.....	118
Figure 9-5: Frequency Modulation	119
Figure 9-6: Power Interrupt	120
Figure 9-7: Power Interrupt for Group2/A (NF) and Group3/A(WF).....	121
Figure 9-8: Emergency Screens	123
Figure 9-9: Abnormal Screen.....	125
Figure 9-10: Normal State screens	128
Figure 9-11: Abnormal State screens	130
Figure 10-1: Applications Menu	134
Figure 10-2: MIL704 Menu.....	134
Figure 10-3: Steady State Menu	135
Figure 10-4: Emergency Menu.....	139
Figure 10-5: Abnormal Screens	140
Figure 10-6: Emergency Test	145

List of Tables

Table 3-1: Output Terminal connections.....	39
Table 3-2: Rear Panel Connectors	40
Table 3-3: AC Line Input Terminal block.....	41
Table 3-4: Output Terminal connections.....	41
Table 3-5: External Sense connector.....	41
Table 3-6: DB15 Auxiliary I/O Connector	42
Table 3-7: BNC Connectors.....	42
Table 3-8: USB Connector pin out.....	43
Table 3-9: RS232 Connector pin out.....	43
Table 3-10: GPIB Interface Connector pin out.....	44
Table 3-11: RJ45 LAN Connector pin out.....	45
Table 3-12: Load Resistance.....	47
Table 4-1: Menu Tree.....	59
Table 4-2: Sample Transient List.....	88
Table 4-3: Factory Default Power on Settings	90
Table 4-4: Remote Inhibit Modes.....	91
Table 6-1: Calibration Load Values.....	96
Table 6-2: Output Calibration Coefficients - Factory Defaults.....	97
Table 6-3: Adjustment pot reference by phase.....	98
Table 7-1: Replaceable Parts and Assemblies.....	107
Table 9-1: Normal Voltage and Frequency minimum	116
Table 9-2: Normal Voltage and Frequency Maximum.....	116
Table 9-3: Normal Voltage Unbalance.....	117
Table 9-4: Airbus mode voltage modulation.....	117
Table 9-5: Normal Voltage Surge Sequence	121
Table 9-6: Normal Frequency Transient Sequence	122
Table 9-7: Normal Frequency Variation Sequence.....	122
Table 9-8: Emergency Voltage and Frequency Minimum.....	123
Table 9-9: Emergency Voltage and Frequency Maximum.....	123
Table 9-10: Emergency Voltage Unbalance	124
Table 9-11: Abnormal Voltage Minimum.....	125
Table 9-12: Abnormal Voltage Maximum.....	125
Table 9-13: Abnormal Voltage Unbalance.....	126
Table 9-14: Abnormal Frequency Transient.....	127
Table 9-15: Normal Voltage Minimum.....	128
Table 9-16: Normal Voltage Maximum.....	129
Table 9-17: Voltage Surge.....	129
Table 9-18: Abnormal Voltage Surge.....	131
Table 10-1: Steady state voltage	135
Table 10-2: Steady state frequency.....	136
Table 10-3: Frequency Modulation	136
Table 10-4: Abnormal Over Frequency.....	141
Table 10-5: Abnormal Under Frequency.....	141
Table 16-1: Error Messages.....	155

1. Introduction

This instruction manual (P/N 6005-962) contains information on the installation, operation, calibration and maintenance of the model 2253i and model 2253iX AC power sources.



Figure 1-1: Model 2253iX AC Source.

1.1 General Description

The Compact i/iX Series of AC Power Source is a family of high efficiency, rack mountable, AC Power Sources that provide a precisely controlled output voltage with low distortion and measurements. In addition, the unit provides measurements of voltage and current, and the iX models offer extensive power analyzer capabilities with easy to use interface software. Standard output voltage ranges are 150 Vac and 300 Vac RMS. The 2253i/iX models operate in three-phase mode and provide a maximum output power of 750VA per phase. A –MODE option is available which parallels all three outputs in a single-phase mode of operation. A unique constant power mode allows for higher output current at less than full-scale voltage effectively increasing the usability for many applications where otherwise a higher power level AC source may be needed.

Read the installation instructions carefully before attempting to install and operate the Compact i/iX Series power source.

1.2 iX and i Model Differences

The 2253iX offers additional features and functions over the 2253i model. Some of the features available on the 2253iX such as the GPIB interface may be added as an option to the 2253i at the time of order. Other features are exclusive to the 2253iX models.

Both models are based on the same AC power source hardware platform and share many common components. The differences are primarily in configuration and options. This manual covers both models. Some menus and screen shown in this manual may not apply to i model AC sources.

All 2253i/iX models are equipped with a USB and RS232 interface. The 2253iX also includes a GPIB interface. The GPIB interface can be specified as an option on the 2253i models at the time of order. An optional Ethernet interface (-LAN) is available on the 2253iX model only.

1.3 Manual organization and format

All user documentation for California Instruments power sources is provided on CDROM in electronic format. (Adobe Portable Document Format) The required Adobe PDF viewer is supplied on the same CDROM. This manual may be printed for personal use if a hardcopy is desired. To request a hardcopy from AMETEK Programmable Power, contact customer service at support@programmablepower.com. There will be an additional charge for printed manuals.

This manual contains sections on installation, normal use, maintenance and calibration.

Refer to the iX Compact Series Programming manual for information on using the remote control interface and command syntax. The programming manual (P/N 6005-961) is provided on the same CDROM as this user manual.

AMETEK Programmable Power may make updated versions of this manual available from time to time in electronic format through it's website. To obtain an updated manual revision if available, check the the AMETEK Programmable Power Manual download page at programmablepower.com. You need to register as a customer to obtain free access to manual and software downloads.

2. Specifications

Specifications shown are valid over an ambient temperature range of $25 \pm 5^\circ \text{C}$ and apply after a 30 minute warm-up time. Unless otherwise noted, all specifications are per phase for sine wave output into a resistive load. For three phase configurations or mode of operation, all specifications are for Line to Neutral (L-N) and phase angle specifications are valid under balanced load conditions only.

Specifications for 2253i models are identical to those for the 2253iX except where noted.

2.1 Electrical

2.1.1 Input

Parameter	Specification
Line Voltage: (single phase, 2 wire + ground (PE))	115 to 230 VAC \pm 10 %
Line VA:	2940 VA / 2850 W
Line Current at nominal input voltage:	< 20 Arms @ 115V and 1500 VA output (Note: Max. AC input current limited to 20 Arms. Breaker may trip above 1500 VA output power) < 15 Arms @ 230V and 2250 VA output
Line Current at low line input voltage, full power:	< 20 Arms @ 103.5V (Derated output power) < 17 Arms @ 207V (Full output power)
Line Frequency:	47-63 Hz
Efficiency:	77 % (typical @ full load)
Power Factor:	0.98 (typical @ full load)
Inrush Current:	< 160 Apk for less than 2 ms at 230V + 10% AC input < 80 Apk for less than 2 ms at 115V + 10% AC input
Hold-Up Time:	> 10 ms
Isolation Voltage:	1350 VAC input to output 1350 VAC input to chassis

2.1.2 Output

Output Parameter	Specification	
Model	2253i	2253iX
Modes	AC, DC	AC, DC, AC+DC
No of Outputs	3 standard 1 or 3 with –MODE option	
Voltage		
Ranges (L-N):		
AC, AC+DC Mode		
Low Vrange:	0 - 150 Vrms	
High Vrange:	0 - 300 Vrms	
DC Mode		
Low Vrange:	0 - 200 Vdc	
High Vrange:	0 - 400 Vdc	
Programming Resolution:	0.1 V	
Accuracy: (ALC mode ON)	0.1% FS ¹ (from 5V to FS ¹)	
Distortion THD ² :	< 1 % 16 - 1000 Hz (harmonics and noise to 300 kHz)	
Load Regulation: (ALC mode ON)	0.1 % FS ¹ (At external sense connection with ext sense mode programmed.)	
Voltage Sense modes:	Internal External	
External Sense	Up to 3 % of set voltage can be dropped across each load lead.	
Line Regulation:	0.02% for 10% input line change	
DC Offset Voltage: (In AC mode)	< 20.0 mV	
Output Noise: (20 kHz to 1 MHz, full R load)	< 100 mV _{RMS} – 150V / 200V Range < 200 mV _{RMS} – 300V / 400V Range	
Output Coupling	Direct coupled	
Output Impedance (Z) (@ max current)	$Z = Vrange * 0.001 / I_load$	
Current (with 200 – 230 VAC line input)		
Output Mode	3 Phase	1 Phase (-Mode)
AC Mode		
High Voltage range	2.5 Arms @ 300 V 3.25 Arms @ 230 V	7.5 Arms @ 300 V 9.74 Arms @ 230 V
Low Voltage range	5.0 Arms @ 150 V 6.5 Arms @ 115 V	15.0 Arms @ 150 V 19.5 Arms @ 115 V

¹ FS (Full Scale) refers to highest available range, e.g. 300Vac in AC mode, 400Vdc in DC mode.

² The distortion specification applies at 77% voltage range, max current and resistive load conditions.

Output Parameter	Specification	
DC Mode		
High Voltage range	1.25 Adc @ 400 V 1.63 Adc @ 300 V	3.75 Adc @ 400 V 4.88 Adc @ 300 V
Low Voltage range	2.5 Adc @ 200 V 3.25 Adc @ 150 V	7.5 Adc @ 200 V 9.74 Adc @ 150 V
AC+DC Mode		
High Voltage range	1.25 Arms @ 300 V 1.63 Arms @ 230 V	3.75 Arms @ 300 V 4.88 Arms @ 230 V
Low Voltage range	2.5 Arms @ 150 V 3.25 Arms @ 115 V	7.5 Arms @ 150 V 9.74 Arms @ 115 V
Current Limit mode	Programmable, CC or CV mode	
<p>Note: Constant power mode allows higher current at reduced voltage. Maximum current available at 77% of voltage range. See Figure 2-1 through Figure 2-6 for voltage versus current profiles by model and voltage range.</p> <p>Note: Full power output available only when using 208-230 AC nominal input line. For 100-115V AC input operation, maximum output power and current are limited by maximum input current of 20 A.</p>		
Maximum AC Peak Current		
Model	3 Phase	1 Phase (-Mode)
AC mode, High Vrange AC mode, Low Vrange	10 Apk 20 Apk	30 Apk 60 Apk
Crest Factor AC Current		
Maximum CF at full scale voltage rms current	4:1	
Power		
Model	3 Phase	1 Phase (-Mode)
AC Mode (208 – 230V nominal AC input)	750 VA	2250 VA
AC Mode (100-115V nominal AC input)	500 VA	1500 VA
DC Mode	500 W	1500 W
AC+DC Mode	375 VA	1125 VA
Frequency		
Range:	16 Hz - 1000 Hz	
Resolution ¹ :	0.01 Hz [< 81.91 Hz] 0.1 Hz [> 82.0 to 819.1 Hz] 1 Hz [> 819 Hz]	
Accuracy:	± 0.025 % ± 0.15 % for FC option	
Temp. Coefficient	± 5 ppm of value / °C	
Stability:	± 15 ppm of value	

¹ Programming resolution reduced if –LKM/-LKS option is installed. See paragraph 2.9.

Note: *All output specifications apply below the Current / Voltage rating line shown in the V/I rating charts of section 2.1.2.1 through 2.1.2.3. Data is shown for three-phase mode. For -MODE option, multiply current by 3.*

2.1.2.1 Voltage versus Current Rating Charts – AC Mode – 230V AC input

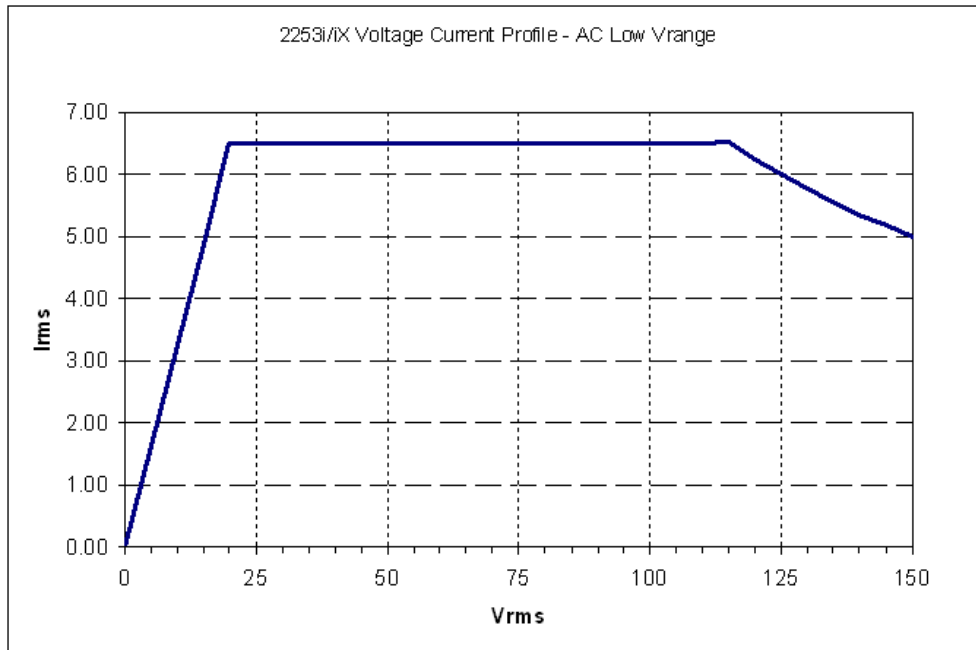

Figure 2-1: 2253i / iX Voltage / Current Rating Chart for 150V AC Range per phase – 230Vac in.

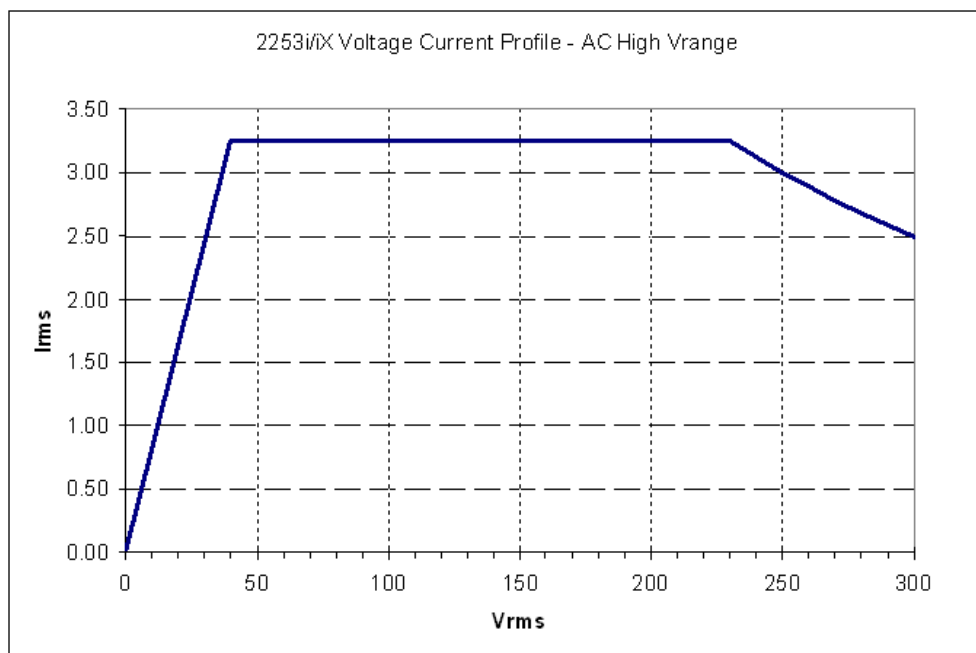

Figure 2-2: 2253i / iX Voltage / Current Rating Chart for 300V AC Range per phase – 230Vac in.

2.1.2.2 Voltage versus Current Rating Charts – AC Mode – 115V AC input

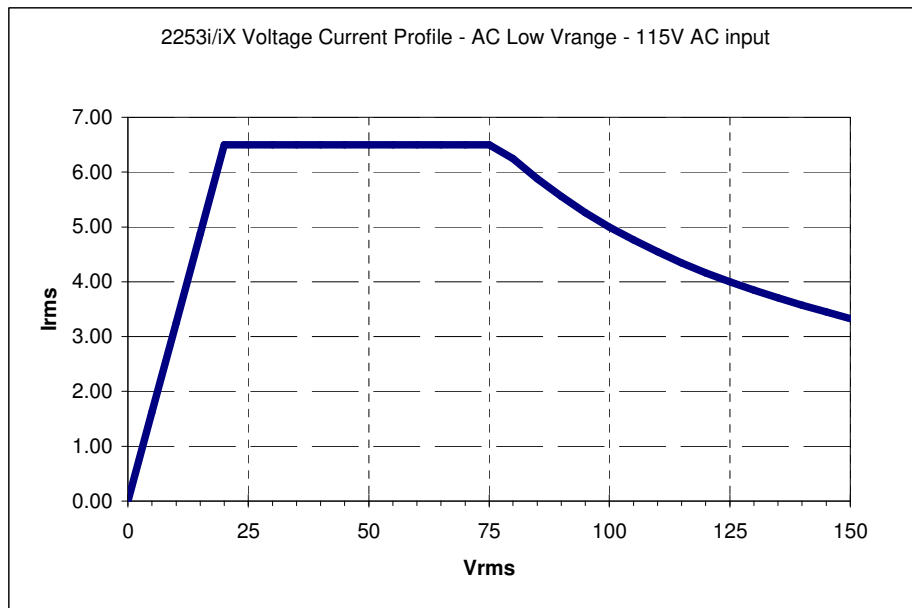

Figure 2-3: 2253i / iX Voltage / Current Rating Chart for 150V AC Range per phase – 115Vac in

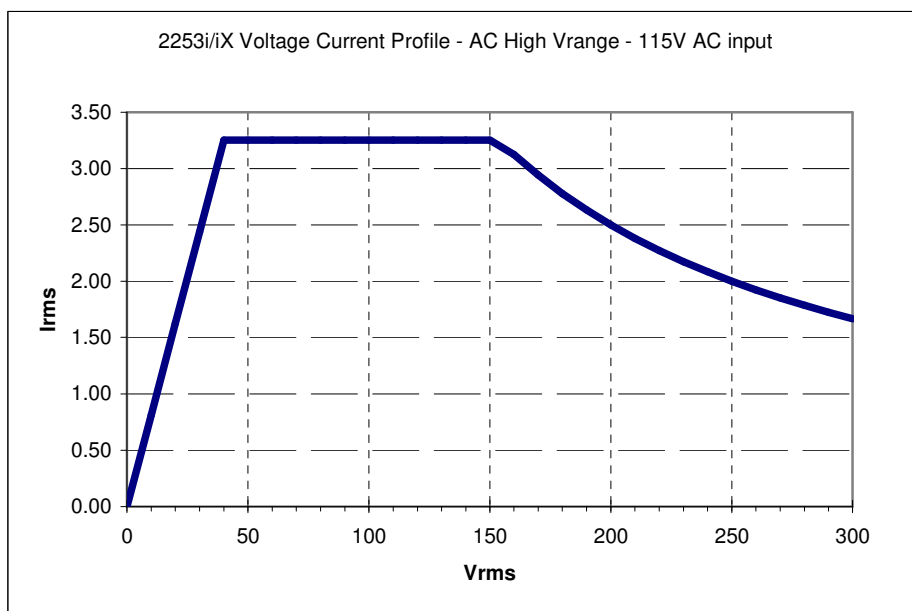

Figure 2-4: 2253i / iX Voltage / Current Rating Chart for 300V AC Range per phase – 115Vac in

2.1.2.3 Voltage versus Current Rating Charts – DC Mode

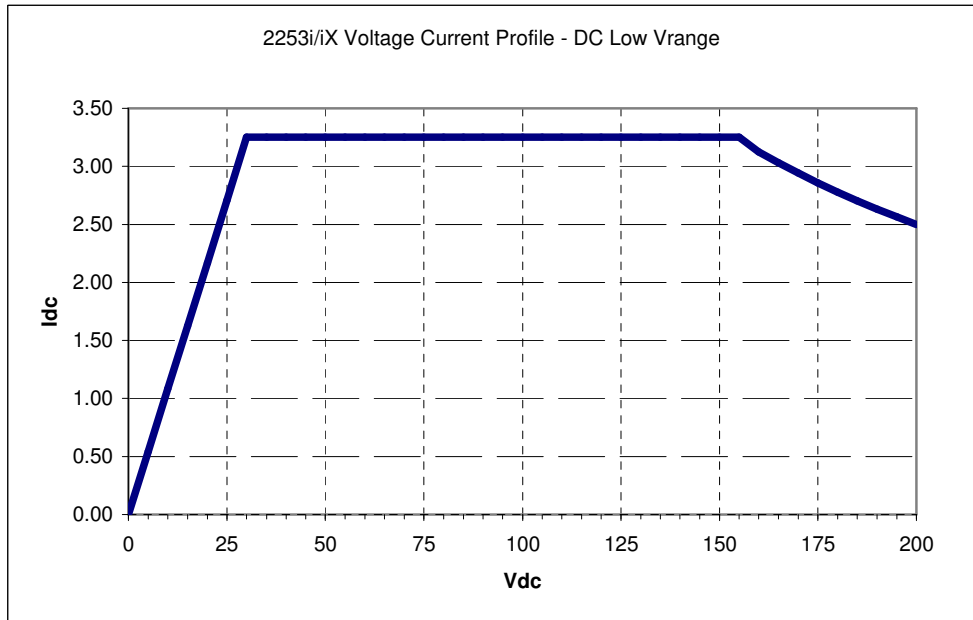

Figure 2-5: 2253i / iX Voltage / Current Rating Chart for 200V DC Range per phase.

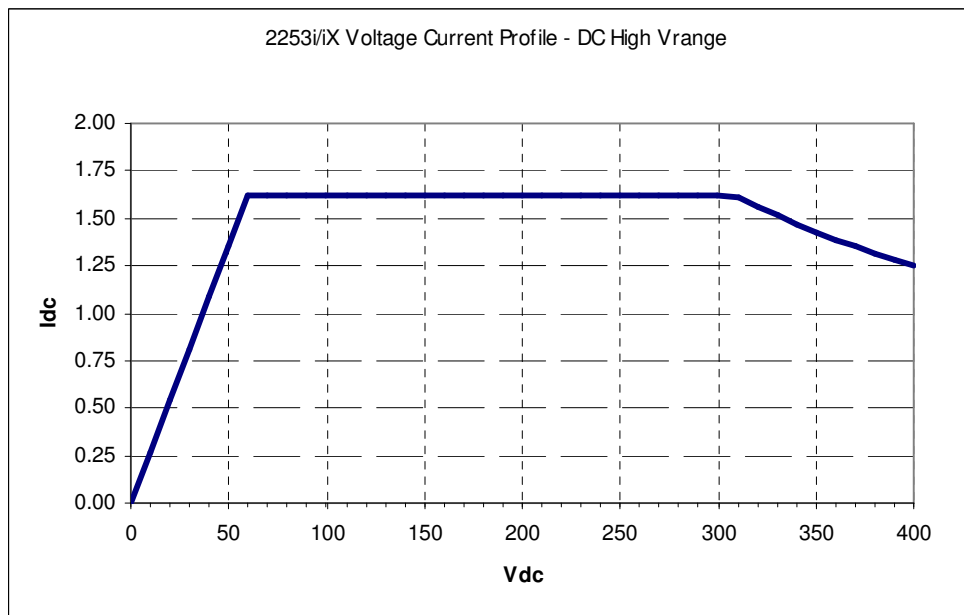

Figure 2-6: 2253i / iX Voltage / Current Rating Chart for 400V DC Range per phase.

2.1.3 Measurements

Measurement specifications apply to single chassis AC sources. See notes for other models and configurations.

Parameter	Range	Accuracy (\pm % FS)	Resolution
Frequency ¹	16.00-1000.0 Hz	0.1 %	0.01 Hz to 81.91 Hz 0.1 Hz to 819.1 Hz 1 Hz > 819.1 Hz
Voltage	0 - 400 Volts	0.1 %	0.01 Volt
Phase angle	0 – 360°	0.5°	0.1°
Current	0 – 15 Amps	0.5 %	0.001 Amp
Peak Current	0 - 60 Amps	0.5 %	0.001 Amp
Crest Factor	1.00 –10.00	1.5 %	0.01
VA Power	0 - 4 KVA	0.5 %	1 VA
Real Power	0 - 4 KW	0.5 %	1 W
Power Factor	0.00 - 1.00	1 %	0.01
<p><i>Note: Accuracy specifications are valid above 100 counts. For multi-chassis configurations, Current and Power range and accuracy specifications are times the number of chassis.</i></p> <p><i>Note: Frequency measurement specification valid for output > 20 Vrms.</i></p> <p><i>Note: Crest Factor accuracy applies for Irms > 50% of max.</i></p> <p><i>Note: Power Factor accuracy applies for PF > 0.5 and VA > 50% of max.</i></p>			

2.1.4 Harmonic Measurements

Harmonic measurement specifications apply to 2253iX model AC sources only.

Parameter	Range	Accuracy (\pm % FS)	Resolution
Frequency fundamental	16.00 - 81.91 Hz 82.0 - 819.1 Hz > 819.1 Hz	0.1%	0.01 Hz 0.1 Hz 1 Hz
Frequency harmonics	16.00 Hz – 48 kHz	0.5%	0.1 Hz
Phase	-180° – 180°	2° + 5°/kHz	0.1°
Voltage			
Fundamental	0 - 400 Volts	0.5%	0.01V
Harmonic 2 - 50		0.5% + 0.5%/kHz	0.01V
Current ²			
Fundamental	0 - 15 Amps	0.5%	0.01A
Harmonic 3 - 50		0.5% + 0.5%/kHz	0.01A
<p><i>Note: For multi-chassis configurations, current accuracy specifications are times the number of chassis.</i></p>			

¹ Frequency measurement specifications valid with output voltage of 20Vrms or higher. If output relay is open, frequency measurement will return 0.0 Hz.

² Second current harmonic measurement value not included.

2.1.5 System Specification

Controller Features	Specification
Trigger Input:	External trigger source input. Requires TTL level input signal. Triggers on negative edge. Response time 80 - 100 μ s.
Function Strobe:	Logic output, active low. Pulse width > 400 μ s. Function strobe is generated on any voltage or frequency program change or output relay open/close. (Mutually exclusive with Trigger Out.)
Trigger Out:	Logic output, active low. Pulse width > 400 μ s. Trigger out is generated based on user programmed transient trigger list. (Mutually exclusive with Function Strobe.)
Non volatile memory storage:	16 complete instrument setups and transient lists, 100 events per list. 50 User defined waveforms.
Waveforms	i Series: Sine. iX Series: Sine, square, clipped, user defined (50 waveforms)
Transients	Voltage: drop, step, sag, surge, sweep Frequency: step, sag, surge, sweep Voltage and Frequency: step, sweep
Current Limit Modes:	Two selectable modes of operation: <ol style="list-style-type: none"> 1. Constant current mode (voltage folds back with automatic recovery) 2. Constant voltage mode with output relay trip-off (Output relay opens).
Control Interfaces	Note: Only one of the serial interfaces (USB, RS232 or LAN) can be active at the same time. (Mutually exclusive).
USB	Standard USB 2.0 peripheral. Data transfer rate: 460,800 bps Syntax: SCPI Note: Use of the USB port to control more than one power source from a single PC is not recommended, as communication may not be reliable. Use GPIB interface for multiple power source control.
RS232	Standard RS232 interface. Data transfer rate: 9600 to 115,200 bps Format: 8 data, 1 start, 1 stop, no parity. Syntax: SCPI
IEEE-488	AH1, DC1, DT1, L3, RL2, SH1, SR1, T6 IEEE 488.2 and SCPI Response time is 10 ms (typical) (Requires -GPIB option on 2253i)
LAN / Ethernet	RJ45 Connector, 10BaseT, 100BaseT or 1000BaseT, Data transfer rate: 460,800 bps Protocol: TCP/IP. (-LAN Option on 2253iX only. RS232 interface is disabled with -LAN option)

2.1.6 Unit Protection

Parameter	Specification
Input Over current:	Input Circuit Breaker. This breaker protects the equipment and is also used to turn the unit on or off.. AC input connection should be made per local electrical code.
Input Over voltage Transients:	Surge protection to withstand EN50082-1 (IEC 801-4, 5) levels.
Output Over current:	Adjustable level constant current mode with programmable set point.
Output Short Circuit:	Peak and RMS current limit.
Over temperature:	Automatic shutdown.

2.2 Mechanical

Parameter	Specification									
Dimensions:	Height: 5.25 inches (13.3 cm) Depth: 23 inches (58.4 cm) Width: 19 inches (48.3 cm) <i>All dimensions are per chassis. For /2 model configurations, multiply height by 2 for total height. Width includes integrated front panel rack mount ears.</i>									
Equipment Rack depth requirement	25 inches (63.5 cm)									
Rack slide mount	The rack mount slide (-RMS option) mounting holes centerlines on the side of the power source are 2.30 inches / 58.4 mm above the bottom edge of the front panel.									
Unit Weight:	Net: 58 lbs / 26 Kg <i>approximately</i> Shipping: 76 lbs / 35 Kg <i>approximately</i>									
Material:	Steel chassis with aluminum top cover									
Finish:	Powder coated external surfaces, color medium gray.									
Cooling:	Fan cooled with air intake on the sides and front, and exhaust to the rear. Variable speed fan control.									
Acoustic Noise (Supplemental specification)	Measured at 1 m distance: <table border="1"> <thead> <tr> <th>Fan speed:</th> <th>Low power mode</th> <th>Full power mode</th> </tr> </thead> <tbody> <tr> <td>Front of unit:</td> <td>41 dBA</td> <td>51 dBA</td> </tr> <tr> <td>Rear of unit:</td> <td>43 dBA</td> <td>56 dBA</td> </tr> </tbody> </table>	Fan speed:	Low power mode	Full power mode	Front of unit:	41 dBA	51 dBA	Rear of unit:	43 dBA	56 dBA
Fan speed:	Low power mode	Full power mode								
Front of unit:	41 dBA	51 dBA								
Rear of unit:	43 dBA	56 dBA								
Internal Construction:	Modular sub assemblies.									
Rear Panel Connections:	(See section 3 for description of connections) <ul style="list-style-type: none"> • AC input screw terminal block. • AC output screw terminal strip. • External sense connector. • USB, RS232, GPIB (option on i), LAN (option on iX) • Auxiliary I/O 									

2.3 Environmental

Parameter	Specification
Operating Temp:	0° to +40° C, full power. +32° to +104° F, full power.
Storage Temp:	-40° to +85 °C. -40° to +185° F.
Altitude:	< 2000 meters < 6000 feet
Relative Humidity:	0-80 % RAH, non-condensing maximum for temperatures up to 31°C decreasing linearly to 50% at 40°C.
Operating Environment	Indoors Use Only. Ground benign.
Vibration:	Designed to meet NSTA project 1A transportation levels.
Shock:	Designed to meet NSTA project 1A transportation levels.

2.4 Regulatory

Electromagnetic Emissions and Immunity:	Designed to meet EN50081-2 and EN50082-2 European Emissions and Immunity standards as required for the "CE" mark.
Safety:	Designed EN61010-1 European safety standards as required for the "CE" mark.

2.5 Front Panel Controls, Indicators and Display

Controls:	
Shuttle knob:	The rotating knob may be used to adjust settings while in the SET menu. In all other menus, the shuttle may be used to change parameter values and settings.
Up/down arrow keys:	A set of up and down arrow keys is used to move the cursor position in all menus. This allows quick selection of the desired function or parameter.
Function keys:	<p>ON/OFF key for output relay control.</p> <p>PHASE This key allows selection of an individual phase or all three phases.</p> <p>SET key will show output voltage and frequency setting.</p> <p>MEAS key displays the measurement screens. Measure key will display measurement values for selected phase or phase A if all three phases are selected.</p> <p>MENU key selects main menu.</p> <p>BACK key is used to back up to previous screen or erase the last digit entered. This key also serves as a "GOTO LOCAL" key when the unit is in remote.</p>
Keypad:	A numeric keypad contains numbers 0 through 9 as well as up and down arrow keys, an Enter key, decimal point and polarity change (+/-) key. The up and down arrow keys are used to move the cursor position in all menus. This allows quick selection of the desired function or parameter.
Indicators and Display:	
Status indicators:	<p>Status indicators inform the user of important power source conditions:</p> <p>The Hi Range indicator is lit any time the unit is switched to the high voltage range.</p> <p>The Overtemp LED illuminates when internal heat sink temperatures are too high.</p> <p>The Overcurrent LED indicates that maximum programmed current limit is being drawn at the output.</p> <p>The Remote/LAN LED informs the user that the unit is under remote control. During LAN operation it indicate that the unit has a valid IP. The LAN LED will turn off if the LAN connection is broken, duplicate IP or DHCP lease expires.</p> <p>The Output indicator is on when the power source output relays are closed.</p> <p>The Phase A, B, C indicators illuminate when either phase A, B, C or all 3 phases are selected using the PHASE button.</p>
LCD character display:	High contrast backlit LCD display. An adjustable viewing angle makes it easy to read from all practical locations.

2.6 Special Features

Controller Features	
Controller:	Programmable controller front panel assembly.
Mode	Available single-phase mode option (-MODE) allows the output of all three amplifiers to be combined on phase A output terminal. No external switching or reconnection to the load is required.
Output Relay:	Standard output relay feature to isolate power source from the load. Each phase and the neutral (common) output is disconnected when the output relay opens.
Output On/Off:	The output relay can be used to quickly disconnect the load. A yellow status indicator displays the status of the output relay.
External Trigger Output or Function Strobe	<p>An external TTL output is available which may be used to trigger other equipment. The TTL output can be controlled by the transient programming system. This requires the trigger mode to be set to EXT (factory default). This can only be done over the computer interface using the OUP:TTL:MODE TRIG command.</p> <p>It can also be configured to generate an output pulse any time the voltage, frequency, current limit or phase programming is updated. This requires the trigger mode to be set to FSTR. This can only be done over the computer interface using the OUP:TTL:MODE FSTR command. This mode is compatible with the CI Lx/Ls Series.</p> <p>The Trigger Output (Trig Out) / Function Strobe is an active low TTL signal with a duration of no less than 400 us.</p>
Clock and Lock Mode	<p>Enables two or more independent iX power systems to be phase synchronized to each other. One system (-LKM) acts as the master, the other(s) (-LKS) as auxiliaries. The -LKS units are synced to the -LKM unit. Refer to section 3.9 for details on Clock and Lock mode.</p> <p>Clock and Lock option is not available with the FC option</p>
Trigger Input	A TTL input signal may be used as a trigger source for output changes programmed on the AC power source transient system. This requires the trigger source to be set to EXT. This can only be done via one of the computer interfaces. An external trigger source may be used to control the execution of output sequences that have been pre-programmed into the power source transient system. Refer to i/iX Series Programming Manual (6005-961) for details.

2.7 Available Options – i Series

Interface Options	
-GPIB	GPIB Remote control interface. This option is not field installable and must be specified at the time of original unit order.
Misc. Options	
-ABL	Atlas Based Language Extension. The ABLE command language provides bus compatibility with 9012 PIP controllers.
-EXT	External Signal Input. This option allows a 0-5Vrms AC signal to be used as the oscillator signal. In this mode, the AC power source acts as an AC amplifier. No programmable current limit is available and the output frequency of 1000 Hz should not be exceeded. Mutually exclusive with –RPF and –RPV options.
-MODE	Mode option allows all three amplifier outputs to be combined on phase A output terminal. No external switching or reconnection to the load is required.
-RMS	Set of 2 Rack mount slides. (Left and Right) Recommended to mount chassis in 19-inch instrument cabinet.
-RPV	Remote programming voltage. DC voltage input 0 to 10 VDC for 0 to full-scale output voltage programming.
-RPF	Remote programming frequency. DC voltage input 0 to 10 VDC or 0 to 5 VDC for 0 to 800 Hz output frequency programming. Input impedance is 20 Kohm (RPF10) or 10 Kohm (RPF5). This option is mutually exclusive with the –LKS option.
-FC	Frequency Control option
-WHM	Watt-hour measurement option.

2.8 Available Options – iX Series

Interface Options	
-LAN	Ethernet LAN interface connection. RJ45 connector. This option is not field installable and must be specified at the time of original unit order. Note: The RS232 interface is disabled if –LAN option is specified.
Test Options	
-160	RTCA/DO-160 Revision D and E, EuroCAE test firmware. Revision E requires use of iXCGui software (included).
-704	Mil-Std 704 Revision D and E test firmware. Revision A, B, C and F requires use of iXCGui software (included).
-704F	Mil-Std 704 Revisions A through F test firmware.
-A350	Airbus A350 / ABD0100.1.8.1 test software. Requires use of iXCGui software (included).
-ABD	Airbus ABD0100.1.8 test software. Requires use of iXCGui software (included).
-AMD	Airbus A400M Directive AMD24 test software. Requires use of iXCGui software (included).
-B787	Boeing B787-0147 test software. Requires use of iXCGui software (included).
Misc. Options	
-ABL	Atlas Based Language Extension. The ABLE command language provides bus compatibility with 9012 PIP controllers.
-EXS	External Sync Input. This option changes the external trigger input to an external sync input. The output frequency will be synced to the square wave TTL level sync signal provided. Not available with FC option
-EXT	External Signal Input. This option allows a 0-5Vrms AC signal to be used as the oscillator signal. In this mode, the AC power source acts as an AC amplifier. No programmable current limit is available and the output frequency of 1000 Hz should not be exceeded. Mutually exclusive with –RPF and –RPV options. Not available with FC option.
-LKM	Clock and Lock Master. Enables synchronizing outputs of two iX AC sources. This mode supports a frequency range of 16 to 819 Hz. The –LKM applies to the master unit. This option is not field installable and must be specified at the time of original unit order. Not available with FC option.
-LKS	Clock and Lock Auxiliary. See -LKM for details. The –LKS applies to the auxiliary unit. (See Notes, see section 3.9.) This option is not field installable and must be specified at the time of original unit order. This option is mutually exclusive with the –RPF option. Not available with FC option.
-MODE	Mode option allows all three amplifier phase outputs to be combined on phase A output terminal. No external switching or reconnection to the load is required.
-RMS	Set of 2 Rack mount slides. (Left and Right) Recommended to mount chassis in 19-inch instrument cabinet.
-RPV	Remote programming voltage. DC voltage input 0 to 10 VDC for 0 to full-scale output voltage programming. Mutually exclusive with –EXT option. Not available with the FC option.

-RPF	Remote programming frequency. DC voltage input 0 to 10 VDC or 0 to 5 VDC for 0 to 800 Hz output frequency programming. Input impedance is 20 KOhm. This option is mutually exclusive with the –LKS and –EXT option. Not available with the FC option.
-FC	Frequency control option
-WHM	Watt-hour measurement option.

2.9 EXT Option - Supplemental Specifications

When the EXT option is installed, the amplifier is used in an open loop mode and none of the regular compact iX Series output specifications apply. This option also precludes the presence of the –RPV and –RPF option.

An external signal input is provided for each phase. The phase A EXT input pins is also used on the Auxiliary I/O connector for the RPVA option so the RPV and EXT options are mutually exclusive. The voltage reference (VOLT REF) on the CONTROL screen of the power source controller must be set to EXT to use this feature. See section 8.4 for EXT option operating instructions.

Parameter	Supplemental Specification
Input:	Isolated inputs, RPVA, EXTB, EXTC to analog common inputs on DB15 Auxiliary I/O (J18)
Level	0 – 5 Vrms / -7.5 Vpk to +7.5 Vpk max. for 0 to 300Vrms. (Gain = 35.6 dB) Voltage range is fixed to 300V AC range.
Impedance	< 4 KOhm
Output:	0 – 300 Vac RMS
Allowable Frequency:	
Range	16 – 1000 Hz
Frequency Response	See Figure 2-7.
Phase	Phase offsets determined by provided external signal inputs A, B, C.

2.9.1 Typical Frequency Response – EXT Option

Typical performance for EXT option models in the 300VAC range operating at 230Vrms. EXT is calibrated at 60 Hz.

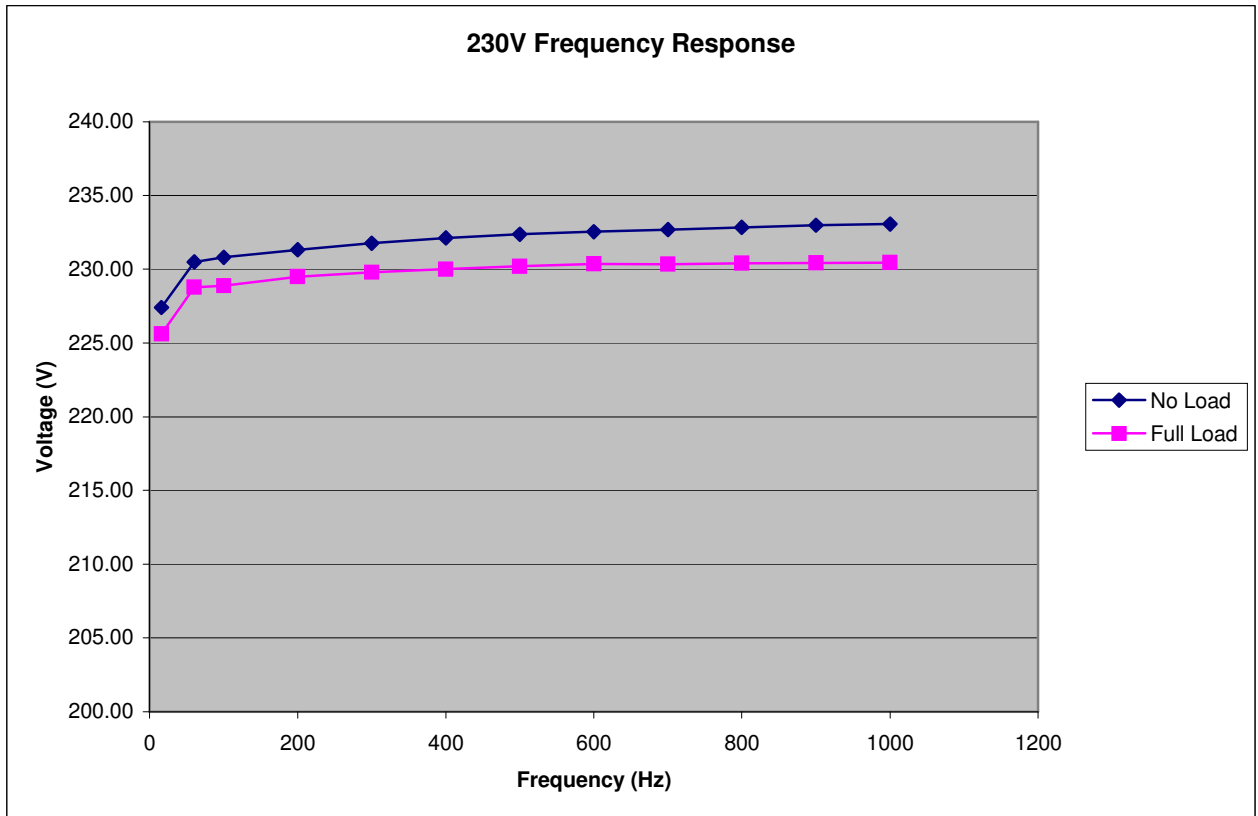

Figure 2-7: EXT Option Frequency response 300VAC Range.

2.10 LKM / LKS Options - Supplemental Specifications

The Clock and Lock option enables two or more independent 2253iX power systems to be phase synchronized to each other. One system (-LKM) acts as the master, the other(s) (-LKS) as auxiliaries. The -LKS units are synced to the -LKM unit. Refer to section 3.9 for details on Clock and Lock mode.

The following supplemental specifications apply when the 2253iX is configured with the Clock and Lock option. (-LKM or -LKS).

Parameter	Supplemental Specification
Voltage:	
Voltage Distortion	Standard specifications apply.
Frequency:	
Range	16 – 819 Hz
Resolution	0.1 Hz
Accuracy	± 0.025%

2.11 RPF Option - Supplemental Specifications

The -RPF option allows an external DC reference to be used to program the output frequency. The following supplemental specifications apply when the 2253i/iX is configured with the remote programming frequency option. (-RPF).

Note that loss of input signal while in RPF mode could result in a DC output from the AC source even though it is in AC mode. If this is potentially damaging to the EUT, care should be taken to always have a minimum input signal level. See section 3.7.4 for RPF input connection.

Parameter	Supplemental Specification
Voltage: Input	0 to 5 Vdc or 0 to 10 Vdc for 0 – 800 Hz output.
Voltage Distortion	Standard specifications apply.
Frequency: -RPF Range	0 – 819 Hz for 0 to 10 Vdc input.
Resolution	0.1 Hz
Accuracy	± 1 %

2.12 WHM Option - Supplemental Specification

The following measurement accuracy specifications apply to the Watt Hour meter mode of operation:

Parameter	Specification
Watt-Hour	
Range:	0 – 999,999.9 WH
Resolution:	0.1 WH
Accuracy:	0.5% R +10 WH
Etime	
Range:	0:00:00 to 9999:59:59
Resolution:	1 sec
Accuracy:	0.025 %

2.13 Supplemental Specifications

Supplemental specifications are provided for reference only and are not guaranteed. Data is based on typical performance of a Compact i/iX series power source but not verified on each unit produced as part of AMETEK Programmable Power acceptance test.

Results on individual units may vary from the data provided here.

2.13.1 Output

Output Parameter	Specification
Frequency response:	See Figure 2-8
Max. Voltage slew:	4V/us, measured step response into resistive load, 10% to 90 % full-scale voltage.
Load Transient response	
No load to full load:	Voltage recovers to within 2% in less than 2 ms
Full load to no load:	Voltage recovers to within 2% in less than 2 ms
Load Regulation response in ALC mode	< 300 ms
Load Regulation: (ALC mode OFF)	< 3 % FS ¹

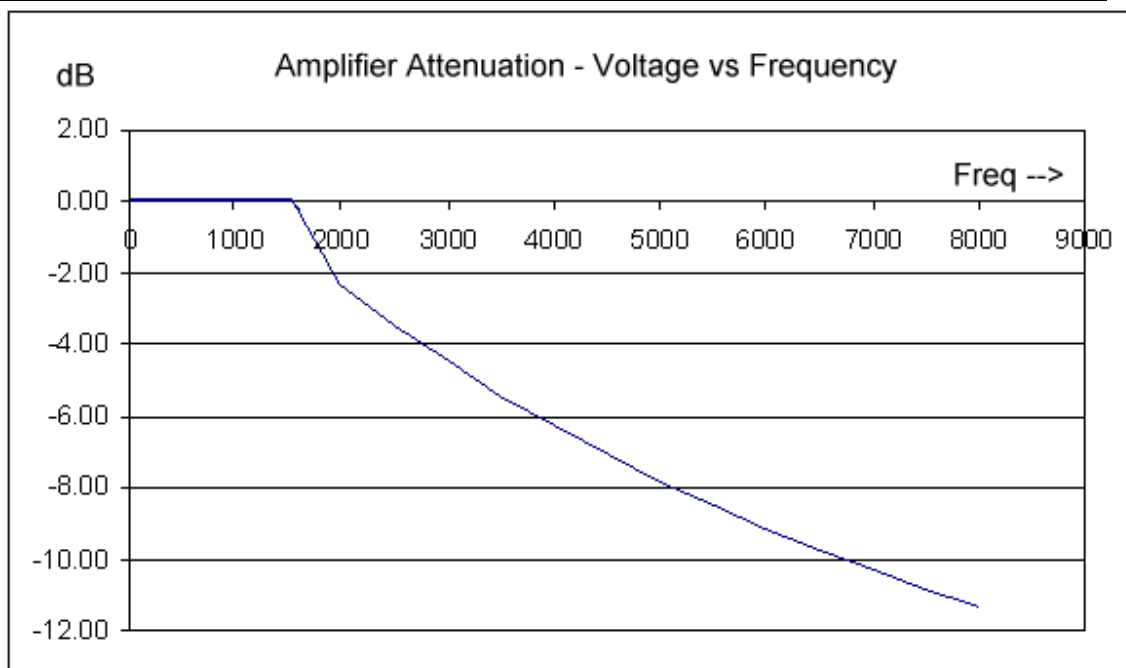

Figure 2-8: Typical frequency response, low Vrange, ALC off.

¹ FS (Full Scale) refers to highest available range, e.g. 300Vac in AC mode, 400Vdc in DC mode.

2.13.2 Remote Programming

Output Parameter	Specification
Bus command response time:	< 20 ms
Ext. Trigger response time	< 50 us

3. Unpacking and Installation

3.1 Unpacking

Inspect the unit for any possible shipping damage immediately upon receipt. If damage is evident, notify the carrier. **DO NOT** return an instrument to the factory without prior approval. Do not destroy the packing container until the unit has been inspected for damage in shipment. If possible, retain the container in the event the system ever has to be returned to the factory for either repair or upgrades.



WARNING: *This power source weighs approximately 60 lbs / 28 Kg. Obtain adequate help when moving or installing the unit. For cabinet mounting, use rack supports to support the weight.*

3.2 AC Input Power Requirements

The i/iX Series power source has been designed to operate from a single-phase, two wire AC input line. A protective earth connection is required as well. (PE). Available AC input voltages are from 115 to 230 V_{LN} nominal.



CAUTION: *Ensure the outlet used to power the 2253i/iX is rated for sufficient current.*

3.3 Mechanical Installation

3.3.1 Table top

The iX/i Series AC power sources can be used free standing on a solid surface or mounted in a 19" instrument cabinet. The units are fan cooled, drawing air in from the side and exhausting at the rear. The back of each unit must be kept clear of obstruction and a 3" clearance must be maintained to the rear. Special consideration of overall airflow characteristics and the resultant internal heat rise must be considered at all times to avoid self heating and over temperature problems.

3.3.2 Rackmount

If the power source is to be mounted in a cabinet system, proper supports such as rack slides, brackets or a shelf must be provided to support the weight of the unit along its depth. The rack ears on the front of the power source are not intended to support the entire weight of the unit and should only be used to prevent the unit from sliding forward.

Contact the cabinet manufacturer for suitable rack support accessories. Extendable rack slides for 24"-28" deep cabinets are available from AMETEK Programmable Power. (-RMS option). The rack mount slide mounting holes centerlines on the side of the power source are 2.30 inches / 58.4 mm above the bottom edge of the front panel.

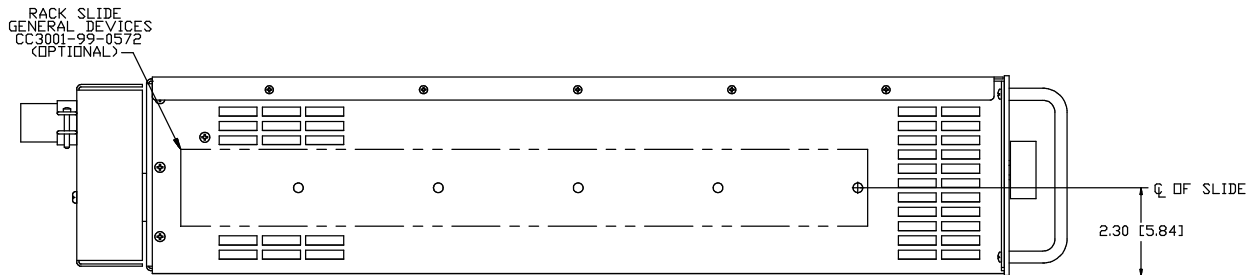

Figure 3-1: Rack Mount Slides (-RMS option) position

3.4 Rear Panel Connectors

All connections to and from the power source are made at the rear panel. For the location of the connectors and types used, refer to Figure 3-2 for i Series models or Figure 3-3 for iX Series models.

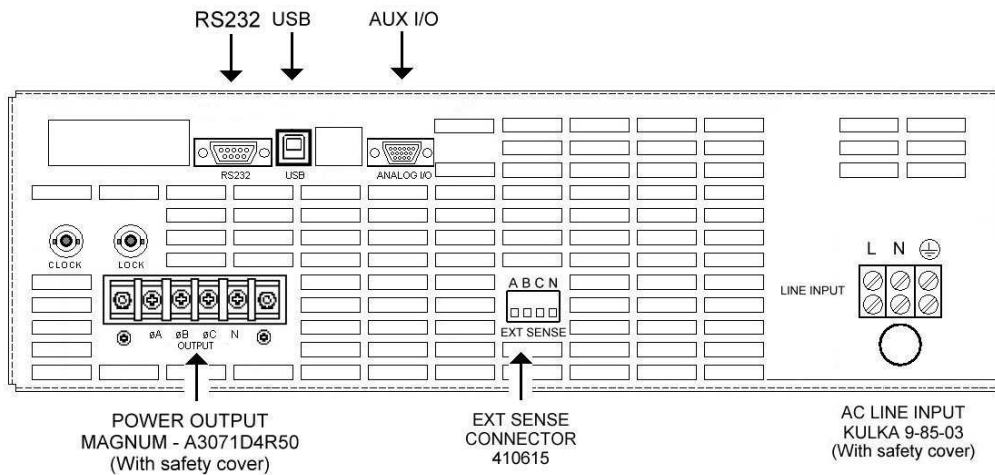

Figure 3-2: Rear Panel Connector Locations – i Models

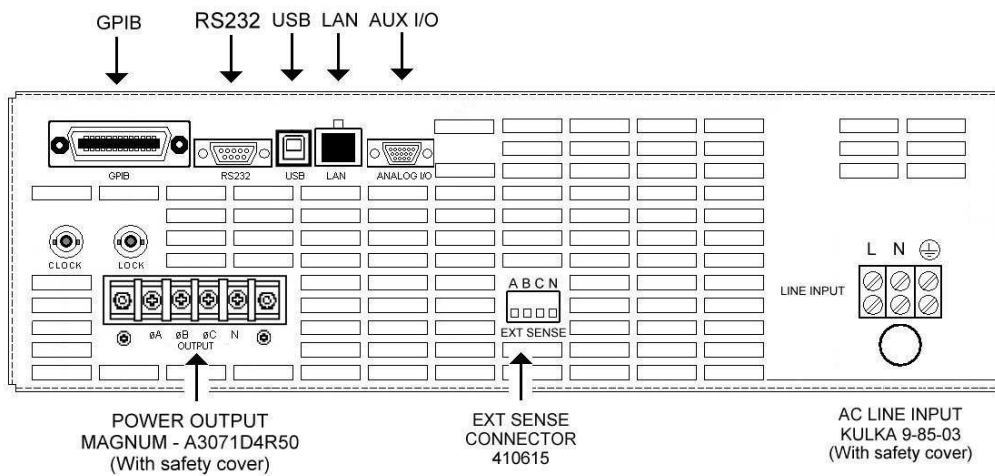

Figure 3-3: Rear Panel Connector Locations – iX Models (Shown with –LAN option)

3.5 AC Input Wiring - INPUT

AC input connections are to be made directly to the input terminal block. The AC input terminal block is located on the right hand side on the back of the chassis (when facing the back of the unit). It is labeled "AC INPUT".

Ground (earth) wire must be connected to the chassis of the AC power system using the ground connection of the AC input terminal block. The mains source must have a current rating equal to or greater than the input fuses and the input wiring must be sized to satisfy the applicable electrical codes.

The AC input compression terminal accommodates a AWG12 to AWG6 wire sizes.

The input power cord must be large enough to handle the input current of the power source and must conform to local electrical codes. Note that all wires must be sized to accommodate the worst-case maximum current that may occur under low line conditions. Local electrical codes may also require different wire types and sizes.

Cable lengths must not exceed twenty-five (25) feet. For lengths greater than 25 feet, calculate the voltage drop from the following formula:

$$2 \times \text{DISTANCE} \times \text{CABLE RESISTANCE PER FT.} \times \text{CURRENT} = \text{VOLT DROP}$$

For cable lengths less than 25 feet, the following wire gauge AC line input cord is recommended:

AC Line Voltage	Wire Gauge	Metric Diameter	Nearest Metric Equivalent
115 - 230 V	AWG12	2.053 mm	4 mm ²

Note: *Always install supplied safety cover on AC input terminal block after connecting input wiring and before applying power.*



CAUTION: *Capacitors in the power source may hold a hazardous electrical charge even if the power source has been disconnected from the mains supply. Allow capacitors to discharge to a safe voltage before touching exposed pins of mains supply connectors. Power modules need at least 5 minutes to discharge to safe levels before they can be removed.*

3.6 Output Connections

3.6.1 Output Wiring

The output terminal block is located at the rear of the unit. Output connections are made to the terminal block labeled OUTPUT. This terminal block has four posts: A, B, C and N (neutral or common).

The external sense input connector is located in the lower center of the rear panel and allows the output voltages to be monitored directly at the load. For external sense mode of operation, these sense connections must be connected at the load using the provided mating connector. The external sense wires should be run as twisted pairs for short lengths. Sense leads over three (3) feet long should be run as a set of twisted shielded pairs.

Note: *The outputs of the power source are isolated from the input line and floating with respect to chassis ground. If needed, the Neutral may be grounded.*

The output power cables must be large enough to prevent a total voltage drop exceeding 3 % of the programmed output voltage between the power source and the load. Note that wires must be sized to accommodate the maximum current that is available. This may be a function of the voltage range. Always use the current available on the low voltage range to size the wires.

For cable lengths less than 25 feet, the following wire gauge is recommended:

Mode	Wire Gauge	Metric Diameter	Nearest Metric Equivalent
3 Phase	AWG14	1.628 mm	2 mm ²
1 Phase	AWG12	2.053 mm	4 mm ²

Cable lengths must not exceed twenty-five (25) feet. For lengths greater than 25 feet, calculate the voltage drop from the following formula:

$$2 \times \text{DISTANCE} \times \text{CABLE RESISTANCE PER FT.} \times \text{CURRENT} = \text{VOLT DROP}$$

3.6.2 Output Terminal Block - OUTPUT

Each chassis has a single AC output terminal strip. The output terminal strip must be covered using the supplied AC Output safety cover. The terminal strip is large enough to accommodate required wire gauge sizes. The terminal strip is located in the lower left corner on the rear panel of the unit. (Looking from the back). Connector type is Magnum, A307104R50.

The AC output terminal strip accommodates a #6 ring or spade lug. The use of sleeved ring lugs (12/10-6 Yellow sleeve lug) or compressed cable lug for the load carrying output wiring is recommended.

Following output terminal lugs and connectors are included in i/iX ship kit:

Use	CI P/N	Description	Qty supplied	For use with:
OUTPUT (TB1)	FS2004	Ring Lug 12/10-6	4	A, B, C, N
SENSE (TB2)	410636	Mating Connector	1	Sense A, B, C, N

Connector TB1	Terminal	Output
	1	Output øA
	2	Output øB
	3	Output øC
	4	Output Neutral (Common)

Table 3-1: Output Terminal connections.

3.7 Connectors - Rear Panel

A number of connectors are located along the top rear panel of the unit. A summary of available connectors is provided in the table below.

Connector	Ref.	Function	Connects To
<i>i / iX Series</i>			
AC Input (INPUT)		Function	Connects To
L – AC in N – AC in G – Chassis Gnd	TB3	Primary AC Power Input	115 VAC to 230 VAC nominal
Output (OUTPUT)		Function	Connects To
1 - Output A 2 - Output B 3 - Output C 4 - Output N	TB1	AC output	User Load
Sense (INPUT)		Function	Connects To
1 - Sense A 2 - Sense B 3 - Sense C 4 - Sense N	TB2	Output Sense	User Load. Required connection for external sense mode.
<i>i Series</i>			
Remote Control		Function	Table
USB	J16	USB Control Interface	
RS232	J14	RS232 Control Interface	
IEEE-488	J17	GPIB Control Interface	See IEEE-488 standard for pin out. Option –GPIB.
<i>iX Series</i>			
Remote Control		Function	Table
USB	J16	USB Control Interface	
RS232	J14	RS232 Control Interface	
IEEE-488	J17	GPIB Control Interface	See IEEE-488 standard for pin out.
LAN	J15	Ethernet Interface	Option -LAN.
<i>i / iX Series</i>			
Other		Function	Table
DB15	J18	Aux I/O	Table 3-6
BNC Connector	J19	Clock	Table 3-7 (-LKM / -LKS option)
BNC Connector	J20	Lock	Table 3-7 (-LKM / -LKS option)

Table 3-2: Rear Panel Connectors

3.7.1 AC Input Connector – INPUT – TB3

See section 3.5 for details on connecting AC input power. Connector type is KULKA 9-85-03 C/I part number is 240321.

Terminal	Designator	Connection Description
1	Line	AC Line
2	Neutral	AC Neutral
3	GND	Chassis Ground

Table 3-3: AC Line Input Terminal block.

3.7.2 Output Terminal Block – OUTPUT – TB1

Each chassis has a single AC output terminal block. The output terminal block must be covered using the supplied AC Output safety cover. The terminal blocks are large enough to accommodate required wire gauge sizes. The terminal block is located in the upper left corner on the rear panel of the unit. (Looking from the back). Connector type is Magnum, A307104R50. C/I part number is 250809. The use of spade or ring lugs is recommended.

Terminal	Designator	Connection Description
1	∅A Output	Output Load High Phase A
2	∅B Output	Output Load High Phase B
3	∅C Output	Output Load High Phase C
4	N Output	Output Load Low Neutral

Table 3-4: Output Terminal connections.

3.7.3 External Sense Connector– INPUT – TB2

If external sense mode is used, sense connections should be made to the four-pin sense connector. A mating connector (ALTECH 37.004/BLK, C/I part number 410636) is provided as part of the shipkit. The external sense connector is located near the center of the rear panel of the unit. Connector type is ALTECH, 37-104/BLK. C/I part number is 410615.

Pin	Designator	Connection Description
1	∅A Sense	Phase A sense input.
2	∅B Sense	Phase B sense input.
3	∅C Sense	Phase C sense input.
4	N Sense	Neutral sense input.

Table 3-5: External Sense connector

3.7.4 Auxiliary I/O Connector – J18

A high density D style, 15-pin I/O connector is located on the rear panel. Table 3-6 shows connections by pin number.

Pin	Signal	Description
1	ACOM	Analog Common
2	RPVA	Remote Programming Voltage all phases (Option -RPV) or Ext Input phase A (Option -EXT) – Use ACOM as return signal
3	RPF	Remote Programming Frequency (Option -RPF) – Use ACOM as return signal
4	/INH	Remote Inhibit. (TTL input) – Use DCOM as return signal
5	TRIG IN	Trigger Input (TTL input) If external sync option (-EXS) is installed, this input is reassigned as Ext Sync. – Use DCOM as return signal
6	FSTB	Function Strobe or Trigger Output (TTL output)
7	DFI	Discrete Fault Indicator output. Isolated Open Collector. Can be used to signal external devices when a fault condition is detected. – Use DCOM as return signal
8	DCOM	Digital Common
9	EXTB	External input for phase B (Option -EXT). – Use ACOM as return signal
10	EXTC	External input for phase C (Option -EXT). – Use ACOM as return signal
11-15	Reserved	Do not use.

Table 3-6: DB15 Auxiliary I/O Connector

3.7.5 BNC Connectors (-LKM / -LKS options) – J19/J20

BNC connectors. Functions are called out on rear panel decal. Table 3-7 shows connections for the optional -LKM and -LKS clock and lock mode. This option is available on iX models. Refer to section 3.9 for more details.

BNC	Ref.	Description
CLOCK	J19	Clock Option (TTL output on Master / TTL input on Auxiliary)
LOCK	J20	Lock Option (TTL output on Master / TTL input on Auxiliary)

Table 3-7: BNC Connectors

3.7.6 USB Interface – J16

A standard USB Series B device connector is located on the rear panel for remote control. A standard USB cable between the AC Source and a PC or USB Hub may be used.

Note: *Use of the USB port to control more than one power source from a single PC is not recommended, as communication may not be reliable. Use GPIB interface for multiple power source control.*



Figure 3-4: USB Connector pin orientation.

Pin	Name	Description
1	VBUS	+5 VDC
2	D-	Data -
3	D+	Data +
4	GND	Ground

Table 3-8: USB Connector pin out.

3.7.7 RS232 Interface – J14

A standard RS232 serial interface connector is located on the rear panel on all 2253 models.

Pin	Name	Description
1	Not used	
2	TxD	Output
3	RxD	Input
4	Not used	
5	Common	
6	Not used	
7	CTS	Input
8	RTS	Output
9	Not used	

Table 3-9: RS232 Connector pin out.

3.7.8 GPIB Interface – J17

A standard IEEE488/ANSI MC1.1; 24 pin GPIB connector is located on the rear panel on all 2253iX models. Maximum cable length is 20 meters, or 2 meters per device - whichever is less. Maximum number of devices is 15. Devices may be connected in either a Star or Linear fashion. Jack screws with *Metric threads* are black.

Note: *On 2253i models, the GPIB interface is optional. If not installed, this connector is not present.*

Pin #	Signal Names	Signal Description	Pin #	Signal Names	Signal Description
1	DIO1	Data Input/Output Bit 1	13	DIO5	Data Input/Output Bit 5
2	DIO2	Data Input/Output Bit 2	14	DIO6	Data Input/Output Bit 6
3	DIO3	Data Input/Output Bit 3	15	DIO7	Data Input/Output Bit 7
4	DIO4	Data Input/Output Bit 4	16	DIO8	Data Input/Output Bit 8
5	EOI	End-Or-Identify	17	REN	Remote Enable
6	DAV	Data Valid	18	Shield	Ground (DAV)
7	NRFD	Not Ready For Data	19	Shield	Ground (NRFD)
8	NDAC	Not Data Accepted	20	Shield	Ground (NDAC)
9	IFC	Interface Clear	21	Shield	Ground (IFC)
10	SRQ	Service Request	22	Shield	Ground (SRQ)
11	ATN	Attention	23	Shield	Ground (ATN)
12	Shield	Chassis Ground	24	Single GND	Signal Ground.

Table 3-10: GPIB Interface Connector pin out.

3.7.9 LAN Interface – RJ45 – J15

An optional RJ45 Ethernet 10BaseT connector is located on the rear panel for remote control. A standard RJ45 UTP patch cord between the AC Source and a network Hub may be used to connect the AC source to a LAN. For direct connection to a PC LAN card, a crossover RJ45 cable is required. Consult your network administrator for directions on connecting the AC source to any corporate LAN.

If the –LAN Ethernet interface option is present, the MAC Address (Media Access Control) of the Ethernet port is printed on the serial tag of the power source. The serial tag is located on the rear panel of the unit.

For information on how to set up a network connection or a direct PC connection using the LAN interface, refer to the *i/iX Compact Series Programming Manual* P/N 6005-961 distributed in Adobe PDF format on CD ROM CIC496.

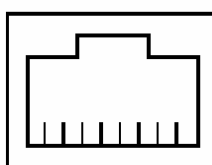

8 7 6 5 4 3 2 1

LAN

Pin	Ethernet TPE 10BaseT/100BaseT/1000BaseT	EIA/TIA 568A	EIA/TIA 568B Crossover
1	Transmit/Receive Data 0 +	White with green stripe	White with orange stripe
2	Transmit/Receive Data 0 -	Green with white stripe or solid green	Orange with white stripe or solid orange
3	Transmit/Receive Data 1 +	White with orange stripe	White with green stripe
4	Transmit/Receive Data 2 +	Blue with white stripe or solid blue	Blue with white stripe or solid blue
5	Transmit/Receive Data 2 -	White with blue stripe	White with blue stripe
6	Transmit/Receive Data 1 -	Orange with white stripe or solid orange	Green with white stripe or solid
7	Transmit/Receive Data 3 +	White with brown stripe or solid brown	White with brown stripe or solid brown
8	Transmit/Receive Data 3 -	Brown with white stripe or solid brown.	Brown with white stripe or solid brown

Table 3-11: RJ45 LAN Connector pin out.

3.8 Basic Initial Functional Test



CAUTION: *Work carefully when performing these tests; hazardous voltages are present on the input and output during this test.*

Refer to Figure 3-5 for the required functional test set up. Make sure the correct sense connection is present if External Sense mode is selected. If Internal Sense mode is used, no sense connection is required but some voltage drop may occur at the load connection. In that case, the scope and meter connection should be made at the output terminal strip of the power source.

Proceed as follows to perform a basic function check of the power system:

1. Verify the correct AC line input rating on the nameplate at the rear panel. Make sure the correct line voltage is selected before applying input power. The 2253iX is auto ranging so will accept 115 VAC, 208VAC or 230VAC. If 115VAC is used, full power is reduced.
2. Connect a suitable resistive or other type load to output phase A of the unit. Suggested load values for both voltage ranges are shown in Table 3-12. Make sure the power resistor has sufficient power dissipation capability for full load test and that the load used does not exceed the maximum power rating of the AC source.
3. Connect an oscilloscope and DMM / voltmeter to the AC source output phase A and Neutral. Set both for AC mode.
4. Turn on the power source using the On/Off switch on the front panel. Allow the power source to initialize.
5. Use the PHASE button to either select phase A only (LED A on) or all three phases (All phase LED's lit).
6. Set the output voltage to 0 volt and close the output relay with the OUTPUT ON/OFF button. There should be little or no output although the DMM may show a noise level, especially if the DMM is in auto ranging mode.
7. Select the **Set** screen and use the keypad to program a small voltage (20 VAC). Observe the DMM reading. The reading should track the programmed voltage.
8. Also monitor the scope display. The output signal should be a sinusoidal voltage waveform.
9. If the output tracks, increase the voltage until you reach 115V on the low voltage range or 230V on the high voltage range. Check the output voltage reading and waveform.
10. Select the measurement screen by pressing the **Meas** button. The output voltage, current and power will be displayed. For phase B and C, use the PHASE button to select the correct phase measurement display.
11. Repeat for Phase B and C as needed.

In the unlikely event the power source does not pass the functional test, refer to the calibration procedure in Section 6 or call California Instrument's customer satisfaction department for further assistance.

Model	115V on 150 V range	230V on 300 V range
2253i/iX, 3 phase mode	20 Ohm	80 Ohm
2253i/iX, 1 phase mode	6.67 Ohm	27 Ohm

Table 3-12: Load Resistance

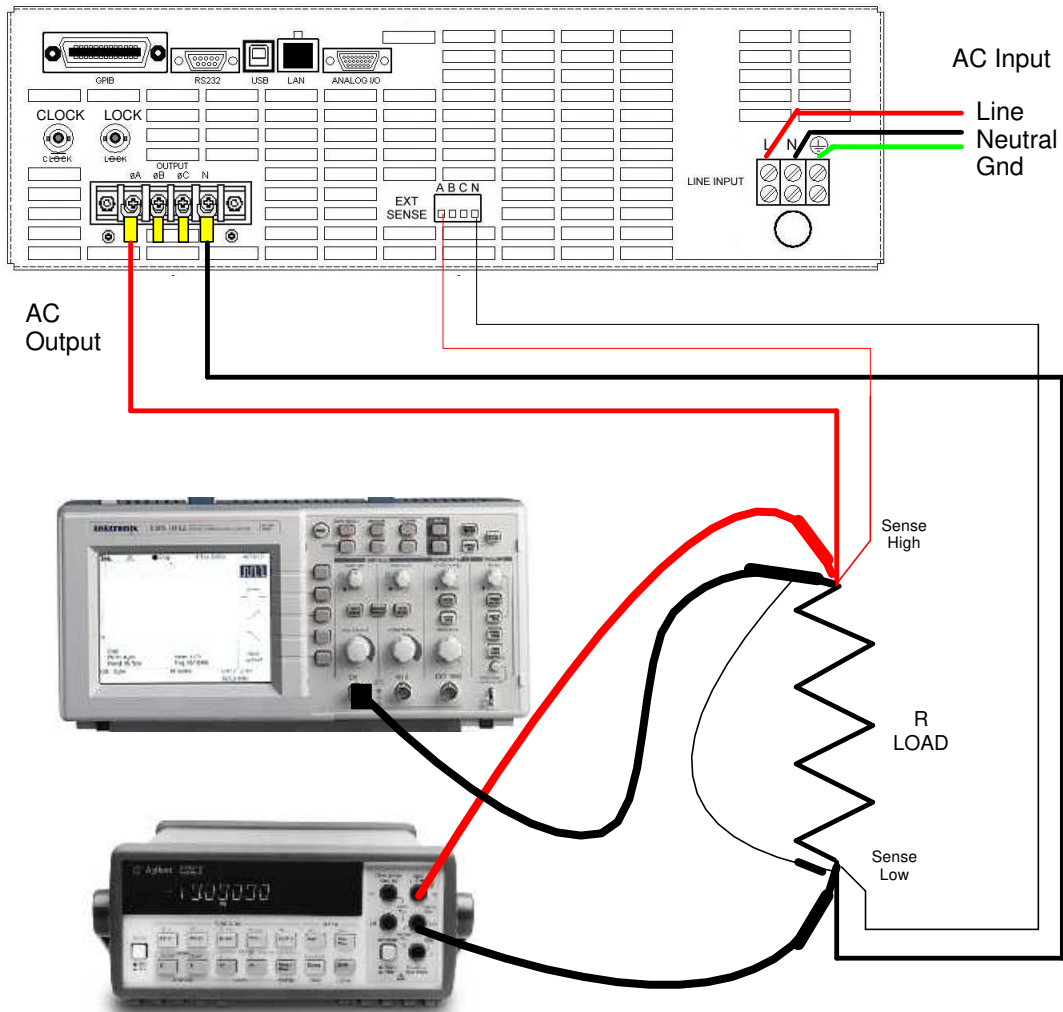

Figure 3-5: Functional Test Setup

3.9 Clock and Lock Mode (-LKM/-LKS Option)

Clock and lock mode operation of two or more iX AC power sources is available only if the -LKM and -LKS options have been installed at the factory. With these options installed, it is possible to lock an auxiliary unit (-LKS) to a master unit (-LKM). The master unit controls the frequency. This configuration can be used to create multiphase power systems such as split-phase or three phases. The auxiliary unit must be set to external clock mode from the Control screen. See section 4.2.5.

Two BNC connectors are provided on the rear panel of the iX model for clock and lock mode. Both need to be connected between the master and auxiliary unit. On the master unit (-LKM), both are outputs. On the auxiliary unit (-LKS), both are inputs. Do not connect these BNC's between two master units (-LKM's) or damage to the unit could result.

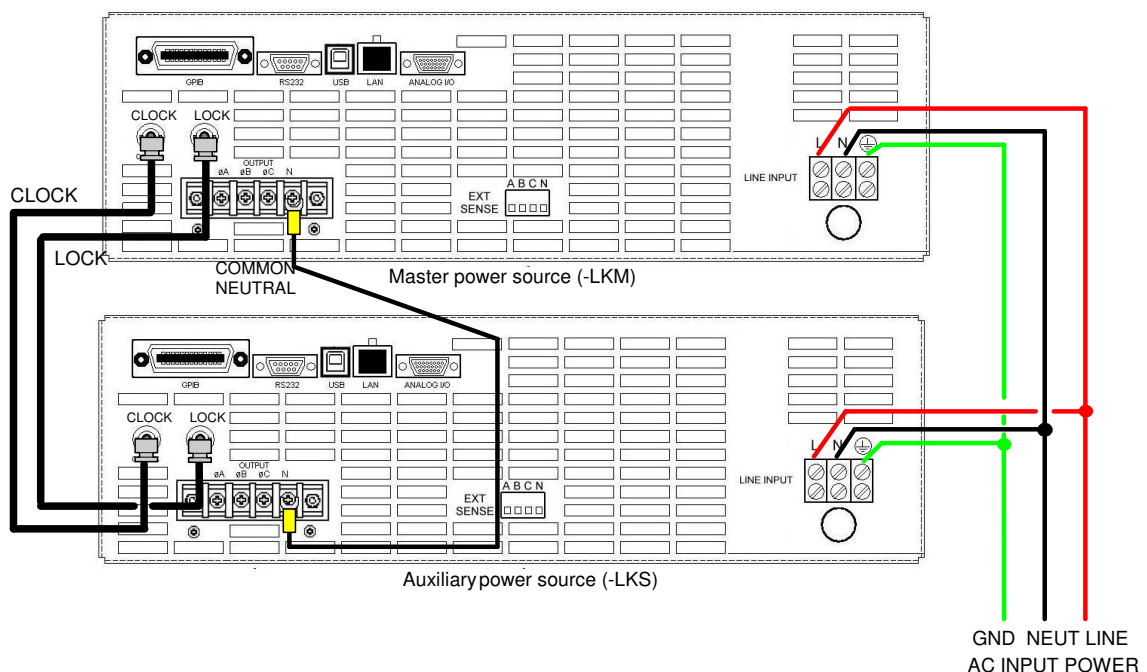

Figure 3-6: Clock and Lock Connections

Refer to Figure 3-6 for the required connections between the -LKM and -LKS units. The example is shown for two units, one master, one auxiliary. More than one auxiliary can be used to create additional phase outputs. In this case, the BNC cables can be daisy chained using BNC T connectors.

WARNING: **DO NOT CONNECT THE AC OUTPUTS OF THE -LKM AND -LKS UNITS TOGETHER. CLOCK AND LOCK OUTPUTS CANNOT BE PARALLELED TO OBTAIN HIGHER OUTPUT CURRENTS.**

Do not use clock and lock mode to obtain higher power capability on the same phase(s).

The frequency of the auxiliary unit will track that of the master. The output phase angle of phase 1/A will be locked to the auxiliary unit as well to within 3°. Phase B and C of each unit will be referenced to phase A of the same unit. This allows split phase or multi-phase configurations to be created.

3.9.1 Configuration settings

Units configured with the –LKM option will show the Clock as INT (internal) and the mode as CLK/LOC on the CONTROL screen. Units configured with the –LKS option can be set to INT (internal) or EXT (external) clock from the CONTROL screen. The MODE setting on the CONTROL screen of the –LKS unit determines the power on state for the clock setting. When set to STAN (Stand-alone operation), the unit powers up with INT clock. When set to CLK/LOC mode, it powers up in EXT clock mode suitable to clock and lock system operation. See section 4.2.5 for details.

3.9.2 Frequency measurements on –LKS units

AC power source models configured with the –LKS option used in a clock and lock configuration will not accurately measure frequency if the programmed voltage of the auxiliary unit (–LKS) is less than 30 Vrms (AC or AC+DC mode).

It is recommended to set the auxiliary unit's (–LKS) programmed frequency to the same frequency as the master (-LKM) unit. This does not affect the actual output frequency of the auxiliary unit as it is controlled by the –LKM master unit.

3.10 Remote Control Interfaces

Setup and connection information on setting up remote control using either GPIB, USB, RS232 or LAN interfaces is provided in the iX Compact Series Programming Manual P/N 6005-961. This manual is distributed on the same CD ROM (P/N CIC496) as this user manual. It can also be downloaded from the AMETEK Programmable Power website (www.programmablepower.com).

Connector pin out information is provided in sections 3.7.6, 3.7.7, 3.7.8 and 3.7.9 of this manual.

Note: *Use of the USB port to control more than one power source from a single PC is not recommended, as communication may not be reliable. Use GPIB interface for multiple power source control.*

4. Front Panel Operation

4.1 Tour of the Front Panel

Before operating the AC source using the front panel, it helps to understand the operation of the front panel controls. Specifically, the operation of the rotating shuttle knob, keyboard and the menu layout are covered in the next few paragraphs.

4.1.1 Front Panel Controls and Indicators

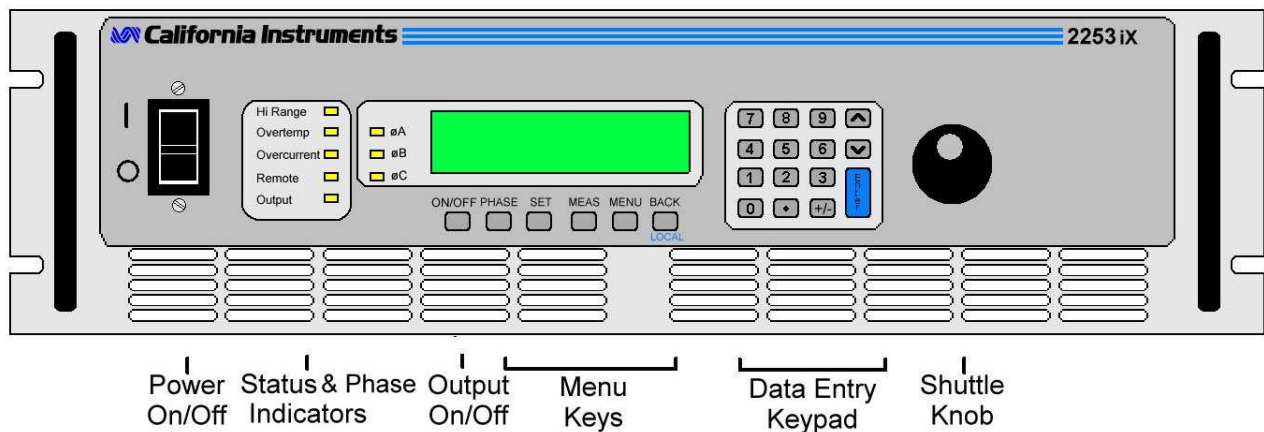

Figure 4-1: Front Panel controls and indicators.

The front panel can be divided in a small number of functional areas:

- AC Input power on/off switch
- Keyboard/ Display:
 - Status Indicator lights
 - Dual line LCD display (2 x 16 characters)
 - Output On/Off key
 - Menu Keys
 - Data Entry Keypad
 - Shuttle Knob

4.1.2 Input Power On/Off switch

The power on/off circuit breaker switch is located on the left side of the front panel of the unit and disconnects the AC Line input.

4.1.3 Status Indicator Lights

Five yellow LED status indicators are located on the left hand side of the keyboard/display panel. These LED's correspond to the following conditions:

Hi Range	The Hi Range LED is on when the high voltage output range has been selected.
Overtemp	The Overtemp LED indicates an overheating problem inside the unit. This is an abnormal condition, which will cause the unit to shut off. Check the air openings to make sure they are not blocked.
Overcurrent	The Overcurrent LED indicates an output current that exceeds the programmed setting. This condition can be controlled by setting the current limit value in the PROGRAM menu. Removing the load using the OUTPUT ON/OFF button will recover from an overload condition when in CV mode.
Remote	The Remote LED indicates that the unit is in remote control mode. If the IEEE-488 interface is used, this indicator will be lit whenever the ATN line (Attention) line for the GPIB address set is asserted by the IEEE controller. If the RS232, USB or LAN interface is used, the REMOTE state can be enabled by the controller using the SYST:REM command. Any time the Remote LED is lit, the front panel of the power source is disabled. Note: The BACK button doubles as a GOTO LOCAL button (LOCAL) while the unit is in remote state. This allows the user to regain control of the front panel. The LOCAL button can be disabled by sending a Local Lockout bus command ¹ . This prevents unauthorized changes of settings in ATE applications.
Output	The Output LED indicates the output relay status. If the LED is off, the output relay is open. If the LED is on, the output relay is closed.
øA, øB, øC	The Phase LEDs indicate the phase selection in effect. For setup screens, phase selection is either one individual phase or all phases (coupled). For the measurements screen, selection of all phases will default to displaying measurement data for phase A only. If the 2253i/iX has the -MODE option and is in single-phase mode, the phase A LED is always lit and the PHASE button has no effect.

¹ Note: When using the iXCGui Windows program with USB, RS232 or LAN interface, the local function is disabled. See programming manual for user application programming.

4.1.4 The Shuttle Knob

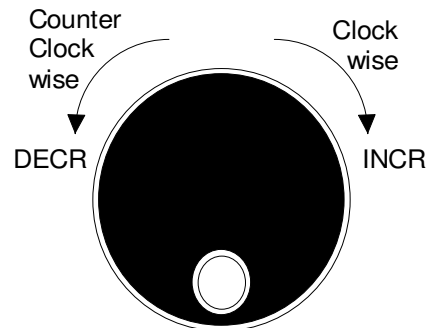

Figure 4-2: Shuttle Knob

The *i/iX* Series has a single rotating knob (“shuttle”). This shuttle knob is located to the right of the numeric keypad. This knob may be used to continuously vary parameter values or select from multiple settings in a given menu field. The parameter or field affected by turning the shuttle knob is indicated by a left pointing arrow (cursor) on the LCD display. Note that it is not possible to move this cursor position between menu fields using the knob. Use the UP and DOWN arrow (cursor) keys for this instead. Data and parameter entry can also be done through the numeric keypad.

The shuttle knob can operate in one of two distinct modes of operation:

MODE	DESCRIPTION
IMMEDIATE mode	Any time the ENTER key is pressed, the power source returns to its normal mode of operation. In this mode, changes made with the shuttle knob will take immediate effect. The IMMEDIATE mode is useful for continuously varying output values such as voltage and frequency and observing the effect on the load.
SET mode	When the Set key is pressed again while the PROGRAM screen is already displayed, changes made with the shuttle to any output parameter will not take effect until the ENTER key is pressed. In this mode, any changes made to a setup menu will have a blinking cursor to indicate the pending change condition. This mode allows changes to be made to all output parameters and executing them all at once by pressing the ENTER key.

4.1.5 Menu Keys

The i/iX Series is operated through a series of menus. These menus can be reached by using a number of menu keys located along the bottom of the LCD display and the UP/DOWN cursors keys. Several menus have more than two entries. Since the LCD display has two display lines, additional entries may not be visible but can be reached by scrolling up or down using the UP/DOWN cursor keys. The following menu keys are available:



Figure 4-3: Menu Keys

KEY	DESCRIPTION
ON/OFF	The ON/OFF key located to the left of the Menu keys may be used to control the state of the output relay. The active state is indicated by the Output LED. If the output relays are open (LED is off), the output is floating.
PHASE	The PHASE key is used to toggle between phase A, B, C or all phases (coupled mode). On models with the –MODE option, this key is active only while the 2253iX is in three phase mode.
SET	The SET key selects the PROGRAM setting screen. While this screen is displayed, the rotary knob can be used to change either voltage or frequency. Additional output settings such as current limit can be reached by using the down ▼ cursor key. For test options such as –704 or –160, the SET key can be used to skip to the next test in a test sequence during test execution.
MEAS	The MEAS key selects the measurement screen for the selected phase. If all three phases are selected, the measurement data for phase A will be displayed. There are no user changeable fields in the measurement screen. The rotary knob is active while the measurement screen is displayed. Additional measurement data can be displayed by using the up ▲ and down ▼ cursor keys.
MENU	The top-level menu is accessed by pressing the MENU key. Refer to section 4.2 for details on available menus.
BACK	The BACK key may be used to back up to the previous menu level or previously selected screen. It can also be used as a backspace key to delete the last digit entered. For tests options such as the –160 and –704 options, the BACK key can be used to abort a test in progress. If the unit is in remote mode, (Remote LED is lit), the front panel of the power source is disabled. The BACK button doubles as a GOTO LOCAL button (LOCAL) while the unit is in remote state. This allows the user to regain control of the front panel. This LOCAL button can be disabled by sending a Local Lockout bus command ¹ . This prevents unauthorized changes of settings in ATE applications.

¹ Note: When using the iXCGui Windows program with USB, RS232 or LAN interface, the local function is disabled. See programming manual for user application programming.

4.1.6 Cursor and Enter Keys

The cursor keys are located on the right hand side of the numeric keypad and can be used to scroll through a list of menu entries:

CURSOR UP (▲)	The UP key moves the cursor position upwards one position to the previous available cursor position.
CURSOR DOWN (▼)	The DOWN key moves the cursor position downwards one position to the next available cursor position.
ENTER	The blue Enter key is used to confirm selections made in menus or to activate settings made in SET mode.

4.1.7 LCD Display

The LCD display of the power source provides information on instrument settings and also guides the user through the various menus. A sample of the measurement display screen is shown in Figure 4-4.

Menus are accessed by scrolling through two or more entries. Alternatively, the Menu key may be pressed repeatedly to access additional available menu entries.

The active cursor position is indicated by a LEFT POINTING ARROW (←) and can be moved by using the UP (▲) and DOWN (▼) keys located on the right hand side of the numeric keypad.



Figure 4-4: Measurement Screen

4.2 Menu Structure

The next few pages show a map of the available menus in the i/iX Series. All menus can be reached by repeatedly pressing the **MENU** key. Frequently used menus have a short cut key that provides direct access. Examples of such menus are Program and Measurements. In any case, there are never more than two levels of menus although some menus may be spread across more than one screen.

4.2.1 Power on screens

At initial power up, the i/iX Series power supply will display important configuration information in a series of power on screens. These displays are only visible for a short period of time and will not re-appear until the next time the unit is turned on.

There are multiple screens that will appear in the following order:

1. LANetwork detection... At power up, the unit will try to detect a LAN interface. If not found, a "LAN not available" message will appear. The LAN will not be detected if:
 1. No –LAN option is installed.
 2. The USB port is connected to a computer.
 3. The RS232 port jumper is installed.This process may take several seconds.

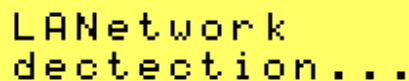

```
LANetwork
detection...
```

2. Initialization in progress. This means the firmware has started to load.

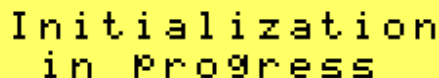

```
Initialization
in Progress
```

3. Company and firmware information. Displays the manufacturer - Cal Inst., which is short for California Instruments - and the firmware part number and revision. The firmware part number starts with CIC followed by a three-digit code and dash number. The firmware revision has a major revision before the decimal point and a minor revision after the decimal point.

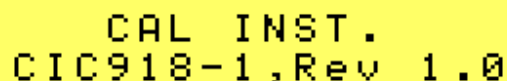

```
CAL INST.
CIC918-1,Rev 1.0
```

4. Model and Serial number information. The model will be a function of the configuration and will include the series designation (i or iX). The serial number is a 5-digit number. This number should match the model type sticker located on the back of the unit.

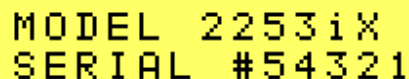

```
MODEL 2253iX
SERIAL #54321
```

5. Memory test result. If all memory tests pass at power on, the message "MEMORY TEST PASSED" will appear. If not, an error message will be displayed instead. This information may be useful when calling in for service support.



```
MEMORY TEST
PASSED
```

Once the power on sequence is completed, the power source will always revert to the PROGRAM screen shown here.

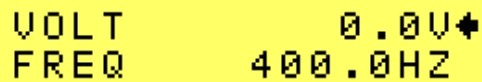

```
VOLT      0.00V
FREQ     400.0HZ
```

The power source is now ready to be used.

4.2.2 Top Level Menus

The following top-level menu choices can be accessed using the **Menu** key:

ENTRY	DESCRIPTION
PROGRAM	The PROGRAM menu allows primary output parameters such as voltage, frequency, current limit, waveform shape and voltage range to be changed.
CONTROL	The CONTROL menu allows secondary setting parameters such as sense mode, phase mode and ALC mode to be changed.
MEASUREMENTS	The MEASUREMENT screen is not a menu in that no user entries are required. It displays read-back data.
TRANSIENTS	The TRANSIENTS menu allows output transients to be programmed.
REGISTERS	The SETUP REGISTERS menu allows complete instrument settings and transient list programs to be saved to nonvolatile memory.
CONFIGURATION	The CONFIGURATION menu allows changes to be made to configuration settings such as the IEEE-488 address, RS232, USB or LAN internal baud rate, LAN settings, power on state and Master/Auxiliary control mode.
OUTPUT CAL	The OUTPUT CAL menu provides access to the LCD viewing angle and Calibration password entry. If the correct calibration password is entered, additional calibration screens can be accessed.
MEAS CAL	The MEAS CAL menu allows for calibration of the AC source measurement system.
APPLICATIONS	The APPLICATIONS menu provides access to the optional firmware application programs that may be installed in the power source controller.
OPTIONS	The OPTIONS menu provides access to optional functions that may be present on the power source.
ETIME/TEMP	The ETIME/TEMP screen displays the Elapsed time (Time the unit has been in operation) in hours, minutes and seconds. It also displays the internal temperature of the unit in degrees Celsius.
LIMITS	The LIMITS screen displays the hardware configuration limits of the AC power source. It is for display purposes only and the user can change none of these fields.

4.2.3 Menu Tree

i/iX Series

Menu Structure

LEVEL 1

PROGRAM
CONTROL

LEVEL 2

VOLT 120.0V
FREQ 400.0HZ

VRANGE 150.0V
PHASE 0.0°

FUNC >SINUSOID
CLIP THD 10.0

VOLT MODE AC
DC OFFSET N/A

CURR 13.00A
OL MODE CV

SENSE INT
SYNC INT

CLOCK INT
MODE STAN

ALC STATE ON
VOLT REF INT

OUTPUTS THR
ST PHASE RAND

MEASUREMENT
TRANSIENT

100.00V 2.349A
400.0HZ 234.9W

238.7VA 1.00pF
2.349A 0.98cF

0.18%A 10.559A
0.19%V 0.0°

TRAN ST IDLE
COUNT 10

TRIG SOUR IMM
TRAN STEP AUTO

LEVEL 1

REGISTERS
CONFIGURATION

LEVEL 2

SAVE REG #
RECALL REG #

ADDRESS 1
BAUD RATE 460800

PON STATE RST
CONTROL MAST

LANGUAGE SCPI
SYSTEM 2253iX

LANetwork <

-LAN option only

IP Address NC
100.10.1.87

MAC Address
0:20:4A:9A:02:FD

GWAddress NC
100.10.1.1

HostBits 8 NC<
Port No 5025

OUTP CAL
MEAS CAL

VIEW ANGLE -5
CAL PWORD 100

VOLT FS 2654
PHASE OFST 0.0

MVOLT FS 4000
MCURR FS 5600

APPLICATIONS
OPTIONS

MIL704
DO160

MS704
WHM

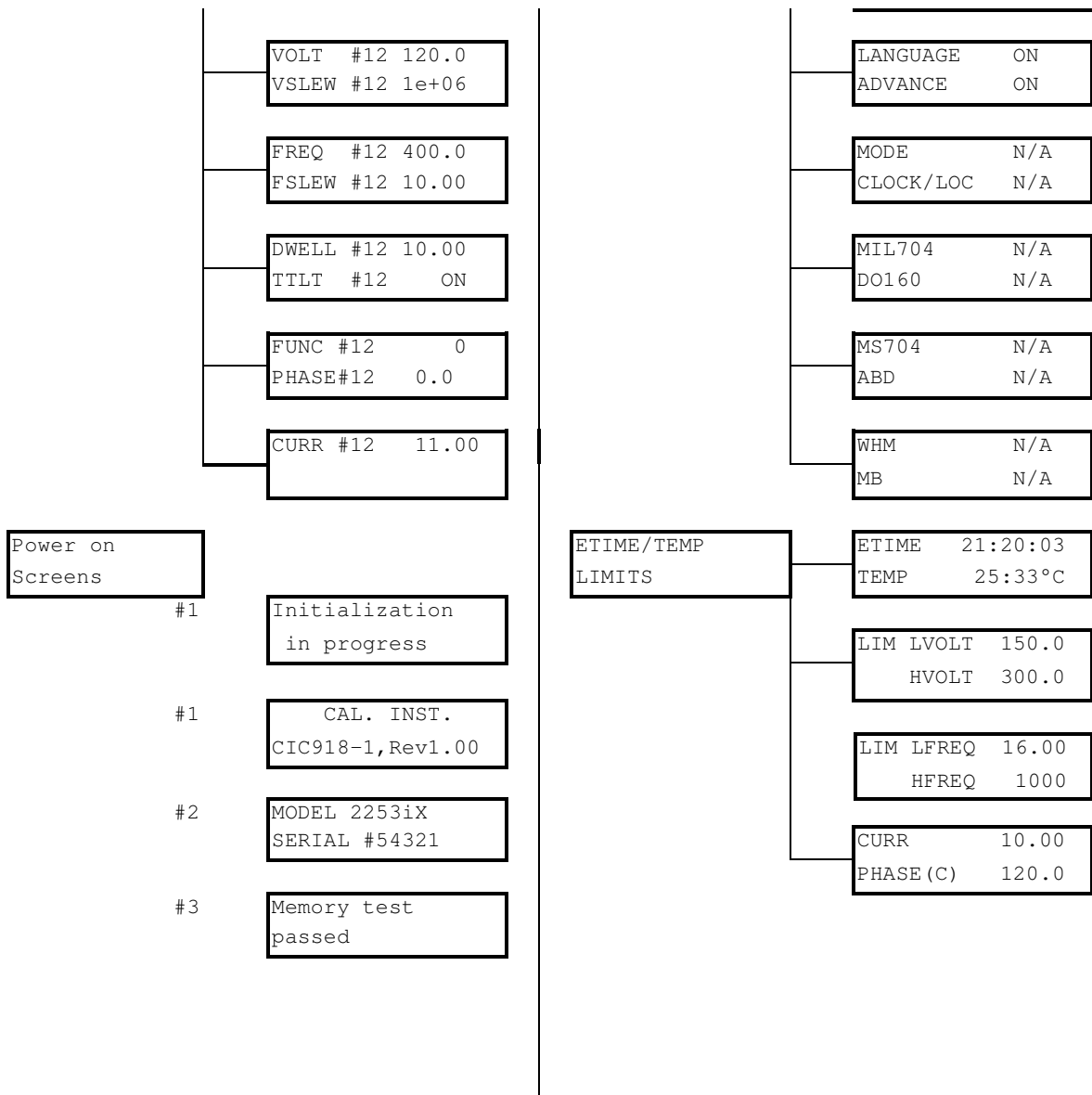

Table 4-1: Menu Tree

4.2.4 PROGRAM Menu

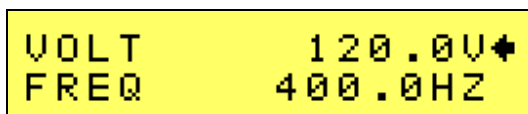

Figure 4-5: PROGRAM Menu

The PROGRAM menu is shown in Figure 4-5. It can be reached in one of two ways:

1. By selecting the **MENU** key, selecting the PROGRAM entry and pressing the **Enter** key.
2. By pressing the **SET** key.

The PROGRAM menu is used to change primary output parameters. Less frequently used parameters are located in the CONTROL menu.

The following choices are available in the PROGRAM menus:

ENTRY	DESCRIPTION
VOLTAGE	Programs the output voltage in Vrms. The voltage can be changed from 0 to its max range value as determined by the configuration settings and the selected voltage range using the keypad + Enter or the shuttle (if the voltage field is selected). NOTE: Voltage programming is phase specific. To program all three output phases at the same time, use the PHASE key first to select coupled mode (A, B, C phase indicator all on). To program an individual phase only, select the desired phase using the PHASE key first.
FREQ	Programs the output frequency. The frequency can be changed from its min to its max value as determined by the configuration settings using the keypad + Enter or the shuttle (if the frequency field is selected).
VRANGE	Selects 150V or 300V voltage range (if available). The actual range values may be different depending on the configuration. The value of this field can be changed with the shuttle as long as the active pointer (←) points to the VRANGE entry. If only one voltage range is available, this field cannot be changed.
PHASE	Selects the phase angle between the external clock and the output of the AC source. If the clock source is internal, this parameter has no effect. This setting always applies to phase A only, regardless of the phase selection in effect.
FUNC	Selects the waveform for the selected phase. On iX models, available choices are SINUSOID, SQUARE and CLIPPED or any user defined waveform that was downloaded to the AC source waveform memory using one of the available interfaces. This field is fixed to SINUSOID on 'i' models. NOTE: Function programming is phase specific. To program all three output phases at the same time, use the PHASE key first to select coupled mode (A, B, C phase indicator all on). To program an individual phase only, select the desired phase using

ENTRY	DESCRIPTION
	the PHASE key first.
CLIP LEVEL	<p>Sets the clip level for the CLIPPED sine wave in percent VTHD. The range is 0 to 20 %. (iX models only).</p> <p>Note: <i>Changing the clip level setting will result in temporary loss of the output voltage as the new clipped waveform is loaded. This may cause the EUT to reset or turn off. To avoid this, set the desired clip level before programming the AC voltage and turning on the output to the EUT or use the transient list system to switch between waveforms.</i></p>
VOLT MODE	<p>Selects the available output modes of operation. Available modes are AC, DC (i/iX models) and ACDC (iX models only). The shuttle can be used to select the desired output mode.</p>
DC OFFSET	<p>This parameter applies only when the power source is in ACDC mode. The DC offset can only be set in percent of the AC RMS voltage programmed. (Relative programming only). The available dc offset range is $\pm 20\%$.</p> <p>NOTE: Offset programming is phase specific. To program all three output phases at the same time, use the PHASE key first to select coupled mode (A, B, C phase indicator all on). To program an individual phase only, select the desired phase using the PHASE key first.</p> <p>Note: <i>Changing the offset percentage setting will result in temporary loss of the output voltage as the new offset is recalculated and loaded. This may cause the EUT to reset or turn off. To avoid this, set the desired offset percentage before programming the AC voltage and turning on the output to the EUT.</i></p>
CURR	<p>Sets the current limit value for the current detection system. When the load current value exceeds the set current limit, a fault condition is generated. The actual response of the AC Source to a current limit fault is determined by the protection mode selected in the OL MODE field. (CC = Constant Current, CV = Constant Voltage).</p> <p>NOTE: Current programming is phase specific. To program all three output phases at the same time, use the PHASE key first to select coupled mode (A, B, C phase indicator all on). To program an individual phase only, select the desired phase using the PHASE key first.</p>
OL MODE	<p>Sets the current limit overload mode. The actual response of the AC Source to a current limit fault is determined by this setting. Available settings are CC for Constant Current mode or CV for Constant Voltage mode. In CV mode, the AC source output will trip off and stay off until re-engaged. In CC mode, the voltage will be reduced until the current limit is no longer exceeded.</p>

4.2.5 CONTROL Menus

SENSE SYNC	INT INT	↔	CLOCK MODE	INT STAN	↔
ALC STATE VOLT REF	ON INT		# OUTPUTS ST PHASE	N/A RAND	

Figure 4-6: CONTROL Menus

The CONTROL menu is shown in Figure 4-6 and can be reached by selecting the **Menu** key, selecting the CONTROL entry using the DOWN cursor key and then pressing the **Enter** key.

The CONTROL menu is used to change secondary output parameters. The following choices are available in the CONTROL menus:

ENTRY	DESCRIPTION	
SENSE	Selects internal or external (remote) voltage sense mode. If INT is selected, the voltage is sensed at the output terminal block. If EXT is selected, the voltage is sensed at the external sense connector. If external sense is selected, care must be taken to connect the external sense lines at the load. For sense leads longer than 1 meter, twisted pairs should be used.	
SYNC	Selects the external sync mode if available. Default is internal sync, which means a free running time base. The time base can be synchronized to an external sync signal depending on installed options (-EXS option).	
CLOCK	Selects internal or external clock source. The i/iX Series controller uses an open-air crystal time base with an accuracy of 100 ppm. The external clock mode is used to support the -LKS option. For use as an auxiliary unit in a clock and lock system, this field must be set to EXT. A unit with -LKS option can be used stand-alone if needed by setting the INT clock mode. The same EXT setting is required to use the -RPF (remote programming frequency) analog input for frequency programming if the -RPF option is installed.	
	INT	Default, internal clock.
	EXT	Auxiliary unit (-LKS) driven by master (-LKM) clock input. Note: When selecting EXT mode, make sure the Clock and Lock BNC cables are connected to the Master (-LKM) unit. If not, there will be no output on the -LKS unit. See section 3.9 for connection information.
MODE	Power on clock mode. The following two modes can be selected.	

ENTRY	DESCRIPTION				
	<table border="1"> <tr> <td data-bbox="579 353 762 645">STAN</td> <td data-bbox="762 353 1394 645"> Power up in INT (internal) clock mode for stand-alone operation. This is the only mode for models without the –LKS option. For units with the –LKM option installed, this field is fixed to CLK/LOCK. For units with the –LKS option installed, this field can be changed to CLK/LOCK for use as an auxiliary unit in a clock and lock system or to STAND for use as a stand alone unit. </td> </tr> <tr> <td data-bbox="579 645 762 943">CLK/LOCK</td> <td data-bbox="762 645 1394 943"> Fixed on master (-LKM) unit configuration in a clock and lock system. Power up with EXT (external) clock mode on unit with –LKS option. (See OPTION menu section.) Note that this field cannot be changed if the –LKM option is installed. The frequency resolution below 81.9 Hz in MAST clock and lock mode is reduced to 0.1 Hz from the normal 0.01 Hz. </td> </tr> </table>	STAN	Power up in INT (internal) clock mode for stand-alone operation. This is the only mode for models without the –LKS option. For units with the –LKM option installed, this field is fixed to CLK/LOCK. For units with the –LKS option installed, this field can be changed to CLK/LOCK for use as an auxiliary unit in a clock and lock system or to STAND for use as a stand alone unit.	CLK/LOCK	Fixed on master (-LKM) unit configuration in a clock and lock system. Power up with EXT (external) clock mode on unit with –LKS option. (See OPTION menu section.) Note that this field cannot be changed if the –LKM option is installed. The frequency resolution below 81.9 Hz in MAST clock and lock mode is reduced to 0.1 Hz from the normal 0.01 Hz.
STAN	Power up in INT (internal) clock mode for stand-alone operation. This is the only mode for models without the –LKS option. For units with the –LKM option installed, this field is fixed to CLK/LOCK. For units with the –LKS option installed, this field can be changed to CLK/LOCK for use as an auxiliary unit in a clock and lock system or to STAND for use as a stand alone unit.				
CLK/LOCK	Fixed on master (-LKM) unit configuration in a clock and lock system. Power up with EXT (external) clock mode on unit with –LKS option. (See OPTION menu section.) Note that this field cannot be changed if the –LKM option is installed. The frequency resolution below 81.9 Hz in MAST clock and lock mode is reduced to 0.1 Hz from the normal 0.01 Hz.				
ALC STATE	<p>Sets the Auto Level Control (ALC) mode. This mode uses the internal measurement system to zero regulate the output. There are three modes of operation:</p> <p>OFF No measurement based output regulation.</p> <p>REG Output regulation is enabled. AC source will continuously regulate output but will not trip off output.</p> <p>ON Output regulation is enabled and output will fault (trip off) with Error 801 “Output Voltage fault” if regulation cannot be maintained and the programmed output voltage is 10Vrms or higher. No error is generated for settings below 10 volt.</p> <p>In most situations, the ALC mode should be set to REG or ON for optimal performance.</p> <p>Note: The ALC ON mode only functions for programmed output voltages above 10 Vrms. The ALC REG mode only functions for programmed output voltages above 5 Vrms.</p>				
VOLT REF	<p>Selects internal or external voltage programming. Select INT for programming of voltage from the front panel or over the bus. Select EXT to use the RPV (remote programming voltage). Note that the ALC mode must be set to OFF to change to external input/rpv input mode. The RPV input expects a 0-10 Vdc signal for 0 to full-scale voltage. Only one RPV input signal is available to drive all three phases if the 2253 is in three phase mode. Thus, all three-phase output amplitudes will track the same RPV input DC signal. The –RPV option must be installed for this mode of operation. This field should also be set to EXT for models that have the –EXT (external input signal) option installed.</p>				

ENTRY	DESCRIPTION
# OUTPUTS	Selects SINGLE or THREE phase mode of operation. If the –MODE option is installed, this field can be toggled on the 2253i / 2253iX. If no –MODE option is installed, this phase will always be set to THR for three phase mode.
ST PHASE	Selects the start phase angle for output changes made to either voltage or frequency. This allows changing the output at a specific phase angle. The ON/OFF key also uses this phase angle setting to program the output voltage up to the set level after the output relay is closed. The default value for this field is RAND. To set the start phase angle, set the cursor to the ST PHASE field and use either shuttle knob to adjust between $\pm 360^\circ$. To set to RAND, use the BACK key.

4.2.6 MEASUREMENTS Screens

The i/iX Series uses a DSP based data acquisition system to provide extensive information regarding the output of the Source. This data acquisition system digitizes the voltage and current waveforms and calculates several parameters from this digitized data. The results of these calculations are displayed in a series of measurement data screens. A total of three measurement screens are used to display all this information.

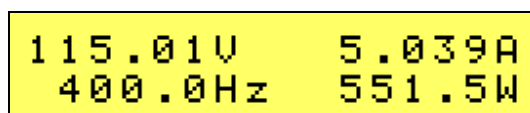

Figure 4-7: MEASUREMENT Screen

The Measurement screens available on the iX Series are not menus in that no changes can be made anywhere. Instead, these screens provide load parameter readouts. The measurement screens can be reached by successively pressing the **MEAS** key, which will toggle to all available screens. Note that for i Series models, only the first two screens are available. For the iX series, all three measurement screens are available.

The **PHASE** key may be used to toggle through each output phase's measurement screens. The selected phase will be indicated by the phase LED's to the left of the LCD display. If all three phases are selected, data is only shown for phase A.

The following parameters are available in the measurement screens:

ENTRY	DESCRIPTION
	MEASUREMENTS 1
VOLTAGE	This value is the true rms output voltage measured at the voltage sense lines.
CURRENT	This value is the true rms output current drawn by the load.
FREQ	The output frequency is measured at the sense lines.
TRUE POWER	This value is the real power.
	MEASUREMENTS 2
VA POWER	This value is the apparent power.
POWER FACTOR	This readout shows the power factor of the load.
PEAK CURR	This readout reflects the highest peak current value detected at the output. This is a track and hold peak current measurement. To measure inrush current for a unit under test, open the output relay and reset the peak current value using the BACK key. Then program the output voltage and frequency and turn on the output relay. The peak current measurement will continuously track the maximum current value detected until reset. See also PEAK CURRENT in MEASUREMENTS 3 screen.

ENTRY	DESCRIPTION
CREST FACTOR	This readout displays the ratio between peak current and rms current.
	<i>MEASUREMENTS 3 (iX Models only)</i>
CURR THD	<p>This readout displays the total current distortion for the selected phase. The distortion calculation is based on the H2 through H50 with the RMS current in the denominator. Note that some definitions of THD use the fundamental component (H1) of the current as the denominator.</p> <p>If desired, the user can program the power source controller to use the fundamental component as the denominator. This mode can only be programmed over the bus by sending the “MEAS:THD:MODE FUND” command. At power up or after a reset command, the mode will revert back to RMS.</p>
PEAK CURRENT	This value is the instantaneous peak current. See also PEAK CURR in MEASUREMENTS 2 screen.
VOLT THD	<p>This readout displays the total voltage distortion for the selected phase. The distortion calculation is based on the H2 through H50 with the RMS voltage in the denominator. Note that some definitions of THD use the fundamental component (H1) of the voltage as the denominator.</p> <p>If desired, the user can program the power source controller to use the fundamental component as the denominator. This mode can only be programmed over the bus by sending the “MEAS:THD:MODE FUND” command. At power up or after a reset command, the mode will revert back to RMS.</p>
PHASE	Relative voltage phase angle measurement with respect to phase A. This readout is only relevant if an external clock source is used.

Update Program Functions from Measurement Screen

The Shuttle knob can be used to update voltage and/or frequency settings while the measurement readout screen is displayed. To do so, select the desired parameter to be change while in the SET screen using the left arrow cursor. Then, select the measurement screen by pressing the MEAS button. While the measurement screen is visible, the shuttle continues to operate.

4.2.7 TRANSIENT Menu

TRAN ST COUNT	IDLE 1	TRIG SOURCE IMM TRAN STEP AUTO
VOLT #12 120.4 VSLEW #12 20.00	FREQ #12 400.0 FSLEW #12 10.00	
DWELL #12 0 TTLT #12 0.0	FUNC #12 SINUS PHASE #12 0.0	
CURR #12 11.00		

The transient menu is used to program and execute user-defined output sequences. These output sequences are defined as a sequential list of voltage and/or current settings that can be executed in a time controlled manner.

Each step in these lists is assigned a sequence number ranging from #0 through #99. The numbering determines the order in which each step is executed.

Each step can control the voltage setting, voltage slew rate, frequency setting, frequency slew rate and dwell time. The dwell time determines how long the output dwells at the current step before progressing to the next step. Dwell times can range from 1 ms up to 900000 seconds.

Transient lists can be set up from the front panel or over the bus. The transient list can be saved with the rest of the front panel settings in one of the setup registers. (See Register Menu).

ENTRY	DESCRIPTION	
TRAN ST	Indicates the status of the transient system. Available modes of operation are:	
	IDLE	Transient system is in IDLE or inactive state. To start a transient list, press the ENTER key while on the TRAN STATE field. Note that the output must be ON to run a transient program or an error message will be displayed.
	WTRIG	Transient system is armed and waiting for a trigger event.
	BUSY	Transient system is active. A transient list execution is in progress.
COUNT	Sets the execution count for the transient system. A count of 1 indicates the transient will run 1 time. The count value can be set with the shuttle knob or the keypad while the cursor is on this field. The count range is from 1 through 2E+08. Values below 200,000 are displayed in fixed point notation. Value higher than 200,000 are displayed as a floating point number	

ENTRY	DESCRIPTION	
	(2E+05). The display has insufficient characters to display the entire mantissa so entering values above 2E+05 from the keyboard is not recommended.	
TRIG SOURCE	Indicates the trigger source for transient system. Available trigger sources are:	
	IMM	Immediate mode. The transient is started from the front panel using the ENTER key.
	BUS	Bus mode. The transient system is started by a bus command or a group execute trigger (GET).
	EXT	External mode. The transient system is started by a user-provided external TTL trigger signal on TRIGGER IN.
TRAN STEP	Indicates the transient system execution mode. Available modes are:	
	AUTO	When triggered, the transient system will automatically execute each list point sequentially without waiting for a trigger between list points. This execution is paced by the dwell time set for each data point.
	ONCE	When triggered, the transient system will execute the first list point and wait for a new trigger once the dwell time expires. This allows triggered execution of each step in the transient list.
List parameters:		
VOLT	Step #	Voltage set point
VSLEW	Step #	Voltage slew rate in V/s
FREQ	Step #	Frequency set point
FSLEW	Step #	Frequency slew rate in Hz/s
DWELL	Step #	Dwell time in seconds. Range is 0.001 to 900000
TTLT	Step #	ON: Generates an output trigger pulse at this list step. OFF: No output trigger. The output trigger is available on the TRIG OUT on the rear panel. (Aux I/O DB9 connector).
FUNC	Step #	Waveform selection. Available choices are

ENTRY	DESCRIPTION	
		Sinusoid, Square, Clipped or any of the user provided waveforms in waveform memory (iX models only).
PHASE	Step #	Phase angle set point. (Not relevant for phase A if clock mode is internal.)
CURR	Step #	Current set point

Transient List point data entry method.

Transient list points are numbered sequentially from 0 through 99 and executed in this order. Each list point or list entry has 9 parameters as shown in the table above. To enter list point data, the keypad must be used. The shuttle knob is used to increment or decrement the list point sequence number (#). The sequence number can only be increased to the next available empty (new) list point.

To move to the next or previous parameter, use the UP (▲) or DOWN (▼) cursor keys

It is not necessary to use all list points, only as many needed to accomplish the desired output sequence.

Setting Data Values

Data values can be set for each point in a list. If all data values in a specific list are going to be the same value (e.g. the current limit parameter is set to the same value for the entire transient program), only the first data value for that parameter has to be set. Setting only the first data point will automatically repeat that value for all subsequent points in the transient list.

Setting Slew Rates

Very often, output changes must be done as fast as the power source can make them. This means the transient list slew rate is set to its maximum value. If this is the case for all the data points in the list, it is sufficient to set just the first data point's slew rate for either voltage and/or current. Setting only the first point of any parameter in the list will automatically cause all points for that parameter to be set to the same value. This saves a lot of data entry time.

If however, one or more data points require a specific slew rate such as needed to do a ramp, all other points have to be specifically set to their required slew rates, including the maximum slew rate.

Saving Transient Lists

Once completed, a transient sequence can be saved along with the steady state setup of the instrument by using the REGISTER, SAVE menu. Registers that may be used for this purpose are 1 through 15. It is advisable to do so, especially for longer transient lists.

4.2.8 REGISTERS Menu

```
SAVE    REG #1
RECALL REG #0
```

The registers menu provides access to the non-volatile setup storage of the power source. A total of 16 front panel setups can be stored in registers numbered from 0 through 15. Each register except register 0 can hold the complete front panel setup, including the programmed transient list. This allows for quick recall of different setups and transient programs.

Register 0 is reserved to be used as the power-on setting as assigned by the user. To have the power source start in a specific setting, save the desired setting to Register 0 and assign register zero as the power-on default in the CONFIGURATION menu. Alternatively, the power source can be set to power up with the RST factory default settings. See 4.9 for factory default settings.

ENTRY	DESCRIPTION	
SAVE	REG 0 – 15	<p>Saves the selected setup and transient list from memory. (Setup only for Reg 0) The shuttle knob may be used to scroll through the available list of setup register numbers. Use the ENTER key to perform the save operation.</p> <p>Register 0 can be assigned as the power-on state setup from the CONFIGURATION menu. A valid setup must be saved in REG0 to do so.</p> <p>Note that REG0 only saves the setup, not the transient list. All other registers also save the transient list.</p>
RECALL	REG 0 – 15	<p>Recalls the selected setup and transient list to memory. (Setup only for Reg 0) The shuttle knob may be used to scroll through the available list of setup register numbers. Use the ENTER key to perform the recall operation.</p> <p>Register 0 can be assigned as the power-on state setup from the CONFIGURATION menu. A valid setup must be saved in REG0 to do so.</p> <p>Note that REG0 only saves the setup, not the transient list. All other registers also save the transient list.</p>

4.2.9 CONFIGURATION Menu

ADDRESS 1	PON STATE RST
BAUD RATE 460800	CONTROL MAST
LANGUAGE SCPI	LANetwork ↕
SYSTEM 2253iX ↕	

The configuration menu may be used to configure various aspects of the instrument such as the serial port, IEEE-488/GPIB address, LAN settings (units with -LAN option only) and the power-on settings of the supply.

ENTRY	DESCRIPTION	
ADDRESS	0 - 31	Sets the selected IEEE / GPIB bus address for the optional IEEE/GPIB interface. Factory default is address 1. The shuttle knob or the keypad can be used to set a value from 0 through 31. Do not use address 0 as this address is typically reserved for the GPIB controller.
BAUD RATE	9600 19200 38400 57600 115200 230400 460800	Sets the baud rate for the USB, RS232 and/or LAN (Ethernet) communications port. Factory default is 460800 baud. Available settings are 9600 through 460800 baud. Note: For USB and LAN use, you must set the baud rate to 460800. The shuttle knob can be used to scroll through these selections.
PON STATE	REG0 RST	Determined power on state. This setting selects either non-volatile REG0 to be recalled automatically at power-on or factory default (RST). Factory default is RST, which recalls the factory settings. Note that to use REG0 for power-on default, the contents of the register must be programmed first. See section 4.2.8. If an empty register is selected, the power source will revert back to RST (factory setting).
CONTROL	MAST AUX	This is an information-only field that displays the controller operation mode. For a single stand-alone iX unit, the mode is always MAST (Master).
LANGUAGE	SCPI ABLE	Displays the active programming command language syntax selection. Default for compact i/iX series is SCPI (Standard commands for Programmable Instruments). If the -ABL option is installed, the ABLE (Atlas Based Language Extension) syntax can be

ENTRY	DESCRIPTION	
		selected. See programming manual for details on use of either syntax.
SYSTEM	2253iX	This field is not user controlled. It merely indicates the configuration of the power system.
LANetwork	LAN	If the –LAN option is installed; pressing Enter while the cursor is on the LANetwork entry provides access to the LAN interface setting screens listed below.
<pre>IP Address NC 255.255.255.255</pre>	IP Address	<p>Displays the IP address setting. This value can be changed by pressing the SET key and entering a new value from the keypad. Use the numeric data pad to enter each field. To move between the four fields, use the decimal point key on the keypad.</p> <p>To set a fixed IP address, press SET and enter the desired IP address. To set the unit to DHCP mode, press SET and enter all zeros (0.0.0.0) as the IP address and cycle power two times. The obtained IP address will be displayed after the second power on. For the DHCP setting to work however, the unit MUST be connected to a network with a DHCP server.</p> <p>Any change to this value will NOT take effect until after power on the unit has been cycled. When changing mode from static IP to DHCP, it is necessary to cycle power on the unit twice, once to change mode and again to obtain and display a new IP address from the network.</p>
<pre>MAC Address 0:20:4A:9A:02:FD</pre>	MAC Address	<p>Displays the network Media Access Control address. This value is fixed and cannot be changed. The same MAC is normally printed on the model serial tag. The MAC address is shown as six hexadecimal numbers separated by a colon, e.g. 00:20:4A:9A:02:FD. Note that the leading '0' is never visible due to the maximum number of LCD characters per line.</p> <p>Note: If the MAC Address displayed is corrupted or does not match the serial tag, there may have been a problem retrieving the LAN port settings. To recover, turn on power to the unit while holding down the SET key. This will allow the unit to boot without attempting to collect the IP settings. You can then set the required IP values. [See IP Address above].</p>

ENTRY	DESCRIPTION	
<pre>GWAddress NC 255.255.255.255</pre>	GWAddress	<p>Gateway address setting. A default gateway is a node (a router) on a computer network that serves as an access point to another network.</p> <p>This value can be changed by pressing the SET key and entering a new value from the keypad. Use the numeric data pad to enter each field. To move between the four fields, use the decimal point key on the keypad.</p> <p>Any change to this value will NOT take effect until after power on the unit has been cycled.</p>
<pre>HostBits 8 NC Port No 5025</pre>	HostBits	<p>Number of host bits as opposed to network bits in network mask. A CIDR class C network uses 24 network bits and 8 host bits. (Class A = 24, Class B = 16).</p> <p>This value can be changed by pressing the SET key and entering a new value from the keypad. Any change to this value will NOT take effect until after power on the unit has been cycled.</p>
<pre>HostBits 8 NC Port No 5025</pre>	Port No	<p>TCP remote port number. This value must be set to 5025 (SCPI) to support the built in web page.</p> <p>This value can be changed by pressing the SET key and entering a new value from the keypad. Any change to this value will NOT take effect until after power on the unit has been cycled.</p>
<pre>LANDefault Yes=ENT No=BACK</pre>	LAN Default	<p>LAN default setting can be achieved by selecting the Mac address screen and press the set key followed by the Enter key. Press the Enter key again to confirm. The IP address is set to DHCP or AUTO IP.</p>

4.2.10 CALIBRATION Menus

```
VIEW ANGLE    -2
CAL PWORD     0*
```

```
MVOLT FS     4053
MCURR FS     2312
```

The measurement calibration menu can be used to perform routine calibration of the internal measurement system. The recommended calibration interval is 12 months. To enter the calibration screens, the calibration password must be entered first.

Note: Refer to chapter 6 for details on routine calibration procedures and equipment requirements. Do not attempt calibration without consulting the user manual.

This menu also contains the LCD viewing angle adjustment.

ENTRY	DESCRIPTION	
VIEW ANGLE	-10 to +10	LCD viewing angle adjustment.
CAL PWORD	V range	Calibration password required to access all calibration screens. The calibration password is the high voltage range value. [300] The password can be entered using the keypad or shuttle followed by the ENTER key.
		Measurement Calibration Screens
MVOLT FS	± 9999	Calibration coefficient for full-scale voltage measurement.
MCURR FS	± 9999	Calibration coefficient for full-scale current measurement.
		Output Calibration Screens
VOLT FS	± 9999	Calibration coefficient for voltage output.
PHASE OFST	0.0 - 360.0	Phase offset calibration for units equipped with the -LKS option. Determines phase offset from -LKM master clock.

4.2.11 APPLICATIONS Menu

Note that some of the application options listed in this section may not be available on all i/iX models and may not be configured. In this case, these fields in these menus will display "N/A" (not applicable) and no access to these menus will be available.

```
APPLICATIONS  ↵
OPTIONS
```

The Applications menu provides access to application specific firmware functions if available. Note that there may be no applications installed in which case this screen will still be shown but has no function.

```
MIL704      ↵
DO160
```

Possible applications are DO160 and MIL704. To access either of the application screens, position the cursor on the APPLICATIONS entry and press the ENTER key. Select the desired application and press ENTER.

```
MS704      ↵
ABD
```

4.2.12 OPTIONS Menu

```
APPLICATIONS  ↵
OPTIONS
```

The Options menu provides access to available optional features. Note that there may be no options installed in which case this screen will still be shown but has no function. The option settings are protected and cannot be changed by the user. These screens are provided for information purposes only.

LANGUAGE	N/A	↵	MODE	ON	↵
ADVANCE	ON		CLOCK/LOC	N/A	
MIL704	ON	↵	MS704	ON	↵
DO160	ON		ABD	ON	
WHM	ON	↵	LAN	ON	
MB	ON		FC	ON	

ENTRY	DESCRIPTION	
LANGUAGE	ON	If –ABL option is installed, this field will indicate ON.
	N/A	Default is N/A. All Compact i/iX support SCPI syntax standard.
ADVANCE	ON	Standard on all iX Series models.
	N/A	This feature is not available on i Series models. N/A is shown.
MODE	ON	If installed, output mode can be changed between 3 phase or 1 phase mode..
	N/A	If not installed, output configuration is always three phase mode.
CLOCK/LOC	N/A	Clock and lock is an option. If no –LKM option is installed, this field will show N/A.
	MAST	-LKM Option installed. The unit can be used as a Clock and Lock system master or stand-alone.
	AUX	-LKS option installed. The unit can be used as a Clock and Lock system auxiliary or stand-alone.
MIL704	ON or N/A	Mil-Std 704 Rev D, E test option. (Rev A, B, C and F provided through iXGui Windows software.)
DO160	ON or N/A	RTCA-DO160 Rev D test option.
MS704	ON or N/A	N/A
ABD	ON or N/A	Airbus ABD0100.1.8 test option.
WHM	ON or N/A	Watt Hour Meter option.
MB	N/A	This feature is not available on 2251i/iXi Series models. N/A is shown.

4.2.13 Elapsed Time and Temperature Screen

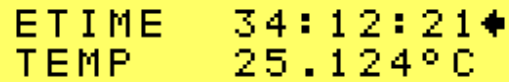

```
ETIME 34:12:21
TEMP 25.124°C
```

The Etime/Temp screen displays the elapsed time since the power source has first been turned on. This is an accumulated total time in hours, minutes and seconds.

The same screen also displays the internal temperature of the power supply.

ENTRY	DESCRIPTION	
ETIME	01:23:45	The ETIME field displays the total accumulated elapsed time for the instrument since it's initial manufacture. This value cannot be changed or reset.
TEMP	37.342°	The TEMP field is not a user selectable parameter but rather a read-out of the internal temperature in degrees Celsius. It is provided for informational purposes only.

4.2.14 LIMIT Menu

```
LIM LVOLT 150.0
LIM HVOLT 300.0
```

```
LIM LFREQ 16.00
LIM HFREQ 1000
```

```
CURR 5.00A
PHASE(C) 120.0
```

The Limit menu displays the maximum available value for voltage, frequency and current range of the power supply. This screen is used for information only and contains no user changeable fields. The limit values shown cannot be changed.

ENTRY	DESCRIPTION	
LIM LVOLT	Low Voltage Range	Displays maximum available output voltage in the low voltage range.
LIM HVOLT	High Voltage Range	Displays maximum available output voltage in the high voltage range.
LIM LFREQ	Low Frequency Limit	Displays minimum available output frequency.
LIM HFREQ	High Frequency Limit	Displays maximum available output frequency
CURR	C range	Displays maximum available current in low voltage range at full-scale voltage.
PHASE (C)	Phase Setting	Displays phase angle for phase C. Valid values are 120 for three-phase or MODE configuration, 0 for single-phase only configuration. Any other value indicates split (2) phase configuration. Standard 2253i/iX models are set to 120.

4.3 Output Programming

4.3.1 Set the Output

Output parameters are all set from the PROGRAM screen.

1. Use the MENU key and select the PROGRAM entry.
 2. Press the ENTER key to bring up the PROGRAM menu.
- or
2. Use the SET key to directly bring up the PROGRAM menu.

There are two methods for programming output parameters:

IMMEDIATE mode

SET mode

4.3.2 Slewing Output Values in IMMEDIATE Mode

The default mode of operation is an immediate mode in which changes to output parameters made with the knob or the entry keypad are immediately reflected at the output.

To change the output voltage:

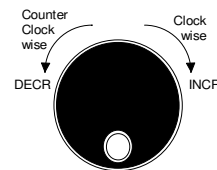
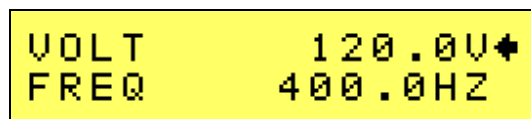

1. Place the cursor on the VOLT entry
2. Rotate the shuttle knob clockwise to increase the value, counterclockwise to decrease the value or use the Keypad to enter a value and press the Enter key.

These changes take effect immediately.

To change the output frequency:

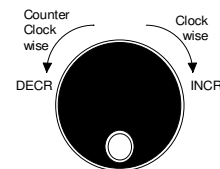
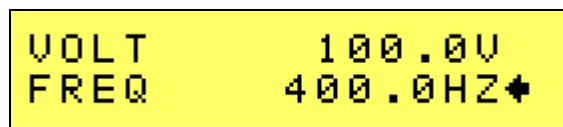

1. Place the cursor on the FREQ entry
2. Rotate the shuttle knob clockwise to increase the value, counterclockwise to decrease the value or use the keypad to enter a value and press the Enter key.

These changes take effect immediately.

4.3.3 Change Output Values in SET Mode

The SET mode of operation is a mode in which changes to output parameters made with the knob or the entry keypad do not affect the output until the **Enter** key is pressed. The AC source is put in this SET mode by pressing the **Set** key twice. A blinking cursor indicates SET mode is active.

To change the output voltage:

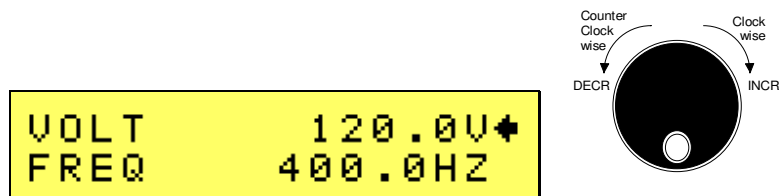

1. Press the **Set** key twice
2. Place the cursor on the VOLT entry
3. Rotate the shuttle knob clockwise to increase the value, counterclockwise to decrease the value or enter a new value using the keypad but do not press the **Enter** key yet.
4. A blinking underline cursor will appear in the data for the VOLT field to indicate a change in settings but the output remains unchanged.
5. Place the cursor on the FREQ entry using the down arrow key.
6. Rotate the shuttle knob clockwise to increase the value, counterclockwise to decrease the value or enter a new value using the keypad but do not press the **Enter** key yet.
7. A blinking underline cursor will appear in the data for the FREQ field to indicate a change in settings but the output remains unchanged.
8. Press the **Enter** key.

Both new voltage and frequency output values are now present at the output.

Note that output settings such as voltage and frequency can be changed from the measurement screen as well. If all three phases are selected on three phase models, slewing the shuttle knob will change the output voltage on all three phases. If only one phase is selected, only the output of the selected phase will be affected.

4.4 Waveform Management

The iX Series employs independent arbitrary waveform generators for each phase. This allows the user to create custom waveforms. In addition, three standard waveforms are always available. This chapter covers issues that relate to defining, downloading and managing custom waveforms.

Note: *i Series models do not support arbitrary waveform generation.*

4.4.1 Standard Waveforms

For most AC applications, a sinusoidal wave shape is used. The sine wave is the standard waveform provided on all i and iX Series models. This standard sine wave is always available and is the default waveform at power-on unless overridden. On iX model power sources, two more standard waveforms are available, square and clipped.

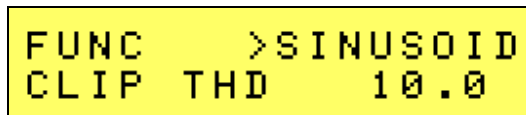

```
FUNC > SINUSOID
CLIP THD 10.0
```

Figure 4-8: Selecting a Waveform

The square wave provides a high frequency content waveform with relative fast rise and fall times. Due to AC amplifier bandwidth limitations, the frequency content of the standard square wave has been kept within the amplifier's capabilities. As the fundamental frequency is increased, the relative contribution of higher harmonics is reduced.

The clipped sine wave may be used to simulate voltage distortion levels to the unit under test. The total harmonic distortion level may be programmed in percent using the CLIP THD field directly below the FUNC entry.

Note that changing the distortion level of the clipped waveform forces the AC source to regenerate the clipped sine wave's data points and reload the waveform register with the newly requested data. This process requires the output to be dropped briefly. To avoid interrupting the voltage output to the unit under test, set the clip level needed before closing the output relay and do not change it while the EUT is under power. You can then toggle between the clipped sine wave and any other waveform in memory without interrupting the output.

4.4.2 Creating Custom Waveforms

The iX controller supports up to 50 user defined waveforms in addition to the 3 standard waveforms. Custom waveforms cannot be created from the front panel of the iX Series. Rather, they have to be downloaded through the IEEE-488, LAN or USB interface.

Each waveform is defined by 1024 data points. Each data point can range between -1 and +1 (floating point number). See the iX Compact Series programming Manual (P/N 6005-961) for details on downloading waveforms.

Once downloaded, waveforms remain in non-volatile memory and will be visible in the WAVEFORMS menu for selection. The user can assign a 12-character name to each custom waveform. Avoid using any of the standard waveform names (SINUSOID, SQUARE or CLIPPED) as these names will not be accepted.

Waveforms may be deleted using the IEEE-488, LAN or USB interface as well. Custom waveforms cannot be deleted from the front panel however to avoid accidental erasure.

4.4.3 RMS Amplitude Restrictions

The output of a sine wave may be programmed to the full rms value of the voltage range selected. If the AC source is in the 300 V range, the maximum programmable rms voltage is 300 Volt. If a custom waveform is used however, the maximum programmable rms voltage may be less than the maximum range value. The voltage range limit is based on the use of a sine wave with a 1.414 crest factor. A 300 V rms sine wave has a 424 Volt peak voltage. The AC source has a maximum peak voltage capability that is determined by the selected voltage range. If the user selects a custom waveform with a crest factor that is higher than 1.414, the peak voltage would exceed this maximum if the rms voltage were to be programmed at 300 V rms.

The iX Series power source automatically limits the maximum allowable programmed rms voltage of any custom waveform by calculating the crest factor of the selected waveform and controlling the rms limit accordingly. Thus, each custom waveform may have a different maximum rms value. The controller will prevent the user from programming the rms voltage above this limit. If a value is entered in the PROGRAM menu above this value, a "Voltage peak error" message is generated.

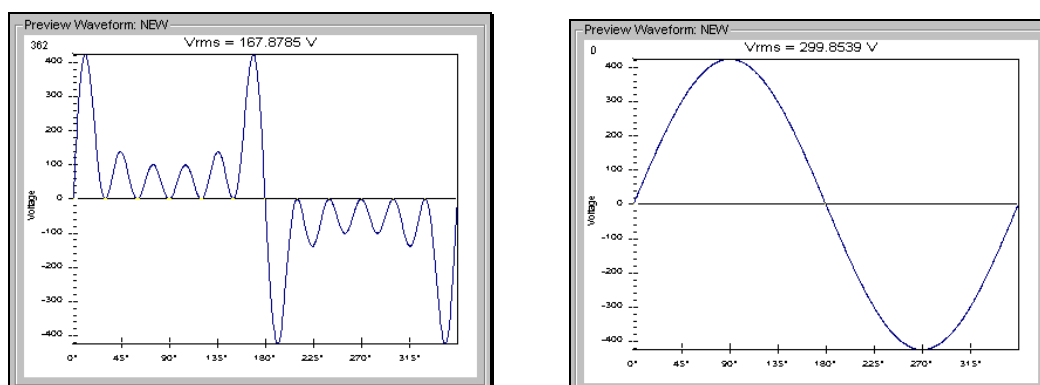

Figure 4-9: Waveform Crest Factor Affects Max. rms Voltage

The figure shown here illustrates the relationship between the crest factor of the wave shape (or its "peakiness") and the maximum peak voltage allowed for a given voltage range. Since the peak voltage cannot exceed the AC source's capabilities, the programmable rms voltage has to be restricted, in this case to only 167.8785 volt for the waveform on the left. The sine wave on the right can be programmed to the full 300 V rms as this still falls within the same peak voltage limitation of the AC source.

If the iX Series is used over the bus, the ":VOLT? MAX" query command can be used to determine the maximum allowable RMS voltage for the selected waveform. Using the returned value as part of a program will prevent range errors.

4.4.4 Frequency Response Restrictions

The user may create a waveform that contains any number of harmonic frequencies of the fundamental. The AC Source itself however has a finite signal bandwidth and will attenuate higher frequency components of the signal. To limit the maximum frequency component of the output signal, the controller automatically applies a band-pass filter to all custom waveforms as they are downloaded. The controller implements the following process for user-defined waveforms:

Each downloaded waveform will have a computed frequency limit that is less than or equal the maximum frequency limit of the AC source. The frequency limit is a function of the harmonics content of the waveform and will follow the equation below.

$$F_{max_n} = F_{max} / (\text{level} * h_n)$$

Where:

F_{max_n} is the maximum allowable fundamental frequency that can be programmed

F_{max} is the upper frequency limit of the power source

Level is the percentage of the harmonic with respect to the fundamental expressed as a fraction (e.g. 10% = 0.1)

h_n is the harmonic number, e.g. h_{11} is the 11th harmonic or $h_n = 11$.

This value F_{max_n} is evaluated for all the harmonic components in the downloaded waveform and the lowest result is assigned as the computed upper fundamental frequency limit that may be used with this specific waveform.

If F_{max} is below the minimum frequency limit, the waveform will be rejected at download time and the label will be deleted from the waveform catalogue.

If the iX Series is used over the bus, the “:FREQ? MAX” query command can be used to determine the maximum allowable fundamental frequency for the selected waveform. Using the returned value as part of a program will prevent range errors.

Limits assume a program of full-scale voltage. No adjustments for voltage setting are made below the full-scale value.

Waveform selection and frequency programming will be subject to the above limit. An error message will be generated to reflect this type of error:

"22,Waveform harmonics limit"

Transient editing will also generate the above error during keyboard entry. Remote transient entry will not check for the error until transient execution.

4.4.5 Switching Waveforms

Waveforms can be switched as part of the transient system. Each transient type setup menu has a FUNC field. This field allows selection of any of the standard or custom waveforms available in waveform memory. Refer to the section on transients for more details on using transient list to switch output waveforms.

4.5 Measurements

Standard measurements are always available through the **MEAS** key on the front panel. These measurements are spread across multiple screens to enhance readability. Switching between these screens can be done by successively pressing the **MEAS** button on the front panel. This will cause the screen to cycle through all available measurement screens.

4.5.1 Basic Measurements

The following three measurement screens are available:

Parameter	
<i>MEASUREMENTS 1</i>	
VOLTAGE	AC rms voltage
CURRENT	AC rms current
FREQUENCY	Frequency
POWER	Real power
<i>MEASUREMENTS 2</i>	
VA POWER	Apparent power
VAR POWER	Peak current
POWER FACT	Power factor
CREST FACT	Crest factor
<i>MEASUREMENTS 3</i>	
VOLT THD	Voltage distortion
CURR THD	Current distortion
PEAK CURR	Instantaneous current found
PHASE	Phase angle (relative to phase A)

Note: The V and I distortion calculations are based on H2 through H50 with the fundamental component (H1) in the denominator. A RMS referenced calculation may be selected by sending the "MEAS:THD:MODE FUND" command over the USB or GPIB interface. See i/iX Series Compact programming manual (CI P/N 6005-961) for details.

Measurements are always running in the background. When the user selects a measurement screen for display, the power source first updates all the measurement parameters before displaying the requested screen. Consequently, pressing the **MEAS** key may not always bring up the selected screen immediately. There will be a perceptible delay. This will prevent the screen from appearing with invalid or blank readouts.

Note that in AC mode, all measurements are AC coupled only so any DC offset will not be reported.

4.5.2 Accuracy Considerations

Any measurement system has a finite accuracy specification. Measurement specifications are listed in Section 2. When using the AC source for measurement purposes, always consider these specifications when interpreting results. Measurement inaccuracies become more pronounced as the signal being measured is at the low end of the measurement range. This is particularly relevant for low current measurements. The iX Series is optimized for providing and measuring load currents up to 15 Arms. When powering very low power loads, measurement inaccuracies on rms and peak current measurements will greatly affect derived measurements such as power, power factor and crest factor.

The measurement system on the i/iX Series uses a digital data acquisition system with a 96 KS/s sampling rate and 48 KHz bandwidth. This means that higher frequency components of the measured signal are filtered out. Any contribution to the rms value of voltage and current above this cutoff

frequency will not be reflected in the i/iX Series measurements. When using an external measurement reference, this may account for discrepancies in readings.

4.6 Harmonic Analysis

The iX Series model controller offers advanced power analyzer measurement capabilities. These functions can be accessed over the bus only except for total harmonic distortion (THD) for voltage and current which are available from the front panel as well.

The iX controller's power analyzer performs fast Fourier transformation (FFT) on both voltage and current on each available phase. The resulting frequency spectrum can be obtained over the bus only.

Note: The i Series does not support this capability.

4.7 Transient Programming

4.7.1 Introduction

Transient programming provides a precise timing control over output voltage and frequency changes. This mode of operation can be used to test a product for susceptibility to common AC line conditions such as surges, sags, brownouts and spikes. By combining transient programming with custom waveforms, virtually any AC condition can be simulated on the output of the AC source.

The default voltage mode is FIXED which means the output voltage is constant and remains at the level set by the user. Changes made to the output voltage made from the PROGRAM menu take effect immediately. In front panel operation mode, the voltage and frequency slew rates (rate of change) are always at their maximum of 2E5 V/s and 2E5 Hz/s. Slew rate programming is only possible over the IEEE-488, LAN or USB bus. On power up, the AC source always reverts to the maximum slew rate for both voltage and frequency.

4.7.2 Using Transient Modes

The voltage can be programmed in the following transient operating modes:

- | | |
|-------|---|
| STEP | Causes the output to permanently change to its triggered value. |
| PULSE | Causes the output to change to its triggered value for a specific time, as determined by the Pulse menu parameters. |
| LIST | Causes the output to sequence through a number of values, as determined by points entered in the List menu. |
| FIXED | Disables transient operation for the selected function. |

4.7.3 Step Transients

Step transients let you specify an alternate or triggered voltage level that the AC source will apply to the output when it receives a trigger. Because the default transient voltage level is zero volts, you must first enter a triggered voltage before you can trigger the AC source to change the output amplitude. Step transients can only be programmed through the bus, not the front panel. Refer to the SCPI Programming Manual for more information about programming Step transients and triggers.

4.7.4 Pulse Transients

Pulse transients let you program the output to a specified value for a predetermined amount of time. At the end of the Pulse transient, the output voltage returns to its previous value. Parameters required to

set up a Pulse transient include the pulse count, pulse period, and pulse duty cycle. An example of a Pulse transient is shown in Figure 4-10. In this case, the count is 4, the pulse period is 16.6 ms or 60 Hz and the duty cycle is 33%.

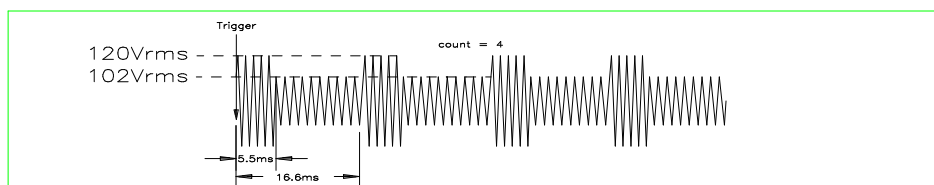

Figure 4-10: Pulse Transients

Note that Pulse transients can only be programmed over the bus, not the front panel. Refer to the SCPI Programming Manual for more information about programming Pulse transients and triggers.

4.7.5 List Transients

List transients provide the most versatile means of controlling the output in a specific manner as they allow a series of parameters to be programmed in a timed sequence. The following figure shows a voltage output generated from a list. The output shown represents three different AC voltage pulses (160 volts for 33 milliseconds, 120 volts for 83 milliseconds, and 80 volts for 150 milliseconds) separated by 67 millisecond, zero volt intervals.

Transient list programming is supported from the front panel and may be accessed by selecting the TRANSIENTS screen. Transient lists can also be programmed over the bus. Refer to the SCPI Programming Manual for more information about programming List transients and triggers over the bus.

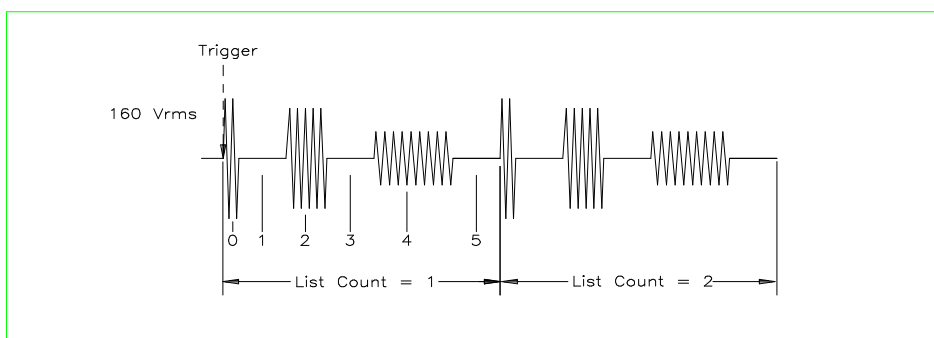

Figure 4-11: List Transients

The list specifies the pulses as three voltage points (point 0, 2, and 4), each with its corresponding dwell point. The intervals are three zero-voltage points (point 1, 3, and 5) of equal intervals. The count parameter causes the list to execute twice when started by a single trigger.

4.7.6 Programming list transients from the front panel

The output transient system allows sequences of programmed voltage and or frequency changes to be executed in a time controlled manner. Changes can be either step changes (maximum slew rate) or ramps (specified slew rates).

The section provides some examples of programming output changes (transients). Transients are defined as a series of numbered steps in a list. The list is executed sequentially. Each step has a number of fields that can be set by the user:

Voltage, Voltage slew rate, Frequency, Frequency slew rate, Current, Function, Dwell time, Trigger out.

The voltage, current and frequency settings are the same as one would do from the setup screen using the shuttle knob or keypad. At each step, the output will be set to the specified voltage, current and/or frequency. The rate of change for voltage and frequency is determined by the slew rate set. Current slew is fixed at MAX and cannot be programmed.

If the voltage is changed from 10 Vac to 20 Vac and the V slew is set to 100 V/sec, the voltage will ramp from 10 to 20 Vac in 100 ms. ($[20 - 10] / 100 = 0.1$ sec). The dwell time is the time the output will remain at this setting. In this example, it should be set long enough to reach the final programmed value of 20 Vac, e.g. it should be at least 0.1 sec. If not, the voltage will never reach the final value of 20 Vac before the next step in the transient list is executed. The dwell time may be set longer than 0.1 sec in this example. If for example the dwell time is set to 1.0 sec, the voltage will ramp from 10 Vac to 20 Vac over a 0.1 sec period and then remain at 20 Vac for 0.9 sec.

Once the dwell time set for a step in the list expires, the next step is entered (if available, if not, execution stops and the output remains at the final values set in the last step of the list.)

Note that while there are parameters for both voltage and frequency level and slew rates, there is only one dwell time, which applies to each step in the transient list.

Front panel entry only supports the LIST mode of operation. For Pulse and Triggered modes, the remote control interface must be used.

When entering transient lists, each list must be entered sequentially starting with step #0. If a list point is not yet set, the step number cannot be increased past it.

The following sample illustrates the use of transient system to program controlled output changes.

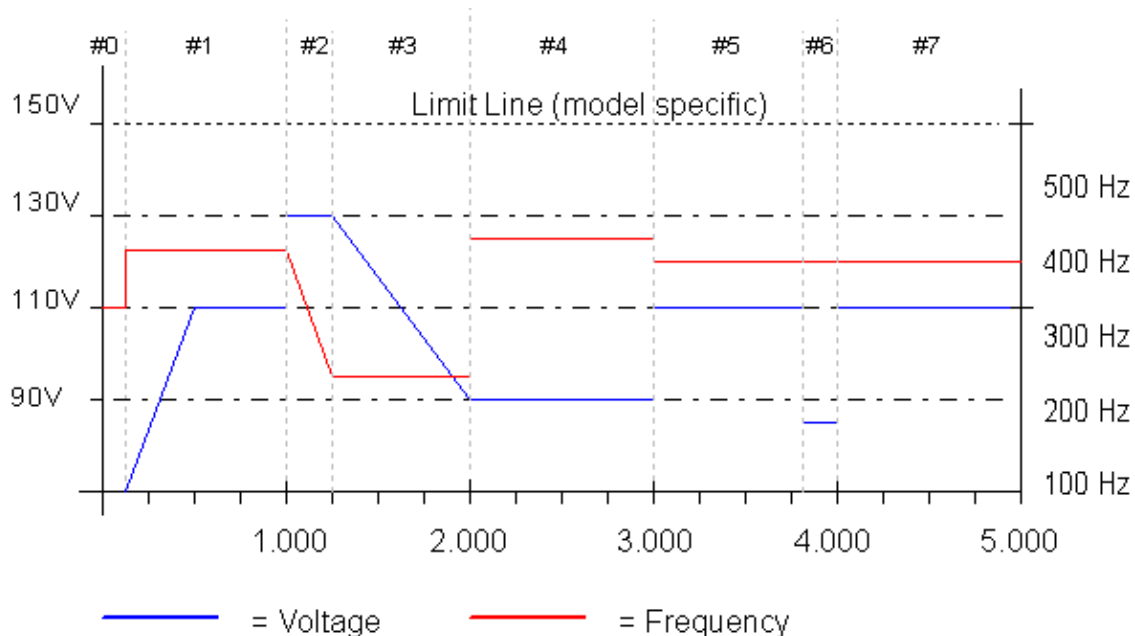

Figure 4-12: Sample Transient Output Sequence

This output can be accomplished using the following transient list.

Step # (data point)	Volt	VSlew	Frequency	FSlew	Dwell
0	70.00	MAX	360.0	MAX	0.100
1	110.00	100.0	440.0	MAX	0.900
2	130.00	MAX	240.0	800.00	0.250
3	90.00	53.3	240.0	MAX	0.750
4	90.00	MAX	460.0	MAX	1.000
5	110.00	MAX	400.0	MAX	0.800
6	88.00	MAX	400.0	MAX	0.200
7	110.00	MAX	400.0	MAX	1.000

Table 4-2: Sample Transient List

4.7.7 Waveforms Function List

The FUNCTION field available in each transient list event setup menu may be used to dynamically switch waveforms during transient execution. This allows different waveforms to be used during transient execution. Waveforms may be switched without the output of the source being turned off. For three phase configurations, each phase has its own waveform list so different waveforms may be programmed on different phases during transient execution.

Figure 4-13 illustrates the concept of using different waveforms at different steps in a transient list. In this case, the change was programmed to occur at the zero crossing. Any phase angle can be used to start the transient execution however. To keep the phase angle synchronization, the dwell times have to be set to an integer number of periods. Over long periods of time, phase synchronization may get lost due to timing skew between the waveform generator and the transient state machine.

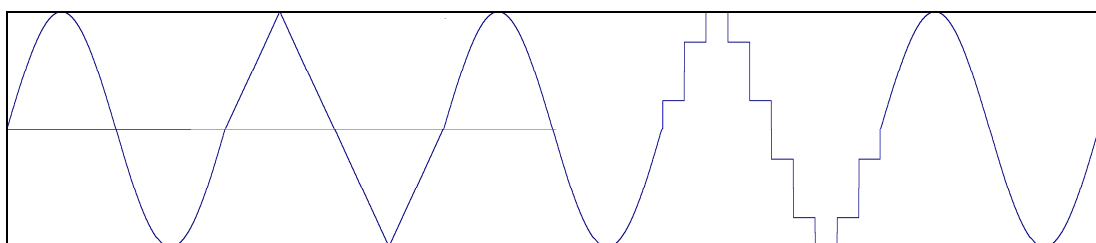

Figure 4-13: Switching Waveforms in a Transient List

4.7.8 Transient Execution

```

TRAN ST      IDLE
COUNT      1

```

Figure 4-14: TRANSIENT Menu

A transient list can be executed from the TRANSIENT menu. To start a transient list, position the cursor on the TRAN ST field as shown in Figure 4-14 and press the ENTER key. Transients may be aborted by pressing the ENTER key again while on the same field as the field changes to ABORT while a transient execution is in progress. For short duration transients, this will likely not be visible, as the transient will complete before the screen is updated. Longer duration transients however may be aborted in this fashion.

4.7.9 Saving Transient List Programs

When the AC source is turned off, the transient list that was programmed is not automatically retained. Thus, if you turn the unit off, you will lose your programmed transient list. However, transient programs may be saved in nonvolatile memory for later recall. This allows multiple transient list programs to be recalled quickly without the need to enter all parameters each time. Transient lists are stored as part of the overall instrument front panel setup in any of the available setup registers.

To save the transient list you created in the previous example, proceed as follows:

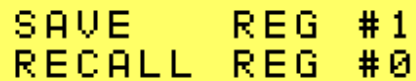

```
SAVE REG #1
RECALL REG #0
```

1. Press the **Menu** key repeatedly until the REGISTERS / CONFIGURATION menu is displayed.
2. Move the cursor to the REGISTERS entry and press the ENTER key.
3. The cursor will default to the SAVE REGISTER # position. Enter a number from 1 through 15 and press the ENTER key. **DO NOT USE REGISTER 0 (REG0)** as it is reserved for power-on setting recall and does not include a transient list.

4.8 Setting the Power-on Initialization Values

The power source is shipped with default factory settings when the unit is powered up. The factory settings are:

Parameter	Factory default setting
Voltage	0.0 Volt
Voltage Range	150 Volt Range
Frequency	60 Hz
Current limit	Maximum available current for selected V Range.
Output state	OFF
Local / Remote State	Local. Front panel unlocked.

Table 4-3: Factory Default Power on Settings

It is possible to change the power on initialization values in one of two ways:

1. Using the IEEE-488, LAN or USB bus interface.
2. Using the front panel.

To change the power on initialization values from the front panel, proceed as follows:

1. Set the AC power source output parameters from the front panel as you want to power up the unit.
2. Save this setting to setup register 0 from the REGISTERS menu.
3. Select the CONFIGURATION menu and move to the POWER ON field.
4. Change the POWER ON field to REG0.
5. This will recall the settings contained in register 0 at power up.

4.9 Remote Inhibit Function

The remote inhibit input available on the high density D-sub 15 connector at the rear panel can be used to disable the output of the AC source. This input takes either a low level TTL signal or a contact closure. The mode of operation can be programmed over the remote control interface using the `OUTP:RI:MODE` command. See 6005-961 programming manual for details.

The following modes are supported.

MODE	OPERATION
LATCHING	A TTL low at the RI input latches the output in the protection shutdown state, which can only be cleared by an <code>OUTPut:PROTection:CLEar</code> command or by manually resetting the output.
LIVE	The output state follows the state of the RI input. A TTL low at the RI input turns the output off; a TTL high turns the output on. This mode is equivalent to using the Output On/Off button on the front panel. Default mode. This mode is active at power up.
OFF	The instrument ignores the RI input.

Table 4-4: Remote Inhibit Modes.

The RI output state is saved as part of an instrument setup using the `REGISTERS` menu. It can be made part of the power on setting if needed. The default state is LIVE.

5. Principle of Operation

5.1 Overall Description

The 2253i/iX models share a common architecture based on single 750VA power amplifier module assembly (P/N 6005-400-1). Power to all amplifier modules is derived from a power factor corrected bias supply PFC module (P/N 6005-707-1 and 6005-709-1). The PFC assembly upconverts the AC input through a high frequency AC transformer that provides full isolation from the line and also accommodates a universal input range from 115V L-N to 230V L-N ac nominal.

The front of the unit houses the digital controller and waveform generator (P/N 6005-703-1) as well as the keyboard display assembly (P/N 6005-703-2). The entire controller front panel assembly (P/N 6005-403-1) can be removed from the main chassis if needed.

5.2 Amplifier Assemblies

The Phase A Amplifier Assembly (P/N 6005-400-1) is located on the right hand side of the chassis. The Phase B amplifier assembly is installed in the center of the chassis and the Phase C amplifier is located on the left hand side (when facing front of the unit). All amplifier assemblies are identical and their positions can be swapped although there is no reason to do so.

The power module contains two independent direct-coupled half-bridge amplifiers. The half bridges may be operated independently (in LO RANGE only, 0 to 150 vac) for two-phase operation but this capability is not used in the 2253i/iX where both half bridges are used for one phase operation only. Each half bridge is rated for 375 VA. One output is taken from OUTPUT LEFT to HV COM OUT and the other output is taken from OUTPUT RIGHT to HV COM OUT.

The half bridges may be operated together for a total of 750 VA. The LEFT amplifier will be the master amplifier and it will drive the RIGHT amplifier.

In LO RANGE the OUTPUT LEFT and RIGHT lines are tied together and drive the load with respect to HV COM OUT.

In HI RANGE (0 to 300 vac) the OUTPUT LEFT and RIGHT lines are separated and the output is taken from OUTPUT LEFT with respect to OUTPUT RIGHT. HV COM OUT is not used in HI RANGE.

5.3 PFC and Rectifier Assembly

The PFC and Rectifier Assembly (P/N 6005-707-1 and 6005-709-1) consists of two modules mounted back to back and connected by a set of heatsinks. It is located on the left hand front side of the chassis below the auxiliary DC bias supply. This module generates six regulated DC buses that provide power to the three amplifier modules.

5.4 EMI Filter Assembly

The EMI Filter Assembly (P/N 4005-710-1) is located in the rear left corner of the chassis. It filters the AC input line and distributes AC power to the input PFC and rectifier assembly and the auxiliary bias DC supply.

5.5 Auxiliary DC bias Supply

An auxiliary bias DC Supply (P/N 6005-711-1) is located on the left side of the chassis above the PFC input assembly.

5.6 Range/Relay Assembly

The Range/Relay Assembly (P/N 6005-712-1) is located in the back of the chassis and contains the required range and output relays. Remote voltage sense and output current monitor circuits are also on this assembly.

5.7 Interface Assembly

The Interface Assembly (P/N 6005-714-1) is located in the back of the chassis and contains several remote control interfaces. An isolated SELV DC supply is used to provide power to the analog and digital interface circuits (USB, RS232, GPIB, LAN, AUX I/O).

5.8 Front Panel Assembly

The Front Panel Assembly (P/N 6005-408-1) consists of the front panel with on/off switch, a CPU board and a keyboard/display board. The controller contains the main oscillator, which generates the sine wave signal setting the frequency, amplitude and current limit level. It also senses the output voltage to provide closed loop control of the output. The controller also handles all user interface and remote control related tasks. The function of each of the two boards that make up the controller assembly is described in the following paragraphs.

5.8.1 Programmable Controller

This board assembly (P/N 6005-713-1) consists of the components for the CPU (DSP), generating the waveform signal to the power amplifier and all program, waveform, and data memory. In addition, this board contains the circuits for all measurements. The clock and lock circuit required to support the clock and lock mode option is also located on this board assembly if this option is installed.

5.8.2 Keyboard / Display Board

The keyboard/display assembly (P/N 6005-703-2) is mounted between the CPU board and the front panel. If the power source is used over one of the remote control interfaces, the keyboard functions can be locked out by asserting the REMOTE state. See the *i/iX Compact Series Programming Manual* (P/N 6005-961) for details.

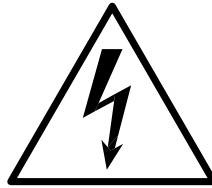

CAUTION

VOLTAGES UP TO 300 VAC AND 500 VDC ARE PRESENT IN CERTAIN SECTIONS OF THIS POWER SOURCE. THIS EQUIPMENT GENERATES POTENTIALLY LETHAL VOLTAGES.



DEATH

ON CONTACT MAY RESULT IF PERSONNEL FAIL TO OBSERVE SAFETY PRECAUTIONS. DO NOT TOUCH ELECTRONIC CIRCUITS WHEN POWER IS APPLIED.

6. Calibration

The Routine Calibration should be performed every 12 months. Non-routine Calibration is only required if a related assembly is replaced or if the periodic calibration is unsuccessful. Calibration of the i/iX system can be performed from the front panel or over the bus. This section covers calibration from the front panel.

6.1 Recommended Calibration Equipment

Digital Multimeter:	Fluke 8506A, 8508 or equivalent.
10 mOhm Current Shunt:	Isotek Model RUG-Z-R010-0.1.
Load Bank:	Various power load resistors or a resistive load bank will be needed. Size of the load bank depends on model. A load is required to perform the current measurement calibration near full scale. Current measurement calibration should be done on the lowest available voltage range. The accuracy and value of the load resistor is not critical as long as the current drawn is sufficient to operate the AC Source in the upper current range (80-100 %). Suggested values of load bank settings are shown in Table 6-1.

6.2 Calibration Screens

The calibration screens for output or measurement calibration can be selected from the **MENU** screen. (Press MENU button several times to toggle to select the CALIBRATION screen.)

To select the CALIBRATION screen press the MENU key several times to select MEAS CAL. Then press the **ENTER** key. This will bring up the PASSWORD screen. To prevent unauthorized access to calibration data, a password must be entered to access any calibration screen. The calibration password is a numeric value equal to the high voltage range limit. This value is 300.

The password can be entered using the shuttle or the keypad. Once the correct value is set, press the **ENTER** key. Once set, the calibration screens remain accessible until the power source is powered down. If you leave the calibration screen and return, toggle the value up or down and back, followed by the **ENTER** key to re-engage the calibration mode.

To select the MEASUREMENT CALIBRATION screen, follow the same steps as outlined above and select the MEAS CAL entry. If another CALIBRATION screen has been accessed since power-up, no password is needed. Otherwise, enter the password as indicated above.

6.3 Measurement Calibration

The i/iX Series controller measures voltage and current by digitizing both voltage and current waveforms on each available output phase. This data is subsequently processed and used to calculate all measurement parameters such as VRMS, IRMS, Power, VA, and Frequency etc. To calibrate all measurements, only the voltage and current measurement need to be calibrated specifically. All other measurements are derived from these.

Connect the test equipment to the power source.

Note: *The Fluke 8506A or 8508 Digital Multi meter (or higher AC accuracy DMM) must be used for the following calibration. The DMM must be set to the AC HI ACCUR mode for all AC measurements.*

The shunt must be connected in series with the load. Connect the load to the output. Use a 10 mOhm current shunt of sufficient power rating in series with the load to measure the AC load current.

To calibrate all measurement functions, the desired value for the measurement value of current or voltage must be entered for the corresponding calibration value. Make the indicated adjustments by typing in the desired display value. This should be the value indicated by the external DVM. If a 10 milliOhm current shunt is used for current, 100 mV represents 10 amps.

The Calibration Load Table shows required load bank settings for the current measurement calibration procedure. The current should be calibrated in the lowest voltage range only. (Highest current range). If only 115VAC input is available, the current can be calibrated using a lower voltage setting (80V) to get the same 6 A current per phase without drawing more than 500W per phase.

PARAMETER		
Model --->	2253i/iX 3 PHS	2253i/iX-MODE 1 PHS
Max current, 115 V, Low Vrange.	19 Ω 700 W	6 Ω 2100 W
Max current, 80 V, Low Vrange (115V AC input)	14 Ω 457 W	5 Ω 1280 W

Table 6-1: Calibration Load Values

6.3.1 Measurement Cal - AC

AC Volt Full-scale:	Turn OFF the ALC mode from the CONTROL menu first. Select the phase to be programmed. Program the output voltage to 300 Vrms on the high voltage range and 400 Hz. Close the output relay. Go to the MEASUREMENT CALIBRATION screen. Enter the actual AC output voltage for the MVOLT FS parameter and press the ENTER key. Note that this calibration process may take up to several minutes to complete. During this time, the measurement display will be shown. Once the cal cycle is completed, the LCD display will revert back to the Calibration screen. To abort the calibration cycle, the BACK key may be used.
AC Current Full-scale:	Select the phase to be programmed. Calibrate the measurement current under a constant current condition (OL MODE set to CC) or a voltage fault may be generated. Apply a load to the output. Program the output to 115 Vrms on the low voltage range and 400 Hz. Observe the actual output current and enter this value for the MCURR FS parameter. Press the ENTER key. Note that this calibration process may take up to several minutes to complete. During this time, the measurement display will be shown. Once the cal cycle is completed, the LCD display will revert back to the Calibration screen. To abort the calibration cycle, the BACK key may be used.

6.4 Non-Routine Output Calibration

The output calibration will not affect the accuracy of the output voltage when the ALC mode is either ON or in REG mode. In these modes of operation, the output voltage accuracy is determined by the voltage measurement accuracy.

The calibration shown in this paragraph will be influenced by the gain of the power amplifier for each phase. The setting of the output calibration coefficients will affect the initial settling time of the ALC mode after power on.

The amplifier gain is set at the factory and the output calibration coefficients are pre-set. There is no need to change the factory default settings unless any of the following conditions occurs:

1. Replacement of the CPU controller board. (CI P/N 6005-703-1)

If the output gains are found to be out of tolerance, they need to be adjusted. This requires removal of the top cover and should only be done by qualified service personnel. In that case, refer to the non-routine calibration section.

The factory output calibration coefficients are shown in the table below.

Output Phase	Output Cal Coefficient
A	2800
B	2800
C	2800

Table 6-2: Output Calibration Coefficients - Factory Defaults.

6.5 Non-Routine Output Offset and Gain Calibration

WARNING: *This requires the top cover to be removed and should be done by qualified service personnel only. Dangerous Voltages are present inside the AC power source.*

First adjust amplifier DC offset as follows:

1. Turn on the front panel power circuit breaker.
2. Program the ALC mode to OFF, output mode to DC function, select Low Voltage range and program 0.0 volts.
3. Use a 100K resistor in series with a 10 uF cap and connect this series network across the output terminals. Connect an external DVM across the cap. Program the DVM to DC.
4. Close the power source output relay and adjust R97 on the Controller (A4) for zero ± 5 mV. See Figure 6-1 for pot location on the controller board.
5. Remove the series resistor and cap.
6. Repeat for phase B and C. Refer to the table below for the relevant adjustment pots in step 2.

To adjust amplifier output gain, proceed as follows:

1. Connect the DVM directly to the output terminals for phase A.
2. Program AC mode, 0.0 volts AC. Adjust R95 on the controller (A4) for the lowest AC output. See Figure 6-1 for pot location on the controller board.
3. Select High Vrange, ALC OFF, 240V and 60 Hz. Go to the OUTP CAL screen and adjust the VOLT FS value for an output of 240 ± 1 VAC.
4. Program 240 VAC and 500 Hz. Check the output is 240 ± 5 VAC. If the output is not correct it indicates an amplifier gain problem.
5. Repeat for phase B and C. Refer to the table below for the relevant adjustment pots in step 2.

Adjustment	Linearity	DC Offset
Phase A	R95	R97
Phase B	R96	R99
Phase C	R98	R100

Table 6-3: Adjustment pot reference by phase.

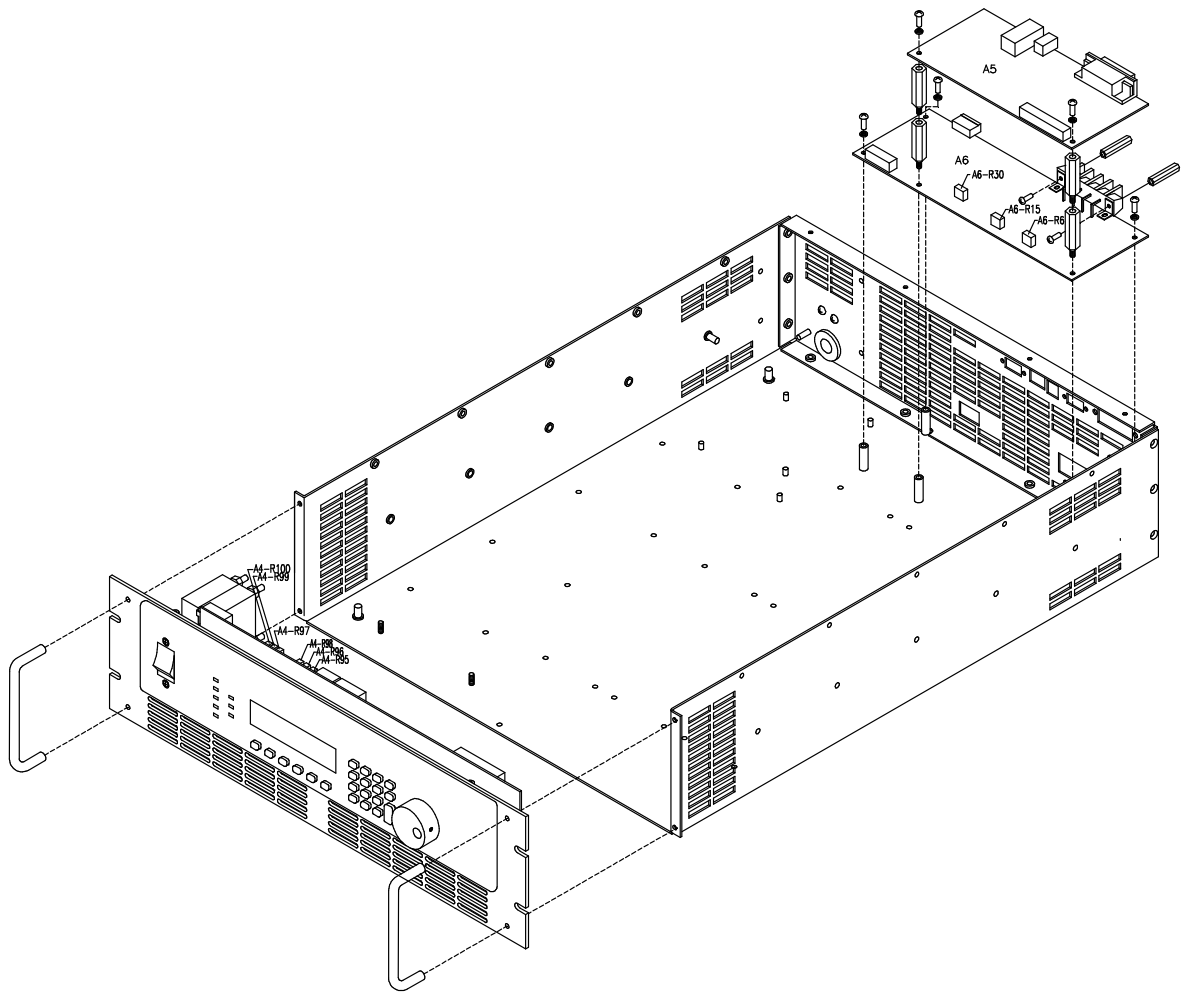

Figure 6-1: Internal adjustment locations.

7. Service

7.1 Cleaning

The exterior of the power source may be cleaned with a cloth dampened with a mild detergent and wrung out. Disconnect mains power to the source before cleaning. Do not spray water or other cleaning agents directly on the power source.

7.2 General

This section describes the suggested maintenance and troubleshooting procedures. The troubleshooting procedure is divided into two sections. The first section deals with basic operation and connection of the equipment. The second section requires opening the unit and using LED indicators and a simple multimeter to troubleshoot the unit down to the module level. Only a qualified electronic technician should attempt this level of troubleshooting.

7.3 Basic operation

PARAGRAPH	PROBLEM
7.3.1	Excessive Output Voltage
7.3.2	Poor Output Voltage Regulation
7.3.3	Overcurrent Light On
7.3.4	Distorted Output
7.3.5	No Output and no lights on front panel
7.3.6	No output, but front panel controller is active.

7.3.1 Excessive Output Voltage

CAUSE	SOLUTION
External sense not connected(If used)	Connect external sense wires on the rear panel from TB1 to TB2. DO NOT MIX UP PHASE ORDER.
External sense reversed (If used)	Verify the output A connects to sense A input, B to B, C to C and N to N.

7.3.2 Poor Output Voltage Regulation

CAUSE	SOLUTION
Unit is overloaded	Remove overload
Unit is programmed to wrong voltage range.	Select correct voltage range.
Input line has fallen below spec. limit.	Check input supply voltage.
Internal sense mode.	Connect external sense wires to load and select external sense mode.

7.3.3 Overload Light is On

CAUSE	SOLUTION
Unit is overloaded	Remove overload or check CL setting
Unit is switched to high voltage range.	Select correct voltage range.

7.3.4 Distorted Output

CAUSE	SOLUTION
Power source is grossly overloaded.	Reduce load
The crest factor of the load exceeds 3:1.	Reduce load current peaks by reducing load.

7.3.5 No Output and No Lights on Front Panel

CAUSE	SOLUTION
Input switched off.	Switch unit on.
No input power.	Ensure power is present at AC input terminal block.
Incorrect input voltage	Voltage applied to a unit is outside of allowable input voltage range. Check model number tag on unit for required input voltage.

7.3.6 No Output But Front Panel controller is active

CAUSE	SOLUTION
"OUTPUT ON" button is turned off.	Press OUTPUT ON so that "ON" LED is lit.
Current limit programmed down or to zero.	Program current limit higher.
Voltage programmed down or to zero.	Turn amplitude control up.

7.4 Self test

An internal self-test can be performed over the bus by sending the *TST? query command. The self-test will run until the first error is encountered and terminate. The response to the query will either be the first error encountered or 0 if no error was found (Self-test passed).

To execute a self-test, the IEEE-488, LAN, RS232 or USB interface must be used. The iXCGui command self-test window can be used to send the *TST? Command. See the section 9 for possible self test error codes and messages.

Note that the internal selftest is more comprehensive than the power on memory test that always runs when the unit is turned on. The memory test only checks the integrity of the controller and its non-volatile memory content. The self test runs an actual power test on all amplifiers.

7.5 Advanced Troubleshooting.



CAUTION: *VOLTAGES UP TO 230 VAC AND 500 VDC ARE PRESENT IN CERTAIN SECTIONS OF THIS POWER SOURCE.*



WARNING: *THIS EQUIPMENT GENERATES POTENTIALLY LETHAL VOLTAGES. DEATH ON CONTACT MAY RESULT IF PERSONNEL FAIL TO OBSERVE SAFETY PRECAUTIONS. DO NOT TOUCH ELECTRONIC CIRCUITS WHEN POWER IS APPLIED*

Switch Off Units

Switch off each unit at the circuit breaker on the front panel as well as removing the input power from the unit.



WARNING: *Wait 10 minutes for all internal capacitors to discharge.*

Removing Cover

Remove the screws securing the top cover and remove it.

Initial Inspection

Make a visual inspection of the unit and ensure all the connectors are properly mated and there are no loose wires.

7.6 Amplifier Module Data

This section lists the various connectors and interface pin outs to the 6005-400-1 amplifier module.

7.6.1 CONTROL BOARD

7.6.1.1 J1 - LV POWER

PINS	NAME	DESCRIPTION
1,2,3	+24V_FAN	+12.0 Vdc to +24.0 Vdc @ 200 mAdc for module fan. Voltage is externally controlled according to output current.
4,5,6	FAN_COM	Return for +24V_FAN
7,8	+15G	+15 Vdc +/- 0.5Vdc @ 450 mAdc for gate drive
9,10	G_COM	Return for +15G
11,12	+15LV	+15 Vdc +/- 0.5Vdc @ 150 mAdc for control circuits
13,14	LV_COM	Return for +15LV and -15LV
15,16	-15_LV	-15Vdc +/-0.5Vdc @ 100 mAdc for control circuits

7.6.1.2 J5 - FAN

PINS	NAME	DESCRIPTION
1	FAN_COM	Return for fan
2	+24V_FAN	DC voltage for fan

7.6.1.3 J6 - E/A IN/OUT

PINS	NAME	DESCRIPTION
1	E/A_COM	Return for E/A IN/OUT
2	E/A_IN/OUT	Error amplifier signal from master module to parallel auxiliary modules

7.6.1.4 J2 - CONTROL SIGNALS

PINS	NAME	DESCRIPTION
1	A_COM	Analog common
2	A_SIG_HI	Phase A oscillator signal, 16 Hz to 1 kHz, 0 – 5.3 Vac
3	B_SIG_HI	Phase B oscillator signal, values same as A_SIG_HI
4	C_SIG_HI	Phase C oscillator signal, values same as A_SIG_HI
5	SCOM	Signal common for A/B/C_SIG_HI
6	DCOM	Digital logic common
7	LO_RNG	Low Range control signal, input to module, TTL LO = Low Voltage Range, TTL HI = High Voltage Range
8	/AMP_FLT	Amplifier fault indicator signal, output from module, open collector, LO = blown fuse fault detected, HI = normal
9	PARALLEL	One phase (parallel) / Three phase mode control signal, LO = three phase mode, HI = one phase mode.
10	/OVT	Overtemperature fault indicator signal, output from module, open collector, LO = Over temp fault detected, HI = normal

7.6.2 POWER BOARD

7.6.2.1 HIGH VOLTAGE DC INPUT

PINS	NAME	DESCRIPTION
E1	+250V_IN	+250 Vdc @ <5 Adc, must be able to sink current from module
E2	HV_COM_IN	Return for +/- 250V_IN
E3	-250V_IN	-250 Vdc @ <5 Adc, must be able to sink current from module

7.6.2.2 HIGH VOLTAGE OUTPUT

PINS	NAME	DESCRIPTION
E4	HV_COM_OUT	Return for E5 and E6
E5	OUTPUT_LEFT	0 – 150 Vac, 375 VA max from 120 Vac to 150 Vac, 3.13 Arms max
E6	OUTPUT_RIGHT	Same as for E5

7.6.3 CONFIGURATION

The module may be configured to operate as two independent 375 VA LO RANGE half bridges or as a single 750 VA dual range half/full bridge. Because DIP switches are used to set the operation of each power module, configuration may only be performed manually.

Note: *Unless a module was exchanged in the field, the i/iX comes factory configured for the correct mode of operation and these dip-switch settings should normally not have to be changed. This information is provided for reference only. Only factory authorized personnel should use this information if needed.*

7.6.3.1 DIP SWITCH SETTINGS

DIP SWITCH S1

DIP switch S1 selects which oscillator phase will drive each half bridge.

DIP SWITCH POSITION	NAME	FUNCTION
1	LA	ON for LEFT = Phase A (LB, LC must be OFF)
2	RA	ON for RIGHT = Phase A (RB, RC must be OFF)
3	LB	ON for LEFT = Phase B (LA, LC must be OFF)
4	RB	ON for RIGHT = Phase B (RA, RC must be OFF)
5	LC	ON for LEFT = Phase C (LA, LB must be OFF)
6	RC	ON for RIGHT = Phase C (RA, RB must be OFF)

DIP SWITCH S2 – 2 Positions

For 6005-701-1 control board (Assy rev H or higher) DIP switch S2 configures the source of the error amplifier drive signal for single or three phase mode.

DIP SWITCH POSITION	NAME	FUNCTION
1	IL	ON to connect error amplifier signal to the master error amplifier signal. This switch must be ON for any single module system, or if the module is a master in a multiple module system. This switch must be OFF if the LEFT amplifier of the module is auxiliary to a

DIP SWITCH POSITION	NAME	FUNCTION
		different master.
2	IC	ON to connect common of module's LEFT amplifier as the master common signal. This switch must be ON for any single module system. This switch must be OFF if the LEFT amplifier of the module is auxiliary to a different master.

DIP SWITCH S3

DIP switch S3 selects whether the RIGHT amplifier of the module is independent or auxiliary to a different master.

DIP SWITCH POSITION	NAME	FUNCTION
1	MRR	ON = MasterRight. This switch must be ON for RIGHT amplifier to be it's own master. This switch must be OFF if RIGHT amplifier is auxiliary to another master.
2	SLR	ON = SlaveRight. This switch must be ON for RIGHT amplifier to be an auxiliary (slave). This switch must be OFF if RIGHT amplifier is it's own master.

7.7 Factory Assistance

If the problem with the cabinet or one of the power modules cannot be isolated, contact the factory for assistance.

7.8 Fuses

See Table 7-1 for replaceable fuses and ratings for each of the sub assemblies in the i/iX model power source.

7.9 Replaceable Parts

In order to ensure prompt, accurate service, please provide the following information, when applicable for each replacement part ordered.

- Model number and serial number of the instrument.
- Part number for the sub-assembly where the component is located. (AMETEK Programmable Power PART #)
- Component reference designator if applicable (REF #)
- Component description.
- Component manufacturers (VENDOR)

All replaceable part orders should be addressed to:

AMETEK Programmable Power, Inc. – San Diego
 9250 Brown Deer Road
 San Diego, CA 92121
 Phone: 858-450-0085
 Toll Free: 800-733-5427

Orders may also be placed using the following fax number: 1 858-458-0267 or via email: support@programmablepower.com

REF #	Sub	CI PART #	DESCRIPTION	MNF, P/N	QTY
Common Assemblies					
	Top	6005-405	Top Assembly		
	CB1		AC Circuit Breaker, 20A, 250V	Airpax: IELXK11-1-62-20.0-A-02-V	1
	B4	241184	Fan, 4", 24VDC	NMB TECHNOLOGIES 4715KL-05W-B30	1
	T1	6005-020-1	HF Transformer	CI	1
	L1	6005-019-1	PFC Inductor	CI	1
	L2	6005-021-1	Rectifier Inductor	CI	1
A3		6005-702-2	Keyboard / Display Assembly	CI	1
A4		6005-713-1	Controller Assembly	CI	1
A5		6005-714-1	Interface Assembly	CI	
A6		6005-712-1	Relay/Output Assembly	CI	
A7		6005-709-1	Rectifier Assembly	CI	
A8		6005-707-1	HV Power Supply Assembly	CI	
	F1	270151	FUSE, 10A, 250V	BUSSMANN, ABC-10-R	1
	F2	270227	FUSE, 20A, 600V	LITTELFUSE, KLK-20	1
A9		6005-711-1	Low Voltage Bias Supply Assembly	CI	
	F1	270245	Fuse, 1A, 250V, Slo, Metric	Bussmann GDC-1A Littlefuse 218-001	1
A10		4005-710-1	EMI Filter	CI	
A11		6005-400-1	Power Module Assembly	CI	1

REF #	Sub	CI PART #	DESCRIPTION	MNF, P/N	QTY
	A1	6005-700-1	Amplifier Power Board	CI	1
	F1, F2	270238	Fuse, 5A, 250V	Bussmann, GDA-5 Littlefuse, 216 005	2
	A2	6005-701-1	Amplifier Control Board	CI	1
	B1	241186	Fan, 3", 24Vdc	Comair, CR0824HB-A70GL Nidec, M33411-16	1
A12		6005-400-1	Power Module Assembly	CI	0 or 1
	A1	6005-700-1	Amplifier Power Board	CI	1
	F1, F2	270238	Fuse, 5A, 250V	Bussmann, GDA-5 Littlefuse, 216 005	2
	A2	6005-701-1	Amplifier Control Board	CI	1
	B2	241186	Fan, 3", 24Vdc	Comair, CR0824HB-A70GL Nidec, M33411-16	1
A13		6005-400-1	Power Module Assembly	CI	0 or 1
	A1	6005-700-1	Amplifier Power Board	CI	1
	F1, F2	270238	Fuse, 5A, 250V	Bussmann, GDA-5 Littlefuse, 216 005	2
	A2	6005-701-1	Amplifier Control Board	CI	1
	B2	241186	Fan, 3", 24Vdc	Comair, CR0824HB-A70GL Nidec, M33411-16	1

Table 7-1: Replaceable Parts and Assemblies

8. Miscellaneous Options

8.1 IEEE488 Interface (-GPIB)

The GPIB interface is available on all iX Series models. It is also available as a factory installed option on the “i” Series. The operation of the GPIB interface is the same on both “i” and “iX” series models.

For details on operation of the GPIB interface and programming command syntax, refer to the i/iX Compact Series Programming manual, CI P/N 6005-961 provided in PDF format on CD ROM CIC496.

8.2 Atlas Based Language Extensions (-ABL)

All Compact i/iX series model support the IEEE SCPI (Standard Commands for Programmable Instruments) command language syntax for programming over the bus. (USB, GPIB or LAN). The – ABL option provides backward compatibility with programs written for certain older products from other manufacturers.

For details on use the Atlas style syntax, refer to the i/iX Compact Series Programming manual, CI P/N 6005-961 provided in PDF format on CD ROM CIC496.

8.3 External Sync (-EXS)

If installed, this option reassigns the External Trigger input on DB15 (J18) to act as an external sync input. A TTL logic level square wave signal is required to act as a sync reference. The output frequency will track the sync signal when the power source is set to external sync mode. Refer to the CONTROL menu for setting information. Section 4.2.5.

8.4 External Input (-EXT)

The -EXT option is factory installed only. If installed, this option disables the internal controller waveform generation, voltage, current limit and frequency programming as well as output relay control. Instead, a user provided AC signal is used to drive each amplifier. A 0 to 5 Vrms AC signal will provide a 0 to 300 Voltage output on the 300V AC range. The 150V AC range is not available on EXT models. If the input signal exceeds ± 7.5 Vpk on the 300 V range or ± 3.75 Vpk, the output waveform will start to clip (flat top) so the rms level of the output is limited by the crest factor of the external input signal(s).

The presence of the EXT option is indicated by the -EXT field in the model number on the serial tag. Note that the -EXT and -RPV options are mutually exclusive so only one or the other can be present.

8.4.1 Important EXT Option Considerations

Input signal range: Since the controller has no control over the output voltage and frequency, it is important not to exceed the available voltage and frequency output range of the amplifier. The amplifiers are used in an open loop mode so no ALC mode is available to improve load regulation. For supplementary specification for -EXT operation, refer to section 2.9.

Output Relay: Since the power source does not control the amplifier drive signal, the output relay control button (OUTPUT ON/OFF) has been disabled leaving the output relay in the CLOSED state at all times. This ensures the output relays cannot be switched hot. To turn "off" the output, the external input signal must be set to 0V.

Turn on requirements: When turning on the power source, it is recommended to make sure the EXT input signal(s) is/are 0V or disconnected to prevent irregular output from occurring.

Also, to ensure the power on measurement zero calibration that occurs any time the power source is turned on operates correctly, it is necessary to disconnect the external signal inputs or make sure they are at 0Vrms with no DC offset present and disconnect any load if possible. If not, the measurements displayed by the power source may not be correct.

Measurements: Measurement functions of the controller are available even on EXT configured units but frequency measurements at very low AC output voltages (< 10Vrms) are not accurate.

Note: *To use the EXT mode, the above guidelines must be followed.*

8.4.2 Connections

The RPVA, EXTB and EXTC inputs on the Auxiliary I/O connector are used to connect the external input signals if the -EXT option is installed. The RPVA input is used if the RPV option is installed instead. A suitable 15 pin DB15H high density mating connector is provided in the ship kit and can be used to connect the external oscillator signals. See Table 3-6: DB15 Auxiliary I/O Connector for pin out information.

8.4.3 Front Panel Setup

Power sources configured with the EXT option always operate in external signal input mode on the 300V AC range. That means no voltage, frequency, current limit or output on/off programming is available using the front panel or the bus.

The VOLT REF setting in the CONTROL menu is fixed. Refer to the CONTROL menu for setting information. Section 4.2.5.

8.5 RPV Input (-RPV)

The –RPV option is factory installed only. If installed, this option disables the internal controller voltage programming reference. Instead, a user provided DC signal is used to drive all amplifiers. Note that only one RPV input is available so in three phase modes, all three outputs will track the same RPV DC input signal.

A 0 to 10 VDC signal will provide a 0 to full-scale voltage output on the selected voltage range.

To enable the RPV mode, press the MENU key until the CONTROL screen and scroll to the ALC setting entry. If the ALC is set to REG or ON, turn it OFF first. Then scroll to the VOLT REF entry. Select EXT to use the RPV (remote programming voltage).

The presence of the RPV option is indicated by the –PRV field in the model number on the serial tag. Note that the –EXT and –RPV options are mutually exclusive so only one or the other can be present.

8.6 Ethernet Interface (-LAN)

The Ethernet interface is available as a factory installed option on the Compact iX Series models.

For details on operation of the Ethernet interface and programming command syntax, refer to the i/iX Compact Series Programming manual, CI P/N 6005-961 provided in PDF format on CD ROM CIC496.

8.7 Clock and Lock (-LKM / -LKS)

The –LKM and –LKS options are available on the iX Series AC power source models. This option allows one or more auxiliary unit outputs to be phase synchronized to a master iX unit.

Note: *The output of any units that are locked together CANNOT be paralleled to obtain more current.*

The Clock and Lock mode is provided for the creation of multi-phase systems.

For connection and operation information of the Clock and Lock mode, refer to section 3.9 of this user manual.

8.8 Rack Mount Slides (-RMS)

For mounting the 2253i/iX in a 19-inch instrument cabinet, it is recommended to use the -RMS rack mount slides kit to provide adequate support for the power source weight. This allows the unit to be pulled forward for servicing as well. When using a cabinet not supplied by AMETEK Programmable Power, contact the cabinet vendor for shelf or bracket accessories designed to support the weight of an instrument.

The rack mount slide mounting holes centerlines on the side of the power source are 2.30 inches / 58.4 mm above the bottom edge of the front panel.

Note: *The 2253i/iX series models cannot be mounted in a cabinet by just using the front panel rack ears. They require additional support.*

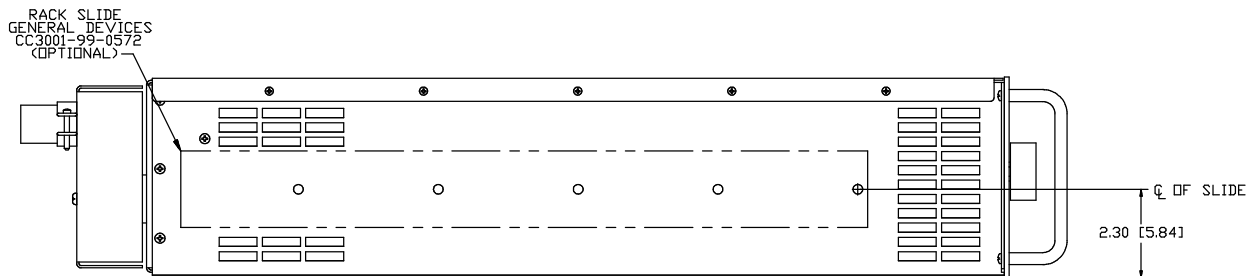

Figure 8-1: Rack Mount Slides (-RMS option) position

9. Option -160: RTCA / DO-160 Rev D, E

9.1 General

Option -160 includes a firmware implementation for RTCA/DO160 revision D including change 2, section 16. For testing to revision E, the GUI based software implementation is available. The software based avionics tests (DO160 Rev E) are covered by a separate Avionics Software Manual, CI P/N 4994-971, which is distributed on the same CD as this manual.

This user manual assumes that the user is familiar with the text of the relevant DO160, section 16 test standard. No attempt is made to explain or elaborate on the actual test specification.

The RTCA/DO-160D option is capable of performing most sub-sections of RTCA/DO-160D, Section 16, RTCA/DO-160D change No2 and EUROCAE-14D / RTCA DO160D, Section 16 for the AC Source signal. A selection is made available to specify the type of standard to be applied to the EUT and the available EUT groups.

Throughout this document, RTCA/DO-160D change No2 will be referred to as RTCA2. Groups 1 through 3 will be used to refer to the EUROCAE-14D standard. Category A(CF), A(NF) and A(WF) will be used to refer to the RTCA2 standard.

9.2 Initial Setup

Nominal parameters for the AC Power source are as follows:

Output Voltage	115V L-N or 230V L-N.
Output Frequency	360 Hz to 800 Hz

Nominal parameters for the DC Power source are as follows:

Output Voltage	28V or 14V L-N
----------------	----------------

Note: *A setting outside these nominal values will disable the test and will prevent access to the DO160 Menu screens.*

The Compact i/iX Series has a maximum voltage range for 300Vrms. Consequently, not all tests for 230VAC nominal input voltage EUT's can be performed.

9.3 Available DO160 Tests

9.3.1 NORMAL STATE

AC Mode:

1. Normal State Voltage and Frequency test
2. Voltage unbalance test
3. Waveform Distortion test
4. Voltage Modulation test
5. Frequency Modulation test
6. Momentary Power Interrupt (Under voltage) test
7. Voltage Surge (Over voltage) test
8. Frequency Transients test (Group 1 only)
Frequency Variation test (Group 2 and 3 only)

DC Mode:

1. Normal State Voltage test
2. Momentary Power Interrupt (Undervoltage) test
3. Voltage Surge and Under

9.3.2 EMERGENCY TEST

AC Mode:

1. Emergency Voltage and Frequency minimum
2. Emergency Voltage and Frequency maximum
3. Voltage unbalance

DC Mode:

1. Emergency Voltage

9.3.3 ABNORMAL TEST

AC Mode:

1. Abnormal Voltage minimum
2. Abnormal Voltage maximum
3. Voltage Drop
4. Voltage Surge
5. Frequency Transients test (group 1 only)

DC Mode:

1. Abnormal Voltage minimum
2. Abnormal Voltage maximum
3. Abnormal Voltage low
4. Voltage Drop

5. Voltage Surge

9.4 Front Panel Operation -160

To perform a test from the keyboard, Press the MENU key several times until the APPLICATIONS/OPTIONS Menu appears, select the APPLICATIONS screen. The APPLICATIONS screen will appear as shown in Figure 9-1.

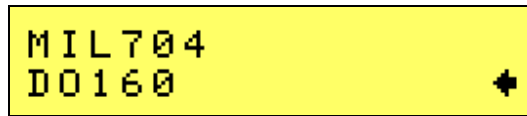

```
MIL704
DO160
```

Figure 9-1: Application Menu

Scroll to the RTCA/DO-160D entry using the up and down cursor keys. Press the ENTER key to select the RTCA/DO 160D main menu. The screen will appear as shown in Figure 9-2.

Note: *The user has to turn on the Output relay before starting a test.*

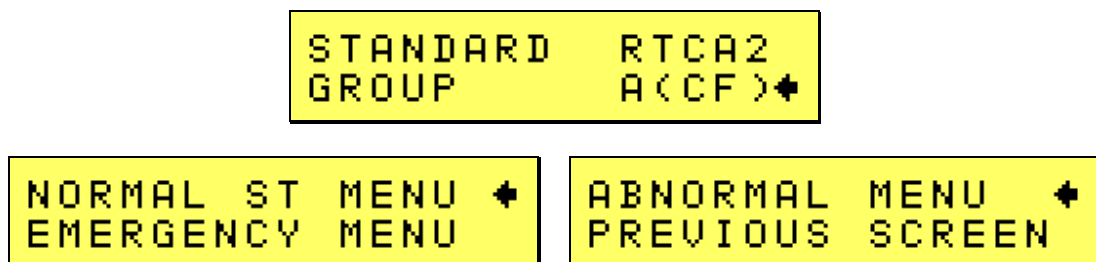

```
STANDARD    RTCA2
GROUP       A(CF)
```

```
NORMAL ST MENU
EMERGENCY MENU
```

```
ABNORMAL MENU
PREVIOUS SCREEN
```

Figure 9-2: DO160 Main Menus

Prior to executing a test, selection of the desired test standard and group is required. Use the shuttle to select the standard and the group if applicable.

9.5 AC Test Mode

Following sections cover testing in AC output mode.

9.5.1 Normal State tests

Scroll to the NORMAL STATE entry using the up and down cursor keys. Press the ENTER key to select the NORMAL STATE screens. The screen will appear as shown in Figure 9-3.

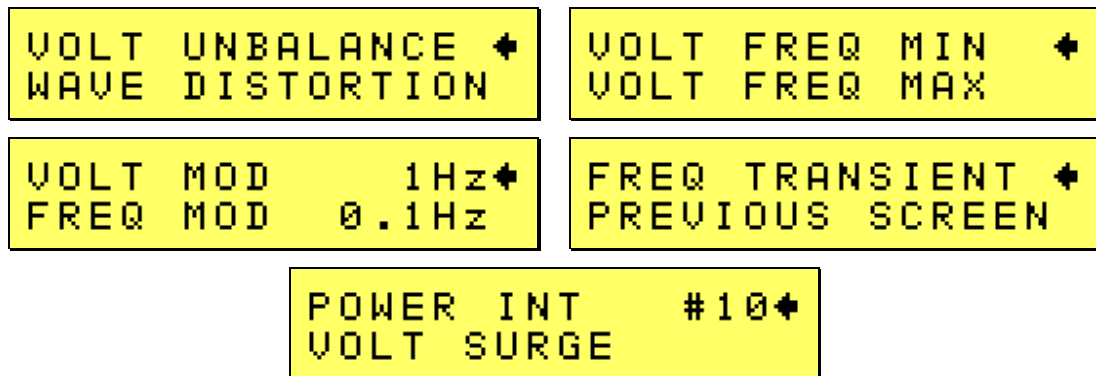

Figure 9-3: Normal state screens

The DO160 NORMAL screens have the following tests:

- 1 VOLT FREQ MIN
- 2 VOLT FREQ MAX
- 3 VOLT UNBALANCE
- 4 WAVEFORM DISTORTION
- 5 VOLT MODULATION
- 6 FREQ MODULATION
- 7 POWER INTERRUPT
- 8 VOLTAGE SURGE
- 9 FREQ TRANSIENT (group 1/A(CF))
FREQ VARIATION (group 2 & 3/A(NF) & A(WF))

The above tests can be selected by scrolling to the highlighted selection using the up and down key and the ENTER key to start the selected test. For some of these tests, numeric data entry may be required to define the test number or the modulation rate.

VOLT FREQ MIN

Standard/Group		RTCA	A(CF)	A(NF)	A(WF)
Voltage	1	100	100	100	100
	3	101.5	101.5	101.5	101.5
Frequency		380	390	360	360

Standard/Group		Group1	Group2	Group3
Voltage	1	104	104	104
	3	105.5	105.5	105.5
Frequency		390	360	360

Table 9-1: Normal Voltage and Frequency minimum

Standard/Group		RTCA	A(CF)	A(NF)	A(WF)
Voltage	1	122	122	122	122
	3	120.5	120.5	120.5	120.5
Frequency		420	410	650	800

Standard/Group		Group1	Group2	Group3
Voltage	1	122	122	122
	3	120.5	120.5	120.5
Frequency		410	650	800

Table 9-2: Normal Voltage and Frequency Maximum

This test will set the voltage and frequency to levels defined by Table 9-1. The test will last for 30 minutes. The test will be repeated, except group1, using the Voltage setting from Table 9-2 and the frequency from Table 9-1. The ← key (backspace) will terminate the test at any time.

VOLT FREQ MAX

This test will set the voltage and frequency to levels defined by Table 9-1. The test will last for 30 minutes. The test will be repeated, except group1, using the Voltage setting from Table 9-1 and the frequency from Table 9-2. The unselected phases will remain at 115 volts. The BACK key (backspace) will terminate the test at any time.

VOLT UNBALANCE

Standard/Group	RTCA	A(CF)	A(NF)	A(WF)
Voltage offset	6	6	6	8
Frequency	400	390/410	360/650	360/800

Standard/Group	Group1	Group2	Group3
Voltage offset	6	6	9
Frequency	400	360/650	360/800

Table 9-3: Normal Voltage Unbalance

This test will change the output voltage for phase A and B to 122V and phase C to a voltage lower by a value specified by an offset. Refer to Table 9-3 for the offset value and the Frequency. The test will repeat with the same frequency and phase A and B volt is set to 100V and phase C set to a higher voltage specified by the offset value. The test will last 30 minutes. The test will be repeated for a second Frequency if applicable. The test can be terminated at any time. The BACK key will terminate the test at any time.

WAVEFORM DISTORTION

This test will generate a 5% THD voltage distortion on the output voltage waveform at the nominal voltage set. (115 V or 230 V) A clipped sine wave generates the required distortion. The test will last for 30 minutes. The ← key (backspace) will terminate the test at any time.

VOLTAGE MODULATION

This test requires a numeric value entry equal to the modulation rate in Hz. This entry value must be between 1 Hz and 200 Hz. The amplitude modulation is calculated based on the modulation rate as defined in Figure 9-4. This test will last for 2 minutes.

Note that the Airbus voltage modulation test levels are specified in peak to peak voltage instead of Vrms. Table 9-4 shows the levels for the Airbus mode versus the DO160 and EUROCAE modes as implemented in the DO160 firmware. The actual requirement for Airbus ABD0100.8 is now specified in Vpeak peak instead of Vrms so the Airbus mode should not be used. Use the DO160 or EURO/CAE mode instead or use the -ABD option (See Section 11).

Modulation Frequency (Hz)	DO160 / EUROCAE	Modulation Frequency (Hz)	AIRBUS
	Volt RMS		Volt RMS
1	0.18	1	0.5
1.7	0.18	1.7	0.5
10	1.24	10	3.5
25	1.24	25	3.5
70	0.18	70	0.5
100	0.18	100	0.5
200	0.18	N/A	N/A

Table 9-4: Airbus mode voltage modulation.

Note: Voltage modulation levels change linearly from frequency 1.7Hz to 10Hz and again from 25Hz to 75Hz. See Figure 9-4.

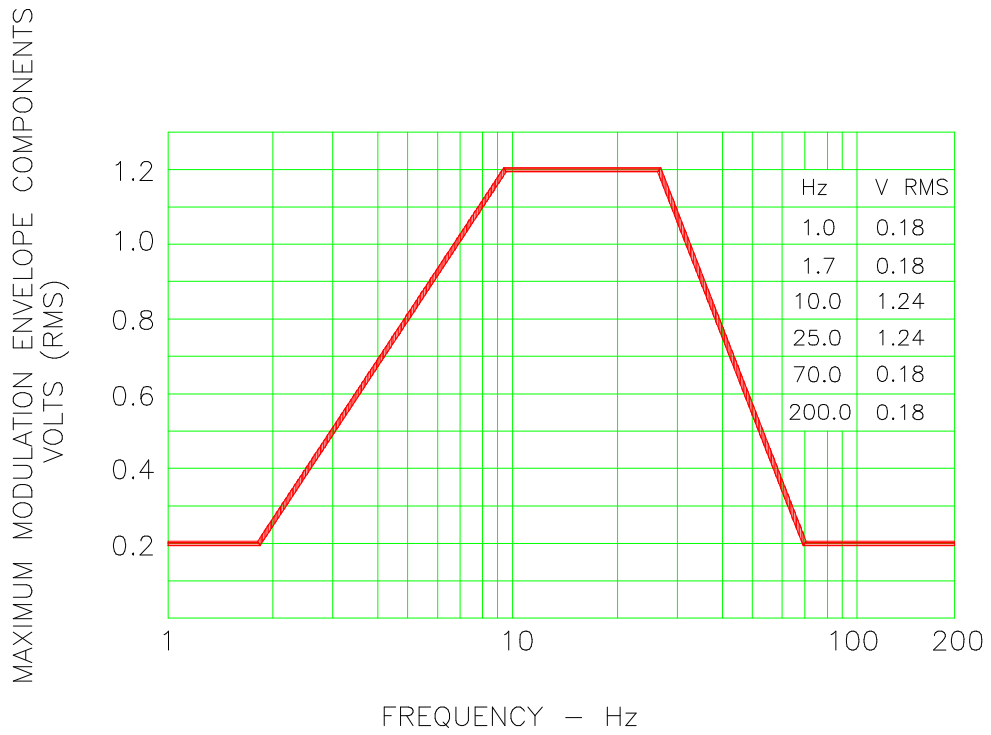

Figure 9-4: Voltage Modulation - Frequency characteristics

FREQUENCY MODULATION

This test requires a numeric value equal to the modulation rate in Hz. This value must be between 0.01 Hz and 100 Hz. The frequency modulation is calculated based on the modulation rate as defined in Figure 9-5. This test will last for a minimum of 2 minutes.

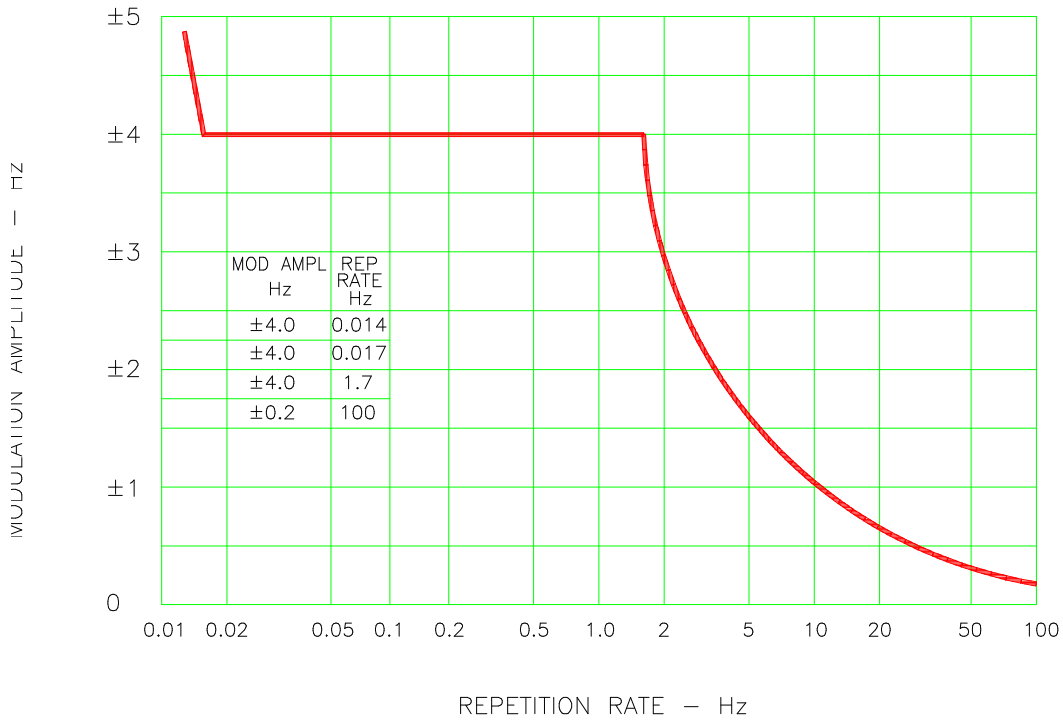
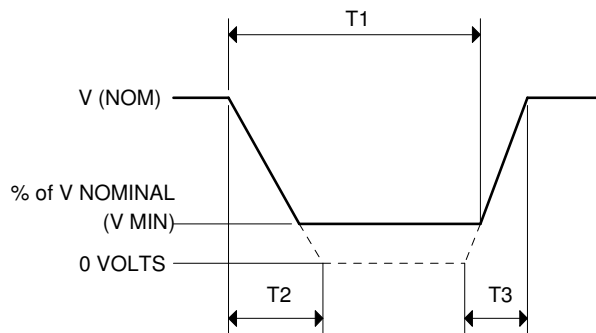

Figure 9-5: Frequency Modulation

POWER INTERRUPT

This test requires a numeric entry value equal to the test number. The tests are grouped as follows:

- Test numbers 1 through 15 are for all Standard and Groups. See Figure 9-6 for details of the tests.
- Test numbers 16 and 17 for all equipment that does not incorporate digital circuit. Test number 16 will drop the output to zero voltage for 50 ms. Test number 17 will drop the output to zero voltage for 200 ms. Test numbers 21 through 26 are applicable for Groups 2 and 3 only for EUROCAE standard and category A(NF) and A(WF) for RTCA2. Output frequency will be set to the F1 value for 1 second prior to the test. The output frequency will remain set to the F2 value when the test is completed. This will allow the user to apply a sequence of power interrupts. See Figure 9-7 for detail of the tests.



DO160 Table 16-1: Test conditions for equipment with digital circuits.

- NOTES
- 1: Definitions:
 - T1 Power interrupt time
 - T2 Time it would take for the applied voltage to decay from V (nom) to zero volts.
 - T3 Time it would take for the applied voltage to rise from zero to V (nom) volts.
 - V MIN The minimum level (expressed as a percentage of V NOMINAL) to which the applied voltage is permitted to decay.
 - 2: Tolerance to T1, T2, T3 = ± 10%
 - 3: Test condition numbers 8 and 15 are for category Z, dc powered equipment only.

Applicable Category:	A				A, Z			Z	A, B, Z			A, Z		Z	
	1**	2	3	4	5	6	7	8	9	10	11	12	13	14	15
Test Condition No.	1**	2	3	4	5	6	7	8	9	10	11	12	13	14	15
T1 (ms)	2**	10	25	50	75	100	200	1000	10	25	50	75	100	200	1000
T2 (ms)	<1	20*	20	20	20	20	20	20	50*	50*	50	50	50	50	50
T3 (ms)	<1	5	5	5	5	5	5	5	20	20	20	20	20	20	20
%V Nom. (V min)	0	50	15	10	5	0	0	0	80	50	0	15	5	0	0

* Voltage will not reach zero in this test condition.

** Equipment performance standards may require to repeat test n°1 with T1 varying from 5 to 200 ms by step defined in the test equipment performance standards (step typically comprised between 5 ms and 20 ms depending on equipment design).

Figure 9-6: Power Interrupt

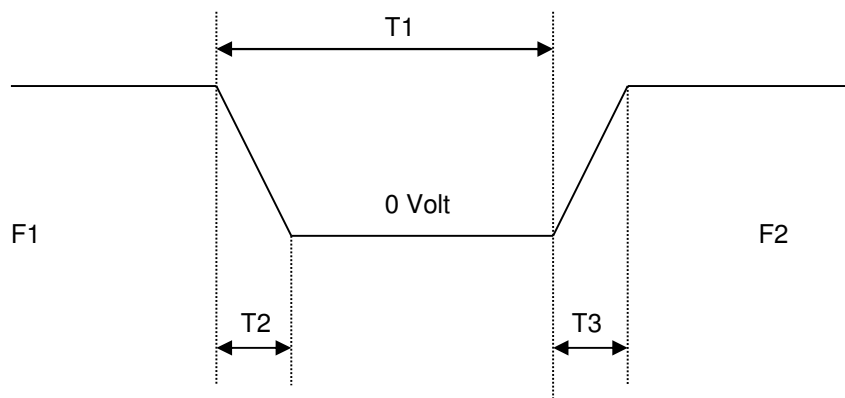

Test no.:	21	22	23	24	25	26
Standard:	I	II	III	IV	V	VI
T1 (ms)	50	50	100	100	200	200
F1 (Hz)	360	Fmax	360	Fmax	360	Fmax
F2 (Hz)	Fmax	360	Fmax	360	Fmax	360

Fmax = 650 Hz for Group2/A(NF)
 Fmax = 800 Hz for Group3/A(WF)
 T2 = 20 msec
 T3 = 5 msec

Figure 9-7: Power Interrupt for Group2/A (NF) and Group3/A(WF)

VOLTAGE SURGE

This test requires 160V output voltage. If the power source is set at the low voltage range, the high voltage range will be selected before the test starts. At the end of the test, the power source will be switched back to the low range automatically.

Seq. No.	Voltage				Time
	RTCA	Group 1	Group 2	Group 3	ALL
1	115	115	115	115	5 Minute
2	160	160	160	170	30msec
3	115	115	115	115	5 Sec.
4	60	70	70	70	30msec
5	115	115	115	115	5 Sec.

Table 9-5: Normal VoltageSurge Sequence

The output voltage will follow the sequence in Table 9-5. The above sequence will repeat itself three times. Each repeat will start from sequence two. RTCA and Group 1 will run at 400 Hz. Group 2 and A(NF) will run at 360 Hz and 650 Hz. Group 3 and A(WF) will run at 360Hz and 800Hz. The frequency will return to the nominal setting when the test is completed. The BACK key (backspace) will terminate the test at any time.

FREQUENCY TRANSIENTS (Group 1 and A(CF) only)

Seq. No	Frequency	Time
1	400	5 Minute
2	440	150msec
3	420	1.5sec
4	400	5Sec.
5	350	150msec
6	380	1.5sec
7	400	5Sec.

Table 9-6: Normal Frequency Transient Sequence

This test applies to Group1 and A(CF) only. The output voltage is set to Vnom (115 V) while the frequency is changed per the sequence listed in Table 9-6. The test will cycle 5 times starting from sequence 2. Steps 3 and 6 apply to A(CF) only.

FREQUENCY VARIATION (Group2 / A(NF) and Group3 / A(WF) only)

Seq. No	Initial Frequency		Slew rate	Final Frequency	
	Group2	Group3		Group2	Group3
1	360	360	100	650	800
2	650	800	100 or 200	360	360
3	360	360	Pause 5 sec	360	360

Table 9-7: Normal Frequency Variation Sequence

This test will apply to Group2/A(NF) and Group3/A(WF) only. . The output voltage is set to Vnom (115 V) while the frequency is set to 360Hz for 5 minutes. The frequency is slowed per the sequence listed in Table 9-7. The test will cycle 3 times. The frequency will return to nominal after the test is completed. Slew rates of 200Hz apply to RTCA2 only.

9.5.2 EMERGENCY TEST

From the DO160 MENU scroll to the EMERGENCY AC entry using the up and down cursor keys. Press the ENTER key to select the EMERGENCY screens. The screen will appear as shown in Figure 9-8.



Figure 9-8: Emergency Screens

The EMERGENCY SCREEN has the following tests:

- 1 VOLT FREQ MIN
- 2 VOLT FREQ MAX
- 3 VOLT UNBALANCE

The above tests can be selected by scrolling to the highlighted selection using the up and down key and the ENTER key to start the selected test.

VOLT FREQ MIN

Standard/Group		RTCA	A(CF)	A(NF)	A(WF)
Voltage	1 Φ	100	100	100	100
	3 Φ	101.5	101.5	101.5	101.5
Frequency		360	360	360	360

Standard/Group		Group1	Group2	Group3
Voltage	1 Φ	104	104	104
	3 Φ	105.5	105.5	105.5
Frequency		360	360	360

Table 9-8: Emergency Voltage and Frequency Minimum

Standard/Group		RTCA	Group1	Group2	Group3
Voltage	1 Φ	122	122	122	122
	3 Φ	120.5	120.5	120.5	120.5
Frequency		440	440	650	800

Standard/Group		Group1	Group2	Group3
Voltage	1 Φ	122	122	122
	3 Φ	120.5	120.5	120.5
Frequency		440	650	800

Table 9-9: Emergency Voltage and Frequency Maximum

This test will set the voltage and frequency to a level defined by Table 9-8. The test will last for 30 minutes. The test will be repeated using the voltage from Table 9-9 and frequency from Table 9-8. The BACK key (backspace) will terminate the test at any time.

VOLT FREQ MAX

This test will set the voltage and frequency to a level defined by Table 9-9. The test will last for 30 minutes. The test will be repeated using the voltage from Table 9-8 and frequency from Table 9-9. The BACK key (backspace) will terminate the test at any time.

VOLT UNBALANCE

Standard/Group	RTCA	A(CF)	A(NF)	A(WF)
Voltage offset	8	8	8	10
Frequency	400	360/440	360/650	360/800

Standard/Group	Group1	Group2	Group3
Voltage offset	8	8	12
Frequency	400	360/650	360/800

Table 9-10: Emergency Voltage Unbalance

This test will change the output voltage for phase A and B to 122V and phase C to a voltage lower by a value specified by an offset. Refer to Table 9-10 for the offset value and the Frequency. The test will repeat with the same frequency and phase A and B volt is set to 100V and phase C set to a higher voltage specified by the offset. The test will last 30 minutes. The test will be repeated for a second Frequency if applicable. The test can be terminated at any time.

The BACK key (backspace) will terminate the test at any time.

9.5.3 ABNORMAL TEST

From the DO160 MENU Scroll to the ABNORMAL AC entry using the up and down cursor keys. Press the ENTER key to select the ABNORMAL screens. The screen will appear as shown in Figure 9-9.

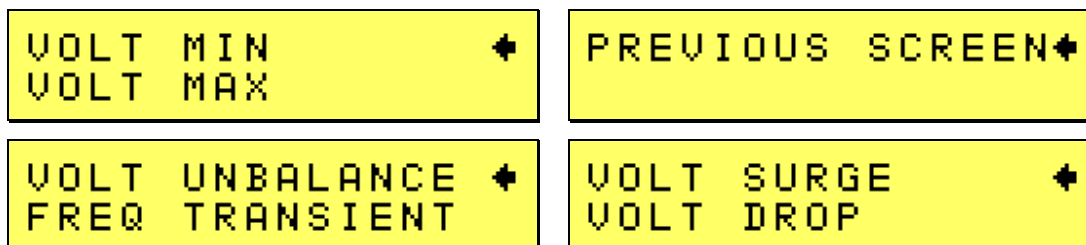

Figure 9-9: Abnormal Screen

The ABNORMAL SCREEN has the following tests:

- 1 VOLT MAX
- 2 VOLT MIN
- 3 VOLT UNBALANCE
- 4 VOLT SURG
- 5 VOLT DROP
- 6 FREQ TRANSIENTS

The above test can be selected by scrolling to the highlighted selection using the up and down key and the ENTER key to start the selected test.

VOLT MAX

Standard/Group		RTCA	Group1/A(CF)		Group2/A(NF)	Group3/A(WF)
Voltage	1	97	97	104/100	97	97
	3	98.5	98.5	105.5/101.5	98.5	98.5
Frequency		400	400	370	360	360

Table 9-11: Abnormal Voltage Minimum

Standard/Group		RTCA	Group1/ACF)		Group2/A(NF)	Group3/A(WF)
Voltage	1	134	134	122	134	134
	3	132.5	132.5	120.5	132.5	132.5
Frequency		400	400	430	650	800

Table 9-12: Abnormal Voltage Maximum

This test will set the voltage and frequency to levels defined by Table 9-11 for 5 minutes. The test will be repeated for Group1 and A(CF) only as indicated in Table 9-10 for voltage and Table 9-12 for frequency. All Groups will repeat the test using Table 9-10 for the voltage setting and Table 9-10 or Table 9-11 for the frequency setting. The BACK key (backspace) will terminate the test at any time.

VOLT MIN

This test will set the voltage and frequency to levels defined by Table 9-12 for 5 minutes. The test will be repeated for Group1 only as indicated in Table 9-12. All Groups will repeat the test using Table 9-12 for the voltage setting and Table 9-11 for the frequency setting. The BACK key (backspace) will terminate the test at any time.

VOLT UNBALANCE

This test applies only to RTCA2 standard.

Standard/Group	A(CF)	A(NF)	A(WF)
Voltage offset	6	6	8
Frequency	400	360/650	360/800

Table 9-13: Abnormal Voltage Unbalance

This test will change the output voltage for phase A and B to 134V and phase C to a voltage lower by a value specified by an offset. Refer to Table 9-13 for the offset value and the Frequency. The test will repeat with the same frequency and phase A and B volt is set to 97V and phase C set to a higher voltage specified by the offset. The test will last 5 minutes. The test will be repeated for a second Frequency if applicable. Additional test for A(CF) category is applied with phase A and voltage set at 122V and phase C at 116V. The frequency is set at 430V. The test is repeated with the same frequency but phase A and B are set at 100V and phase C set at 106V. Both tests are repeated for 370Hz. The test can be terminated at any time. The BACK key (backspace) will terminate the test at any time.

VOLT UNDER

This test will drop the output voltage from 115 volts to 60 volts for 7 seconds.

VOLT SURGE

This test requires 180 volt output voltage. If the power source is set at the low voltage range, the high voltage range will be selected before the test starts. At the end of the test the AC source will be switched back to the low range.

The output voltage will surge to 180 volts for 100 ms. followed by drop to 148 volts for 1 sec before it returns to 115 volts. The BACK key (backspace) will terminate the test at any time.

FREQUENCY TRANSIENTS (A(CF) only)

Test 1

Seq. No.	Volt/Frequency	Time
1	115/400	5 minutes
2	115/350	5 sec.
3	115/320	0.2 sec.
4	0/320	0.2 sec.
5	115V/400	10 sec.

Test 2

Seq. No.	Volt/Frequency	Time
1	115/400	5 minutes
2	115/480	0.2 sec.
3	115/440	5 sec.
4	0/440	0.2 sec.
5	115V/400	10 sec.

FREQUENCY TRANSIENTS (Group 1 only)

Seq. No.	Frequency	Time
1	400	5 minutes
2	480	5 sec.
3	400	10 sec.
4	320	5 sec.
5	400	10 sec.

Table 9-14: Abnormal Frequency Transient

This test will set the voltage at 115V and will remain at this voltage through out the test except for the A(CF) category. The test will cycle the frequency three times as shown in Table 9-14. Each repeat will start from sequence 2. Test 1 and Test 2 for the A(CF) category are done in succession as a single test.

9.6 DC Test Mode

DC test mode requires DC mode and a steady state voltage setting of 24V DC or 14V DC.

Note: Prior to test selection the Standard selection and Category selection are required. Use the shuttle to select Standard RTCA or EUROCAE. Also, select equipment category A, B or Z.

9.6.1 Normal State Test

Scroll to the NORMAL STATE entry using the up and down cursor keys. Press the ENTER key to select the NORMAL STATE screen. The screens will appear as shown in Figure 9-10.



Figure 9-10: Normal State screens

The DO-160 NORMAL screen has the following tests:

1. VOLT MIN
2. VOLT MAX
3. VOLT UNDER
4. VOLT SURGE
5. POWER INTERRUPT

The above tests can be selected by scrolling to the highlighted selection using the up and down key and the ENTER key to start the selected test. For some of these tests, numeric data entry may be required to define the test number or the modulation rate.

VOLT MIN

Standard	Categories		
	A and Z	B 28V / 14V	
RTCA	22.0	22.0	11.0
EUROCAE	22.0	25.1	12.5

Table 9-15: Normal Voltage Minimum

This test will change the output voltage from 28V or 14V to 22V or 11V. The test will last for 30 minutes. The ← (backspace) will terminate the test at any time.

VOLT MAX

Standard	Categories		
	A and Z	B 28V / 14V	
RTCA	30.3	30.3	15.1
EUROCAE	30.3	29.3	14.6

Table 9-16: Normal Voltage Maximum

This test will change the output voltage from 28V or 14V to 30.3V or 15.1V. The test will last for 30 minutes. The ← (backspace) will terminate the test at any time.

VOLT UNDER

This test applies to category Z and 28 volt category B equipment. The output voltage will drop to 10 volts and will ramp up at a rate of 0.15 volt/sec for the US standard and at a rate of 0.30 volt/sec for EUROCAE standard for 30 seconds before it returns to nominal value.

VOLT SURGE

This test will surge and sag the voltage to a level and duration specified Table 9-17 with 5 seconds between transients. The test is repeated three times.

Category	Surge			Sags		
	Volt		Dwell (msec)	Volt		Dwell (msec)
	RTCA	EUR		US	EUR	
A	40	40	30	15	17	30
B	40	40	30	15	17	30
Z	50	50	50	12	12	30

Table 9-17: Voltage Surge

POWER INTERRUPT

Refer to section POWER INTERRUPT.

9.6.2 Abnormal Test

From the DO-160 MENU scroll to the ABNORMAL DC entry using the up and down cursor keys. Press the ENTER key to select the ABNORMAL screen. The screen will appear as shown in Figure 9-11.

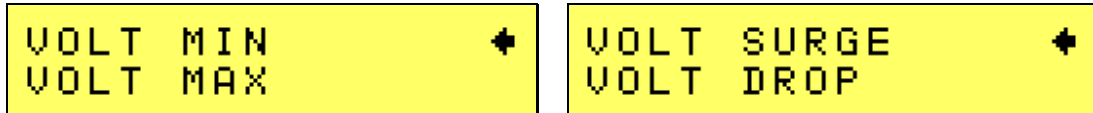

Figure 9-11: Abnormal State screens

The Abnormal Test has the following tests:

1. VOLT MIN
2. VOLT MAX
3. VOLT LOW
4. VOLT DROP
5. VOLT SURGE

The above tests can be selected by scrolling to the highlighted selection using the up and down key and the ENTER key to start the selected test.

VOLT MIN

This test will change the output voltage from 28V or 14V to 20.5V or 10V. The test will last for 30 minutes. The ← key (backspace) will terminate the test at any time.

VOLT MAX

This test will change the output voltage from 28V or 14V to 32.2V or 16V. The test will last for 30 minutes. The ← key (backspace) will terminate the test at any time.

VOLT LOW

This test applies for category B equipment.

This test will change the output voltage to the voltage minimum for one minute. The voltage will decay linearly to zero voltage in a ten minute period before returning to its nominal voltage.

VOLT DROP

This test will change the output to 12V from 28V or to 6V from 14V for seven seconds. The output voltage will return to nominal voltage after seven seconds.

VOLT SURGE

This test will produce voltage surge defined by Table 9-18. This test will be repeated three times with ten seconds intervals. The voltage values are halved for 14.0V category B equipment.

Category	Surge 1		Surge 2	
	Volt	Dwell (msec)	Volt	Dwell (msec)
A	46.3	100	37.8	1000
B	60	100	40	1000
Z	80	100	48	1000

Table 9-18: Abnormal Voltage Surge

9.6.3 Emergency Test

The Emergency test is selected from the DO-160 DC Main Menu. This test will set the output voltage to 18V for 28V equipment and to 9V for 14V equipment. The test will last for 30 minutes. The ← key (backspace) will terminate the test at any time.

10. Option -704: MIL-STD 704 Rev D & E (MIL704 Mode)

10.1 General

Option -704 includes a firmware implementation for Mil-Std 704 revision D and E and a short version of revision F. For testing to revision F conform the MIL704 handbook, the GUI based software implementation is available. The software based avionics tests are covered by a separate Avionics Software Manual, CI P/N 4994-971, which is distributed on the same CD as this manual.

This user manual assumes that the user is familiar with the text of the relevant MIL-STD 704, test standard. No attempt is made to explain or elaborate on the actual test specification. The-704 option supports both AC and DC power applications.

Test Execution Considerations

Several of the MIL-STD 704 test steps take considerable time to execute. Tests in progress may be aborted by using the BACK button on the power source front panel.

10.2 Initial Setup

Nominal parameters for the AC Power source are as follows:

Output Voltage	115V L-N or 230V L-N
Output Frequency	360 Hz to 800 Hz for all revisions. 60 Hz for revision F only.

Nominal parameters for the DC Power source are as follows:

Output Voltage	28V or 270V L-N
----------------	-----------------

Note: *A setting outside these nominal values will disable the test and will prevent access to the 704 Menu screens or execution of any test step.*

The Compact i/iX Series has a maximum voltage range for 300Vrms. Consequently, not all tests for 230VAC nominal input voltage EUT's can be performed.

10.3 Test Revision

The MIL-STD 704 option is capable of performing many sub-sections of MIL-STD 704 revision D or E. A selection is made available to specify the revision of standard to be applied to the EUT. The MIL704 option defaults to Revision E.

10.4 Available MIL-STD 704 Tests

10.4.1 STEADY STATE

AC Mode:

1. Steady State Voltage and Frequency test
2. Waveform Distortion test
3. Voltage Modulation test
4. Voltage Unbalance test
5. Phase Unbalance test
6. Frequency Modulation test
7. Voltage Modulation test
8. Transient Voltage low and high test
9. Transient Frequency low and high test

DC Mode:

1. Steady State Voltage test
2. Ripple test (limit frequency range).

10.4.2 EMERGENCY STATE

AC Mode:

1. Emergency Voltage minimum and maximum test
2. Emergency Frequency minimum and maximum test

DC Mode:

1. Emergency Voltage minimum and maximum test

10.4.3 ABNORMAL STATE

AC Mode:

1. Abnormal Voltage under
2. Abnormal Voltage over
3. Abnormal Frequency under
4. Abnormal Frequency under

DC Mode:

1. Abnormal Voltage under
2. Abnormal Voltage over

10.5 Front Panel Operation MIL704

To perform a test from the keyboard, from the MENU screen, select the APPLICATIONS screen. The APPLICATIONS screen will appear as shown in Figure 10-1.

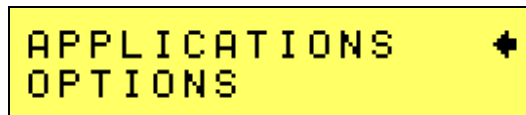

Figure 10-1: Applications Menu

Scroll to the MIL-STD-704 entry using the up and down cursor keys. Press the ENTER key to select the MIL704 main menu.

Note: The user has to turn on the Output relay before starting a test and set the steady state setup for the test. NOM FREQ must be set to match the desired steady state frequency. All MIL704 revisions will accept 400Hz as a nominal frequency. Revision F only will accept 60Hz and VFREQ.

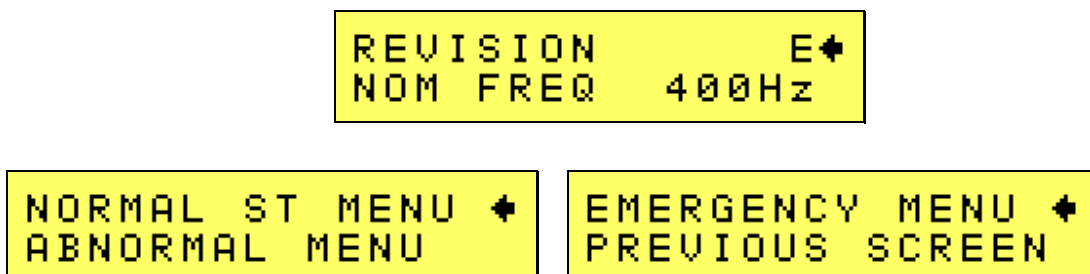

Figure 10-2: MIL704 Menu

10.5.1 Revision Selection

The default Revision is E. Revisions supported is D, E and F. The Revision can be changed from the front panel. Scroll to the REVISION entry using the up and down cursor keys (Figure 10-2). Use the shuttle to change the selection.

10.5.2 Nominal Frequency Selection

Three selections are available for the nominal frequency to be used:

- 400Hz, this selection is active in all revisions. Program frequency must be set to 400Hz.
- VFREQ, this selection is active for revision F only. Program frequency must be set between 360Hz and 800Hz to run the tests.
- 60Hz, this selection is active for revision F only. Program frequency must be set to 60Hz to run the tests.

Note that the programmed frequency of the AC source must be the same as the selected nominal test frequency selected in the 704 screen. If not, a Setting Conflict error will be generated when attempting to run a test. The programmed frequency can only be changed from the normal setup screen. Selecting the nominal test frequency in the 704 Application screen does not change the output frequency programmed.

10.6 AC Test Mode

Following sections cover testing in AC output mode.

10.6.1 Steady State Tests

Scroll to the STEADY STATE entry using the up and down cursor keys. Press the ENTER key to select the STEADY STATE screens. The screen will appear as shown in Figure 10-3

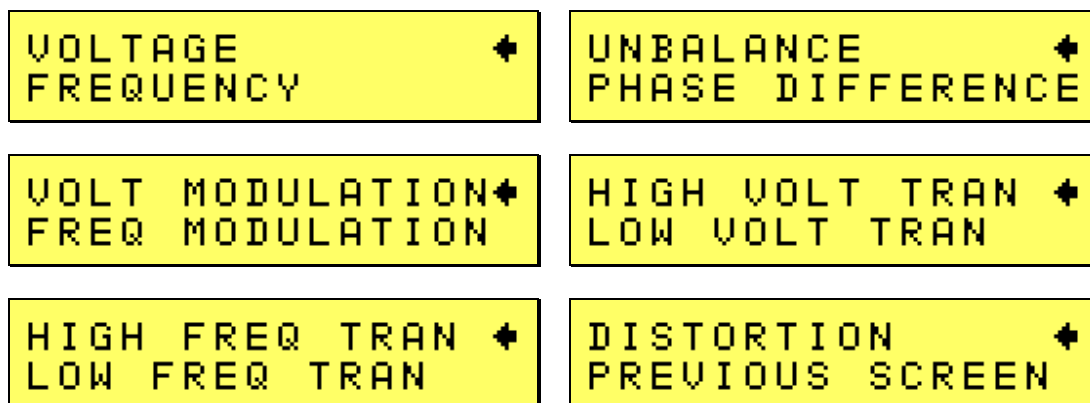

Figure 10-3: Steady State Menu

The MIL704 Steady state screens have the following tests:

1. VOLTAGE
2. FREQUENCY
3. VOLT UNBALANCE
4. PHASE DIFFERENCE
5. VOLT MODULATION
6. FREQ MODULATION
7. VOLT TRANSIENT
8. FREQ TRANSIENT
9. DISTORTION

The above tests can be selected by scrolling to the highlighted selection using the up and down cursor keys and the ENTER key to start the selected test.

VOLTAGE

This test will change the output voltage in the sequence shown in Table 10-1.

SEQUENCE	VOLTAGE		TIME
	400Hz/VFREQ	60Hz only	
1	108	110	1 minute
2	118	125	1 minute
3	115	115	1 minute

Table 10-1: Steady state voltage

The ← key (backspace) will terminate the test at any time.

FREQUENCY

This test will change the output frequency in the sequence shown in Table 10-2.

SEQUENCE	FREQUENCY			TIME
	400Hz	VFREQ	60 Hz	
1	393	360	59	1 minute
2	407	800	61	1 minute
3	400	SSF	60	1 minute

Table 10-2: Steady state frequency

The ← key (backspace) will terminate the test at any time.

VOLT UNBALANCE

This test will change the output voltage for the selected phase only in the following sequence:

- 112V for 1 minute.
- 118V for 1 minute.
- 115V for 1 minute.

The test will be repeated on three phase systems to include all three phases if the coupling is set to all.

The ← key (backspace) will terminate the test at any time.

PHASE DIFFERENCE

This test applies to three phase systems only. The phase angle for the selected phase will change relative to phase A in the following sequence:

If phase B is selected:

- 236° for 1 minute.
- 244° for 1 minute.
- 240° for 1 minute.

If phase C is selected:

- 116° for 1 minute.
- 124° for 1 minute.
- 120° for 1 minute

VOLTAGE MODULATION

This test will vary the output voltage by $\pm 2.5V$ rms over a period of one second. The test will last for 2 minutes. The ← key (backspace) will terminate the test at any time.

FREQUENCY MODULATION

REVISION	D	E	F (400Hz /VFREQ)	F (60HZ)
MODULATION	$\pm 7Hz$	$\pm 4Hz$	$\pm 4Hz$	$\pm 0.5Hz$

Table 10-3: Frequency Modulation

This test will vary the output frequency as defined by Table 10-3 over a period of one minute. The test will last for 4 minutes. The ← key (backspace) will terminate the test at any time.

WAVEFORM DISTORTION

This test will generate a 5% THD voltage distortion on the output voltage waveform. Using a clipped sine wave causes the distortion. The test will last for 2 minutes. The ← key (backspace) will terminate the test at any time.

HIGH VOLTAGE TRANSIENT

This test will change the output voltage for the selected phase in the following sequence:

For 400 Hz and VFREQ:

- 180V for 10msec.
- Linearly reduced to 118V in 78msec.
- Stay at 118V for 87msec before returning to 115V.

For 60 Hz only:

- 170V for 1.67msec
- Linearly reduced to 130V in 14msec.
- Linearly reduced to 120V in 83.3msec.
- Stay at 120V for 75msec.

Note: Prior to the test, a voltage range change may take place if the power source is set for the low voltage range. This will cause the EUT to lose power momentarily. If this is not acceptable, the power source must be left in high range at all times.

After this sequence, a 5 second delay will be inserted at the nominal test voltage. The ← key (backspace) will terminate the test at any time.

LOW VOLTAGE TRANSIENT

This test will change the output voltage for the selected phase only in the following sequence:

For 400 Hz and VFREQ:

- 80V for 10msec.
- Linearly increase to 108V in 70msec.
- Stay at 108V for 95msec before returning to 115V.

For 60Hz only:

- 0V for 1.67msec.
- Linearly increase to 70V in 14msec.
- Linearly increase to 105V in 83.3msec
- Stay at 105V for 75msec.

After this sequence, a 5 second delay will be inserted at the nominal test voltage. The ← key (backspace) will terminate the test at any time.

HIGH FREQUENCY TRANSIENT

This test will change the output frequency in the following sequence:

For 400Hz and VFREQ:

- 425Hz for 1 sec.

- 420Hz for 4 sec.
- 410Hz for 5 sec.
- 407Hz for 4 sec.

For 60Hz only:

- 61Hz for 0.5 sec.
- 60.5Hz for 0.5 sec.

After this sequence, a 5 second delay will be inserted at the nominal test frequency. The ← key (backspace) will terminate the test at any time.

LOW FREQUENCY TRANSIENT

This test will change the output frequency in the following sequence:

For 400Hz and VFREQ:

- 375Hz for 1 sec.
- 380Hz for 4 sec.
- 390Hz for 5 sec.
- 393Hz for 4 sec.

For 60Hz only:

- 59Hz for 0.5 sec.
- 59.5Hz for 0.5 sec.

After this sequence, a 5 second delay will be inserted at the nominal test frequency. The ← key (backspace) will terminate the test at any time.

10.6.2 Emergency Test

From the MIL704 main menu (Figure 10-2) scroll to the EMERGENCY entry using the up and down cursor keys. Press the ENTER key to select the EMERGENCY screens. The screen will appear as shown in Figure 10-4.

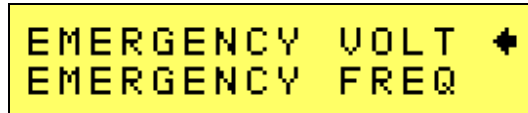

Figure 10-4: Emergency Menu

The EMERGENCY SCREEN has the following tests:

- 1 VOLTAGE
- 2 FREQUENCY

The above tests can be selected by scrolling to the highlighted selection using the up and down key and the ENTER key to start the selected test.

Note: *These tests are only required for revision D. See steady state voltage and frequency tests for all other revisions.*

VOLTAGE

This test will change the output voltage in the following sequence:

- 104V for 1 minute.
- 122V for 1 minute.
- 115V for 1 minute.

The ← key (backspace) will terminate the test at any time.

FREQUENCY

This test will change the output frequency in the following sequence:

- 360Hz for 1 minute.
- 440Hz for 1 minute.
- 400Hz for 1 minute.

The ← key (backspace) will terminate the test at any time.

10.6.3 Abnormal Test

From the MIL704 main menus as shown in Figure 10-2, scroll to the ABNORMAL AC entry using the up and down cursor keys. Press the ENTER key to select the ABNORMAL screens. The screen will appear as shown in Figure 10-5.



Figure 10-5: Abnormal Screens

The ABNORMAL SCREEN has the following tests:

1. OVER VOLTAGE
2. UNDER VOLTAGE
3. OVER FREQUENCY
4. UNDER FREQUENCY

The above test can be selected by scrolling to the highlighted selection using the up and down key and the ENTER key to start the selected test.

OVER VOLTAGE

This test will change the output voltage for the selected phase in the following sequence:

For 400Hz and VFREQ:

- 180V for 50msec.
- The voltage gradually decays with time to 125 volt by the following equation:
 $V = 124.6 + 2.77/t$. For $0.05 \leq t \leq 6.925$
- Stay at 125V for 93 seconds before returning to 115V.

For 60Hz only:

- 180V for 3.34msec
- The Voltage gradually decays with time to 122 volt by the following equation:
 $V = 121.7 + 0.583/t$. For $0.00334 \leq t \leq 1.947$
- Stay at 122V for 8 seconds before returning to 115V.

Note: Prior to the test, a voltage range change may take place if the power source is set for the low voltage range. This will cause the EUT to loose power momentarily. If this is not acceptable, the power source must be left in high range at all times.

The ← key (backspace) will terminate the test at any time.

UNDER VOLTAGE

This test will change the output voltage for the selected phase in the following sequence:

For 400Hz and VFREQ:

- 0V for 7 seconds.
- 100V for 93 seconds.

For 60Hz only

- 0V for 2 seconds.
- 100V for 8 seconds.

The ← key (backspace) will terminate the test at any time.

OVER FREQUENCY

This test will change the output frequency in the sequence shown in Table 10-4 before returning to the steady state frequency.

The ← key (backspace) will terminate the test at any time.

Revision	D		E		F		F 60Hz only	
	FREQ	Time	FREQ	Time	FREQ	TIME	FREQ	TIME
Seq1	480Hz	5sec.	480Hz	5sec.	480Hz	5sec	61Hz	7sec
Seq2	420Hz	5sec	420Hz	9sec	420Hz	5sec	60.5Hz	8sec

Table 10-4: Abnormal Over Frequency

After this sequence, a 5 second delay will be inserted at the nominal test frequency. The ← key (backspace) will terminate the test at any time.

UNDER FREQUENCY

This test will change the output frequency in the sequence shown in Table 10-5 before returning to steady state frequency.

The ← key (backspace) will terminate the test at any time.

Revision	D		E		F		F 60Hz only	
	FREQ	Time	FREQ	Time	FREQ	TIME	FREQ	TIME
Seq1	0	5sec.	0Hz	7sec.	0Hz	7sec	0Hz	7sec
Seq2	375Hz	5sec	380Hz	7sec	380Hz	3sec	59.5Hz	8sec

Table 10-5: Abnormal Under Frequency

After this sequence, a 5 second delay will be inserted at the nominal test frequency. The ← key (backspace) will terminate the test at any time.

10.7 DC Test Mode

DC test mode requires DC mode and a steady state voltage setting of 28V DC or 270V DC.

10.7.1 Steady State Test

Scroll to the STEADY STATE entry using the up and down cursor keys. Press the ENTER key to select the STEADY STATE screen.

The MIL704 STEADY STATE screen has the following tests:

- 1 VOLTAGE
- 2 RIPPLE

The above tests can be selected by scrolling to the highlighted selection using the up and down key and the ENTER key to start the selected test.

VOLTAGE

This test will change the output voltage for the selected phase in the following sequence:

1. 28V system:
 - 22V for 1 minute.
 - 29V for 1 minute.
 - 28V for 1 minute.
2. 270V system:
 - 250V for 1 minute.
 - 280V for 1 minute.
 - 270V for 1 minute.

The ← key (backspace) will terminate the test at any time.

DC RIPPLE

This test will impose a 400Hz frequency component to the output voltage. The test will last for 2 minutes. The level of the ripple is as follows:

1. 28V system:
 - ±1.5V.
2. 270V system:
 - ±6.0V.

The ← key (backspace) will terminate the test at any time.

10.7.2 Transient Test

From the MIL704 DC MENU scroll to the TRANSIENT DC entry using the up and down cursor keys. Press the ENTER key to select the TRANSIENT screen.

The Transient Test has the following tests:

- 1 HIGH VOLTAGE
- 2 LOW VOLTAGE

HIGH VOLTAGE

This test will change the output voltage for the selected phase in the following sequence:

1. 28V System
 - 50V for 12.5 msec.
 - Linearly reduce to 29V in 70msec.
 - Stay at 29V for 92.5msec before returning to 28V.
2. 270V System
 - 330V for 20 msec.
 - Linearly reduce to 280V in 20msec.
 - Stay at 280V for 135msec before returning to 270V.

Prior to the test, a range change may take place if the power source is set for the low voltage range.

The ← key (backspace) will terminate the test at any time.

Note: A range change will result in momentary loss of power to the EUT. If this is not acceptable, the power source must be left in high range at all times.

LOW VOLTAGE

This test will change the output voltage for the selected phase in the following sequence:

1. 28V System
 - 18V for 15 msec.
 - Linearly increase to 22V in 85msec.
 - Stay at 22V for 75msec before returning to 28V.
2. 270V System
 - 200V for 10 msec.
 - Linearly increase to 250V in 30msec.
 - Stay at 250V for 135msec before returning to 270V.

The ← key (backspace) will terminate the test at any time.

10.7.3 Abnormal Test

From the MIL704 DC MENU scroll to the ABNORMAL DC entry using the up and down cursor keys. Press the ENTER key to select the ABNORMAL screen. The Abnormal Test has the following tests:

- 1 OVER VOLTAGE
- 2 UNDER VOLTAGE

The above tests can be selected by scrolling to the highlighted selection using the up and down cursor keys and the ENTER key to start the selected test.

OVER VOLTAGE

This test will change the output voltage for the selected phase in the following sequence:

1. 28V system:
 - 50V for 50msec.
 - The voltage gradually decays with time to 31.5 volts by the following equation:
 $V = 31.38 + 0.93/t$ for $0.05 \leq t \leq 7.758$
 - Stay at 31.5V for 92.242 seconds before returning to 28V.
2. 270V system:
 - 350V for 50msec.
 - The voltage gradually decays with time to 290 volts by the following equation:
 $V = 289.6 + 3.02/t$ for $0.05 \leq t \leq 7.55$
 - Stay at 290V for 92.45 seconds before returning to 270V.

Prior to the test, a range change may take place if the power source is set at the low voltage range. Note: See Section 10.6.1 under HIGH VOLTAGE.

The ← key (backspace) will terminate the test at any time.

Note: A range change will result in momentary loss of power to the EUT. If this is not acceptable, the power source must be left in high range at all times.

UNDER VOLTAGE

This test will change the output voltage for the selected phase in the following sequence:

1. 28V system:
 - 0V for 7sec.
 - 20V for 93sec.
2. 270V system:
 - 0V for 7sec.
 - 240V for 93sec.

The ← key (backspace) will terminate the test at any time.

10.7.4 Emergency Test

From the MIL704 DC MENU scroll to the EMERGENCY DC entry using the up and down cursor keys (Figure 10-6). Press the ENTER key to start the EMERGENCY TEST.

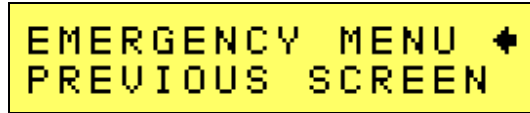

Figure 10-6: Emergency Test

VOLTAGE

This test will change the output voltage for the selected phase in the following sequence:

1. 28V system:
 - 18V for 1 minute.
 - 29V for 1 minute.
 - 28V for 1 minute.
2. 270V system:
 - 250V for 1 minute.
 - 280V for 1 minute.
 - 270V for 1 minute.

The ← key (backspace) will terminate the test at any time.

11. Option –ABD: Airbus ABD0100.1.8 Test

Use of this option requires the following:

- Compact i/iX Series AC power source.
- -ABD option. Options installed are listed on unit's serial tag.
- Windows XP/2000 PC with USB, RS232, LAN or National Instruments GPIB controller interface.
- IXCGui Windows software. Provided on CI P/N CIC496 CD ROM or available for download from the AMETEK Programmable Power' website.
- Additional equipment will be required in order to meet all ABD directive test requirements.

Information on how to operate the GUI for ABD0100.1.8 testing may be found in the Avionics Software Manual, CI P/N 4994-971. This manual is distributed on the same CD ROM as this user manual.

12. Option –A350: Airbus ABD0100.1.8.1 Test

Use of this option requires the following:

- Compact i/iX Series AC power source.
- -A350 option. Options installed are listed on unit's serial tag.
- Windows XP/2000 PC with USB, RS232, LAN or National Instruments GPIB controller interface.
- IXCGui Windows software. Provided on CI P/N CIC496 CD ROM or available for download from the AMETEK Programmable Power website.
- Additional equipment will be required in order to meet all ABD directive test requirements.

Information on how to operate the GUI for A350 / ABD0100.1.8.1 testing may be found in the Avionics Software Manual, CI P/N 4994-971. This manual is distributed on the same CD ROM as this user manual.

13. Option –AMD: Airbus AMD24 Test

Use of this option requires the following:

- Compact i/iX Series AC power source.
- -AMD option. Options installed are listed on unit's serial tag.
- Windows XP/2000 PC with USB, RS232, LAN or National Instruments GPIB controller interface.
- IXCGui Windows software. Provided on CI P/N CIC496 CD ROM or available for download from the AMETEK Programmable Power website.
- Additional equipment will be required in order to meet all AMD directive test requirements.

Information on how to operate the GUI for A400M directive AMD24 testing may be found in the Avionics Software Manual, CI P/N 4994-971. This manual is distributed on the same CD ROM as this user manual.

14. Option –B787: Boeing B787-0147 Test

Use of this option requires the following:

- Compact i/iX Series AC power source.
- -B787 option. Options installed are listed on unit's serial tag.
- Windows XP/2000 PC with USB, RS232, LAN or National Instruments GPIB controller interface.
- iXCGui Windows software. Provided on CI P/N CIG496 CD ROM or available for download from the AMETEK Programmable Power website.
- Additional equipment will be required in order to meet all ABD directive test requirements.

Information on how to operate the GUI for B787-0147 testing may be found in the Avionics Software Manual, CI P/N 4994-971. This manual is distributed on the same CD ROM as this user manual.

15. Option –WHM: Watt Hour Meter measurements

The WHM measurement function can be accessed from the APPLICATIONS screen. Note that the -WHM option is required for watt-hour measurements. If the –WHM is not installed (refer to the OPTIONS menu), the watt-hour screen in the APPLICATIONS menu will be inactive.

To start watt-hour measurement, program the required output parameters of the power source and apply the load. The output relay must be closed. From the APPLICATIONS menu, scroll down to the WHM entry and press the Enter Key.

```
MS704
WHM      ↵
```

This will display the screen shown below. Scroll down using the down arrow key to select the elapsed time screen.

```
WHM STATE    OFF ↵
WATT HR      0.0
```

```
ETIME       0:00:00 ↵
PREVIOUS SCREEN
```

The following fields are available:

WHM STATE: Select this field and press the ENTER key to toggle the watt-hour measurement mode ON or OFF. This will start and stop the watt-hour measurements.

WATT HR: This field displays the watt-hour measurement readout.

ETIME: This field will accumulate the time in hours, minutes and seconds.

PREVIOUS SCREEN: Returns to the APPLICATIONS screen.

Note: Changing from ON to OFF will stop the measurement and will maintain the last data record for the watt-hour meter. To restart the measurements, the field is toggled to the OFF position from the ON position and the previous data will be reset to zeros.

16. Error Messages

Any errors that occur during operation from either the front panel or the remote control interface will result in error messages. Error messages are displayed on the LCD display. They are also stored in the error message queue from which they can be queried using the SYST:ERR? Query. The error queue has a finite depth. If more error messages are generated than can be held in the queue, a queue overflow message (Error -400, "Queue Overflow") will be put in the last queue location. To empty the queue, use the system error query until a 0, "No Error" result is received.

Errors appearing on the LCD will generally remain visible until the user moves to another screen. If multiple error messages are generated in succession, only the last message will be visible as there is only space for one error message on the LCD display.

The same area of the display is also used to display status messages.

The table below displays a list of possible error and status messages along with their possible cause and remedy.

Number	Message String	Cause	Remedy
0	"No error"	No errors in queue	
-100	"Command error"	Unable to complete requested operation	Unit may be in a mode inconsistent with request.
-102	"Syntax error"	Command syntax incorrect.	Misspelled or unsupported command
-103	"Invalid separator"	SCPI separator not recognized	See SCPI section of programming manual.
-104	"Data type error"	Data type invalid.	Check command for supported data types
-108	"Parameter not allowed"	One or more additional parameters were received.	Check programming manual for correct number of parameters
-109	"Missing parameter"	Too few parameters received for requested operation	Check programming manual for correct number of parameters
-110	"Command header error"	Command header incorrect	Check syntax of command.
-111	"Header separator error"	Invalid command separator used.	Use semi-colon to separate command headers
-112	"Program mnemonic too long"	Syntax error	Check programming manual for correct command syntax
-113	"Undefined header"	Command not recognized error	Check programming manual for correct command syntax
-120	"Numeric data error"	Data received is not a number	Check programming manual for correct command syntax
-121	"Invalid character in number"	Number received contains non-numeric character(s)	Check programming manual for correct command syntax
-123	"Exponent too large"	Exponent in number exceeds limits	Check programming manual for correct parameter range
-128	"Numeric data not allowed"	Number received when number is not allowed.	Check programming manual for correct command syntax
-168	"Block data not allowed"	Block data was sent.	<i>Check programming manual for correct command syntax</i>
-200	"Execution error"	Command could not be	Command may be inconsistent with

Number	Message String	Cause	Remedy
		executed	mode of operation.
-201	"Invalid while in local"	Command issued but unit is not in remote state	Put instrument in remote state before issuing GPIB commands.
-203	"Command protected"	Command is locked out	Some commands are supported by the unit but are locked out for protection of settings and are not user accessible.
-210	"Trigger error"	Problem with trigger system.	Unit could not generate trigger for transient execution or measurement.
-211	"Trigger ignored"	Trigger request has been ignored.	Trigger setup incorrect or unit was not armed when trigger was received. Check transient system or measurement trigger system settings.
-213	"Init ignored"	Initialization request has been ignored	Unit was told to go to armed state but was unable to do so. Could be caused by incorrect transient system or measurement acquisition setup.
-220	"Parameter error"	Parameter not allowed.	Incorrect parameter or parameter value. Check programming manual for allowable parameters
-221	"Setting conflict"	Transient programmed with more than 1 mode.	Check other settings. E.g. Redefine transient mode. As result of *TST? execution, indicates ALC mode is off or waveform not set to Sine.
-222	"Data out of range"	Parameter data outside of allowable range.	Check programming manual for allowable parameter values
-223	"Too much data"	More data received than expected	Check programming manual for number of parameters or data block size
-224	"Illegal parameter value"	Parameter value is not supported	Check programming manual for correct parameters
-226	"Lists not same length"	One or more transient lists programmed have different length.	All lists must be of same length or transient cannot be compiled and executed.
-241	"Hardware missing"	N/A	N/A
-254	"Media full"	No storage space left to save settings or data.	Delete other settings or data to make room.
-255	"Directory full"	Too many waveform directory entries	Delete one or more waveforms from waveform memory to make room.
-256	"File name not found"	Waveform requested not in directory	Check waveform directory for waveform names present.
-257	"File name error"	Incorrect filename	Too many or non-ASCII characters used in waveform file definition.
-283	"Illegal variable name"	Variable name illegal.	Use ASCII characters only
-300	"Device specific error"	Hardware related error	Check hardware for proper operation.
-311	"Memory error"	Waveform memory checksum error.	May be the result of incomplete user-defined waveform download. Check interface and try downloading waveform again. Successful download may clear this error condition. Alternatively, use TRAC:DEL:ALL command to clear waveform memory.

Number	Message String	Cause	Remedy
-314	"Save/recall memory lost"	User setup register contents lost	Store setup in same register again.
-315	"Configuration memory lost"	Hardware configuration settings lost.	Contact CI service department at support@programmablepower.com to obtain instructions on restoring configuration data.
-330	"Self-test failed"	Internal error	Contact CI service department at support@programmablepower.com
-350	"Queue overflow"	Message queue full.	Too many messages. Read status using SYST:ERR query until 0, "No Error" is received indicating queue empty.
-400	"Query error"	Unable to complete query.	Check programming manual for correct query format and parameters
-410	"Query INTERRUPTED"	Query issued but response not read.	Check application program for correct flow. Response must be read after each query to avoid this error.
-420	"Query UNTERMINATED"	Query incomplete.	Check for terminator after query command.
-430	"Query DEADLOCKED"	Query cannot be completed	Check application program for multiple queries
-440	"Query UNTERMINATED"	Query incomplete.	Check for terminator after query command.
0	"No error"	No errors in queue	
40	"Voltage self test error, output 1"	No. 1/A amplifier in Master source has no output during Self-test.	Contact CI service department at support@programmablepower.com
41	"Voltage self test error, output 2"	No. 2/B amplifier in Master source has no output during Self-test. Three phase models only.	Contact CI service department at support@programmablepower.com
42	"Voltage self test error, output 3"	No. 3/C amplifier in Master source has no output during Self-test. Three phase models only.	Contact CI service department at support@programmablepower.com
43	"Current self test error, output 1"	No. 1/A amplifier in Aux. Source has no output during Self-test.	Contact CI service department at support@programmablepower.com
44	"Current self test error, output 2"	No. 2/B amplifier in Aux. Source has no output during Self-test. Three phase models only.	Contact CI service department at support@programmablepower.com
45	"Current self test error, output 3"	No. 3/C amplifier in Aux. Source has no output during Self-test. Three phase models only.	Contact CI service department at support@programmablepower.com
403	"CAL not enabled"	No password entered for calibration	Enter correct CAL password.
801	"Output volt fault"	<ul style="list-style-type: none"> - Output voltage does not match program value when ALC is on. - Over load - Voltage kick-back - No output voltage 	<p>Load exceeds current limit and unit is in Constant Voltage (CV) mode of operation.</p> <ul style="list-style-type: none"> - Reduce load or increase CL setting. <p>Output voltage is driven above programmed voltage by external</p>

Number	Message String	Cause	Remedy
			influence (Load, voltage kickback, etc.)
802	"Current limit fault"	Current limit exceeded.	Load exceeds current limit and unit is in Constant Voltage (CV) mode of operation. Reduce load or increase CL setting
803	"Temperature fault"	Amplifier heat sink temp. too high.	Reduce load. Ensure proper airflow and exhaust clearance. Check fan(s) for operation.
804	"External sync error"	Could not sync to external sync signal.	External sync signal missing, disconnected or out of range.
805	"Initial memory lost"	Initial settings could not be recalled at power-up.	Save power on settings again to overwrite old content.
806	"Limit memory lost"	Hardware configuration settings could not be recalled at power-up.	Contact CI service department at support@programmablepower.com to obtain instructions on restoring configuration data.
807	"System memory lost"	Memory corrupted during power-up.	Recycle power.
808	"Calibration memory lost"	Calibration data lost during power-up.	Contact CI service department at support@programmablepower.com to obtain instructions on restoring calibration data or recalibrate unit.
813	"Missing list parameter"	One or more transient list parameters missing.	Check programmed lists.
814	"Voltage peak error "	Peak voltage exceeds internal bus voltage	This error may occur when selecting user defined wave shapes with higher crest factors. Reduce programmed RMS value.
815	"Slew time exceed dwell"	Time needed to slew to final value is less than dwell time.	Check dwell times in transient list settings. Increase dwell time or change slew rate for affected parameter.
816	"Illegal during transient"	Operation requested not available while transient is running.	Wait till transient execution is completed or abort transient execution first.
817	"Output relay must be closed"	Transient programmed with output relay open.	Close relay before attempting transient operation.
819	"Clock and sync must be internal"	Operation not possible with external clock	Switch to internal sync. (Default)
820	"Input buffer full"	Too much data received.	Break up data in smaller blocks.
821	"PFC Input Fault "	AC input line related error.	Possibly due to low line input condition requiring too much input current.
822	"Waveform harmonics limit"	Harmonic contents of user defined wave shape is too high and could damage amplifier output stage.	Reduce harmonic content or reduce fundamental frequency programmed.
823	"Amplifier fault"	An amplifier failure. Can be reported at any time.	Determine which amplifier is at fault with self-test or checking amber LED's on amplifier control board. Replace amplifier.
825	"Over voltage prot trip"	Over voltage detected on output	Check output voltage for correct RMS value.
826	"Peak current prot trip"	Peak current limit	Peak current exceeded. Could be

Number	Message String	Cause	Remedy
		exceeded.	caused by switching EUT on or off.
827	"Frequency error"	Frequency error during self-test.	Correct frequency was not measured during self-test. May be result of 801 error.
828	"Phase error"	Self test error phase angle	Correct phase angle was not measured during self-test. May be result of 801 error.
829	"Dc component exceed limit"	DC value exceed limit for the voltage mode setting.	Select AC+DC mode instead of AC mode.
830	"Lan connection missing"	LAN Cable is not connected	Make sure the LAN cable is connected to a network.
831	"Duplicate IP,Set to DHCP"	It detect a duplicate IP on the network.	Change IP or Cycle power to connect to DHCP or Auto IP.
832	"Duplicate IP,REM set reject"	The IP set from remote interface is rejected.	The IP is rejected use different IP. It is a duplicate IP or out of reach IP.
833	"Duplicate IP,LOC set rejec"	The IP set from front panel keypad is rejected	The IP is rejected use different IP. It is a duplicate IP or out of reach IP.
834	"Out of reach IP"	The IP set is out of reach	Use an IP within the sub net.

Table 16-1: Error Messages

17. Index

160	28	error messages.....	152
704	28	Ethernet.....	21
A350.....	28	EXS.....	28, 63
Option	148	EXT.....	27, 28, 29, 64, 110
ABD.....	28	Ext. Trig.....	26
Option	147	external sync.....	42
ABL.....	27, 28, 109	factory	
ABLE.....	73	default power on setting.....	91
ATLAS.....	27, 28	Finish	
Acoustic Noise	23	paint.....	23
address		Frequency Range	15
GPIB	72	front panel	50
IEEE.....	72	lock	51, 54
Airbus		Function Strobe	21, 26
DO160.....	118	Functional Test.....	46
ALC		GPIB	27
state.....	64	Setup	49
AMD	28	GPIB connector	44
Option	149	Hold-Up Time	13
Arbitrary waveforms		IEEE-488	21
Frequency response restrictions	83	Immunity.....	24
arrow keys	52	initialization	
ATLAS	109	changing	91
B787.....	28	Input	
Back key	53	AC	37
baud rate	72	Inrush Current.....	13
blinking		installation	34
parameter entry	52	Introduction.....	11
Boeing 787		Isolation Voltage	13
Option	150	Keypad	25
bus address		Keys	
setting	72	Menu.....	53
calibration		LAN	21, 28
password.....	96	MAC Address	45
Calibration password.....	75	Settings.....	73
CE" mark	24	Setup	49
Clock and lock mode.....	48	language	
Clock and Lock option	31	programming.....	73
clock mode.....	63	LCD	
Construction		viewing angle	75
internal	23	LCD display	55
controller assembly	94	LED	101
Controllers		LED indicators	101
programmable	26	Line Current:.....	13
Cooling	23	Line Frequency	13
custom waveforms	82	Line VA:.....	13
creating	82	list transient	87
deleting	82	LKM.....	28
downloading	82	LKS	28
Dimensions	23	LOCAL key	53
Distorted output	102	MAC Address	45
DO160		maintenance.....	101
Airbus.....	118	Material	
Option	113	chassis.....	23
Efficiency	13	Meas key	53
Emissions	24	Menu key.....	53
Enter key	55	Menu keys	53

MIL-STD 704		sense.....	101
Option	133	wiring	38
Mode		Set key	53
output.....	26	SET mode	52
MODE.....	27, 28	setting	
Noise	14	baud rate.....	72
Offset Voltage		GPIB address.....	72
DC.....	14	Shock	24
Options		Short Circuit	
-160.....	113	current	22
-704.....	133	shuttle.....	52
-A350	148	SET mode	52
-ABD	147	Shuttle	
-AMD.....	149	IMMEDIATE mode	52
-B787	150	status	51
-WHM.....	151	step transient	86
output		temperature	
frequency	61	over.....	51
on/off key	53	Temperature	
voltage	61	operating,storage	24
Output Coupling	14	top cover	
Output Impedance	14	removal	103
output relay	53	transient	
Overcurrent.....	22	execution	90
overload.....	51	Transient list	
Overtemperature.....	22	execution	68
password		transients	
calibration.....	96	list	87
Password		pulse	87
Calibration	75	step.....	86
phase angle	61	switching waveforms	89
PIP		Transients	
9012.....	109	Front panel data entry	70
Power Factor	13	Input.....	22
power on screens.....	56	Trigger	
power-on setting	71	input.....	21
Programming manual	12	Trigger Out	21
pulse transient	87	troubleshooting	101
Rear panel	36	UP key.....	55
Regulation.....	64	USB.....	21
Relay		baudrate setting	72
output.....	26	Setup	49
remote control	51	Vibration	24
Remote Inhibit.....	92	viewing angle	25
replacement parts	107	adjustment	75
RMS	27, 28	voltage drop	
RPF	27, 28	cables	37, 38
-RPF	31	voltage rating	34
RPV	27, 28, 64, 111	Watt Hour Meter	
RS232	21	Option	151
Setup	49	Weight.....	23
RS232 connector	43	WHM.....	27, 29
Safety	24	Wiring	
SCPI.....	73	AC input	37