

# User Manual

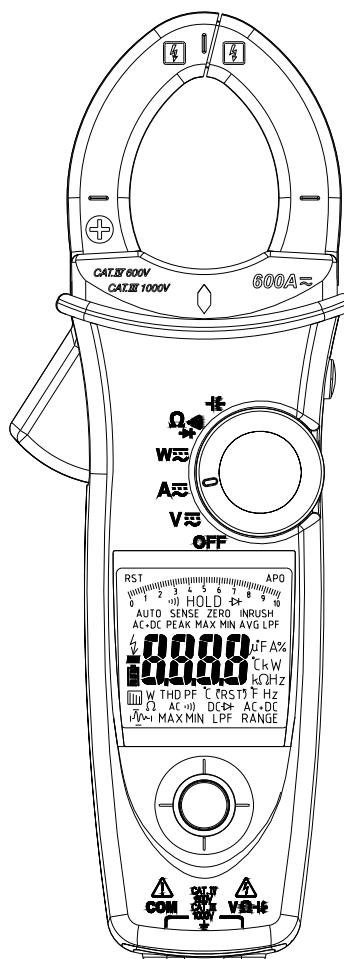

Solar  
Power  
Clamp



**TRANSCAT**<sup>®</sup>  
Trust in every measure

Visit us at [Transcat.com](http://Transcat.com)

[sales@transcat.com](mailto:sales@transcat.com) 1.800.828.1470

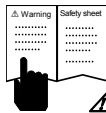

**⚠ Read First**

### **⚠ Safety Information**

Understand and follow operating instructions carefully. Use the meter only as specified in this manual; otherwise, the protection provided by the meter may be impaired.

#### **⚠ WARNING**

Identifies hazardous conditions and actions that could cause **BODILY HARM** or **DEATH**

#### **⚠ CAUTION**

Identifies conditions and actions that could **DAMAGE** the meter or equipment under test











#### **⚠ WARNING**

- When using test leads or probes, keep your fingers behind the finger guards.
- Remove test lead from Meter before opening the battery door or Meter case.
- Use the Meter only as specified in this manual or the protection by the Meter might be impaired.
- Always use proper terminals, switch position, and range for measurements.
- Verify the Meter's operation by measuring a known voltage. If in doubt, have the Meter serviced.
- Do not apply more than the rated voltage, as marked on Meter, between terminals or between any terminal and earth ground.
- Use caution with voltages above 30 Vac rms, 42 Vac peak, or 60 Vdc. These voltages pose a shock hazard.
- To avoid false readings that can lead to electric shock and injury, replace battery as soon as low battery indicator.
- Disconnect circuit power and discharge all high-voltage capacitors before testing resistance, continuity, diodes, or capacitance.
- Do not use Meter around explosive gas or vapor.
- To reduce the risk of fire or electric shock do not expose this product to rain or moisture.

### **⚠ CAUTION**

- Disconnect the test leads from the test points before changing the position of the function rotary switch.
- Never connect a source of voltage with the function rotary switch in  $\Omega$ ,  $\nabla$ , position.
- Do not expose Meter to extremes in temperature or high humidity.
- Never set the meter in  $\Omega$ ,  $\nabla$ , function to measure the voltage of a power supply circuit in equipment that could result in damage the meter and the equipment under test.

### **Symbols as marked on the Meter and Instruction manual**

	Risk of electric shock
	See instruction card
	DC measurement
	Equipment protected by double or reinforced insulation
	Battery
	Earth
	AC measurement
	Conforms to EU directives
	Application around and removal from hazardous live conductors is permitted
	Do not discard this product or throw away.

### **Unsafe Voltage**

To alert you to the presence of a potentially hazardous voltage, when the Tester detects a voltage  $\geq 30$  V or a voltage overload (OL) in V . The  symbol is displayed.

### **Maintenance**

Do not attempt to repair this Meter. It contains no userserviceable parts. Repair or servicing should only be performed by qualified personnel.

### **Cleaning**

Periodically wipe the case with a dry cloth and detergent. Do not use abrasives or solvents.

---

## Feature

- 10000 Count digital display
- Active Backlit, Large scale display
- VoltSense (None Contact Voltage)
- Analog Bar graph
- True RMS reading on AC and AC+DC mode
- Torch lightening when clamping
- Auto AC/DC 600 Amps capability and selection
- Auto AC/DC 1000 Volts capability and selection
- Auto Ohms/Continuity/Diode selection
- 100K Resistance capability
- Continuity Beeper
- Frequency Counter
- Power and Power factor measurement
- Total Harmonics distortion and Harmonics 1 to 25
- Capacitance capability
- Inrush Current
- DCA Auto-Zeroing Key
- Peak Hold
- MIN/MAX HOLD
- Smart Data Hold
- Phase rotation indication
- Low pass Filter
- Auto Power Off
- CAT.IV 600V / CAT.III 1000V Safety Standard

## Unpacking and Inspection

Upon removing your new Power Clamp Meter from its packing, you should have the following items:

1. APPA 130 Series Power Clamp Meter
2. Test leads. set (one black, one red)
3. User Manual
4. Carrying case
5. Battery Installed

## The Meter Description

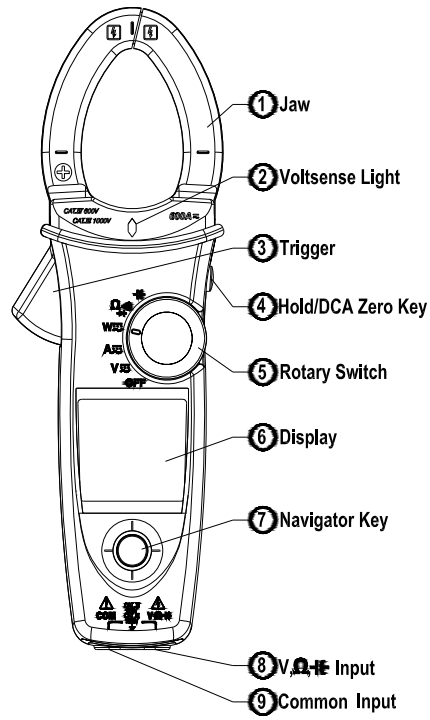

## Power On/ Off

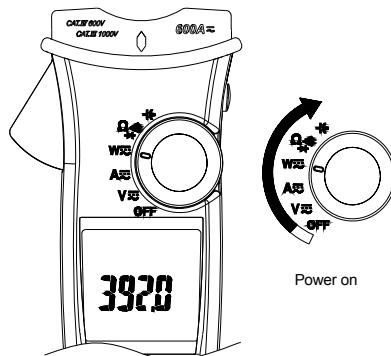

---

## **Auto Power Off**

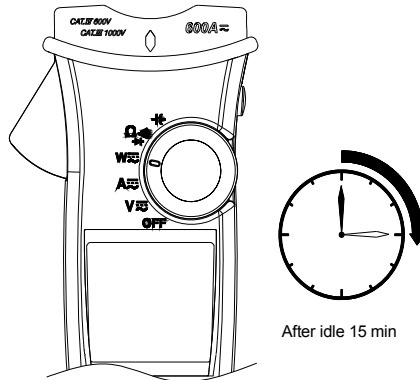

The meter can work again by turning it on from the OFF position.

### **Auto Power Off (APO) disable :**

Press "Downward" of Navigator key while tuning meter on from OFF position.

### **Navigator KEY**

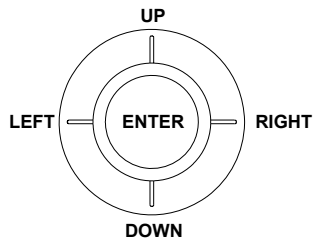

The Navigator Key has 5 directions of switch on the display, toggle the navigator key to select the desired feature to activate the feature by a simple click.

## Making Basic Measurements

Preparation and Caution Before Measurement

**⚠** : **Observe the rules** of **⚠** Warnings and **⚠** Cautions  
The figures on the following pages show how to make basic measurements.

When connecting the test leads to the **DUT** (Device Under Test) connect the common test lead before connecting the live lead ; when removing the test leads, remove the test live lead before removing the common test lead.

### Measuring Voltage

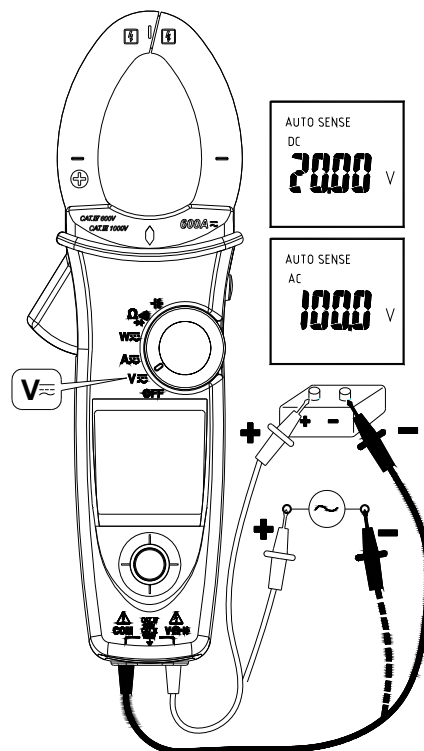

### **⚠ Warning**

To avoid electrical shock, hazard or damage to meter, do not attempt to measurement that might exceed 1000 V DC or AC RMS. Do not apply more then 1000 V DC or AC RMS between the comment input terminal and earth ground.

Note - If the measured voltage is greater than 30 V DC or AC RMS, the display will show the " ⚡ " symbol.

### **Measuring Current**

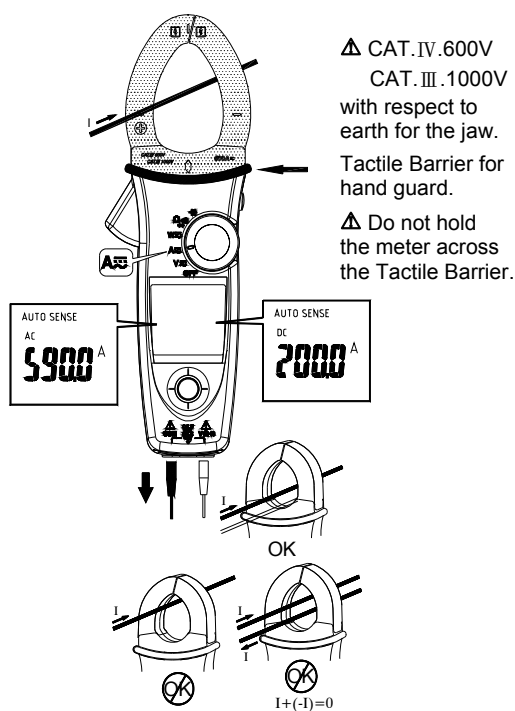

### **⚠ Caution**

Please do not measure current from clamp jaw when temperature probe is connected to meter.

- Don't clamp on any conductor while the meter power on.
- Torch lightening when clamping.



### AUTO SENSE mode :

Display measurement result at AC only with RMS value or DC value, it depends on whichever is greater.

**AC mode** : AC only with RMS value.

**DC mode** : DC value.

**AC+DC mode** : AC+DC RMS value.

### Note

- Select " AC", " DC" or " AC+DC" indicator then press the navigator key to enter the AC/DC/AC+DC mode.
- Select " AC", " DC" or " AC+DC" indicator then press the navigator key for more than 2sec to return to the AUTO SENSE mode.

### PEAK HOLD $\sqrt{\text{m}}$ (AC mode only)

1. In ACV mode, select "  $\sqrt{\text{m}}$  " indicator on the display to enter PEAK HOLD mode. To quit from PEAK HOLD mode, press the navigator key for more than 2sec.

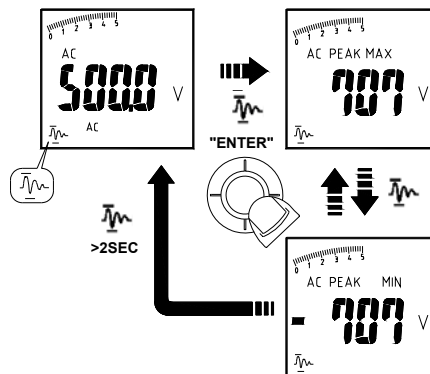

2. In ACA mode, select "  $\sqrt{\text{m}}$  " indicator then press the navigator key for more than 2sec to enter PEAK HOLD  $\sqrt{\text{m}}$  mode. To quit from PEAK HOLD  $\sqrt{\text{m}}$  mode, just press the navigator key for more than 2sec to return to the "  $\sqrt{\text{m}}$  " indicator.

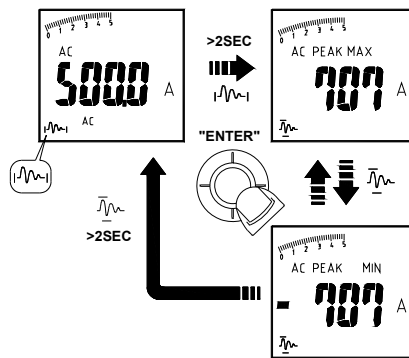

In PEAK HOLD mode, the meter is activated to save the positive peak value and negative peak value. Positive peak value is displayed in PEAK MAX mode. Negative peak value is displayed in PEAK MIN mode.

**Inrush current**  $i_{\text{inrush}}$  : (AC mode only)

If the under testing Inrush current could be bigger than 100A ac, please select the range to 600A in advance before activating inrush current.

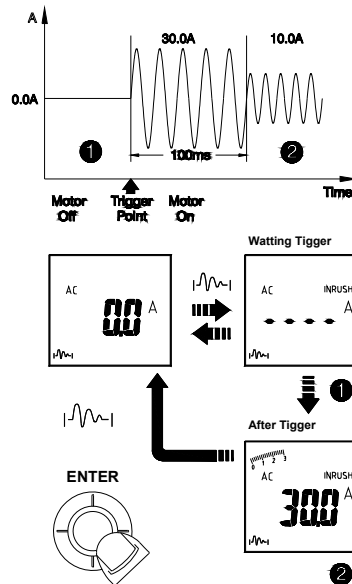

### DCA ZERO

Remove the jaw out of the conductor.

Press HOLD Key > 2 Sec to compensate the residual magnetism.

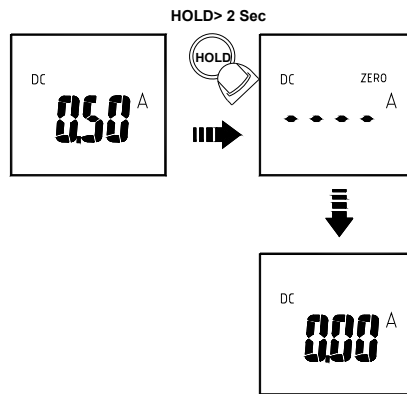

- DCA Zero is only available in Auto Sense, DC and AC+DC mode.

### Measuring Frequency (AC mode only)

Select the "Hz" indicator then press the navigator key to enter/exit the frequency measurement mode.

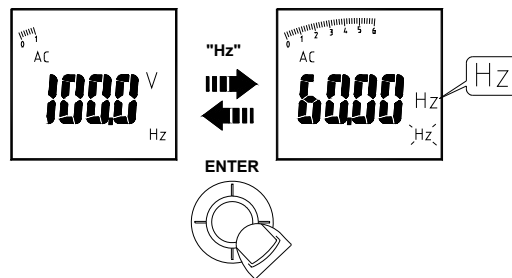

## MAX/MIN/AVG

Select the "MAX MIN" indicator then press the navigator key to enter the MAX/MIN/AVG mode. To quit from the MAX/MIN/AVG mode, press the navigator key for more than 2sec.

The MAX/MIN/AVG mode records the minimum and maximum input values. When the inputs go below the record minimum value or above the record maximum value, the meter records the new value. The MAX/MIN/AVG mode can also calculate the average of the maximum value and the minimum value.

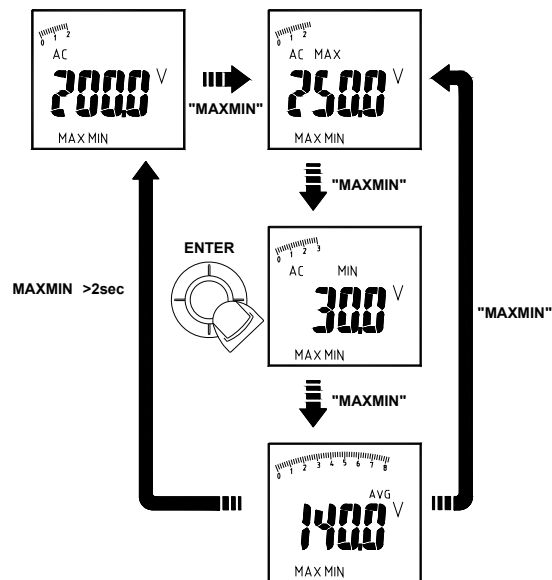

### NOTE :

- Press HOLD key in MAX MIN mode to make the meter stop updating the maximum and minimum value. When the HOLD mode is nested in MAX MIN mode, the HOLD mode must be released before the MAX MIN mode.

### THD Measurement (AC mode only)

Select the "THD" indicator then press the navigator key to enter the THD mode. THD-F=RMS of Harmonics ÷ RMS of fundamental ×100%. (harmonics up to the 25<sup>th</sup>)

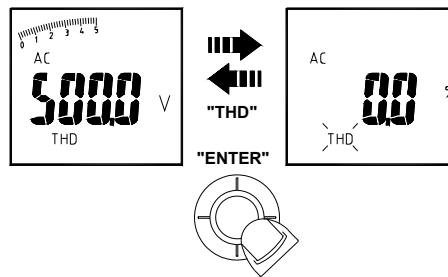

### Individual Harmonic Measurement (AC mode only)

Select the "Hn" indicator then press the navigator key to enter the individual harmonic mode. To quit from the individual harmonic mode, press the navigator key for more than 2sec. Hn=RMS of Individual Harmonic ÷ RMS of fundamental ×100%.

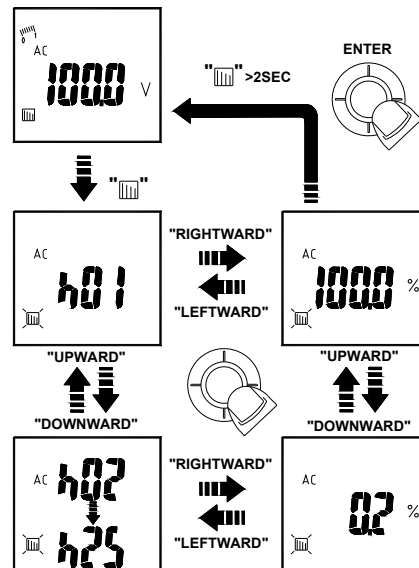

### LPF(AC mode only)

Select the "LPF" indicator then press the navigator key to eliminate high frequency noise.

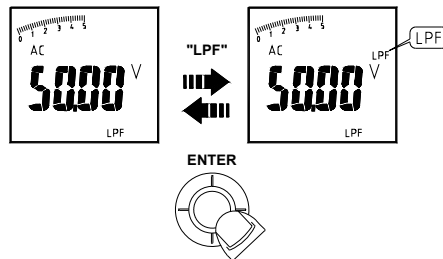

### NOTE :

Peak Hold, Inrush, THD, HZ, individual Harmonic and LPF mode are only available in AC mode.

## Measuring Active power(W)/Power factor(PF)

### 1.Single Phase Power Measurement

- Step1. Set the rotary switch to the "W" position.
- Step2. Connect the Red test lead to the L, and the Black test lead to the N.
- Step3. Press the trigger to open the transformer jaws and clamp one conductor only, make sure that the jaw is firmly closed around the conductor.
- Step4. Using the Navigator key to choose the "W/PF" mode.

### NOTE :

- The "+" symbol on the jaw must face on the power source side.
- In AutoSense mode, The meter will displays ACW/DCW depends on if there has AC frequency been detected.

### Active power sign :

**No sign** : Indicates the power flows from the power source to the load.

**"\_" sign** : Indicates the power flows from the load to the power source.

**Power factor sign :**

**No sign :** The phase of the current signal is lagging behind the voltage signal (inductive load).

**"\_ " sign :** The phase of the current signal is leading the voltage signal (capacitive load).

**Overrange display :**

**OL.U :** Voltage overload

**OL.A :** Current overload

**OL.UA :** Both Voltage and current overload.

**± OL kW :** Active Power > 600 kW or < -600 kW.

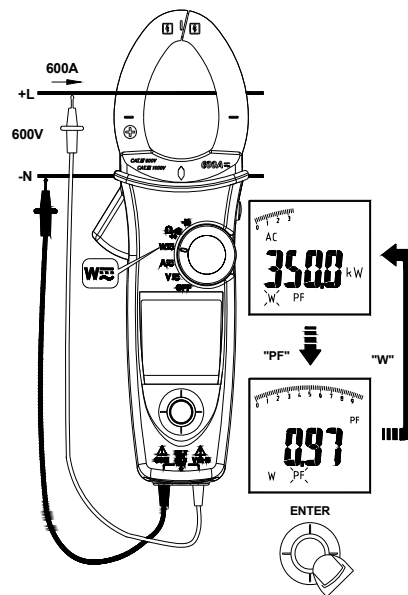

---

## 2. Three Phase Power Measurement

### A. 3 phase 3 wire balanced / unbalanced

Step1. Set the rotary switch to the "W" position

Step2. Using the Navigator key to choose the "W" mode.

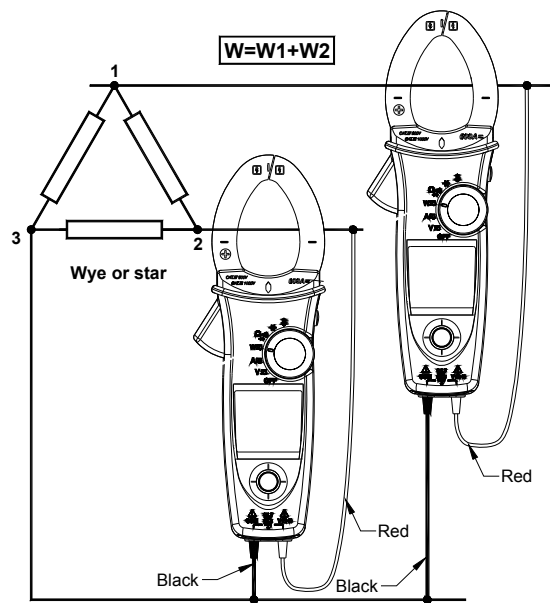



**b. 3 phase 4 wire balanced / unbalanced**

Step1. Set the rotary switch to the "W" position

Step2. Using the Navigator key to choose the "W" mode.

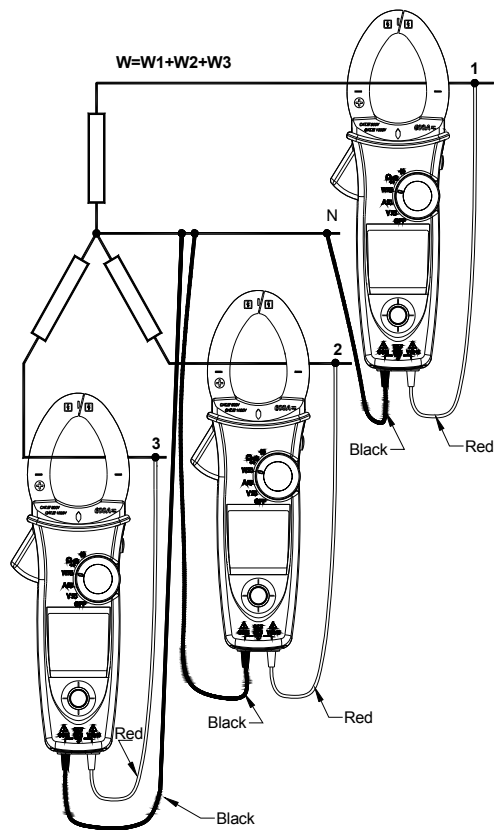

## Phase Rotation

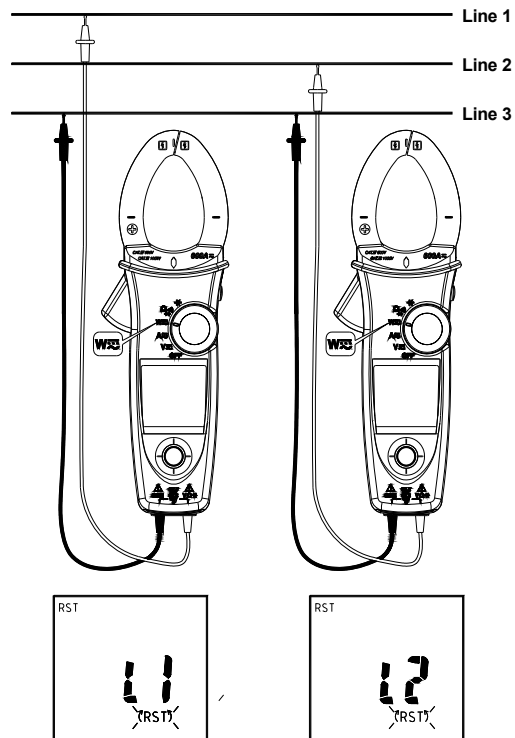

### NOTE :

- Connect the supposed three phase of power source as shown above.
  - The test is only available while the system frequency is stable.
- Step 1. Set the rotary switch to the "W" position.
- Step 2. Using the Navigator key to choose the " (RST) " mode
- Step 3. Connect the Red test lead to the supposed phase Line 1, and the Black test lead to the supposed phase Line 3.
- a. if volt > 1000V, it will display "OLU" and flash; if volt < 30V, it will display "LoU"
  - b. If the frequency > 65Hz or < 45Hz, it will display "outF" and flash.
  - c. If it is normal, then it will display "L1" and flash for about 3 sec.

Step 4. If it displays "L2", then BUZZER will be sound for twice.  
Please switch the Red test lead to connect to the supposed phase Line 2 immediately before the " L2 " is disappeared.

Step 5. When "L2" is disappeared, it will display the testing result.

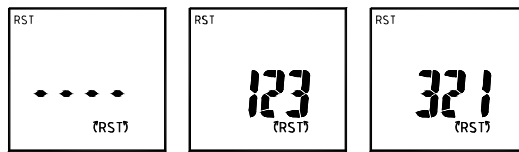

- a. If it displays " 1 2 3 ", then the phase sequence is forward sequence, which means the supposed phase Line 1 is ahead of the supposed phase Line 2.
- b. If it displays " 3 2 1 ", then the phase sequence is reversed sequence, which means the supposed phase Line 2 is ahead of the supposed phase Line 1.
- c. Display " — — — — " means it is unable to judge.
- d. If displays "LoU", it is possible that you remove the test leads before completing the whole testing procedures.

Step 6 : To repeat the test, using the Navigator key to choose the " (RST) " mode again.

### OHM Measurement

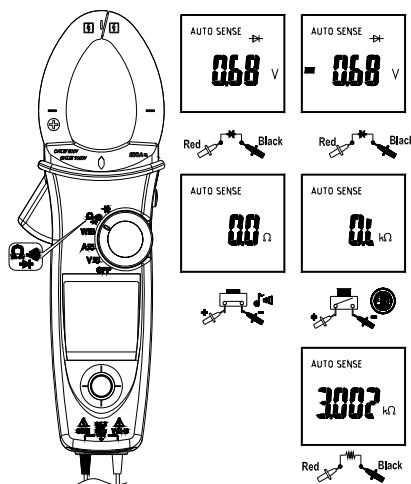

**⚠ CAUTION**

To avoid possible damage to the Meter or to the equipment under test, disconnect circuit power and discharge all high - voltage capacitors before measuring resistance and diode.

**Note :**

- Select "Ω", "∞" or "▶" indicator then press the navigator key to enter the Ω/∞ / ▶ mode.
- Select "Ω", "∞" or "▶" indicator then press the navigator key for more than 2sec to return to the AUTO SENSE mode.

Note - Under diode mode, LCD displays "bad" when measuring a diode conducted at forward and reverse bias.

**Measuring Capacitance**

Set the rotary switch to the "⚡" position.

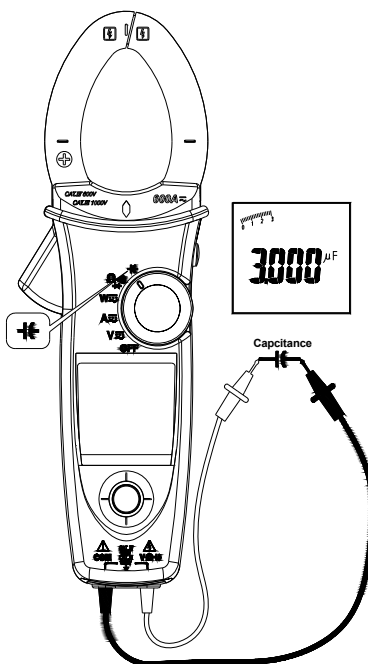

**⚠ CAUTION**

To avoid possible damage to the meter or to the equipment under test, disconnect circuit power and discharge all high-voltage capacitors before measuring capacitance. Use the DC voltage function to confirm that the capacitor discharged.

Note - The meter will display "diSC" while discharging the capacitor.

**Other Function :**

**AUTO/MANUAL RANGE**

Select the "RANGE" indicator then press the navigator key to enter the manual range mode. To return to the auto range mode, press the navigator key for more than 2sec.

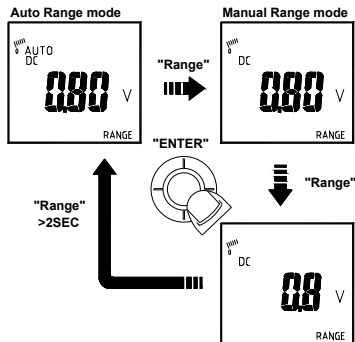

## HOLD Key

Press HOLD key to freeze display value.

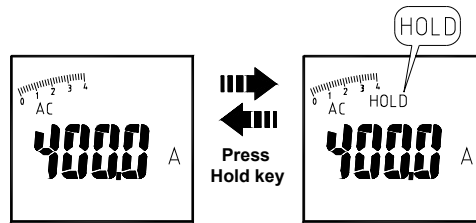

**SMART HOLD** : The meter will beep continuously and the display will flash if the measured signal is larger than the display reading. (for V.A.W function)

## VoltSense :

The red diamond shape of LED will illuminate, If there has electric field been detected from the jaw.

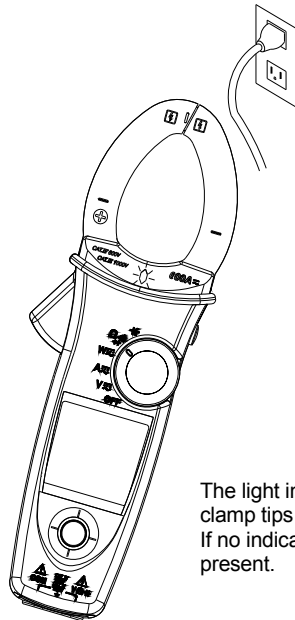

### **⚠ Caution**

The light indicator turns on while the clamp tips are close to a electric field. If no indication, voltage could still be present.

## Buzzer

The Meter beeps once for every valid key-press, and beeps twice for every invalid key-press.

## Power-up options:

Press one of the following keys while tuning meter on from OFF position.

**Upward of Navigator key** : Display of the software version.





**Downward of Navigator key** : Disable auto power off.

**Leftward of Navigator key** : Disable active backlight.

**HOLD KEY** : Display all LCD symbols approx 10sec.

## Battery State display

User can know the battery state from the battery indicator.

Batter State	Description
	The battery is full charged
	The battery is remained 2/3 power
	The battery is remained 1/3 power
	Replace the battery as soon as the low battery indicator appears, to avoid inaccurate reading.

## Battery Replacement

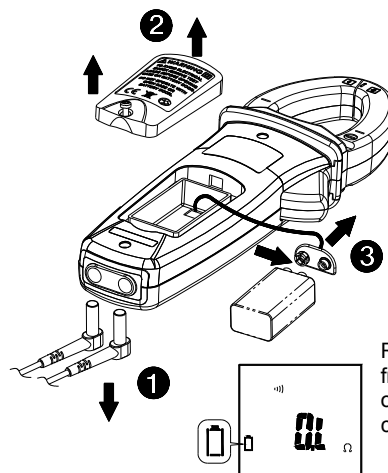

### ⚠ Caution

Remove test leads from Meter before opening the battery cover or Meter case.

---

## Specifications

### General Specifications

**Display count** : 10000 or 4000

**Measuring rate** : 3 times / sec.

**Overrange display** : "OL" or "-OL" .

**Auto Power Off** : Approx 15 minutes.

**Low battery indicator** : **■** is displayed. Replace the battery when the indicator **■** appears in the display.

**Power requirement** : 9V battery.

**Battery life** : ALKALINE 9V 50 hours (without Backlight).

**Dimensions** : 87.5mm(W) x 242mm(L) x 50.5mm(D)

**Weight** : approx. 435g (with battery)

### Environmental Conditions

**Indoor Use.**

**Calibration** : One year calibration cycle.

**Operating temperature** : 0 °C ~ 10 °C

10 °C ~ 30 °C (≤80% RH)

30 °C ~ 40 °C (≤75% RH)

40 °C ~ 50 °C (≤45%RH)

**Storage temperature** : -10 to 50 °C for current,  
-20 to 60 °C for other function,  
0 to 80% RH (batteries not fitted).

**Temperature coefficient** :

0.2 x (Specified accuracy) / °C, < 18°C, > 28°C .

**Over voltage category** : IEC 61010-1 600V CAT.IV.

1000V CAT.III.

**CAT**

**Application field**

I	The circuits not connected to mains.
II	The circuits directly connected to Low-voltage installation.
III	The building installation.
IV	The source of the Low-voltage installation.

**Operating altitude** : 2000m (6562 ft)

**Conductor Size** : 37mm diameter

**Pollution degree** : 2

**EMC** : EN 61326-1

**Shock vibration** : Sinusoidal vibration per MIL-T- 28800E  
(5 ~ 55 Hz, 3g maximum).

**Drop Protection** : 4 feet drop to hardwood on concrete floor.



## Electrical Specifications

Accuracy is  $\pm$ (% reading + number of digits) at 23°C  $\pm$  5°C < 80%RH.

### (1) Voltage

Function	Range	Accuracy*
DCV	99.99V	$\pm$ (0.7% + 2dgt)
	999.9V	
ACV	99.99V	$\pm$ (1.0% + 5dgt) 50 ~ 500Hz
	999.9V	
LPF ACV	99.99V	50 ~ 60Hz $\pm$ (1% + 5dgt)
	999.9V	>60 ~ 400Hz $\pm$ (5% + 5dgt)

\* DCV <1000dgt, add 6 dgt to the accuracy.

ACV <1000dgt, add 3 dgt to the accuracy.

**Overload protection :** 1000V<sub>rms</sub>

**Input Impedance :** 3.5M $\Omega$  // <100pF

**AC Conversion Type :** AC Conversions are ac-coupled, true RMS responding, calibrated to the RMS value of a sine wave input. Accuracies are given for sine wave at full scale and non-sine wave below half scale. For non-sine wave (50/60Hz) add the following Crest Factor corrections:

For Crest Factor of 1.4 to 2.0, add 1.0% to accuracy.

For Crest Factor of 2.0 to 2.5, add 2.5% to accuracy.

For Crest Factor of 2.5 to 3.0, add 4.0% to accuracy.

CF 3 @ 460V, 280A

2 @ 690V, 420A

**AC+DC Vrms Accuracy :** same as ACV spec. +DCV spec.

## (2) Current

Function	Range	Accuracy
DCA	99.99A	$\pm (1.5\% + 0.2A)$
	599.9A	$\pm (1.5\% + 5dgt) *$
ACA	0.10A ~ 99.99A	50 ~ 60Hz $\pm (1.5\% + 5dgt) *$
	599.9A	>60 ~ 400Hz $\pm (2\% + 5dgt) *$
LPF ACA	0.10A ~ 99.99A	50 ~ 60Hz $\pm (1.5\% + 5dgt) *$
	599.9A	>60 ~ 400Hz $\pm (5\% + 5dgt) *$

\* The measured value <1000dgt, add 5 dgt to the accuracy.

Overload protection : 600A<sub>rms</sub>

Position Error :  $\pm 1\%$  of reading.

AC Conversion Type and additional accuracy is same as AC Voltage.

**AC+DC Arms Accuracy** : Same as ACA spec + DCA spec.

- DCA affected by the temperature and the residual magnetism.  
Press HOLD key > 2sec to compensate it.

## (3) Peak Hold : Peak MAX / Peak MIN

Function	Range	Accuracy
ACV	140.0V	$\pm (3.0\% + 15dgt)$
	1400V	
ACA	140.0A	$\pm (3.0\% + 15dgt)$
	850A	

Overload protection : 1000 V<sub>rms</sub> / 600 A<sub>rms</sub>

Accuracy defined for :

Sine wave, ACV>5V<sub>rms</sub> / ACA $\geq$ 5A<sub>rms</sub>, Freq.50~400Hz.

- Only suitable for the repetitive events.

#### (4) Frequency

Function	Range	Accuracy
Frequency	20.00 ~ 99.99Hz	± (0.5% + 3dgt)
	20.0 ~ 999.9Hz	
	0.020 ~ 9.999KHz	

**Overload protection :** 1000  $V_{rms}$  / 600  $A_{rms}$

**Sensitivity :**

10~100Vrms for AC 100V range

10~100Arms for AC 100A range ( >400Hz Unspecified)

100~1000Vrms for AC 1000V range

100~600/1000Arms for AC 600A/1000A range

( >400Hz Unspecified)

- Reading will be 0.0 for signals below 10.0 Hz.

#### (5) Total Harmonic Distortion :

Function	Range	Accuracy
ACA /ACV	99.9%	± (3.0% + 10dgt)

**Harmonic distortion measurement :**

Harmonic order	Range	Accuracy
H01 ~ H12	99.9%	± (5% + 10dgt)
H13 ~ H25		± (10% + 10dgt)

**Overload protection :** 1000  $V_{rms}$  / 600  $A_{rms}$

– If ACV<10Vrms or ACA <10Arms, it will display “rdy”.

– If the fundamental frequency out of range 45 ~ 65Hz, it will display “out.F”.

**(6) Inrush Current :**

Function	Range	Accuracy
ACA	99.99A	$\pm (2.5\% + 0.2A)$
	599.9A	$\pm (2.5\% + 5dgt)$

**Overload protection :** 1000  $V_{rms}$  / 600  $A_{rms}$

**Accuracy defined for :**

Sine wave,  $ACA \geq 10A_{rms}$ , Freq. 50/60Hz  
- Integration time about 100m sec

**(7)Active Power : Watt (DC/AC)**

Function	Range	Accuracy
ACW / DCW	9.999 kW*	$A_{error} \times V_{reading} + V_{error} \times A_{reading}$
	99.99 kW	
	599.9kW	

\* The measured value < 1.000kW , add 10 dgt to the accuracy.

**Overload protection :** 1000  $V_{rms}$  / 600  $A_{rms}$

**Accuracy defined for :**

ACW :

Sine wave ,  $ACV \geq 10 V_{rms}$ ,  $ACA \geq 5 A_{rms}$   
Freq. 50~60Hz, PF=1.00

DCW :

DCV  $\geq 10V$  , DCA  $\geq 5 A$

**(8) Power Factor**

Function	Range	Accuracy
PF	-1.00 ~ 0.00 ~ 1.00	$\pm 3^\circ \pm 1dgt$

**Overload protection :** 1000  $V_{rms}$  / 600  $A_{rms}$

**(9) Resistance & Continuity & Diode :**

Function	Range	Accuracy
Resistance	999.9 $\Omega$	$\pm (1.0\% + 5\text{dgt})$
	9.999 k $\Omega$	$\pm (1.0\% + 3\text{dgt})$
	99.99 k $\Omega$	
Continuity	999.9 $\Omega$	$\pm (1.0\% + 5\text{dgt})$
Diode	0.40~ 0.80V	$\pm 0.1V$

**Overload protection :** 1000V<sub>rms</sub>

**Max. Test Current :** Approx. 0.5mA.

**Maximum Open Circuit Voltage for  $\Omega$ ,  $\text{M}$  :** Approximate 3V

**Maximum Open Circuit Voltage for diode :** Approximate  $\pm 1.8V$

**Continuity Threshold :** < 30 $\Omega$  Beep On.

> 100 $\Omega$  Beep OFF.

**Continuity Indicator :** 2 KHz Tone Buzzer

**Continuity response time :** < 100ms.

**(10) Capacitance :**

Function	Range	Accuracy
Capacitance	3.999 $\mu\text{F}$	$\pm (1.9\% + 8\text{dgt})$
	39.99 $\mu\text{F}$	
	399.9 $\mu\text{F}$	
	3999 $\mu\text{F}$	

**Overload protection :** 1000 V<sub>rms</sub>

---

### **Limited Warranty**

This Meter is warranted to the original purchaser against defects in material and workmanship for 2 years from the date of purchase. During this warranty period, manufacturer will, at its option, replace or repair the defective unit, subject to verification of the defect or malfunction.

This warranty does not cover fuses, disposable batteries, or damage from abuse, neglect, accident, unauthorized repair, alteration, contamination, or abnormal conditions of operation or handling.

Any implied warranties arising out of the sale of this product, including but not limited to implied warranties of merchantability and fitness for a particular purpose, are limited to the above.

The manufacturer shall not be liable for loss of use of the instrument or other incidental or consequential damages, expenses, or economic loss, or for any claim or claims for such damage, expense or economic loss. Some states or countries laws vary, so the above limitations or exclusions may not apply to you.



Seaward Electronic Ltd  
15-18 Bracken Hill, South West Industrial Estate  
Peterlee, County Durham, UK  
SR8 2SW  
Tel: +44 (0)191 586 3511  
Fax: +44 (0) 191 586 0227  
Email: [enquiry@seawardsolar.com](mailto:enquiry@seawardsolar.com)  
[www.seawardsolar.com](http://www.seawardsolar.com)

**TRANSCAT**<sup>®</sup>  
Trust in every measure

Visit us at [Transcat.com](http://Transcat.com) ▶

[sales@transcat.com](mailto:sales@transcat.com) 1.800.828.1470