

**TRANSCAT**

▶ Visit us at [Transcat.com](http://Transcat.com)!

**FLUKE**®

Calibration

35 Vantage Point Drive // Rochester, NY 14624 // Call 1.800.800.5001

# 3130

Portable Pressure Calibrator

## Users Manual

PN 4222409

February 2013

© 2013 Fluke Corporation. All rights reserved. Specifications are subject to change without notice.  
All product names are trademarks of their respective companies.

## LIMITED WARRANTY AND LIMITATION OF LIABILITY

Each Fluke product is warranted to be free from defects in material and workmanship under normal use and service. The warranty period is one year and begins on the date of shipment. Parts, product repairs, and services are warranted for 90 days. This warranty extends only to the original buyer or end-user customer of a Fluke authorized reseller, and does not apply to fuses, disposable batteries, or to any product which, in Fluke's opinion, has been misused, altered, neglected, contaminated, or damaged by accident or abnormal conditions of operation or handling. Fluke warrants that software will operate substantially in accordance with its functional specifications for 90 days and that it has been properly recorded on non-defective media. Fluke does not warrant that software will be error free or operate without interruption.

Fluke authorized resellers shall extend this warranty on new and unused products to end-user customers only but have no authority to extend a greater or different warranty on behalf of Fluke. Warranty support is available only if product is purchased through a Fluke authorized sales outlet or Buyer has paid the applicable international price. Fluke reserves the right to invoice Buyer for importation costs of repair/replacement parts when product purchased in one country is submitted for repair in another country.

Fluke's warranty obligation is limited, at Fluke's option, to refund of the purchase price, free of charge repair, or replacement of a defective product which is returned to a Fluke authorized service center within the warranty period.

To obtain warranty service, contact your nearest Fluke authorized service center to obtain return authorization information, then send the product to that service center, with a description of the difficulty, postage and insurance prepaid (FOB Destination). Fluke assumes no risk for damage in transit. Following warranty repair, the product will be returned to Buyer, transportation prepaid (FOB Destination). If Fluke determines that failure was caused by neglect, misuse, contamination, alteration, accident, or abnormal condition of operation or handling, including overvoltage failures caused by use outside the product's specified rating, or normal wear and tear of mechanical components, Fluke will provide an estimate of repair costs and obtain authorization before commencing the work. Following repair, the product will be returned to the Buyer transportation prepaid and the Buyer will be billed for the repair and return transportation charges (FOB Shipping Point).

THIS WARRANTY IS BUYER'S SOLE AND EXCLUSIVE REMEDY AND IS IN LIEU OF ALL OTHER WARRANTIES, EXPRESS OR IMPLIED, INCLUDING BUT NOT LIMITED TO ANY IMPLIED WARRANTY OF MERCHANTABILITY OR FITNESS FOR A PARTICULAR PURPOSE. FLUKE SHALL NOT BE LIABLE FOR ANY SPECIAL, INDIRECT, INCIDENTAL, OR CONSEQUENTIAL DAMAGES OR LOSSES, INCLUDING LOSS OF DATA, ARISING FROM ANY CAUSE OR THEORY.

Since some countries or states do not allow limitation of the term of an implied warranty, or exclusion or limitation of incidental or consequential damages, the limitations and exclusions of this warranty may not apply to every buyer. If any provision of this Warranty is held invalid or unenforceable by a court or other decision-maker of competent jurisdiction, such holding will not affect the validity or enforceability of any other provision.

Fluke Corporation  
P.O. Box 9090  
Everett, WA 98206-9090  
U.S.A.

Fluke Europe B.V.  
P.O. Box 1186  
5602 BD Eindhoven  
The Netherlands

11/99

To register your product online, visit [register.fluke.com](http://register.fluke.com)

# Table of Contents

Title	Page
Introduction.....	1
How to Contact Fluke Calibration .....	2
Safety Information .....	2
Standard Equipment.....	3
Features.....	4
Buttons.....	4
Display.....	5
Calibrator Interface.....	6
Typical Connections.....	7
Power Options.....	9
Product Startup .....	9
Product Menus .....	9
Top-Level Menu.....	11
Main Menu .....	11
Display Configuration Menu .....	12
Zero Function.....	13
Internal Sensor and Pressure Module (non-absolute).....	13
Absolute Pressure .....	13
Other Menu Controlled Functions .....	14
Contrast Main Menu.....	14
Lock or Unlock the Display Configuration .....	14
Save and Recall Menu Setups .....	15
Automatic Shutdown .....	15
Activate and Deactivate a Display.....	16
Damping .....	16
HART Resistor .....	16
Pump Limits .....	16
Initial Setup and Basic Pressure Generation.....	17
Pressure Measurement .....	17
Media Compatibility.....	18
External Modules.....	18
Measure and Source Current (4... 20 mA).....	18
Measure Voltage.....	20
Pressure Switch Test.....	21
Calibrate Transmitters .....	23
Use the mA Measurement Function.....	23

Calibrate a Pressure-to-Current Transmitter .....	24
Calibrate a Pressure-to-Voltage Transmitter .....	25
%-Error Function .....	26
Storage Capability.....	29
Remote Operation .....	29
Set Up the RS-232 Port for Remote Control .....	30
Change from Remote to Local Operation.....	31
Command Use .....	31
Character Processing .....	32
Response Data Types .....	32
Calibrator Status .....	33
Error Queue .....	33
Input Buffer.....	33
Remote Commands and Error Codes .....	33
Enter Commands .....	36
Common Commands.....	36
Calibrator Commands .....	37
Maintenance.....	43
User-Replaceable Parts and Accessories .....	43
Specifications.....	44
Electrical Specification.....	44
Pressure .....	44
Accuracy.....	44
Loop Power .....	44
Mechanical Specification .....	44
Environmental .....	44
Standards and Agency Approval .....	45
Power.....	45

# ***List of Tables***

<b>Table</b>	<b>Title</b>	<b>Page</b>
1.	Symbols.....	3
2.	Mode Concurrency.....	13
3.	Common Commands.....	33
4.	Product Commands.....	34
5.	Parameter Units.....	35
6.	Error Codes.....	36
7.	Replaceable Parts.....	43



# List of Figures

Figure	Title	Page
1.	Buttons .....	4
2.	Display .....	5
3.	Controls .....	6
4.	External Pressure Supply .....	7
5.	Pressure Supply with Internal Pump .....	8
6.	Pressure Measurement .....	8
7.	Menu Map .....	10
8.	Top-Level Menu.....	11
9.	Main Menu .....	12
10.	Display Configuration Menu.....	12
11.	Absolute Pressure.....	13
12.	Contrast Menu .....	14
13.	Display Configuration Menu.....	14
14.	Setups Menu.....	15
15.	Auto Shutdown Menu .....	15
16.	Active Display Menu .....	16
17.	Pressure Module.....	18
18.	Measure and Sourcing Current.....	19
19.	Measure Voltage .....	20
20.	Switch Test Connections.....	21
21.	Switch Test Screen .....	21
22.	Switch Test Screen (Open).....	22
23.	Opened Switch Reading.....	22
24.	Switch Test and Deadband Results .....	23
25.	Passive and Active Screens .....	23
26.	Calibrate a Pressure-to-Current Transmitter .....	24
27.	Calibrate a Pressure-to-Voltage Transmitter.....	25
28.	Connections with a Pressure Transmitter with % Error Function.....	26
29.	Port Setting Screen .....	27
30.	Loop Power Screen .....	27
31.	Set Unit Screen.....	27
32.	Setting the Upper Limit.....	28
33.	% ERROR Screen .....	28
34.	Saved Upper and Lower Limits .....	28
35.	Remote Operation .....	29





## Introduction

The Fluke 3130 (the Product) is a portable pressure calibrator that can use two methods to source pressure:

- An internal, electronic pump that has a range of -12 psi to 300 psi (-0.8 bar to 20 bar)
- An external connection that lets you use externally-sourced, clean, dry air to regulate pressures to a maximum of 300 psi

Product features include:

- A built-in needle valve for metering in pressure
- Variable volume for small pressure changes
- An internal pressure sensor
- Measurement of 0 V dc to 30 V dc and 0 mA to 24 mA from a unit under test (UUT).
- Sourcing current of 0 mA to 24 mA to a UUT also available
- A 24 V dc loop power supply that uses dedicated front panel jacks. For voltage transmitters, a dedicated 24 V dc loop power supply is available in volts measure mode. mA loop power is supplied from the left-most jacks.
- An internal, high-capacity NiMH battery
- A universal power supply (90 V ac to 250 V ac) that can charge the battery pack while it powers the Product
- Pressure measurement with the internal pressure sensor or with a Fluke 700 Series external pressure module
- The Product can show pressure units in these different values:
  - psi
  - MPa
  - kPa
  - inHg 0°C
  - mmHg 0°C
  - kg/cm<sup>2</sup>
  - mmH<sub>2</sub>O 4°C
  - mH<sub>2</sub>O 20°C
  - inH<sub>2</sub>O 4°C
  - inH<sub>2</sub>O 60°C
  - cmH<sub>2</sub>O 4°C
  - cmH<sub>2</sub>O 20°C
  - bar
  - mbar

## How to Contact Fluke Calibration

To contact Fluke Calibration, call one of the subsequent telephone numbers:

- Technical Support USA: 1-877-355-3225
- Calibration/Repair USA: 1-877-355-3225
- Canada: 1-800-36-FLUKE (1-800-363-5853)
- Europe: +31-40-2675-200
- Japan: +81-3-6714-3114
- Singapore: +65-6799-5566
- China: +86-400-810-3435
- Brazil: +55-11-3759-7600
- Anywhere in the world: +1-425-446-6110

To see product information and download the latest manual supplements, visit Fluke Calibration's website at [www.flukecal.com](http://www.flukecal.com).

To register your product, visit <http://flukecal.com/register-product>.

## Safety Information

A **Warning** identifies conditions and procedures that are dangerous to the user. A **Caution** identifies conditions and procedures that can cause damage to the Product or the equipment under test.

### Warnings

**To prevent possible electrical shock, fire, or personal injury:**







- **Read all safety Information before you use the Product.**
- **Use the Product only as specified, or the protection supplied by the Product can be compromised.**
- **Do not use the Product around explosive gas, vapor, or in damp or wet environments.**
- **Do not use and disable the Product if it is damaged.**
- **Only assemble and operate high-pressure systems if you know the correct safety procedures. High-pressure liquids and gases are hazardous and the energy from them can be released without warning.**

**For safe operation and maintenance of the Product:**

- **Use only Fluke approved power adapters to charge the battery. See the "User-Replaceable Parts and Accessories" section.**

Symbols used on the Product and in this manual are in Table 1.

**Table 1. Symbols**

Symbol	Meaning	Symbol	Meaning
	Risk of danger. Important information. See manual.		Conforms to European Union directives.
	Pressure		Battery
	Hazardous voltage. Risk of electrical shock.		This product complies with the WEEE Directive (2002/96/EC) marking requirements. The affixed label indicates that you must not discard this electrical/electronic product in domestic household waste. Product Category: With reference to the equipment types in the WEEE Directive Annex I, this product is classed as category 9 "Monitoring and Control Instrumentation" product. Do not dispose of this product as unsorted municipal waste. Go to Fluke's website for recycling information.

### **Standard Equipment**

Items included with the Product are in the list below. If the Product is damaged or something is missing, immediately contact Fluke Calibration. See the "How to Contact Fluke Calibration" section.

- Printed *3130 Safety Information*
- *3130 Manual CD-ROM* with multilingual users manuals
- Six 1/8 inch NPT quick connectors for calibration hoses
- Two 3 foot sections of 1/8 inch O.D. hose
- One 1/8 inch NPT female on 1/4 inch NPT female fitting
- One 1/8 inch NPT female on 1/4 inch BSP female fitting
- Thread seal tape
- Test cables (two red, two black)
- Universal power supply
- Traceable calibration certificate

## Features

Product features and user interface information is in the subsequent sections.

### Buttons

The Product buttons are on the left-side of the Product face and are shown in Figure 1.

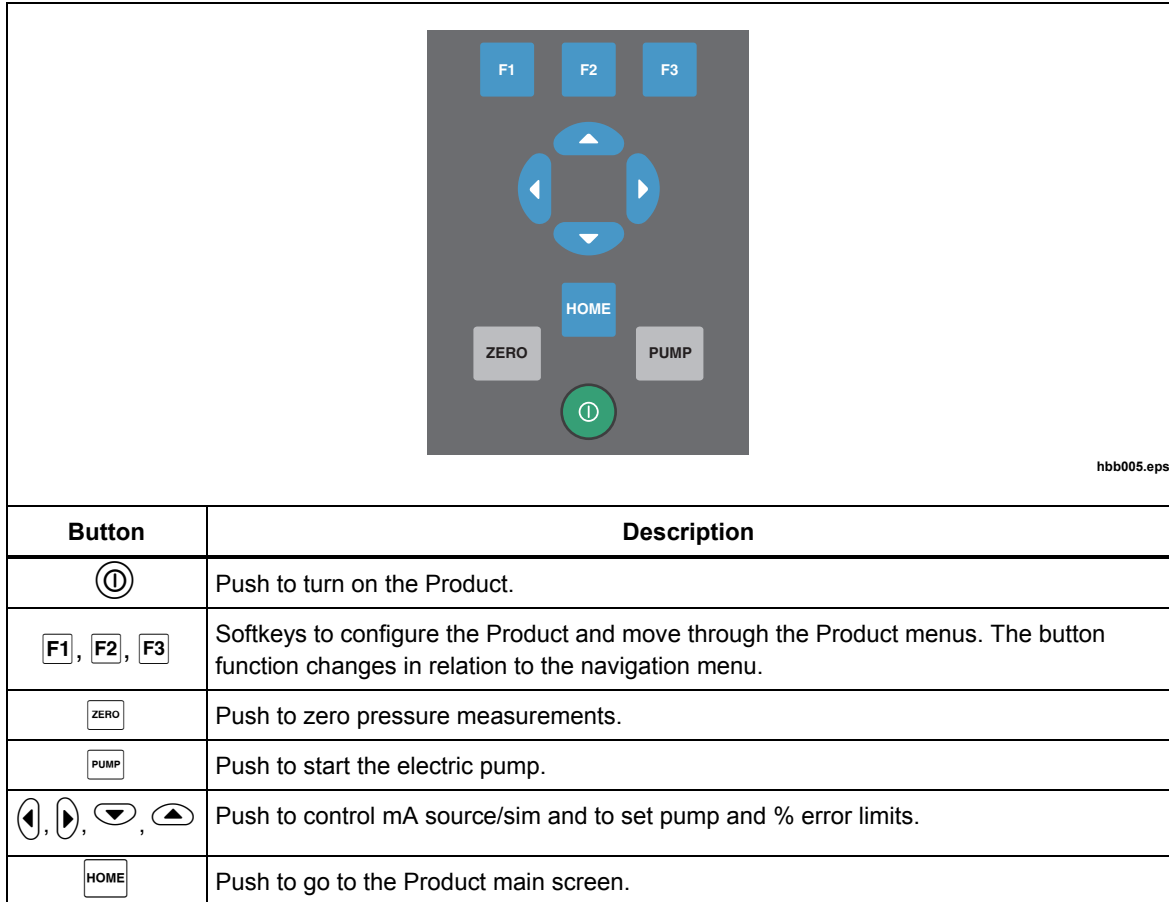

Figure 1. Buttons

## Display

The display can be made up of a maximum of three process measurement sections plus the menu bar which is always at the bottom of the display. The sections of the display are referred to by the Product and in this manual as UPPER, MIDDLE, LOWER, and menu bar. Push the softkeys that correspond to items shown on the menu bar to move through the Product menus. The arrow keys change values for some menu steps. See “Product Menus”.

The Display sections are shown in Figure 2.

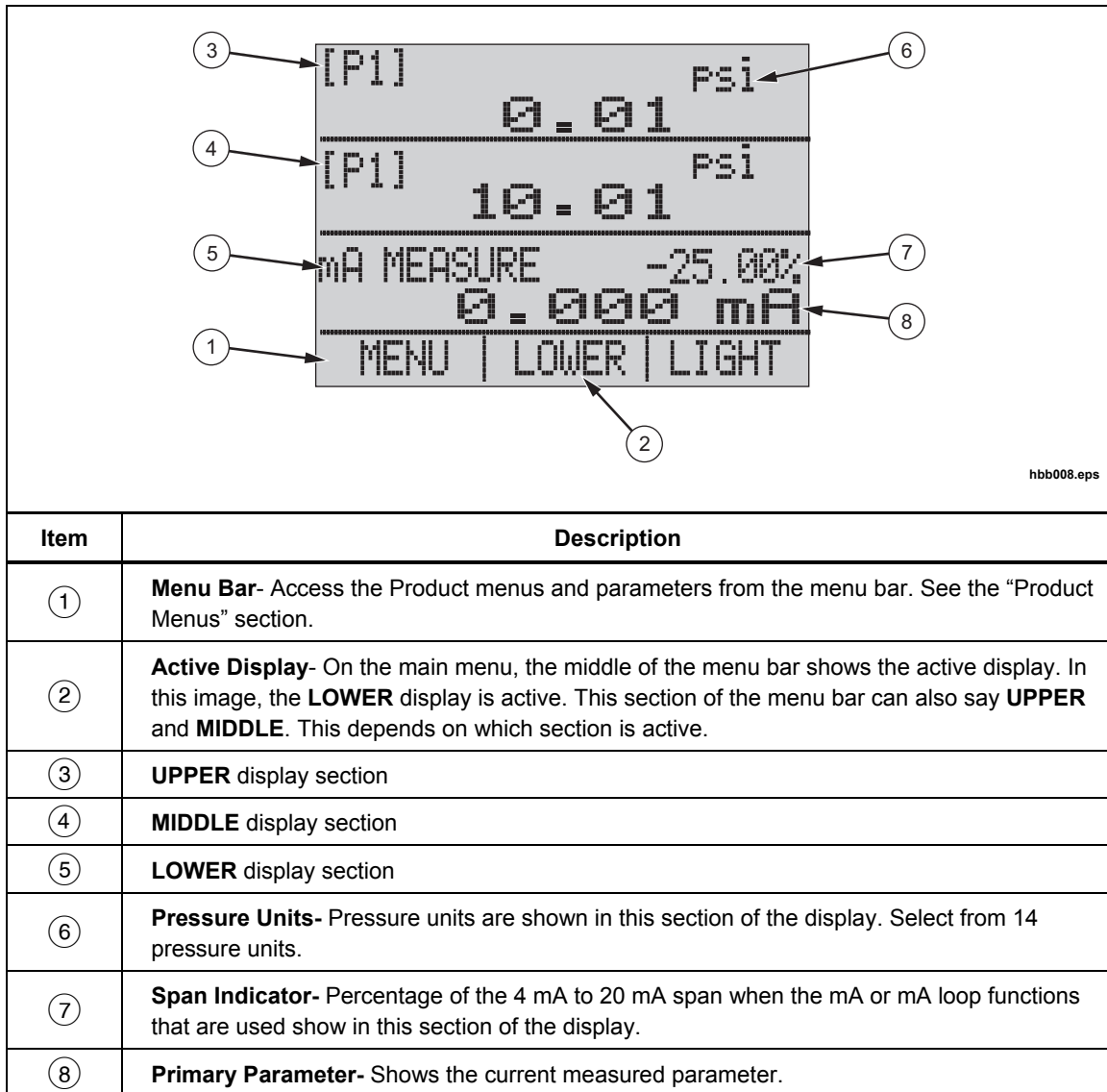
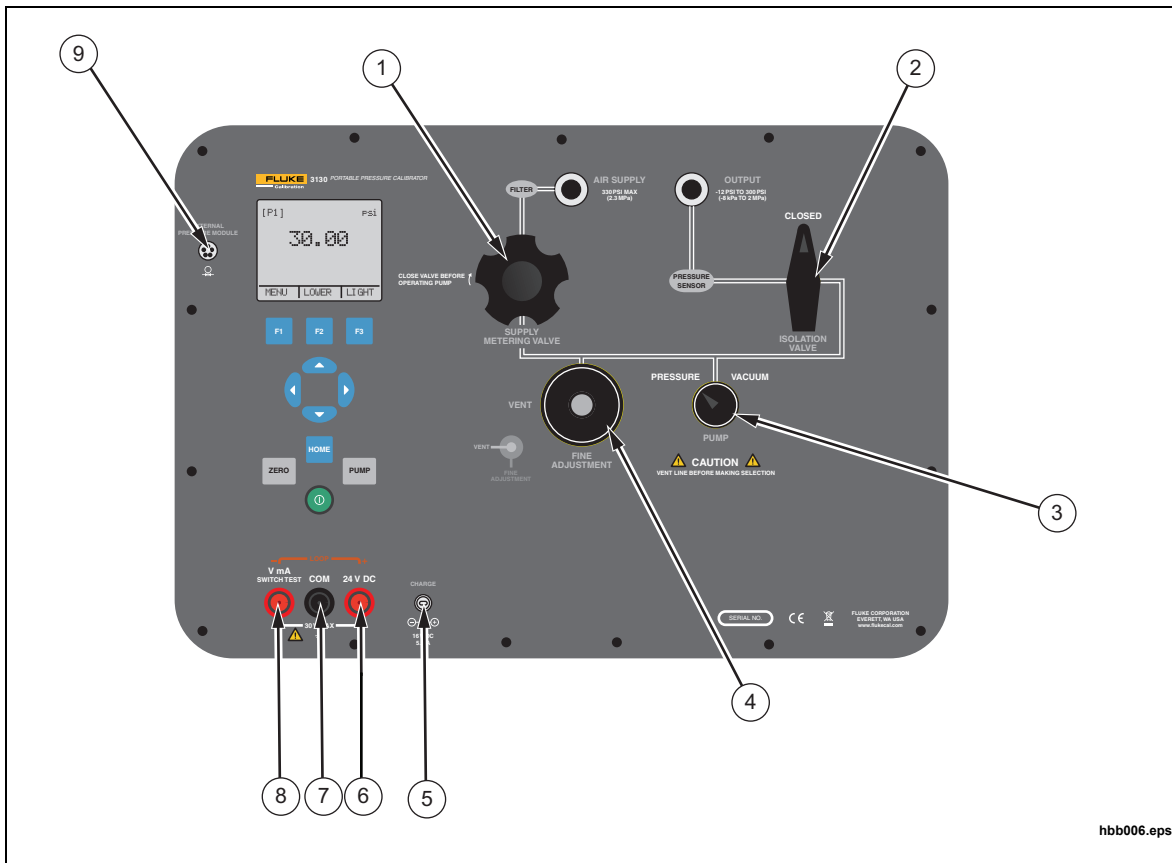

Figure 2. Display

### Calibrator Interface

The pressure controls are shown in Figure 3.



hbb006.eps

Item	Description
①	Supply metering valve. Use the supply metering valve to regulate the incoming air supply. See the “Typical Connections” section for more.
②	Isolation valve. This valve isolates the right-most port and pressure sensor from the Vent/Fine adjust, pump, and Supply Metering Valve.
③	Pump Pressure/Vacuum. In the + position, the pump operates from 0 psi to 300 psi. In the - position, the pump runs in vacuum mode, which is 0 psi to -12 psi.
④	Fine adjust/vent. Use the small silver knob of this valve to bleed off the pressure in a controlled manner. If left open, it will vent all pressure off safely. The outer-most knob (black) is a vernier control that varies the volume which finely reduces or increases the pressure.
⑤	Power Adapter input.
⑥	24 V power for voltage transmitters. This jack only powered when in Voltage Measure mode.
⑦	Common Jack.
⑧	Input Jacks. Use the input jacks for volts and milliamp functions. See the “Measure and Source Current (4... 20 mA)” and “Measure Voltage” sections. Also used for switch test.
⑨	External pressure module connection. See the “External Modules” section.

Figure 3. Controls

### Typical Connections

Typical connections of the pressure controls, connection port, and electrical inputs are shown in Figures 4, 5, and 6.

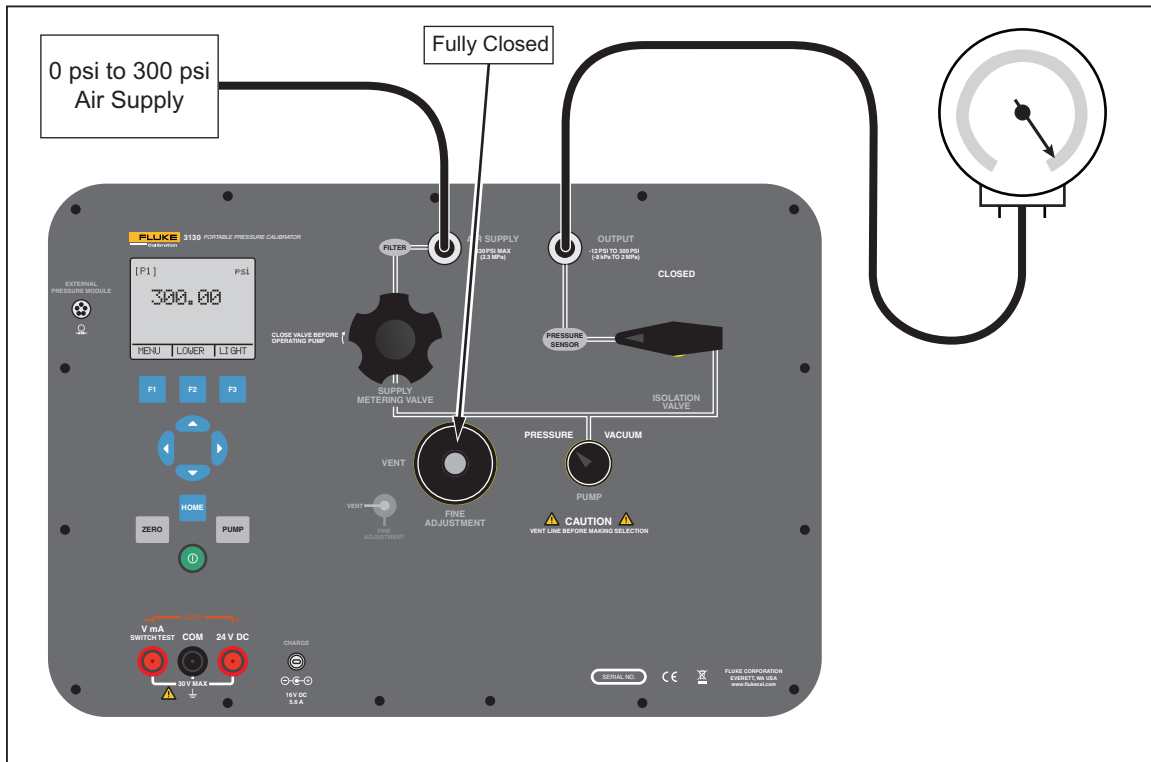

Figure 4. External Pressure Supply

hbb002.eps

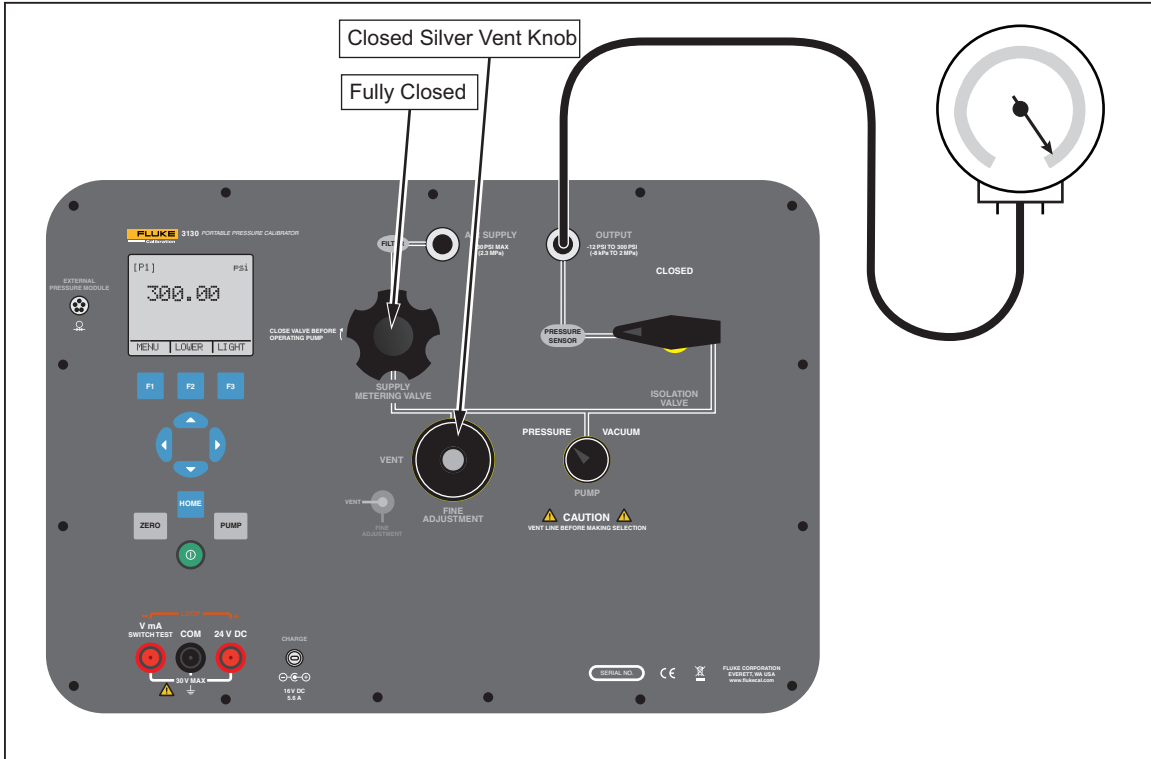

Figure 5. Pressure Supply with Internal Pump

hbb003.eps

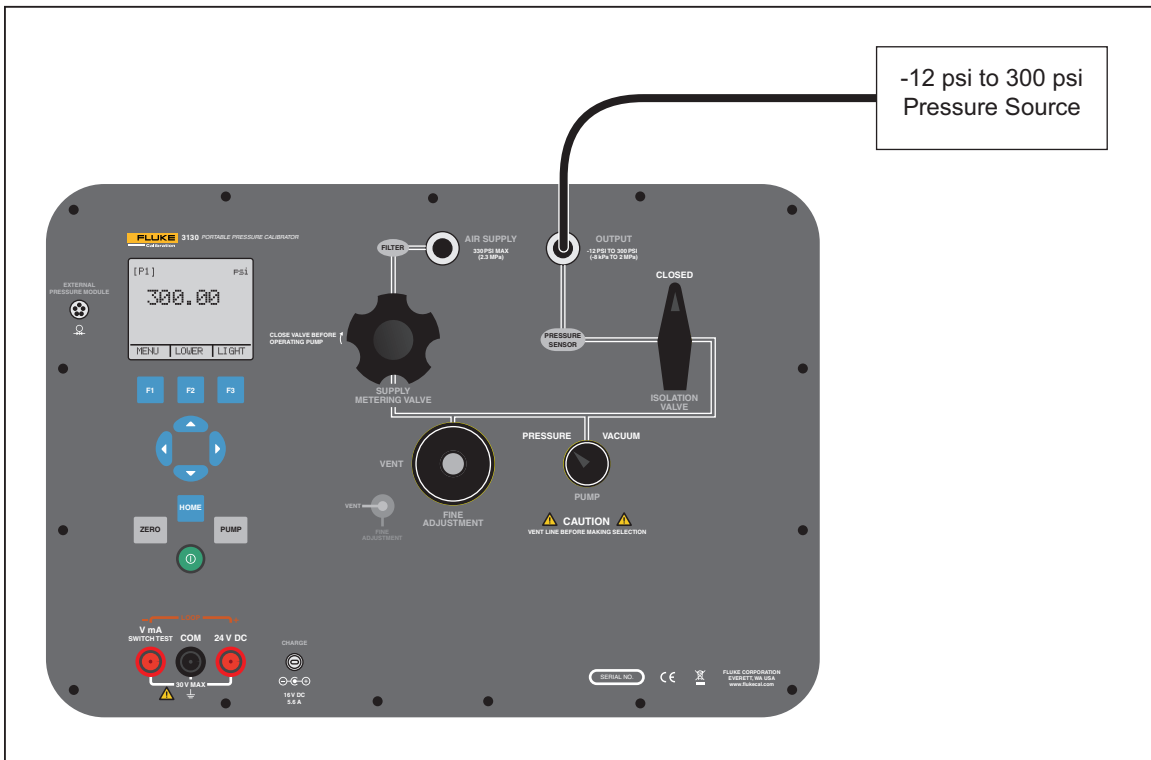

Figure 6. Pressure Measurement

hbb004.eps



## **Power Options**

The Product can be powered with the internal, high-capacity NiMH battery and/or the universal power supply (90 V ac to 250 V ac) that charges the battery pack. The universal power supply can power the Product at the same time it charges the battery pack. A fully-discharged battery can take a maximum of 14 hours to recharge. When the Product is first received, plug it into the universal power supply for that period to ensure the Product is fully charged.

## **Product Startup**

When you turn on the Product, it goes through a short self-test. The display shows the current firmware version, auto-shutdown status, and the range of the internal pressure sensor. The Product also shows the warning “⚠ FOR USE WITH DRY GAS ONLY”.

A minimum 5-minute warm-up is necessary to get the rated accuracy of the Product. If there are large changes in ambient temperature, a longer warm-up is necessary.

Pressure ranges must be zeroed each time the Product is started. See the “Zero Function” section for instructions to zero the pressure sensor displays.

## **Product Menus**

The menu bar at the bottom of the display is controlled with the softkeys or arrow keys, this depends on which menu is in use. Use the menu bar to navigate the Product menus. The menus are explained in the subsequent sections. A menu map is shown in Figure 7.

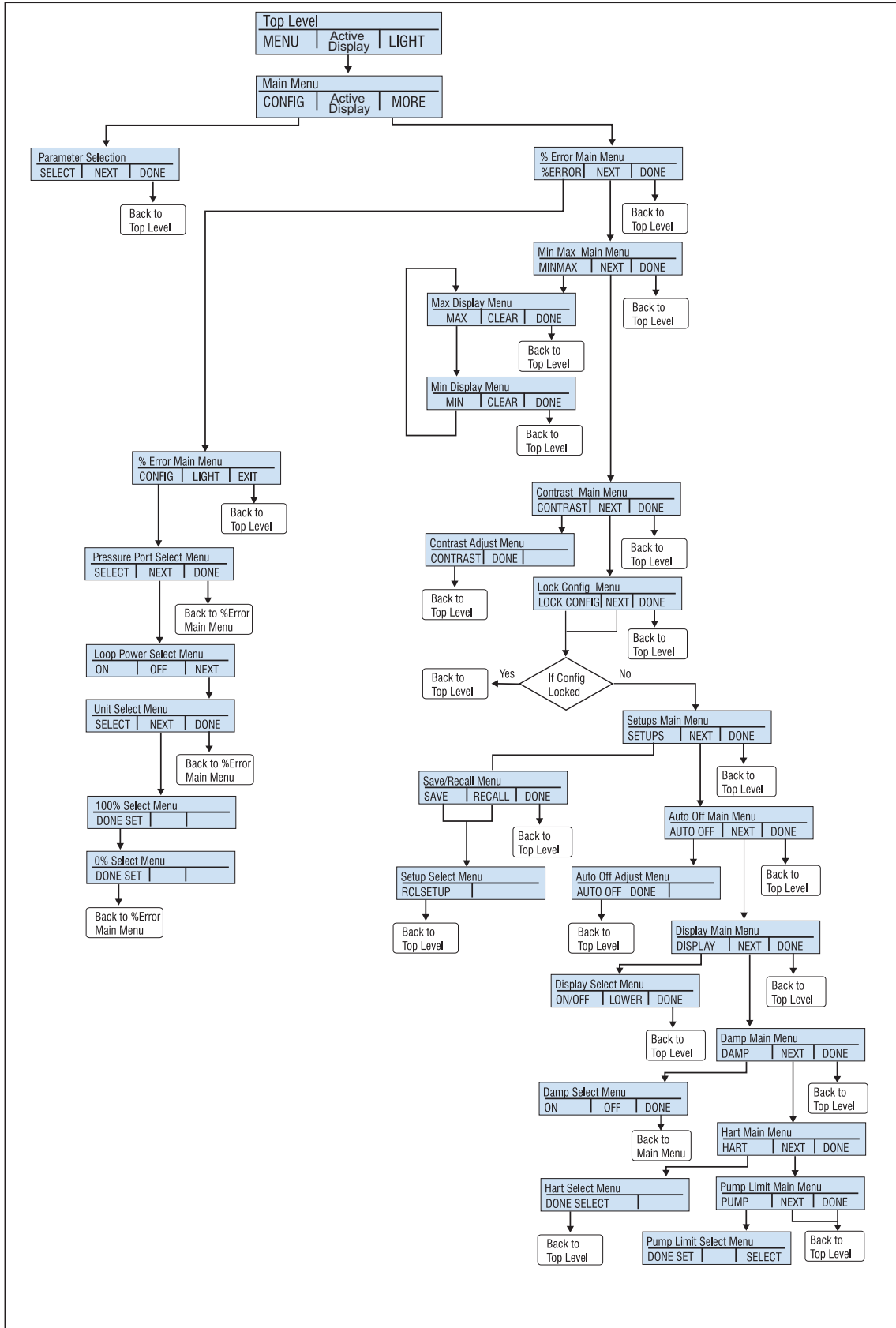

Figure 7. Menu Map

hbb001.eps

## Top-Level Menu

The top-level menu is shown in Figure 8. It has three levels.



Figure 8. Top-Level Menu

hbb009.eps

- **MENU**- Push the **MENU** softkey to get to the main menu. See the “Main Menu” section.
- **[Active Display]**- The active display is shown in the middle field on the top-level and main menu. In Figure 8 the active display is the **LOWER** display. This menu item lets you assign the ZERO key to one of the three display sections. Push the softkey that corresponds to the display named on the menu bar to change the active display. If the chosen display is a pressure range, then the ZERO key becomes active.
- **LIGHT**- The Product has a backlight for low-light situations. To turn on or turn off the backlight, push the **LIGHT** softkey on the main menu. The backlight cannot be controlled by the serial interface.

## Main Menu

To go to the main menu, push the **MENU** softkey from the top-level menu. From the main menu, the submenus can be accessed. The main menus are:

- Config- Display Configuration menu
- % Error Main Menu
- MinMax Menu
- Contrast Main Menu
- Lock Config Menu
- Setups Main Menu
- Save/Recall Menu
- Auto Off Main Menu
- Setups Main Menu
- Display Main Menu
- Damp Main Menu
- HART Main Menu
- Pump Limit Main Menu

Some of these menus are broken up into more submenus.

The main menu is shown in Figure 7 and has three levels.



Figure 9. Main Menu

hbb010.eps

- **CONFIG** (Configuration) - Push **F1** to access the config menu. Push **F1** again to go to the Display Configuration menu. This will let you change the parameters for each display section. See the Parameter Selection portion of the Figure 7.
- **[Active Display]** - See the “Top-Level Menu” section.
- **MORE**- Push **F3** to access the % Error Main Menu.

### Display Configuration Menu

Use the display configuration menu to set the parameters of the active display. Push the **SELECT** softkey to move through this menu. See Figure 13.



Figure 10. Display Configuration Menu

hbb011.eps

The first parameter is **Mode**. Since voltage, current, and switch test modes all use the same jacks, two of these functions cannot be used at the same time. What can be selected depends on what is already selected in another display.

Push the **NEXT** softkey to change the second parameter. Pressure can be read in 14 different engineering units. Only Pressure mode has a second parameter.

These modes are available with a single display:

- P[1] = Pressure internal sensor
- [EXT] = Pressure with external pressure module
- P[1] ST = Switch Test with internal sensor
- [EXT] ST = Switch Test with external pressure module

#### Note

*mA functions are only available on the lower section of the display.*

- *mA Measure = Milliamps measure.*
- *mA Source = Milliamps source.*
- *SIM-2W = Milliamps simulate using an external supply from the UUT.*
- VOLTS = Voltage Measure.
- mA MEAS/24v

Table 2 shows which functions are available concurrently.

An X in a column indicates that the mode in the active display is not available for selection if the mode in that row is in use in a different display.

Use the **MORE** option on the main menu to access other menu functions.

**Table 2. Mode Concurrency**

Active Display								
		P[1]	[EXT]	P[1]ST	[EXT]ST	mA	mA MEAS/24V	Volts
Other Displays	P[1]	x	x	x	x	x	x	x
	[EXT]	x	x	x	x	x	x	x
	P[1]ST	x	x					
	[EXT]ST	x	x					
	mA	x	x			x		
	mA MEAS/24V	x	x				x	
	Volts	x	x					x

### Zero Function

When  is pushed, the Product zeros its active display if a pressure mode is selected, and the pressure is within the zero limit. The zero limits are within 10 % of the full-scale range of the selected sensor. If the display shows “OL,” the zero function will not operate.  is only used for pressure.

### Internal Sensor and Pressure Module (non-absolute)

When a sensor or pressure module is selected on the active display and  is pushed, the Product subtracts the current reading from the output. The zero limits are within 10 % of the full-scale range of the selected sensor. If the display shows “OL,” the zero function will not operate.

### Absolute Pressure

When an absolute pressure range is selected on the active display and  is pushed, the Product prompts you to enter the barometric reference pressure. Record the barometric reference pressure with the arrow buttons. While you do this procedure, make sure the sensor port is open (vented) to the atmosphere. See Figure 11.

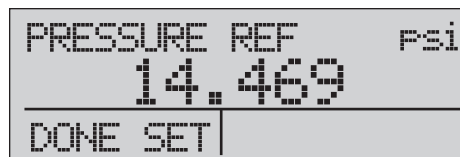

**Figure 11. Absolute Pressure**

hbb012.eps

## Other Menu Controlled Functions

There are many submenus below the main menu. These can be accessed through the **MORE** option of the main menu. A submenu contains three options. The first option is unique to the function. The second and third options are always the same. The **NEXT** option leads to the subsequent menu. The **DONE** option goes home. For the last menu, the **NEXT** option goes home. See Figure 7 for the menu structure.

In this manual, if a submenu has subsequent menus below it, it is referred to as {function} main menu. As an example, the display contrast submenu will be called the Contrast main menu.

### Contrast Main Menu

To set the contrast, go through the menu list until **CONTRAST** is shown. Push the **CONTRAST** softkey to access the Contrast Adjustment menu.

Push the up arrow or down arrow softkey to change the display to the necessary contrast level. When completed, push the **CONTRAST DONE** softkey to go home. See Figure 12.

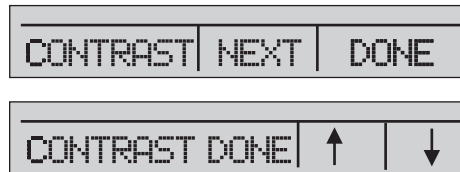

Figure 12. Contrast Menu

hbb013.eps

### Lock or Unlock the Display Configuration

To lock or unlock the display configuration settings, go through the menu list until **LOCK CFG** is shown. Push the **LOCK CFG** or **UNLOCK CFG** softkeys from the Configuration Lock menu. See Figure 13.



Figure 13. Display Configuration Menu

hbb014.eps

When the **LOCK CFG** option is used, the menu goes home and the **CONFIG** option on the main menu shows that it is locked. All menus are now locked except for Min Max, Contrast Adjustment, and Configuration Lock. When the **UNLOCK CFG** option is used, the configuration is unlocked and the menu goes to the next sub menu.

### Save and Recall Menu Setups

The current Product setup is saved for recall at the next power up. Five different setups can be saved for later use. To access these setups, go through the menu list until **SETUPS** is shown. Push the **SETUPS** softkey from the Setups Main menu. Push the **RECALL** softkey to recall a setup or the **SAVE** softkey to save a setup. Push the **DONE** softkey to do nothing and go to the home menu.

If **SAVE** or **RECALL** is selected, push the arrow keys to select the setup location. Then push the **SAVE** softkey to store the current setup into the selected location. You can also push the **RECALL** softkey to recall the setup stored in the selected location. The display menu will go to home. See Figure 14.

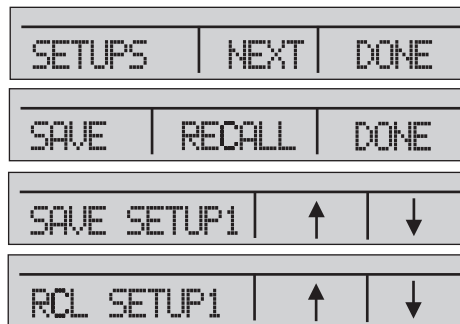

Figure 14. Setups Menu

hbb015.eps

### Automatic Shutdown

The Product can be set to turn off after a preprogrammed time interval, 0 minutes to 30 minutes. To set the automatic shutdown, go through the menu list until **AUTO OFF** is shown. Select the **AUTO OFF** option on the Auto Shutdown main menu

Push the arrow softkeys to choose the number of minutes the Product functions. Or push the down arrow softkey until **OFF** is shown to disable the automatic shutdown. When you have made the selection, push the **AUTO OFF DONE** softkey to set the selection. The Product menu will go to the home menu. The auto shutdown timer is reset when a button is pushed. See Figure 15.

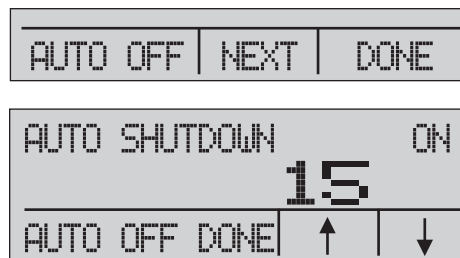

Figure 15. Auto Shutdown Menu

hbb016.eps

### Activate and Deactivate a Display

Use the **DISPLAY** menu to select which display to use. The **ON/OFF** option turns the selected display on or off. The selected display and current on/off state are shown in the lower display. See Figure 16.

To choose which displays are active:

1. Go through the menu list until **DISPLAY** is shown.
2. Push the **DISPLAY** softkey to access the Display Activation menu.
3. Push the **UPPER**, **MIDDLE**, or **LOWER** softkey to make your selection.
4. Push the **ON/OFF** softkey to change the display state.
5. Push the **DONE** softkey to save the changes and go to the home screen.

When a display is deactivated, its configuration is saved. When the display is activated, its configuration is verified against the configurations of the other currently-active displays. If the configurations are in conflict, the recalled-display configuration is changed to prevent the conflict. If all three displays are deactivated, the lower display will turn on automatically.



Figure 16. Active Display Menu

hbb017.eps

### Damping

Damping can be turned **ON** or **OFF** with the **DAMP** menu selection. Go through the menu list until **DAMP** is shown. Select **ON** or **OFF**. When damping is **ON**, the Product shows a running average indication of ten measurements. The Product makes approximately three readings per second.

### HART Resistor

An internal 250  $\Omega$  HART resistor can be enabled when the Product is used in the mA Measure-24V mode. This lets a HART communicator be connected across the mA terminals and makes it unnecessary to add an external resistor.

#### Note

*When the HART resistor is on, the maximum load-driving capacity is 750  $\Omega$ .*

Go through the menu list until **HART** is shown. Use the arrow softkeys to select **ON** or **OFF**.

### Pump Limits



To prevent overpressure of sensitive devices the maximum pressure (pump limit) can be set. Go through the menu list until **PUMP** is shown. When in this mode, use **SELECT** and the arrow buttons to change the pump limit. Push the **DONE SET** softkey to save the selection and go to the main menu. This limit can be set to 10 % above full scale.



## **Initial Setup and Basic Pressure Generation**

The Product has a special low-volume calibration hose for faster pressure generation and quick pressure stabilization. "Quick-fit" hose connectors and different adapters are included. It is recommended that this hose is used to get the best results. After the fittings are installed and the Product is connected to the UUT (unit under test), the Product is ready for use.

To configure the Product for the appropriate application:

1. Set the pressure/vacuum selection knob to the necessary function (+ for pressure and - for vacuum).
2. Close the vent knob.
3. Close the supply metering valve.
4. Push and hold  and see the pressure rise (or vacuum generation) until you reach the necessary pressure.
5. Release  when the necessary pressure is reached.

### *Note*

*The motor speed starts slow while the pressure is low <15 psi (1 bar) for better control at low pressures.*

6. The fine pressure adjustment lets you set the correct pressure.
7. To decrease or bleed off all pressure, slowly turn the vent knob counter clockwise to the open position. When the valve is slowly opened, there is a slow decrease of pressure. Open the valve more to vent the pressure.

## **Pressure Measurement**

To measure pressure:

1. Connect the Product with the correct adapter.
2. Select the pressure parameter for the display used.
3. The Product has an internal sensor and optional external sensors are available. Select a sensor that is correct for the pressure range and accuracy.

### **⚠ Warning**

**To prevent injury, only assemble and operate high-pressure systems if you know the correct safety procedures. High-pressure liquids and gases are hazardous and the energy from them can be released without warning.**

For a better understanding with respect to overpressure and burst pressure, follow the specifications and these operation instructions. See the "Specifications" section. The Product display will show "OL" when an inappropriate pressure is applied. When "OL" is shown on a pressure display, immediately decrease the pressure to prevent damage or possible physical injury. "OL" is shown if the pressure exceeds the nominal range by 110 %. Push  to zero the pressure sensor after it is vented to atmospheric pressure.

### Media Compatibility

The Product is only to be used with clean, dry gases.

### External Modules

The Product has a digital interface to support the Fluke 700P series of pressure modules. These modules are available for different ranges that include gauge, vacuum, differential, and absolute pressure. The modules work in conjunction with the Product. Connect them to the interface and select [EXT] (external sensor). Since the interface between the Product and the module is digital, the accuracy and display resolution depends on the module. See Figure 17.

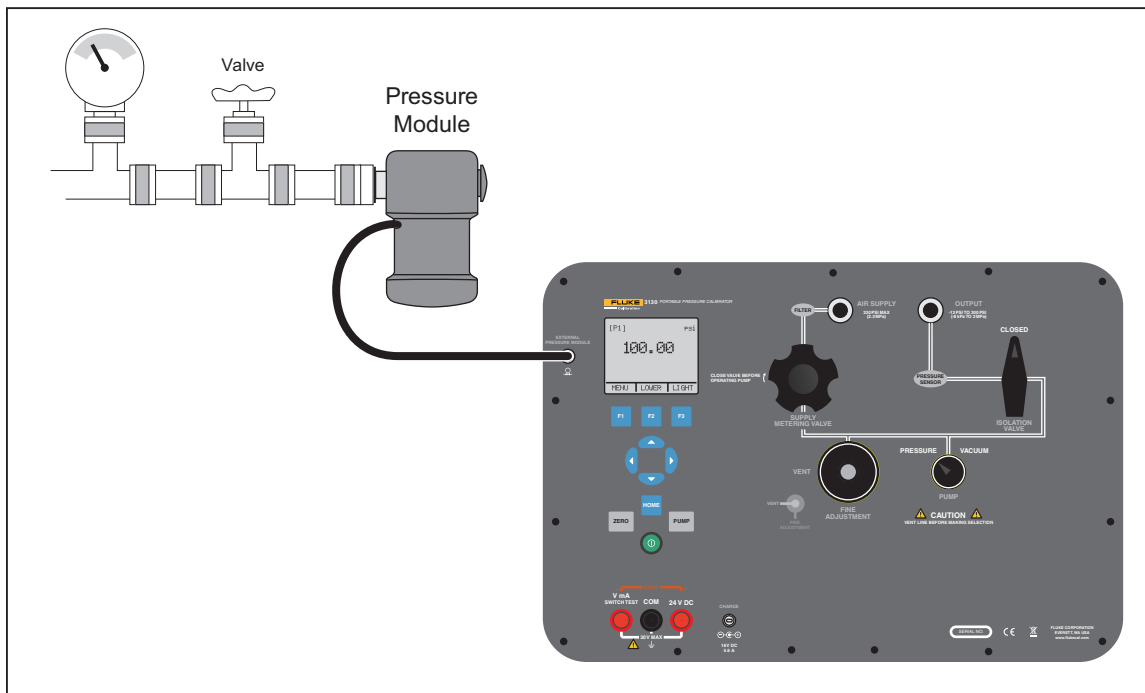

Figure 17. Pressure Module

hbb007.eps

### Measure and Source Current (4... 20 mA)

To measure and source current:

1. To measure current, use the input terminals on the front of the Product. Select the mA function on the lower display. Current is measured in mA and a percentage of the measuring range. The measuring range on the Product is set to 0 % at 4 mA and 100 % at 20 mA. See Figure 18 for connections.

Example:

If the current measured is shown as 75 %, then the value is 16 mA.

*Note*

*The display shows "OL" when the measured current exceeds the nominal range of current measurement (24 mA).*

- The same connections are used for the current source. Select mA-Source or mA Sim-2W from the configuration display.
- This selection can only be made in the lower display. Also, in source mode, the Product generates 0... 24 mA that uses its own internal 24 V supply, whereas in simulation mode the Product acts as a 2-wire transmitter and an external 24 V supply is necessary.
- Push the arrow key to start the output mode and then use the arrow keys to adjust the mA output. The function keys can also be used to control the output in 25 % steps (4, 8, 12, 16, 20 mA) or 0 % (4 mA) and 100 % (20 mA). See Figure 18.
- While in the mA output mode, if the loop is broken or the resistance burden is exceeded, the Product will flash "OL".

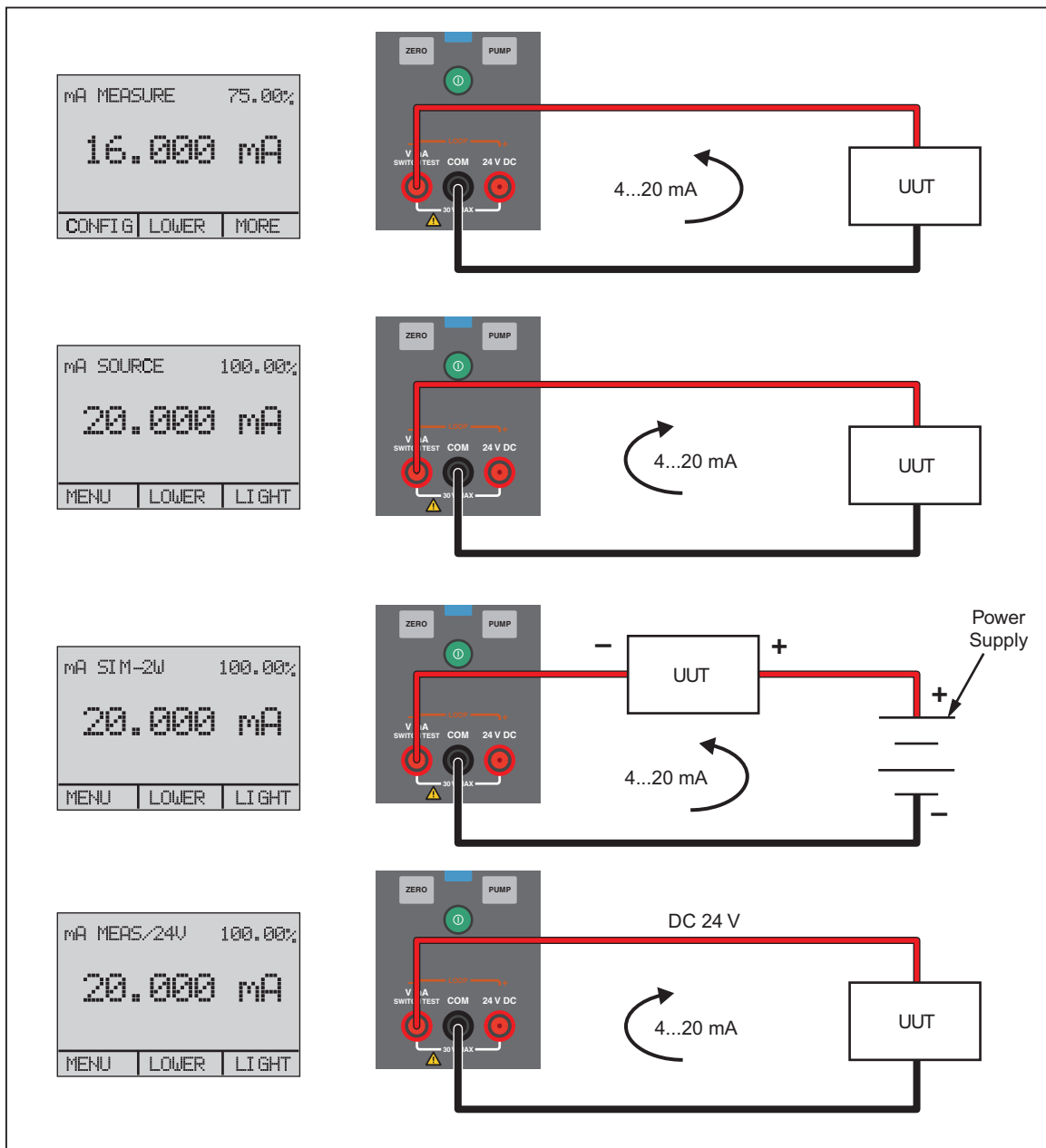

Figure 18. Measure and Sourcing Current

hbb018.eps

### Measure Voltage

To measure voltage, use the connections on the front of the Product. Select the **VOLTS** function on one of the displays. The Product can measure to a maximum of 30 V dc. See Figure 19.

*Note*

*The display shows "OL" when the measured voltage is larger than the nominal range of voltage measurement (30 V).*

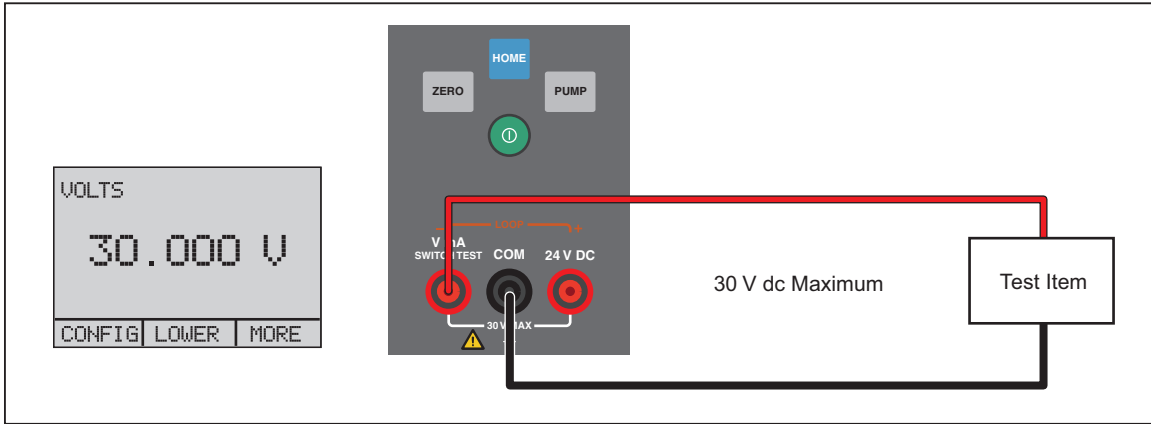

Figure 19. Measure Voltage

### Pressure Switch Test

To do a pressure switch test:

1. Set the upper display to [P1] ST, all other displays are switched off.

*Note*

*The pressure switch test can be done with these functions: [P1] ST or EXT ST.*

2. Connect the Product to the pressure switch with the switch terminals. The polarity of the terminals is not important. See Figure 20.

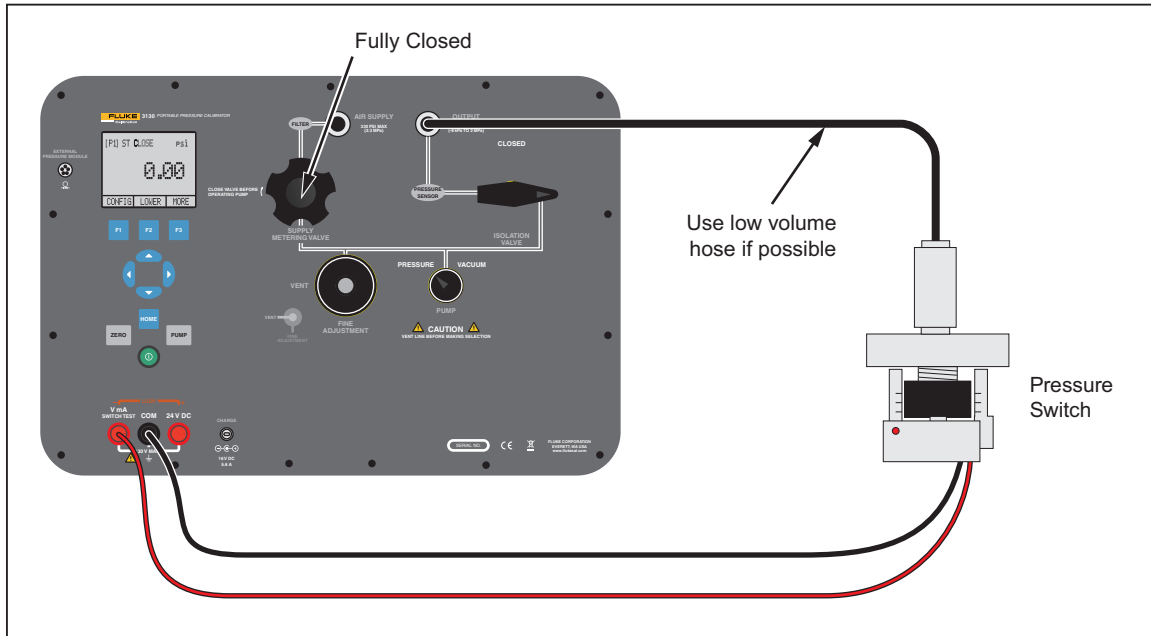

Figure 20. Switch Test Connections

hbb020.eps

3. Connect the Output of the Product to the pressure switch.
4. Open the vent button on the pump and zero the Product.
5. Close the vent after you reset the Product.

The top of the display shows "CLOSE". See Figure 22.

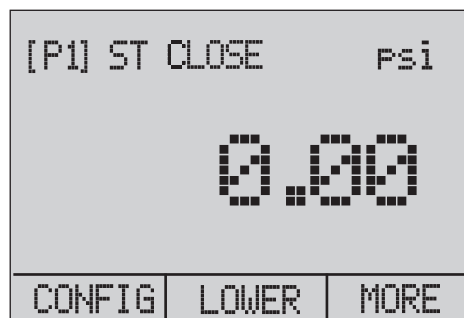

Figure 21. Switch Test Screen

hbb021.eps

6. Apply pressure with the pump slowly until the switch opens.

*Note*

*In the switch test mode, the display-update rate is increased to help capture changes to pressure inputs. Even with this enhanced sample rate, the UUT should be charged slowly with pressure to ensure accurate readings.*

7. After the switch is open, "OPEN" will be shown. Bleed the pump slowly until the pressure switch closes. See Figure 22.

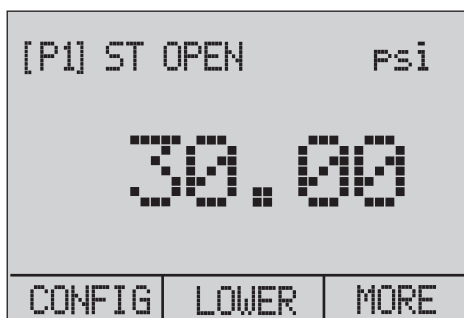

hbb022.eps

**Figure 22. Switch Test Screen (Open)**

8. The top display now shows "SW OPENED AT" and gives you the pressure at which the switch opened. See Figure 23.



hbb023.eps

**Figure 23. Opened Switch Reading**

9. Select the "NEXT" option to show the pressure at which the switch closed and the deadband. See Figure 24.

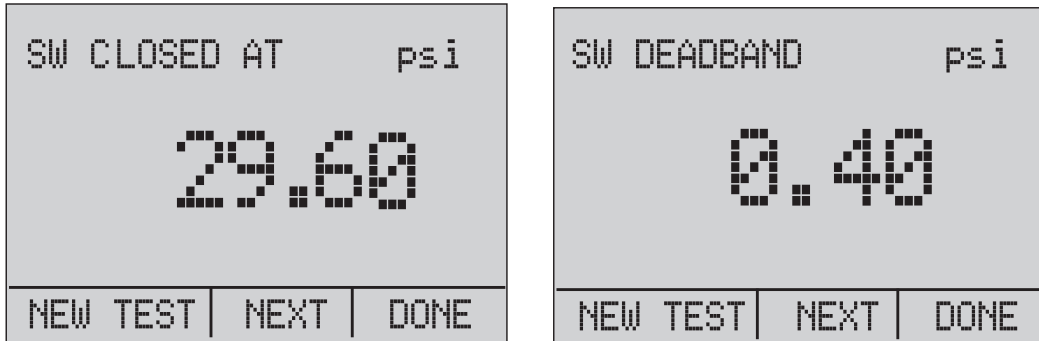

**Figure 24. Switch Test and Deadband Results**

hbb024.eps

10. Select the "NEW TEST" option to clear the data and do another test.
11. Select the "DONE" option to complete the test and go to the standard pressure setting.

Example:

[P1] ST will return to [P1].

This example uses a normally closed switch. The basic procedure is effectively the same for a normally open switch. The display reads "OPEN" instead of "CLOSE".

### **Calibrate Transmitters**

#### **Use the mA Measurement Function**

The mA function lets you read the 4... 20 mA output from the UUT. This can be done in two ways:

1. Passively – the UUT generates 4... 20 mA directly. This can be read on the Product.
2. Actively – the Product supplies a loop power of 24 V dc to the UUT to power the device while it reads the 4... 20 mA signal. See Figure 25.

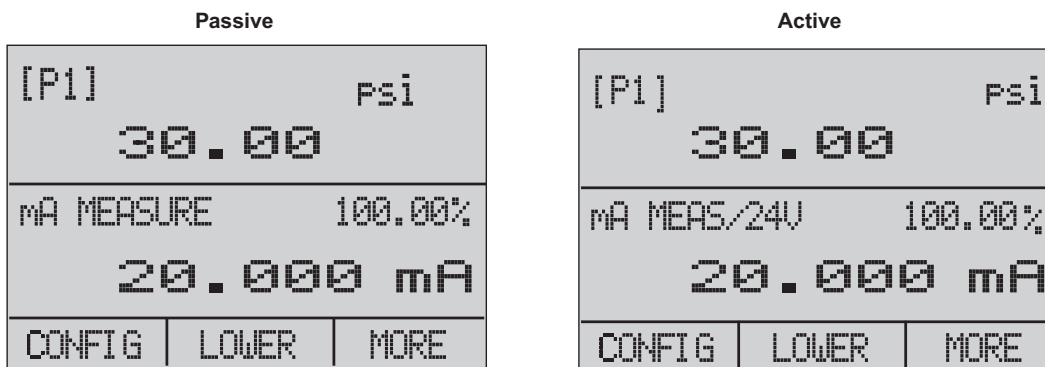

**Figure 25. Passive and Active Screens**

hbb025.eps

### Calibrate a Pressure-to-Current Transmitter

To calibrate a pressure-to-current transmitter (P/I):

1. Connect the Product pump to the transmitter.
2. Apply pressure from the pump.
3. Measure the current output of the transmitter.
4. Make sure that the read value is correct. If it is not correct, the transmitter must be adjusted. See Figure 26.

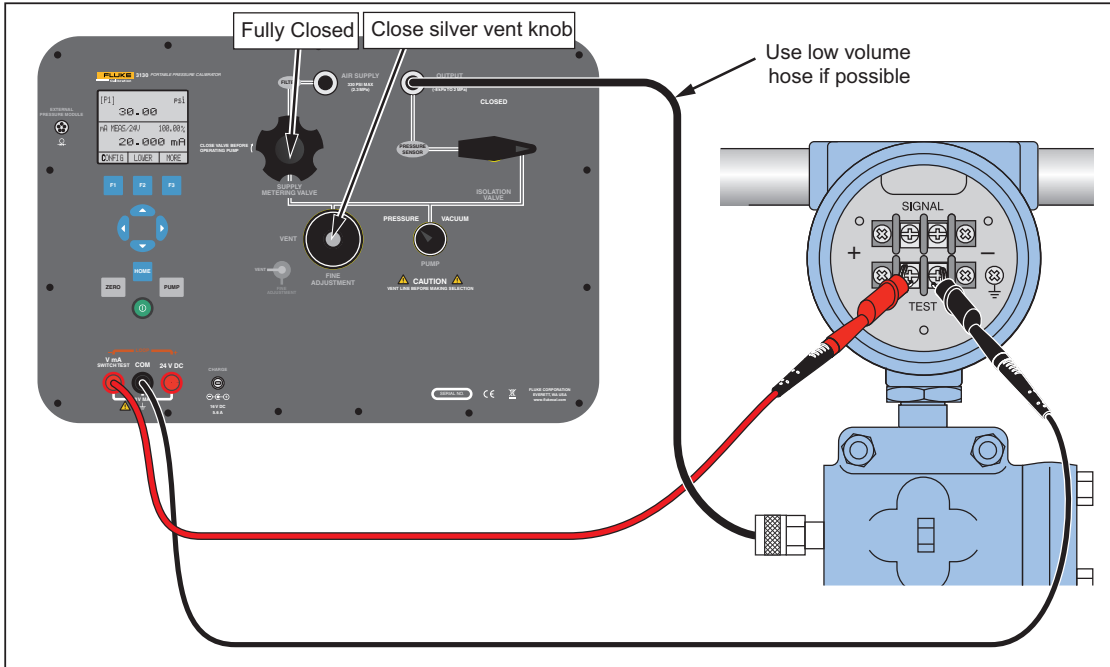

Figure 26. Calibrate a Pressure-to-Current Transmitter

hbb026.eps



### Calibrate a Pressure-to-Voltage Transmitter

To calibrate a pressure-to-voltage transmitter (P/V):

1. Connect the Product pump to the transmitter.
2. Apply pressure from the pump.
3. Connect the 24 V to the transmitter.
4. Measure the voltage output of the transmitter.
5. Make sure that the read value is correct. If it is not correct, the transmitter must be adjusted. See Figure 27 for connections.

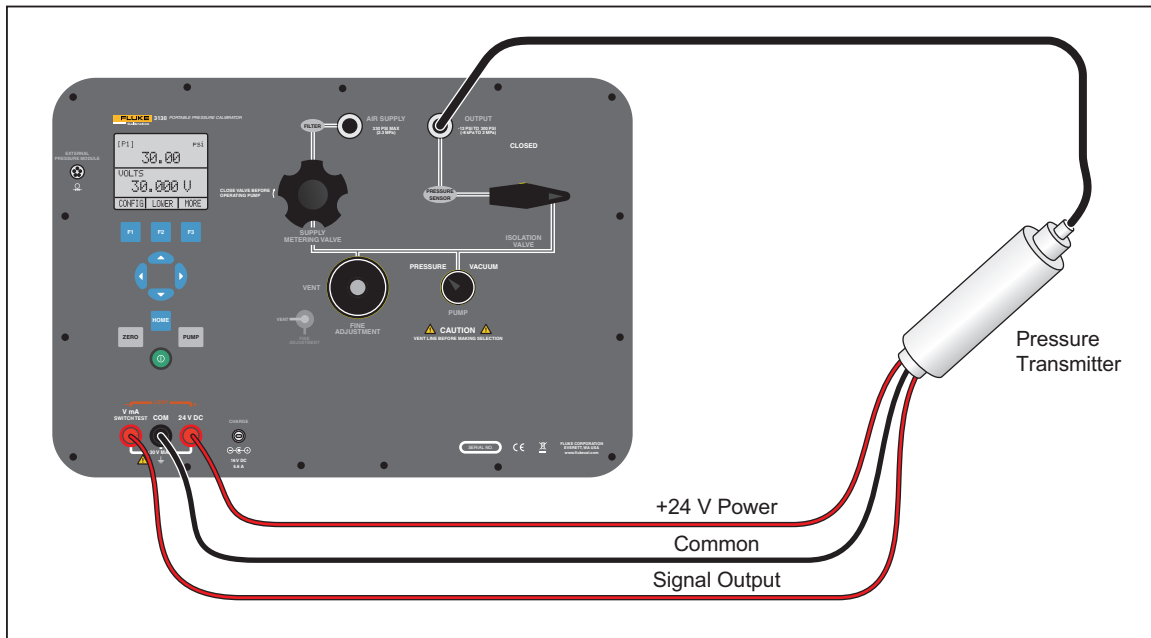

Figure 27. Calibrate a Pressure-to-Voltage Transmitter

hbb035.eps

### %-Error Function

The Product has a special function which can calculate the error in the pressure value from the mA value as a percentage of the 4 ... 20 mA loop span. The %-Error mode uses all three screens and has a special menu structure. It shows pressure, mA and %-Error simultaneously. See Figure 28.

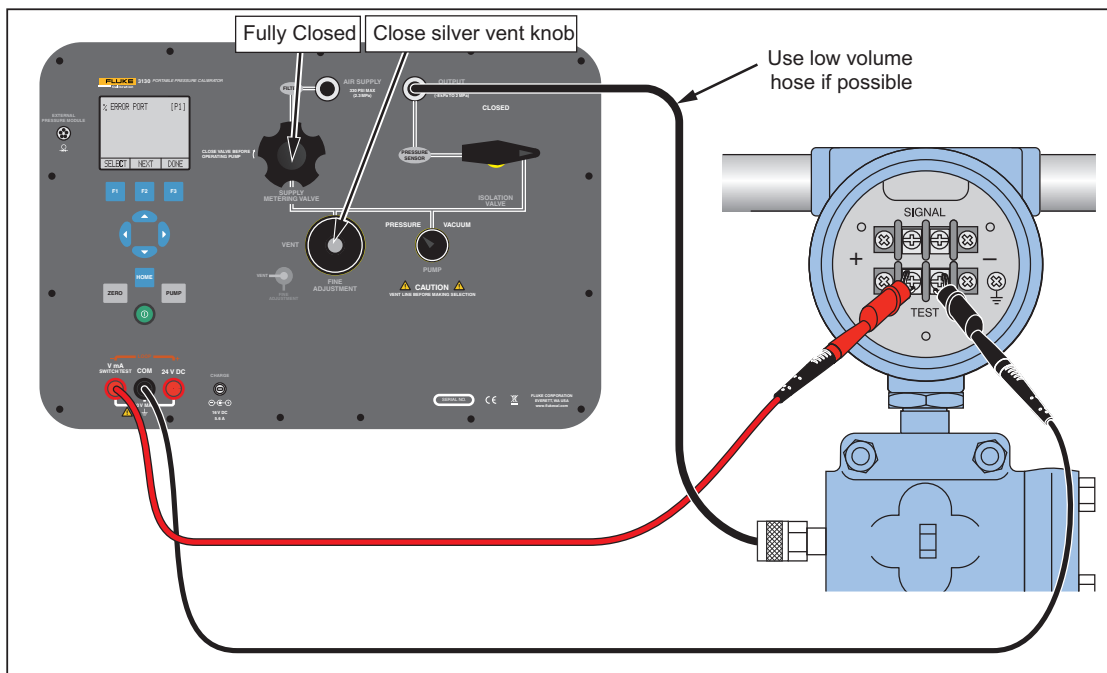

Figure 28. Connections with a Pressure Transmitter with % Error Function

hbb027.eps

Example:

If a pressure transmitter under test has a full-scale range of 2 bar and gives a 4 ... 20 mA output signal, you can program in a 0 ... 2 bar pressure span into the Product. The Product will then calculate and show the deviation or %-Error value from the 4 ... 20 mA output. This makes manual calculations unnecessary.

To use the "%-ERROR" function:

1. Once the Product is turned on, push **F3** to start the "MORE" menu option. Then Push **F1** to start the "%-ERROR" option.
2. Push **F1** to select the "CONFIG" option.

3. The first option is the port setting. Use the "SELECT" option to scroll through the choice of ports (pressure connections). When this is done, select the "NEXT" option. See Figure 29.



**Figure 29. Port Setting Screen**

hbb028.eps

4. "LOOP POWER" can be toggled on or off. Select "NEXT" when done. See Figure 30.

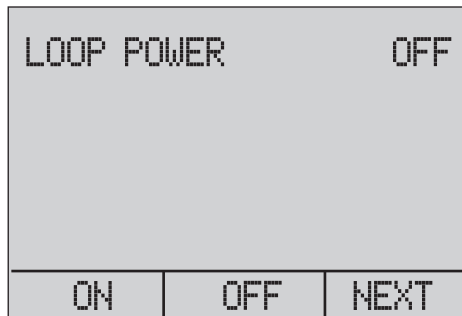

**Figure 30. Loop Power Screen**

hbb029.eps

5. Use "SELECT" to scroll through the "UNIT" options, and select "NEXT" to move on. See Figure 31.

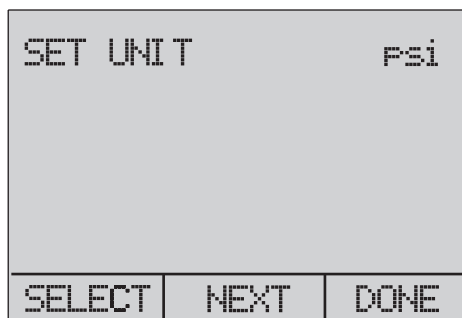

**Figure 31. Set Unit Screen**

hbb030.eps

- Use the arrow keys to set the upper limit of the measurement range. Select **DONE SET** when finished. See Figure 32.

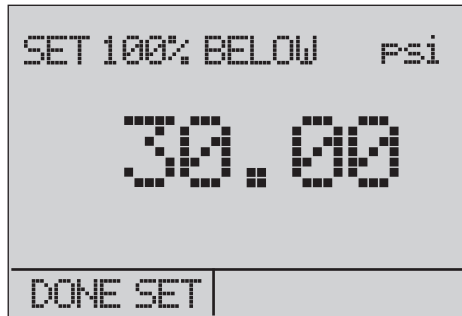

Figure 32. Setting the Upper Limit

hbb031.eps

- Use the arrow keys to set lower limit of the measurement range, and select **DONE SET** when finished. The "%-ERROR" mode will be ready to use. See Figure 33.

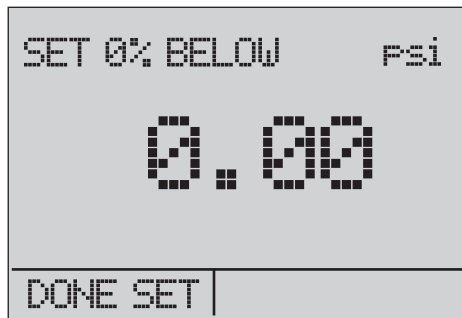

Figure 33. % ERROR Screen

hbb032.eps

The lower and upper limit of the measuring range is saved in non-volatile memory until they are changed by the user for the internal sensors and the external pressure modules. See Figure 34.

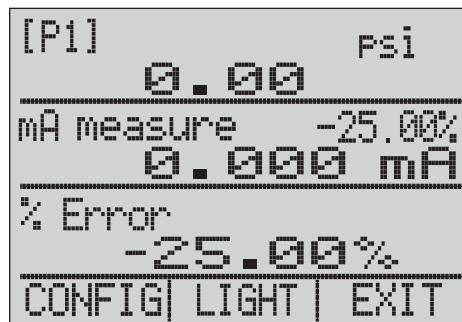

Figure 34. Saved Upper and Lower Limits

hbb033.eps

## Storage Capability

The Product has a min/max feature to capture the minimum and maximum values of a shown parameter.

The min/max function can be accessed by going through the menu options until the **MINMAX** menu choice is shown. Push the **MINMAX** softkey to see the min/max values that are stored in the min/max registers. These readings are live so that the new min/max values are recorded while in this mode.

To reset the min/max registers, push the **CLEAR** softkey. These registers are also cleared at power-up or when the configuration is changed.

## Remote Operation

The Product can be remotely controlled with a PC terminal, or by a computer program that runs the Product in an automated system. An RS-232 serial port connection is used for remote operation.

### Note

*To use the remote control option, a custom RS-232 cable must be purchased. See the “How to Contact Fluke Calibration” section.*

With this connection, you can write programs on the PC. Use Windows languages like Visual Basic to operate the Product, or use a Windows terminal like Hyper Terminal, for single commands. A typical RS-232 remote configuration is shown in Figure 35.

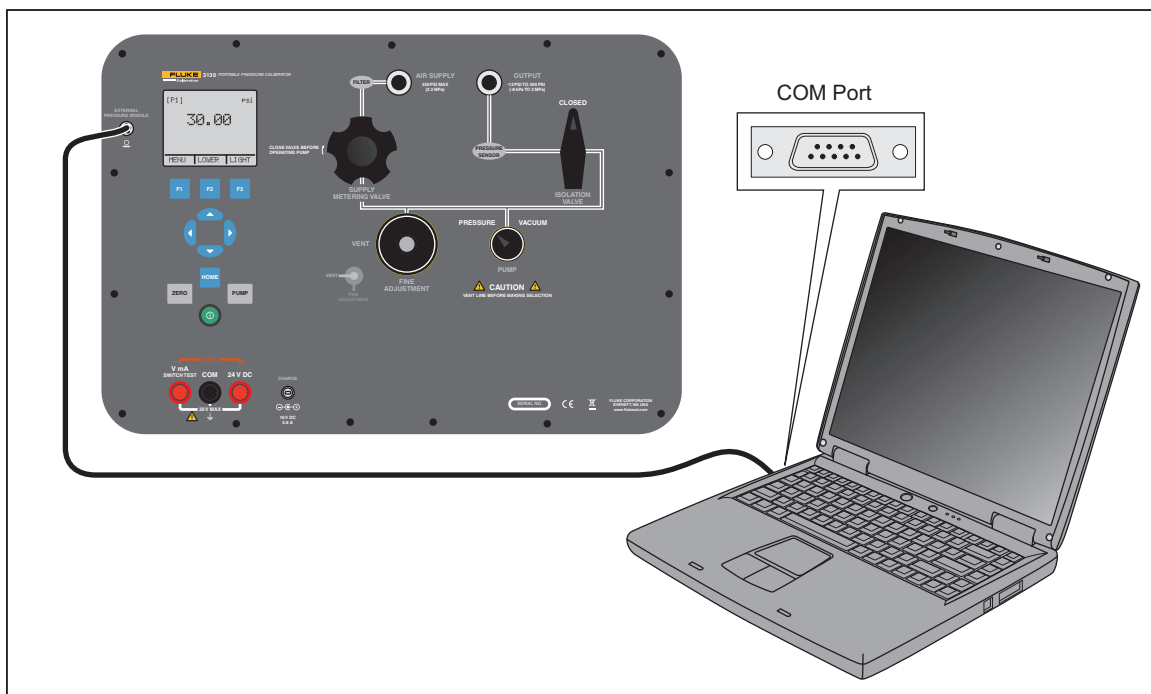

Figure 35. Remote Operation

hbb034.eps

## Set Up the RS-232 Port for Remote Control

### Note

*The RS-232 connection cable must be less than 15 m unless the load capacitance measured at connection points is less than 2500 pF.*

Serial parameter values:

1. 9600 baud
2. 8 data bits
3. 1 stop bit
4. no parity
5. Xon/Xoff
6. EOL (End of Line) character or CR (Carriage Return) or both

An RS-232 cable is used for RS-232 communications from the Product to a computer. If the computer only has USB ports, a USB to RS-232 converter will be necessary. To connect the Product to a computer, attach the LEMO connector end of the cable to the pressure module port on the right side of the Product. Then connect the DB-9 connector to the RS-232 port on the computer. The Product must be off before you make the connection.

To set up remote operation of the Product with Windows Hyper Terminal, connect the Product to a COM port on the PC. See Figure 35.

Do the subsequent procedure:

1. Start Hyper Terminal (located on your computer in Accessories/Communications of the Windows Start menu).
2. Select **New Connection**.
3. For **Name** enter "**Fluke 3130**".
4. Select the serial port that the Product is connected to.
5. Enter the above information for port settings.
6. Select ASCII setup from File/Properties/Settings and mark these choices:
  1. Echo typed characters locally
  2. Wrap lines that exceed terminal width
7. Select **Ok**.
8. To see if the port functions, enter **\*IDN?**. This command shows information on the Product.

### **Change from Remote to Local Operation**

The Product uses three modes of operation:

- Local
- Remote
- Remote with Lockout

Local mode is the default mode. Commands can be entered with the buttons on the Product or with a computer. In Remote mode, the buttons are disabled and commands can only be entered with a computer. Select [**GO TO LOCAL**] from the menu on the Product display to restore button operation. In Remote with Lockout mode, the buttons cannot be used.

To switch modes:

1. To start Remote mode, enter the serial command “**REMOTE**” at the computer terminal.
2. To start Remote with Lockout mode, enter “**REMOTE LOCKOUT**” in either order.
3. To go back to Local Operation mode, enter “**LOCAL**” at the terminal. This command also turns off LOCKOUT if it is on. For more information on commands, see the “Remote Commands” section.

### **Command Use**

The Product can be controlled by commands and queries. All commands can be entered with upper or lower case. See the Remote Commands section for all available commands.

The commands are divided into these categories:

#### **Calibrator Commands**

Only the Product uses these commands.

For example:

VAL?

This command requests the values shown on the Product display.

#### **Common Commands**

Standard commands used by most devices. These commands always start with an “\*?”.

For example:

\*IDN?

This command tells the Product to show its identification.

#### **Query Commands**

Commands that request information and always end with a “?”.

For example:

FUNC?

This command shows the current modes of the Product displays.

### Compound Commands

Commands that have more than one command on one line.

For example:

```
PRES_UNIT LOWER, PSI;PRES_UNIT?
```

This command sets the pressure unit to PSI on the lower display and queries the Product to verify. In this case, it will show the pressure units of all three displays:

```
BAR,BAR,PSI
```

### Character Processing

The data entered into the Product is processed as follows:

- ASCII characters are discarded if their decimal equivalent is less than 32 (space), except 10 (LF) and 13 (CR):
- Data is taken as 7-bit ASCII.
- The most significant data bit is ignored.
- Upper or lower case is acceptable.

### Response Data Types

The data shown by the Product can be divided into these types:

#### Integer

For most computers and controllers they are decimal numbers ranging from -32768 to 32768.

For example:

```
FAULT?
```

Could show 110

Refer to the Error Codes table (Table 8) for more information on error codes.

#### Floating

Floating numbers can have a maximum of 15 significant figures and exponents.

For example:

```
VAL?
```

Shows 5.830000E01,PSI,0.000000E00,PSI,0.000000E+00,A

#### Character Response Data (CRD)

Data shown as keywords.

For example:

```
PRES_UNIT?
```

Shows BAR,BAR,PSI

#### Indefinite ASCII (IAD)

Any ASCII characters followed by a terminator. For example:

```
*IDN?
```

Shows Fluke, 3130, 1234567, 1.00 (1234567 is the serial number)



## **Calibrator Status**

### **Error Queue**

If an error occurs from invalid input or buffer overflow, its error code is sent to the error queue. The error code can be read from the queue with the command FAULT?. The error queue holds 15 error codes. When it is empty, FAULT? shows 0. The error queue is cleared when power is reset or when the clear command \*CLS is entered.

### **Input Buffer**

The calibrator stores all received data in the input buffer. The buffer holds 250 characters and they are processed on a first in, first out basis.

## **Remote Commands and Error Codes**

This section shows and describes all of the remote commands that are accepted by the Product.

**Table 3. Common Commands**

<b>Command</b>	<b>Description</b>
*CLS	(Clear status.) Clears the error queue.
*IDN?	Identification query. Shows the manufacturer, model number, and firmware revision level of the Product.
*RST	Resets the Product to the power up state.

**Table 4. Product Commands**

Command	Description
DAMP	Turns on or off Damp
DAMP?	Show if DAMP is on/off
DISPLAY	Turns on or off the displays specified in the command
DISPLAY?	Shows which displays are on/off
ERROR_LOOP	Turns on or off loop power in percent error mode
ERROR_LOOP?	Shows the current state of loop power in error mode
ERROR_MODE	Turns on or off percent error mode
ERROR_MODE?	Shows if percent error mode is on or off
ERROR_PORT	Set the pressure port for percent error mode
ERROR_PORT?	Shows the pressure port for percent error mode
FAULT?	Shows the most recent error code
FUNC	Sets the display mode as specified in the command
FUNC?	Shows the current mode of the upper, middle, and lower display
HART_ON	Turns on the HART resistor
HART_OFF	Turns off the HART resistor
HART?	Shows the current state of the HART resistor.
HI_ERR	Sets the 100 % of span limit for percent error mode
HI_ERR?	Shows the 100 % of span limit for percent error mode
IO_STATE	Set the Product mA state
IO_STATE?	Shows the Product mA state
LOCAL	Shows user to manual operation of the Product
LOCKOUT	Locks out the keypad of the Product in remote operation
LO_ERR	Sets the 0 % of span limit for percent error mode
LO_ERR	Shows the 0 % of span limit for percent error mode
MOTOR_ON	Turns on the motor
MOTOR_OFF	Turns off the motor
MOTOR?	Shows the current state of the HART resistor
OUT	Set the Product to output the requested current
OUT?	Shows the value of the current being simulated

**Table 4. Product Commands (cont.)**

Command	Description
PRES_UNIT	Set the pressure unit for the indicated display
PRES_UNIT?	Shows the pressure from the indicated display
PUMP_LIMIT	Sets the approximate value at which the pump will turn off
PUMP_LIMIT?	Shows the approximate value at which the pump will turn off
REMOTE	Puts the Product in remote mode
SIM	Set the Product to simulate the requested current
SIM?	Shows the value of the current being simulated
ST_CLOSE?	Shows pressure value at which the switch closed
ST_DEAD?	Shows pressure value of the deadband of the switch
ST_OPEN?	Shows pressure value at which the switch opened
ST_START	Starts a switch test
VAL?	Shows the measured values
ZERO_MEAS	Zeros the pressure module
ZERO_MEAS?	Shows the zero offset of the pressure module

**Table 5. Parameter Units**

Units	Meaning
DCI	Current function
DCV	Voltage measure function
EXT	External pressure measurement function
LOWER	Designates Lower display
MA	Milliamps of current
MEASURE	Measure state
MEAS_LOOP	Measure with loop power state
MIDDLE	Designates Middle display
PCT_ERR	Percent Error
PERCENT	Percent
P1	P1 pressure measurement function
ST_P1	Switch test mode with P1
ST_EXT	Switch test mode with external module
SOURCE	Source state
SIM	Simulate state
UPPER	Designates Upper display
V	Voltage

Table 6. Error Codes

Error Number	Error Description
100	A non-numeric entry was received where it should be a numeric entry
101	Too many digits entered
102	Invalid units or parameter value received
103	Entry is above the upper limit of the allowable range
104	Entry is below the lower limit of the allowable range
105	A required command parameter was missing
106	An invalid command parameter was received
107	Pressure not selected
108	Invalid sensor type
109	Pressure module not connected
110	An unknown command was received
111	Bad Parameter received
112	The serial input buffer overflowed
113	Too many entries in the command line
114	The serial output buffer overflowed

### Enter Commands

Commands for the Product can be entered in upper or lower case. There is a minimum of one space necessary between the command and parameter. All other spaces are optional. Most of the commands for the Product are sequential. Any overlapped commands will be shown as such. This section describes each of the commands and their general use, which will include any parameters that can be entered with the command as well as what the output of the command is.

### Common Commands

#### \*CLS

Clears the error queue. Also ends all pending operations. When you write programs, use this command before each procedure to prevent buffer overflow.

#### \*IDN?

Shows the manufacturer, model number, and firmware revision of the Product.

For example:

#### \*IDN?

Shows Fluke, 3130 0, 1.00

### **Calibrator Commands**

#### **DAMP**

Turns on or off the dampening function.

For example:

If you send DAMP ON, this will turn the dampening function on.

#### **DAMP?**

Shows the current state of the dampening function.

For example:

If you send DAMP?, this will show ON if the dampening function is on.

#### **DISPLAY**

Turns on or off the indicated display.

For example:

If you send DISPLAY LOWER, ON, this will turn on the lower display.

#### **DISPLAY?**

Shows the current state of the each of the displays.

For example:

If you send DISPLAY?, it will show ON, ON, ON if the all the displays are on.

#### **FAULT?**

Shows the error code number of an error that has occurred. The command can be entered if the previous command did not do what it was meant to do.

For example, if a value for current output is entered that is larger than the supported range (0-24 mA), FAULT? shows:

103 which is the code number for an entry over range.

Refer to Table 6 for more information about error code numbers.

#### **ERROR\_LOOP**

Turns on or off loop power in percent error mode.

For example:

To set loop power on, send ERROR\_LOOP ON.

### **ERROR\_LOOP?**

Shows the current state of loop power in percent error mode.

For example:

If you send ERROR\_LOOP?, it will show ON if loop power is on in error mode.

### **ERROR\_MODE**

Turns on or off percent error mode.

For example:

To turn on percent error mode, send ERROR\_MODE ON.

### **ERROR\_MODE?**

Shows the current state of percent error mode.

For example:

If you send ERROR\_MODE?, it will show ON if the Product is in percent error mode.

### **ERROR\_PORT**

Sets the pressure port for percent error.

For example:

To set the pressure port for percent error to [P1] send ERROR\_PORT P1.

### **ERROR\_PORT?**

Shows the current pressure port for percent error mode.

For example:

If you send ERROR\_PORT?, it will show P1 if the pressure port in percent error is [P1].

### **FUNC**

Sets the display indicated in argument 1 to the function indicated in argument 2.

For example:

To set the lower display to pressure mode, send FUNC LOWER,[P1].

### **FUNC?**

Shows the current mode of all displays. For example if the Product is set to [P2] ST on the upper display, [P1] on the middle, and [P1] on the lower, FUNC? shows:

ST\_P2,P1,[P1]

**HART\_ON**

Turns on the Hart resistor.

**HART\_OFF**

Turns off the Hart resistor.

**HART?**

Shows the state of the Hart resistor.

For example:

If the Hart resistor was on, HART? shows ON.

**HI\_ERR**

Sets the 100 % point for the percent error mode calculation in the current engineering units.

For example:

To set the 100 % point to 100 psi, send HI\_ERR 100.

**HI\_ERR?**

Shows the 100 % point for the percent error mode calculation.

For example:

If the 100 % point is set to 100 psi, HI\_ERR? shows 1.000000E+02, PSI .

**IO\_STATE**

Sets the input/output/simulate state of the mA function of the Product. This does not put the Product into mA if it is not in it already.

For example:

If the Product is in mA simulate modem sending IO\_STATE MEASURE would put it into measure mode.

**IO\_STATE?**

Shows the input/output/simulate state of the mA function of the Product.

For example:

If the Product was in mA simulate mode, IO\_STATE? shows SIM.

### **LOCAL**

Returns the Product to local operation if it was in remote mode. The command also clears LOCKOUT if the Product was in lockout mode.

### **LOCKOUT**

Sending this command sets the lockout state, when the unit is in REMOTE or goes to remote, it stops use of the keypad completely. The lockout state can only be cleared by sending the LOCAL command.

### **LO\_ERR**

Sets the 0 % point for the percent error mode calculation in the current engineering units.

For example:

To set the 0 % point to 20 psi, send LO\_ERR 20.

### **LO\_ERR?**

Shows the 0 % point for the percent error mode calculation.

For example:

If the 0 % point is set to 20 psi, LO\_ERR? shows 2.000000E+01, PSI .

### **MOTOR\_ON**

Turns on the motor.

### **MOTOR\_OFF**

Turns off the motor.

### **MOTOR?**

Shows the state of the motor.

For example:

If the motor was on, MOTOR? shows ON.



## **OUT**

This command also switches the Product into mA output mode. A number and a unit must be entered after the command.

For example:

OUT 5 MA sets the current output at 5 mA.

## **OUT?**

Shows the output of the Product.

Using the above example, OUT? shows: 5.000000E-03, A.

## **PRES\_UNIT**

Used to set the pressure unit for the indicated display.

For example:

To set the pressure unit to psi on the lower display, send PRES\_UNIT LOWER, PSI.

## **PRES\_UNIT?**

Shows the pressure unit used when measuring pressure for each of the three displays.

## **PUMP\_LIMIT**

Sets the approximate pressure in psi at which the pump will turn off.

For example:

PUMP\_LIMIT 50 sets the approximate value that the pump will shut off at to 50 psi.

## **PUMP\_LIMIT?**

Shows the pump limit. Using the above example, PUMP\_LIMIT? Shows:

50.000

## **REMOTE**

Puts the Product into remote mode. From the remote mode the user can still use the keypad to get back to local mode unless the command LOCKOUT was entered before REMOTE. Then the keypad is completely locked out, and the user has to send the LOCAL command to go to local operation.

### **SIM**

Sets the output for current simulation. This command also switches the Product into mA simulation mode. A number and a unit must be entered after the command.

For example:

SIM 5 MA sets the current simulation at 5 mA

### **SIM?**

Shows the output of the current simulation. With the example above, the output would be: 5.000000E-03, A

### **ST\_START**

Starts a switch test.

### **ST\_CLOSE?**

Shows the pressure that the switch closed at in the current pressure units.

### **ST\_OPEN?**

Shows the pressure that the switch opened at in the current pressure units.

### **ST\_DEAD?**

Shows deadband of the switch in the current pressure units.

### **VAL?**

Shows the value of measurement on a maximum of three displays. For example, if the upper display shows pressure at 0.00 bar on P1, the middle display shows pressure at 0 psi on P1, and the lower display shows 0 mA, then VAL? will return:

0.000000E+00,BAR,0.000000E+00,PSI,0.000000E+00,A

### **ZERO\_MEAS**

Zeroes the attached pressure module. Enter the zeroing value in PSI after the command when zeroing an absolute pressure module.

### **ZERO\_MEAS?**

Shows the zero offset or the reference value for absolute pressure modules.

## Maintenance

### Warning

For safe operation and maintenance of the Product:

- Use only Fluke approved power adapters to charge the battery.

To prevent possible electrical shock, fire, or personal injury:

- Use only specified replacement parts.
- Have an approved technician repair the Product.

Clean the Product and pressure modules with a soft cloth dampened with water or water and mild soap.

### Caution

To prevent possible damage to the Product, do not use solvents or abrasive cleansers.

## User-Replaceable Parts and Accessories

Table 7 lists the Fluke part number of each user-replaceable part or accessory for the Product.

Table 7. Replaceable Parts

Item Description	Fluke Part Number
Test cables (1x red, 1x black), 48 in, stackable	3971218
16 V 5.06 A ac adapter/charger	4312648
Filter Pack and end plates	4296874

## Specifications

Specifications are valid for one year unless otherwise noted.

### Electrical Specification

Measurement Inputs	Range	Accuracy
mA	0 mA to 24.000 mA	0.015 % of reading $\pm 0.002$ mA
Volts	0 mA to 30.000 V dc	0.015 % of reading $\pm 0.002$ V

Outputs	Range
mA	4 mA to 24.00 mA
Volts	24 V dc <sup>[1]</sup>
[1] Available in mA or V measurement mode	

### Pressure

Pressure .....	-12 to 300.00 psi
mA .....	0 to 24.000 mA
Volts .....	0 to 30.000 V dc
Engineering Units .....	psi, bar, mbar, kPa, MPa, kgcm <sup>2</sup> , mmH <sub>2</sub> O @ 4 °C, mmH <sub>2</sub> O @ 20 °C, cmH <sub>2</sub> O @ 4 °C, cmH <sub>2</sub> O @ 20 °C, inH <sub>2</sub> O @ 4 °C, inH <sub>2</sub> O @ 20 °C, inH <sub>2</sub> O @ 60 °F, mmHg @ 0 °C, inHg @ 0 °C

### Accuracy

Pressure .....	1 year: 0.025 % of reading $\pm 0.01$ % FS
mA .....	$\pm 0.015$ % of reading $\pm 0.002$ mA
Volts .....	$\pm 0.015$ % of reading $\pm 0.002$ V
Temperature Effect (all functions) .....	No effect on accuracy on all functions from 15 °C to 35 °C Add $\pm 0.002$ % F.S. /°C for temps outside of 15 °C to 35 °C

### Loop Power

24 V .....	23 V to 28 V
------------	--------------

### Mechanical Specification

Size (H X W X L).....	(387 x 305 x 178) mm, (15.3 x 12.0 x 7.0) in
Weight .....	~7.0 kg (15.5 lb)

### Environmental

Operating Temperature.....	-10 °C to +50 °C (14 °F to 122 °F)
Storage .....	-20 °C to +55 °C (-4 °F to +131 °F)
Humidity .....	10 % to 95 % RH Non-condensing
Altitude.....	2000 meters, limited by ac adapter

Media Compatibility.....	Any clean, dry, non-corrosive gas
<b>Standards and Agency Approval</b>	
Safety.....	IEC 61010-1, 30V Max, Pollution Degree 2
Electromagnetic Environment.....	IEC 61326-1: Basic/Portable
Ingress Protection.....	IP67 (Case closed), IP40 (Case open)
Vibration.....	MIL-PRF-28800F (Class 3-Random)
<b>Power</b>	
Power Requirements.....	16 V dc (Universal AC Adapter/Charger supplied) Internal 3800 mAh advanced NiMH pack
Battery life (fully-charged).....	Approximately 50 hours (Only measurement or with external pressure supply) 125 pump cycles to 20 bar 300 pump cycles to 10 bar 1,000 pump cycles to 2 bar



---

35 Vantage Point Drive // Rochester, NY 14624 // Call 1.800.800.5001

