

Brief Operating Instructions

Deltabar S

PMD75, FMD77, FMD78

Differential pressure measurement

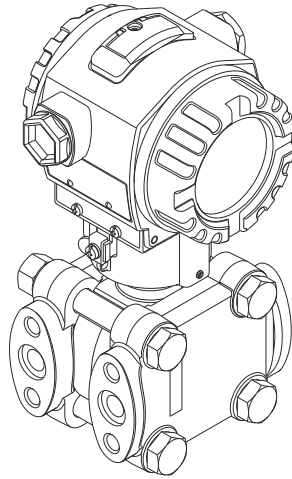

These Instructions are Brief Operating Instructions; they are not a substitute for the Operating Instructions pertaining to the device.

Detailed information about the device can be found in the Operating Instructions and the other documentation:

Available for all device versions via:

- Internet: www.endress.com/deviceviewer
- Smart phone/tablet: *Endress+Hauser Operations App*

TRANSCAT[®]
Trust in every measure

Visit us at Transcat.com

sales@transcat.com 1.800.828.1470

Endress+Hauser 

People for Process Automation

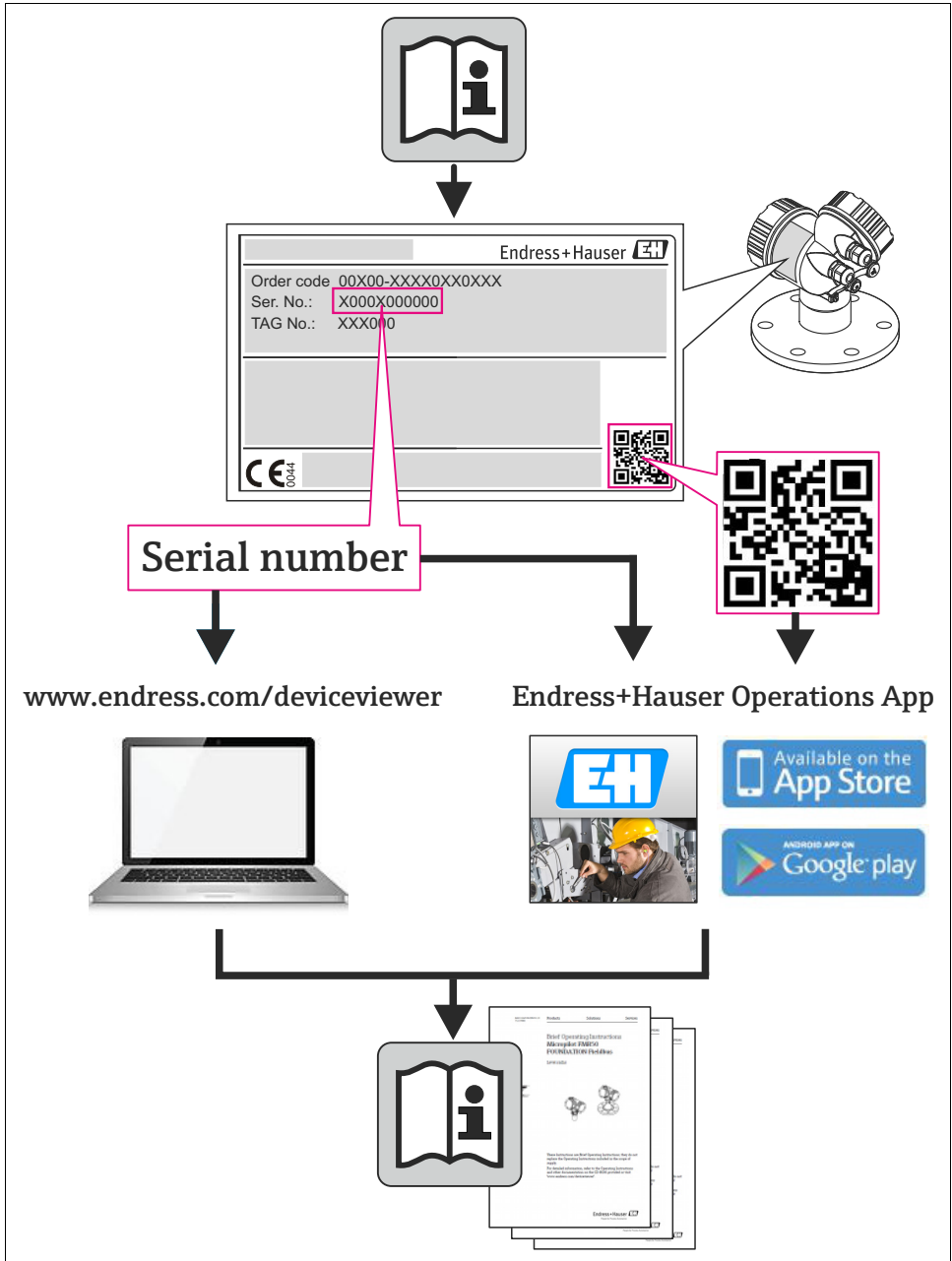

A0023555

Table of contents

| | | |
|-----|--|----|
| 1 | Document information | 4 |
| 1.1 | Document function | 4 |
| 1.2 | Symbols used | 4 |
| 2 | Basic safety instructions | 7 |
| 2.1 | Requirements concerning the staff | 7 |
| 2.2 | Designated use | 7 |
| 2.3 | Workplace safety | 7 |
| 2.4 | Operational safety | 7 |
| 2.5 | Hazardous area | 8 |
| 2.6 | Product safety | 8 |
| 2.7 | Functional Safety SIL3 (optional) | 8 |
| 3 | Identification | 9 |
| 3.1 | Product identification | 9 |
| 4 | Installation | 9 |
| 4.1 | Seal for flange mounting | 9 |
| 4.2 | General installation instructions | 10 |
| 4.3 | Measuring arrangement | 11 |
| 4.4 | Installation instructions for devices with diaphragm seals (FMD78) | 12 |
| 4.5 | Heat insulation | 13 |
| 4.6 | Assembling and mounting the "separate housing" version | 14 |
| 5 | Wiring | 15 |
| 5.1 | Connecting the device | 15 |
| 5.2 | Connecting the measuring unit | 16 |
| 6 | Operation | 18 |
| 6.1 | On-site display (optional) | 18 |
| 6.2 | Operating elements | 20 |
| 6.3 | On-site operation via on-site display | 23 |
| 6.4 | Locking/unlocking operation | 27 |
| 7 | Commissioning | 28 |
| 7.1 | Configuring messages | 28 |
| 7.2 | Position adjustment | 28 |
| 7.3 | Differential pressure measurement | 29 |
| 7.4 | Level measurement | 33 |
| 7.5 | Flow measurement | 37 |





1 Document information

1.1 Document function







These Operating Instructions contain all the information that is required in various phases of the life cycle of the device: from product identification, incoming acceptance and storage, to mounting, connection, operation and commissioning through to troubleshooting, maintenance and disposal.

1.2 Symbols used



1.2.1 Safety symbols

| Symbol | Meaning |
|---|--|
|  A0011189-DE | DANGER! This symbol alerts you to a dangerous situation. Failure to avoid this situation will result in serious or fatal injury. |
|  A0011190-DE | WARNING! This symbol alerts you to a dangerous situation. Failure to avoid this situation can result in serious or fatal injury. |
|  A0011191-DE | CAUTION! This symbol alerts you to a dangerous situation. Failure to avoid this situation can result in minor or medium injury. |
|  A0011192-DE | NOTICE! This symbol contains information on procedures and other facts which do not result in personal injury. |









1.2.2 Electrical symbols

| Symbol | Meaning | Symbol | Meaning |
|--|--|---|--|
|  | Direct current |  | Alternating current |
|  | Direct current and alternating current |  | Ground connection A grounded terminal which, as far as the operator is concerned, is grounded via a grounding system. |
|  | Protective ground connection A terminal which must be connected to ground prior to establishing any other connections. |  | Equipotential connection A connection that has to be connected to the plant grounding system: This may be a potential equalization line or a star grounding system depending on national or company codes of practice. |

1.2.3 Tool symbols

| Symbol | Meaning |
|---|----------------|
|  A0011221 | Allen key |
|  A0011222 | Hexagon wrench |

1.2.4 Symbols for certain types of information

| Symbol | Meaning |
|---|--|
|  A0011182 | Permitted Indicates procedures, processes or actions that are permitted. |
|  A0011184 | Forbidden Indicates procedures, processes or actions that are forbidden. |
|  A0011193 | Tip Indicates additional information. |
|  A0015482 | Reference to documentation |
|  A0015484 | Reference to page |
|  A0015487 | Reference to graphic |
| 1., 2., 3., ... | Series of steps |
|  A0018343 | Result of a sequence of actions |
|  A0015502 | Visual inspection |

1.2.5 Symbols in graphics

| Symbol | Meaning |
|-----------------|-----------------|
| 1, 2, 3, 4, ... | Item numbers |
| 1., 2., 3., ... | Series of steps |
| A, B, C, D, ... | Views |

1.2.6 Symbols at the device

| Symbol | Meaning |
|--|---|
|  | <p>Safety instructions Observe the safety instructions contained in the associated Operating Instructions.</p> |

1.2.7 Registered trademarks

KALREZ, VITON, TEFLON

Registered trademarks of E.I. Du Pont de Nemours & Co., Wilmington, USA

TRI-CLAMP

Registered trademark of Ladish & Co., Inc., Kenosha, USA

HART

Registered trademark of the HART Communication Foundation, Austin, USA.

GORE-TEX®

Registered trademarks of W.L. Gore & Associates, Inc., USA

2 Basic safety instructions

2.1 Requirements concerning the staff

The personnel for installation, commissioning, diagnostics and maintenance must fulfill the following requirements:

- Trained, qualified specialists: must have a relevant qualification for this specific function and task
- Are authorized by the plant owner/operator
- Are familiar with federal/national regulations
- Before beginning work, the specialist staff must have read and understood the instructions in the Operating Instructions and supplementary documentation as well as in the certificates (depending on the application)
- Following instructions and basic conditions

The operating personnel must fulfill the following requirements:

- Being instructed and authorized according to the requirements of the task by the facility's owner-operator
- Following the instructions in these Operating Instructions

2.2 Designated use

The Deltabar S is a differential pressure transmitter for measuring differential pressure, flow and level.

2.2.1 Incorrect use

The manufacturer is not liable for damage caused by improper or non-designated use.

Verification for borderline cases:

For special fluids and fluids for cleaning, Endress+Hauser is glad to provide assistance in verifying the corrosion resistance of fluid-wetted materials, but does not accept any warranty or liability.

2.3 Workplace safety

For work on and with the device:

- Wear the required personal protective equipment according to federal/national regulations.
- Switch off the supply voltage before connecting the device.

2.4 Operational safety

Risk of injury!

- ▶ Operate the device in proper technical condition and fail-safe condition only.
- ▶ The operator is responsible for interference-free operation of the device.

Conversions to the device

Unauthorized modifications to the device are not permitted and can lead to unforeseeable dangers:

- ▶ If, despite this, modifications are required, consult with Endress+Hauser.

Repair

To ensure continued operational safety and reliability,

- ▶ Carry out repairs on the device only if they are expressly permitted.
- ▶ Observe federal/national regulations pertaining to repair of an electrical device.
- ▶ Use original spare parts and accessories from Endress+Hauser only.

2.5 Hazardous area

To eliminate a danger for persons or for the facility when the device is used in the hazardous area (e.g. explosion protection, pressure vessel safety):

- Based on the nameplate, check whether the ordered device is permitted for the intended use in the hazardous area.
- Observe the specifications in the separate supplementary documentation that is an integral part of these Instructions.

2.6 Product safety

This measuring device is designed in accordance with good engineering practice to meet state-of-the-art safety requirements, has been tested, and left the factory in a condition in which they are safe to operate. It fulfills general safety requirements and legal requirements. It also conforms to the EC directives listed in the device-specific EC declaration of conformity. Endress+Hauser confirms this fact by applying the CE mark.

2.7 Functional Safety SIL3 (optional)

If using devices for applications with safety integrity, the Functional Safety Manual must be observed thoroughly.

3 Identification

3.1 Product identification

The following options are available for identification of the measuring device:

- Nameplate specifications
- Order code with breakdown of the device features on the delivery note
- Enter serial numbers from nameplates in W@M Device Viewer (www.endress.com/deviceviewer): All information about the measuring device is displayed.

For an overview of the technical documentation provided, enter the serial number from the nameplates in the W@M Device Viewer (www.endress.com/deviceviewer).

4 Installation

NOTICE

Incorrect handling!

Damage of the device!

- ▶ Disassembly of the screws with item number (1) is not permissible under any circumstances and will result in loss of warranty.

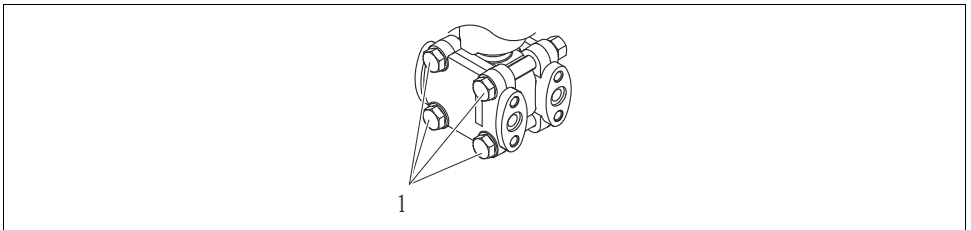

A0025336

4.1 Seal for flange mounting

NOTICE

Distorted measurement results.

The seal is not allowed to press on the process isolating diaphragm as this could affect the measurement result.

- ▶ Ensure that the seal is not touching the process isolating diaphragm.

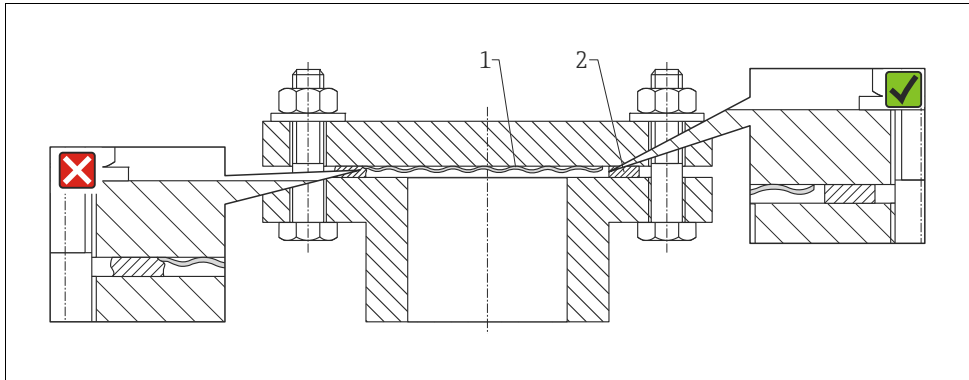

Fig. 1:
 1 Process isolating diaphragm
 2 Seal

A0017743

4.2 General installation instructions

- Due to the orientation of the Deltabar S, there may be a shift in the measured value, i.e. when the container is empty, the measured value does not display zero. You may correct this zero point shift either directly on the device using the "E"-key or by remote operation. → See Page 20, 4.2.1 "Position of operating elements", Page 21, Section 4.2.3 "Function of the operating elements" and Page 28, Section 5.1 "Position adjustment".
- For FMD77 and FMD78, please refer to Section 2.3 "Installation instructions for devices with diaphragm seals", Page 12.
- The FMD77 must only be insulated up to a certain height.
- General recommendations for routing the impulse piping can be found in DIN 19210 "Methods for measurement of fluid flow; differential piping for flow measurement devices" or the corresponding national or international standards.
- Using a three-valve or five-valve manifold allows for easy commissioning, installation and maintenance without interrupting the process.
- When routing the impulse piping outdoors, ensure that sufficient anti-freeze protection is used, e.g. by using pipe heat tracing.
- Install the impulse piping with a monotonic gradient of at least 10%.
- Do not clean or touch diaphragm seals with hard or pointed objects.
- To ensure optimal readability of the on-site display, it is possible to rotate the housing up to 380°.
- The onsite display can be rotated in 90° stages
- Endress+Hauser offers a mounting bracket for installing on pipes or walls.

4.3 Measuring arrangement

4.3.1 Pressure measurement

- The PMD75 and FMD78 are best suited for differential pressure measurement.
- Measuring arrangement for gases: Mount device above the measuring point.
- Measuring arrangement for liquids and steams: Mount device below tapping point.
- For differential pressure measurement in vapour, mount the condensate traps at the same level as the same the tapping point and at the same distance from Deltabar S.

4.3.2 Level measurement

- All Deltabar S devices are best suited for level measurement in closed tanks.
- PMD75 and FMD77 are suitable to level measurement in open tanks.

Measuring arrangement level measurement in closed tanks and closed tanks with superimposed vapour

- PMD75: Mount device below the lower measuring connection. Always connect the negative side above the maximum level via an impulse piping.
- FMD77: Mount device direct on the tank. Always connect the negative side above the maximum level via an impulse piping.
- FMD78 see Chap. 4.4 and Chap. 4.6
- In the case of level measurement in closed tanks with superimposed vapour, a condensate trap ensures pressure which remains constant on the minus side.

Measuring arrangement level measurement in open tanks

- FMD77: Mount device direct on the tank. The negative side is open to atmosphere pressure.
- PMD75: Mount device below the lower measuring connection. The negative side is open to atmosphere pressure.

4.3.3 Flow measurement

- The PMD75 are best suited for flow measurement.
- Measuring arrangement for gases: Mount device above the measuring point.
- Measuring arrangement for liquids and vapours: Mount device below tapping point.
- For flow measurement in vapours, mount the condensate traps at the same level as the same the tapping point and at the same distance from Deltabar S.

4.4 Installation instructions for devices with diaphragm seals (FMD78)

- The diaphragm seal, together with the pressure transmitter, forms a closed, calibrated system, which is filled through openings in the diaphragm seal and in the measurement system of the pressure transmitter. This openings are sealed and must not be opened.
- Do not remove the protection of the process isolating diaphragm protection until shortly before installation.
- When using a mounting bracket, sufficient strain relief must be ensured for the capillaries in order to prevent the capillary bending down (bending radius ≥ 100 mm).
- Please note that the hydrostatic pressure of the liquid columns in the capillaries can cause zero point shift. The zero point shift can be corrected. → See Page 20, Section "Position of operating elements", Page 21, Section 4.2.2 "Function of the operating elements" and Page 28, Section 5.1 "Position adjustment".
- Please note the application limits of the diaphragm seal filling oil as detailed in the Technical Information for Deltabar S TI00382P, Section "Planning instructions for diaphragm seal systems" or at "www.endress.com/applicator".

In order to obtain more precise measurement results and to avoid a defect in the device, mount the capillaries as follows:

- vibration-free (in order to avoid additional pressure fluctuations)
- not in the vicinity of heating or cooling lines
- insulate if the ambient temperature is below or above the reference temperature
- with a bending radius of ≥ 100 mm.
- The ambient temperature and length of both capillaries should be the same when using two-sided diaphragm seal systems.
- Two diaphragm seals which are the same (e.g. with regard to diameter, material, etc.) should always be used for the negative and positive side (standard delivery).

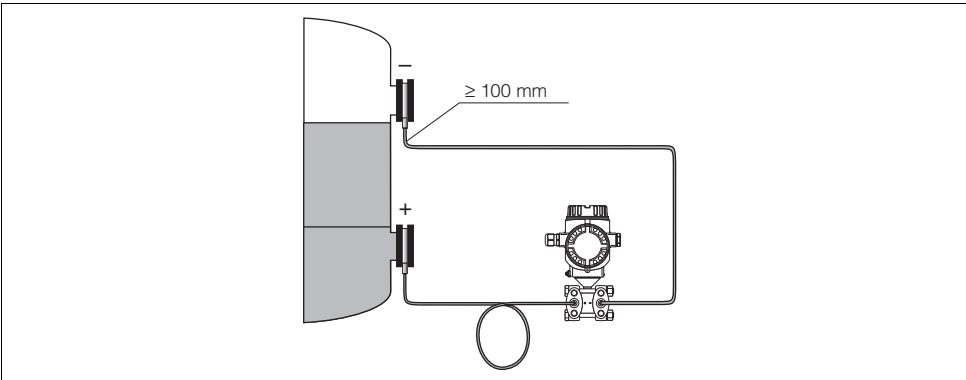

PD1-FMD78xxx-11-xx-xx-xx-005

Fig. 2: Mounting Deltabar S, FMD78 with diaphragm seals and capillary, recommended mounting for vacuum applications: mount pressure transmitter below the lowest diaphragm seal!

4.4.1 Vacuum application (FMD78)

For applications under vacuum, Endress+Hauser recommends mounting the pressure transmitter underneath the lower diaphragm seal. A vacuum load of the diaphragm seal caused by the presence of filling oil in the capillaries is hereby prevented.

When the pressure transmitter is mounted above the lower diaphragm seal, the maximum height difference H1 in accordance with the illustration below on the left must not be exceeded. The maximum height difference is dependent on the density of the filling oil and the smallest ever pressure that is permitted to occur at the diaphragm seal on the positive side (empty container), see illustration below, on the right.

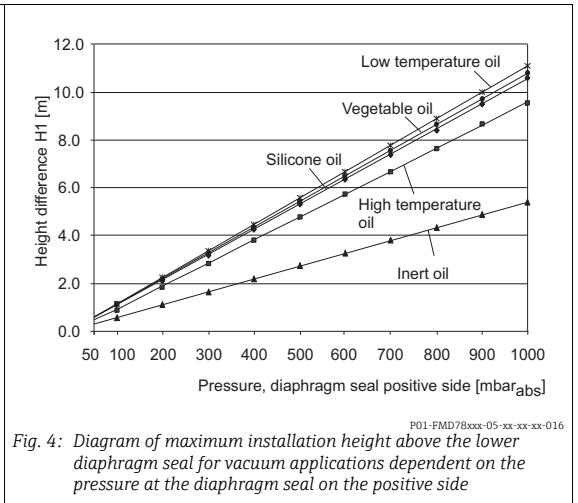
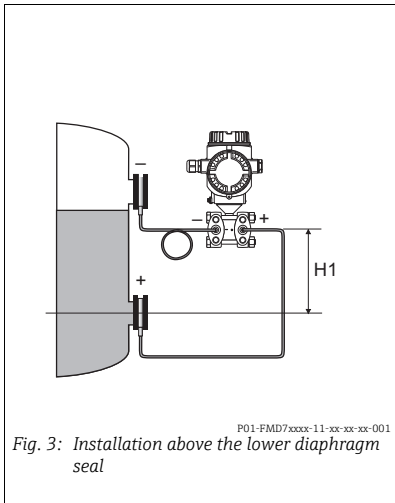

4.5 Heat insulation

See Operating Instructions.

4.6 Assembling and mounting the "separate housing" version

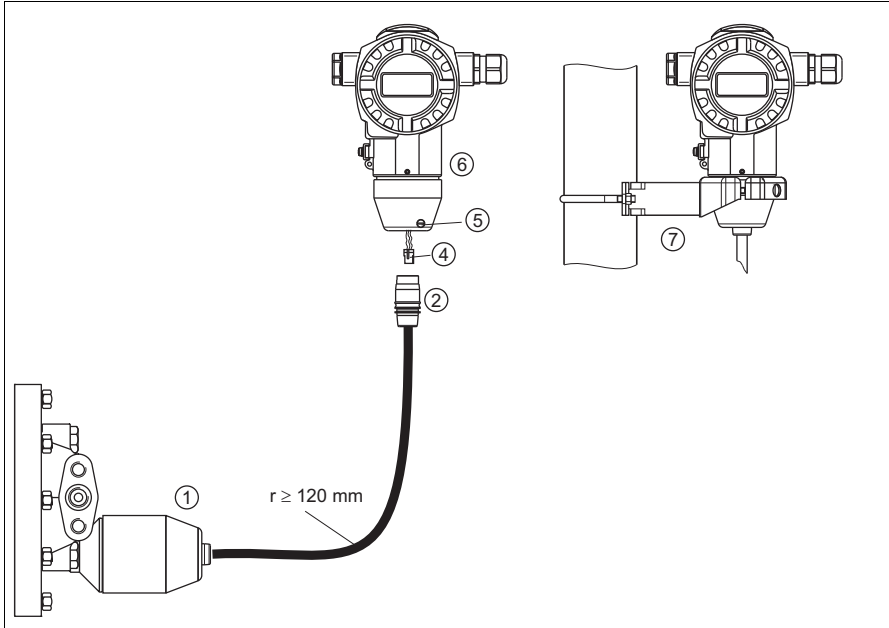

Fig. 5: "Separate housing" version

P01-xMD/xxxx-11-xx-xx-xx-011

- 1 In the "separate housing" version, the sensor is supplied with process connection and cable fitted.
- 2 Cable with connection jack
- 4 Plug
- 5 Locking screw
- 6 Housing fitted with housing adapter, included
- 7 Mounting bracket suitable for wall and pipe mounting, included

Assembly and mounting

1. Connect plug (item 4) into the corresponding connection jack of the cable (item 2).
2. Plug the cable into the housing adapter (item 6).
3. Tighten the locking screw (item 5).
4. Mount the housing on a wall or pipe using the mounting bracket (item 7). When mounting on a pipe, tighten the nuts on the bracket uniformly with a torque of at least 5 Nm.
Mount the cable with a bending radius (r) ≥ 120 mm.

5 Wiring

5.1 Connecting the device

⚠ WARNING

Risk of electric shock!

If the operating voltage is > 35 VDC: Dangerous contact voltage at terminals.

- ▶ In a wet environment, do not open the cover if voltage is present.

⚠ WARNING

Limitation of electrical safety due to incorrect connection!

- Risk of electric shock and/or explosion in hazardous areas! In a wet environment, do not open the cover if voltage is present.
- When using the measuring device in hazardous areas, installation must comply with the corresponding national standards and regulations and the Safety Instructions or Installation or Control Drawings.
- Devices with integrated overvoltage protection must be earthed.
- Protective circuits against reverse polarity, HF influences and overvoltage peaks are installed.
- The supply voltage must match the supply voltage on the nameplate.
- Switch off the supply voltage before connecting the device.
- Remove housing cover of the terminal compartment.
- Guide cable through the gland. Preferably use twisted, screened two-wire cable.
- Connect device in accordance with the following diagram.
- Screw down housing cover.
- Switch on supply voltage.

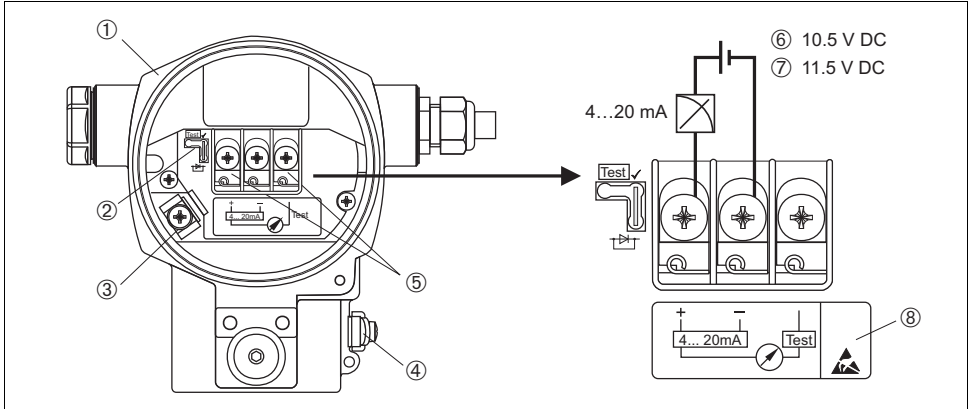

Fig. 6: Electrical connection 4...20 mA HART → Observe also the following section.
For devices with Harting Han7D or M12 plug see Operating Instructions.

P01-xMc7xxxx-04-xx-xx-xx-001

- 1 Housing
- 2 Jumper for 4...20 mA test signal. → See also the following section.
- 3 Internal earth terminal
- 4 External earth terminal
- 5 4...20 mA test signal between plus and test terminal
- 6 Minimum supply voltage = 10.5 V DC, jumper is inserted in accordance with the illustration.
- 7 Minimum supply voltage = 11.5 V DC, jumper is inserted in "Test" position.
- 8 Devices with integrated overvoltage protection are labelled OVP (overvoltage protection) here.

5.2 Connecting the measuring unit

5.2.1 Supply voltage and taking 4...20 mA test signal

| Jumper position for test signal | Description |
|---------------------------------|--|
| | <ul style="list-style-type: none"> - Taking 4...20 mA test signal via plus and test terminal: possible. (Thus, the output current can be measured without interruption via the diode.) - Delivery status - minimum supply voltage (at the terminals): 11.5 V DC |
| | <ul style="list-style-type: none"> - Taking 4...20 mA test signal via plus and test terminal: not possible. - minimum supply voltage (at the terminals): 10.5 V DC |

5.2.2 Cable specification

- Endress+Hauser recommends using twisted, screened two-wire cables.
- Terminals for wire cross-sections 0.5...2.5 mm²
- Cable external diameter: 5...9 mm

5.2.3 Screening/potential matching

- You achieve optimum screening against disturbances if the screening is connected on both sides (in the cabinet and on the device). If you have to reckon with potential equalisation currents in the plant, only earth screening on one side, preferably at the transmitter.
- When using in hazardous areas, you must observe the applicable regulations. Separate Ex documentation with additional technical data and instructions is included with all Ex systems as standard.

6 Operation

6.1 On-site display (optional)

A 4-line liquid crystal display (LCD) is used for display and operation. The on-site display shows measured values, dialog texts, fault messages and notice messages.





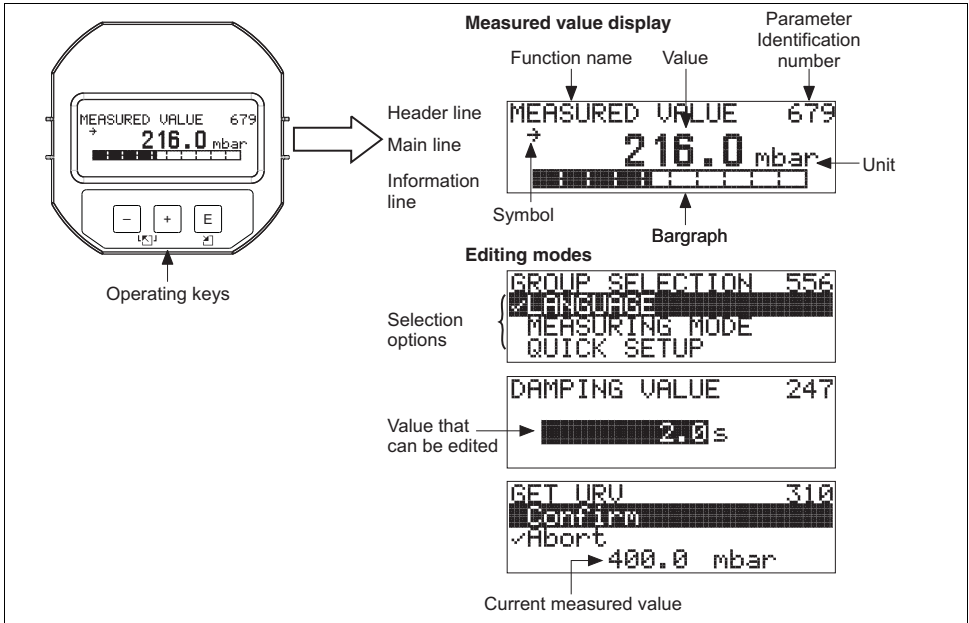

The display of the device can be turned in 90° steps.

Depending on the installation position of the device, this makes it easy to operate the device and read the measured values.



P01-4Mx7xxxx-07-xx-xx-xx-001

The following table illustrates the symbols that can appear on the on-site display. Four symbols can occur at one time.

| Symbol | Meaning |
|---|--|
|  | Alarm symbol – Symbol flashing: warning, device continues measuring. – Symbol permanently lit: error, device does not continue measuring. <i>Note:</i> The alarm symbol may overlie the tendency symbol. |
|  | Lock symbol The operation of the device is locked. Unlock device, → see Page 27, Section 4.4. |
|  | Communication symbol Data transfer via communication |
|  | Square root symbol Active measuring mode "Flow measurement" The root flow signal is used for the current output. |
|  | Tendency symbol (increasing) The measured value is increasing. |
|  | Tendency symbol (decreasing) The measured value is decreasing. |
|  | Tendency symbol (constant) The measured value has remained constant over the past few minutes. |

6.2 Operating elements

6.2.1 Position of operating elements

With regard to aluminium housings (T14/T15) and stainless steel housing (T14), the operating keys are located either outside the device under the protection cap or inside on the electronic insert. In hygienic stainless housings (T17), the operating keys are always located inside on the electronic insert. Additionally, three operating keys are located on the optional on-site display.

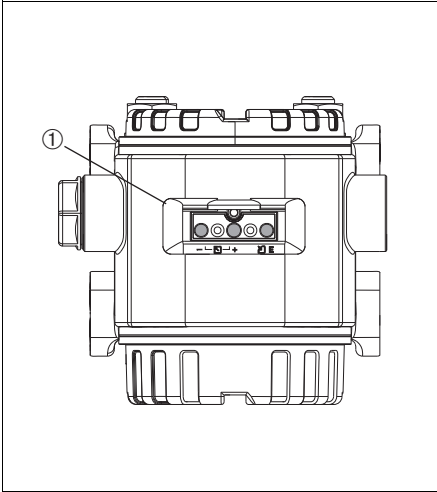

P01-xxxxxxxx-19-xx-xx-xx-056

Fig. 7: Operating keys, external

- 1 Operating keys on the exterior of the device under the protective flap

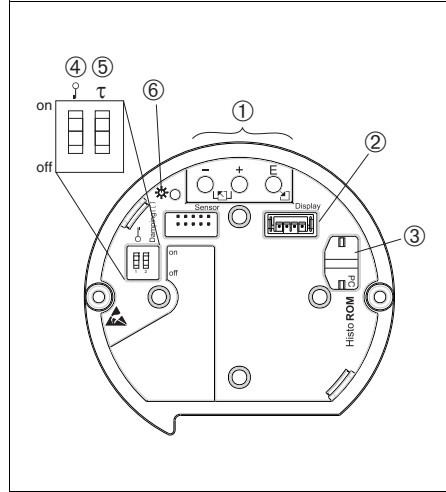





P01-xxxxxxxx-19-xx-xx-xx-104

Fig. 8: Operating keys, internal







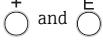
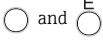
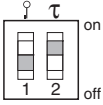

- 1 Operating keys
- 2 Slot for optional display
- 3 Slot for optional HistoROM®/M-DAT
- 4 DIP-switch for locking/unlocking measured-value-relevant parameters
- 5 DIP-switch for damping on/off
- 6 Green LED to indicate value being accepted

6.2.2 Function of the operating elements – on-site display not connected

Press and hold the key or the key combination for at least 3 seconds to execute the corresponding function. Press the key combination for at least 6 seconds for a reset.

| Operating key(s) | Meaning |
|--|--|
|  | Adopt lower range value. A reference pressure is present at the device. → See also Page 31, Section 5.2.2 "Pressure measuring mode", Page 35, Section 5.3.2 "Level measuring mode" or Page 38, Section 5.4.2 "Flow measuring mode". |
|  | Adopt upper range value. A reference pressure is present at the device. → See also Page 31, Section 5.2.2 "Pressure measuring mode", Page 35, Section 5.3.2 "Level measuring mode" or Page 38, Section 5.4.2 "Flow measuring mode". |
|  | Position adjustment |
|  | Reset all parameters. The reset via operating keys corresponds to the software reset code 7864. |
|  | Copy the configuration data from the optional HistoROM®/M-DAT module to the device. |
|  | Copy the configuration data from the device to the optional HistoROM®/M-DAT module. |
|  <p style="font-size: small;">P01-xxxxxxx-19-xx-xx-xx-057</p> | <ul style="list-style-type: none"> - DIP-switch 1: for locking/unlocking measured-value-relevant parameters Factory setting: off (unlocked) - DIP-switch 2: damping on/off, Factory setting: on (damping on) |

6.2.3 Function of the operating elements – on-site display connected

| Operating key(s) | Meaning |
|---|---|
|  | <ul style="list-style-type: none"> - Navigate upwards in the picklist - Edit the numerical values and characters within a function |
|  | <ul style="list-style-type: none"> - Navigate downwards in the picklist - Edit the numerical values and characters within a function |
|  | <ul style="list-style-type: none"> - Confirm entry - Jump to the next item |
|  and  | Contrast setting of on-site display: darker |
|  and  | Contrast setting of on-site display: brighter |
|  and  | ESC functions: <ul style="list-style-type: none"> - Exit edit mode without saving the changed value. - You are in a menu within a function group. The first time you press the keys simultaneously, you go back a parameter within the function group. Each time you press the keys simultaneously after that, you go up a level in the menu. - You are in a menu at a selection level. Each time you press the keys simultaneously, you go up a level in the menu. Note: The terms function group, level and selection level are explained in Section 4.3.1, Page 23. |

6.3 On-site operation via on-site display

6.3.1 Structure of the operating menu

The menu is split into four levels. The three upper levels are used to navigate while you use the bottom level to enter numerical values, select options and save settings.

→ For the entire menu see Operating Instructions BA00270P.

The structure of the OPERATING MENU depends on the measuring mode selected, e.g. if the "Pressure" measuring mode is selected, only the functions necessary for this mode are displayed.

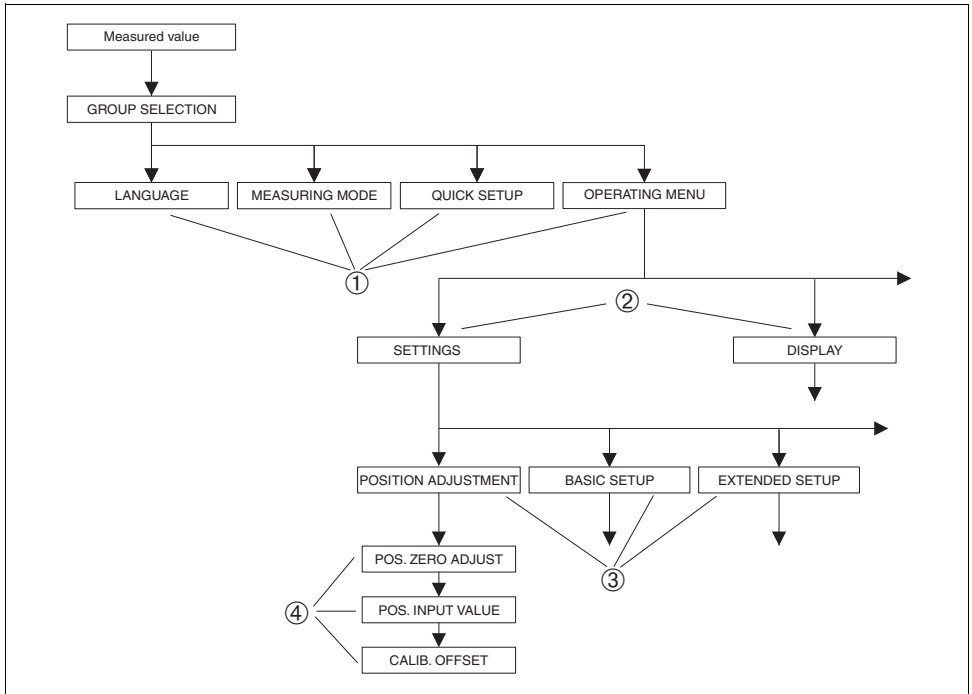

P01-xxxxxxxx-19-xx-xx-xx-145

Fig. 9: Structure of the operating menu

- 1 1. Selection level
- 2 2. Selection level
- 3 Function groups
- 4 Parameter

6.3.2 Selecting an option

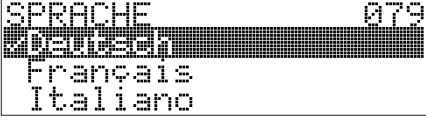
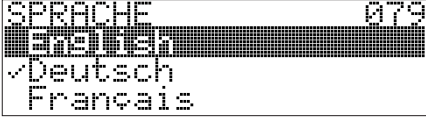
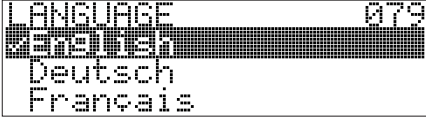

Example: select "English" as the language of the menu.

| On-site display | Operation |
|--|---|
|  <p>P01-xxxxxxxx-19-xx-xx-xx-017</p> | <p>German is selected as the language. A 3in front of the menu text indicates the active option.</p> |
|  <p>P01-xxxxxxxx-19-xx-xx-xx-033</p> | <p>Select English with "+" or "-".</p> |
|  <p>P01-xxxxxxxx-19-xx-xx-xx-034</p> | <ol style="list-style-type: none"> 1. Confirm your choice with "E". A 3 in front of the menu text indicates the active option. (English is now selected as the menu language.) 2. Jump to the next item with "E". |

6.3.3 Editing a value

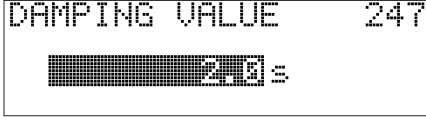
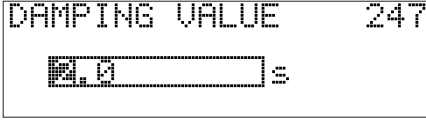

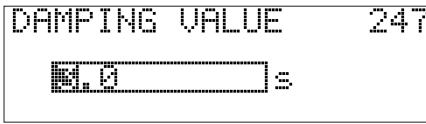
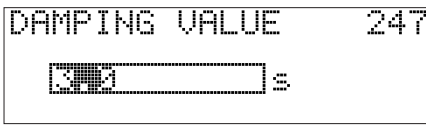
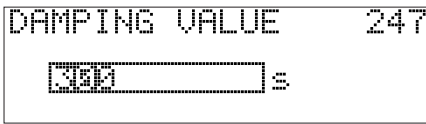
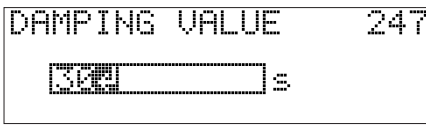

Example: adjusting DAMPING VALUE function from 2.0 s to 30.0 s. → See also Page 22, Section 4.2.3 "Function of the operating elements".

| On-site display | Operation |
|--|---|
|  <p>P01-xxxxxxxx-19-xx-xx-xx-023</p> | <p>The on-site display shows the parameter to be changed. The value highlighted in black can be changed. The "s" unit is fixed and cannot be changed.</p> |
|  <p>P01-xxxxxxxx-19-xx-xx-xx-027</p> | <ol style="list-style-type: none"> 1. Press "+" or "-" to get to the editing mode. 2. The first digit is highlighted in black. |

| On-site display | Operation |
|--|--|
|  <p style="text-align: right; font-size: small;">P01-xxxxxxxx-19-xx-xx-xx-028</p> | <ol style="list-style-type: none"> 1. Use "+" to change "2" to "3". 2. Confirm "3" with "E". The cursor jumps to the next position (highlighted in black). |
|  <p style="text-align: right; font-size: small;">P01-xxxxxxxx-19-xx-xx-xx-029</p> | <p>The decimal point is highlighted in black, i.e. you can now edit it.</p> |
|  <p style="text-align: right; font-size: small;">P01-xxxxxxxx-19-xx-xx-xx-030</p> | <ol style="list-style-type: none"> 1. Keep pressing "+" or "-" until "0" is displayed. 2. Confirm "0" with "E". The cursor jumps to the next position. ↓ is displayed and is highlighted in black. → See next graphic. |
|  <p style="text-align: right; font-size: small;">P01-xxxxxxxx-19-xx-xx-xx-031</p> | <p>Use "E" to save the new value and exit the editing mode. → See next graphic.</p> |
|  <p style="text-align: right; font-size: small;">P01-xxxxxxxx-19-xx-xx-xx-032</p> | <p>The new value for the damping is now 30.0 s.</p> <ul style="list-style-type: none"> - Jump to the next parameter with "E". - You can get back to the editing mode with "+" or "-". |

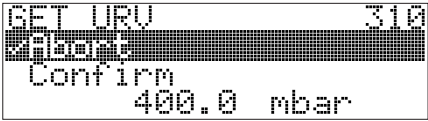
6.3.4 Taking pressure applied at device as value

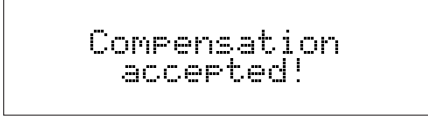
Example: configuring upper range value – assign 20 mA to the pressure value 400 mbar.

| On-site display | Operation |
|---|---|
|  <p style="text-align: right; font-size: small;">P01-xxxxxxxx-19-xx-xx-xx-035</p> | <p>The bottom line on the on-site display displays the pressure present, here 400 mbar.</p> |
|  <p style="text-align: right; font-size: small;">P01-xxxxxxxx-19-xx-xx-xx-036</p> | <p>Use "+" or "-" to switch to the "Confirm" option. The active selection is highlighted in black.</p> |
|  <p style="text-align: right; font-size: small;">P01-xxxxxxxx-19-xx-xx-xx-037</p> | <p>Use "E" to assign the value (400 mbar) to the GET URV parameter. The device confirms the calibration and jumps back to the parameter, here GET URV (see next graphic).</p> |
|  <p style="text-align: right; font-size: small;">P01-xxxxxxxx-19-xx-xx-xx-035</p> | <p>Switch to the next parameter with "E".</p> |

6.4 Locking/unlocking operation

Once you have entered all the parameters, you can lock your entries against unauthorised and undesired access.

You have the following possibilities for locking/unlocking the operation:

- Via a DIP-switch on the electronic insert, locally on the display (→ see Page 20, Fig. 7).
- Via the on-site display (optional)
- Via digital communication.

The -symbol on the on-site display indicates that operation is locked. Parameters which refer to how the display appears, e.g. LANGUAGE and DISPLAY CONTRAST can still be altered.

The table provides an overview of the locking functions:

| Locking via | View/ read parameter | Modify/write via ¹⁾ | | Unlocking via | | |
|------------------|----------------------------|--------------------------------|---------------------|---------------|--------------------|---------------------|
| | | On-site display | Remote operation | DIP-Switch | On-site display | Remote operation |
| DIP-Switch | yes | no | no | yes | no | no |
| On-site display | yes | no | no | no | yes | yes |
| Remote operation | yes | no | no | no | yes | yes |

1) Parameters which refer to how the display appears, e.g. LANGUAGE and DISPLAY CONTRAST can still be altered.

| | Locking/Unlocking operation via on-site display or remote operation |
|---------------------|---|
| Locking operation | <ol style="list-style-type: none"> 1. Select INSERT PIN NO. parameter, Menu path: GROUP SELECTION → OPERATING MENU → OPERATION → INSERT PIN NO. 2. To lock operation, enter a number for this parameter between 0..9999 that is ≠100. |
| Unlocking operation | <ol style="list-style-type: none"> 1. Select INSERT PIN NO. parameter. 2. To unlock operation, enter "100" for the parameter. |

7 Commissioning

The device is configured for the Pressure measuring mode as standard. The measuring range and the unit in which the measured value is transmitted correspond to the specifications on the nameplate.

⚠ WARNING

Exceeding the maximum allowable working pressure!

Risk of injury due to bursting of parts! Warning messages are generated if pressure is too high.

- ▶ If a pressure greater than the maximum permitted pressure is present at the device, the messages "E115 Sensor overpressure" and "E727 Sensor pressure error - overrange" are output in succession! Use the device only within the sensor range limits

NOTICE

Shortfall of the allowable working pressure!

Output of messages if pressure is too low.

- ▶ If a pressure smaller than the minimum permitted pressure is present at the device, the messages "E120 Sensor low pressure" and "E727 Sensor pressure error - overrange" are output in succession! Use the device only within the sensor range limits

7.1 Configuring messages

- Messages E727, E115 and E120 are "Error"-type messages and can be configured as a "Warning" or an "Alarm". These messages are configured as "Warning" messages at the factory. This setting prevents the current output from assuming the set alarm current value for applications (e.g. cascade measurement) where the user is consciously aware of the fact that the sensor range can be exceeded
- We recommend setting messages E727, E115 and E120 to "Alarm" in the following instances:
 - The sensor range does not have to be exceeded for the measuring application.
 - Position adjustment has to be carried out that has to correct a large measured error as a result of the orientation of the device (e.g. devices with a diaphragm seal).

7.2 Position adjustment

Due to the orientation of the device, there may be a shift in the measured value, i.e. when the container is empty, the measured value parameter does not display zero. There are three options to choose from when performing position adjustment.

(Menu path: GROUP SELECTION → OPERATING MENU → SETTINGS → POSITION ADJUSTMENT)

| Parameter name | Description |
|---------------------------------|---|
| POS. ZERO ADJUST (685) Entry | <p>Position adjustment – the pressure difference between zero (set point) and the measured pressure need not be known. (A reference pressure is present at the device.)</p> <p>Example:</p> <ul style="list-style-type: none"> – MEASURED VALUE = 2.2 mbar – Correct the MEASURED VALUE via the POS. ZERO ADJUST parameter with the "Confirm" option. This means that you are assigning the value 0.0 to the pressure present. – MEASURED VALUE (after pos. zero adjust) = 0.0 mbar – The current value is also corrected. <p>The CALIB. OFFSET parameter displays the resulting pressure difference (offset) by which the MEASURED VALUE was corrected.</p> <p>Factory setting: 0</p> |
| POS. INPUT VALUE (563) Entry | <p>Position adjustment – the pressure difference between zero (set point) and the measured pressure need not be known. (A reference pressure is present at the device.)</p> <p>Example:</p> <ul style="list-style-type: none"> – MEASURED VALUE = 0.5 mbar – For the POS. INPUT VALUE parameter, specify the desired set point for the MEASURED VALUE, e.g. 2 mbar. ($\text{MEASURED VALUE}_{\text{new}} = \text{POS. INPUT VALUE}$) – MEASURED VALUE (after entry for POS. INPUT VALUE) = 2.0 mbar – The CALIB. OFFSET parameter displays the resulting pressure difference (offset) by which the MEASURED VALUE was corrected. $\text{CALIB. OFFSET} = \text{MEASURED VALUE}_{\text{old}} - \text{POS. INPUT VALUE}$, here: $\text{CALIB. OFFSET} = 0.5 \text{ mbar} - 2.0 \text{ mbar} = -1.5 \text{ mbar}$ – The current value is also corrected. <p>Factory setting: 0</p> |
| CALIB. OFFSET (319) Entry | <p>Position adjustment – the pressure difference between zero (set point) and the measured pressure is known.</p> <p>Example:</p> <ul style="list-style-type: none"> – MEASURED VALUE = 2.2 mbar – Via the CALIB. OFFSET parameter, enter the value by which the MEASURED VALUE should be corrected. To correct the MEASURED VALUE to 0.0 mbar, you must enter the value 2.2 here. ($\text{MEASURED VALUE}_{\text{new}} = \text{MEASURED VALUE}_{\text{old}} - \text{CALIB. OFFSET}$) – MEASURED VALUE (after entry for calib. offset) = 0.0 mbar – The current value is also corrected. <p>Factory setting: 0</p> |

7.3 Differential pressure measurement

- FMD78: the device is ready for calibration immediately.
- PMD75: before calibrating the device, the impulse piping must be cleaned and filled with fluid. → See the following table.

7.3.1 Quick Setup menu for Pressure measuring mode – on-site display

See also Page 22, Section 4.2.3 "Function of the operating elements" and Page 23, 4.3 "On-site operation via on-site display".

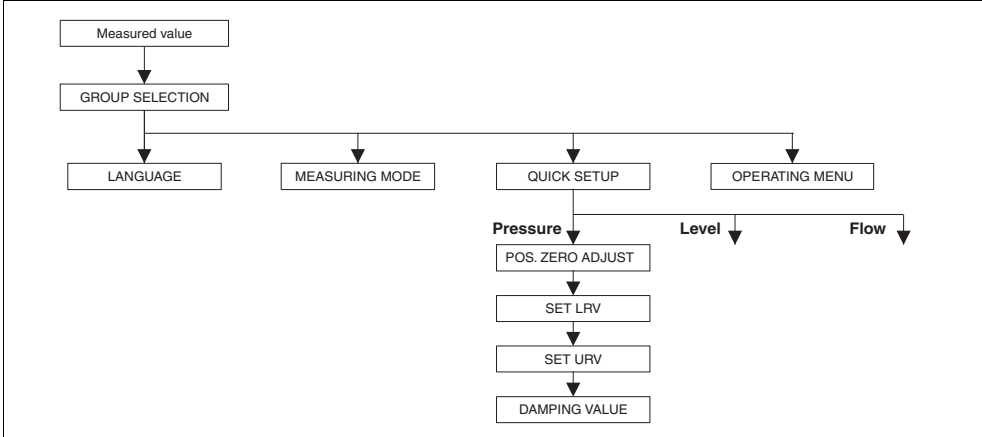

Fig. 10: Quick Setup menu for Pressure measuring mode

P01-xxxxxxx-19-xx-xx-xx-146

| |
|--|
| On-site operation |
| <p>Measured value display On-site display: Switch from the measured value display to GROUP SELECTION with F.</p> |
| <p>GROUP SELECTION Select MEASURING MODE.</p> |
| <p>MEASURING MODE Select "Pressure" option.</p> <p>⚠ WARNING</p> <p>Changing the measuring mode affects the span (URV)! This situation can result in product overflow.</p> <ul style="list-style-type: none"> ▶ If the measuring mode is changed, the span setting (URV) must be verified in the "Calibration" → "Basic Setup" operating menu and, if necessary, reconfigured! |
| <p>GROUP SELECTION Select QUICK SETUP menu.</p> |
| <p>POS. ZERO ADJUST Due to orientation of the device, there may be a shift in the measured value. You correct the MEASURED VALUE via the POS. ZERO ADJUST parameter with the "Confirm" option, i. e. you assign the value 0.0 to the pressure present.</p> |
| <p>SET LRV Set the measuring range (enter 4 mA value). Specify a pressure value for the lower current value (4 mA value). A reference pressure does not have to be present at the device.</p> |

| On-site operation |
|--|
| <p>SET URV Set the measuring range (enter 20 mA value). The pressure for the upper current value (20 mA value) is present at device. With the "Confirm" option, you assign the upper current value to the pressure value present.</p> |
| <p>DAMPING TIME Enter damping time (time constant τ). The damping affects the speed at which all subsequent elements, such as the on-site display, measured value and current output react to a change in the pressure.</p> |

7.3.2 On-site operation – on-site display not connected

If no on-site display is connected, the following functions are possible by means of the three keys on the electronic insert or on the exterior of the device:

- Position adjustment (zero point correction)
- Setting lower range value and upper range value
- Device reset, → see also Page 21, Section 4.2.2 "Function of the operating elements", Table.
- The device is configured for the Pressure measuring mode as standard. You can switch measuring modes by means of the MEASURING MODE parameter.
- The operation must be unlocked. → See Page 27, Section 4.4 "Locking /unlocking operation".
- The pressure applied must be within the nominal pressure limits of the sensor. See information on the nameplate.

WARNING

Changing the measuring mode affects the span (URV)!

This situation can result in product overflow.

- ▶ If the measuring mode is changed, the span setting (URV) must be verified in the "Calibration" → "Basic Setup" operating menu and, if necessary, reconfigured!

| Carry out position adjustment. ¹⁾ | | Setting lower range value. | | Setting upper range value. | |
|---|----|--|----|--|----|
| Pressure is present at device. | | Desired pressure for lower range value is present at device. | | Desired pressure for upper range value is present at device. | |
| ↓ | | ↓ | | ↓ | |
| Press "E"-key for 3 s. | | Press "-"-key for 3 s. | | Press "+"-key for 3 s. | |
| ↓ | | ↓ | | ↓ | |
| Does the LED on the electronic insert light up briefly? | | Does the LED on the electronic insert light up briefly? | | Does the LED on the electronic insert light up briefly? | |
| Yes | No | Yes | No | Yes | No |
| ↓ | ↓ | ↓ | ↓ | ↓ | ↓ |

| Carry out position adjustment. ¹⁾ | | Setting lower range value. | | Setting upper range value. | |
|---|---|---|---|---|---|
| Applied pressure for position adjustment has been accepted. | Applied pressure for position adjustment has not been accepted. Observe the input limits. | Applied pressure for lower range value has been accepted. | Applied pressure for lower range value has not been accepted. Observe the input limits. | Applied pressure for upper range value has been accepted. | Applied pressure for upper range value has not been accepted. Observe the input limits. |

1) Observe "Warning" on Page 28.

7.4 Level measurement

Open container

- FMD77: the device is ready for calibration immediately after opening a shut-off valve (may or may not be present).
- PMD75: before calibrating the device, the impulse piping must be cleaned and filled with fluid.

Closed Container

- FMD77: the device is ready for calibration immediately after opening the shut-off valves (may or may not be present).
- FMD78: the device is ready for calibration immediately.
- PMD75: before calibrating the device, the impulse piping must be cleaned and filled with fluid.

Containers with superimposed steam

- FMD77: the device is ready for calibration immediately after opening the shut-off valves (may or may not be present).
- FMD78: the device is ready for calibration immediately.
- PMD75: before calibrating the device, the impulse piping must be cleaned and filled with fluid.

7.4.1 Quick Setup menu for Level measuring mode – on-site display

- Some parameters are only displayed if other parameters are appropriately configured (see the following table).
- The following parameters are set to the following values in the factory:
 - LEVEL SELECTION: Level Easy Pressure
 - CALIBRATION MODE: Wet
 - OUTPUT UNIT or LIN. MEASURAND: %
 - EMPTY CALIB.: 0.0
 - FULL CALIB.: 100.0
 - SET LRV (BASIC SETTINGS group): 0.0 (corresponds to 4 mA value)
 - SET URV (BASIC SETTINGS group): 100.0 (corresponds to 20 mA value).
- → For parameter description see Operating Instructions BA00274P.
- The quick setup is suitable for simple and quick commissioning. If you wish to make more complex settings, e.g. change the unit from "%" to "m", you will have to calibrate using the BASIC SETTINGS group.
- See also Page 22, Section 4.2.3 "Function of the operating elements" and Page 23, 4.3 "On-site operation via on-site display".

⚠ WARNING

Changing the measuring mode affects the span (URV)!

This situation can result in product overflow.

- ▶ If the measuring mode is changed, the span setting (URV) must be verified in the "Calibration" → "Basic Setup" operating menu and, if necessary, reconfigured!

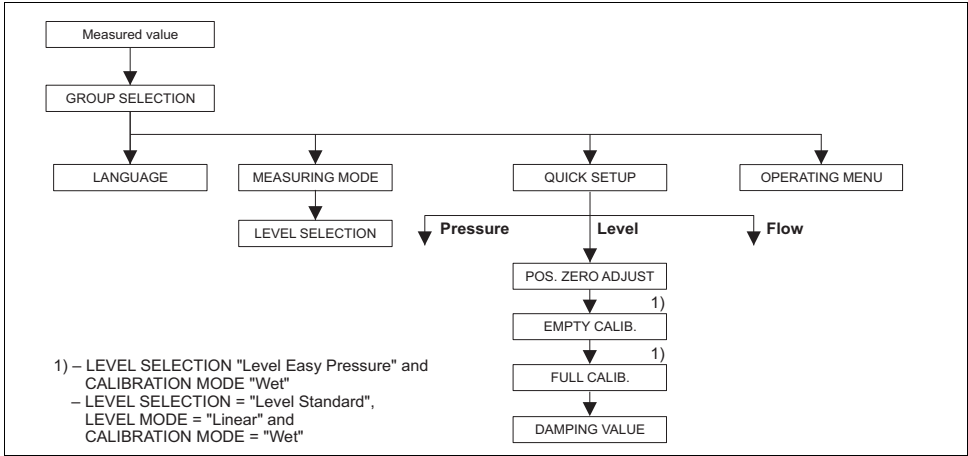

P01-xMx7xxxx-19-xx-xx-xx-047

Fig. 11: Quick Setup menu for the Level measuring mode

| |
|--|
| On-site operation |
| Measured value display On-site display: Switch from the measured value display to GROUP SELECTION with F. |
| GROUP SELECTION Select MEASURING MODE. |
| MEASURING MODE Select "Level" option. |
| ⚠ WARNING Changing the measuring mode affects the span (URV)! This situation can result in product overflow. ▶ If the measuring mode is changed, the span setting (URV) must be verified in the "Calibration" → "Basic Setup" operating menu and, if necessary, reconfigured! |
| LEVEL SELECTION Select level mode. |
| GROUP SELECTION Select QUICK SETUP menu. |
| POS. ZERO ADJUST Due to orientation of the device, there may be a shift in the measured value. You correct the MEASURED VALUE via the POS. ZERO ADJUST parameter with the "Confirm" option, i. e. you assign the value 0.0 to the pressure present. |

| On-site operation |
|---|
| <p>EMPTY CALIB. 1) Enter level for the lower calibration point. For this parameter, enter a level value which is assigned to the pressure present at the device.</p> |
| <p>FULL CALIB. 1) Enter level for the upper calibration point. For this parameter, enter a level value which is assigned to the pressure present at the device.</p> |

| On-site operation |
|---|
| <p>DAMPING TIME Enter damping time (time constant τ). The damping affects the speed at which all subsequent elements, such as the on-site display, measured value and current output react to a change in the pressure.</p> |
| <p>1) – LEVEL SELECTION "Level Easy Pressure" and CALIBRATION MODE "Wet" – LEVEL SELECTION "Level Standard", LEVEL MODE "Linear" and CALIBRATION MODE "Wet" (Menu path for CALIBRATION MODE: GROUP SELECTION → OPERATING MENU → SETTINGS → BASIC SETTINGS)</p> |

7.4.2 On-site operation – on-site display not connected

If no on-site display is connected, the following functions are possible by means of the three keys on the electronic insert or on the exterior of the device:

- Position adjustment (zero point correction)
- Set the lower and upper pressure value and assign to the lower and upper level value
- Device reset, → see also Page 21, section 4.2.2 "Function of the operating elements", Table.

- The device is configured for the Pressure measuring mode as standard. You can switch measuring modes by means of the MEASURING MODE parameter.

- The following parameters are set to the following values in the factory:

- LEVEL SELECTION: Level Easy Pressure
- CALIBRATION MODE: Wet
- OUTPUT UNIT or LIN. MEASURAND: %
- EMPTY CALIB.: 0.0
- FULL CALIB.: 100.0.
- SET LRV: 0.0 (corresponds to 4 mA value)
- SET URV: 100.0 (corresponds to 20 mA value)

These parameters can only be modified by means of the on-site display or remote operation such as FieldCare.

- The "-" and "+" keys only have a function in the following cases:

- LEVEL SELECTION "Level Easy Pressure", CALIBRATION MODE "Wet"
- LEVEL SELECTION "Level Standard", LEVEL MODE "Linear", CALIBRATION MODE "Wet"

The keys have no function in other settings.

- The operation must be unlocked. → See Page 27, Section 4.4 "Locking /unlocking operation".

- The pressure applied must be within the nominal pressure limits of the sensor. See information on the nameplate.
- LEVEL SELECTION, CALIBRATION MODE, LEVEL MODE, EMPTY CALIB., FULL CALIB, SET LRV and SET URV are parameter names used for on-site display or remote operation such as FieldCare, for instance.
- → For parameter description see Operating Instructions BA00274P.

⚠ WARNING

Changing the measuring mode affects the span (URV)!

This situation can result in product overflow.

- ▶ If the measuring mode is changed, the span setting (URV) must be verified in the "Calibration" → "Basic Setup" operating menu and, if necessary, reconfigured!

| Carry out position adjustment. ¹⁾ | | Setting lower pressure value. | | Setting upper pressure value. | |
|---|---|---|---|---|---|
| Pressure is present at device. | | Desired pressure for lower pressure value (EMPTY PRESSURE) is present at device. | | Desired pressure for upper pressure value (FULL PRESSURE) is present at device. | |
| ↓ | | ↓ | | ↓ | |
| Press "E"-key for 3 s. | | Press "-"-key for 3 s. | | Press "+"-key for 3 s. | |
| ↓ | | ↓ | | ↓ | |
| Does the LED on the electronic insert light up briefly? | | Does the LED on the electronic insert light up briefly? | | Does the LED on the electronic insert light up briefly? | |
| Yes | No | Yes | No | Yes | No |
| ↓ | ↓ | ↓ | ↓ | ↓ | ↓ |
| Applied pressure for position adjustment has been accepted. | Applied pressure for position adjustment has not been accepted. Observe the input limits. | The pressure present was saved as the lower pressure value (EMPTY PRESSURE) and assigned to the lower level value (EMPTY CALIB.). | The pressure present was not saved as the lower pressure value. Observe the input limits. | The pressure present was saved as the upper pressure value (FULL PRESSURE) and assigned to the upper level value (FULL CALIB.). | The pressure present was not saved as the upper pressure value. Observe the input limits. |

1) Observe "Warning" on Page 28.

7.5 Flow measurement

Before calibrating the Deltabar S, the impulse piping must be cleaned and filled with fluid.

7.5.1 Quick Setup menu for the Flow measurement – on-site display

See also Page 22, Section 4.2.3 "Function of the operating elements" and Page 23, 4.3 "On-site operation via on-site display".

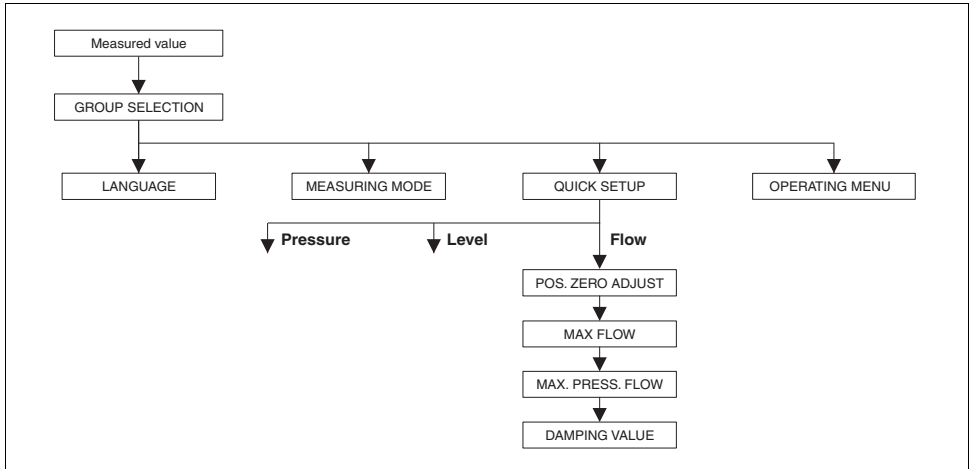

Fig. 12: Quick Setup menu for the Flow measuring mode

P01-xxxxxxx-19-xx-xx-xx-147

| |
|---|
| On-site operation |
| Measured value display On-site display: Switch from the measured value display to GROUP SELECTION with F. |
| GROUP SELECTION Select MEASURING MODE. |
| MEASURING MODE Select "Flow" option. <div style="background-color: orange; color: black; padding: 2px; display: inline-block; margin-top: 5px;"> ⚠ WARNING </div> <p>Changing the measuring mode affects the span (URV)! This situation can result in product overflow.</p> <ul style="list-style-type: none"> ▶ If the measuring mode is changed, the span setting (URV) must be verified in the "Calibration" → "Basic Setup" operating menu and, if necessary, reconfigured! |
| GROUP SELECTION Select QUICK SETUP menu. |
| POS. ZERO ADJUST Due to orientation of the device, there may be a shift in the measured value. You correct the MEASURED VALUE via the POS. ZERO ADJUST parameter with the "Confirm" option, i. e. you assign the value 0.0 to the pressure present. |

| |
|--|
| On-site operation |
| MAX. FLOW Enter maximum flow of primary device. (→ See also layout sheet of primary device). |
| MAX. PRESS FLOW Enter maximum pressure of primary device. (→ See also layout sheet of primary device). |
| DAMPING TIME Enter damping time (time constant τ). The damping affects the speed at which all subsequent elements, such as the on-site display, measured value and current output react to a change in the pressure. |

7.5.2 On-site operation – on-site display not connected

If no on-site display is connected, the following functions are possible by means of the three keys on the electronic insert or on the exterior of the device:

- Position adjustment (zero point correction)
- Set the maximum pressure value and assign it to the maximum flow value
- Device reset, → see also Page 21, section 4.2.2 "Function of the operating elements", Table.
- The device is configured for the Pressure measuring mode as standard. You can switch measuring modes by means of the MEASURING MODE parameter.
- The S- key does not have any function.
- The operation must be unlocked. → See Page 27, Section 4.4 "Locking /unlocking operation".
- The pressure applied must be within the nominal pressure limits of the sensor. See information on the nameplate.
- MAX. PRESS. FLOW, MAX. FLOW, SET LRV – Flow and LINEAR/SQROOT are parameter names used for on-site display or remote operation such as FieldCare, for instance.
- → For parameter description see Operating Instructions BA00274P.

⚠ WARNING

Changing the measuring mode affects the span (URV)!

This situation can result in product overflow.

- ▶ If the measuring mode is changed, the span setting (URV) must be verified in the "Calibration" → "Basic Setup" operating menu and, if necessary, reconfigured!

| Carry out position adjustment. ¹⁾ | |
|---|----|
| Pressure is present at device. | |
| ↓ | |
| Press "E"-key for 3 s. | |
| ↓ | |
| Does the LED on the electronic insert light up briefly? | |
| Yes | No |
| ↓ | ↓ |

| Setting maximum pressure value. | |
|---|----|
| Desired pressure for the maximum pressure value (MAX. FLOW) is present at device. | |
| ↓ | |
| Press "+"-key for 3 s. | |
| ↓ | |
| Does the LED on the electronic insert light up briefly? | |
| Yes | No |
| ↓ | ↓ |

| Carry out position adjustment. ¹⁾ | | Setting maximum pressure value. | |
|---|---|---|---|
| Applied pressure for position adjustment has been accepted. | Applied pressure for position adjustment has not been accepted. Observe the input limits. | The pressure present was saved as the maximum pressure value (MAX. PRESS FLOW) and assigned to the maximum flow value (MAX. FLOW.). | The pressure present was not saved as the maximum pressure value. Observe the input limits. |

1) Observe "Warning" on Page 28.



71281258

www.addresses.endress.com

TRANSCAT[®]
Trust in every measure

Visit us at Transcat.com 

sales@transcat.com 1.800.828.1470

Endress + Hauser 
People for Process Automation