

MEMORY HiLOGGER 8423

Data Logger 

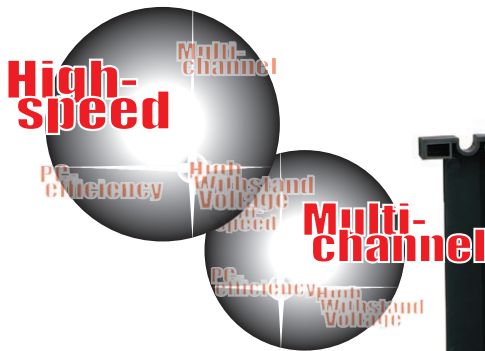

Fast 10-ms Sampling Up to 600 Channels Data Logging

MEMORY HiLOGGER Model 8423 is a data acquisition system capable of measuring and recording multiple channels at high speed. Acquired data can be easily analyzed on a personal computer. This model is ideal for acquiring data for evaluation and testing at development sites. If your evaluation needs require faster data sampling than was available with former HIOKI MEMORY HiLOGGERS, or if you just need more measurement channels, this model has the capabilities you want.



ISO 9001
JMI-0216



ISO14001
JQA-E-90091



www.hioki.com

HIOKI company overview, new products, environmental considerations and other information are available on our website.

Who needs 10 ms high-speed sampling?

High-Speed

Multi-channel

PC efficiency

High Withstand Voltage

- Answer -

To acquire data when converting automobile electronics for electric or hybrid vehicles

- Fastest measurement interval (sampling interval) is 10 ms
- Acquires up to 600 channels of data with 10 ms sampling interval
- Insulation withstand voltage between the measurement channels in each module is 200 V (Model 8948)

In the development of electric and hybrid automobiles, the need to capture sudden swings in various loads requires a measurement instrument with multi-channel high-speed sampling capability. For this purpose, HIOKI has developed a very economical logger that can measure with

10-ms sampling interval on all channels. Also included is a dual-sampling function that can measure at two different sampling rates simultaneously. This new model can follow waveforms that former 100-ms-sampling instruments could not.

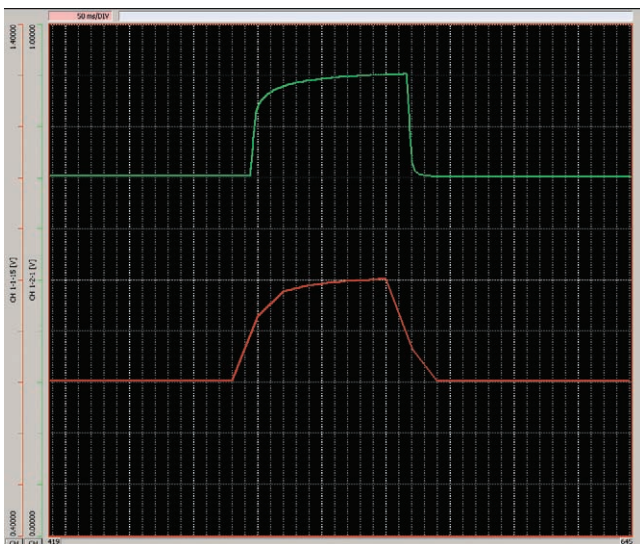

Sudden-load-change testing of a fuel cell employs dual sampling to measure with 10-ms (upper trace) and 100-ms sampling (lower trace). (Timebase: 50 ms/div).

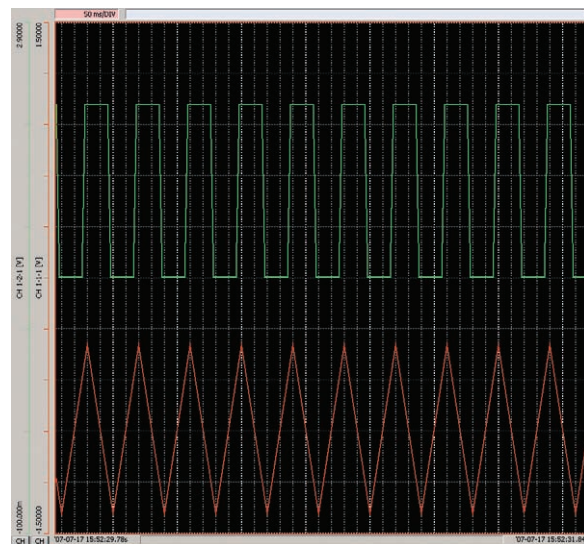

A 5-Hz pulse waveform is measured using dual sampling: 10-ms (upper trace) and 100-ms sampling (lower trace) (Timebase: 50 ms/div).

Who needs 120 or 600 channels?



High-speed
Multi-channel
PC efficiency
High Withstand Voltage

- Answer -

To acquire multi-point temperature distribution data To measure the voltage of each cell in a stack

- Expandable up to 120 channels with a single instrument
- Up to five instruments can be connected for measuring up to 600 channels
- Isolated to sustain up to 600 V between modules and earth

Temperature distribution is measured to evaluate air conditioning systems during development. A system to acquire data on up to 600 channels can be constructed with merely a LAN or USB connection, providing highly detailed temperature distribution measurements.

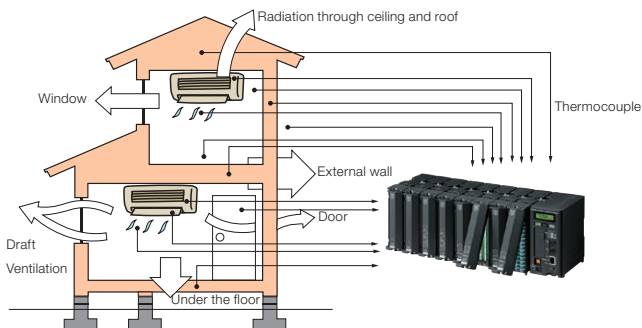

With all channels isolated and a 600V AC/DC maximum rated voltage to earth, even when the common mode voltage increases as is common with layered batteries, the voltage of each individual battery cell can be safely measured.

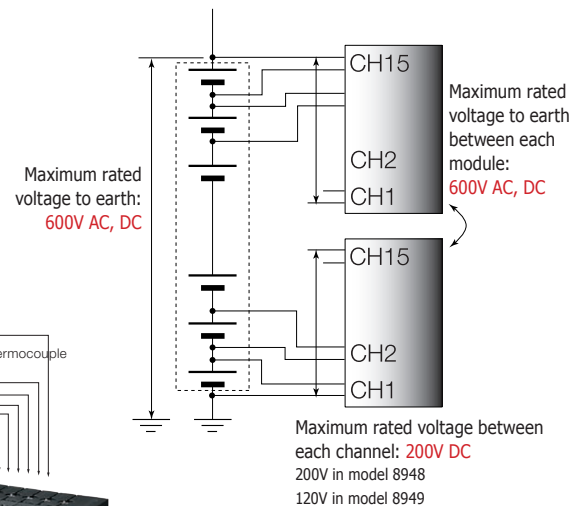

To evaluate heat radiation characteristics and copy machine operation, temperatures at many points inside the chassis and analog voltages from the control board are simultaneously measured.

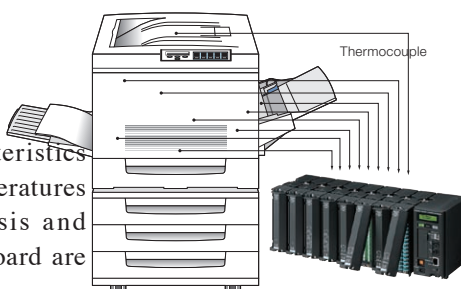

“Simplicity” as a Design Concept



Installation

Because the terminal blocks are designed to be removable, thermocouples can be connected to the terminal block in hand before connecting the block to a HiLOGGER input module, with just one touch.



Easily add input modules: just align and mate the connectors on the left side of the instrument assembly, and turn the metal clasp. For added strength, attach the supplied mounting bracket on the rear, or attach a standard DIN rail to the rear for tray or rack mounting.

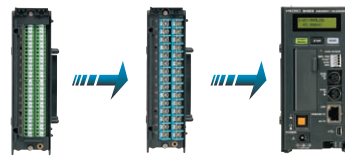

Each measurement module daisy-chains onto the stacking configuration.

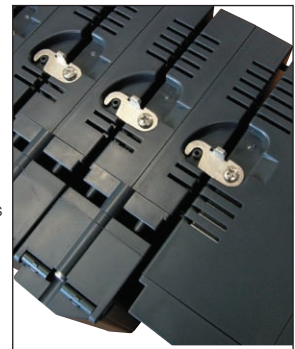

Mounting with a standard DIN rail is supported.



Measurement configuration settings

Logger configuration settings are made from a computer running the supplied application program. Settings can be easily made using familiar PC operations. To keep the process simple, the user is guided sequentially through the setting items.

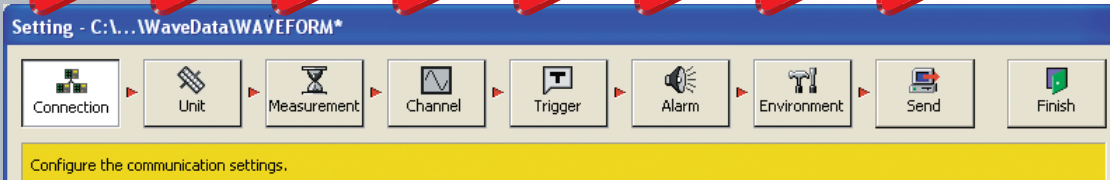
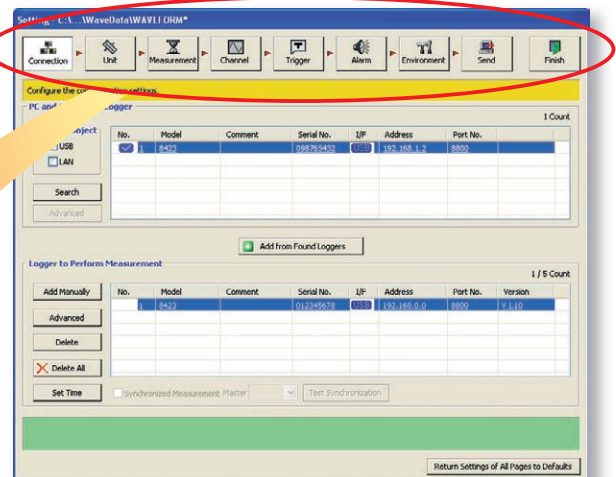



View your data even while measuring!

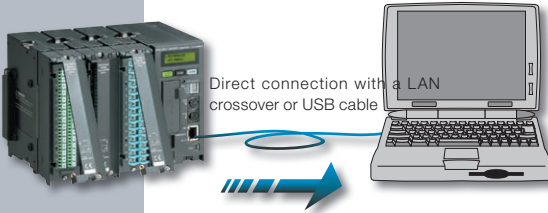
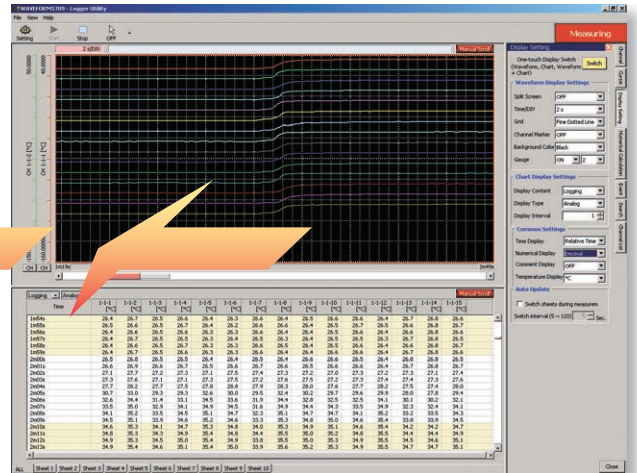
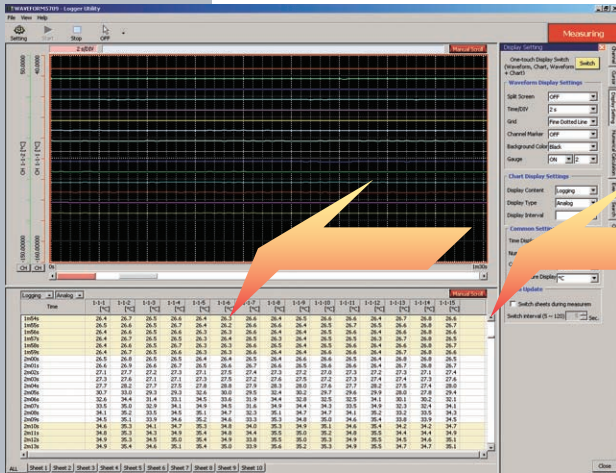

Data is recorded on the computer in real time using the supplied Logger Utility PC application program. View a trend graph in a window and scroll back to view earlier waveform data, even while recording.



Post-measurement analysis (New Double-Thumb function*)

The newly developed Double-Thumb function simplifies analysis. Two windows are displayed side by side, each with a scroll bar at the bottom containing a thumb (scroll box) that corresponds to the length and position of that window's displayed segment within the overall waveform. The thumbs in the scroll bars of the waveform display windows show you the position of the segments at a glance, greatly simplifying scrolling operations.

* Patent pending

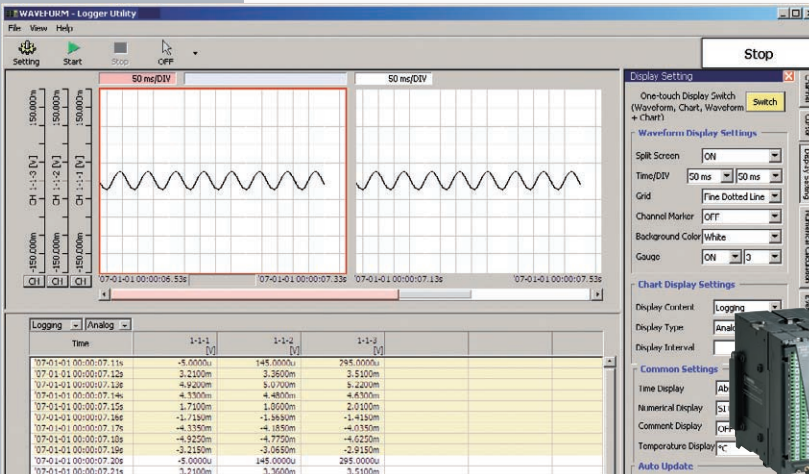
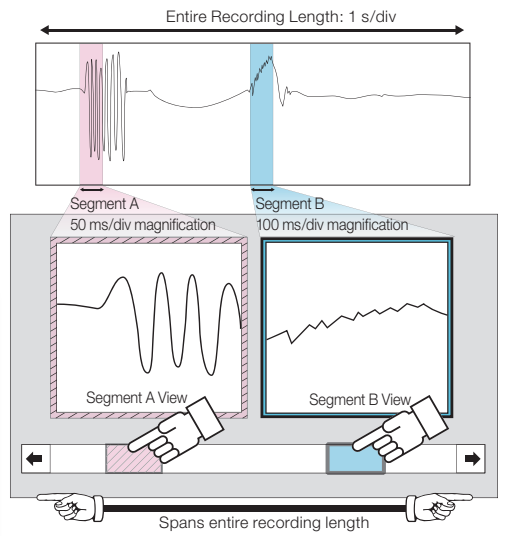

More Functional Details

Universal isolated inputs for temperature, voltage and pulses

*1 Pt (platinum resistance temperature sensor) and humidity measurements require UNIVERSAL UNIT 8949
 *2 Requires optional HUMIDITY SENSOR 9701

With the modular input design, you can select the input modules appropriate for your measurement application. Select from voltage and temperature (thermocouple or Pt input*¹) and humidity.*¹ *² Also, Digital Pulse Module 8996 provides 15 input channels for totalization/rotation counts and Hi/Lo logic measurements. In addition to inter-channel input isolation, the PC connection interface is completely isolated from the measurement terminals, minimizing shock hazards and interference even when measuring thermocouple and voltage inputs at the same time.

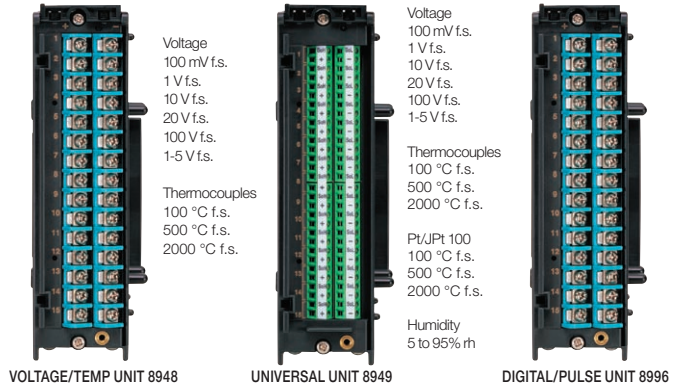

Real-time saving to CF Card

Each measurement can be saved to a CF Card in real time. Continuous long-term recording can be performed with high capacity CF Cards up to 1 GB. Data can be viewed on a PC using the supplied Logger Utility program.

Enhanced data protection from power failures

This exclusive technology has been developed to preserve data as reliably as possible in the event of a power failure, by incorporating memory card technology with the know-how built into the MEMORY HiLOGGER 8420-50, 8421-50 and 8422-50 series. The 8423 emphasizes the existing HiLOGGER functions and maintains internal supply voltage with a large internal capacitor until all data has been saved to the card, resulting in greater reliability when acquiring large amounts of data.



A CF Card slot is included as a standard feature, supporting HIOKI CF Cards up to 1 GB (operation with non-HIOKI-brand cards is not guaranteed). Using a CF Card, instrument settings can be easily copied from one 8423 to another.

Recording Times with a 128 MB Card (Voltage, Temperature and Humidity Measurements, but no Pulse Channels)

Recording intervals	128MB (using 1 channel)	128MB (using 15 channels)	128MB (using 30 channels)	128MB (using 60 channels)	128MB (using 120 channels)
10ms	7 d 18 h 24 min	12 h 25 min	6 h 12 min	3 h 06 min	1 h 33 min
20ms	15 d 12 h 49 min	1 d 00 h 51 min	12 h 25 min	6 h 12 min	3 h 06 min
50ms	38 d 20 h 04 min	2 d 14 h 08 min	1 d 07 h 04 min	15 h 32 min	7 h 46 min
100ms	77 d 16 h 08 min	5 d 04 h 16 min	2 d 14 h 08 min	1 d 07 h 04 min	15 h 32 min
200ms	155 d 08 h 16 min	10 d 08 h 33 min	5 d 04 h 16 min	2 d 14 h 08 min	1 d 07 h 04 min
500ms	- abbreviated -	25 d 21 h 22 min	12 d 22 h 41 min	6 d 11 h 20 min	3 d 05 h 40 min
1s	- abbreviated -	51 d 18 h 45 min	25 d 21 h 22 min	12 d 22 h 41 min	6 d 11 h 20 min
10s	- abbreviated -	- abbreviated -	258 d 21 h 47 min	129 d 10 h 53 min	64 d 17 h 26 min
1min	- abbreviated -	- abbreviated -	- abbreviated -	- abbreviated -	- abbreviated -
10min	- abbreviated -	- abbreviated -	- abbreviated -	- abbreviated -	- abbreviated -
1hour	- abbreviated -	- abbreviated -	- abbreviated -	- abbreviated -	- abbreviated -

Note: Actual CF data capacity is less than total CF storage capacity, and waveform file headers are not included in these calculated values, so we recommend using 90% of these values for estimation purposes.

Note: Periods longer than 365 days are abbreviated.

Recording Times with a 128 MB Card (Pulse Channels use only)

Recording intervals	128MB (using 1 channel)	128MB (using 15 channels)	128MB (using 30 channels)	128MB (using 60 channels)	128MB (using 120 channels)
10ms	3 d 21 h 12 min	6 h 12 min	3 h 06 min	1 h 33 min	46 min
20ms	7 d 18 h 24 min	12 h 25 min	6 h 12 min	3 h 06 min	1 h 33 min
50ms	19 d 10 h 02 min	1 d 07 h 04 min	15 h 32 min	7 h 46 min	3 h 53 min
100ms	38 d 20 h 04 min	2 d 14 h 08 min	1 d 07 h 04 min	15 h 32 min	7 h 46 min
200ms	77 d 16 h 08 min	5 d 04 h 16 min	2 d 14 h 08 min	1 d 07 h 04 min	15 h 32 min
500ms	194 d 04 h 20 min	12 d 22 h 41 min	6 d 11 h 20 min	3 d 05 h 40 min	1 d 14 h 50 min
1s	- abbreviated -	25 d 21 h 22 min	12 d 22 h 41 min	6 d 11 h 20 min	3 d 05 h 40 min
10s	- abbreviated -	258 d 21 h 47 min	129 d 10 h 53 min	64 d 17 h 26 min	32 d 08 h 43 min
1min	- abbreviated -	- abbreviated -	- abbreviated -	- abbreviated -	194 d 04 h 20 min
10min	- abbreviated -	- abbreviated -	- abbreviated -	- abbreviated -	- abbreviated -
1hour	- abbreviated -	- abbreviated -	- abbreviated -	- abbreviated -	- abbreviated -

Note: Actual CF data capacity is less than total CF storage capacity, and waveform file headers are not included in these calculated values, so we recommend using 90% of these values for estimation purposes.

Note: Periods longer than 365 days are abbreviated.

Trigger function

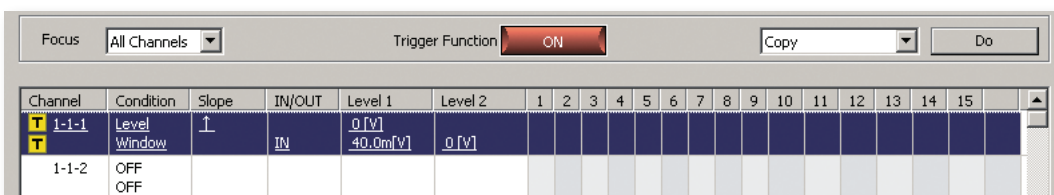

Level, Window and Logic trigger functions are provided. You can have one criterion start recording and another stop recording.

Dual Sampling

Two different measurement intervals can be specified at the same time (one interval setting per input module). Using dual sampling, the appropriate measurement interval can be set for each type of object to be measured, optimizing use of internal memory and CF Card capacity.

Time	1-1-2 [V]	1-1-3 [V]	1-2-1 [°C]
'07-05-23 14:34:22.2s	0.7370	0.9864	26.10
'07-05-23 14:34:22.3s	0.6488	0.8735	-----
'07-05-23 14:34:22.4s	0.4979	0.6766	-----
'07-05-23 14:34:22.5s	0.2983	0.4132	-----
'07-05-23 14:34:22.6s	0.0698	0.1098	-----
'07-05-23 14:34:22.7s	-0.1642	-0.2024	-----
'07-05-23 14:34:22.8s	-0.3824	-0.4953	-----
'07-05-23 14:34:22.9s	-0.5618	-0.7379	-----
'07-05-23 14:34:23.0s	-0.6848	-0.9065	-----
'07-05-23 14:34:23.1s	-0.7414	-0.9868	-----
'07-05-23 14:34:23.2s	-0.7252	-0.9705	26.07
'07-05-23 14:34:23.3s	0.6360	0.8392	-----

Fast sampling
100ms

Slow sampling
100ms

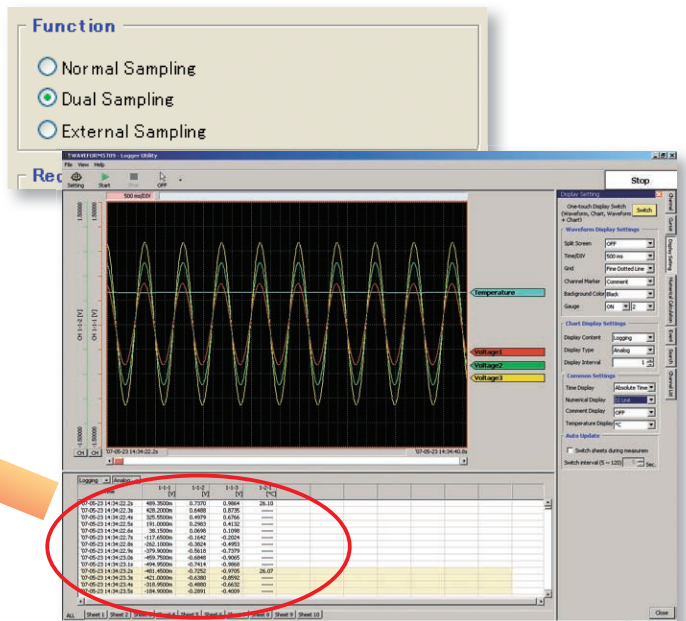

Enhanced PC Interface



USB Port Included

A USB 2.0 (mini-B connector) port is included as standard. The 8423 instrument and a PC can be connected by a USB cable (A to mini-B) for transferring 8423 operating settings and data.



LAN Terminal Included

A 100Base-TX LAN terminal is included as standard. The 8423 instrument and a PC can be connected by a LAN cable for transferring 8423 operating settings and data.

External Control Inputs Included



Input terminals are provided for external triggering, external start and stop and external sampling. External signals can be applied as a trigger source and to start and stop measurements, so data can be acquired by controlled sampling timing.

Note: External triggering and external sampling share a common terminal, so only one of these control input types can be used at a time.

More Functional Details

All-Channel Synchronous Measurement Capability

When measuring up to 120 channels on combined modules, all input channels are sampled synchronously. When multiple **8423s** are connected via LAN or USB for measuring up to 600 channels, the sampling of each instrument in the system can be synchronized using optional Connection Cable Model **9683**. As well as PC-based data collection, measurement start and stop can be controlled by the [START/MARK] and [STOP] keys on a master **8423**.

*Note: Any **8423** may be designated as the master. Only the initial acquisition criteria setting needs to be performed on a PC via USB or LAN.*

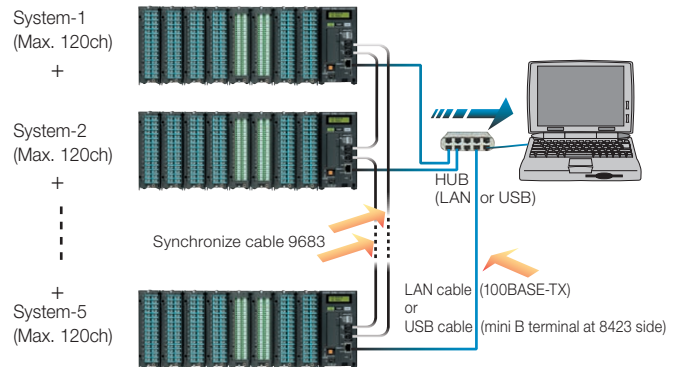

Enhanced Noise Immunity

A delta-sigma type A/D converter has been incorporated in the measurement circuitry. The effects of previously problematic inverter switching noise and 50/60 Hz hum noise have been greatly reduced by the digital filtering function using the oversampling principle inherent in this type of device.

Note: Optimum noise suppression is obtained with recording intervals of two seconds or longer

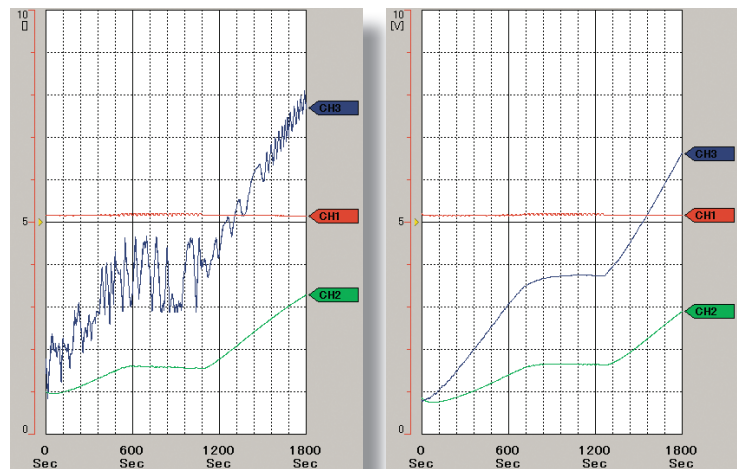

Product Specifications



8423 Hardware Specifications <small>(accuracy is specified @23 ±5°C/73 ±9°F, 30 to 80 % rh, from 30 minutes after power on, accuracy guaranteed for one year, product guaranteed for one year)</small>	
Display	LCD, 16 characters × 2 lines, 5 × 8 dots / characters
Memory capacity	Total 16 M-word (about 16.77 million data points: 32 mega-bytes)
External control connectors	Push-button type terminal block : External trigger/ External sampling input (exclusive OR), External start input, External stop input External sampling : rise-up, or fall-down (selectable) Rise-up : Low (0 to 1.0 V) to High (2.5 to 5.0 V) Fall-down : High (2.5 to 5.0 V) to Low (0 to 1.0 V), or terminal short Input voltage range : -5 to 10 V DC, Filter ON/OFF possible Pulse width response : Over 1 ms at "H", over 2 μs at "L" (at filter OFF), Over 2.5 ms at "H", over 4 ms at "L" (at filter ON) Maximum external sampling period : 10 ms (at digital filter OFF), 20 ms (at digital filter OFF, and synchronous measurement), 5 s (at digital filter ON, and combined with humidity measurement) Synchronous sampling : Five-units maximum for synchronous connection, Function : Connect via the connection cable model 9683 for synchronous sampling
Clock	Auto calendar, leap year auto distinguish, Precision : ±0.2s/ day at power ON, ±3s/ day at power OFF (at 23 °C/ 73°F)
Accuracy of timebase	±0.2s/ day on measurement (at 23 °C/ 73°F)
Recording intervals	10ms, 20ms, 50ms, 100ms, 200ms, 500ms, 1s, 2s, 5s, 10s, 20s, 30s, 1min, 2min, 5min, 10min, 20min, 30min, 1hr (5s to 1hr when combined with humidity measurement)
Recording length	Set to arbitrary length or continuous; Data storage : last 16-mega datas in internal memory (for one channel recording, for n channels, 16 M-datas / n data)
Recording mode	Continue, Repeat, Timer measurement
Number of data	For analog "n" channels, (16-mega datas / n) datas
Durability of battery	Backup battery for clock and setting conditions: battery life of at least 10 years, For measurement data: none (at 23 °C/ 73°F)
No. of connectable units	Maximum 8 units (total 120 channels)
Environmental conditions	Operating temperature and humidity : 0 (32°F) to 40°C (104°F), 30 to 80% rh, Storage temperature and humidity : -10 (14°F) to 50°C (122°F), 80% rh or less, (non-condensating)
Conforming standards	Safety : EN61010, EMC : EN61326, EN61000-3-2, EN61000-3-3
Power supply	(1) Using the AC ADAPTER 9418-15 , 100 to 240 VAC, 50/60 Hz (2) 12 V Battery (voltage may range from -20% to +30%, Please contact HIOKI for connection cord).
Power consumption	20 VA (when connected with 8 units)
Dimensions & Mass	Approx. 67 mm (2.64 in) W × 133 mm (5.24 in) H × 125 mm (4.92 in) D, 600 g (21.2 oz)
Accessories	Operating Manual x1, Quick Start Manual x1, AC ADAPTER 9418-15 x1, USB cable x1, Connection Plate x1, CD-R (data collection software "Logger Utility") x1, Connector cover x1, Ferrite clamp x1

PC Interface	
Data storage media	CF card slot × 1, HIOKI 9726 (128MB), 9727 (256MB), 9728 (512MB), 9729 (1GB), MS-DOS format
Interface	LAN : supports 100Base-TX, DHCP, DNS USB : Ver 2.0, mini-B receptacle
PC control	Data acquisition and measurement criteria settings are controlled by the PC data acquisition program; data acquired to internal memory and CF Cards is downloaded via FTP server function; simple operations (measurement start/stop and data acquisition to internal memory) are available via HTTP server function

Function Specifications	
Major Functions	Control the input units, or output units, Communication to the PC, Data storage to the CF card
Measurement parameters	Depending on the connected measurement unit: Temperature (thermocouple, Pt), voltage, humidity (used optional sensor), totalized pulses (addition, instantly), rotation count, digital signal
Real time save	Measurement data are saved as binary data to the CF Card in real time, and can be saved to separate files at preset times, selectable as full files or an endless loop with automatic deletion of oldest data.
Dual sampling	Two (high-speed and low-speed) recording intervals can be specified for every input module from the following: 10, 20, 50, 100, 200 and 500 ms; 1, 2, 5, 10, 20 and 30 s; 1, 2, 5, 10, 20 and 30 min; and 1 hr (the low-speed setting divided by the high-speed setting must be an integer less than 1,000)
Marking	Event mark input : Press [Start / Stop] key at measurement
Trigger function	Mode : Single / Repeat, Timing : Start / Stop / Start & Stop, Pre-Trigger : records period before trigger, can be set for real-time saving
Trigger source	Analog input : Maximum 120 channels, depend on number of the input unit. Pulse totalizer inputs : Maximum 120 channels, depend on number of the input unit. Logic inputs : Maximum 120 channels, depend on number of the input unit. External trigger : Rise up or fall down of the external input signal (selectable) Logical AND or OR for each trigger source, Trigger condition setttable for each channels
Trigger type	Level : Triggers when rising or falling through preset level Window : Triggers when entering or exiting range defined by preset upper and lower limit values Trigger level resolution : 0.1 % f.s. Logic : 1, 0, × Pattern trigger
External trigger signal	Rise up : Low level (0 to 1.0 V) to High level (2.5 V to 5.0 V) Fall down : High level (2.5 V to 5.0 V) to Low level (0 to 1.0 V), or terminal short Input voltage range : -5 V to 10 V, Filter ON/OFF possible, Pulse width response : more than 1 ms (High period), more than 2 μs (Low period) at filter OFF, more than 2.5 ms (High period), more than 4 ms (Low period) at filter ON
Alarm output	Alarm Module 8997 can be connected along with various measurement modules (although it cannot be connected alone)
Alarm type	Level : Triggers when rising or falling through preset level Window : Triggers when entering or exiting range defined by preset upper and lower limit values Logic pattern : agreement (or disagreement) in the specified pattern Output latch settings : latch / no latch
Start backup	Possible

■ Specification

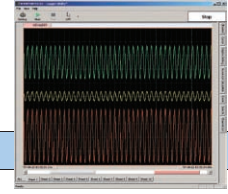

Logger Utility (bundled application software)	
Media/Operating environment	One CD-R, CPU : Pentium 3 (500 MHz or more), at least 512 MB of memory, Ethernet, or USB terminal OS : Windows 2000 (SP4 or later), Windows XP (SP2 or later), Vista (32-bits type) (This software is compatible only to the MEMORY HiLOGGER 8423, 8430-20/-21)
Real-time data acquisition	Measurements on multiple loggers connected by LAN or USB can be controlled to sequentially acquire, display and save waveform data (for recording up to 10 million samples) Maximum number of controllable instruments : 5; Data acquisition systems : 1 (acquisition from multiple systems is possible by running multiple instances of the application program) Display : Waveforms (multiple time axes can be displayed); Numerical values (logging) and alarm status can be displayed at the same time; Numerical value monitoring is possible in a separate window; measuring while waveform scrolling is possible Data saving destination : Real-time data acquisition file (LUW format); Event marks : can be applied while recording
Data acquisition settings	Settings : Data acquisition settings for the HiLOGGER; Saving : The setting for multiple HiLOGGERS can be saved together in one file (LUS format); Instrument configuration settings can be sent and received
Waveform display	Processed data file : Real-time data acquisition file (LUW format), Measurement data file (MEM format), Display format : Simultaneously waveform and numerical value, (time-axis divided display possible), Maximum number of channels : 600 channels (measurement data, used with the 8423) + 60 channels (waveform processing data) Others : Waveform display on sheet for each channel, scroll, record event mark, cursor, hard copy, numerical value display
Data conversion	Target data : Real-time data acquisition file (LUW format), Measurement data file (MEM format), Waveform processing data, Converted sections: All data, designation section, Format : CSV format (separate by comma, space, tab), transfer to EXCEL sheet, arbitrary data thinning
Parameter calculations	Target data : Real-time data acquisition file (LUW format), Measurement data file (MEM format), data acquired in real time, Waveform processing data Calculation items : average, peak, maximum and minimum values, timing of maximum and minimum values, ON time, OFF time, count the number of ON time and OFF time, standard deviation, integration, area values
Search function	Target data : Real-time data acquisition file (LUW format), Measurement data file (MEM format), Waveform processing data, Search mode : event mark, time and date, maximum position, minimum position, maximum pole, minimum pole, alarm position, level, window, the amount of change
Print function	Supported printer : printer compatible with the OS, Target data : Real-time data acquisition file (LUW format), Measurement data file (MEM format), Waveform processing data, Print format : waveform image, report format, list print (channel settings, event, cursor value), Print area : the entire area, area between cursors A and B, Print preview : supported
Waveform processing	Processing items : Four arithmetic operations, Number of processing channels : 60 channels (Software Version 1.20 or later)



VOLTAGE/TEMP UNIT 8948 (accuracy specified @23 ±5°C/73 ±9°F, 30 to 80% rh., from 30 minutes after power on and after zero point adjustment, accuracy and product guaranteed for one year)																																																																									
Input	Measurement parameters : Voltage, Thermocouples (K, E, J, T, N, W, R, S, B) Terminal : M3 (mm) screw terminals (2 terminals/1ch), terminal block removable, supplied terminal block cover Number of channels : 15 channels isolated from each other and chassis, (voltage or thermocouple selectable for each channels) Input impedance : 1MΩ (850kΩ when open-circuit polling is enabled)																																																																								
Measurement parameters	<table border="1"> <thead> <tr> <th></th> <th>Setting Range</th> <th>Measurement range</th> <th>Resolution</th> <th>Accuracy</th> </tr> </thead> <tbody> <tr> <td rowspan="6">Voltage</td> <td>100mV f.s.</td> <td>-150mV to +150mV</td> <td>5μV</td> <td rowspan="6">±0.1% f.s.</td> </tr> <tr> <td>1V f.s.</td> <td>-1.5V to +1.5V</td> <td>50μV</td> </tr> <tr> <td>10V f.s.</td> <td>-15V to +15V</td> <td>500μV</td> </tr> <tr> <td>20V f.s.</td> <td>-30V to +30V</td> <td>1mV</td> </tr> <tr> <td>100V f.s.</td> <td>-100V to +100V</td> <td>5mV</td> </tr> <tr> <td>1-5V f.s.</td> <td>1V to 5V</td> <td>500μV</td> </tr> <tr> <td rowspan="15">Thermocouples</td> <td>K 100°C f.s.</td> <td>-100°C to 100°C</td> <td>0.01°C</td> <td rowspan="15">±0.05% f.s. ±1°C</td> </tr> <tr> <td>K 500°C f.s.</td> <td>-200°C to 500°C</td> <td>0.05°C</td> </tr> <tr> <td>K 2000°C f.s.</td> <td>-200°C to 1350°C</td> <td>0.1°C</td> </tr> <tr> <td>E 100°C f.s.</td> <td>-100°C to 100°C</td> <td>0.01°C</td> </tr> <tr> <td>E 500°C f.s.</td> <td>-200°C to 500°C</td> <td>0.05°C</td> </tr> <tr> <td>E 2000°C f.s.</td> <td>-200°C to 1000°C</td> <td>0.1°C</td> </tr> <tr> <td>J 100°C f.s.</td> <td>-100°C to 100°C</td> <td>0.01°C</td> </tr> <tr> <td>J 500°C f.s.</td> <td>-200°C to 500°C</td> <td>0.05°C</td> </tr> <tr> <td>J 2000°C f.s.</td> <td>-200°C to 1200°C</td> <td>0.1°C</td> </tr> <tr> <td>T 100°C f.s.</td> <td>-100°C to 100°C</td> <td>0.01°C</td> </tr> <tr> <td>T 500°C f.s.</td> <td>-200°C to 400°C</td> <td>0.05°C</td> </tr> <tr> <td>T 2000°C f.s.</td> <td>-200°C to 400°C</td> <td>0.1°C</td> </tr> <tr> <td>N 100°C f.s.</td> <td>-100°C to 100°C</td> <td>0.01°C</td> </tr> <tr> <td>N 500°C f.s.</td> <td>-200°C to 500°C</td> <td>0.05°C</td> </tr> <tr> <td>N 2000°C f.s.</td> <td>-200°C to 1300°C</td> <td>0.1°C</td> </tr> </tbody> </table>		Setting Range	Measurement range	Resolution	Accuracy	Voltage	100mV f.s.	-150mV to +150mV	5μV	±0.1% f.s.	1V f.s.	-1.5V to +1.5V	50μV	10V f.s.	-15V to +15V	500μV	20V f.s.	-30V to +30V	1mV	100V f.s.	-100V to +100V	5mV	1-5V f.s.	1V to 5V	500μV	Thermocouples	K 100°C f.s.	-100°C to 100°C	0.01°C	±0.05% f.s. ±1°C	K 500°C f.s.	-200°C to 500°C	0.05°C	K 2000°C f.s.	-200°C to 1350°C	0.1°C	E 100°C f.s.	-100°C to 100°C	0.01°C	E 500°C f.s.	-200°C to 500°C	0.05°C	E 2000°C f.s.	-200°C to 1000°C	0.1°C	J 100°C f.s.	-100°C to 100°C	0.01°C	J 500°C f.s.	-200°C to 500°C	0.05°C	J 2000°C f.s.	-200°C to 1200°C	0.1°C	T 100°C f.s.	-100°C to 100°C	0.01°C	T 500°C f.s.	-200°C to 400°C	0.05°C	T 2000°C f.s.	-200°C to 400°C	0.1°C	N 100°C f.s.	-100°C to 100°C	0.01°C	N 500°C f.s.	-200°C to 500°C	0.05°C	N 2000°C f.s.	-200°C to 1300°C	0.1°C
		Setting Range	Measurement range	Resolution	Accuracy																																																																				
Voltage	100mV f.s.	-150mV to +150mV	5μV	±0.1% f.s.																																																																					
	1V f.s.	-1.5V to +1.5V	50μV																																																																						
	10V f.s.	-15V to +15V	500μV																																																																						
	20V f.s.	-30V to +30V	1mV																																																																						
	100V f.s.	-100V to +100V	5mV																																																																						
	1-5V f.s.	1V to 5V	500μV																																																																						
Thermocouples	K 100°C f.s.	-100°C to 100°C	0.01°C	±0.05% f.s. ±1°C																																																																					
	K 500°C f.s.	-200°C to 500°C	0.05°C																																																																						
	K 2000°C f.s.	-200°C to 1350°C	0.1°C																																																																						
	E 100°C f.s.	-100°C to 100°C	0.01°C																																																																						
	E 500°C f.s.	-200°C to 500°C	0.05°C																																																																						
	E 2000°C f.s.	-200°C to 1000°C	0.1°C																																																																						
	J 100°C f.s.	-100°C to 100°C	0.01°C																																																																						
	J 500°C f.s.	-200°C to 500°C	0.05°C																																																																						
	J 2000°C f.s.	-200°C to 1200°C	0.1°C																																																																						
	T 100°C f.s.	-100°C to 100°C	0.01°C																																																																						
	T 500°C f.s.	-200°C to 400°C	0.05°C																																																																						
	T 2000°C f.s.	-200°C to 400°C	0.1°C																																																																						
	N 100°C f.s.	-100°C to 100°C	0.01°C																																																																						
	N 500°C f.s.	-200°C to 500°C	0.05°C																																																																						
	N 2000°C f.s.	-200°C to 1300°C	0.1°C																																																																						
	<table border="1"> <thead> <tr> <th></th> <th>Setting Range</th> <th>Measurement range</th> <th>Resolution</th> <th>Accuracy</th> </tr> </thead> <tbody> <tr> <td rowspan="8">Thermocouples</td> <td>R 100°C f.s.</td> <td>0°C to 100°C</td> <td>0.01°C</td> <td rowspan="8">±0.05% f.s. ±3.5°C (0°C to less than 400°C) (Temperatures less than 400°C measured by B thermocouples are not guaranteed for accuracy)</td> </tr> <tr> <td>R 500°C f.s.</td> <td>0°C to 500°C</td> <td>0.05°C</td> </tr> <tr> <td>R 2000°C f.s.</td> <td>0°C to 1700°C</td> <td>0.1°C</td> </tr> <tr> <td>S 100°C f.s.</td> <td>0°C to 100°C</td> <td>0.01°C</td> </tr> <tr> <td>S 500°C f.s.</td> <td>0°C to 500°C</td> <td>0.05°C</td> </tr> <tr> <td>S 2000°C f.s.</td> <td>0°C to 1700°C</td> <td>0.1°C</td> </tr> <tr> <td>B 2000°C f.s.</td> <td>0°C to 1800°C</td> <td>0.1°C</td> </tr> <tr> <td>W : WreS-26</td> <td></td> <td></td> <td></td> </tr> <tr> <td>W 100°C f.s.</td> <td>0°C to 100°C</td> <td>0.01°C</td> <td rowspan="3">±0.05% f.s. ±2°C (400°C and above)</td> </tr> <tr> <td>W 500°C f.s.</td> <td>0°C to 500°C</td> <td>0.05°C</td> </tr> <tr> <td>W 2000°C f.s.</td> <td>0°C to 2000°C</td> <td>0.1°C</td> </tr> </tbody> </table>		Setting Range	Measurement range	Resolution	Accuracy	Thermocouples	R 100°C f.s.	0°C to 100°C	0.01°C	±0.05% f.s. ±3.5°C (0°C to less than 400°C) (Temperatures less than 400°C measured by B thermocouples are not guaranteed for accuracy)	R 500°C f.s.	0°C to 500°C	0.05°C	R 2000°C f.s.	0°C to 1700°C	0.1°C	S 100°C f.s.	0°C to 100°C	0.01°C	S 500°C f.s.	0°C to 500°C	0.05°C	S 2000°C f.s.	0°C to 1700°C	0.1°C	B 2000°C f.s.	0°C to 1800°C	0.1°C	W : WreS-26				W 100°C f.s.	0°C to 100°C	0.01°C	±0.05% f.s. ±2°C (400°C and above)	W 500°C f.s.	0°C to 500°C	0.05°C	W 2000°C f.s.	0°C to 2000°C	0.1°C																														
	Setting Range	Measurement range	Resolution	Accuracy																																																																					
Thermocouples	R 100°C f.s.	0°C to 100°C	0.01°C	±0.05% f.s. ±3.5°C (0°C to less than 400°C) (Temperatures less than 400°C measured by B thermocouples are not guaranteed for accuracy)																																																																					
	R 500°C f.s.	0°C to 500°C	0.05°C																																																																						
	R 2000°C f.s.	0°C to 1700°C	0.1°C																																																																						
	S 100°C f.s.	0°C to 100°C	0.01°C																																																																						
	S 500°C f.s.	0°C to 500°C	0.05°C																																																																						
	S 2000°C f.s.	0°C to 1700°C	0.1°C																																																																						
	B 2000°C f.s.	0°C to 1800°C	0.1°C																																																																						
	W : WreS-26																																																																								
W 100°C f.s.	0°C to 100°C	0.01°C	±0.05% f.s. ±2°C (400°C and above)																																																																						
W 500°C f.s.	0°C to 500°C	0.05°C																																																																							
W 2000°C f.s.	0°C to 2000°C	0.1°C																																																																							
	<table border="1"> <thead> <tr> <th colspan="2">Standard reference contact</th> </tr> </thead> <tbody> <tr> <td>Accuracy with internal compensation, add to measurement accuracy</td> <td>±0.5°C (K, E, J, T) ±1.0°C (N, R, S, B, W)</td> </tr> <tr> <td>Switching</td> <td>Switchable between internal and external</td> </tr> </tbody> </table>	Standard reference contact		Accuracy with internal compensation, add to measurement accuracy	±0.5°C (K, E, J, T) ±1.0°C (N, R, S, B, W)	Switching	Switchable between internal and external																																																																		
Standard reference contact																																																																									
Accuracy with internal compensation, add to measurement accuracy	±0.5°C (K, E, J, T) ±1.0°C (N, R, S, B, W)																																																																								
Switching	Switchable between internal and external																																																																								
A/D conversion	Resolution : 16 bit, Maximum sampling speed : 10 ms																																																																								
Filter function	Digital filter : OFF, 50 Hz, 60 Hz (With 50 and 60 Hz settings, the digital filter is automatically set according to recording interval)																																																																								
Max. allowable input	Max. allowable input : 100 V DC (maximum voltage between input terminals that does not cause damage), Max. rated voltage between channels : 200 V DC Max. rated voltage to earth : 600 V DC, AC (Upper limit voltage that does not cause damage when applied between input channel and chassis, and between each input channels)																																																																								
Conforming standards	Safety : EN61010, EMC : EN61326																																																																								
Dimensions & Mass	Approx. 38.5 mm (1.52 in) W × 133 mm (5.24 in) H × 141.2 mm (5.56 in) D mm, 550 g (19.4 oz)																																																																								
Accessories	Connection Plate x1, Operating Manual x1																																																																								

■ Specification



UNIVERSAL UNIT 8949		(accuracy specified @ 23 ±5°C/73 ±9°F, 30 to 80% rh., from 30 minutes after power on and after zero point adjustment, accuracy and product guaranteed for one year)																																																															
Input	Measurement parameters : Voltage, Thermocouples (K, E, J, T, N, W, R, S, B), Resistance temperature sensor (Pt 100, JPt 100), Humidity (only use with the Model 9701 sensor) Terminal : Screw-type terminals (4 terminals/1ch), terminal block removable, supplied terminal block cover Number of channels : 15 channels (input type selectable for each channels), Isolated from each other and chassis (at voltage or thermocouples), Not isolated from each other and common GND (at resistance temperature sensor or humidity) Input impedance: 1MΩ (850kΩ when open-circuit polling is enabled at thermocouples), 2MΩ (when resistance temperature sensor)																																																																
Measurement parameters	Voltage	<table border="1"> <thead> <tr> <th>Setting Range</th> <th>Measurement range</th> <th>Resolution</th> <th>Accuracy</th> </tr> </thead> <tbody> <tr> <td>100mV f.s.</td> <td>-150mV to +150mV</td> <td>5μV</td> <td rowspan="6">±0.1% f.s. <i>Note: at 1-5 V range, f.s.=10 V</i></td> </tr> <tr> <td>1V f.s.</td> <td>-1.5V to +1.5V</td> <td>50μV</td> </tr> <tr> <td>10V f.s.</td> <td>-15V to +15V</td> <td>500μV</td> </tr> <tr> <td>20V f.s.</td> <td>-30V to +30V</td> <td>1mV</td> </tr> <tr> <td>100V f.s.</td> <td>-60V to +60V</td> <td>5mV</td> </tr> <tr> <td>1-5V f.s.</td> <td>1V to 5V</td> <td>500μV</td> </tr> </tbody> </table>	Setting Range	Measurement range	Resolution	Accuracy	100mV f.s.	-150mV to +150mV	5μV	±0.1% f.s. <i>Note: at 1-5 V range, f.s.=10 V</i>	1V f.s.	-1.5V to +1.5V	50μV	10V f.s.	-15V to +15V	500μV	20V f.s.	-30V to +30V	1mV	100V f.s.	-60V to +60V	5mV	1-5V f.s.	1V to 5V	500μV	<table border="1"> <thead> <tr> <th>Setting Range</th> <th>Measurement range</th> <th>Resolution</th> <th>Accuracy</th> </tr> </thead> <tbody> <tr> <td>R 100°C f.s.</td> <td>0°C to 100°C</td> <td>0.01°C</td> <td rowspan="10">±0.05% f.s. ±3.5°C (0°C to less than 400°C) (Temperatures less than 400°C measured by B thermocouples are not guaranteed for accuracy)</td> </tr> <tr> <td>R 500°C f.s.</td> <td>0°C to 500°C</td> <td>0.05°C</td> </tr> <tr> <td>R 2000°C f.s.</td> <td>0°C to 1700°C</td> <td>0.1°C</td> </tr> <tr> <td>S 100°C f.s.</td> <td>0°C to 100°C</td> <td>0.01°C</td> </tr> <tr> <td>S 500°C f.s.</td> <td>0°C to 500°C</td> <td>0.05°C</td> </tr> <tr> <td>S 2000°C f.s.</td> <td>0°C to 1700°C</td> <td>0.1°C</td> </tr> <tr> <td>B 2000°C f.s.</td> <td>0°C to 1800°C</td> <td>0.1°C</td> </tr> <tr> <td>W : Wres-26</td> <td></td> <td></td> </tr> <tr> <td>W 100°C f.s.</td> <td>0°C to 100°C</td> <td>0.01°C</td> </tr> <tr> <td>W 500°C f.s.</td> <td>0°C to 500°C</td> <td>0.05°C</td> </tr> <tr> <td>W 2000°C f.s.</td> <td>0°C to 2000°C</td> <td>0.1°C</td> </tr> </tbody> </table>		Setting Range	Measurement range	Resolution	Accuracy	R 100°C f.s.	0°C to 100°C	0.01°C	±0.05% f.s. ±3.5°C (0°C to less than 400°C) (Temperatures less than 400°C measured by B thermocouples are not guaranteed for accuracy)	R 500°C f.s.	0°C to 500°C	0.05°C	R 2000°C f.s.	0°C to 1700°C	0.1°C	S 100°C f.s.	0°C to 100°C	0.01°C	S 500°C f.s.	0°C to 500°C	0.05°C	S 2000°C f.s.	0°C to 1700°C	0.1°C	B 2000°C f.s.	0°C to 1800°C	0.1°C	W : Wres-26			W 100°C f.s.	0°C to 100°C	0.01°C	W 500°C f.s.	0°C to 500°C	0.05°C	W 2000°C f.s.	0°C to 2000°C	0.1°C
	Setting Range	Measurement range	Resolution	Accuracy																																																													
	100mV f.s.	-150mV to +150mV	5μV	±0.1% f.s. <i>Note: at 1-5 V range, f.s.=10 V</i>																																																													
	1V f.s.	-1.5V to +1.5V	50μV																																																														
10V f.s.	-15V to +15V	500μV																																																															
20V f.s.	-30V to +30V	1mV																																																															
100V f.s.	-60V to +60V	5mV																																																															
1-5V f.s.	1V to 5V	500μV																																																															
Setting Range	Measurement range	Resolution	Accuracy																																																														
R 100°C f.s.	0°C to 100°C	0.01°C	±0.05% f.s. ±3.5°C (0°C to less than 400°C) (Temperatures less than 400°C measured by B thermocouples are not guaranteed for accuracy)																																																														
R 500°C f.s.	0°C to 500°C	0.05°C																																																															
R 2000°C f.s.	0°C to 1700°C	0.1°C																																																															
S 100°C f.s.	0°C to 100°C	0.01°C																																																															
S 500°C f.s.	0°C to 500°C	0.05°C																																																															
S 2000°C f.s.	0°C to 1700°C	0.1°C																																																															
B 2000°C f.s.	0°C to 1800°C	0.1°C																																																															
W : Wres-26																																																																	
W 100°C f.s.	0°C to 100°C	0.01°C																																																															
W 500°C f.s.	0°C to 500°C	0.05°C																																																															
W 2000°C f.s.	0°C to 2000°C	0.1°C																																																															
Thermocouples	<table border="1"> <thead> <tr> <th>Setting Range</th> <th>Measurement range</th> <th>Resolution</th> <th>Accuracy</th> </tr> </thead> <tbody> <tr> <td>K 100°C f.s.</td> <td>-100°C to 100°C</td> <td>0.01°C</td> <td rowspan="16">±0.05% f.s. ±1°C <i>Exclude the standard reference contact accuracy</i></td> </tr> <tr> <td>K 500°C f.s.</td> <td>-200°C to 500°C</td> <td>0.05°C</td> </tr> <tr> <td>K 2000°C f.s.</td> <td>-200°C to 1350°C</td> <td>0.1°C</td> </tr> <tr> <td>E 100°C f.s.</td> <td>-100°C to 100°C</td> <td>0.01°C</td> </tr> <tr> <td>E 500°C f.s.</td> <td>-200°C to 500°C</td> <td>0.05°C</td> </tr> <tr> <td>E 2000°C f.s.</td> <td>-200°C to 1000°C</td> <td>0.1°C</td> </tr> <tr> <td>J 100°C f.s.</td> <td>-100°C to 100°C</td> <td>0.01°C</td> </tr> <tr> <td>J 500°C f.s.</td> <td>-200°C to 500°C</td> <td>0.05°C</td> </tr> <tr> <td>J 2000°C f.s.</td> <td>-200°C to 1200°C</td> <td>0.1°C</td> </tr> <tr> <td>T 100°C f.s.</td> <td>-100°C to 100°C</td> <td>0.01°C</td> </tr> <tr> <td>T 500°C f.s.</td> <td>-200°C to 400°C</td> <td>0.05°C</td> </tr> <tr> <td>T 2000°C f.s.</td> <td>-200°C to 400°C</td> <td>0.1°C</td> </tr> <tr> <td>N 100°C f.s.</td> <td>-100°C to 100°C</td> <td>0.01°C</td> </tr> <tr> <td>N 500°C f.s.</td> <td>-200°C to 500°C</td> <td>0.05°C</td> </tr> <tr> <td>N 2000°C f.s.</td> <td>-200°C to 1300°C</td> <td>0.1°C</td> </tr> </tbody> </table>	Setting Range	Measurement range	Resolution	Accuracy	K 100°C f.s.	-100°C to 100°C	0.01°C	±0.05% f.s. ±1°C <i>Exclude the standard reference contact accuracy</i>	K 500°C f.s.	-200°C to 500°C	0.05°C	K 2000°C f.s.	-200°C to 1350°C	0.1°C	E 100°C f.s.	-100°C to 100°C	0.01°C	E 500°C f.s.	-200°C to 500°C	0.05°C	E 2000°C f.s.	-200°C to 1000°C	0.1°C	J 100°C f.s.	-100°C to 100°C	0.01°C	J 500°C f.s.	-200°C to 500°C	0.05°C	J 2000°C f.s.	-200°C to 1200°C	0.1°C	T 100°C f.s.	-100°C to 100°C	0.01°C	T 500°C f.s.	-200°C to 400°C	0.05°C	T 2000°C f.s.	-200°C to 400°C	0.1°C	N 100°C f.s.	-100°C to 100°C	0.01°C	N 500°C f.s.	-200°C to 500°C	0.05°C	N 2000°C f.s.	-200°C to 1300°C	0.1°C	<table border="1"> <tr> <td>Standard reference contact accuracy with internal compensation, add to measurement accuracy</td> <td>±0.5°C (K, E, J, T)</td> <td>±1.0°C (N, R, S, B, W)</td> </tr> <tr> <td>Switching</td> <td colspan="2">Switchable between internal and external</td> </tr> </table>		Standard reference contact accuracy with internal compensation, add to measurement accuracy	±0.5°C (K, E, J, T)	±1.0°C (N, R, S, B, W)	Switching	Switchable between internal and external							
Setting Range	Measurement range	Resolution	Accuracy																																																														
K 100°C f.s.	-100°C to 100°C	0.01°C	±0.05% f.s. ±1°C <i>Exclude the standard reference contact accuracy</i>																																																														
K 500°C f.s.	-200°C to 500°C	0.05°C																																																															
K 2000°C f.s.	-200°C to 1350°C	0.1°C																																																															
E 100°C f.s.	-100°C to 100°C	0.01°C																																																															
E 500°C f.s.	-200°C to 500°C	0.05°C																																																															
E 2000°C f.s.	-200°C to 1000°C	0.1°C																																																															
J 100°C f.s.	-100°C to 100°C	0.01°C																																																															
J 500°C f.s.	-200°C to 500°C	0.05°C																																																															
J 2000°C f.s.	-200°C to 1200°C	0.1°C																																																															
T 100°C f.s.	-100°C to 100°C	0.01°C																																																															
T 500°C f.s.	-200°C to 400°C	0.05°C																																																															
T 2000°C f.s.	-200°C to 400°C	0.1°C																																																															
N 100°C f.s.	-100°C to 100°C	0.01°C																																																															
N 500°C f.s.	-200°C to 500°C	0.05°C																																																															
N 2000°C f.s.	-200°C to 1300°C	0.1°C																																																															
Standard reference contact accuracy with internal compensation, add to measurement accuracy	±0.5°C (K, E, J, T)	±1.0°C (N, R, S, B, W)																																																															
Switching	Switchable between internal and external																																																																
Resistance temperature sensor	<table border="1"> <thead> <tr> <th>Setting Range</th> <th>Measurement range</th> <th>Resolution</th> <th>Accuracy</th> </tr> </thead> <tbody> <tr> <td>100°C f.s.</td> <td>-100°C to 100°C</td> <td>0.01°C</td> <td rowspan="3">±0.05% f.s. ±0.5°C</td> </tr> <tr> <td>500°C f.s.</td> <td>-200°C to 500°C</td> <td>0.05°C</td> </tr> <tr> <td>2000°C f.s.</td> <td>-200°C to 800°C</td> <td>0.1°C</td> </tr> <tr> <td>Resistance temperature sensor JPt 100, JIS C 1604-1997</td> <td>100°C f.s.</td> <td>-100°C to 100°C</td> <td>0.01°C</td> <td rowspan="3">±0.05% f.s. ±0.5°C</td> </tr> <tr> <td>500°C f.s.</td> <td>-200°C to 500°C</td> <td>0.05°C</td> </tr> <tr> <td>2000°C f.s.</td> <td>-200°C to 500°C</td> <td>0.1°C</td> </tr> </tbody> </table>				Setting Range	Measurement range	Resolution	Accuracy	100°C f.s.	-100°C to 100°C	0.01°C	±0.05% f.s. ±0.5°C	500°C f.s.	-200°C to 500°C	0.05°C	2000°C f.s.	-200°C to 800°C	0.1°C	Resistance temperature sensor JPt 100, JIS C 1604-1997	100°C f.s.	-100°C to 100°C	0.01°C	±0.05% f.s. ±0.5°C	500°C f.s.	-200°C to 500°C	0.05°C	2000°C f.s.	-200°C to 500°C	0.1°C																																				
Setting Range	Measurement range	Resolution	Accuracy																																																														
100°C f.s.	-100°C to 100°C	0.01°C	±0.05% f.s. ±0.5°C																																																														
500°C f.s.	-200°C to 500°C	0.05°C																																																															
2000°C f.s.	-200°C to 800°C	0.1°C																																																															
Resistance temperature sensor JPt 100, JIS C 1604-1997	100°C f.s.	-100°C to 100°C	0.01°C	±0.05% f.s. ±0.5°C																																																													
500°C f.s.	-200°C to 500°C	0.05°C																																																															
2000°C f.s.	-200°C to 500°C	0.1°C																																																															
Humidity	<table border="1"> <thead> <tr> <th>Setting Range</th> <th>Measurement range</th> <th>Resolution</th> <th>Accuracy</th> </tr> </thead> <tbody> <tr> <td>100% rh</td> <td>5.0 to 95.0% rh</td> <td>0.1% rh</td> <td>Refer to the accuracy table</td> </tr> </tbody> </table>				Setting Range	Measurement range	Resolution	Accuracy	100% rh	5.0 to 95.0% rh	0.1% rh	Refer to the accuracy table																																																					
Setting Range	Measurement range	Resolution	Accuracy																																																														
100% rh	5.0 to 95.0% rh	0.1% rh	Refer to the accuracy table																																																														
A/D conversion	Resolution : 16 bit, Maximum sampling speed : 10 ms (5 s when combined with humidity measurement)																																																																
Filter function	Digital filter : OFF, 50 Hz, 60 Hz (With 50 and 60 Hz settings, the digital filter is automatically set according to recording interval)																																																																
Max. allowable input	Max. allowable input : 60 V DC (maximum voltage between input terminals that does not cause damage), Max. rated voltage between channels : 120 V DC Max. rated voltage to earth : 600 V DC, AC (Upper limit voltage that does not cause damage when applied between input channel and chassis, and between each input channels)																																																																
Conforming standards	Safety : EN61010, EMC : EN61326																																																																
Dimensions & Mass	Approx. 38.5 mm (1.52 in) W × 133 mm (5.24 in) H × 141.2 mm (5.56 in) D mm, 530 g (18.7 oz)																																																																
Accessories	Flat-blade Screwdriver x1 (for terminal block), Connection Plate x1, Operating Manual x1																																																																

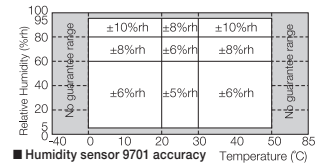

DIGITAL/PULSE UNIT 8996		(product guaranteed for one year)																				
Input	Input signal condition : No-voltage 'a' contact (normally open contact), open collector or voltage input, Digital / Pulse input selectable for each channels Measurement parameters : Voltage, Totalized pulses (integrated or instantaneous), Rotation count, ON/OFF digital signal Terminal : M3 (mm) screw terminals (2 terminals/1ch), terminal block removable, supplied terminal block cover Number of channels : 15 channels (digital / pulse selectable for each channels) (common ground for CH-1 to CH-5, common ground for CH-6 to CH-10, common ground for CH-11 to CH-15) Input impedance : 1.1MΩ																					
Pulse input	Totalized pulses	<table border="1"> <thead> <tr> <th>Setting Range</th> <th>Measurement range</th> <th>Resolution</th> </tr> </thead> <tbody> <tr> <td>1,000M pulse f.s.</td> <td>0 to 1,000M pulse</td> <td>1 pulse</td> </tr> <tr> <td>5,000/n (r/s) f.s.</td> <td>0 to 5,000/n (r/s)</td> <td>1/n (r/s)</td> </tr> </tbody> </table>	Setting Range	Measurement range	Resolution	1,000M pulse f.s.	0 to 1,000M pulse	1 pulse	5,000/n (r/s) f.s.	0 to 5,000/n (r/s)	1/n (r/s)	<table border="1"> <tr> <td>Pulse input period with filter OFF</td> <td colspan="3">200 μs or more (both H and L periods must be at least 100 μs)</td> </tr> <tr> <td>with filter ON</td> <td colspan="3">100 ms or more (both H and L periods must be at least 50 ms)</td> </tr> </table>			Pulse input period with filter OFF	200 μs or more (both H and L periods must be at least 100 μs)			with filter ON	100 ms or more (both H and L periods must be at least 50 ms)		
	Setting Range	Measurement range	Resolution																			
1,000M pulse f.s.	0 to 1,000M pulse	1 pulse																				
5,000/n (r/s) f.s.	0 to 5,000/n (r/s)	1/n (r/s)																				
Pulse input period with filter OFF	200 μs or more (both H and L periods must be at least 100 μs)																					
with filter ON	100 ms or more (both H and L periods must be at least 50 ms)																					
Rotation count	<i>Note: n = pulses per rotation (1 to 1,000)</i>																					
Digital input	Logic detection level HIGH = at least 1.0 V, LOW = 0 to 0.5 V HIGH = at least 4.0 V, LOW = 0 to 1.5 V	<table border="1"> <tr> <td>Filter</td> <td colspan="3">Chatter-prevention filter : can be set ON/OFF for each channels</td> </tr> <tr> <td>Slope</td> <td colspan="3">Rising or falling edge can be set for each channel</td> </tr> <tr> <td>Detection level</td> <td colspan="3">HIGH = at least 1.0 V, LOW = 0 to 0.5 V HIGH = at least 4.0 V, LOW = 0 to 1.5 V</td> </tr> </table>				Filter	Chatter-prevention filter : can be set ON/OFF for each channels			Slope	Rising or falling edge can be set for each channel			Detection level	HIGH = at least 1.0 V, LOW = 0 to 0.5 V HIGH = at least 4.0 V, LOW = 0 to 1.5 V							
Filter	Chatter-prevention filter : can be set ON/OFF for each channels																					
Slope	Rising or falling edge can be set for each channel																					
Detection level	HIGH = at least 1.0 V, LOW = 0 to 0.5 V HIGH = at least 4.0 V, LOW = 0 to 1.5 V																					
Max. allowable input	50 V DC (maximum voltage between input terminals that does not cause damage)																					
Max. rated voltage to earth	600 V DC, AC (Upper limit voltage that does not cause damage when applied between CH-1 to CH-5 each channel and chassis, CH-6 to CH-10 each channel and chassis, CH-11 to CH-15 each channel and chassis, and between each UNITS)																					
Max. rated voltage to each channels	33 V AC rms, 70 V DC (Upper limit voltage that does not cause damage when applied between CH-1 to CH-5 each channel and CH-6 to CH-10 each channel, CH-6 to CH-10 each channel and CH-11 to CH-15 each channel, CH-1 to CH-5 each channel and CH-11 to CH-15 each channel)																					
Conforming standards	Safety : EN61010, EMC : EN61326																					
Dimensions & Mass	Approx. 38.5 mm (1.52 in) W × 133 mm (5.24 in) H × 141.2 mm (5.56 in) D mm, 500 g (17.6 oz)																					
Accessories	Connection Plate x1, Operating Manual x1																					

ALARM UNIT 8997		(product guaranteed for one year)			
Output	Output type : open collector (active low) Alarm parameters : Use up to 15 channels in response to analog input, pulse input, rotation count, or ON/OFF digital signal Terminal : M3 (mm) screw terminals (2 terminals/1ch) Number of channels : 15 channels isolated from each other and chassis				
Output sink current	Maximum switching capability : 5 to 60 V DC @10 mA (open collector drive)				
Output refresh	Output latch settings : Latch / No latch at every recording interval				
Max. rated voltage to earth	600 V DC, AC (Upper limit voltage that does not cause damage when applied between each output channel and chassis, and between each units)				
Max. rated voltage to each channels	33 V AC rms, 70 V DC (Upper limit voltage that does not cause damage when applied between each output channels)				
Conforming standards	Safety : EN61010, EMC : EN61326				
Dimensions & Mass	Approx. 38.5 mm (1.52 in) W × 133 mm (5.24 in) H × 141.2 mm (5.56 in) D mm, 500 g (17.6 oz)				
Accessories	Connection Plate x1, Operating Manual x1				



Main unit and input or output module



Note: 8423 cannot operate alone. You must install one or more optional input modules in the unit. Thermocouples are not provided by HIOKI, and must be purchased from a separate vendor.

MEMORY HILOGGER 8423
Maximum number of connectable units: 8



VOLTAGE/TEMP UNIT 8948
15-channels, Voltage, Thermocouple input



UNIVERSAL UNIT 8949
15-channels, Voltage, Thermocouple, Resistance temperature sensor, Humidity measurement



DIGITAL/PULSE UNIT 8996
15-channels, ON/OFF logic signal, Totalized pulses (integrated or instantaneous), Rotation count



ALARM UNIT 8997
15-channels, Open-collector output

Other options



AC ADAPTER 9418-15
Universal 100 to 240 V AC, 12 V DC/ 2.5 A output

Supplied Accessories



LAN CABLE 9642
Straight Ethernet cable, supplied with straight to cross conversion cable, 5 m (16.41 ft) length



CONNECTION CABLE 9683
For synchronization, cable length 1.5 m (4.92 ft)



HUMIDITY SENSOR 9701
1-channel, for UNIVERSAL UNIT 8949

Removable storage (CF card)



Supplied with PC Card adapter

PC Card Precaution

Use only PC Cards sold by HIOKI. Compatibility and performance are not guaranteed for PC cards made by other manufacturers. You may be unable to read from or save data to such cards.

PC CARD 256M 9727
(256 MB capacity)

PC CARD 512M 9728
(512 MB capacity)

PC CARD 1G 9729
(1 GB capacity)

Appearance/Dimension Illustration

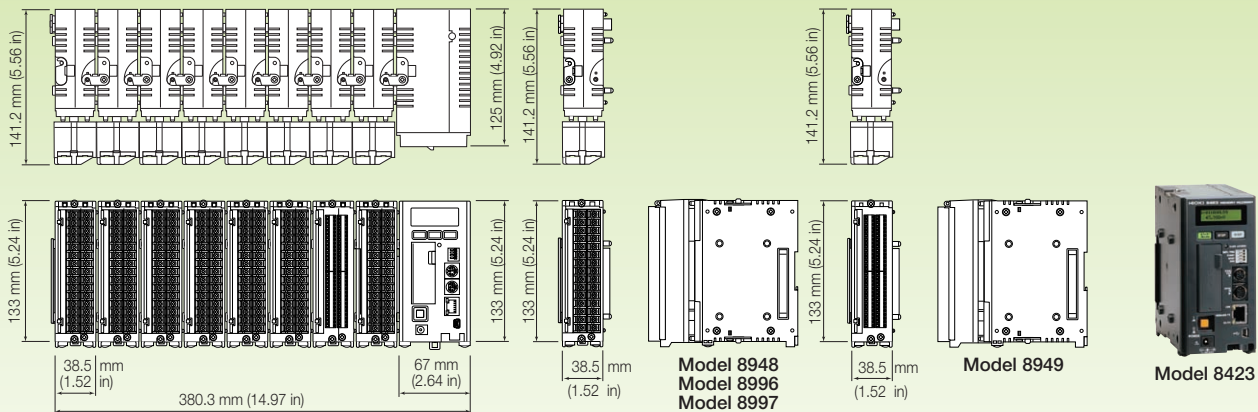

Configuration Examples

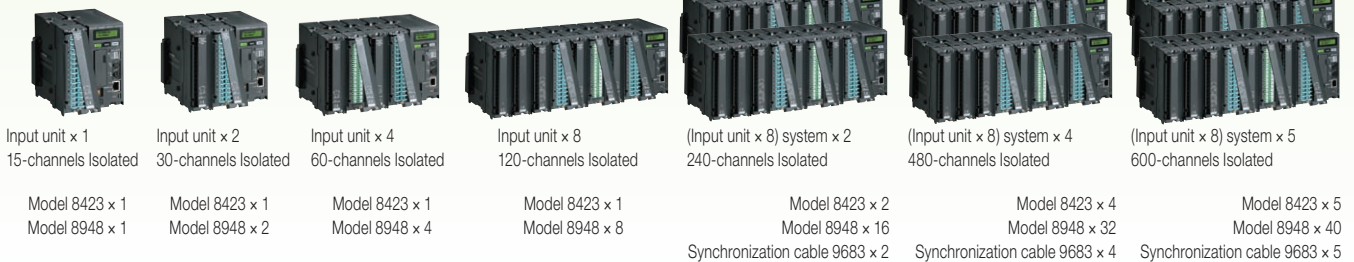

HEAD OFFICE :
81 Koizumi, Ueda, Nagano, 386-1192, Japan
TEL +81-268-28-0562 / FAX +81-268-28-0568
E-mail: os-com@hioki.co.jp

HIOKI USA CORPORATION :
6 Corporate Drive, Cranbury, NJ 08512 USA
TEL +1-609-409-9109 / FAX +1-609-409-9108
E-mail: hioki@hiokiusa.com

HIOKI (Shanghai) Sales & Trading Co., Ltd. :
1608-1610 Shanghai Times Square Office, 93 Huai Hai Zhong Road, Shanghai, P.R.China POSTCODE: 200021
TEL +86-21-6391-0090/0092 FAX +86-21-6391-0360
E-mail: info-sh@hioki.com.cn

Beijing Office :
A-2602 Freetown, 58 Dong San Huan Nan Road Beijing, P.R.China POSTCODE: 100022
TEL +86-10-5867-4080/4081 FAX +86-10-5867-4090
E-mail: info-bj@hioki.com.cn

Guangzhou Office :
Room A-3206, Victory Plaza Services Center, No.103, Tiyuxi Road, Guangzhou, P.R.China POSTCODE: 510620
TEL +86-20-38392673/2676 FAX +86-20-38392679
E-mail: info-gz@hioki.com.cn

DISTRIBUTED BY