

## Non-incendive Pressure Transmitter Model N-10, N-11

Datasheet N-10



### Applications

- Natural gas compressors
- Wellhead monitoring
- Pipeline pressure
- General industrial applications

### Special Features

- FM approved Non-incendive for Class I Division 2 hazardous locations
- Engineered to meet the harsh demands of gas compressor applications
- Do not require the use of intrinsically safe barriers
- NACE MR-01-75 compliant
- 4-20 mA or low power 1-5 volt output signals available



Left: N-10 pressure transmitter with NPT connection  
Right: N-11 flush diaphragm pressure transmitter

### Description

Model N-10 pressure transmitters are specifically designed to meet the durability and performance requirements of gas compressor systems. These pressure transmitters feature an industry standard 4-20 mA 2 wire signal output, NEMA 4X (IP 67) weather protection, and are extremely resistant to pressure spikes, vibration, and moisture intrusion. NACE MR-01-75 compliance provides extra resistance against sulfide stress cracking when exposed to gases containing sulphur.

Type N-11 pressure transmitters feature a flat, non-clogging diaphragm. This is designed for use with viscous fluids, or media containing particulates that could clog the pressure port of the standard NPT version.

The transmitters are engineered to meet Class I Division 2 Non-incendive protection requirements in hazardous environments. Each undergoes extensive quality control testing and calibration to achieve a linearity of  $\leq 0.25\%$  full scale. In addition, each pressure transmitter is temperature compensated to assure accuracy and long term stability when exposed to severe ambient temperature variations.

## Specifications

## Model N-10 / N-11

Pressure range	5PSI	10PSI	15PSI	25PSI	30PSI	60PSI	100PSI	200PSI	300PSI
Maximum pressure*	29PSI	58PSI	72PSI	145PSI	145PSI	240PSI	500PSI	1160PSI	1160PSI
Burst pressure**	35PSI	69PSI	87PSI	170PSI	170PSI	290PSI	600PSI	1390PSI	1390PSI
Pressure range	500PSI	1000PSI	1500PSI	2000PSI	3000PSI	5000PSI	8000PSI <sup>1</sup>	10000PSI <sup>1</sup>	15000PSI <sup>1</sup>
Maximum pressure*	1160PSI	1740PSI	2900PSI	4600PSI	7200PSI	11,600PSI	17,400PSI	17,400PSI	21,750PSI
Burst pressure**	5800PSI	7970PSI	11,600PSI	14,500PSI	17,400PSI	24,650PSI <sup>2</sup>	34,800PSI	34,800PSI	43,500PSI

(vacuum, gauge pressure, compound ranges, and absolute pressure references are available)

Materials		
■ Wetted parts		
> Model N-10		Stainless steel (> 300 PSI stainless steel and Elgloy)
> Model N-11		Stainless steel {Hastelloy C4}; O-ring: NBR{Viton or EPDM}
■ Case		Stainless steel
Internal transmission fluid		Synthetic oil (only for pressure ranges up to 300 PSI or flush diaphragm units)
Power supply U <sub>B</sub>	DC V	10 < U <sub>B</sub> ≤ 30 for 4 ... 20 mA, 2-wire 6 < U <sub>B</sub> < 30 for 1 ... 5 V, 3-wire low power version
Signal output and maximum load R <sub>A</sub>		4...20 mA: R <sub>A</sub> ≤ (U <sub>B</sub> - 10 V) / 0,02 A with R <sub>A</sub> in Ohm and U <sub>B</sub> in Volt 1 ... 5 V, 3-wire: R <sub>A</sub> > 10 kOhm
Response time (10 ... 90 %)	ms	≤ 1 (≤ 10 ms when media temperatures are below -22 ° F (-30 ° C) for pressure ranges up to 300 PSI or with flush diaphragm)
Accuracy <sup>3)</sup>	% of span	≤ 0.25 (BFSL)
	% of span	≤ 0.5 (limit point calibration)
Non-repeatability	% of span	≤ 0.05
Hysteresis	% of span	≤ 0.1
1-year stability	% of span	≤ 0.2 (at reference conditions)
Permissible temperature of		
• ■ Medium		-22 ... +212 ° F   -30 ... +100 ° C
• ■ Ambient		-22 ... +212 ° F   -30 ... +100 ° C
• ■ Storage		-40 ... +221 ° F   -40 ... +105 ° C
Compensated temp. range		32 ... +176 ° F   0 ... +80 ° C
Temperature coefficients in compensated temp range:		
■ Mean TC of zero	% of span	≤ 0.2 / 10 K (< 0,4 for pressure range < 100 INWC)
■ Mean TC of range	% of span	≤ 0.2 / 10 K
Approval authority		Factory Mutual (FM) Non-incendive with entity approval for: Class 1, Division 2, Groups A, B, C, D Dust-ignitionproof for Class II and III, Division 1, Groups E, F, and G Maximum electrical ratings 30 V, 20 mA FM Standards according to FMRC 3600, 3611, 3810
HF-immunity	V/m	10
Burst	KV	4
Ingress protection		NEMA 4X (IP 67)
Shock resistance	g	1000 according to IEC 60068-2-27 (mechanical shock)
Vibration resistance	g	20 according to IEC 60068-2-27 (vibration under resonant conditions)
Wiring protection		Protected against reverse polarity, overvoltage, and short circuiting
Weight	lb	0.4

\* Pressure applied up to the maximum rating will cause no permanent change in specifications but may lead to zero and span shifts

\*\*Exceeding the burst pressure may result in destruction of the transmitter

- 1) Only Model N-10.
- 2) For Model N-11: the burst pressure is limited to 21,000 PSI unless the pressure seal is accomplished by using the sealing ring underneath the hex.
- 3) Includes linearity, hysteresis and repeatability. Limit point calibration performed in vertical mounting position with pressure connection facing down.
- 4) Transmitters will function when exposed to these extended temperature ranges. The media, when exposed to temperature extremes, may change characteristics that effect transmitter performance.

{ } Items in curved brackets are options available at additional cost.

# Dimensions in inches (mm)

## Electrical connection

6 foot cable with free ends  
NEMA 4 / IP 67  
Order code: EM

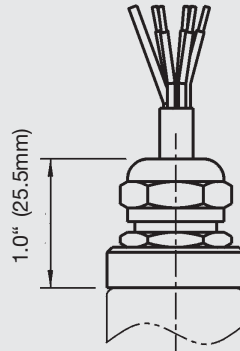

## Case



## N-10 pressure connections

1/4 NPT male  
Order code: NB

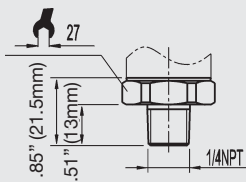

1/2 NPT male  
Order code: ND

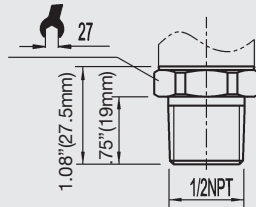

G 1/2  
EN 837  
Order code: GD

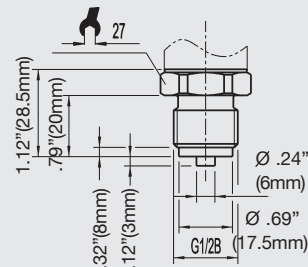

G 1/4  
EN 837  
Order code: GB

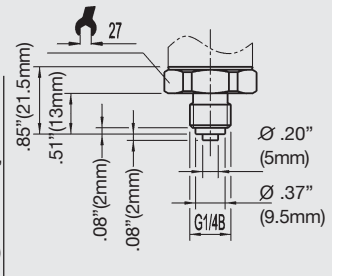

## N-11 flush diaphragm pressure connections

N-11 G 1  
50 INWC to 25 PSI  
Order code: 85

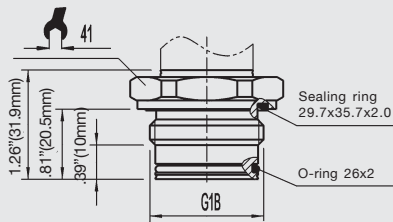

N-11 G 1/2  
30 PSI to 5,000 PSI  
Order code: 86

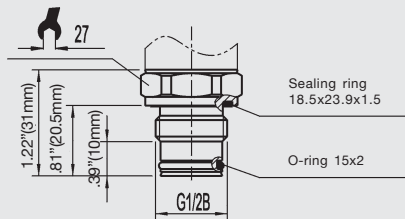

## Matching P-1 weld insert adapters for N-11 flush diaphragm transmitters

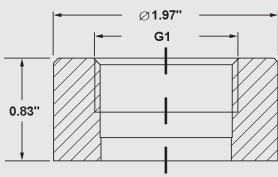

P-1 G1 weld insert adapter  
Part # 1206974  
for pressure ranges  $\leq 25$  PSI

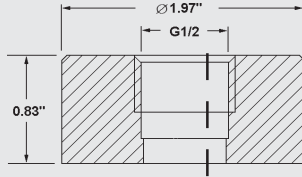

P-1 G1/2 weld insert adapter  
Part # 1097008  
for pressure ranges  $\geq 30$  PSI

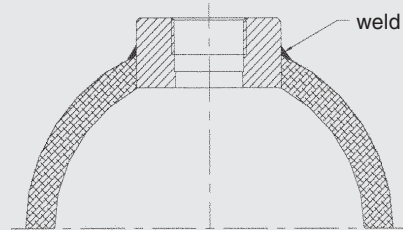

Cross section view of P-1  
adapter installed in pipe.

## Wiring details

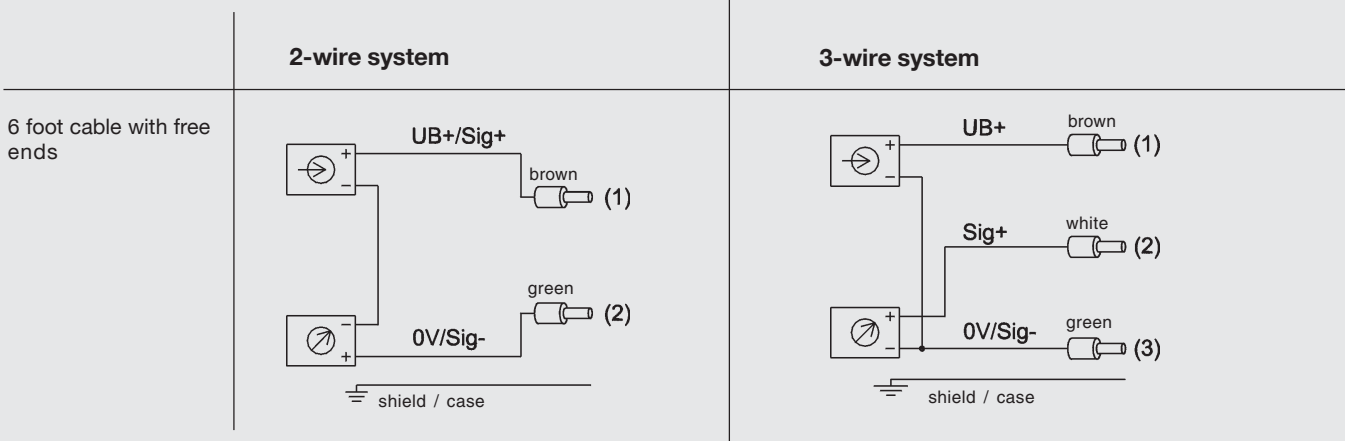

### Legend:

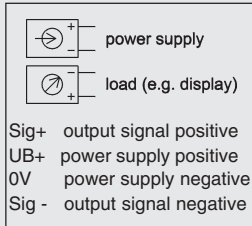

Specifications and dimensions given in this data sheet represent the state of engineering at the time of printing. Modifications may take place and materials specified may be replaced by others without prior notice.