



Level



Pressure



Flow



Temperature



Liquid  
Analysis



Registration



Systems  
Components



Services



Solutions

## Operating Instructions

# Cerabar S PMP71 with MID Part Certificate

## Process pressure measurement

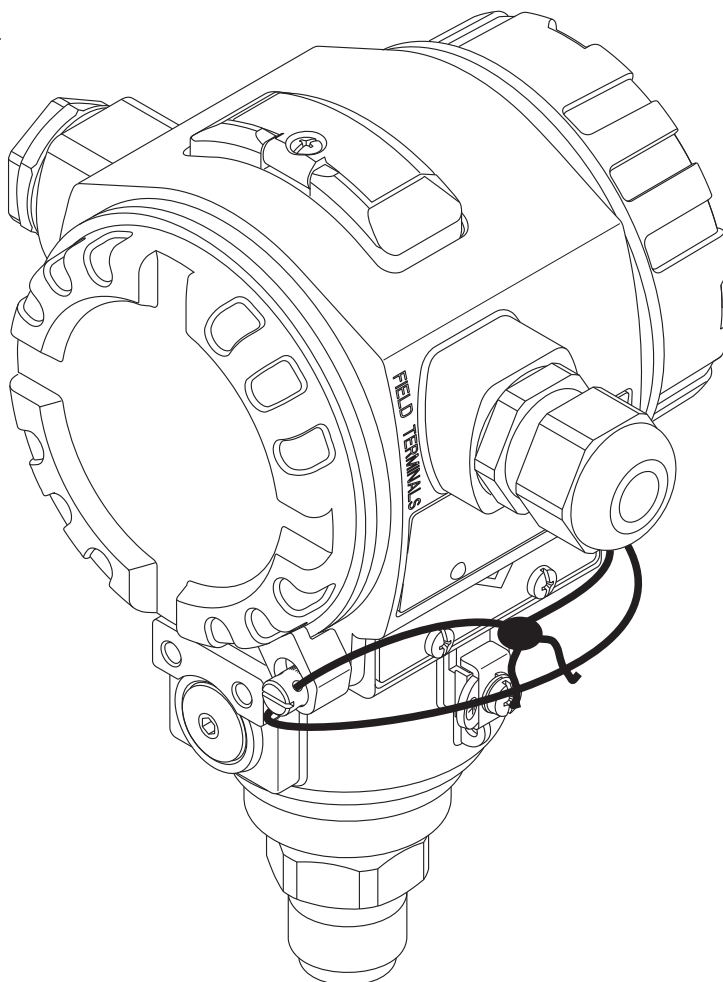

BA00412P/00/EN/03.14  
71270369

Valid for software version:  
02.10.54

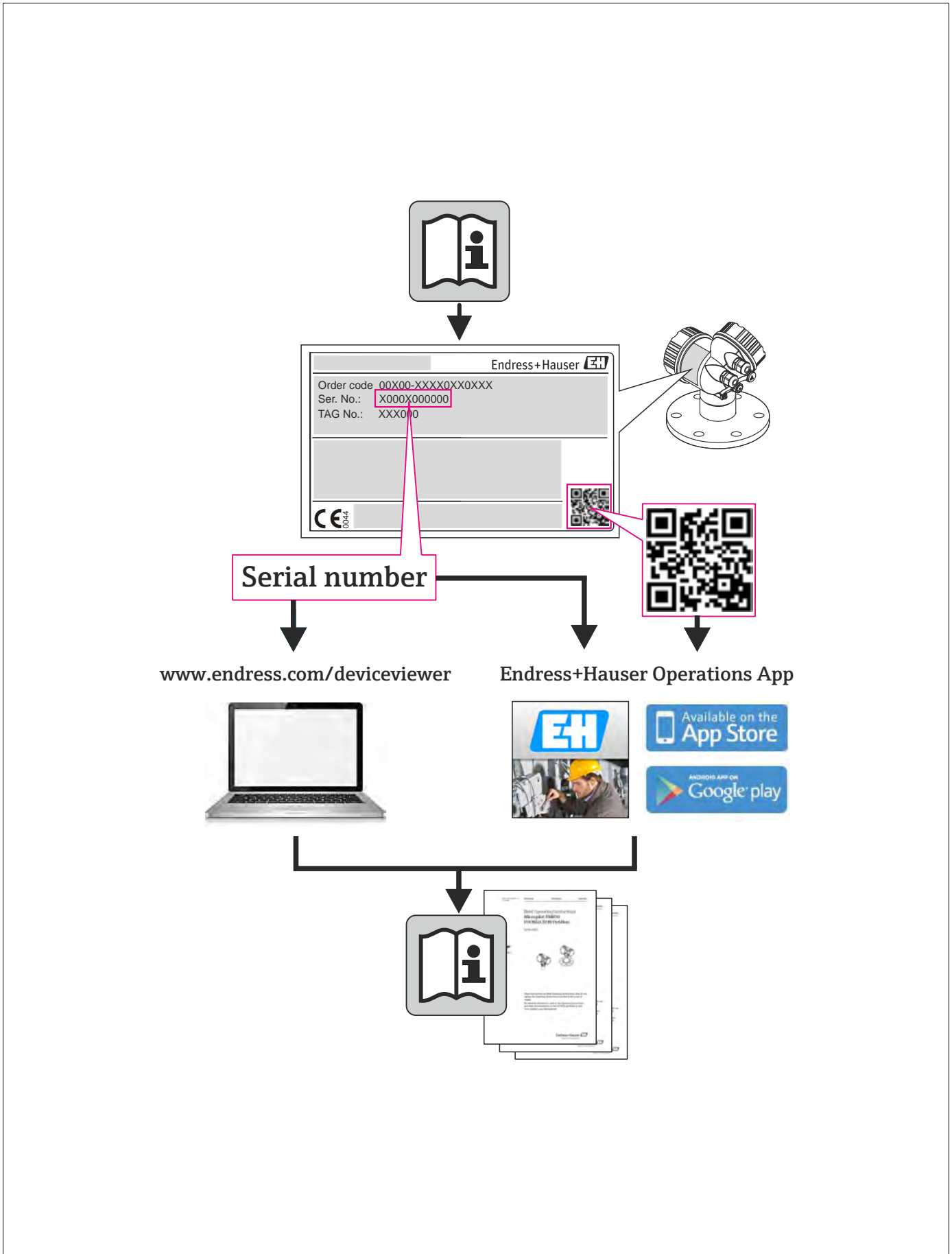

A0023555



# 1 Safety instructions

## 1.1 Designated use

The Cerabar S is a pressure transmitter for measuring pressure.

The manufacturer accepts no liability for damages resulting from incorrect use or use other than that designated.

## 1.2 Installation, commissioning and operation

The device is designed to meet state-of-the-art safety requirements and complies with applicable standards and EC regulations. If used incorrectly or for anything other than the designated use, the device can, however, be a source of danger e.g. product overflow due to incorrect installation or configuration. Consequently, installation, connection to the electricity supply, commissioning, operation and maintenance of the measuring system must be carried out by trained, qualified specialists authorized to perform such work by the facility's owner-operator. The specialists must have read and understood these Operating Instructions and must follow the instructions they contain. Modifications and repairs to the device are permissible only if they are expressly approved in the manual. Pay particular attention to the information and instructions on the nameplate.

## 1.3 Operational and process safety

Alternative monitoring measures have to be taken while configuring, testing or servicing the device to ensure operational and process safety.

### 1.3.1 Hazardous areas (optional)

Devices for use in hazardous areas are fitted with an additional nameplate (→  6). If the measuring system is to be used in hazardous areas, applicable national standards and regulations must be observed. The device is accompanied by separate "Ex documentation" which is an integral part of these Operating Instructions. The installation regulations, connection values and safety instructions listed in this Ex documentation must be observed. The documentation number of the related safety instructions is also indicated on the additional nameplate.













- Ensure that all personnel are suitably qualified.

### 1.3.2 Functional safety SIL3 (optional)

If using devices for functional-safety applications, strict compliance with the Functional Safety Manual (SD00190P) is mandatory.

## 1.4 Notes on safety conventions and icons

In order to highlight safety-related or alternative operating procedures in the manual, the following conventions have been used, each indicated by a corresponding icon in the margin.

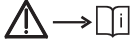
Symbol	Meaning
	<b>Warning!</b> A warning highlights actions or procedures which, if not performed correctly, will lead to serious personal injury, a safety hazard or the destruction of the device.
	<b>Caution!</b> A caution highlights actions or procedures which, if not performed correctly, may lead to personal injury or the incorrect operation of the device.
	<b>Note!</b> A note highlights actions or procedures which, if not performed correctly, can have an indirect effect on operation or trigger an unexpected response on the part of the device.
	<b>Explosion-protected, type-examined equipment</b> If the device has this symbol embossed on its nameplate, it can be used in a hazardous area or a non-hazardous area, depending on the approval.
	<b>Hazardous areas</b> Symbol used in drawings to indicate hazardous areas. – Devices used in hazardous areas must possess an appropriate type of protection.
	<b>Safe area (non-hazardous area)</b> Symbol used in drawings to indicate non-hazardous areas. – Devices used in hazardous areas must possess an appropriate type of protection. Cables used in hazardous areas must meet the necessary safety-related characteristic quantities.
	<b>Direct current</b> A terminal to which DC voltage is applied or through which direct current flows.
	<b>Alternating current</b> A terminal to which alternating voltage (sine-wave) is applied or through which alternating current flows.
	<b>Ground connection</b> A grounded terminal which, as far as the operator is concerned, is grounded by means of a grounding system.
	<b>Protective ground terminal</b> A terminal which must be connected to ground prior to establishing any other connections.
	<b>Equipotential connection</b> A connection that has to be connected to the plant grounding system: this may be a potential equalization line or a star grounding system depending on national or company codes of practice.
	<b>Connecting cable immunity to temperature change</b> Indicates that the connecting cables have to withstand a temperature of 85 °C (185 °F) at least.
	<b>Safety instructions</b> Observe the safety instructions in the associated Operating Instructions.

## 2 Identification

### 2.1 Device designation

#### 2.1.1 Nameplates



Note!

- The MWP (maximum working pressure) is specified on the nameplate. This value refers to a reference temperature of 20°C (68°F) or 100°F (38°C) for ASME flanges.
- The pressure values permitted at higher temperatures can be found in the following standards:
  - EN 1092-1: 2001 Tab. 18 <sup>1)</sup>
  - ASME B 16.5a – 1998 Tab. 2-2.2 F316
  - ASME B 16.5a – 1998 Tab. 2.3.8 N10276
  - JIS B 2220
- The test pressure corresponds to the overpressure limit (OPL) of the device =  $MWP \times 1.5$  <sup>2)</sup>.
- The Pressure Equipment Directive (EC Directive 97/23/EC) uses the abbreviation "PS". The abbreviation "PS" corresponds to the MWP (maximum working pressure) of the measuring device.

- 1) With regard to their stability-temperature property, the materials 1.4404 and 1.4435 are grouped together under 13EO in EN 1092-1 Tab. 18. The chemical composition of the two materials can be identical.
- 2) The equation does not apply to PMP71 with a 50 bar (750 psi) or a 100 bar (1,500 psi) measuring cell.

#### Aluminum and stainless steel housing (T14)

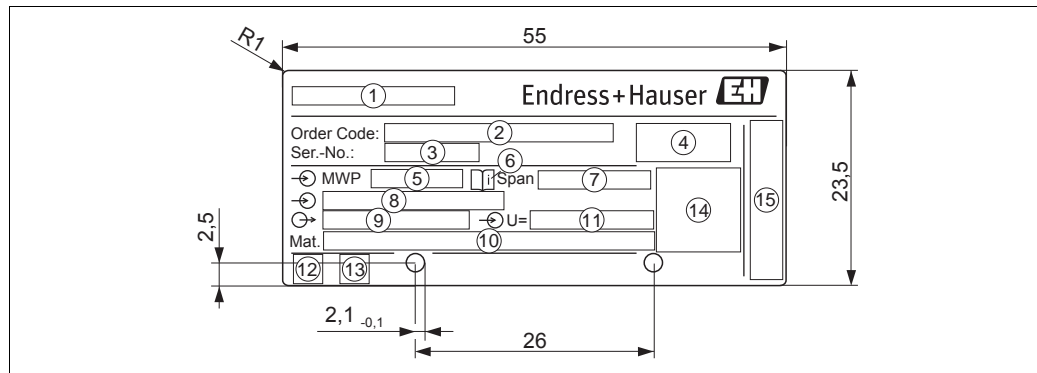

P01-XXMX7XXXX-18-xx-xx-xx-000

Fig. 1: Nameplate

- 1 Device name
- 2 Order code  
See the specifications on the order confirmation for the meanings of the individual letters and digits.
- 3 Serial number
- 4 Degree of protection
- 5 MWP (Maximum working pressure)
- 6 Symbol: Note: pay particular attention to the data in "Technical Information"!
- 7 Minimum/maximum span
- 8 Nominal measuring range
- 9 Electronic version (output signal)
- 10 Wetted materials
- 11 Supply voltage
- 12 GL symbol for GL marine certificate (optional)
- 13 SIL symbol for devices with SIL3/IEC 61508 Declaration of Conformity (optional)
- 14 Approval marks and ID numbers
- 15 Manufacturer's address

Devices for use in hazardous areas are fitted with an additional nameplate.

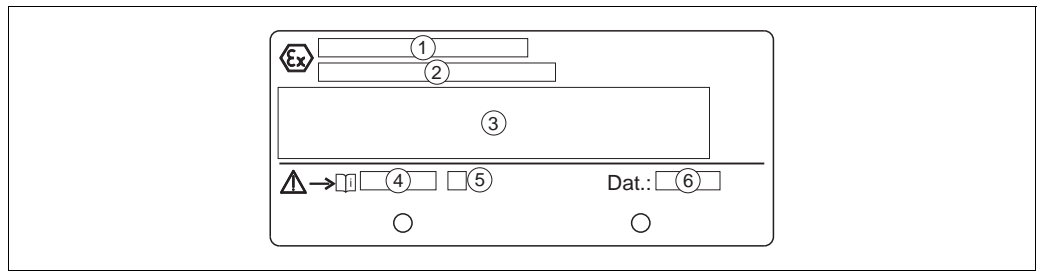

P01-xMD7xxxx-18-xx-xx-xx-002

Fig. 2: Additional nameplate for devices suitable for use in hazardous areas

- 1 EC type-examination certificate number
- 2 Type of protection e.g. II 1/2 G Ex ia IIC T6
- 3 Electrical data
- 4 Safety Instructions number e.g. XA00235P
- 5 Safety Instructions index e.g. A
- 6 Date of device manufacture

Devices suitable for oxygen applications are fitted with an additional nameplate.

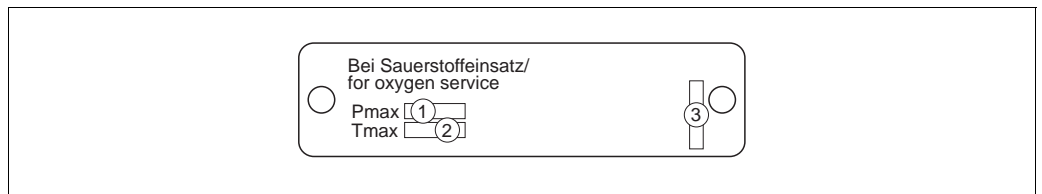

P01-xxxxxxxx-18-xx-xx-xx-000

Fig. 3: Additional nameplate for devices suitable for oxygen applications

- 1 Maximum pressure for oxygen applications
- 2 Maximum temperature for oxygen applications
- 3 Layout identification of the nameplate

Devices suitable for custody transfer applications are fitted with an additional nameplate.

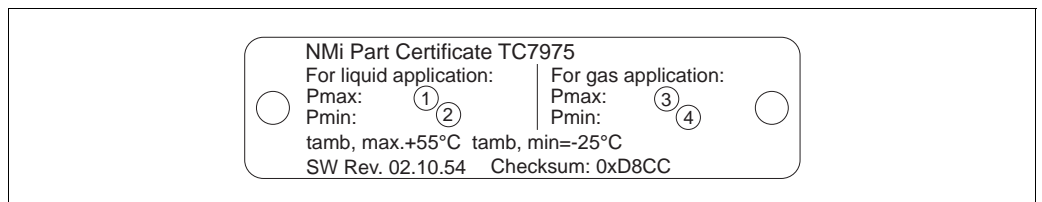

P01-PMP71MID-18-xx-xx-xx-000

Fig. 4: Additional nameplate for devices suitable for custody transfer applications

- 1 Maximum pressure for liquid applications
- 2 Minimum pressure for liquid applications
- 3 Maximum pressure for gas applications
- 4 Minimum pressure for gas applications

**Hygienic stainless steel housing (T17)**

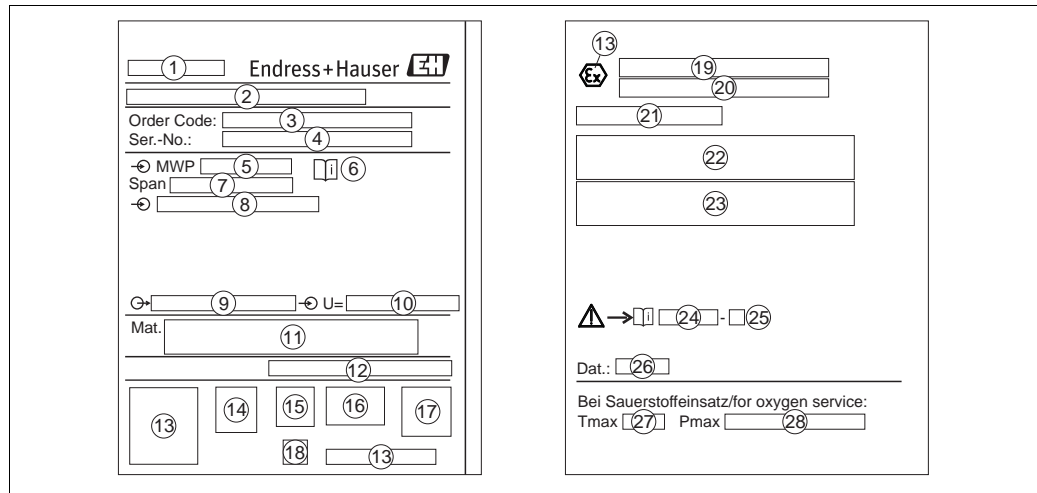

P01-XXMX7XXXX-18-xx-xx-xx-001

Fig. 5: Nameplate

- 1 Device name
- 2 Manufacturer's address
- 3 Order code
- 4 Serial number
- 5 MWP (Maximum working pressure)
- 6 Symbol: Note: pay particular attention to the data in "Technical Information"!
- 7 Minimum/maximum span
- 8 Nominal measuring range
- 9 Electronic version (output signal)
- 10 Supply voltage
- 11 Wetted materials
- 12 Type of protection
  
- Optional:
- 13 Approval marks and ID numbers
- 14 3A symbol
- 15 CSA symbol
- 16 FM symbol
- 17 SIL symbol for devices with SIL3/IEC 61508 Declaration of Conformity
- 18 GL symbol for GL marine certificate
- 19 EC type-examination certificate
- 20 Type of protection
- 21 Approval number for WHG overfill protection
- 22 Temperature operating range for devices for use in hazardous areas
- 23 Electrical data for devices for use in hazardous areas
- 24 Safety Instructions number
- 25 Safety Instructions index
- 26 Date of device manufacture
- 27 Maximum temperature for devices suitable for oxygen applications
- 28 Maximum pressure for devices suitable for oxygen applications

**2.1.2 Identifying the sensor type**

See parameter "Sensor Meas.Type" in Operating Instructions BA00413P.



## 2.2 Scope of delivery

The scope of delivery comprises:

- Cerabar S pressure transmitter
- For devices with the "HistoROM/M-DAT" option:  
CD-ROM with Endress+Hauser operating program
- Optional accessories

Documentation supplied:

- Operating Instructions BA00412P and BA00413P are available via the Internet.  
→ See: [www.endress.com](http://www.endress.com) → Download.
- Brief Operating Instructions KA01095P
- Fold-out flyer KA00298P
- Final inspection report
- Also Safety Instructions with ATEX, IECEx and NEPSI devices
- Optional: factory calibration certificate, inspection certificates

## 2.3 Certificates and approvals

### CE mark, Declaration of Conformity

The device is designed to meet state-of-the-art safety requirements, has been tested and left the factory in a condition in which it is safe to operate. The device complies with the applicable standards and regulations as listed in the EC Declaration of Conformity and thus complies with the statutory requirements of the EC Directives. Endress+Hauser confirms the successful testing of the device by affixing to it the CE mark.

## 2.4 Registered trademarks

KALREZ<sup>®</sup>, VITON<sup>®</sup>, TEFLON<sup>®</sup>

Registered trademarks of E.I. Du Pont de Nemours & Co., Wilmington, USA

TRI-CLAMP<sup>®</sup>

Registered trademark of Ladish & Co., Inc., Kenosha, USA

HART<sup>®</sup>

Registered trademark of HART Communication Foundation, Austin, USA

GORE-TEX<sup>®</sup>

Registered trademark of W.L. Gore & Associates, Inc., USA

## 3 Installation

### 3.1 Incoming acceptance, transport and storage

#### 3.1.1 Incoming acceptance

- Check the packaging and the contents for damage.
- Check the shipment, make sure nothing is missing and that the scope of supply matches your order.

#### 3.1.2 Transporting to the measuring point



Caution!

Please comply with the safety instructions and transport conditions for devices weighing over 18 kg (39.69 lbs).

Transport the device to the measuring point in the original packaging or at the process connection.

#### 3.1.3 Storage

The device must be stored in a dry, clean place and protected against damage from impact (EN 837-2).

Storage temperature range:

See Technical Information TI00383P.

### 3.2 Installation conditions

#### 3.2.1 Dimensions

For dimensions, please refer to the "Mechanical construction" section in TI00383P.

### 3.3 Installation instructions



Note!

- Due to the orientation of the Cerabar S, there may be a shift in the zero point, i.e. when the container is empty or partially full, the measured value does not display zero. You can correct this zero point shift either directly at the device using the "E" key or by remote operation. See
  - [24](#), "Function of the operating elements – onsite display not connected" or
  - [36](#), "Position adjustment".
- To ensure optimal readability of the onsite display, it is possible to rotate the housing up to 380°.
  - [15](#), "Rotating the housing".
- Endress+Hauser offers a mounting bracket for installing on pipes or walls.
  - [13](#), "Wall and pipe-mounting (optional)".

### 3.3.1 Installation instructions



Note!

- If a heated Cerabar S is cooled during the cleaning (e.g. by cold water), a vacuum develops for a short time, whereby water can penetrate the sensor through the pressure compensation point (1). If this is the case, mount the sensor with the pressure compensation point (1) pointing downwards.

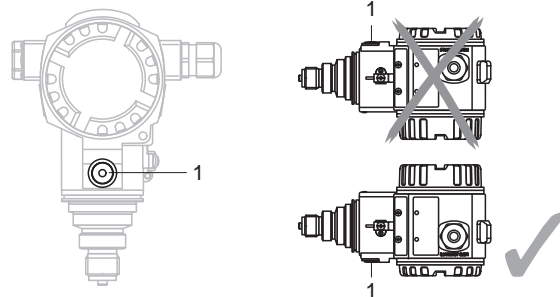

- Keep the pressure compensation and GORE-TEX® filter (1) free from contamination and water.
- Cerabar S devices are mounted as per the norms for a manometer (DIN EN 837-2). We recommend the use of shutoff devices and siphons. The orientation depends on the measuring application.
- Do not clean or touch process isolating diaphragms with hard or pointed objects.
- To comply with ASME-BPE requirements regarding cleanability (Part SD Cleanability), the device must be installed as follows:

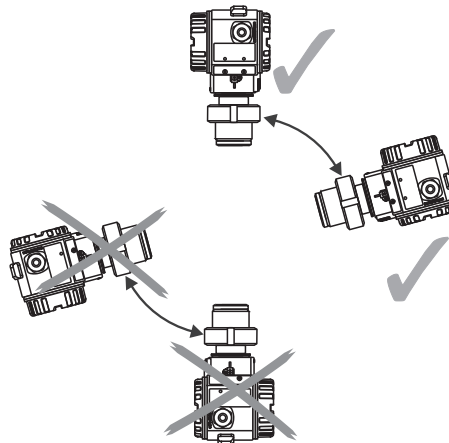

### Pressure measurement in gases

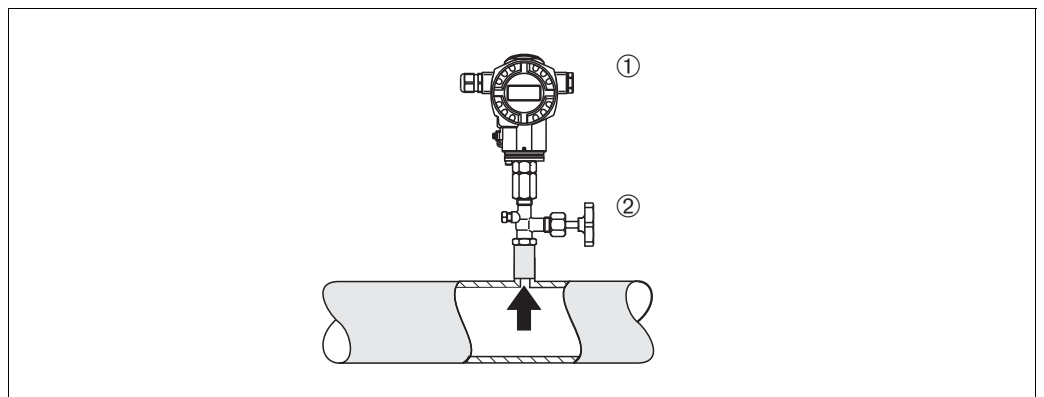

Fig. 6: Measuring arrangement for pressure measurement in gases

- 1 Cerabar S
- 2 Shutoff device

Mount Cerabar S with shutoff device above the tapping point so that any condensate can flow into the process.

### Pressure measurement in steam

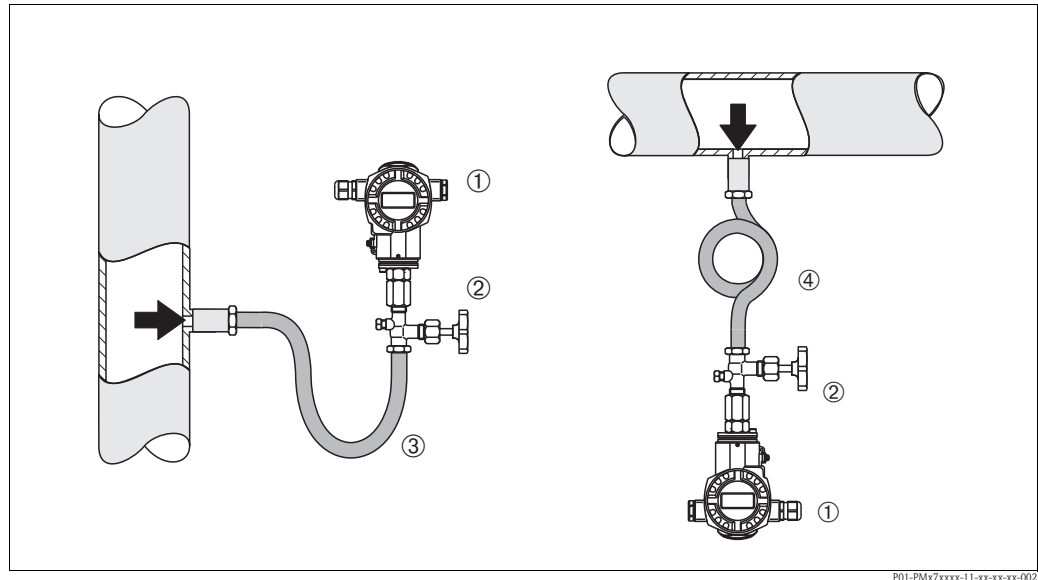
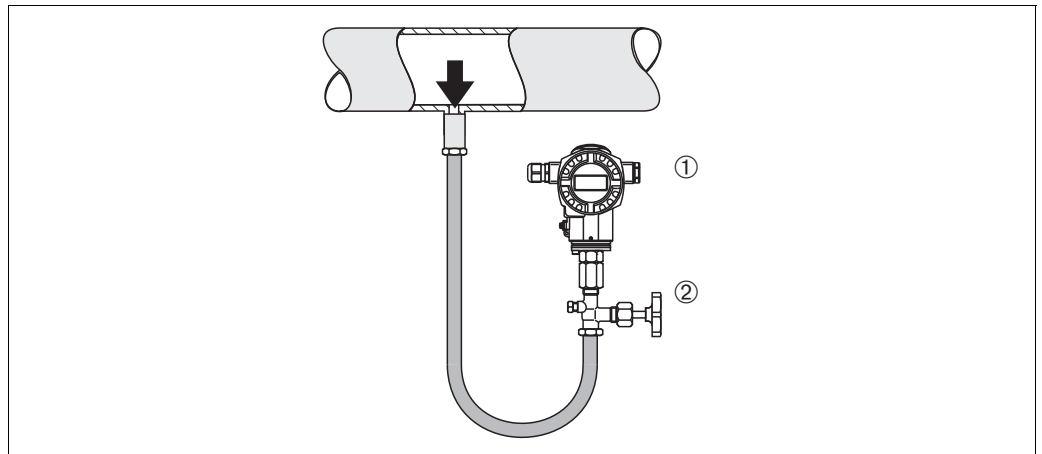

Fig. 7: Measuring arrangement for pressure measurement in steam

- 1 Cerabar S
- 2 Shutoff device
- 3 U-shaped siphon
- 4 Circular siphon

- Use siphons for pressure measurement in steam. The siphon reduces the temperature to almost ambient temperature. Preferably mount the Cerabar S with the siphon below the tapping point. Advantages:
  - defined water column only causes minimal/negligible measured errors
  - only minimal/negligible thermal effects on the device
 Mounting above the tapping point is also possible. Pay attention to the maximum permitted ambient temperature of the transmitter!
- Fill the siphon with liquid before commissioning.

### Pressure measurement in liquids



P01-PMz7xxxx-11-xx-xx-xx-003

Fig. 8: Measuring arrangement for pressure measurement in liquids

- 1 Cerabar S
- 2 Shutoff device

Mount Cerabar S with shutoff device below or at the same level as the tapping point.

### 3.3.2 Seal for flange mounting

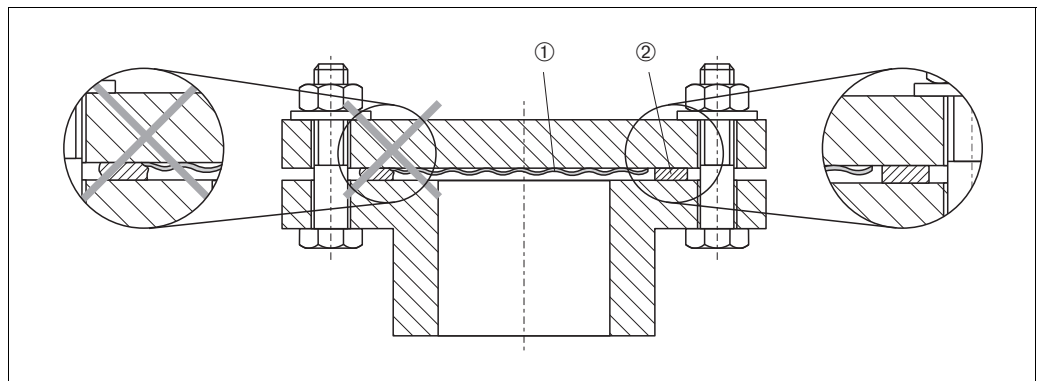

P01-FMD7xxxx-11-xx-xx-xx-002

Fig. 9: Mounting the versions with flange or diaphragm seal

- 1 Process isolating diaphragm
- 2 Seal



#### Warning!

The seal is not allowed to press against the process isolating diaphragm as this could affect the measurement result.

### 3.3.3 Wall and pipe-mounting (optional)

Endress+Hauser offers a mounting bracket for installing on pipes or walls.

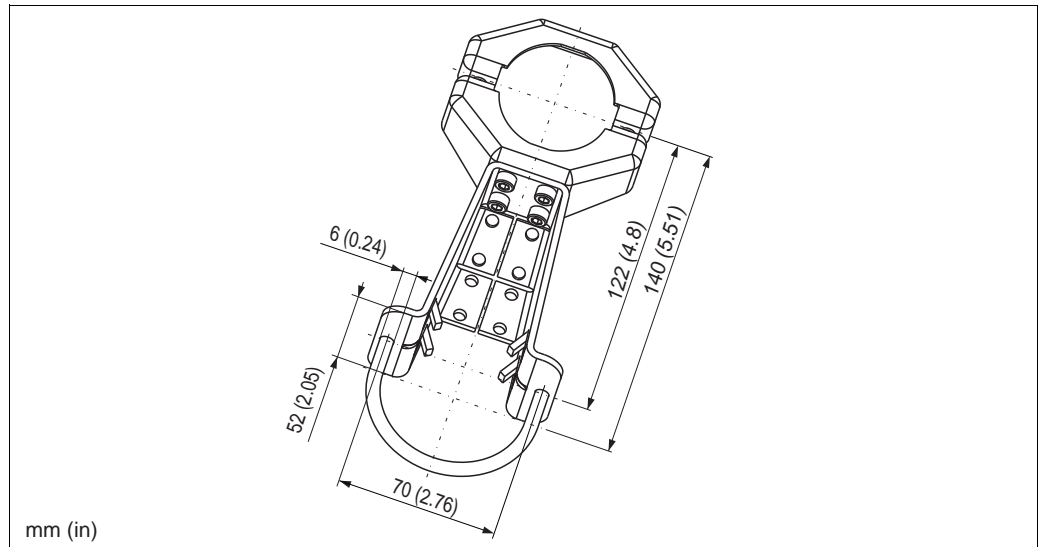

Please note the following when mounting:

- Devices with capillary tubes: mount capillaries with a bending radius of  $\geq 100$  mm (3.94 in).
- In the case of pipe mounting, the nuts on the bracket must be tightened uniformly with a torque of at least 5 Nm (3.69 lbf ft).

### 3.3.4 Rotating the housing

The housing can be rotated up to 380° by loosening the setscrew.

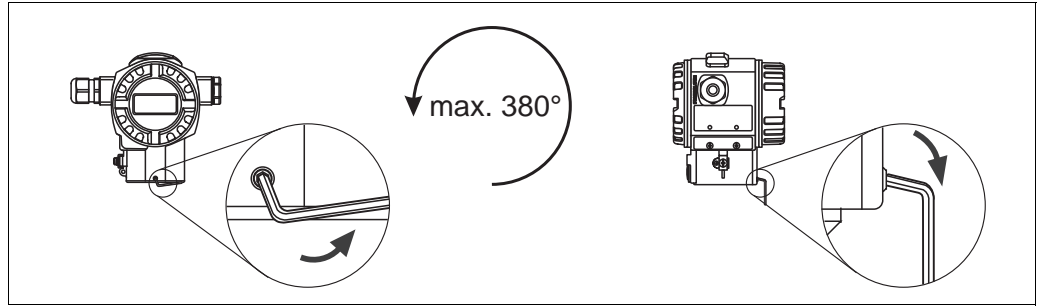

Fig. 10: Aligning the housing

- T14 and T15 housing: Loosen setscrew with a 2 mm (0.08 in) Allen key.
- Hygienic T17 housing: Loosen setscrew with a 3 mm (0.12 in) Allen key.
- Rotate housing (max. up to 380°).
- Retighten setscrew with a torque of 1 Nm (0.74 lbf ft).

### 3.3.5 Closing the housing cover



Note!

When closing the housing cover, please ensure that the thread of the cover and housing are free from dirt, e.g. sand. If you feel any resistance when closing the cover, check the thread on both again to ensure that they are free from dirt.

#### Close cover on a hygienic stainless steel housing (T17)

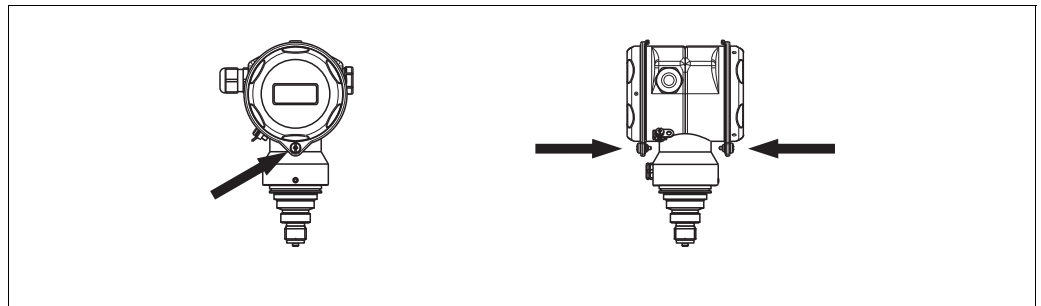

Fig. 11: Close cover

The covers for the terminal and electronics compartment are hooked into the casing and closed with a screw. These screws should be finger-tightened (2 Nm (1.48 lbf ft)) to the stop to ensure that the covers sit tightly.

### 3.4 Post-installation check

After installing the device, carry out the following checks:

- Are all the screws firmly tightened?
- Are the housing covers screwed down tight?

## 4 Wiring

### 4.1 Connecting the device



Warning!

If the operating voltage is > 35 VDC: Dangerous contact voltage at terminals.

Risk of electric shock!

In a wet environment, do not open the cover if voltage is present.



Warning!

Risk of electric shock and/or explosion in hazardous areas! In a wet environment, do not open the cover if voltage is present.



Note!

- When using the measuring device in hazardous areas, installation must comply with the corresponding national standards and regulations and the Safety Instructions or Installation or Control Drawings.
- Devices with integrated overvoltage protection must be grounded.
- Protective circuits against reverse polarity, HF influences and overvoltage peaks are integrated.
- The supply voltage must match the supply voltage on the nameplate (→ 6, "Nameplates").
- Switch off the supply voltage before connecting the device.
- Remove the housing cover of the terminal compartment.
- Guide the cable through the gland. Preferably use twisted, shielded two-wire cables.
- Connect the device in accordance with the following diagram.
- Screw down the housing cover.
- Switch on the supply voltage.

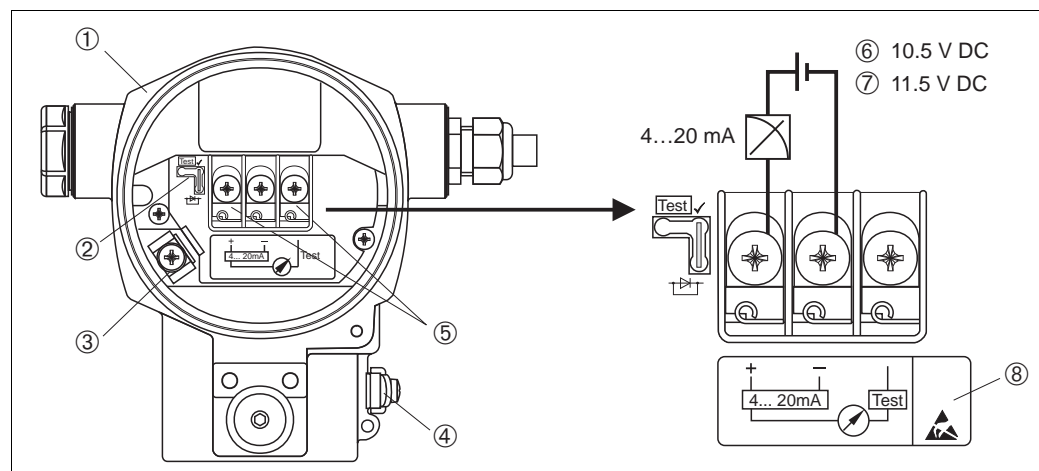

P01-xxMx7xxxx-04-xx-xx-xx-001

Fig. 12: Electrical connection 4 to 20 mA HART. Please also note → 18, "Supply voltage".

- 1 Housing
- 2 Jumper for 4 to 20 mA test signal.  
→ 18, Section "Taking 4 to 20 mA test signal".
- 3 Internal earth terminal
- 4 External earth terminal
- 5 4 to 20 mA test signal between plus and test terminal
- 6 Minimum supply voltage = 10.5 V DC, jumper is inserted in accordance with the illustration.
- 7 Minimum supply voltage = 11.5 V DC, jumper is inserted in "Test" position.
- 8 Devices with integrated overvoltage protection are labeled OVP (overvoltage protection) here.



### 4.1.1 Connecting devices with Harting connector Han7D

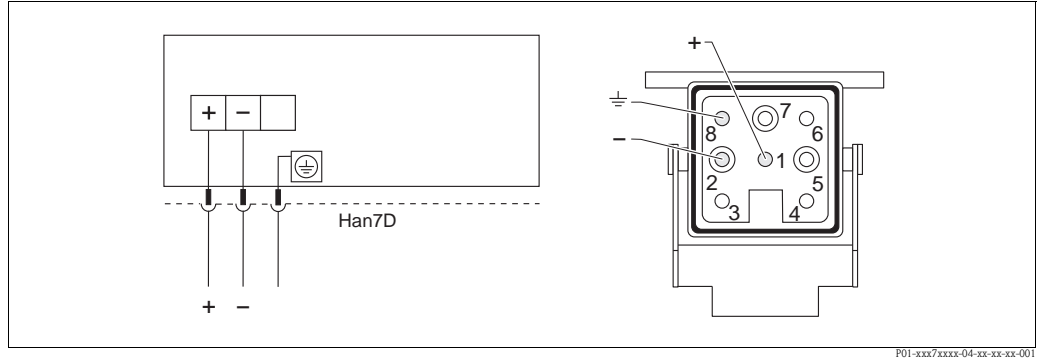

Fig. 13: Left: electrical connection for devices with Harting connector Han7D  
Right: view of the connection at the device

### 4.1.2 Devices with M12 connector

#### PIN assignment for M12 connector

PIN	Meaning
1	signal +
2	not used
3	signal -
4	ground

### 4.1.3 Connecting the cable version

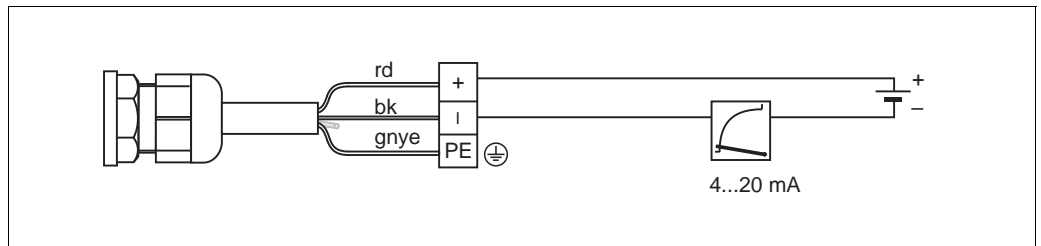

Fig. 14: rd = red, bk = black, gnye = green-yellow

## 4.2 Connecting the measuring unit

### 4.2.1 Supply voltage



Note!

- When using the measuring device in hazardous areas, installation must comply with the corresponding national standards and regulations and the Safety Instructions or Installation or Control Drawings.
- All explosion protection data are given in separate documentation which is available upon request. The Ex documentation is supplied as standard with all devices approved for use in explosion hazardous areas.

Electronic version	Jumper for 4 to 20 mA test signal in "Test" position (order configuration)	Jumper for 4 to 20 mA test signal in "Non-Test" position
4 to 20 mA HART, version for non-hazardous areas	11.5 to 45 V DC	10.5 to 45 V DC

#### Taking 4 to 20 mA test signal

A 4 to 20 mA signal may be measured via the positive and test terminal without interrupting the measurement. The minimum supply voltage of the device can be reduced by simply replugging the jumper. As a result, operation is also possible with lower voltage sources. To keep the measured error below 0.1%, the current measuring device should exhibit an internal resistance of  $< 0.7 \Omega$ . Observe the position of the jumper in accordance with the following table.

Jumper position for test signal	Description
	<ul style="list-style-type: none"> <li>– Taking 4 to 20 mA test signal via plus and test terminal: possible. (Thus, the output current can be measured without interruption via the diode.)</li> <li>– Order configuration</li> <li>– Minimum supply voltage: 11.5 V DC</li> </ul>
	<ul style="list-style-type: none"> <li>– Taking 4 to 20 mA test signal via plus and test terminal: not possible.</li> <li>– Minimum supply voltage: 10.5 V DC</li> </ul>

### 4.2.2 Cable specification

- Endress+Hauser recommends using twisted, shielded two-wire cables.
- Terminals for wire cross-sections  $0.5$  to  $2.5 \text{ mm}^2$  (20 to 14 AWG)
- Cable outer diameter: 5 to 9 mm (0.2 to 0.35 in)

### 4.2.3 Load

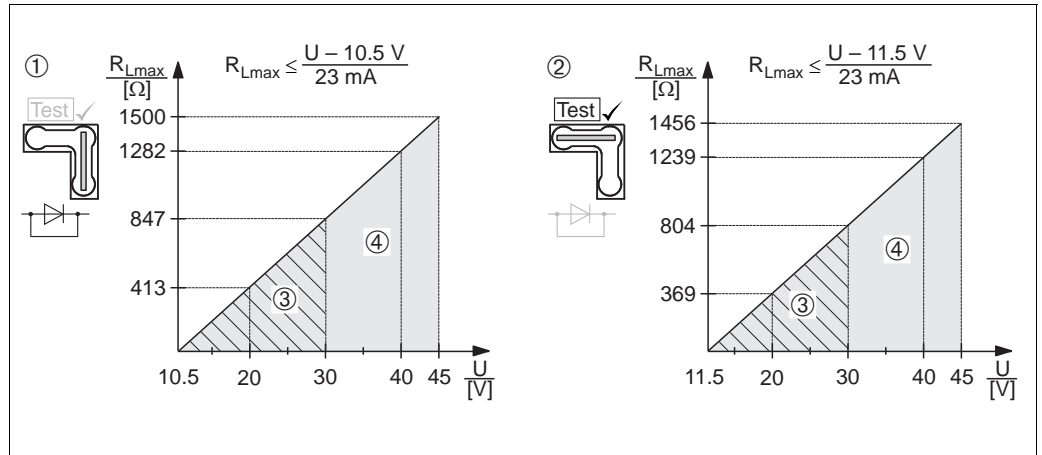

Fig. 15: Load diagram, observe the position of the jumper and the explosion protection.  
 (→ 18, Section "Taking 4 to 20 mA test signal".)

- 1 Jumper for the 4 to 20 mA test signal inserted in "Non-Test" position
- 2 Jumper for the 4 to 20 mA test signal inserted in "Test" position
- 3 Supply voltage 10.5 (11.5) to 30 V DC for 1/2 G, 1 GD, 1/2 GD, FM IS, CSA IS, IECEx ia, NEPSI Ex ia
- 4 Supply voltage 10.5 (11.5) to 45 V DC for devices for non-hazardous areas, 1/2 D, 1/3 D, 2 G Ex d, 3 G Ex nA, FM XP, FM DIP, FM NI, CSA XP, CSA dust ignition-proof, NEPSI Ex d

$R_{Lmax}$  Maximum load resistance  
 U Supply voltage



**Note!**

When operating via a handheld terminal or via a PC with an operating program, a minimum communication resistance of 250 Ω must be taken into account.

### 4.2.4 Shielding/potential matching

- You achieve optimum shielding against interference influences if the shielding is connected on both sides (in the cabinet and at the device). If potential equalization currents are expected in the plant, only ground the shielding on one side, preferably at the transmitter.
- When using in hazardous areas, you must observe the applicable regulations. Separate Ex documentation with additional technical data and instructions is included with all Ex devices as standard.

### 4.2.5 Connecting HART handheld terminal

With a HART handheld terminal you can set and check the transmitter and avail of additional functions all along the 4 to 20 mA line.

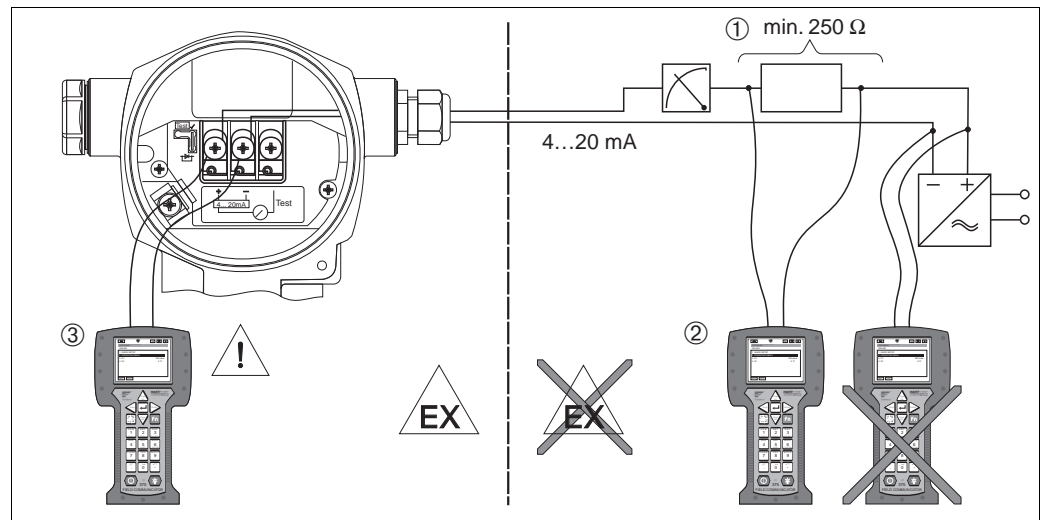

Fig. 16: Connecting HART handheld terminal, e.g. Field Communicator 375, 475

- 1 Necessary communication resistor  $250\ \Omega$
- 2 HART handheld terminal
- 3 HART handheld terminal, directly connected to the device even in the Ex i-area



Warning!

- In the case of Ex d type of protection, do not connect the handheld terminal in the hazardous area.
- Do not replace the battery of the handheld terminal in the hazardous area.
- For devices with FM or CSA certificates, establish electrical connection as per Installation or Control Drawing (ZD) supplied.

### 4.2.6 Connecting the Commubox FXA195

The Commubox FXA195 connects intrinsically safe transmitters with HART protocol to the USB interface of a computer. This enables remote operation of the transmitter using the Endress+Hauser operating program FieldCare. The power is supplied to the Commubox via the USB interface. The Commubox is also suitable for connection to intrinsically safe circuits. For additional information, refer to TI00404F/00/EN.

### 4.2.7 Connecting Commubox FXA291/ToF adapter FXA291 for operation via FieldCare

#### Commubox FXA291

The Commubox FXA291 connects Endress+Hauser field devices with a CDI interface (= Endress+Hauser common data interface) to the USB port of a personal computer or a notebook. For details, refer to TI00405C/07/EN.



Note!

You will also require the following accessory for the device: "ToF Adapter FXA291".

#### ToF Adapter FXA291

ToF Adapter FXA291 connects Commubox FXA291 via the USB interface of a personal computer or laptop to the device. For details, refer to KA00271F/00/A2.

### 4.3 Potential equalization

Ex applications: Connect all devices to the local potential equalization system.  
Observe the applicable regulations.

### 4.4 Post-connection check

Perform the following checks after completing electrical installation of the device:

- Does the supply voltage match the specifications on the nameplate?
- Is the device connected correctly (→  16)?
- Are all the screws firmly tightened?
- Are the housing covers screwed down tight?

As soon as voltage is applied to the device, the green LED on the electronic insert lights up for a few seconds or the connected onsite display lights up.

## 5 Operation

Feature 20 "Output; operation" in the order code provides you with information on the operating options available to you.

Versions in the order code		Operation
A	4 to 20 mA HART; external operation, LCD	Via onsite display and 3 keys on the exterior of the device
B	4 to 20 mA HART; internal operation, LCD	Via onsite display and 3 keys on the inside of the device
C	4 to 20 mA; internal operation	Without onsite display, 3 keys on the inside of the device

### 5.1 Onsite display (optional)

A 4-line liquid crystal display (LCD) is used for display and operation.

The onsite display shows measured values, dialog texts, fault messages and notice messages.

The display of the device can be turned in 90° stages. Depending on the orientation of the device, this makes it easy to operate the device and read the measured values.

Functions:

- 8-digit measured value display including sign and decimal point, unit display and bar graph for current display
- Simple and complete menu guidance as parameters are split into several levels and groups
- Menu guidance in 8 languages (de, en, fr, es it, nl, jp, ch)
- Each parameter is given a 3-digit ID number for easy navigation
- Option for configuring the display according to individual requirements, such as language, alternating display, contrast setting, display of other measured values such as sensor temperature
- Comprehensive diagnostic functions (fault and warning message, maximum indicators, etc.)
- Rapid and safe commissioning with the Quick Setup menus

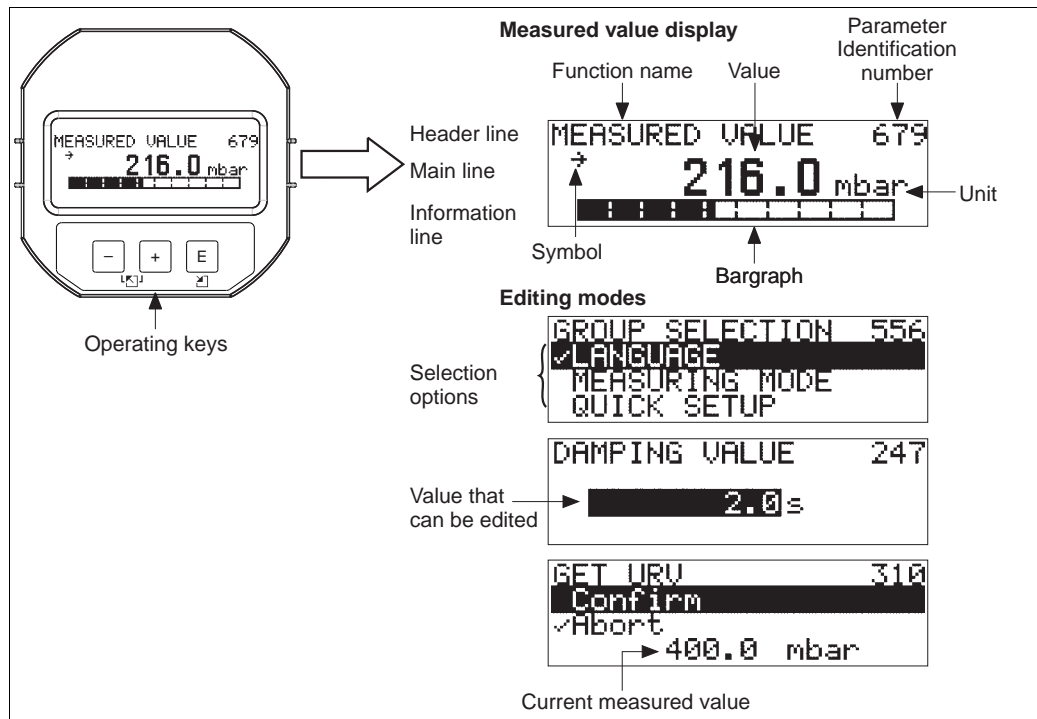

P01-xMx7xxxx-07-xx-xx-xx-001

The following table illustrates the symbols that can appear on the onsite display. Four symbols can occur at one time.

Symbol	Meaning
	<b>Alarm symbol</b> – Symbol flashing: warning, device continues measuring. – Symbol permanently lit: error, device does not continue measuring. <i>Note:</i> The alarm symbol may overlie the tendency symbol.
	<b>Lock symbol</b> The operation of the device is locked. To unlock the device → 34.
	<b>Communication symbol</b> Data transfer via communication
	<b>Tendency symbol (increasing)</b> The measured value is increasing.
	<b>Tendency symbol (decreasing)</b> The measured value is decreasing.
	<b>Tendency symbol (constant)</b> The measured value has remained constant over the past few minutes.

## 5.2 Operating elements

### 5.2.1 Position of operating elements

With regard to aluminum or stainless steel housings (T14), the operating keys are located either outside the device under the protection cap or inside on the electronic insert. In hygienic stainless steel housings (T17), the operating keys are always located inside on the electronic insert. Operating keys are also integrated on the optional onsite display.

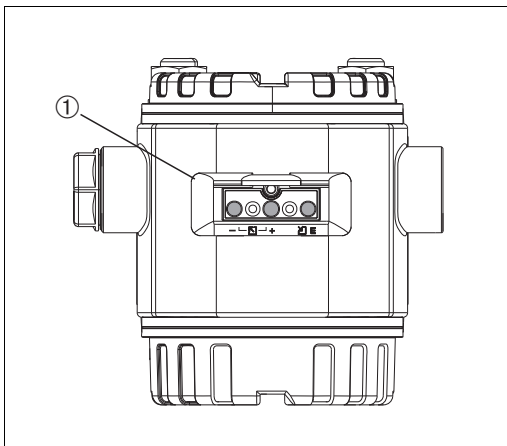

Fig. 17: Operating keys, external

- 1 Operating keys on the exterior of the device under the protective flap

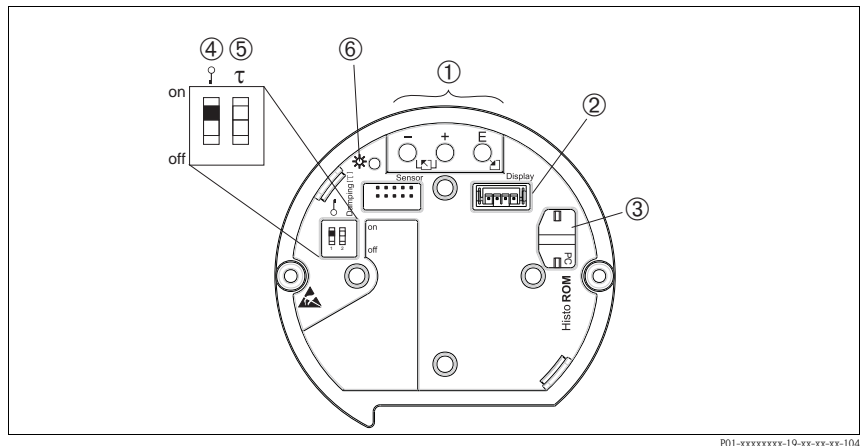









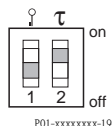

Fig. 18: Operating keys, internal









- 1 Operating keys
- 2 Slot for optional display
- 3 Slot for optional HistoROM®/M-DAT module
- 4 DIP switch for locking/unlocking measured-value relevant parameters  
 Lead sealing of the housing cover is provided (→ 38) for use in applications subject to custody transfer regulations. The DIP switch must be used to block access to the electronics and lock configuration of the device.
- 5 DIP switch for damping on/off
- 6 Green LED to indicate value being accepted

### 5.2.2 Function of the operating elements – onsite display not connected

Press and hold the key or the key combination for at least 3 seconds to execute the corresponding function. Press the key combination for at least 6 seconds for a reset.

Operating key(s)	Meaning
	Adopt lower-range value. Reference pressure is present at the device. For a detailed description, also see → 25, "Pressure measuring mode".
	Adopt upper-range value. Reference pressure is present at the device. For a detailed description, also see → 25, "Pressure measuring mode".
	Position adjustment.
 and  and 	Reset all parameters. The reset via operating keys corresponds to the software reset code 7864.
 and 	Copy the configuration data from the optional HistoROM®/M-DAT module to the device.
 and 	Copy the configuration data from the device to the optional HistoROM®/M-DAT module.
	<ul style="list-style-type: none"> <li>– DIP switch 1: for locking/unlocking parameters relevant to the measured value Factory setting: off (unlocked)</li> <li>– DIP switch 2: damping on/off, Factory setting: on (damping on)</li> </ul>

### 5.2.3 Function of the operating elements – onsite display connected

Operating key(s)	Meaning
	<ul style="list-style-type: none"> <li>– Navigate upwards in the picklist</li> <li>– Edit the numerical values and characters within a function</li> </ul>
	<ul style="list-style-type: none"> <li>– Navigate downwards in the picklist</li> <li>– Edit the numerical values and characters within a function</li> </ul>
	<ul style="list-style-type: none"> <li>– Confirm entry</li> <li>– Jump to the next item</li> </ul>
 and 	Contrast setting of onsite display: darker
 and 	Contrast setting of onsite display: brighter
 and 	<p>ESC functions:</p> <ul style="list-style-type: none"> <li>– Exit edit mode without saving the changed value.</li> <li>– You are in a menu within a function group. The first time you press the keys simultaneously, you go back a parameter within the function group. Each time you press the keys simultaneously after that, you go up a level in the menu.</li> <li>– You are in a menu at a selection level. Each time you press the keys simultaneously, you go up a level in the menu.</li> </ul> <p><i>Note:</i> The terms function group, level and selection level are explained in → 26, "General structure of the operating menu".</p>



### 5.3 Onsite operation – onsite display not connected



Note!

To operate the device with a HistoROM®/M-DAT module, see Page → 28, "HistoROM®/M-DAT (optional)".

#### 5.3.1 Pressure measuring mode

If no onsite display is connected, the following functions are possible by means of the three keys on the electronic insert or on the exterior of the device:

- Position adjustment (zero point correction)
- Setting lower-range value and upper-range value
- Device reset → 24, "Function of the operating elements – onsite display not connected".



Note!

- The operation must be unlocked. → 32, "Locking/unlocking operation".
- The device is configured for the "Pressure" measuring mode as standard. You can switch measuring modes by means of the MEASURING MODE parameter. → 35, "Selecting language and measuring mode".
- The pressure applied must be within the nominal pressure limits of the sensor. See information on the nameplate.

Carrying out position adjustment. <sup>1)</sup>		Setting lower-range value.		Setting upper-range value.	
Pressure is present at device.		Desired pressure for lower-range value is present at device.		Desired pressure for upper-range value is present at device.	
↓		↓		↓	
Press "E" key for at least 3 s.		Press "-" key for at least 3 s.		Press "+" key for at least 3 s.	
↓		↓		↓	
Does the LED on the electronic insert light up briefly?		Does the LED on the electronic insert light up briefly?		Does the LED on the electronic insert light up briefly?	
Yes	No	Yes	No	Yes	No
↓	↓	↓	↓	↓	↓
Pressure present for position adjustment has been accepted.	Pressure present for position adjustment has not been accepted. Observe the input limits.	Pressure present for lower-range value has been accepted.	Pressure present for lower-range value has not been accepted. Observe the input limits.	Pressure present for upper-range value has been accepted.	Pressure present for upper-range value has not been accepted. Observe the input limits.

1) Please note warning on Page → 35, "Commissioning".

## 5.4 Onsite operation – onsite display connected

If the onsite display is connected, the three operating keys are used to navigate through the operating menu → 24, "Function of the operating elements – onsite display connected".

### 5.4.1 General structure of the operating menu

The menu is split into four levels. The three upper levels are used to navigate while you use the bottom level to enter numerical values, select options and save settings.

The structure of the OPERATING MENU depends on the measuring mode selected, e.g. if the "Pressure" measuring mode is selected, only the functions needed for this mode are displayed.

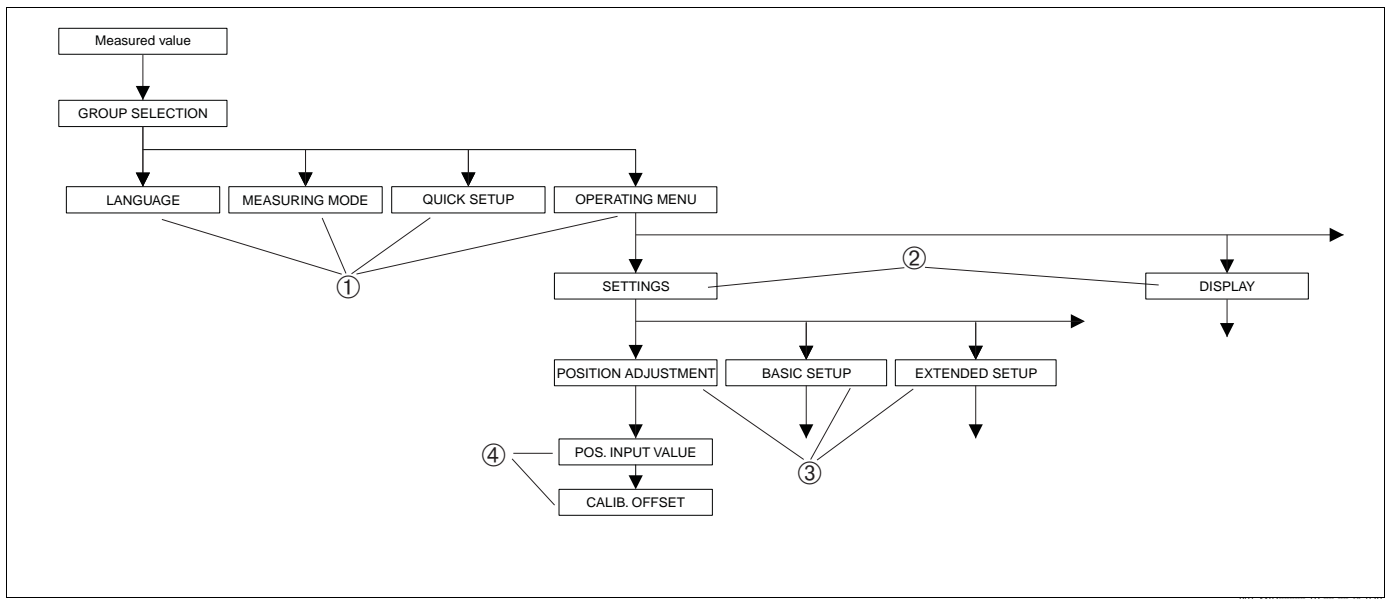

Fig. 19: General structure of the operating menu

- 1 1. Selection level
- 2 2. Selection level
- 3 Function groups
- 4 Parameters



#### Note!

The LANGUAGE and MEASURING MODE parameters are only displayed via the onsite display on the 1st selection level. In digital communication, the LANGUAGE parameter is displayed in the DISPLAY group and the MEASURING MODE parameter is displayed in the QUICK SETUP menus or in the BASIC SETUP function group.

### 5.4.2 Selecting an option

Example: selecting "English" as the language of the menu.

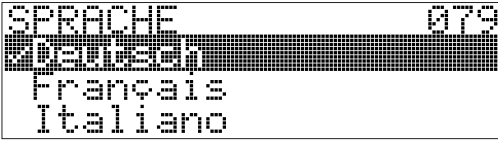
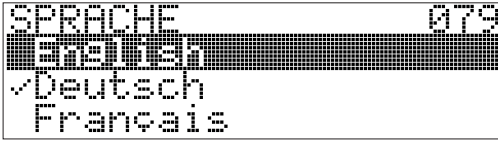
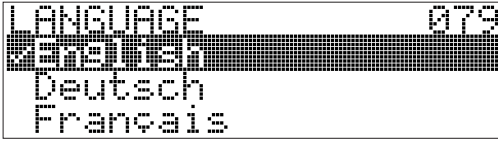
Onsite display	Operation
 <p>SPRACHE 079 Deutsch Français Italiano</p> <p>P01-xxxxxxx-19-xx-xx-xx-017</p>	<p>German is selected as the language. A ✓ in front of the menu text indicates the active option.</p>
 <p>SPRACHE 079 English ✓Deutsch Français</p> <p>P01-xxxxxxx-19-xx-xx-xx-033</p>	<p>Select English with "+" or "-".</p>
 <p>LANGUAGE 079 English Deutsch Français</p> <p>P01-xxxxxxx-19-xx-xx-xx-034</p>	<ol style="list-style-type: none"> <li>1. Confirm your choice with "E". A ✓ in front of the menu text indicates the active option. (English is now selected as the menu language.)</li> <li>2. Jump to the next item with "E".</li> </ol>

### 5.4.3 Editing a value

Example: adjusting DAMPING VALUE function from 2.0 s to 30.0 s.

→ 24, "Function of the operating elements – onsite display connected".

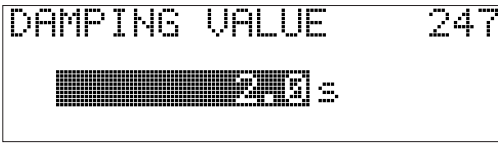
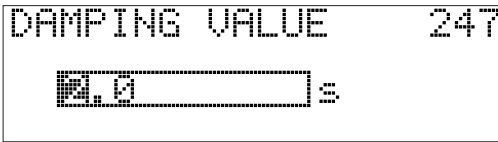
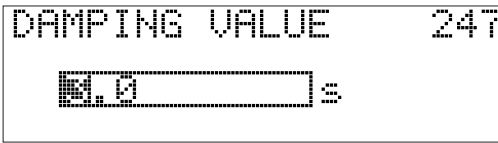
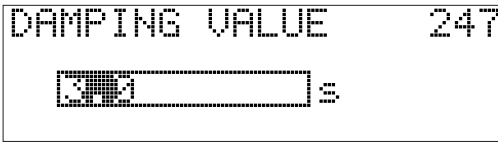
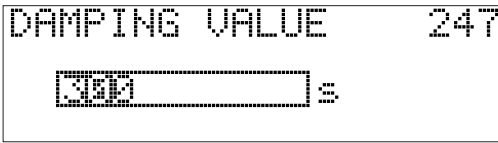
Onsite display	Operation
 <p>DAMPING VALUE 247 2.0 s</p> <p>P01-xxxxxxx-19-xx-xx-xx-023</p>	<p>The onsite display shows the parameter to be changed. The value highlighted in black can be changed. The "s" unit is fixed and cannot be changed.</p>
 <p>DAMPING VALUE 247 2.0 s</p> <p>P01-xxxxxxx-19-xx-xx-xx-027</p>	<ol style="list-style-type: none"> <li>1. Press "+" or "-" to get to the editing mode.</li> <li>2. The first digit is highlighted in black.</li> </ol>
 <p>DAMPING VALUE 247 3.0 s</p> <p>P01-xxxxxxx-19-xx-xx-xx-028</p>	<ol style="list-style-type: none"> <li>1. Use "+" to change "2" to "3".</li> <li>2. Confirm "3" with "E". The cursor jumps to the next position (highlighted in black).</li> </ol>
 <p>DAMPING VALUE 247 30.0 s</p> <p>P01-xxxxxxx-19-xx-xx-xx-029</p>	<p>The decimal point is highlighted in black, i.e. you can now edit it.</p>
 <p>DAMPING VALUE 247 30.0 s</p> <p>P01-xxxxxxx-19-xx-xx-xx-030</p>	<ol style="list-style-type: none"> <li>1. Keep pressing "+" or "-" until "0" is displayed.</li> <li>2. Confirm "0" with "E". The cursor goes to the next position. ↓ is displayed and highlighted in black. → See next graphic.</li> </ol>

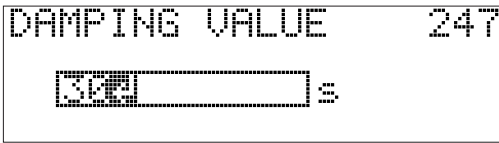
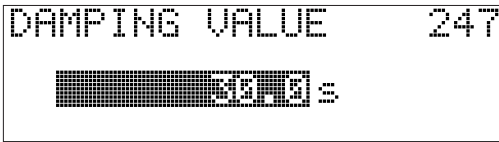
Onsite display	Operation
 <p style="text-align: center; font-size: small;">P01-xxxxxxx-19-xx-xx-xx-031</p>	Use "E" to save the new value and exit the editing mode. See next graphic.
 <p style="text-align: center; font-size: small;">P01-xxxxxxx-19-xx-xx-xx-032</p>	The new value for the damping is now 30.0 s. – Jump to the next parameter with "E". – You can get back to the editing mode with "+" or "-".

### 5.4.4 Taking pressure applied at device as value

Example: configuring upper-range value – assigning 20 mA to the pressure value 400 mbar (6 psi).

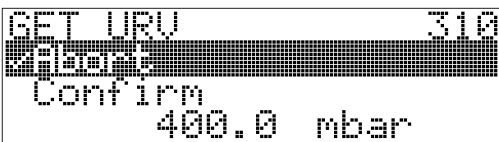
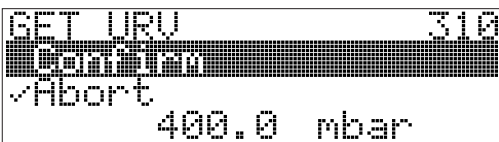
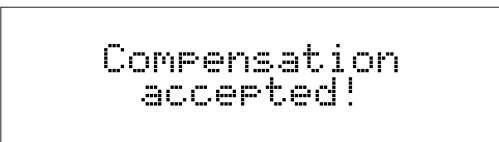
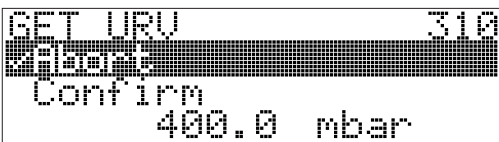
Onsite display	Operation
 <p style="text-align: center; font-size: small;">P01-xxxxxxx-19-xx-xx-xx-035</p>	The bottom line on the onsite display shows the pressure present, here 400 mbar (6 psi).
 <p style="text-align: center; font-size: small;">P01-xxxxxxx-19-xx-xx-xx-036</p>	Use "+" or "-" to switch to the "Confirm" option. The active option is highlighted in black.
 <p style="text-align: center; font-size: small;">P01-xxxxxxx-19-xx-xx-xx-037</p>	Use "E" to assign the value (400 mbar (6 psi)) to the GET URV parameter. The device confirms the calibration and jumps back to the parameter, here GET URV (see next graphic).
 <p style="text-align: center; font-size: small;">P01-xxxxxxx-19-xx-xx-xx-035</p>	Switch to the next parameter with "E".

## 5.5 HistoROM®/M-DAT (optional)

HistoROM®/M-DAT is a memory module which is attached to the electronic insert and fulfills the following functions:

- Back-up copy of configuration data
- Copying configuration data from one transmitter to another transmitter
- Cyclic recording of pressure and sensor-temperature measured values
- Recording diverse events, such as alarms, configuration changes, counters for measuring range undershooting and overshooting for pressure and temperature, overshooting and undershooting the user limits for pressure and temperature, etc.



Warning!

Detach HistoROM®/M-DAT from the electronic insert or attach it to the insert in a de-energized state only.



Note!

- The HistoROM®/M-DAT module may be retrofitted at any time (Order No.: 52027785).
- The HistoROM data and the data in the device are analyzed once a HistoROM®/M-DAT is attached to the electronic insert and power is reestablished to the device. During the analysis, the messages "W702, HistoROM data not consistent" and "W706, Configuration in HistoROM and device not identical" can occur. For measures, see Page → 40, "Messages".

### 5.5.1 Copying configuration data

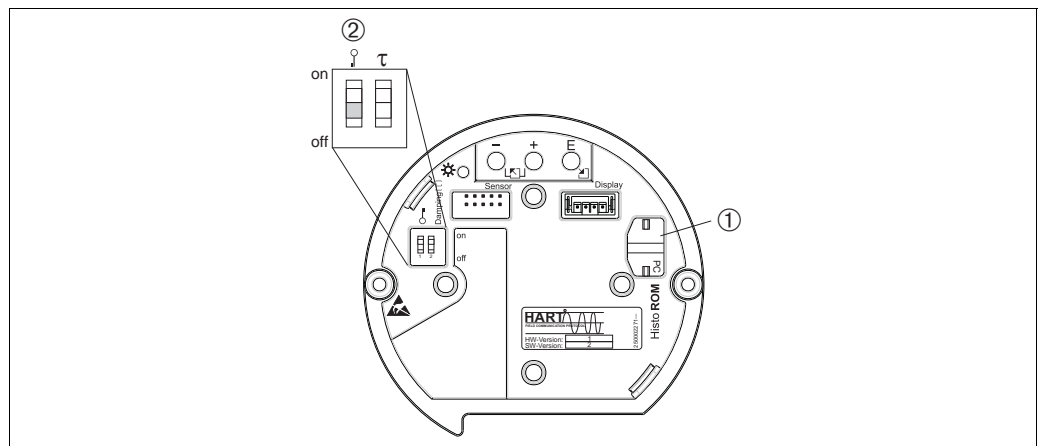

Fig. 20: Electronic insert with optional HistoROM®/M-DAT memory module

- 1 Optional HistoROM®/M-DAT module
- 2 To copy configuration data from the HistoROM®/M-DAT module to a device or from a device to a HistoROM®/M-DAT module, operation must be unlocked (DIP switch 1, "off" position, parameter INSERT PIN NO. = 100). Please also note Page → 32, "Locking/unlocking operation".

#### Onsite operation – onsite display not connected

##### Copying configuration data from a device to a HistoROM®/M-DAT module:



Note!

The operation must be unlocked.

1. Disconnect device from supply voltage.
2. Attach the HistoROM®/M-DAT module to the electronic insert.
3. Reestablish supply voltage to the device.
4. Press the "E" and "-" keys (for at least 3 seconds) until the LED on the electronic insert lights up.
5. Wait approx. 20 seconds. Configuration data are loaded from the device to the HistoROM®/M-DAT. The device is not restarted.
6. Disconnect device from the supply voltage again.
7. Detach memory module.
8. Reestablish supply voltage to the device.

**Copying configuration data from a HistoROM®/M-DAT to a device:**

Note!

The operation must be unlocked.

1. Disconnect device from supply voltage.
2. Attach the HistoROM®/M-DAT module to the electronic insert. Configuration data from another device are stored in the HistoROM®/M-DAT
3. Reestablish supply voltage to the device.
4. Press the "E" and "+" keys (for at least 3 seconds) until the LED on the electronic insert lights up.
5. Wait approx. 20 seconds. All parameters except DEVICE SERIAL No., DEVICE DESIGN., CUST. TAG NUMBER, LONG TAG NUMBER, DESCRIPTION, BUS ADDRESS and the parameters in the POSITION ADJUSTMENT and PROCESS CONNECTION group are loaded into the device by HistoROM®/M-DAT. The device is restarted.
6. Before removing the HistoROM®/M-DAT again from the electronic insert, disconnect the device from the supply voltage.

**Onsite operation via onsite display (optional) or remote operation****Copying configuration data from a device to a HistoROM®/M-DAT module:**

Note!

The operation must be unlocked.

1. Disconnect device from supply voltage.
2. Attach the HistoROM®/M-DAT module to the electronic insert.
3. Reestablish supply voltage to the device.
4. The DOWNLOAD SELECT. parameter setting has no influence on uploading from the device to HistoROM.  
(Menu path: (GROUP SELECTION →) OPERATING MENU → OPERATION)
5. Using the HistoROM CONTROL parameter, select the option "Device → HistoROM" as the data transfer direction.
6. Wait approx. 20 seconds. Configuration data are loaded from the device to the HistoROM®/M-DAT. The device is not restarted.
7. Disconnect device from the supply voltage again.
8. Detach memory module.
9. Reestablish supply voltage to the device.

**Copying configuration data from a HistoROM®/M-DAT to a device:**

Note!

The operation must be unlocked.

1. Disconnect device from supply voltage.
2. Attach the HistoROM®/M-DAT module to the electronic insert. Configuration data from another device are stored in the HistoROM®/M-DAT
3. Reestablish supply voltage to the device.
4. Use the DOWNLOAD SELECT. parameter to select which parameters are to be overwritten (menu path: (GROUP SELECTION →) OPERATING MENU → OPERATION).

The following parameters are overwritten depending on the option selected:

– **Configuration copy (factory setting):**

all parameters except DEVICE SERIAL No., DEVICE DESIGN., CUST. TAG NUMBER, LONG TAG NUMBER, DESCRIPTION, BUS ADDRESS and the parameters in the POSITION ADJUSTMENT, PROCESS CONNECTION, CURR. TRIM (SERVICE/SYSTEM 2), SENSOR TRIM and SENSOR DATA group.

– **Device replacement:**

all parameters except DEVICE SERIAL No., DEVICE DESIGN. and the parameters in the POSITION ADJUSTMENT, PROCESS CONNECTION, CURR. TRIM (SERVICE/SYSTEM 2), SENSOR TRIM and SENSOR DATA group.

– **Electronics replacement:**

all parameters except the parameters in the CURR. TRIM (SERVICE/SYSTEM 2), POSITION ADJUSTMENT and SENSOR DATA group.

Factory setting: Configuration copy

5. Using the HistoROM CONTROL parameter, select the option "HistoROM → Device" as the data transfer direction.  
(Menu path: (GROUP SELECTION →) OPERATING MENU → OPERATION)
6. Wait approx. 20 seconds. Configuration data are loaded from the device to the HistoROM®/M-DAT. The device is restarted.
7. Before removing the HistoROM®/M-DAT again from the electronic insert, disconnect the device from the supply voltage.

## 5.6 Operation via HART handheld terminal

Use the HART handheld terminal to set all parameters all the way along the 4 to 20 mA line via menu operation.



Note!

- See also → 20, "Connecting HART handheld terminal".
- For further information, please refer to the Operating Instructions for the handheld terminal, which can be found in the carrying case of the Field Communicator 375, 475.

## 5.7 Endress+Hauser operating program

FieldCare is an Endress+Hauser asset management tool based on FDT technology. With FieldCare, you can configure all Endress+Hauser devices as well as devices from other manufacturers that support the FDT standard. Hardware and software requirements can be found on the Internet: [www.endress.com](http://www.endress.com) → Search for: FieldCare → FieldCare → Technical Data.

FieldCare supports the following functions:

- Configuration of transmitters in online mode
- Loading and saving device data (upload/download)
- Tank linearization
- HistoROM<sup>®</sup>/M-DAT analysis
- Documentation of the measuring point

Connection options:

- HART via Fieldgate FXA520
- HART via Commubox FXA195 and the USB port of a computer
- Commubox FXA291 with ToF Adapter FXA291 via Service Interface



Note!

- See also → 20, "Connecting the Commubox FXA195".
- Further information on FieldCare can be found on the Internet: <http://www.endress.com> → Download → Search for: FieldCare.

## 5.8 Locking/unlocking operation

Once you have entered all the parameters, you can lock your entries against unauthorized and undesired access.

You have the following possibilities for locking/unlocking the operation:

- Via a DIP switch on the electronic insert, locally on the display.
- Via the onsite display (optional)
- Via digital communication

The symbol on the onsite display indicates that operation is locked. Parameters which refer to how the display appears, e.g. LANGUAGE and DISPLAY CONTRAST can still be altered.



Note!

If operation is locked by means of the DIP switch, you can only unlock operation again by means of the DIP switch. If operation is locked by means of the onsite display or remote operation e.g. FieldCare, you can unlock operation again either by means of the onsite display or remote operation.



The table provides an overview of the locking functions:

Locking via	View/read parameter	Modify/write via <sup>1)</sup>		Unlocking via		
		Onsite display	Remote operation	DIP switch	Onsite display	Remote operation
DIP switch	Yes	No	No	Yes	No	No
Onsite display	Yes	No	No	No	Yes	Yes
Remote operation	Yes	No	No	No	Yes	Yes

1) Parameters which refer to how the display appears, e.g. LANGUAGE and DISPLAY CONTRAST can still be altered.

### 5.8.1 Locking/unlocking operation locally via DIP switch

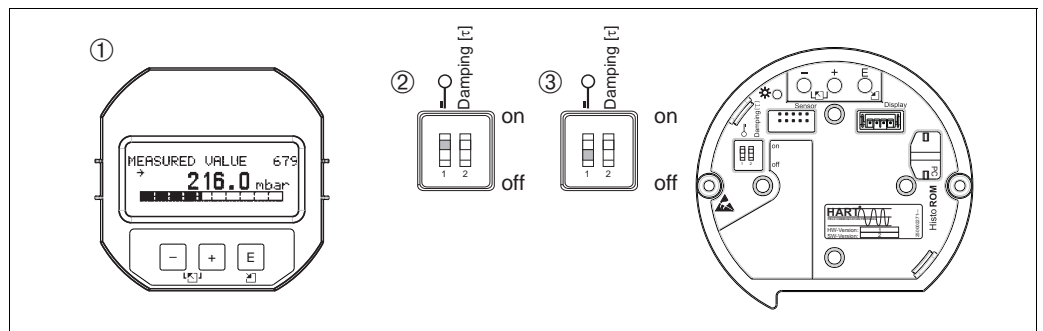

Fig. 21: Position of DIP switch for "hardware locking" on the electronic insert

- 1 If necessary, remove onsite display (optional)
- 2 DIP switch is at "on": operation is locked.
- 3 DIP switch is at "off": operation is unlocked (operation possible)

### 5.8.2 Locking/unlocking operation via onsite display or remote operation

	Description
Locking operation	<ol style="list-style-type: none"> <li>1. Select the INSERT PIN NO. parameter, menu path: OPERATING MENU → OPERATION → INSERT PIN NO.</li> <li>2. To lock operation, enter a number for this parameter between 0 and 9999 that is ≠100.</li> </ol>
Unlocking operation	<ol style="list-style-type: none"> <li>1. Select INSERT PIN NO. parameter.</li> <li>2. To unlock operation, enter "100" for the parameter.</li> </ol>

## 5.9 Factory setting (reset)



By entering a certain code, you can completely, or partially, reset the entries for the parameters to the factory settings. ( For factory settings, refer to Operating Instructions BA0041 3P "Description of device functions"). Enter the code by means of the ENTER RESET CODE parameter (menu path: (GROUP SELECTION →) OPERATING MENU → OPERATION).

There are various reset codes for the device. The following table illustrates which parameters are reset by the particular reset codes. Operation must be unlocked to reset parameters (→  32, "Locking/unlocking operation").



Note!

Any customer-specific configuration carried out by the factory is not affected by a reset (customer-specific configuration remains). If you want to change the customer-specific configuration set at the factory, please contact Endress+Hauser Service.

Reset code	Description and effect
1846	<b>Display reset</b> <ul style="list-style-type: none"> <li>– This reset resets all the parameters which have to do with how the display appears (DISPLAY group).</li> <li>– Any simulation which may be running is ended.</li> <li>– The device is restarted.</li> </ul>
62	<b>PowerUp reset (warm start)</b> <ul style="list-style-type: none"> <li>– This reset resets all the parameters in the RAM. Data are read back anew from the EEPROM (processor is reinitialized).</li> <li>– Any simulation which may be running is ended.</li> <li>– The device is restarted.</li> </ul>
333	<b>User reset</b> <ul style="list-style-type: none"> <li>– This reset resets the following parameters: <ul style="list-style-type: none"> <li>– Function group POSITION ADJUSTMENT</li> <li>– Function group BASIC SETUP, except for the customer-specific units</li> <li>– Function group EXTENDED SETUP</li> <li>– Group OUTPUT</li> <li>– Function group HART DATA: BUS ADDRESS and PREAMBLE NUMBER</li> </ul> </li> <li>– Any simulation which may be running is ended.</li> <li>– The device is restarted.</li> </ul>
7864	<b>Total reset</b> <ul style="list-style-type: none"> <li>– This reset resets the following parameters: <ul style="list-style-type: none"> <li>– Function group POSITION ADJUSTMENT</li> <li>– Function group BASIC SETUP</li> <li>– Function group EXTENDED SETUP</li> <li>– Function group LINEARIZATION (an existing linearization table is erased)</li> <li>– Group OUTPUT</li> <li>– Function group HART DATA</li> <li>– Function group MESSAGES</li> <li>– All configurable messages ("Error" type) are reset to the factory setting. <ul style="list-style-type: none"> <li>→  40, "Messages" and →  47, "Response of outputs to errors".</li> </ul> </li> <li>– Function group USER LIMITS</li> <li>– Function group SYSTEM 2</li> </ul> </li> <li>– Any simulation which may be running is ended.</li> <li>– The device is restarted.</li> </ul>
8888	<b>HistoROM reset</b> <p>The measured value memory and event memory are cleared. During the reset, the HistoROM must be attached to the electronic insert.</p>

## 6 Commissioning



Warning!

- If a pressure smaller than the minimum permitted pressure is present at the device, the messages "E120 Sensor low pressure" and "E727 Sensor pressure error - overrange" are output in succession.
- If a pressure greater than the maximum permitted pressure is present at the device, the messages "E115 Sensor overpressure" and "E727 Sensor pressure error - overrange" are output in succession.
- Messages E727, E115 and E120 are "Error"-type messages and can be configured as a "Warning" or an "Alarm". These messages are configured as "Warning" messages at the factory. This setting prevents the current output from assuming the set alarm current value for applications (e.g. cascade measurement) where the user is consciously aware of the fact that the sensor range can be exceeded.
- We recommend setting messages E727, E115 and E120 to "Alarm" in the following instances:
  - The sensor range does not have to be exceeded for the measuring application.
  - Position adjustment has to be carried out that has to correct a large measured error as a result of the orientation of the device (e.g. devices with a diaphragm seal).



Note!

The device is configured for the Pressure measuring mode as standard. The measuring range and the unit in which the measured value is transmitted correspond to the specifications on the nameplate.

### 6.1 Function check

Carry out a post-installation and a post-connection check as per the checklist before commissioning the device.

- "Post-installation check" checklist → 15.
- "Post-connection check" checklist → 21 .

### 6.2 Selecting language and measuring mode

#### 6.2.1 Onsite operation

The LANGUAGE and MEASURING MODE parameters are located on the top selection level. See also → 26, "General structure of the operating menu".

The following languages are available:

- Deutsch
- English
- Français
- Italiano
- Español
- Nederlands
- Chinese (CHS)
- Japanese (JPN)

The following measuring modes are available:

- Pressure

## 6.2.2 Digital communication

In digital communication, the MEASURING MODE parameter is displayed in the QUICK SETUP menus and in the BASIC SETUP function group (OPERATING MENU → SETTINGS → BASIC SETUP).

The following measuring modes are available:

- Pressure

The LANGUAGE parameter is arranged in the DISPLAY group (OPERATING MENU → DISPLAY).

- Use the LANGUAGE parameter to select the menu language for the onsite display.
- Select the menu language for FieldCare by means of the "Language Button" in the configuration window. Select the menu language for the FieldCare frame via the "Extra" menu → "Options" → "Display" → "Language".

The following languages are available:

- Deutsch
- English
- Français
- Italiano
- Español
- Nederlands
- Chinese (CHS)
- Japanese (JPN)

## 6.3 Position adjustment

Due to the orientation of the device, there may be a shift in the measured value, i.e. when the container is empty or partially filled, the measured value does not display zero. There are three options to choose from when performing position adjustment.

(Menu path: (GROUP SELECTION →) OPERATING MENU → SETTINGS → POSITION ADJUSTMENT)

Parameter name	Description
POS. INPUT VALUE (563) Entry	<p>Position adjustment – the pressure difference between zero (set point) and the measured pressure need not be known. To correct the pressure difference, you need a reference measured value (e. g. from a reference device).</p> <p><b>Example:</b></p> <ul style="list-style-type: none"> <li>– MEASURED VALUE = 0.5 mbar (0.0073 psi)</li> <li>– For the POS. INPUT VALUE parameter, specify the desired set point for the MEASURED VALUE, e.g. 2.0 mbar (0.029 psi). (<math>\text{MEASURED VALUE}_{\text{new}} = \text{POS. INPUT VALUE}</math>)</li> <li>– MEASURED VALUE (after entry for POS. INPUT VALUE) = 2.0 mbar ( 0.029 psi)</li> <li>– The CALIB. OFFSET parameter displays the resulting pressure difference (offset) by which the MEASURED VALUE was corrected. The following applies: <math>\text{CALIB. OFFSET} = \text{MEASURED VALUE}_{\text{old}} - \text{POS. INPUT VALUE}</math>, here: <math>\text{CALIB. OFFSET} = 0.5 \text{ mbar (0.0073 psi)} - 2.0 \text{ mbar (0.029 psi)} = -1.5 \text{ mbar (0.022 psi)}</math></li> <li>– The current value is also corrected.</li> </ul> <p><b>Factory setting:</b> 0.0</p>
CALIB. OFFSET (319) Entry	<p>Position adjustment – the pressure difference between zero (set point) and the measured pressure is known.</p> <p><b>Example:</b></p> <ul style="list-style-type: none"> <li>– MEASURED VALUE = 2.2 mbar (0.032 psi)</li> <li>– Via the CALIB. OFFSET parameter, enter the value by which the MEASURED VALUE should be corrected. To correct the MEASURED VALUE to 0.0 mbar, you must enter the value 2.2 here. (<math>\text{MEASURED VALUE}_{\text{new}} = \text{MEASURED VALUE}_{\text{old}} - \text{CALIB. OFFSET}</math>)</li> <li>– MEASURED VALUE (after entry for calib. offset) = 0.0 mbar</li> <li>– The current value is also corrected.</li> </ul> <p><b>Factory setting:</b> 0.0</p>

## 6.4 Pressure measurement

### 6.4.1 Information on pressure measurement



Note!

- There is a Quick Setup menu for the measuring mode Pressure which guides you through the most important basic functions. With the setting in the MEASURING MODE parameter, you specify which Quick Setup menu should be displayed. See also → 35, "Selecting language and measuring mode".
- For a detailed description of the parameters, see Operating Instructions BA00413P "Description of device functions"
  - Table 6, POSITION ADJUSTMENT
  - Table 7, BASIC SETUP
  - Table 15, EXTENDED SETUP
- For differential pressure measurement, select the "Pressure" option by means of the MEASURING MODE parameter. The operating menu is structured accordingly.

### 6.4.2 Quick Setup menu for Pressure measuring mode

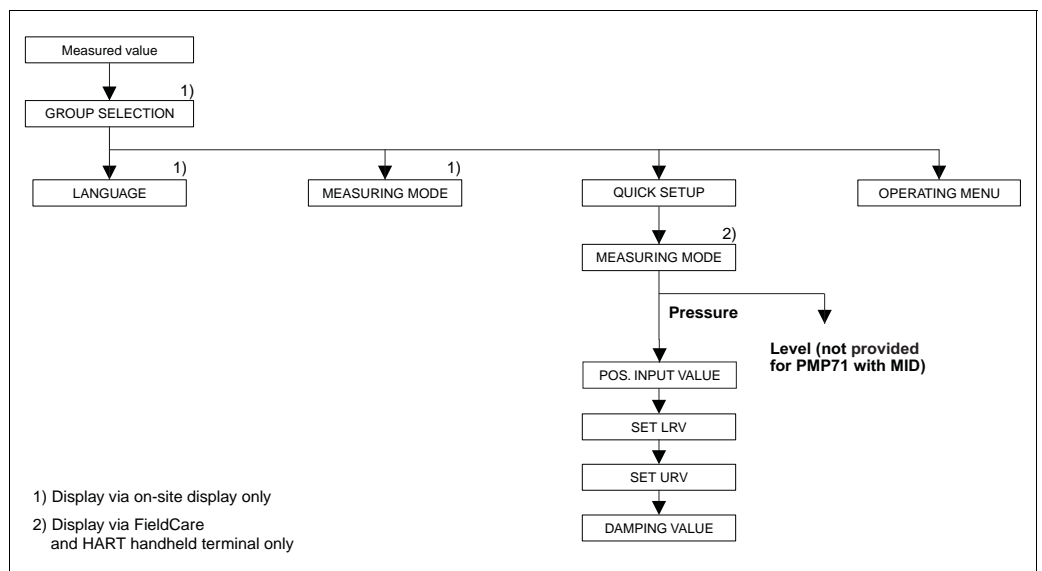

Fig. 22: Quick Setup menu for Pressure measuring mode

Onsite operation	Digital communication
<p><b>Measured value display</b> Switch from the measured value display to GROUP SELECTION with <math>\square</math>.</p>	<p><b>Measured value display</b> Select QUICK SETUP menu.</p>
<p><b>GROUP SELECTION</b> Select MEASURING MODE parameter.</p>	<p><b>MEASURING MODE</b> Select "Pressure" option.</p>
<p><b>MEASURING MODE</b> Select "Pressure" option.</p>	
<p><b>GROUP SELECTION</b> Select QUICK SETUP menu.</p>	<p><b>POS. INPUT VALUE</b> Due to orientation of the device, there may be a shift in the measured value. For the POS. INPUT VALUE parameter, specify the desired set point for the MEASURED VALUE.</p>
<p><b>POS. INPUT VALUE</b> Due to orientation of the device, there may be a shift in the measured value. For the POS. INPUT VALUE parameter, specify the desired set point for the MEASURED VALUE.</p>	

Onsite operation	Digital communication
<p><b>SET LRV</b> Set the measuring range (enter 4 mA value). Specify a pressure value for the lower current value (4 mA value). A reference pressure does not have to be present at the device.</p>	<p><b>SET LRV</b> Set the measuring range (enter 4 mA value). Specify a pressure value for the lower current value (4 mA value). A reference pressure does not have to be present at the device.</p>
<p><b>SET URV</b> Set the measuring range (enter 20 mA value). Specify a pressure value for the upper current value (20 mA value). A reference pressure does not have to be present at the device.</p>	<p><b>SET URV</b> Set the measuring range (enter 20 mA value). Specify a pressure value for the upper current value (20 mA value). A reference pressure does not have to be present at the device.</p>
<p><b>DAMPING TIME</b> Enter damping time (time constant <math>\tau</math>). The damping affects the speed at which all subsequent elements, such as the onsite display, measured value and current output react to a change in the pressure.</p>	<p><b>DAMPING TIME</b> Enter damping time (time constant <math>\tau</math>). The damping affects the speed at which all subsequent elements, such as the onsite display, measured value and current output react to a change in the pressure.</p>



Note!

For onsite operation, see also:

- 24, "Function of the operating elements – onsite display connected" and
- 26, "Onsite operation – onsite display connected".

## 6.5 Lead sealing plan

Lead sealing of the housing cover is provided for use in applications subject to custody transfer regulations:

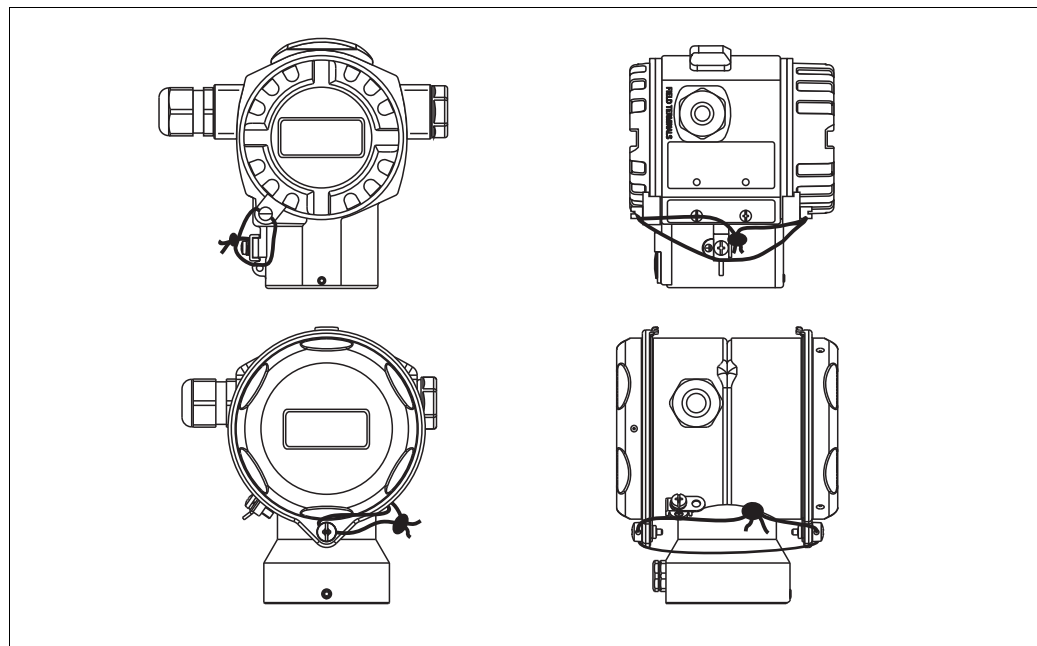

P01-MIDxxxxx-19-xx-xx-xx-031

## 7 Maintenance

Keep the pressure compensation and GORE-TEX® filter (1) free from contamination and water.

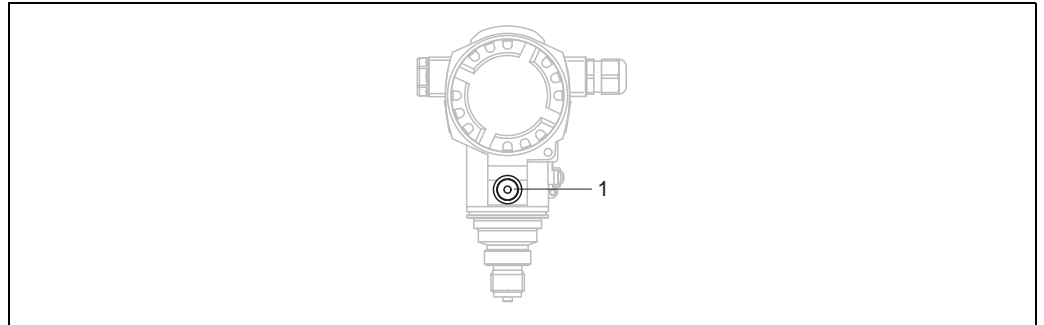

P01-PMC71xxx-17-xx-xx-xx-001

### 7.1 Exterior cleaning

Please note the following points when cleaning the device:

- The cleaning agents used should not corrode the surface and the seals.
- Mechanical damage to the process isolating diaphragm, e.g. due to pointed objects, must be avoided.
- Observe the degree of protection. See the nameplate if necessary (→ 6).

## 8 Troubleshooting

### 8.1 Messages



The following table lists all the possible messages that can occur.

The device makes a distinction between the error types "Alarm", "Warning" and "Error". You may specify whether the device should react as if for an "Alarm" or "Warning" for "Error" messages. See "Message type/NA 64" column and →  47, "Response of outputs to errors".

In addition, the "Error type/NA 64" column classifies the messages in accordance with NAMUR Recommendation NA 64:

- Break down: indicated with "B"
- Maintenance need: indicated with "C" (check request)
- Function check: indicated with "I" (in service)

Error message display on the onsite display:

- The measured value display shows the message with the highest priority. See the "Priority" column.
- The ALARM STATUS parameter shows all the messages present in descending order of priority. You can scroll through all the messages present with the  key or  key.



Message display via digital communication:

The ALARM STATUS parameter shows the message with the highest priority. See the "Priority" column.



Note!

- If the device detects a defect in the onsite display during initialization, special error messages are generated. For error messages, see →  46, "Onsite display error messages".
- For support and further information, please contact Endress+Hauser Service.
- See also "Repair", "Repair of Ex-certified devices" and "Spare Parts".

Code	Error type/ NA 64	Message/description	Cause	Measure	Priority
101 (A101)	Alarm B	B>Sensor electronic EEPROM error	<ul style="list-style-type: none"> <li>– Electromagnetic effects are greater than specifications in the technical data. (→  52) This message normally only appears briefly.</li> <li>– Sensor defective.</li> </ul>	<ul style="list-style-type: none"> <li>– Wait a few minutes.</li> <li>– Restart the device. Perform reset (Code 62).</li> <li>– Block off electromagnetic effects or eliminate source of disturbance.</li> <li>– Replace sensor.</li> </ul>	17
102 (W102)	Warning C	C>Checksum error in EEPROM: peakhold segment	<ul style="list-style-type: none"> <li>– Main electronics defective. Correct measurement can continue as long as you do not need the peak hold indicator function.</li> </ul>	<ul style="list-style-type: none"> <li>– Replace main electronics.</li> </ul>	53
106 (W106)	Warning C	C>Downloading - please wait	<ul style="list-style-type: none"> <li>– Downloading.</li> </ul>	<ul style="list-style-type: none"> <li>– Wait for download to complete.</li> </ul>	52
110 (A110)	Alarm B	B>Checksum error in EEPROM: configuration segment	<ul style="list-style-type: none"> <li>– The supply voltage is disconnected when writing.</li> <li>– Electromagnetic effects are greater than specifications in the technical data. (→  52)</li> <li>– Main electronics defective.</li> </ul>	<ul style="list-style-type: none"> <li>– Reestablish supply voltage. Perform reset (Code 7864) if necessary. Carry out calibration again.</li> <li>– Block off electromagnetic effects or eliminate sources of disturbance.</li> <li>– Replace main electronics.</li> </ul>	6
113 (A113)	Alarm B	B>ROM failure in transmitter electronic	<ul style="list-style-type: none"> <li>– Main electronics defective.</li> </ul>	<ul style="list-style-type: none"> <li>– Replace main electronics.</li> </ul>	1
115 (E115)	Error B Factory setting: Warning	B>Sensor overpressure	<ul style="list-style-type: none"> <li>– Overpressure present.</li> <li>– Sensor defective.</li> </ul>	<ul style="list-style-type: none"> <li>– Reduce pressure until message disappears.</li> <li>– Replace sensor.</li> </ul>	29



Code	Error type/ NA 64	Message/description	Cause	Measure	Priority
116 (W116)	Warning C	C>Download error, repeat download	<ul style="list-style-type: none"> <li>– The file is defective.</li> <li>– During the download, the data are not correctly transmitted to the processor, e.g. because of open cable connections, spikes (ripple) on the supply voltage or electromagnetic effects.</li> </ul>	<ul style="list-style-type: none"> <li>– Use another file.</li> <li>– Check cable connection PC – transmitter.</li> <li>– Block off electromagnetic effects or eliminate sources of disturbance.</li> <li>– Perform reset (Code 7864) and carry out calibration again.</li> <li>– Repeat download.</li> </ul>	36
120 (E120)	Error B Factory setting: Warning	B>Sensor low pressure	<ul style="list-style-type: none"> <li>– Pressure too low.</li> <li>– Sensor defective.</li> </ul>	<ul style="list-style-type: none"> <li>– Increase pressure until message disappears.</li> <li>– Replace sensor.</li> </ul>	30
121 (A121)	Alarm B	B>Checksum error in factory segment of EEPROM	<ul style="list-style-type: none"> <li>– Main electronics defective.</li> </ul>	<ul style="list-style-type: none"> <li>– Replace main electronics.</li> </ul>	5
122 (A122)	Alarm B	B>Sensor not connected	<ul style="list-style-type: none"> <li>– Cable connection sensor –main electronics disconnected.</li> <li>– Electromagnetic effects are greater than specifications in the technical data. (→ 52)</li> <li>– Main electronics defective.</li> <li>– Sensor defective.</li> </ul>	<ul style="list-style-type: none"> <li>– Check cable connection and repair if necessary.</li> <li>– Block off electromagnetic effects or eliminate source of disturbance.</li> <li>– Replace main electronics.</li> <li>– Replace sensor.</li> </ul>	13
130 (A130)	Alarm B	B>EEPROM is defective.	<ul style="list-style-type: none"> <li>– Main electronics defective.</li> </ul>	<ul style="list-style-type: none"> <li>– Replace main electronics.</li> </ul>	10
131 (A131)	Alarm B	B>Checksum error in EEPROM: min/max segment	<ul style="list-style-type: none"> <li>– Main electronics defective.</li> </ul>	<ul style="list-style-type: none"> <li>– Replace main electronics.</li> </ul>	9
132 (A132)	Alarm B	B>Checksum error in totalizer EEPROM	<ul style="list-style-type: none"> <li>– Main electronics defective.</li> </ul>	<ul style="list-style-type: none"> <li>– Replace main electronics.</li> </ul>	7
133 (A133)	Alarm B	B>Checksum error in History EEPROM	<ul style="list-style-type: none"> <li>– An error occurred when writing.</li> <li>– Main electronics defective.</li> </ul>	<ul style="list-style-type: none"> <li>– Perform reset (Code 7864) and carry out calibration again.</li> <li>– Replace main electronics.</li> </ul>	8
602 (W602)	Warning C	C>Linearization curve not monotone	<ul style="list-style-type: none"> <li>– The linearization table is not monotonic increasing or decreasing.</li> </ul>	<ul style="list-style-type: none"> <li>– Add to or correct linearization table. Then accept linearization table again.</li> </ul>	57
604 (W604)	Warning C	C>Linearization table not valid. Less than 2 points or points too close	<ul style="list-style-type: none"> <li>– The linearization table consists of less than 2 points.</li> <li>– At least 2 points in the linearization table are too close together. A minimum gap of 0.5 % of the span must be maintained between two points. Spans for the "Pressure linearized" option: HYDR. PRESS MAX. – HYDR. PRESS MIN.; TANK CONTENT MAX. – TANK CONTENT MIN. Spans for the "Height linearized" option: LEVEL MAX. – LEVEL MIN.; TANK CONTENT MAX. – TANK CONTENT MIN.</li> </ul>	<ul style="list-style-type: none"> <li>– Add to linearization table. If necessary, confirm linearization table again.</li> <li>– Correct linearization table and accept again.</li> </ul>	58
613 (W613)	Warning I	I>Simulation is active	<ul style="list-style-type: none"> <li>– Simulation is switched on, i.e. the device is not measuring at present.</li> </ul>	<ul style="list-style-type: none"> <li>– Switch off simulation.</li> </ul>	60

Code	Error type/ NA 64	Message/description	Cause	Measure	Priority
620 (E620)	Error C Factory setting: Warning	C>Current output out of range	The current is outside the permitted range 3.8 to 20.5 mA. – The pressure applied is outside the set measuring range (but within the sensor range).  – Loose connection at sensor cable	– Check pressure applied, reconfigure measuring range if necessary. (See also Operating Instructions BA00413P, Section 4 and 5 or these Operating Instructions) – Perform reset (Code 7864) and carry out calibration again.  – Wait a short period of time and tighten the connection, or avoid loose connection.	49
700 (W700)	Warning C	C>Last configuration not stored	– An error occurred when writing or reading configuration data or the power supply was disconnected.  – Main electronics defective.	– Perform reset (Code 7864) and carry out calibration again.  – Replace main electronics.	54
701 (W701)	Warning C	C>Measuring chain config. exceeds sensor range	– The calibration carried out would result in the sensor nominal operating range being undershot or overshoot.	– Carry out calibration again.	50
702 (W702)	Warning C	C>HistoROM data not consistent.	– Data were not written correctly to the HistoROM, e.g. if the HistoROM was detached during the writing process.  – HistoROM does not have any data.	– Repeat upload. – Perform reset (Code 7864) and carry out calibration again.  – Copy suitable data to the HistoROM. (See also → 29, "Copying configuration data".)	55
703 (A703)	Alarm B	B>Measurement error	– Fault in the main electronics.  – Main electronics defective.	– Briefly disconnect device from the power supply.  – Replace main electronics.	22
704 (A704)	Alarm B	B>Measurement error	– Fault in the main electronics.  – Main electronics defective.	– Briefly disconnect device from the power supply.  – Replace main electronics.	12
705 (A705)	Alarm B	B>Measurement error	– Fault in the main electronics.  – Main electronics defective.	– Briefly disconnect device from the power supply.  – Replace main electronics.	21
706 (W706)	Warning C	C>Configuration in HistoROM and device not identical	– Configuration (parameters) in the HistoROM and in the device is not identical.	– Copy data from the device to the HistoROM. (See also → 29, "Copying configuration data".) – Copy data from the HistoROM to the device. (See also → 29, "Copying configuration data".) The message remains if the HistoROM and the device have different software versions. The message goes out if you copy the data from the device to the HistoROM. – Device reset codes such as 7864 do not have any effect on the HistoROM. That means that if you perform a reset, the configurations in the HistoROM and in the device may not be the same.	59
707 (A707)	Alarm B	B>X-VAL. of lin. table out of edit limits.	– At least one X-VALUE in the linearization table is either below the value for HYDR. PRESS MIN. or MIN. LEVEL or above the value for HYDR. PRESS. MAX. or LEVEL MAX.	– Carry out calibration again. (See also Operating Instructions BA00413P, Section 5 or these Operating Instructions)	38

Code	Error type/ NA 64	Message/description	Cause	Measure	Priority
710 (W710)	Warning C	B>Set span too small. Not allowed.	<ul style="list-style-type: none"> <li>– Values for calibration (e.g. lower-range value and upper-range value) are too close together.</li> <li>– The sensor was replaced and the customer-specific configuration does not suit the sensor.</li> <li>– Unsuitable download carried out.</li> </ul>	<ul style="list-style-type: none"> <li>– Adjust calibration to suit sensor. (See also Operating Instructions BA00413P, parameter description MINIMUM SPAN or these Operating Instructions)</li> <li>– Adjust calibration to suit sensor.</li> <li>– Replace sensor with a suitable sensor.</li> <li>– Check configuration and perform download again.</li> </ul>	51
711 (A711)	Alarm B	B>LRV or URV out of edit limits	<ul style="list-style-type: none"> <li>– Lower-range value and/or upper-range value undershoot or overshoot the sensor range limits.</li> <li>– The sensor was replaced and the customer-specific configuration does not suit the sensor.</li> <li>– Unsuitable download carried out.</li> </ul>	<ul style="list-style-type: none"> <li>– Reconfigure lower-range value and/or upper-range value to suit the sensor. Pay attention to position factor.</li> <li>– Reconfigure lower-range value and/or upper-range value to suit the sensor. Pay attention to position factor.</li> <li>– Replace sensor with a suitable sensor.</li> <li>– Check configuration and perform download again.</li> </ul>	37
713 (A713)	Alarm B	B>100% POINT level out of edit limits	<ul style="list-style-type: none"> <li>– The sensor was replaced.</li> </ul>	<ul style="list-style-type: none"> <li>– Carry out calibration again.</li> </ul>	39
715 (E715)	Error C Factory setting: Warning	C>Sensor over temperature	<ul style="list-style-type: none"> <li>– The temperature measured in the sensor is greater than the upper nominal temperature of the sensor. (See also Operating Instructions BA00413P, parameter description Tmax SENSOR or these Operating Instructions)</li> <li>– Unsuitable download carried out.</li> </ul>	<ul style="list-style-type: none"> <li>– Reduce process temperature/ambient temperature.</li> <li>– Check configuration and perform download again.</li> </ul>	32
716 (E716)	Error B Factory setting: Alarm	B>Process isolating diaphragm broken	<ul style="list-style-type: none"> <li>– Sensor defective.</li> </ul>	<ul style="list-style-type: none"> <li>– Replace sensor.</li> <li>– Reduce pressure.</li> </ul>	24
717 (E717)	Error C Factory setting: Warning	C>Transmitter over temperature	<ul style="list-style-type: none"> <li>– The temperature measured in the electronics is greater than the upper nominal temperature of the electronics (+88 °C (+190 °F)).</li> <li>– Unsuitable download carried out.</li> </ul>	<ul style="list-style-type: none"> <li>– Reduce ambient temperature.</li> <li>– Check configuration and perform download again.</li> </ul>	34
718 (E718)	Error C Factory setting: Warning	C>Transmitter under temperature	<ul style="list-style-type: none"> <li>– The temperature measured in the electronics is less than the lower nominal temperature of the electronics (–43 °C (–45 °F)).</li> <li>– Unsuitable download carried out.</li> </ul>	<ul style="list-style-type: none"> <li>– Increase ambient temperature. Insulate device if necessary.</li> <li>– Check configuration and perform download again.</li> </ul>	35
719 (A719)	Alarm B	B>Y-VAL of lin. table out of edit limits	<ul style="list-style-type: none"> <li>– At least one Y-VALUE in the linearization table is below the MIN. TANK CONTENT or above the MAX. TANK CONTENT.</li> </ul>	<ul style="list-style-type: none"> <li>– Carry out calibration again. (See also Operating Instructions BA00413P, Section 5 or these Operating Instructions)</li> </ul>	40

Code	Error type/ NA 64	Message/description	Cause	Measure	Priority
720 (E720)	Error C Factory setting: Warning	C>Sensor under temperature	<ul style="list-style-type: none"> <li>- The temperature measured in the sensor is smaller than the lower nominal temperature of the sensor. (See also Operating Instructions BA00413P, parameter description Tmin SENSOR or these Operating Instructions)</li> <li>- Unsuitable download carried out.</li> <li>- Loose connection at sensor cable</li> </ul>	<ul style="list-style-type: none"> <li>- Increase process temperature/ ambient temperature.</li> <li>- Check configuration and perform download again.</li> <li>- Wait a short period of time and tighten the connection, or avoid loose connection.</li> </ul>	33
721 (A721)	Alarm B	B>ZERO POSITION level out of edit limits	<ul style="list-style-type: none"> <li>- LEVEL MIN or LEVEL MAX has been changed.</li> </ul>	<ul style="list-style-type: none"> <li>- Perform reset (Code 2710) and carry out calibration again.</li> </ul>	41
722 (A722)	Alarm B	B>EMPTY CALIB. or FULL CALIB. out of edit limits	<ul style="list-style-type: none"> <li>- LEVEL MIN or LEVEL MAX has been changed.</li> </ul>	<ul style="list-style-type: none"> <li>- Perform reset (Code 2710) and carry out calibration again.</li> </ul>	42
723 (A723)	Alarm B	B>MAX. FLOW out of edit limits	<ul style="list-style-type: none"> <li>- FLOW-MEAS. TYPE has been changed.</li> </ul>	<ul style="list-style-type: none"> <li>- Carry out calibration again.</li> </ul>	43
725 (A725)	Alarm B	B>Sensor connection error, cycle disturbance	<ul style="list-style-type: none"> <li>- Electromagnetic effects are greater than specifications in the technical data. (→ See Kap. 9.)</li> <li>- Setscrew loose.</li> <li>- Sensor or main electronics defective.</li> </ul>	<ul style="list-style-type: none"> <li>- Block off electromagnetic effects or eliminate source of disturbance.</li> <li>- Tighten setscrew with a torque of 1 Nm (0.74 lbf ft) (see Kap. 3.3.4).</li> <li>- Replace sensor or main electronics.</li> </ul>	25
726 (E726)	Error C Factory setting: Warning	C>Sensor temperature error - overrange	<ul style="list-style-type: none"> <li>- Electromagnetic effects are greater than specifications in the technical data. (→ 52)</li> <li>- Process temperature is outside permitted range.</li> <li>- Sensor defective.</li> </ul>	<ul style="list-style-type: none"> <li>- Block off electromagnetic effects or eliminate source of disturbance.</li> <li>- Check temperature present, reduce or increase if necessary.</li> <li>- If the process temperature is within the permitted range, replace sensor.</li> </ul>	31
727 (E727)	Error C Factory setting: Warning	C>Sensor pressure error - overrange	<ul style="list-style-type: none"> <li>- Electromagnetic effects are greater than specifications in the technical data. (→ 52)</li> <li>- Pressure is outside permitted range.</li> <li>- Sensor defective.</li> </ul>	<ul style="list-style-type: none"> <li>- Block off electromagnetic effects or eliminate source of disturbance.</li> <li>- Check pressure present, reduce or increase if necessary.</li> <li>- If the pressure is within the permitted range, replace sensor.</li> </ul>	28
728 (A728)	Alarm B	B>RAM error	<ul style="list-style-type: none"> <li>- Fault in the main electronics.</li> <li>- Main electronics defective.</li> </ul>	<ul style="list-style-type: none"> <li>- Briefly disconnect device from the power supply.</li> <li>- Replace main electronics.</li> </ul>	2
729 (A729)	Alarm B	B>RAM error	<ul style="list-style-type: none"> <li>- Fault in the main electronics.</li> <li>- Main electronics defective.</li> </ul>	<ul style="list-style-type: none"> <li>- Briefly disconnect device from the power supply.</li> <li>- Replace main electronics.</li> </ul>	3

Code	Error type/ NA 64	Message/description	Cause	Measure	Priority
730 (E730)	Error C Factory setting; Warning	C>LRV user limits exceeded	<ul style="list-style-type: none"> <li>– Pressure measured value has undershot the value specified for the Pmin ALARM WINDOW parameter.</li> <li>– Loose connection at sensor cable</li> </ul>	<ul style="list-style-type: none"> <li>– Check system/pressure measured value.</li> <li>– Change value for Pmin ALARM WINDOW if necessary. (See also Operating Instructions BA00413P, parameter description Pmin ALARM WINDOW or these Operating Instructions)</li> <li>– Wait a short period of time and tighten the connection, or avoid loose connection.</li> </ul>	46
731 (E731)	Error C Factory setting; Warning	C>URV user limits exceeded	<ul style="list-style-type: none"> <li>– Pressure measured value has overshoot the value specified for the Pmax ALARM WINDOW parameter.</li> </ul>	<ul style="list-style-type: none"> <li>– Check system/pressure measured value.</li> <li>– Change value for Pmax ALARM WINDOW if necessary. (See also Operating Instructions BA00413P, parameter description Pmax ALARM WINDOW or these Operating Instructions)</li> </ul>	45
732 (E732)	Error C Factory setting; Warning	C>LRV Temp. user limits exceeded	<ul style="list-style-type: none"> <li>– Temperature measured value has undershot the value specified for the Tmin ALARM WINDOW parameter.</li> <li>– Loose connection at sensor cable</li> </ul>	<ul style="list-style-type: none"> <li>– Check system/temperature measured value.</li> <li>– Change value for Tmin ALARM WINDOW if necessary. (See also Operating Instructions BA00413P, parameter description Tmin ALARM WINDOW or these Operating Instructions)</li> <li>– Wait a short period of time and tighten the connection, or avoid loose connection.</li> </ul>	48
733 (E733)	Error C Factory setting; Warning	C>URV Temp. User limits exceeded	<ul style="list-style-type: none"> <li>– Temperature measured value has overshoot the value specified for the Tmax ALARM WINDOW parameter.</li> </ul>	<ul style="list-style-type: none"> <li>– Check system/temperature measured value.</li> <li>– Change value for Tmax ALARM WINDOW if necessary. (See also Operating Instructions BA00413P, parameter description Tmax ALARM WINDOW or these Operating Instructions)</li> </ul>	47
736 (A736)	Alarm B	B>RAM error	<ul style="list-style-type: none"> <li>– Fault in the main electronics.</li> <li>– Main electronics defective.</li> </ul>	<ul style="list-style-type: none"> <li>– Briefly disconnect device from the power supply.</li> <li>– Replace main electronics.</li> </ul>	4
737 (A737)	Alarm B	B>Measurement error	<ul style="list-style-type: none"> <li>– Fault in the main electronics.</li> <li>– Main electronics defective.</li> </ul>	<ul style="list-style-type: none"> <li>– Briefly disconnect device from the power supply.</li> <li>– Replace main electronics.</li> </ul>	20
738 (A738)	Alarm B	B>Measurement error	<ul style="list-style-type: none"> <li>– Fault in the main electronics.</li> <li>– Main electronics defective.</li> </ul>	<ul style="list-style-type: none"> <li>– Briefly disconnect device from the power supply.</li> <li>– Replace main electronics.</li> </ul>	19
739 (A739)	Alarm B	B>Measurement error	<ul style="list-style-type: none"> <li>– Fault in the main electronics.</li> <li>– Main electronics defective.</li> </ul>	<ul style="list-style-type: none"> <li>– Briefly disconnect device from the power supply.</li> <li>– Replace main electronics.</li> </ul>	23
741 (A741)	Alarm B	B>TANK HEIGHT out of edit limits	<ul style="list-style-type: none"> <li>– LEVEL MIN or LEVEL MAX has been changed.</li> </ul>	<ul style="list-style-type: none"> <li>– Perform reset (Code 2710) and carry out calibration again.</li> </ul>	44

Code	Error type/ NA 64	Message/description	Cause	Measure	Priority
742 (A742)	Alarm B	B>Sensor connection error (upload)	<ul style="list-style-type: none"> <li>- Electromagnetic effects are greater than specifications in the technical data. (→ 52) This message normally only appears briefly.</li> <li>- Cable connection sensor –main electronics disconnected.</li> <li>- Sensor defective.</li> </ul>	<ul style="list-style-type: none"> <li>- Wait a few minutes.</li> <li>- Perform reset (Code 7864) and carry out calibration again.</li> <li>- Check cable connection and repair if necessary.</li> <li>- Replace sensor.</li> </ul>	18
743 (E743)	Alarm B	B>Electronic PCB error during initialization	<ul style="list-style-type: none"> <li>- Electromagnetic effects are greater than specifications in the technical data. (→ 52) This message normally only appears briefly.</li> <li>- Main electronics defective.</li> </ul>	<ul style="list-style-type: none"> <li>- Wait a few minutes.</li> <li>- Restart the device. Perform reset (Code 62).</li> <li>- Replace main electronics.</li> </ul>	14
744 (A744)	Alarm B	B>Main electronic PCB error	<ul style="list-style-type: none"> <li>- Electromagnetic effects are greater than specifications in the technical data. (→ 52)</li> <li>- Main electronics defective.</li> </ul>	<ul style="list-style-type: none"> <li>- Restart the device. Perform reset (Code 62).</li> <li>- Block off electromagnetic effects or eliminate source of disturbance.</li> <li>- Replace main electronics.</li> </ul>	11
745 (W745)	Warning C	C>Sensor data unknown	<ul style="list-style-type: none"> <li>- Sensor does not suit the device (electronic sensor nameplate). Device continues measuring.</li> </ul>	<ul style="list-style-type: none"> <li>- Replace sensor with a suitable sensor.</li> </ul>	56
746 (W746)	Warning C	C>Sensor connection error - initializing	<ul style="list-style-type: none"> <li>- Electromagnetic effects are greater than specifications in the technical data. (→ 52) This message normally only appears briefly.</li> <li>- Overpressure or low pressure present.</li> </ul>	<ul style="list-style-type: none"> <li>- Wait a few minutes.</li> <li>- Restart the device. Perform reset (Code 7864).</li> <li>- Block off electromagnetic effects or eliminate source of disturbance.</li> <li>- Reduce or increase pressure.</li> </ul>	26
747 (A747)	Alarm B	B>Sensor software not compatible to electronics	<ul style="list-style-type: none"> <li>- Sensor does not suit the device (electronic sensor nameplate).</li> </ul>	<ul style="list-style-type: none"> <li>- Replace sensor with a suitable sensor.</li> </ul>	16
748 (A748)	Alarm B	B>Memory failure in signal processor	<ul style="list-style-type: none"> <li>- Electromagnetic effects are greater than specifications in the technical data. (→ 52)</li> <li>- Main electronics defective.</li> </ul>	<ul style="list-style-type: none"> <li>- Block off electromagnetic effects or eliminate source of disturbance.</li> <li>- Replace main electronics.</li> </ul>	15



### 8.1.1 Onsite display error messages

If the device detects a defect in the onsite display during initialization, the following error messages can be displayed:

Message	Measure
Initialization, VU Electr. Defect A110	Exchange onsite display.
Initialization, VU Electr. Defect A114	
Initialization, VU Electr. Defect A281	
Initialization, VU Checksum Err. A110	
Initialization, VU Checksum Err. A112	
Initialization, VU Checksum Err. A171	

## 8.2 Response of outputs to errors

The device makes a distinction between the error types Alarm, Warning and Error. See the following table and →  40, "Messages".

Output	A (Alarm)	W (Warning)	E (Error: Alarm/Warning)
Current output	<ul style="list-style-type: none"> <li>– Device does not continue measuring.</li> <li>– The current output assumes the value specified via the OUTPUT FAIL MODE<sup>1)</sup>, ALT. CURR. OUTPUT<sup>1</sup> and SET MAX. ALARM.<sup>1</sup></li> </ul> See also the following section: "Configuring current output for an alarm".	Device continues measuring.	For this error, you can enter whether the device should react as in the event of an alarm or as in the event of a warning. See corresponding "Alarm" or "Warning" column. (See also Operating Instructions BA00413P, parameter description SELECT ALARM TYPE or these Operating Instructions)
Bar graph (onsite display)	The bar graph adopts the value defined by the OUTPUT FAIL MODE <sup>1</sup> parameter.	The bar graph adopts the value which corresponds to the current value.	See this table, "Alarm" or "Warning" column, depending on the option selected.
Onsite display	<ul style="list-style-type: none"> <li>– The measured value and message are displayed alternately</li> <li>– Measured value display:  -symbol is permanently displayed.</li> </ul> Message display <ul style="list-style-type: none"> <li>– 3-digit number such as A122 and description</li> </ul>	<ul style="list-style-type: none"> <li>– The measured value and message are displayed alternately</li> <li>– Measured value display:  -symbol flashes.</li> </ul> Message display: <ul style="list-style-type: none"> <li>– 3-digit number such as W613 and description</li> </ul>	<ul style="list-style-type: none"> <li>– The measured value and message are displayed alternately</li> <li>– Measured value display: see corresponding "Alarm" or "Warning" column</li> </ul> Message display: <ul style="list-style-type: none"> <li>– 3-digit number such as E731 and description</li> </ul>
Remote operation (FieldCare or HART handheld terminal)	In the case of an alarm, the ALARM STATUS <sup>2)</sup> parameter displays a 3-digit number such as 122 for "Sensor not connected".	In the case of a warning, the ALARM STATUS <sup>2)</sup> parameter displays a 3-digit number such as 613 for "Simulation is active".	In the case of an error, the ALARM STATUS <sup>2)</sup> parameter displays a 3-digit number such as 731 for "URV user limits exceeded".

- 1) Menu path: (GROUP SELECTION →) OPERATING MENU → OUTPUT
- 2) Menu path: (GROUP SELECTION →) OPERATING MENU → MESSAGES

### 8.2.1 Configuring current output for an alarm

You can configure the current output for the event of an alarm by means of the OUTPUT FAIL MODE, ALT. CURR. OUTPUT and SET MAX. ALARM parameters. These parameters are displayed in the OUTPUT group (menu path: (GROUP SELECTION →) OPERATING MENU → OUTPUT).

In the event of an alarm, the current and the bar graph assume the value entered with the OUTPUT FAIL MODE parameter.

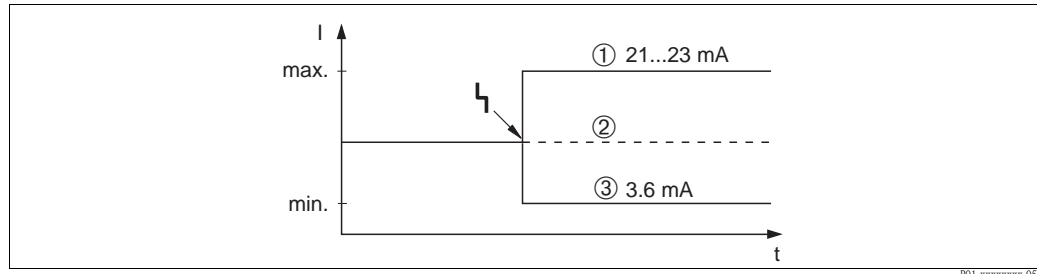

Fig. 23: Current output in the event of an alarm

Options:

- 1 Max. alarm (110%): can be set between 21 and 23 mA via the SET MAX. ALARM parameter
- 2 Hold meas. value: last measured value is kept
- 3 Min. alarm (-10%): 3.6 mA

Factory setting:

- OUTPUT FAIL MODE = max. alarm (110%)
- SET MAX. ALARM = 22 mA

Use the ALT. CURR. OUTPUT parameter to set the current output value for the error messages E 120 "Sensor low pressure" and E 115 "Sensor overpressure". You have the following options:

- Normal: the current output assumes the value set via the OUTPUT FAIL MODE and SET MAX. ALARM parameters.
- NAMUR
  - Lower sensor limit undershot (E 120 "Sensor low pressure"): 3.6 mA
  - Upper sensor limit overshoot (E 115 "Sensor overpressure"): current output assumes the value set via the SET MAX ALARM parameter.





Factory setting:

ALT. CURR. OUTPUT: normal







### 8.3 Confirming messages

Depending on the settings for the ALARM DISPL. TIME and ACK. ALARM MODE parameters, the following measures should be taken to clear a message:

Settings <sup>1)</sup>	Measures
<ul style="list-style-type: none"> <li>– ALARM DISPL. TIME = 0 s</li> <li>– ACK. ALARM MODE = off</li> </ul>	<ul style="list-style-type: none"> <li>– Rectify cause of the message (→  40).</li> </ul>
<ul style="list-style-type: none"> <li>– ALARM DISPL. TIME &gt; 0 s</li> <li>– ACK. ALARM MODE = off</li> </ul>	<ul style="list-style-type: none"> <li>– Rectify cause of the message (→  40).</li> <li>– Wait for the alarm display time to elapse.</li> </ul>
<ul style="list-style-type: none"> <li>– ALARM DISPL. TIME = 0 s</li> <li>– ACK. ALARM MODE = on</li> </ul>	<ul style="list-style-type: none"> <li>– Rectify cause of the message (→  40).</li> <li>– Confirm message using ACK. ALARM parameter.</li> </ul>
<ul style="list-style-type: none"> <li>– ALARM DISPL. TIME &gt; 0 s</li> <li>– ACK. ALARM MODE = on</li> </ul>	<ul style="list-style-type: none"> <li>– Rectify cause of the message (→  40).</li> <li>– Confirm message using ACK. ALARM parameter.</li> <li>– Wait for the alarm display time to elapse. If a message appears and the alarm display time elapses before the message has been acknowledged, the message will be cleared once it has been acknowledged.</li> </ul>

- 1) Menu path for ALARM DISPL. TIME and ACK. ALARM MODE: (GROUP SELECTION →) OPERATING MENU → DIAGNOSTICS → MESSAGES

If the onsite display displays a message, you can suppress it with the  key.

If there are several messages, the onsite display shows the message which has the highest priority (→  40). Once you have suppressed this message using the  key, the message with the next highest priority is displayed. You can use the  key to suppress each message, one after the other. The ALARM STATUS parameter continues to display all the messages present.

## 8.4 Repair

The Endress+Hauser repair concept provides for measuring devices to have a modular design and that the customer may also carry out repairs (→  51, "Spare Parts").



Note!

- For certified devices, please refer to the "Repair of Ex-certified devices" Section.
- For more information on service and spare parts, contact Endress+Hauser Service. See [www.endress.com/worldwide](http://www.endress.com/worldwide).

## 8.5 Repair of Ex-certified devices



Warning!

When repairing Ex-certified devices, please note the following:

- Only specialist personnel or Endress+Hauser may undertake repairs of certified devices.
- Relevant standards, national hazardous area regulations and safety instructions and certificates must be observed.
- Only genuine Endress+Hauser spare parts may be used.
- When ordering spare parts, please check the device designation on the nameplate. Identical parts may only be used as replacements.
- Electronic inserts or sensors already in use in a standard device may not be used as spare parts for a certified device.
- Carry out repairs according to the instructions. After repairs, the device must fulfill the requirements of the specified individual tests.
- A certified device may only be converted into another certified variant by Endress+Hauser.
- All repairs and modifications must be documented.

## 8.6 Spare Parts

An overview of the spare parts for your device is available in the internet at [www.endress.com](http://www.endress.com). To obtain information on the spare parts, proceed as follows :

1. Go to "www.endress.com" and select your country.
2. Click "Instruments".

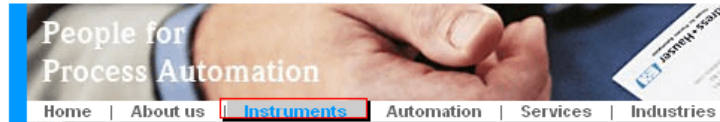

3. Enter the product name into the "product name" field.

### Endress+Hauser product search

**Via product name**

Enter the product name

4. Select the device.
5. Click the "Accessories/Spare parts" tab.

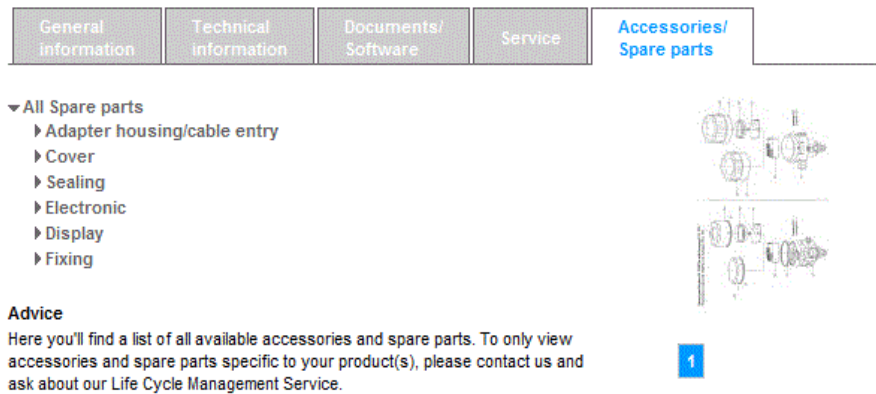

6. Select the required spare parts (You may also use the overview drawing on the right side of the screen.).

When ordering spare parts, always quote the serial number indicated on the nameplate. As far as necessary, the spare parts also include replacement instructions.

## 8.7 Return

The measuring device must be returned if repairs or a factory calibration are required, or if the wrong measuring device has been ordered or delivered. According to legal regulations, Endress+Hauser, as an ISO-certified company, is required to follow certain procedures when handling returned products that are in contact with medium.

To ensure swift, safe and professional device returns, please read the return procedures and conditions on the Endress+Hauser website at [www.services.endress.com/return-material](http://www.services.endress.com/return-material)

## 8.8 Disposal

When disposing, separate and recycle the device components based on the materials.

## 8.9 Software history

Date	Software version	Changes to software	Documentation	
			Operating Instructions	Description of Device Functions
04.2009	02.10.54	Original software. Compatible with: – Fieldcare Version 2.08.01 – EMERSON AMS Device Manager Version 11.0 – SIEMENS Simatic PDM Version 6.0 SP5 – EMERSON Field Communicator 375/475 Version 3.5	BA00412P/00/EN/01.11 71147879	BA00413P/00/EN/01.11 71147888
			BA00412P/00/EN/02.12 71185804	BA00413P/00/EN/02.12 71185806
			BA00412P/00/EN/03.14 71270369	BA00413P/00/EN/03.14 71270370

## 9 Technical data

For technical data, please refer to TI00383P.

# Index

## Numerics

4 to 20 mA test signal ..... 18

## A

Alarm messages ..... 40

## C

Cable specification ..... 18

Commubox FXA195 anschließen ..... 20

Connecting Commubox FXA291 ..... 20

Connecting the ToF adapter FXA291 ..... 20

## D

Display ..... 22

## E

Electrical connection ..... 16

Error messages ..... 40

Ersatzteile ..... 51

## F

Factory setting ..... 34

FieldCare ..... 32

## G

General structure of the operating menu ..... 26

## H

HART handheld terminal, connection ..... 20

Hazardous areas ..... 4

HistoROM/M-DAT ..... 28

## I

Incoming acceptance ..... 10

Installation instructions ..... 11

## K

Keys, local, function ..... 24

Keys, local, pressure measuring mode ..... 25

## L

Language, selection ..... 35

Load ..... 19

Locking operation ..... 32

## M

Measuring arrangement for pressure measurement ... 11–13

Measuring mode, selection ..... 35

## N

Nameplate ..... 6

## O

Onsite display ..... 22

Operating elements, function ..... 24

Operating elements, position ..... 23

Operating keys, position ..... 23

## P

Pipe mounting ..... 13

Position adjustment ..... 36

Potential equalization ..... 19, 21

Pressure measurement ..... 37

Pressure measurement, Quick Setup menu ..... 37

## Q

Quick Setup menu pressure ..... 37

## R

Repair ..... 50

Repair of Ex-certified devices ..... 50

Reset ..... 34

Rotating the housing ..... 15

## S

Scope of delivery ..... 9

Service Interface FXA291 ..... 20

Shielding ..... 19

SIL3 ..... 4

Software history ..... 52

Storage ..... 10

Supply voltage ..... 18

## T

Troubleshooting ..... 40

## U

Unlocking operation ..... 32

## W

Wall mounting ..... 13

Warnings ..... 40

[www.endress.com/worldwide](http://www.endress.com/worldwide)

---

**Endress+Hauser**   
People for Process Automation

---

