



Level



Pressure



Flow



Temperature



Liquid
Analysis



Registration



Systems
Components



Services



Solutions

Brief Operating Instructions

Cerabar M

PMC51, PMP51, PMP55

Process pressure measurement

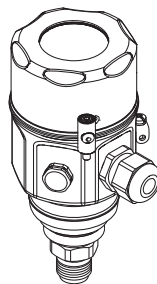
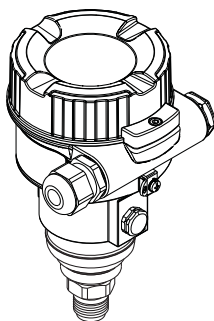

These Instructions are Brief Operating Instructions; they are not a substitute for the Operating Instructions pertaining to the device.

Detailed information about the device can be found in the Operating Instructions and the other documentation:

Available for all device versions via:

- Internet: www.endress.com/deviceviewer
- Smart phone/tablet: *Endress+Hauser Operations App*

KA01031P/00/EN/04.14
71269377

Endress+Hauser

People for Process Automation

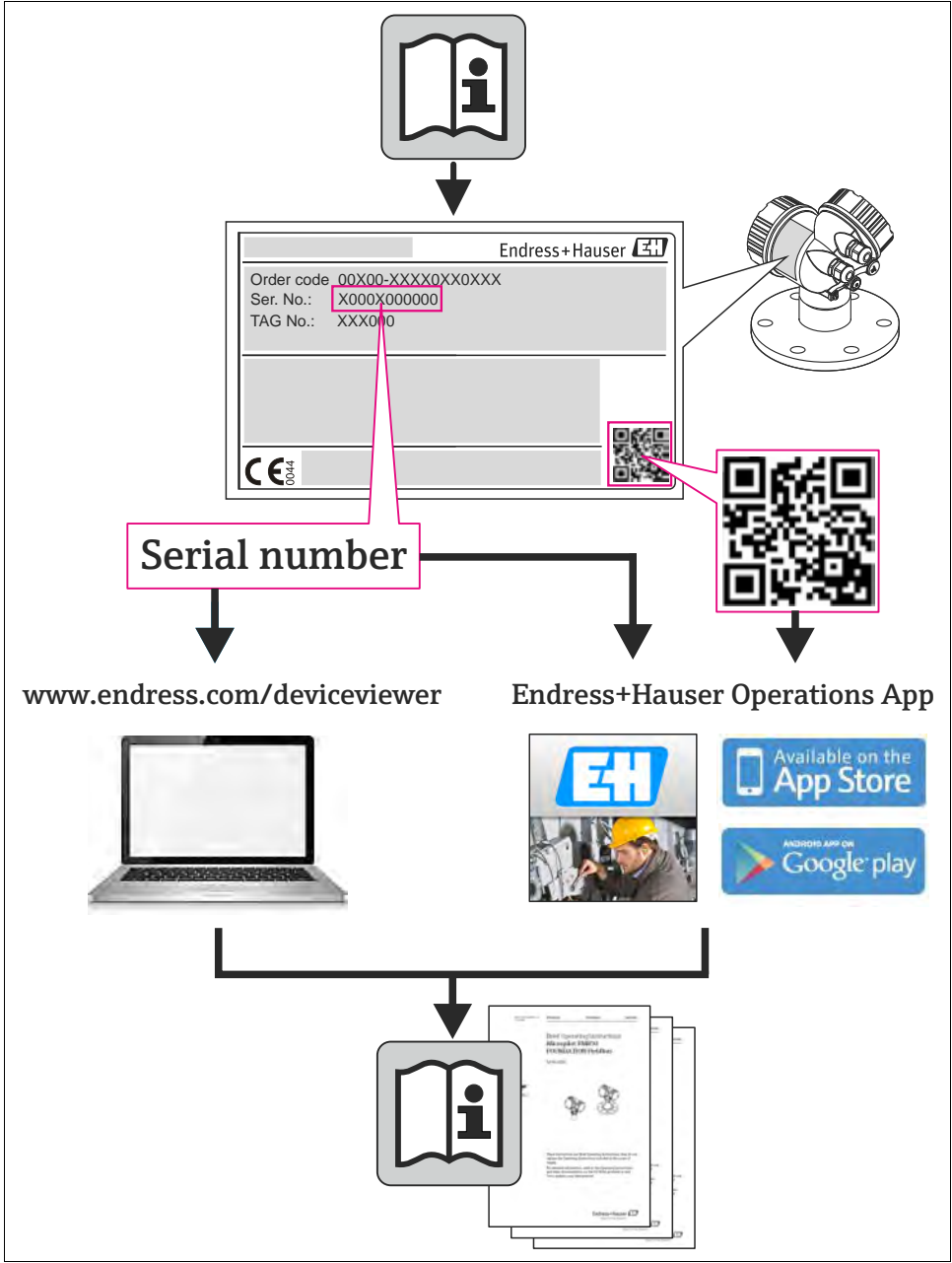

A0023555

Table of contents

1	Safety instructions	4
1.1	Designated use	4
1.2	Installation, commissioning and operation	4
1.3	Operational safety and process safety	4
1.4	Return	5
1.5	Safety icons	5
2	Identification	5
2.1	Product identification	5
3	Mounting	5
3.1	Installation position	6
3.2	Installation instructions for devices without diaphragm seals – PMP51, PMC51	6
3.3	Installation instructions for devices with diaphragm seals – PMP55	7
3.4	Assembling and mounting the "separate housing" version	9
3.5	Closing the housing cover	10
3.6	Post-installation check	10
4	Wiring	11
4.1	Connecting the device	11
4.2	Connecting the measuring unit	12
4.3	Potential equalization	13
4.4	Post-connection check	14
5	Operation	14
5.1	Operation without an operating menu	14
5.2	Operation with an operating menu	16
5.3	Device identification and addressing	25
6	Commissioning without an operating menu	26
6.1	Function check	26
6.2	Position adjustment	27
7	Commissioning with an operating menu (onsite display/FieldCare)	28
7.1	Function check	28
7.2	Commissioning	28
7.3	Position zero adjustment	30
7.4	Level measurement	31
7.5	Linearization	41
7.6	Pressure measurement	44

1 Safety instructions

1.1 Designated use

The Cerabar M is a pressure transmitter for measuring level and pressure.

The manufacturer accepts no liability for damages resulting from incorrect use or use other than that designated.

1.2 Installation, commissioning and operation

- The device must only be installed, connected, commissioned and maintained by qualified and authorized specialists (e.g. electrical technicians) in full compliance with the instructions in this manual, the applicable norms, legal regulations and certificates (depending on the application).
- The specialist must have read and understood this manual and must follow the instructions it contains. If you are unclear on anything in these Brief Operating Instructions, you must read the Operating Instructions. The Operating Instructions provide detailed information on the device/measuring system.
- The device may only be modified or repaired if such work is expressly permitted in the Operating Instructions.
- If faults cannot be rectified, the device must be taken out of service and secured against unintentional commissioning.
- Do not operate damaged devices. Mark them as defective.

1.3 Operational safety and process safety

- Alternative monitoring measures must be taken to ensure operational safety and process safety during configuration, testing and maintenance work on the device.
- The device is safely built and tested according to state-of-the-art technology and has left the factory in perfect condition as regards technical safety. The applicable regulations and European standards have been taken into account.
- Pay particular attention to the technical data on the nameplate.
- Devices for use in hazardous areas are fitted with an additional nameplate. If the device is to be installed in an explosion hazardous area, then the specifications in the certificate as well as all national and local regulations must be observed. The device is accompanied by separate "Ex documentation", which is an integral part of this Operating Instructions. The installation regulations, connection values and Safety Instructions listed in this Ex document must be observed. The documentation number of the related Safety Instructions is also indicated on the additional nameplate.





Warning!

Only disassemble the device in pressurless condition!

1.4 Return

Follow the instructions on returning the device as outlined in the Operating Instructions.

1.5 Safety icons

Symbol	Meaning
	Warning! A warning highlights actions or procedures which, if not performed correctly, will lead to personal injury, a safety hazard or destruction of the instrument.
	Caution! Caution highlights actions or procedures which, if not performed correctly, may lead to personal injury or incorrect functioning of the instrument.
	Note! A note highlights actions or procedures which, if not performed correctly, may indirectly affect operation or may lead to an instrument response which is not planned.

2 Identification

2.1 Product identification

The following options are available for identification of the measuring device:

- Nameplate specifications
- Order code with breakdown of the device features on the delivery note
- Enter serial numbers from nameplates in W@M Device Viewer (www.endress.com/deviceviewer): All information about the measuring device is displayed.

For an overview of the technical documentation provided, enter the serial number from the nameplates in the W@M Device Viewer (www.endress.com/deviceviewer).

3 Mounting



Warning!

The seal is not allowed to press against the process isolating diaphragm as this could affect the measurement result.

3.1 Installation position



Note!

- Due to the orientation of the Cerabar M, there may be a shift in the measured value, i.e. when the container is empty, the measured value does not display zero. You may correct this zero point shift by a position adjustment in one of the following ways:
 - via the operation keys on the electronics module (→ [15](#), "Function of the operating elements")
 - via the operating menu (→ [30](#), "Position zero adjustment")
- For PMP55, please refer to Section 3.3 "Installation instructions for devices with diaphragm seals – PMP55", → [7](#).
- Endress+Hauser offers a mounting bracket for installing on pipes or walls (see Operating Instructions BA00383P).

3.2 Installation instructions for devices without diaphragm seals – PMP51, PMC51



Note!

- If a heated Cerabar M is cooled during the cleaning process (e.g. by cold water), a vacuum develops for a short time, whereby moisture can penetrate the sensor through the pressure compensation (1). If this is the case, mount the Cerabar M with the pressure compensation (1) pointing downwards.

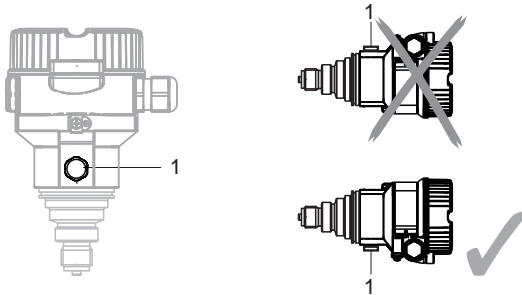

- Keep the pressure compensation and GORE-TEX® filter (1) free from contamination.
- Cerabar M transmitters without diaphragm seals are mounted as per the norms for a manometer (DIN EN 837-2). We recommend the use of shutoff devices and siphons. The orientation depends on the measuring application.
- Do not clean or touch process isolating diaphragms with hard or pointed objects.

3.2.1 Pressure measurement in gases

- Mount Cerabar M with shutoff device above the tapping point so that condensate which may be present, can flow into the process.

3.2.2 Pressure measurement in steams

- Mount Cerabar M with siphon above the tapping point.

- Fill the siphon with liquid before commissioning.
The siphon reduces the temperature to almost the ambient temperature.

3.2.3 Pressure measurement in liquids

- Mount Cerabar M with shutoff device below or at the same level as the tapping point.

3.2.4 Level measurement

- Always install the Cerabar M below the lowest measuring point.
- Do not mount the device in the filling curtain or at a point in the tank which could be affected by pressure pulses from an agitator.
- Do not mount the device in the suction area of a pump.
- The calibration and functional test can be carried out more easily if you mount the device downstream of a shutoff device.

3.3 Installation instructions for devices with diaphragm seals – PMP55



Note!

- Cerabar M devices with diaphragm seals are screwed in, flanged or clamped, depending on the type of diaphragm seal.
- A diaphragm seal and the pressure transmitter together form a closed, oil-filled calibrated system. The fill fluid hole is sealed and may not be opened.
- Do not clean or touch the process isolating diaphragm of the diaphragm seal with hard or pointed objects.
- Do not remove process isolating diaphragm protection until shortly before installation.
- When using a mounting bracket, sufficient strain relief must be ensured for the capillaries in order to prevent the capillary bending down (bending radius ≥ 100 mm (3.94 in)).
- Please note that the hydrostatic pressure of the liquid columns in the capillaries can cause zero point shift. The zero point shift can be corrected. → 30, Section 7.3 "Position zero adjustment".
- Please observe the application limits of the diaphragm seal filling oil as detailed in the Technical Information for Cerabar M TI00436P, "Planning instructions for diaphragm seal systems" section.

In order to obtain more precise measurement results and to avoid a defect in the device, mount the capillaries as follows:

- Vibration-free (in order to avoid additional pressure fluctuations)
- Not in the vicinity of heating or cooling lines
- Insulate if the ambient temperature is below or above the reference temperature
- With a bending radius of ≥ 100 mm (3.94 in).

3.3.1 Vacuum application

For applications under vacuum, Endress+Hauser recommends mounting the pressure transmitter below the diaphragm seal. This prevents vacuum loading of the diaphragm seal caused by the presence of filling oil in the capillaries.

When the pressure transmitter is mounted above the diaphragm seal, the maximum height difference H_1 in accordance with the illustration below left must not be exceeded. The maximum height difference depends on the density of the filling oil and the smallest ever pressure that is permitted to occur at the diaphragm seal (empty container), see illustration below right.

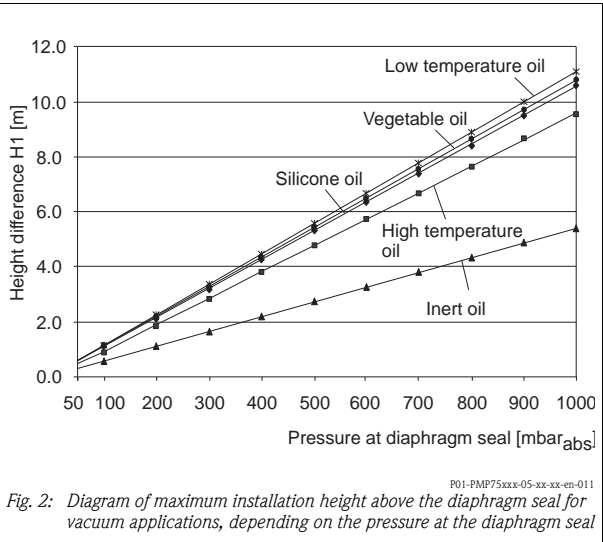
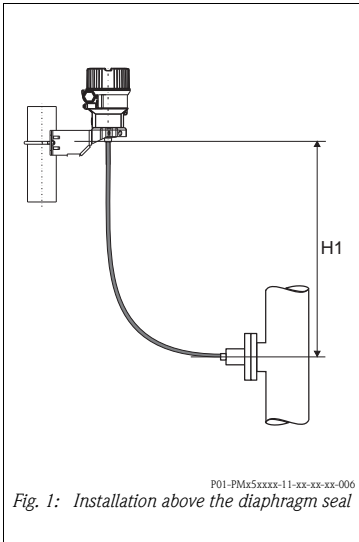

3.4 Assembling and mounting the "separate housing" version

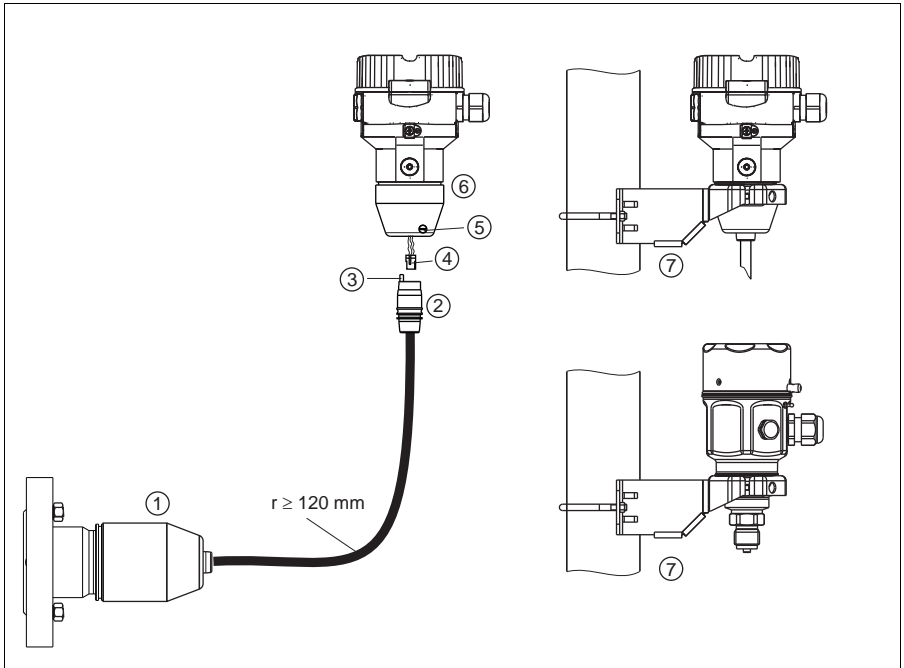

P01-3Mx5xxxx-11-xx-xx-xx-009

Fig. 3: "Separate housing" version

- 1 In the case of the "separate housing" version, the sensor is delivered with the process connection and cable ready mounted.
- 2 Cable with connection jack
- 3 Pressure compensation
- 4 Connector
- 5 Locking screw
- 6 Housing mounted with housing adapter, included
- 7 Mounting bracket provided, suitable for pipe and wall mounting (for pipes from 1 1/4" up to 2" diameter)

3.4.1 Assembly and mounting

1. Insert the connector (item 4) into the corresponding connection jack of the cable (item 2).
2. Plug the cable into the housing adapter (item 6).
3. Tighten the locking screw (item 5).
4. Mount the housing on a wall or pipe using the mounting bracket (item 7).
When mounting on a pipe, tighten the nuts on the bracket uniformly with a torque of at least 5 Nm (3.69 lbf ft).
Mount the cable with a bending radius (r) \geq 120 mm (4.72 in).

3.5 Closing the housing cover



Note!

When closing the housing cover, please ensure that the thread of the cover and housing are free from dirt, e.g. sand. If you feel any resistance when closing the cover, check the thread on both again to ensure that they are free from dirt.

3.5.1 Closing the cover on the stainless steel housing

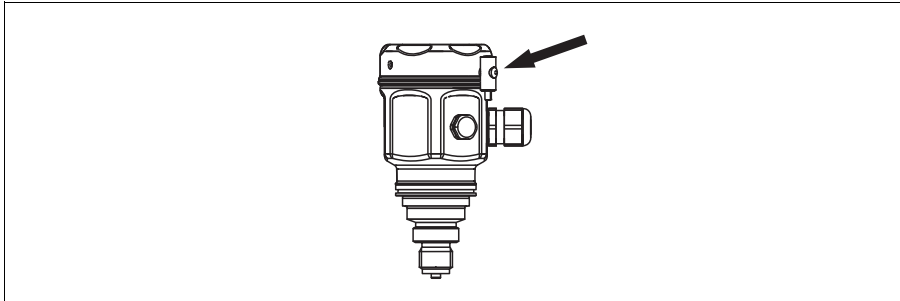

P01-PMx5xxxx-17-xxx-xx-xx-001

Fig. 4: Closing the cover

The cover for the electronics compartment is tightened by hand at the housing until the stop. The screw serves as DustEx protection (only available for devices with DustEx approval).

3.6 Post-installation check

After installing the device, carry out the following checks:

- Are all screws firmly tightened?
- Are the housing covers screwed down tight?

4 Wiring

4.1 Connecting the device



Note!

- When using the measuring device in hazardous areas, installation must comply with the corresponding national standards and regulations and the Safety Instructions or Installation or Control Drawings.
- A suitable circuit breaker has to be provided for the device in accordance with IEC/EN 61010.
- Devices with integrated overvoltage protection must be earthed.
- Protective circuits against reverse polarity, HF influences and overvoltage peaks are integrated.

The procedure

1. Check if the supply voltage matches the specified supply voltage on the nameplate.
2. Switch off the supply voltage before connecting the device.
3. Remove housing cover.
4. Guide cable through the gland. Preferably use twisted, screened two-wire cable.
5. Connect device in accordance with the following diagram.
6. Screw down housing cover.
7. Switch on supply voltage.

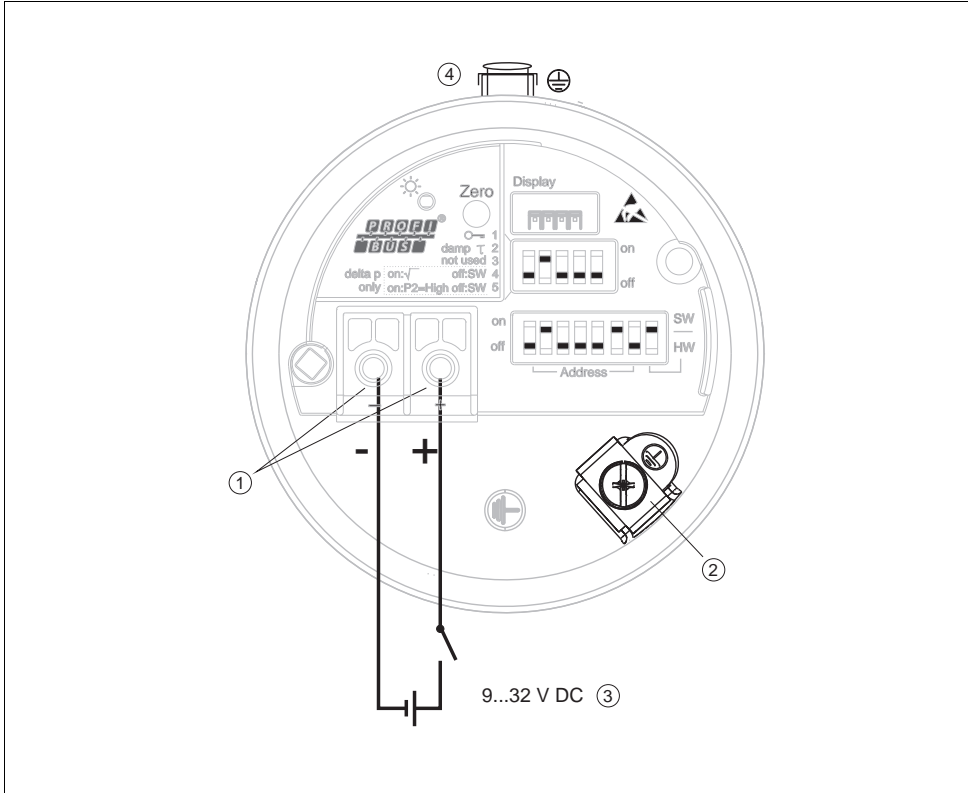

PROFIBUS PA electrical connection

F01-3Mx5xxxx-04-xx-xx-xx-01Z

- 1 Terminals for supply voltage and signal
- 2 Grounding terminal
- 3 Supply voltage: 9 to 32 VDC (Segment coupler)
- 4 External ground terminal

4.2 Connecting the measuring unit



Note!

For further information on the network structure and grounding and for further bus system components such as bus cables, see the relevant documentation, e.g. Operating Instructions BA00034S "PROFIBUS DP/PA: Guidelines for planning and commissioning" and the PNO Guideline.

4.2.1 Supply voltage



Note!

- When using the measuring device in hazardous areas, installation must comply with the corresponding national standards and regulations and the Safety Instructions or Installation or Control Drawings.
- All explosion protection data are given in separate documentation which is available upon request. The Ex documentation is supplied as standard with all devices approved for use in explosion hazardous areas.

Electronic version	
PROFIBUS PA, version for non-hazardous areas	9 to 32 V DC

4.2.2 Current consumption

11 mA ±1 mA, switch-on current corresponds to IEC 61158-2, Clause 21.

4.2.3 Cable specification

- Use a twisted, shielded two-wire cable, preferably cable type A.
- Terminals for wire cross-sections 0.5 to 2.5 mm² (20 to 14 AWG)
- Cable outer diameter: 5 to 9 mm (0.2 to 0.35 in) depends on the used cable gland (see technical information)



Note!

For further information on the cable specifications, see Operating Instructions BA00034S "PROFIBUS DP/PA: Guidelines for planning and commissioning", the PNO Guideline 2.092 "PROFIBUS PA User and Installation Guideline" and IEC 61158-2 (MBP).

4.2.4 Shielding/potential equalization

- You achieve optimum shielding against disturbances if the shielding is connected on both sides (in the cabinet and on the device). If potential equalization currents are expected in the plant, only ground shielding on one side, preferably at the transmitter.
- When using in hazardous areas, you must observe the applicable regulations. Separate Ex documentation with additional technical data and instructions is included with all Ex systems as standard.

4.3 Potential equalization

Hazardous area applications: Connect all devices to the local potential equalization. Observe the applicable regulations.

4.4 Post-connection check

Perform the following checks after completing electrical installation of the device:

- Does the supply voltage match the specifications on the nameplate?
- Is the device connected as per Section 3.1?
- Are all screws firmly tightened?
- Are the housing covers screwed down tight?

As soon as voltage is applied to the device, the green LED on the electronic insert lights up briefly or the connected onsite display lights up.

5 Operation

5.1 Operation without an operating menu

5.1.1 Position of operating elements

The operating key and DIP switches are located on the electronic insert in the device.

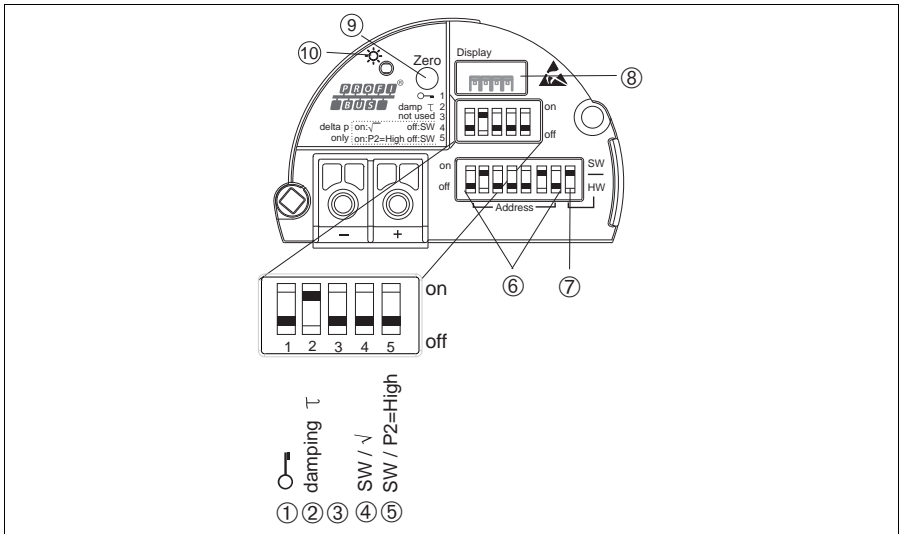



Fig. 5: PROFIBUS PA electronic insert

P01-Mxxxxxxx-19-xx-xx-xx-013

- 1 DIP switch for locking/unlocking parameters relevant to the measured value
- 2 DIP switch for switching damping on/off
- 3 Not assigned
- 4/5 DIP switch only for Deltabar M
- 6 DIP switch for hardware address
- 7 DIP switch for bus address SW / HW

- 8 Slot for optional onsite display
 9 Operating key for position adjustment or reset (zero)
 10 Green LED to indicate successful operation (Position adjustment, Reset, Warm start)

Function of the DIP switches

Switches	Symbol/ labeling	Switch position	
		"off"	"on"
1		The device is unlocked. Parameters relevant to the measured value can be modified.	The device is locked. Parameters relevant to the measured value cannot be modified.
2	damping τ	Damping is switched off. The output signal follows measured value changes without any delay.	Damping is switched on. The output signal follows measured value changes with the delay time τ . ¹⁾
6	Address	Set the device address using switches 1-7	
7	SW / HW	Hardware addressing	Software addressing

- 1) The value for the delay time can be configured via the operating menu ("Setup" -> "Damping").
 Factory setting: $\tau = 2$ s or as per order specifications.

Function of the operating elements

Operating key(s)	Meaning
"Zero" pressed for at least 3 seconds	Position adjustment (zero point correction) Press key for at least 3 seconds. The LED on the electronic insert lights up briefly if the pressure applied has been accepted for position adjustment. → See also the following Section "Performing position adjustment on site."
"Zero" pressed for at least 12 seconds	Reset All parameters are reset to the order configuration.

Performing position adjustment on site



Note!

- Operation must be unlocked. →  24, Section 5.2.4 "Locking/unlocking operation".
- The device is configured for the Pressure measuring mode as standard.
- The pressure applied must be within the nominal pressure limits of the sensor. See information on the nameplate.

Perform position adjustment:

1. Pressure is present at device.
2. Press key for at least 3 seconds.
3. If the LED on the electronic insert lights up briefly, the pressure applied has been accepted for position adjustment.
If the LED does not light up, the pressure applied was not accepted. Observe the input limits. For error messages, see Operating Instructions.

5.1.2 Locking/unlocking operation

Once you have entered all the parameters, you can lock your entries against unauthorized and undesired access.



Note!

If operation is locked by means of the DIP switch, you can only unlock operation again by means of the DIP switch. If operation is locked by means of the operating menu, you can only unlock operation again using the operating menu.

Locking/unlocking via DIP switches

DIP switch 1 on the electronic insert is used to lock/unlock operation.

→ 15, "Function of the DIP switches".

5.2 Operation with an operating menu

5.2.1 Operation concept

The operation concept makes a distinction between the following user roles:

User role	Meaning
Operator	Operators are responsible for the devices during normal "operation". This is usually limited to reading process values either directly at the device or in a control room. If the work with the devices extends beyond value read-off tasks, the tasks involve simple, application-specific functions that are used in operation. Should an error occur, these users simply forward the information on the errors but do not intervene themselves.
Service engineer/ technician	Service engineers usually work with the devices in the phases following device commissioning. They are primarily involved in maintenance and troubleshooting activities for which simple settings have to be made at the device. Technicians work with the devices over the entire life cycle of the product. Thus, commissioning and advanced settings and configurations are some of the tasks they have to carry out.
Expert	Experts work with the devices over the entire product life cycle, but their device requirements are often extremely high. Individual parameters/functions from the overall functionality of the devices are required for this purpose time and again. In addition to technical, process-oriented tasks, experts can also perform administrative tasks (e.g. user administration). "Experts" can avail of the entire parameter set.

5.2.2 Structure of the operating menu

User role	Submenu	Meaning/use
Operator	Language	Only consists of the "Language" parameter (000) where the operating language for the device is specified. The language can always be changed even if the device is locked.
Operator	Display/operat.	Contains parameters that are needed to configure the measured value display (selecting the values displayed, display format, etc.). With this submenu, users can change the measured value display without affecting the actual measurement.
Service engineer/ technician	Setup	Contains all the parameters that are needed to commission measuring operations. This submenu has the following structure: <ul style="list-style-type: none"> ■ Standard setup parameters A wide range of parameters, which can be used to configure a typical application, is available at the start. The measuring mode selected determines which parameters are available. After making settings for all these parameters, the measuring operation should be completely configured in the majority of cases. ■ "Extended setup" submenu The "Extended setup" submenu contains additional parameters for more in-depth configuration of the measurement operation to convert the measured value and to scale the output signal. This menu is split into additional submenus depending on the measuring mode selected.
Service engineer/ technician	Diagnosis	Contains all the parameters that are needed to detect and analyze operating errors. This submenu has the following structure: <ul style="list-style-type: none"> ■ Diagnostic list Contains up to 10 error messages currently pending. ■ Event logbook Contains the last 10 error messages (no longer pending). ■ Instrument info Contains information on the device identification. ■ Measured values Contains all the current measured values ■ Simulation Is used to simulate pressure, level and alarm/warning. ■ Factory reset
Expert	Expert	Contains all the parameters of the device (including those in one of the submenus). The "Expert" submenu is structured by the function blocks of the device. It thus contains the following submenus: <ul style="list-style-type: none"> ■ System Contains general device parameters that neither affect measurement nor integration into a distributed control system. ■ Measurement Contains all the parameters for configuring the measurement. ■ Communication Contains the parameters of the PROFIBUS PA interface. ■ Application Contains all the parameters for configuring the functions that go beyond the actual measurement (e.g. totalizer). ■ Diagnosis Contains all the parameters that are needed to detect and analyze operating errors.

5.2.3 Operation with a device display (optional)

A 4-line liquid crystal display (LCD) is used for display and operation. The onsite display shows measured values, dialog texts, fault messages and notice messages.

For easy operation the display can be taken out of the housing (see figure steps 1 to 3). It is connected to the device through a 90 mm (3.54 in) cable.

The display of the device can be turned in 90° stages (see figure steps 4 to 6).

Depending on the orientation of the device, this makes it easy to operate the device and read the measured values.

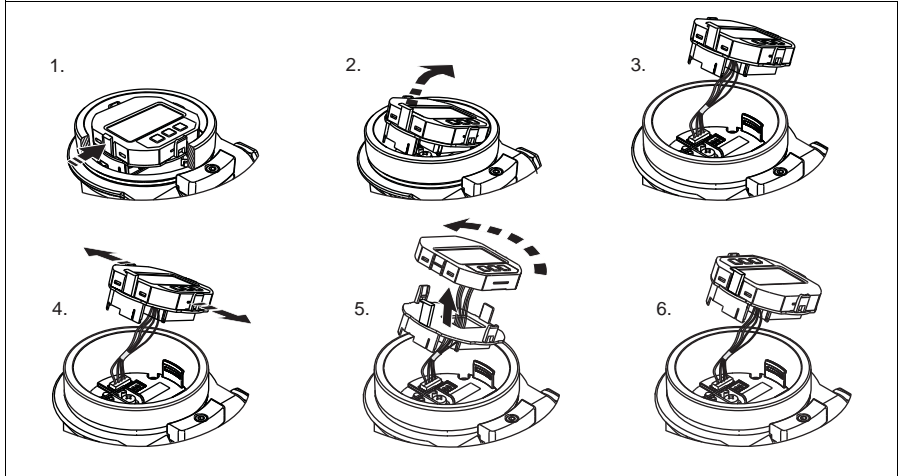

P01-Mxxxxxxx-19-xx-xx-xx-008





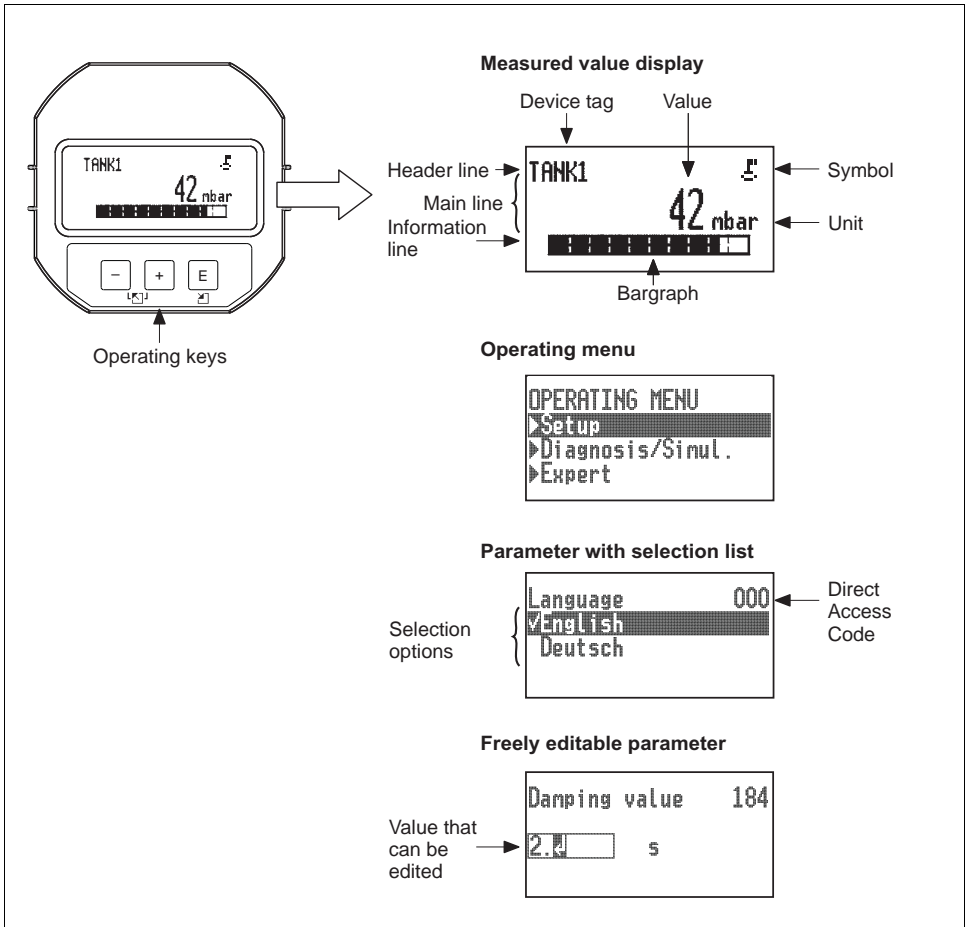

Functions:

- 8-digit measured value display including sign and decimal point.
- Bar graph as graphic display of the standardized value of the Analog Input Block (→ see Operating Instructions)
- Three keys for operation
- Simple and complete menu guidance as parameters are split into several levels and groups
- Each parameter is given a 3-digit parameter code for easy navigation
- Possibility of configuring the display to suit individual requirements and preferences, such as language, alternating display, display of other measured values such as sensor temperature, contrast setting.
- Comprehensive diagnostic functions (fault and warning message etc.)





FO1-Mxxxxxxx-07-xx-xx-xx-002

The following table illustrates the symbols that can appear on the onsite display. Four symbols can occur at one time.

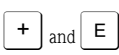
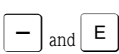
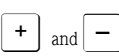

Symbol	Meaning
	Lock symbol The operation of the device is locked. To unlock the device, →  24, Locking/unlocking operation.
	Communication symbol Data transfer via communication
	Error message "Out of specification" The device is being operated outside its technical specifications (e.g. during warmup or cleaning processes).
	Error message "Service mode" The device is in the service mode (during a simulation, for example).
	Error message "Maintenance required" Maintenance is required. The measured value remains valid.
	Error message "Failure detected" An operating error has occurred. The measured value is no longer valid.

Operating keys on the display and operating module

Operating key(s)	Meaning
	<ul style="list-style-type: none"> – Navigate downwards in the picklist – Edit the numerical values and characters within a function
	<ul style="list-style-type: none"> – Navigate upwards in the picklist – Edit the numerical values and characters within a function
	<ul style="list-style-type: none"> – Confirm entry – Jump to the next item – Selection of a menu item and activation of the editing mode
	Contrast setting of onsite display: darker
	Contrast setting of onsite display: brighter
	ESC functions: <ul style="list-style-type: none"> – Exit the edit mode for a parameter without saving the changed value. – You are in a menu at a selection level. Each time you press the keys simultaneously, you go up a level in the menu.

Parameters with a picklist

Example: selecting "Deutsch" as the language.

Onsite display	Operation
 <p style="text-align: right; font-size: small;">P01-PMD55xxx-19-xx-xx-xx-002</p>	<p>"English" is set as the language (default value). A ✓ in front of the menu text indicates the active option.</p>
 <p style="text-align: right; font-size: small;">P01-PMD55xxx-19-xx-xx-xx-001</p>	<p>Select "Deutsch" with "+" or "-".</p>
 <p style="text-align: right; font-size: small;">P01-PMD55xxx-19-xx-xx-xx-000</p>	<ol style="list-style-type: none"> 1. Confirm your choice with "E". A ✓ in front of the menu text indicates the active option. ("Deutsch" is now selected as the menu language.) 2. Exit the edit mode for the parameter with "E".

User-definable parameters

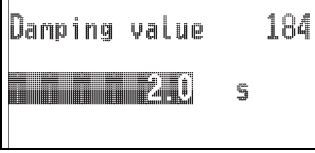
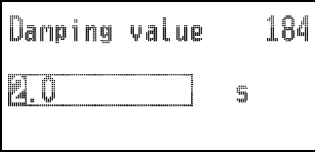
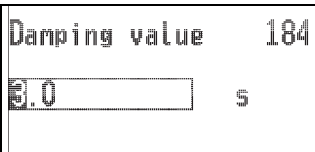
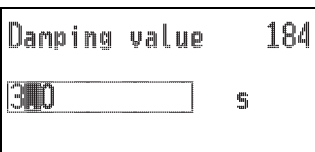
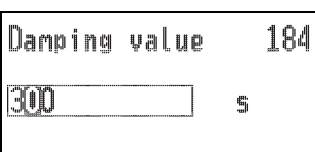
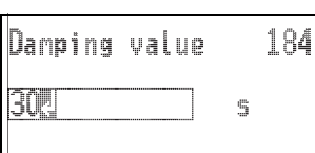

Example: changing the damping function from 2.0 s to 30.0 s.

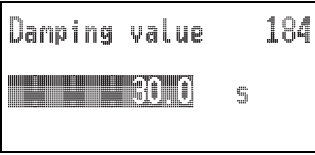
Onsite display	Operation
 <p style="text-align: center; font-size: small;">P01-xxxxxxxx-19-xx-xx-en-001</p>	<p>The onsite display shows the parameter to be changed. The value highlighted in black can be changed. The unit "s" is prespecified and cannot be changed.</p>
 <p style="text-align: center; font-size: small;">P01-xxxxxxxx-19-xx-xx-en-002</p>	<ol style="list-style-type: none"> 1. Press "+" or "-" to get to the editing mode. 2. The first digit is highlighted in black.
 <p style="text-align: center; font-size: small;">P01-xxxxxxxx-19-xx-xx-en-003</p>	<ol style="list-style-type: none"> 1. Use "+" to change "2" to "3". 2. Confirm "3" with "E". The cursor jumps to the next position (highlighted in black).
 <p style="text-align: center; font-size: small;">P01-xxxxxxxx-19-xx-xx-en-004</p>	<p>The decimal point is highlighted in black. This means you can now edit this digit.</p>
 <p style="text-align: center; font-size: small;">P01-xxxxxxxx-19-xx-xx-en-005</p>	<ol style="list-style-type: none"> 1. Press "+" or "-" until "0" is displayed. 2. Confirm "0" with "E". The cursor goes to the next position. ␣ is displayed and highlighted in black. → See next graphic.
 <p style="text-align: center; font-size: small;">P01-xxxxxxxx-19-xx-xx-en-006</p>	<p>Use "E" to save the new value and exit the editing mode. → See next graphic.</p>

Onsite display	Operation
 <p style="text-align: center; font-size: small;">P01-xxxxxxx-19-xx-xx-en-007</p>	<p>The new value for the damping is 30.0 s.</p> <ul style="list-style-type: none"> - Go to the next parameter with "E" . - You can get back to the editing mode with "+" or "-".

Accepting the pressure present

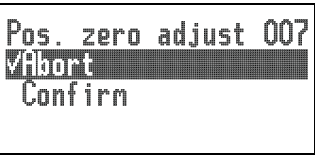
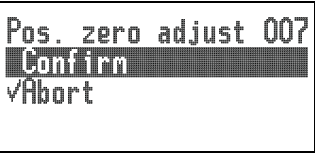
Example: setting position adjustment

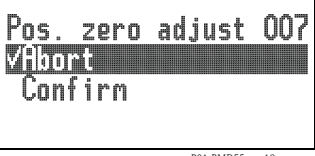
Onsite display	Operation
 <p style="text-align: center; font-size: small;">P01-PMD55xxx-19-xx-xx-009</p>	<p>The pressure for position adjustment is present at the device.</p>
 <p style="text-align: center; font-size: small;">P01-PMD55xxx-19-xx-xx-010</p>	<p>Use "+" or "-" to switch to the "Confirm" option. The active option is highlighted in black.</p>
 <p style="text-align: center; font-size: small;">P01-PMD55xxx-19-xx-xx-011</p>	<p>Accept the pressure present as position adjustment with the "E" key. The device confirms the adjustment and goes back to the "Pos. zero adjust" parameter.</p>
 <p style="text-align: center; font-size: small;">P01-PMD55xxx-19-xx-xx-009</p>	<p>Exit the edit mode for the parameter with "E" .</p>

5.2.4 Locking/unlocking operation

Once you have entered all the parameters, you can lock your entries against unauthorized and undesired access.

Locked operation is indicated as follows:

- By the  symbol on the onsite display
- The parameters are grayed out in FieldCare and the handheld terminal, which means they cannot be edited. Indicated in the corresponding "Lockstate" parameter.

Parameters which refer to how the display appears, e.g. "Language (000)", can still be altered.



Note!

If operation is locked by means of the DIP switch, you can only unlock operation again by means of the DIP switch. If operation is locked by means of the operating menu, you can only unlock operation again using the operating menu.

The "Operator code (021)" parameter is used to lock and unlock the device.

Parameter name	Description
Operator code (021) Entry Menu path: Setup → Extended setup → Operator code	Use this function to enter a code to lock or unlock operation. User input: <ul style="list-style-type: none"> ■ To lock: Enter a number ≠ the release code (value range: 1 to 9999). ■ To unlock: Enter the release code.  Note! The release code is "0" in the order configuration. Another release code can be defined in the "Code definition (023)" parameter. If the user has forgotten the release code, the release code can be visible by entering the number "5864". Factory setting: 0

The release code is defined in the "Code definition (023)" parameter.

Parameter name	Description
Code definition (023) Entry Menu path: Setup → Extended setup → Code definition	Use this function to enter a release code with which the device can be unlocked. User input: <ul style="list-style-type: none"> ■ A number between 0 and 9999 Factory setting: 0

5.3 Device identification and addressing

Please note the following:

- An address must be assigned to each PROFIBUS PA device. The control system/master can only recognize the device if the address is set correctly.
- Each address can only be assigned once in any PROFIBUS PA network.
- Device addresses in the range from 0 to 125 are valid.
- The address "126" configured at the factory can be used for functional device testing and to connect to a PROFIBUS PA network already in operation. This address must be changed subsequently to add additional devices.
- On leaving the factory, all devices are delivered with the default address 126 and software addressing.
- The FieldCare operating program is delivered with the default address 1.

There are two ways to assign the device address to a Deltapilot:

- Via an operating program of the DP Class 2 master, such as FieldCare or
- Onsite via DIP switches.

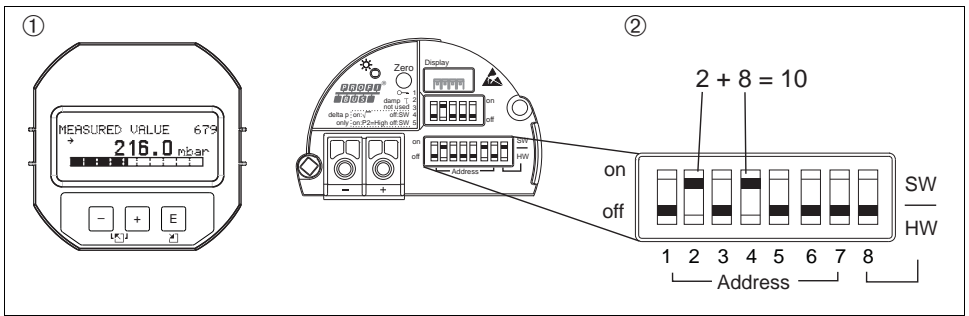

Fig. 6: Setting the device address via DIP switches

P01-Mxxxxxxx-19-xx-xx-xx-018

- 1 If necessary, remove onsite display (optional)
- 2 Set the hardware address via the DIP switches

5.3.1 Hardware addressing

A hardware address is set as follows:

1. Set the DIP switch 8 (SW/HW) to "Off".
2. Set the address with DIP switches 1 to 7.
3. The change of address takes effect after 10 seconds. The device is restarted.

DIP switch	1	2	3	4	5	6	7
Value when set to "On"	1	2	4	8	16	32	64
Value when set to "Off"	0	0	0	0	0	0	0

5.3.2 Software addressing

A software address is set as follows:

1. Set the DIP switch 8 (SW/HW) to "On" (factory setting).
2. The device is restarted.
3. The device reports its current address. Factory setting: 126
4. Set the address via the configuration program.
See the next section for information on how to enter a new address via FieldCare.
For other operating programs, see the corresponding operating manual.

6 Commissioning without an operating menu



Warning!

- If a pressure smaller than the minimum permitted pressure or greater than the maximum permitted pressure is present at the device, the following messages are output in succession:
 1. "S140 Working range P" or "F140 Working range P" ¹⁾
 2. "S841 Sensor range" or "F841 Sensor range" ¹⁾





Note!

The device is configured for the Pressure measuring mode as standard. The measuring range and the unit in which the measured value is transmitted correspond to the specifications on the nameplate.

6.1 Function check

Carry out a post-installation and a post-connection check as per the checklist before commissioning the device.

- "Post-installation check" checklist →  10
- "Post-connection check" checklist →  14

1) Depending on the setting in the "Alarm behav. P (050) parameter.

6.2 Position adjustment

The following functions are possible by means of the key on the electronic insert:

- Position adjustment (zero point correction)
- Device reset (see Operating Instructions)



Note!

- Operation must be unlocked. → 24, "Locking/unlocking operation"
- The device is configured for the "Pressure" measuring mode as standard.
- The pressure applied must be within the nominal pressure limits of the sensor. See information on the nameplate.

Carrying out position adjustment	
Pressure is present at device.	
↓	
Press the "Zero" key for at least 3 s.	
↓	
Does the LED on the electronic insert light up briefly?	
Yes	No
↓	↓
Applied pressure for position adjustment has been accepted.	¹⁾ Applied pressure for position adjustment has not been accepted. Observe the input limits.

1) Observe warning on commissioning (→ 26)

7 Commissioning with an operating menu (onsite display/FieldCare)



Warning!

- If a pressure smaller than the minimum permitted pressure or greater than the maximum permitted pressure is present at the device, the following messages are output in succession:
 1. "S140 Working range P" or "F140 Working range P" ²⁾
 2. "S841 Sensor range" or "F841 Sensor range" ²⁾



Note!

The device is configured for the Pressure measuring mode as standard. The measuring range and the unit in which the measured value is transmitted correspond to the specifications on the nameplate.

7.1 Function check

Carry out a post-installation and a post-connection check as per the checklist before commissioning the device.

- "Post-installation check" checklist → 10
- "Post-connection check" checklist → 14

7.2 Commissioning

Commissioning comprises the following steps:

1. Function check → 28
2. Selecting the language, measuring mode and pressure unit → 28
3. Position adjustment → 30
4. Configuring measurement:
 - Pressure measurement → 44 ff
 - Level measurement → 31 ff

2) depending on the setting in the "Alarm behav. P" (050) parameter

7.2.1 Selecting the language, measuring mode and pressure unit

Language selection

Parameter name	Description
Language (000) Options Menu path: Main menu → Language	Select the language for the onsite display. Options: <ul style="list-style-type: none"> ■ English ■ Possibly another language (as selected when ordering the device) ■ One further language (language of the manufacturing plant) Factory setting: English

Measuring mode selection

Parameter name	Description
Measuring mode (005) Options Menu path: Setup → Measuring mode (005)	Select the measuring mode. The operating menu is structured differently depending on the measuring mode selected.  Note! If the measuring mode is changed, no conversion takes place. If necessary, the device has to be recalibrated after the measuring mode has been changed. Options: <ul style="list-style-type: none"> ■ Pressure ■ Level Factory setting: Pressure

Pressure unit selection

Parameter name	Description
Press. eng. unit (125) Options Menu path: Setup → Press. eng. unit (125)	Select the pressure unit. If a new pressure unit is selected, all pressure-specific parameters are converted and displayed with the new unit. Options: <ul style="list-style-type: none"> ■ mbar, bar ■ mmH2O, mH2O, ■ inH2O, ftH2O ■ Pa, kPa, MPa ■ psi ■ mmHg, inHg ■ kgf/cm² Factory setting: mbar or bar depending on the sensor nominal measuring range, or as per order specifications

7.3 Position zero adjustment

The pressure resulting from the orientation of the device can be corrected here.

Parameter name	Description
<p>Corrected press. (172) Display</p> <p>Menu path: Setup → Corrected press. (172)</p>	<p>Displays the measured pressure after sensor trim and position adjustment.</p> <p> Note! If this value is not equal to "0", it can be corrected to "0" by the position adjustment.</p>
<p>Pos. zero adjust (007) (Deltabar M and relative pressure sensor) Options</p> <p>Menu path: Setup → Pos. zero adjust (007) (Deltabar and relative pressure sensor)</p>	<p>Position adjustment – the pressure difference between zero (set point) and the measured pressure need not be known.</p> <p>Example:</p> <ul style="list-style-type: none"> – Measured value = 2.2 mbar (0.032 psi) – Correct the measured value via the "Pos. zero adjust (007) (Deltabar and relative pressure sensor)" parameter with the "Confirm" option. This means that you are assigning the value 0.0 to the pressure present. – Measured value (after pos. zero adjust) = 0.0 mbar <p>Options</p> <ul style="list-style-type: none"> ■ Confirm ■ Abort <p>Factory setting: Abort</p>
<p>Calib. offset (192) (008) (absolute pressure sensor) Entry</p> <p>Menu path: Setup → Calib. offset (192)</p>	<p>Position adjustment – the pressure difference between the set point and the measured pressure must be known.</p> <p>Example:</p> <ul style="list-style-type: none"> – Measured value = 982.2 mbar (14.25 psi) – You correct the measured value with the value entered (e.g. 2.2 mbar (0.032 psi)) via the "Calib. offset (192)" parameter. This means that you are assigning the value 980.0 (14.21 psi) to the pressure present. – Measured value (after calib. offset) = 980.0 mbar (14.21 psi) <p>Factory setting: 0.0</p>

7.4 Level measurement

7.4.1 Information on level measurement



Note!

You have a choice of two methods for calculating the level: "In pressure" and "In height". The table in the "Overview of level measurement" section that follows provides you with an overview of these two measuring tasks.

- The limit values are not checked, i.e. the values entered must be appropriate for the sensor and the measuring task for the device to be able to measure correctly.
- Customer-specific units are not possible.
- There is no unit conversion.
- The values entered for "Empty calib. (028)/Full calib. (031)", "Empty pressure (029)/Full pressure (032)", "Empty height (030)/Full height (033)" must be at least 1 % apart. The value will be rejected, and a warning message displayed, if the values are too close together.

7.4.2 Overview of level measurement

Measuring task	Level selection	Measured variable options	Description	Measured value display
Calibration is performed by entering two pressure-level value pairs.	"In pressure"	Via the "Unit before lin (025)" parameter: %, level, volume or mass units.	<ul style="list-style-type: none"> - Calibration with reference pressure (wet calibration), see → 32 - Calibration without reference pressure (dry calibration), see → 34 	The measured value display and the "Level before lin. (019)" parameter display the measured value.
Calibration is performed by entering the density and two height-level value pairs.	"In height"		<ul style="list-style-type: none"> - Calibration with reference pressure (wet calibration), see → 39 - Calibration without reference pressure (dry calibration), see → 36 	

7.4.3 "In pressure" level selection Calibration with reference pressure (wet calibration)

Example:

In this example, the level in a tank should be measured in "m". The maximum level is 3 m (9.8 ft). The pressure range is due to the filling height and the density.

Prerequisite:

- The measured variable is in direct proportion to the pressure.
- The tank can be filled and emptied.



Note!

The values entered for "Empty calib. (028)/Full calib. (031)" and the pressures present at the device must be at least 1% apart. The value will be rejected, and a warning message displayed, if the values are too close together. Further limit values are not checked; i.e. the values entered must be appropriate for the sensor and the measuring task so that the measuring device can measure correctly.

Description	
1	Perform "position adjustment" → 30.
2	Select the "Level" measuring mode via the "Measuring mode (005)" parameter. Menu path: Setup → Measuring mode (005)
3	Select a pressure unit via the "Press. eng. unit (125)" parameter, here "mbar" for example. Menu path: Setup → Press. eng. unit (125)
4	Select the "in pressure" level mode by means of the "Level selection (024)" parameter. Menu path: Setup → Extended Setup → Level → Level selection (024)

P01-Mxxxxxxx-19-xx-xx-xx-003

Fig. 7: Calibration with reference pressure – wet calibration

1 See Table, Step 7.
2 See Table, Step 8.

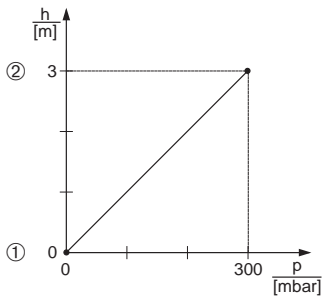
	Description		
5	Select a level unit by means of the "Unit before lin (025)" parameter, here "m" for example. Menu path: Setup → Extended Setup → Level → Unit before lin (025)		
6	Select the "Wet" option by means of the "Calibration mode (027)" parameter. Menu path: Setup → Extended Setup → Level → Calibration mode (027)		
7	The pressure for the lower calibration point is present at the device, here 0 mbar for example.		
	Select the "Empty calib. (028)" parameter.		
	Menu path: Setup → Extended Setup → Level → Empty calib. (028)		
	Enter the level value, here 0 m for example. The pressure value present is assigned to the lower level value by confirming the value.		
8	The pressure for the upper calibration point is present at the device, here 300 mbar (4.35 psi) for example.		1 See Table, Step 7. 2 See Table, Step 8.
	Select the "Full calib. (031)" parameter.		
	Menu path: Setup → Extended Setup → Level → Full calib. (031) Enter the level value, here 3 m (9.8 ft) for example. The pressure value present is assigned to the upper level value by confirming the value.		
9	If calibration is performed with a medium other than the process medium, enter the density of the calibration medium in "Adjust density (034)". Menu path: Setup → Extended Setup → Level → Adjust density (034)		
10	If calibration was performed with a medium other than the process medium, specify the density of the process medium in the "Process density (035)" parameter. Menu path: Setup → Extended setup → Level → Process density (035).		
11	Result: The measuring range is set for 0 to 3 m (9.8 ft).		

P01-xxxxxxx-05-xx-xx-xx-011

Fig. 8: Calibration with reference pressure – wet calibration



Note!

The measured variables %, level, volume and mass are available for this level mode see parameter "Unit before lin (025)" in the Operating Instructions.

7.4.4 "In pressure" level selection

Calibration without reference pressure (dry calibration)

Example:

In this example, the volume in a tank should be measured in liters. The maximum volume of 1000 liters (264 gal) corresponds to a pressure of 450 mbar (6.53 psi). The minimum volume of 0 liters corresponds to a pressure of 50 mbar (0.72 psi) since the device is mounted below the start of the level measuring range.

Prerequisite:

- The measured variable is in direct proportion to the pressure.
- This is a theoretical calibration i.e. the pressure and volume values for the lower and upper calibration point must be known.



Note!

- The values entered for "Empty calib. (028)/Full calib. (031)", "Empty pressure (029)/Full pressure (032)" must be at least 1% apart. The value will be rejected, and a warning message displayed, if the values are too close together. Further limit values are not checked; i.e. the values entered must be appropriate for the sensor and the measuring task so that the measuring device can measure correctly.
- Due to the orientation of the device, there may be pressure shifts in the measured value, i.e. when the container is empty or partly filled, the measured value is not zero. For information on how to perform position adjustment, see → 30, "Position zero adjustment".

	Description	
1	Select the "Level" measuring mode via the "Measuring mode (005)" parameter. Menu path: Setup → Measuring mode (005)	 <p style="text-align: right; font-size: small;">P01-Mxxxxxxx-19-xx-xx-xx-004</p>
2	Select a pressure unit via the "Press. eng. unit (125)" parameter, here "mbar" for example. Menu path: Setup → Press. eng. unit (125)	
3	Select the "in pressure" level mode by means of the "Level selection (024)" parameter. Menu path: Setup → Extended Setup → Level → Level selection (024)	
4	Select a volume unit via the "Unit before lin (025)" parameter, here "l" (liter) for example. Menu path: Setup → Extended Setup → Level → Unit before lin (025)	

Fig. 9: Calibration without reference pressure – dry calibration

- 1 See Table, Steps 7 and 8.
2 See Table, Steps 9 and 10.

	Description	
5	Select the "Dry" option by means of the "Calibration mode (027)" parameter. Menu path: Setup → Extended Setup → Level → Calibration mode (027)	<p style="text-align: right; font-size: small;">P01-xxxxxxx-05-xx-xx-xx-026</p> <p><i>Fig. 10: Calibration with reference pressure – wet calibration</i></p> <p>1 See Table, Step 7. 2 See Table, Step 8. 3 See Table, Step 9. 4 See Table, Step 10.</p>
6	"Adjust density (034)" contains the factory setting 1.0, but this value can be changed if required. The entered value pairs must correspond to this density. Menu path: Setup → Extended Setup → Level → Adjust density (034)	
7	Enter the volume value for the lower calibration point via the "Empty calib. (028)" parameter, here 0 liters for example. Menu path: Setup → Extended Setup → Level → Empty calib. (028)	
8	Enter the pressure value for the lower calibration point via the "Empty pressure (029)" parameter, here 50 mbar (0.72 psi) for example. Menu path: Setup → Extended Setup → Level → Empty pressure (029)	
9	Enter the volume value for the upper calibration point via the "Full calib. (031)" parameter, here 1000 liters (264 gal) for example. Menu path: Setup → Extended Setup → Level → Full calib. (031)	
10	Enter the pressure value for the upper calibration point via the "Full pressure (032)" parameter, here 450 mbar (6.53 psi) for example. Menu path: Setup → Extended Setup → Level → Full pressure (032)	
11	If calibration was performed with a medium other than the process medium, specify the density of the process medium in the "Process density (035)" parameter. Menu path: Setup → Extended setup → Level → Process density (035).	
12	Result: The measuring range is set for 0 to 1000 l (264 gal).	

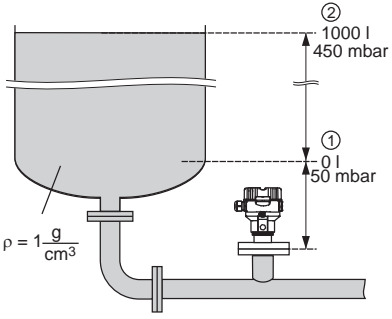

Note!

The measured variables %, level, volume and mass are available for this level mode see parameter "Unit before lin (025)" in the Operating Instructions.

7.4.5 "In height" level selection

Calibration without reference pressure (dry calibration)

Example:

In this example, the volume in a tank should be measured in liters. The maximum volume of 1000 liters (264 gal) corresponds to a level of 4.5 m (14.8 ft). The minimum volume of 0 liters corresponds to a level of 0.5 m (1.6 ft) since the device is mounted below the start of the level measuring range.

Prerequisite:

- The measured variable is in direct proportion to the pressure.
- This is a theoretical calibration i.e. the height and volume values for the lower and upper calibration point must be known.

**Note!**

- The values entered for "Empty calib. (028)/Full calib. (031)", "Empty height (030)/Full height (033)" must be at least 1 % apart. The value will be rejected, and a warning message displayed, if the values are too close together. Further limit values are not checked; i.e. the values entered must be appropriate for the sensor and the measuring task so that the measuring device can measure correctly.
- Due to the orientation of the device, there may be pressure shifts in the measured value, i.e. when the container is empty or partly filled, the measured value is not zero. For information on how to perform position adjustment, see →  30, "Position zero adjustment".

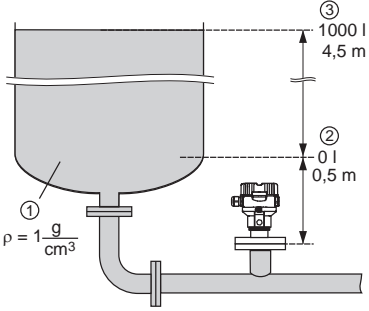
	Description		
1	Select the "Level" measuring mode via the "Measuring mode (005)" parameter. Menu path: Setup → Measuring mode (005)	 <p style="text-align: right; font-size: small;">P01-Mxxxxxxx-19-xx-xx-xx-007</p>	
2	Select a pressure unit via the "Press. eng. unit (125)" parameter, here "mbar" for example. Menu path: Setup → Press. eng. unit (125)		
3	Select the "in height" level mode via the "Level selection (024)" parameter. Menu path: Setup → Extended Setup → Level → Level selection (024)		
4	Select a volume unit via the "Unit before lin (025)" parameter, here "l" (liter) for example. Menu path: Setup → Extended Setup → Level → Unit before lin (025)		
5	Select a level unit by means of the "Height unit (026)" parameter, here "m" for example. Menu path: Setup → Extended Setup → Level → Height unit (026)		
6	Select the "Dry" option by means of the "Calibration mode (027)" parameter. Menu path: Setup → Extended Setup → Level → Calibration mode (027)		<p><i>Fig. 11: Calibration without reference pressure – dry calibration</i></p> <p>1 See Table, Step 7. 2 See Table, Steps 8 and 9. 3 See Table, Steps 10 and 11.</p>
7	Enter the density of the medium via the "Adjust density (034)" parameter, here "1 g/cm ³ " (1 SGU) for example. Menu path: Setup → Extended Setup → Level → Adjust density (034)		

	Description	
8	Enter the volume value for the lower calibration point via the "Empty calib. (028)" parameter, here 0 liters for example. Menu path: Setup → Extended Setup → Level → Empty calib. (028)	 <p style="text-align: center;">$h = \frac{p}{\rho \cdot g}$</p> <p style="text-align: center;">$\rho = 1 \frac{\text{g}}{\text{cm}^3}$</p>
9	Enter the height value for the lower calibration point via the "Empty height (030)" parameter, here 0.5 m (1.6 ft) for example. Menu path: Setup → Extended Setup → Level → Empty height (030)	
10	Enter the volume value for the upper calibration point via the "Full calib. (031)" parameter, here 1000 liters (264 gal) for example. Menu path: Setup → Extended Setup → Level → Full calib. (031)	
11	Enter the height value for the upper calibration point via the "Full height (033)" parameter, here 4.5 m (14.8 ft) for example. Menu path: Setup → Extended Setup → Level → Full height (033)	<p style="text-align: right;"><small>P01-xxxxxxx-05-xx-xx-xx-029</small></p>  <p style="text-align: center;">$h = \frac{p}{\rho \cdot g}$</p>
12	If the process uses a medium other than that on which the calibration was based, the new density must be specified in the "Process density (035)" parameter. Menu path: Setup → Extended setup → Level → Process density (035).	
13	Result: The measuring range is set for 0 to 1000 l (264 gal).	

Fig. 12: Calibration with reference pressure – wet calibration

- 1 See Table, Step 7.
- 2 See Table, Step 8.
- 3 See Table, Step 9.
- 4 See Table, Step 10.
- 5 See Table, Step 11.

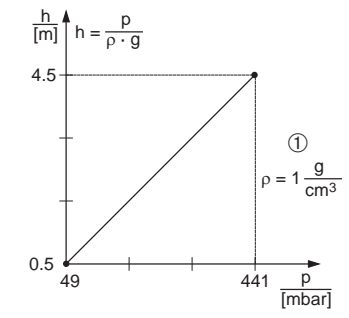
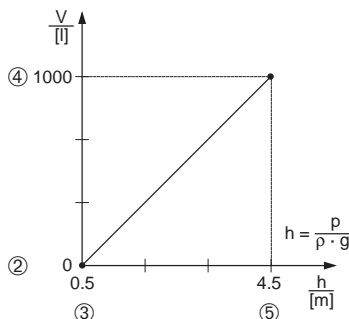

Note!

The measured variables %, level, volume and mass are available for this level mode see parameter "Unit before lin (025)" in the Operating Instructions.

7.4.6 "In height" level selection Calibration with reference pressure (wet calibration)

Example:

In this example, the volume in a tank should be measured in liters. The maximum volume of 1000 liters (264 gal) corresponds to a level of 4.5 m (14.8 ft). The minimum volume of 0 liters corresponds to a level of 0.5 m (1.6 ft) since the device is mounted below the start of the level measuring range.

The density of the medium is 1 g/cm³ (1 SGU).

Prerequisite:

- The measured variable is in direct proportion to the pressure.
- The tank can be filled and emptied.



Note!

The values entered for "Empty calib. (028)/Full calib. (031)" and the pressure values present at the device must be at least 1% apart. The value will be rejected, and a warning message displayed, if the values are too close together. Further limit values are not checked; i.e. the values entered must be appropriate for the sensor and the measuring task so that the measuring device can measure correctly.

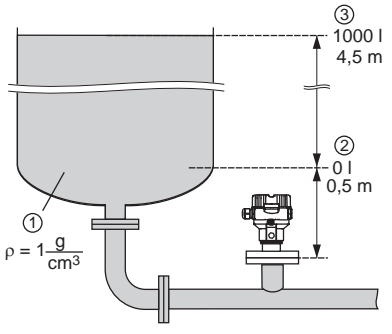
	Description	
1	Perform position adjustment. See → 30.	
2	Select the "Level" measuring mode via the "Measuring mode (005)" parameter. Menu path: Setup → Measuring mode (005)	 <p style="text-align: right; font-size: small;">P01-Mxxxxxxx-19-xx-xx-xx-007</p>
3	Select a pressure unit via the "Press. eng. unit (125)" parameter, here "mbar" for example. Menu path: Setup → Press. eng. unit (125)	
4	Select the "in height" level mode via the "Level selection (024)" parameter. Menu path: Setup → Extended Setup → Level → Level selection (024)	
5	Select a volume unit via the "Unit before lin (025)" parameter, here "l" (liter) for example. Menu path: Setup → Extended Setup → Level → Unit before lin (025)	

	Description	
6	Select a level unit by means of the "Height unit (026)" parameter, here "m" for example. Menu path: Setup → Extended Setup → Level → Height unit (026)	 <p style="text-align: right;"><small>P01-xxxxxxx-05-xx-xx-xx-029</small></p>
7	Select the "Wet" option by means of the "Calibration mode (027)" parameter. Menu path: Setup → Extended Setup → Level → Calibration mode (027)	
8	If calibration is performed with a medium other than the process medium, enter the density of the calibration medium in the "Adjust density (034)" parameter, here 1 g/cm ³ (1 SGU) for example. Menu path: Setup → Extended Setup → Level → Adjust density (034)	
9	The pressure for the lower calibration point is present at the device, here 0.5 m covered / 49 mbar (0.71 psi) for example. Enter the volume value for the lower calibration point via the "Empty calib. (028)" parameter, here 0 liters for example. Menu path: Setup → Extended Setup → Level → Empty calib. (028)	 <p style="text-align: right;"><small>P01-xxxxxxx-05-xx-xx-xx-001</small></p>
10	The pressure for the upper calibration point is present at the device, here 4.5 m covered / 441 mbar (6.4 psi) for example. Enter the volume value for the upper calibration point via the "Full calib. (031)" parameter, here "1000 liters" (264 gal) for example. Menu path: Setup → Extended Setup → Level → Full calib. (031)	
11	If calibration was performed with a medium other than the process medium, specify the density of the process medium in the "Process density (035)" parameter. Menu path: Setup → Extended Setup → Level → Process density (035)	
12	Result: The measuring range is set for 0 to 1000 l (264 gal).	<p>1 See Table, Step 8. 2 See Table, Step 9. 3 See Table, Step 10.</p>

Fig. 14: Calibration with reference pressure – wet calibration



Note!

The measured variables %, level, volume and mass are available for this level mode see parameter "Unit before lin (025)" in the Operating Instructions.

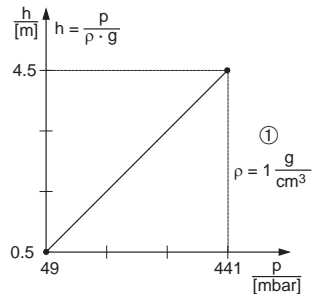
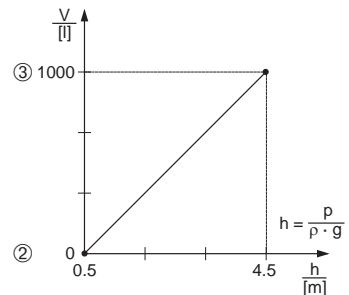
7.5 Linearization

7.5.1 Manual entry of the linearization table via onsite display

Example:

In this example, the volume in a tank with a conical outlet should be measured in m³.

Prerequisite:

- This is a theoretical calibration, i.e. the points for the linearization table are known.
- The "Level" operating mode has been selected.
- A level calibration in m has been performed.



Note!

For a description of the parameters mentioned, see Operating Instructions.

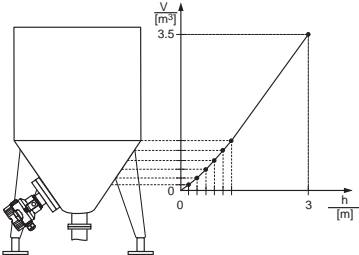
	Description	
1	Select the "Manual entry" option via the "Lin. mode (037)" parameter. Menu path: Setup → Extended Setup → Linearization → Lin. mode (037)	 <p style="text-align: right; font-size: small;">P01-Mxxxxxxx-19-xx-xx-xx-000</p>
2	Select a unit via the "Unit after lin. (038)" parameter, e.g. m ³ . Menu path: Setup → Extended Setup → Linearization → Unit after lin. (038)	
3	Enter the number of the point in the table via the "Line numb. (039)" parameter. Menu path: Setup → Extended Setup → Linearization → Line numb. (039) The level is entered via the "X-value (040) (manual entry)" parameter, here 0 m for example. Confirm your entry. Menu path: Setup → Extended Setup → Linearization → X-value (040) (manual entry) Using the "Y-value (041) (manual entry/in semi-auto. entry)" parameter, enter the associated volume value, here 0 m ³ for example, and confirm the value. Menu path: Setup → Extended Setup → Linearization → Y-value (041) (manual entry/in semi-auto. entry)	

	Description
4	To enter another point in the table, select the "Next point" option via the "Edit table (042)" parameter. Enter the next point as explained in Step 3. Menu path: Setup → Extended Setup → Linearization → Edit table (042)
5	Once all the points have been entered in the table, select the "Activate table" option via the "Lin. mode (037)" parameter. Menu path: Setup → Extended Setup → Linearization → Lin. mode (037)
6	Result: The measured value after linearization is displayed.



Note!

Error message F510 "Linearization" is displayed as long as the table is being entered and is not activated.

7.5.2 Manual entry of the linearization table via the operating tool

Using an operating tool based on FDT technology (e.g. FieldCare), you can enter linearization using a module specially designed for this purpose. This provides you with an overview of the selected linearization even during entry. In addition, it is possible to access preprogrammed tank shapes.



Note!

The linearization table may also be entered manually point by point in the operating tool menu, see → Chap. 7.5.1 "Manual entry of the linearization table via onsite display".

7.5.3 Semi-automatic entry of the linearization table

Example:

In this example, the volume in a tank with a conical outlet should be measured in m³.

Prerequisite:

- The tank can be filled or emptied. The linearization characteristic must rise continuously.
- A level calibration has been performed.



Note!

For a description of the parameters mentioned, see Operating Instructions.

	Description
1	Select the "Semi-auto. entry" option via the "Lin. mode (037)" parameter. Menu path: Setup → Extended Setup → Linearization → Lin. mode (037)
2	Select a unit via the "Unit after lin. (038)" parameter, e.g. m ³ . Menu path: Setup → Extended Setup → Linearization → Unit after lin. (038)
3	Fill the tank to the height of the 1st point.
4	Enter the number of the point in the table via the "Line numb. (039)" parameter. Menu path: Setup → Extended Setup → Linearization → Line numb. (039)
	The actual level is displayed via the "X-value (040) (manual entry)" parameter. Menu path: Setup → Extended Setup → Linearization → X-value (040) (manual entry)
	Using the "Y-value (041) (manual entry/in semi-auto. entry)" parameter, enter the associated volume value, here 0 m ³ for example, and confirm the value. Menu path: Setup → Extended Setup → Linearization → Y-value (041) (manual entry/in semi-auto. entry)
5	To enter another point in the table, select the "Next point" option via the "Edit table (042)" parameter. Enter the next point as explained in Step 4. Menu path: Setup → Extended Setup → Linearization → Edit table (042)
6	Once all the points have been entered in the table, select the "Activate table" option via the "Lin. mode (037)" parameter. Menu path: Setup → Extended Setup → Linearization → Lin. mode (037)
7	Result: The measured value after linearization is displayed.

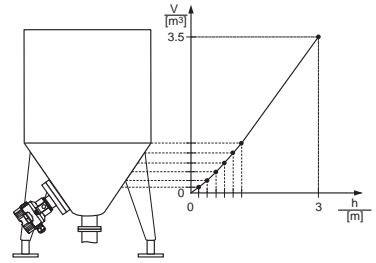

P01-Mxxxxxxx-19-xx-xx-xx-006

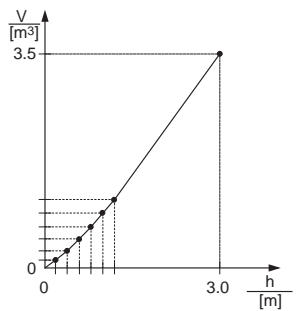

P01-Mxxxxxxx-05-xx-xx-xx-015

Fig. 15: Semi-automatic entry of the linearization table



Note!

Error message F510 "Linearization" is displayed as long as the table is being entered and is not activated.

7.6 Pressure measurement

7.6.1 Calibration without reference pressure (dry calibration)

Example:

In this example, a device with a 400 mbar (6 psi) sensor is configured for the 0 to +300 mbar (4.35 psi) measuring range, i.e. 0 mbar and 300 mbar (4.35 psi) are assigned.

Prerequisite:

This is a theoretical calibration, i.e. the pressure values for the lower and upper range are known.



Note!

Due to the orientation of the device, there may be pressure shifts in the measured value, i.e. the measured value is not zero in a pressureless condition. For information on how to perform position adjustment, see → 30. Calibration is possible only using FieldCare.

	Description
1	Select the "Pressure" measuring mode via the "Measuring mode (005)" parameter. Menu path: Setup → Measuring mode (005)
2	Select a pressure unit via the "Press. eng. unit (125)" parameter, here "mbar" for example. Menu path: Setup → Press. eng. unit (125)
3	Where necessary scale the "Output value (Out Value)" of the Analog Input Block, see Operating Instructions.
4	Result: The measuring range is configured for 0 to +300 mbar (4.35 psi).

www.endress.com/worldwide

Endress+Hauser 
People for Process Automation

KA01031P/00/EN/04.14
71269377
CCS/FM+SGML 9

