

RIGOL

User's Guide

DS6000 Series Digital Oscilloscope

Dec. 2015

RIGOL TECHNOLOGIES, INC.

Guaranty and Declaration

Copyright

© 2010 **RIGOL** TECHNOLOGIES, INC. All Rights Reserved.

Trademark Information

RIGOL is a registered trademark of **RIGOL** TECHNOLOGIES, INC.

Publication Number

UGA06116-1110

Software Version

00.02.00.SP5

Software upgrade might change or add product features. Please acquire the latest version of the manual from **RIGOL** website or contact **RIGOL** to upgrade the software.

Notices

- **RIGOL** products are covered by P.R.C. and foreign patents, issued and pending.
- **RIGOL** reserves the right to modify or change parts of or all the specifications and pricing policies at the company's sole decision.
- Information in this publication replaces all previously released materials.
- Information in this publication is subject to change without notice.
- **RIGOL** shall not be liable for either incidental or consequential losses in connection with the furnishing, use, or performance of this manual, as well as any information contained.
- Any part of this document is forbidden to be copied, photocopied, or rearranged without prior written approval of **RIGOL**.

Product Certification

RIGOL guarantees that this product conforms to the national and industrial standards in China as well as the ISO9001:2008 standard and the ISO14001:2004 standard. Other international standard conformance certifications are in progress.

Contact Us

If you have any problem or requirement when using our products or this manual, please contact **RIGOL**.

E-mail: service@rigol.com

Website: www.rigol.com

Safety Requirement

General Safety Summary

Please review the following safety precautions carefully before putting the instrument into operation so as to avoid any personal injury or damage to the instrument and any product connected to it. To prevent potential hazards, please follow the instructions specified in this manual to use the instrument properly.

Use Proper Power Cord.

Only the exclusive power cord designed for the instrument and authorized for use within the local country could be used.

Ground the Instrument.

The instrument is grounded through the Protective Earth lead of the power cord. To avoid electric shock, connect the earth terminal of the power cord to the Protective Earth terminal before connecting any input or output terminals.

Connect the Probe Correctly.

If a probe is used, do not connect the ground lead to high voltage since it has isobaric electric potential as the ground.

Observe All Terminal Ratings.

To avoid fire or shock hazard, observe all ratings and markers on the instrument and check your manual for more information about ratings before connecting the instrument.

Use Proper Overvoltage Protection.

Ensure that no overvoltage (such as that caused by a bolt of lightning) can reach the product. Otherwise, the operator might be exposed to the danger of an electric shock.

Do Not Operate Without Covers.

Do not operate the instrument with covers or panels removed.

Do Not Insert Anything Into the Air Outlet.

Do not insert anything into the air outlet to avoid damage to the instrument.

Use Proper Fuse.

Please use the specified fuses.

Avoid Circuit or Wire Exposure.

Do not touch exposed junctions and components when the unit is powered on.

Do Not Operate With Suspected Failures.

If you suspect that any damage may occur to the instrument, have it inspected by **RIGOL** authorized personnel before further operations. Any maintenance, adjustment or replacement especially to circuits or accessories must be performed by **RIGOL** authorized personnel.

Provide Adequate Ventilation.

Inadequate ventilation may cause an increase of temperature in the instrument, which would cause damage to the instrument. So please keep the instrument well ventilated and inspect the air outlet and the fan regularly.

Do Not Operate in Wet Conditions.

To avoid short circuit inside the instrument or electric shock, never operate the instrument in a humid environment.

Do Not Operate in an Explosive Atmosphere.

To avoid personal injuries or damage to the instrument, never operate the instrument in an explosive atmosphere.

Keep Instrument Surfaces Clean and Dry.

To avoid dust or moisture from affecting the performance of the instrument, keep the surface of the instrument clean and dry.

Prevent Electrostatic Impact.

Operate the instrument in an electrostatic discharge protective environment to avoid damage induced by static discharges. Always ground both the internal and external conductors of cables to release static before making connections.

Use the Battery Properly.

Do not expose the battery (if available) to high temperature or fire. Keep it out of the reach of children. Improper change of a battery (lithium battery) may cause an explosion. Use **RIGOL** specified battery only.

Handle with Caution.

Please handle with care during transportation to avoid damage to keys, knobs, interfaces, and other parts on the panels.

Safety Notices and Symbols

Safety Notices in this Manual:

**WARNING**

Indicates a potentially hazardous situation or practice which, if not avoided, will result in serious injury or death.

**CAUTION**

Indicates a potentially hazardous situation or practice which, if not avoided, could result in damage to the product or loss of important data.

Safety Terms on the Product:

DANGER It calls attention to an operation, if not correctly performed, could result in injury or hazard immediately.

WARNING It calls attention to an operation, if not correctly performed, could result in potential injury or hazard.

CAUTION It calls attention to an operation, if not correctly performed, could result in damage to the product or other devices connected to the product.

Safety Symbols on the Product:



Hazardous
Voltage



Safety
Warning



Protective
Earth
Terminal



Chassis
Ground



Test
Ground

Allgemeine Sicherheits Informationen

Überprüfen Sie die folgenden Sicherheitshinweise sorgfältig um Personenschäden oder Schäden am Gerät und an damit verbundenen weiteren Geräten zu vermeiden. Zur Vermeidung von Gefahren, nutzen Sie bitte das Gerät nur so, wie in diesem Handbuch angegeben.

Um Feuer oder Verletzungen zu vermeiden, verwenden Sie ein ordnungsgemäßes Netzkabel.

Verwenden Sie für dieses Gerät nur das für ihr Land zugelassene und genehmigte Netzkabel.

Erden des Gerätes.

Das Gerät ist durch den Schutzleiter im Netzkabel geerdet. Um Gefahren durch elektrischen Schlag zu vermeiden, ist es unerlässlich, die Erdung durchzuführen. Erst dann dürfen weitere Ein- oder Ausgänge verbunden werden.

Anschluss eines Tastkopfes.

Die Erdungsklemmen der Sonden sind auf dem gleichen Spannungspegel des Instruments geerdet. Schließen Sie die Erdungsklemmen an keine hohe Spannung an.

Beachten Sie alle Anschlüsse.

Zur Vermeidung von Feuer oder Stromschlag, beachten Sie alle Bemerkungen und Markierungen auf dem Instrument. Befolgen Sie die Bedienungsanleitung für weitere Informationen, bevor Sie weitere Anschlüsse an das Instrument legen.

Verwenden Sie einen geeigneten Überspannungsschutz.

Stellen Sie sicher, daß keinerlei Überspannung (wie z.B. durch Gewitter verursacht) das Gerät erreichen kann. Andernfalls besteht für den Anwender die Gefahr eines Stromschlages.

Nicht ohne Abdeckung einschalten.

Betreiben Sie das Gerät nicht mit entfernten Gehäuse-Abdeckungen.

Betreiben Sie das Gerät nicht geöffnet.

Der Betrieb mit offenen oder entfernten Gehäuseteilen ist nicht zulässig. Nichts in entsprechende Öffnungen stecken (Lüfter z.B.)

Passende Sicherung verwenden.

Setzen Sie nur die spezifikationsgemäßen Sicherungen ein.

Vermeiden Sie ungeschützte Verbindungen.

Berühren Sie keine unisolierten Verbindungen oder Baugruppen, während das Gerät in Betrieb ist.

Betreiben Sie das Gerät nicht im Fehlerfall.

Wenn Sie am Gerät einen Defekt vermuten, sorgen Sie dafür, bevor Sie das Gerät wieder betreiben, dass eine Untersuchung durch **RIGOL** autorisiertem Personal durchgeführt wird. Jedwede Wartung, Einstellarbeiten oder Austausch von Teilen am Gerät, sowie am Zubehör dürfen nur von **RIGOL** autorisiertem Personal durchgeführt werden.

Belüftung sicherstellen.

Unzureichende Belüftung kann zu Temperaturanstiegen und somit zu thermischen Schäden am Gerät führen. Stellen Sie deswegen die Belüftung sicher und kontrollieren regelmäßig Lüfter und Belüftungsöffnungen.

Nicht in feuchter Umgebung betreiben.

Zur Vermeidung von Kurzschluß im Geräteinneren und Stromschlag betreiben Sie das Gerät bitte niemals in feuchter Umgebung.

Nicht in explosiver Atmosphäre betreiben.

Zur Vermeidung von Personen- und Sachschäden ist es unumgänglich, das Gerät ausschließlich fernab jedweder explosiven Atmosphäre zu betreiben.

Geräteoberflächen sauber und trocken halten.

Um den Einfluß von Staub und Feuchtigkeit aus der Luft auszuschließen, halten Sie bitte die Geräteoberflächen sauber und trocken.

Schutz gegen elektrostatische Entladung (ESD).

Sorgen Sie für eine elektrostatisch geschützte Umgebung, um somit Schäden und

Funktionsstörungen durch ESD zu vermeiden. Erden Sie vor dem Anschluß immer Innen- und Außenleiter der Verbindungsleitung, um statische Aufladung zu entladen.

Die richtige Verwendung des Akku.

Wenn eine Batterie verwendet wird, vermeiden Sie hohe Temperaturen bzw. Feuer ausgesetzt werden. Bewahren Sie es außerhalb der Reichweite von Kindern auf. Unsachgemäße Änderung der Batterie (Anmerkung: Lithium-Batterie) kann zu einer Explosion führen. Verwenden Sie nur von **RIGOL** angegebenen Akkus.

Sicherer Transport.

Transportieren Sie das Gerät sorgfältig (Verpackung!), um Schäden an Bedienelementen, Anschlüssen und anderen Teilen zu vermeiden.

Sicherheits Begriffe und Symbole

Begriffe in diesem Guide:



WARNING

Die Kennzeichnung WARNING beschreibt Gefahrenquellen die leibliche Schäden oder den Tod von Personen zur Folge haben können.



CAUTION

Die Kennzeichnung Caution (Vorsicht) beschreibt Gefahrenquellen die Schäden am Gerät hervorrufen können.

Begriffe auf dem Produkt:

DANGER weist auf eine Verletzung oder Gefährdung hin, die sofort geschehen kann.

WARNING weist auf eine Verletzung oder Gefährdung hin, die möglicherweise nicht sofort geschehen.

CAUTION weist auf eine Verletzung oder Gefährdung hin und bedeutet, dass eine mögliche Beschädigung des Instruments oder anderer Gegenstände auftreten kann.

Symbole auf dem Produkt:



Gefährliche
Spannung



Sicherheits-
Hinweis



Schutz-erde



Gehäusemasse



Erde

Measurement Category

DS6000 series digital oscilloscopes can make measurements in Measurement Category I.



WARNING

This oscilloscope can only be used for measurements within its specified measurement categories.

Measurement Category Definitions

Measurement category I is for measurements performed on circuits not directly connected to MAINS. Examples are measurements on circuits not derived from MAINS, and specially protected (internal) MAINS derived circuits. In the latter case, transient stresses are variable; for that reason, the transient withstand capability of the equipment is made known to the user.

Measurement category II is for measurements performed on circuits directly connected to the low voltage installation. Examples are measurements on household appliances, portable tools and similar equipment.

Measurement category III is for measurements performed in the building installation. Examples are measurements on distribution boards, circuit-breakers, wiring, including cables, bus-bars, junction boxes, switches, socket-outlets in the fixed installation, and equipment for industrial use and some other equipment, for example, stationary motors with permanent connection to the fixed installation.

Measurement category IV is for measurements performed at the source of the low-voltage installation. Examples are electricity meters and measurements on primary overcurrent protection devices and ripple control units.

Ventilation Requirement

This oscilloscope uses a fan to force cooling. Please make sure that the air intake and exhaust areas are free from obstructions and have free air. When using the oscilloscope in a bench-top or rack setting, provide at least 10 cm clearance beside, above and behind the instrument for adequate ventilation.



WARNING

Inadequate ventilation may cause a temperature increase, which can damage the instrument. So please keep the instrument well ventilated during operation and inspect the air outlet and the fan regularly.

Working Environment

Temperature

Operating: 0°C to +50°C

Non-operating: -20°C to +70°C

Humidity

Under +35°C: ≤90% relative humidity

+35°C to +40°C: ≤60% relative humidity



WARNING

To avoid short circuit inside the instrument or electric shock, please do not operate in humid environment.

Altitude

Operating: less than 3 km

Non-operating: less than 15 km

Installation (Overvoltage) Category

This product is powered by MAINS conforming to installation (overvoltage) category II.



WARNING

Ensure that no overvoltage (such as that caused by a bolt of lightning) can reach the product. Otherwise, the operator might be exposed to the danger of an electric shock.

Installation (Overvoltage) Category Definitions

Installation (overvoltage) category I refers to signal level which is applicable to equipment measurement terminals connected to the source circuit. Among these terminals, precautions are done to limit the transient voltage to the corresponding low level.

Installation (overvoltage) category II refers to the local power distribution level which is applicable to equipment connected to the AC line (AC power).

Pollution Degree

Pollution Degree 2

Pollution Degree Definitions

Pollution Degree 1: No pollution or only dry, non-conductive pollution occurs. The pollution has no impact on the equipment. For example, a clean room or an air-conditioned office.

Pollution Degree 2: Normally only dry, non-conductive pollution occurs. Occasionally a temporary conductivity caused by condensation may occur. For example, indoor environment, laboratories, and test stations.

Pollution Degree 3: Conductive pollution or dry non-conductive pollution that becomes conductive due to condensation occurs. For example, industrial environment or construction sites (harsh environments).

Pollution Degree 4: Pollution that generates persistent conductivity through conductive dust, rain, or snow. For example, outdoor areas.

Safety Class

Class 1 – Grounded Product

Care and Cleaning

Care

Do not store or leave the instrument where it may be exposed to direct sunlight for long periods of time.

Cleaning

Clean the instrument regularly according to its operating conditions. To clean the exterior surface, perform the following steps:

1. Disconnect the instrument from all power sources.
2. Clean the external surfaces of the instrument with a soft cloth dampened with mild detergent or water. When cleaning the LCD, take care to avoid scarifying it.



CAUTION

To avoid damage to the instrument, do not expose it to caustic liquids.



WARNING

To avoid short-circuit resulting from moisture or personal injuries, ensure that the instrument is completely dry before reconnecting it to the power supply.

Environmental Considerations

The following symbol indicates that this product complies with the WEEE Directive 2002/96/EC.



Product End-of-Life Handling

The equipment may contain substances that could be harmful to the environment or human health. To avoid the release of such substances into the environment and avoid harm to human health, we recommend you to recycle this product appropriately to ensure that most materials are reused or recycled properly. Please contact your local authorities for disposal or recycling information.

From: RIGOL Technologies Inc

Date: May 5, 2014

156# Cai He Village, Sha He Town, Chang Ping District, Beijing, China

<http://www.rigol.com>

Declaration of RoHS&WEEE Conformity

RoHS: The European Union of 2011/65/EU Restriction of Hazardous Substances (RoHS) Directive, which applies to all electrical products and their component parts, offered for sale into the European Union after July 22, 2014, restricts the presence of the six substances: Lead (Pb), Cadmium (Cd), Mercury (Hg), Hexavalent Chromium (Cr⁶⁺), Polybrominated biphenyl ethers (PBBs), and Polybrominated diphenyl ethers (PBDEs). In view of legal and market requirements, Rigol has restricted use of Pb, Cd, Hg, Cr⁶⁺, PBBs, PBDEs in our products. In addition, we require all our direct suppliers to strictly limit or prohibit use of hazardous substances. All its AVL (Approved Vendors List) components apply for RoHS.

Content of Compliance

Lead	<0.1% by weight (1000 ppm)	Mercury	<0.1% by weight (1000 ppm)
Cadmium	<0.01% by weight (100 ppm)	Hexavalent Chrome (Cr ⁶⁺)	<0.1% by weight (1000 ppm)
PBBs	<0.1% by weight (1000 ppm)	PBDEs	<0.1% by weight (1000 ppm)

WEEE: The European Union of 2012/19/EU, Waste Electrical and Electronic Equipment percentage of reused, recycled and recovered materials, such as metals, plastics, and components of waste electrical and electronic equipment.

We are registered in Germany in the WEEE (in Germany, EAR) register as a manufacturer of category 9 (monitoring and control) equipment and have the assigned registration number

WEEE-Reg.-No. : DE88132002

in our commercial documents.

RIGOL Technologies Inc

Weiming Mao

Director of Central Quality and

Environmental Management



DS6000 Series Overview

DS6000 is a digital oscilloscope with multiple functions and high performance. It is easy to use, perfectly integrating superb technical specifications and various functions to help users to fulfill their tasks (such as quick measurement of parameters, remote interface configuration, and easy connection to the printer) more quickly.

Main Features:

- 1 GHz or 600 MHz bandwidth
- 2-channel or 4-channel model
- Up to 5 GSa/s real-time sample rate, 100 GSa/s equivalent sample rate, 180,000 wfms/s (dots display) waveform capture rate
- Up to 140 Mpts memory depth (standard)
- Unique Ultra Vision technology
- 10.1-inch WVGA (800*480) 160,000 color TFT LCD, with ultra-wide screen, vivid picture, low power consumption, and long service life
- Capable of identifying the probe type automatically
- Adjustable brightness of analog channel waveform
- Auto setting of waveform display (**Auto**)
- Various trigger functions, including multiple protocol triggers
- Standard parallel decoding, multiple serial decoding options available
- Auto measurements of 29 waveform parameters and measurement functions with statistic
- Real-time waveform recording, playback and analysis functions
- Fine delayed sweep function
- Built-in FFT function
- Pass/fail test function
- Multiple waveform math operation functions
- Standard configuration interfaces: USB DEVICE, dual USB HOST, LAN and GPIB (optional)
- USB storage device storage and PictBridge printer supported
- LXI-C instrument standards compliance; capable of creating and reconfiguring the test system in a fast, economical, and efficient manner
- Remote command control supported
- Embedded help to facilitate information access

- Multiple languages and Chinese/English input supported
- One-key measurement, storage and printing
- Over 2 hours' charging for the Lithium battery (optional) to facilitate on-site test and use
- Built-in 1 GBytes flash memory

Document Overview

Main Topics of this Manual:

1 Quick Start

Describe the preparations before using the instrument and generally introduce the instrument.

2 To Set the Vertical System

Introduce the functions of the vertical system of the oscilloscope.

3 To Set the Horizontal System

Introduce the functions of the horizontal system of the oscilloscope.

4 To Set the Sample System

Introduce the functions of the sample system of the oscilloscope.

5 To Trigger the Oscilloscope

Introduce the trigger mode, trigger coupling, trigger holdoff, external trigger and various trigger types of the oscilloscope.

6 To Make Measurements

Introduce how to make math operation, cursor measurement and auto measurement.

7 Protocol Decoding

Introduce how to decode the input signal using those common protocols.

8 Reference Waveform

Introduce how to compare the input waveform with the reference waveform.

9 Pass/Fail Test

Introduce how to monitor the input signal using the Pass/Fail test.

10 Waveform Recording

Introduce how to record the waveform as well as play back and analyze the recorded waveform.

11 Display Control

Introduce how to control the display of the oscilloscope.

12 Store and Recall

Introduce how to perform internal/external storage and recall.

13 System Function Setting

Introduce how to configure the remote interfaces, set the system-related functions and print waveforms.

14 Remote Control

Introduce how to perform remote control of the oscilloscope.

15 Troubleshooting

Introduce how to deal with common failures of the oscilloscope.

16 Specifications

List the technical resolutions and general specifications of the oscilloscope.

17 Appendix

Provide the options and accessories information.

Format Conventions in this Manual:

1. Key

The key on the front panel is denoted by the format of "Button Name (Bold) + Text Box". For example, **SAVE** denotes the "SAVE" key.





2. Menu softkey

The menu softkey is denoted by the format of "Menu Word (Bold) + Character Shading". For example, **Storage** denotes the "Storage" menu softkey under the **SAVE**.

3. Operation step

The next step of operation is denoted by an arrow "→". For example, **SAVE** → **Storage** denotes pressing **SAVE** on the front panel and then pressing **Storage**.

4. Knob

Label	Knob
HORIZONTAL  SCALE	Horizontal Time Base Knob
HORIZONTAL  POSITION	Horizontal Position Knob
VERTICAL  SCALE	Channel Vertical Scale Knob
VERTICAL  POSITION	Channel Vertical Position Knob
TRIGGER  LEVEL	Trigger Level Knob

Content Conventions in this Manual:

DS6000 series includes the following models. Unless otherwise noted, DS6104 is taken as an example to illustrate the functions and operation methods of DS6000 series.

Model	DS6104	DS6102	DS6064	DS6062
Analog Bandwidth	1 GHz	1 GHz	600 MHz	600 MHz
Number of Channels	4	2	4	2
Max. Real-time Sample Rate	5 GSa/s			
Standard Memory Depth	140 Mpts			
Waveform Capture Rate	Up to 180,000 wfms/s			

Contents

Guaranty and Declaration	I
Safety Requirement	II
General Safety Summary.....	II
Safety Notices and Symbols	V
Allgemeine Sicherheits Informationen	VI
Sicherheits Begriffe und Symbole.....	IX
Measurement Category.....	X
Ventilation Requirement.....	XI
Working Environment	XII
Care and Cleaning.....	XIV
Environmental Considerations.....	XV
DS6000 Series Overview	XVII
Document Overview	XIX
1 Quick Start	1-1
General Inspection	1-2
Appearance and Dimensions	1-3
Preparations for Use.....	1-4
To Remove the Cover	1-4
To Adjust the Supporting Legs	1-5
To Connect to AC Power Supply	1-6
To Use the Battery.....	1-7
Power-on Inspection	1-8
To Connect the Probe.....	1-9
Function Inspection	1-12
Probe Compensation.....	1-14
Front Panel Overview	1-15
Rear Panel Overview	1-17
Front Panel Function Overview	1-19
VERTICAL	1-19
HORIZONTAL	1-21
TRIGGER	1-22
Run/Stop	1-22

Single	1-23
Auto	1-23
Multifunction Knob	1-24
Navigation Knob	1-24
Function Keys	1-25
Record	1-25
MEAS	1-26
Clear	1-26
Print	1-26
User Interface	1-27
Security Lock	1-33
Desk Mount Instrument Arm	1-34
Built-in Help System	1-35
2 To Set the Vertical System	2-1
To Enable the Channel	2-2
Channel Coupling	2-3
Bandwidth Limit	2-4
Probe	2-5
Input Impedance	2-9
Waveform Invert	2-9
Vertical Scale	2-10
Vertical Position	2-11
Vertical Expansion	2-12
Amplitude Unit	2-12
Channel Label	2-13
Delay Calibration	2-14
3 To Set the Horizontal System	3-1
Delayed Sweep	3-2
Time Base Mode	3-4
Y-T Mode	3-4
X-Y Mode	3-5
Roll Mode	3-8
Horizontal Scale	3-9
Horizontal Position	3-9
Horizontal Reference	3-11
4 To Set the Sample System	4-1

Acquisition Mode	4-2
Normal	4-2
Average	4-2
Peak Detect	4-4
High Resolution	4-4
Sample Mode.....	4-5
Real-time Sample	4-5
Equivalent Sample	4-5
Sample Rate	4-6
Memory Depth.....	4-8
Anti-aliasing	4-9
5 To Trigger the Oscilloscope	5-1
Trigger Source	5-2
Trigger Mode	5-3
Trigger Coupling.....	5-5
Trigger Holdoff.....	5-6
Trigger Type	5-7
Edge Trigger	5-8
Pulse Trigger	5-10
Slope Trigger.....	5-12
Video Trigger.....	5-15
Pattern Trigger	5-17
RS232 Trigger	5-19
I2C Trigger.....	5-21
SPI Trigger.....	5-24
CAN Trigger	5-26
FlexRay Trigger	5-29
USB Trigger.....	5-31
Trigger Output Connector.....	5-33
6 To Make Measurements	6-1
Math Operation.....	6-2
Addition.....	6-2
Subtraction	6-3
Multiplication.....	6-3
Division	6-5
FFT	6-6

Logic Operation	6-9
Advanced Operation.....	6-11
Auto Measurement	6-14
Quick Measurement after Auto	6-15
One-key Measurement	6-16
Frequency Counter Measurement	6-23
Measurement Setting	6-24
To Clear the Measurement	6-26
All Measurement	6-27
Statistic Function	6-28
Measurement History	6-28
Cursor Measurement.....	6-29
Manual Mode.....	6-31
Track Mode	6-35
Auto Mode	6-39
X-Y Mode	6-40
7 Protocol Decoding	7-1
Parallel Decoding.....	7-2
RS232 Decoding (Option).....	7-5
I2C Decoding (Option)	7-10
SPI Decoding (Option)	7-13
CAN Decoding (Option)	7-17
FlexRay Decoding (Option).....	7-21
8 Reference Waveform	8-1
To Enable REF Function.....	8-2
To Set the Color	8-3
To Select REF Source	8-4
To Save to Internal Memory	8-4
To Adjust REF Waveform Display.....	8-4
To Export to Internal or External Memory	8-5
To Import from Internal or External Memory	8-5
9 Pass/Fail Test	9-1
To Enable Pass/Fail Test Function.....	9-2
To Select Source.....	9-3
Mask Range	9-3
Test and Output	9-4

To Save the Test Mask	9-5
To Load the Test Mask	9-5
10 Waveform Recording.....	10-1
Waveform Recording	10-2
Record Constant On	10-4
Waveform Playback	10-5
Waveform Analysis	10-7
Analysis Based on Trace	10-10
Analysis Based on Pass/Fail Mask	10-11
11 Display Control.....	11-1
To Select the Display Type	11-2
To Set the Persistence Time	11-3
To set the Waveform Brightness	11-5
To Set the Screen Grid.....	11-5
To Set the Grid Brightness.....	11-5
To Set the Menu Display	11-5
12 Store and Recall	12-1
Storage System.....	12-2
Storage Type	12-3
Internal Store and Recall	12-5
External Store and Recall	12-8
Disk Management	12-10
To Select File Type.....	12-11
To Create a New File or Folder	12-12
To Delete a File or Folder.....	12-15
To Rename a File or Folder	12-15
To Clear the Local Memory	12-16
Factory.....	12-17
13 System Function Setting	13-1
Remote Interface Configuration.....	13-2
LAN Setting.....	13-2
USB Device	13-6
To Set the GPIB Address	13-6
System-related	13-7
Sound	13-7

Language.....	13-7
System Information.....	13-7
Power-off Recall.....	13-8
System Time	13-8
Self-calibration Information.....	13-9
Screen	13-9
Error Information.....	13-10
Self-calibration.....	13-10
Power Status	13-11
External Trigger Impedance	13-11
Aux Output	13-11
Reference Clock.....	13-12
Option Management.....	13-13
To Print the Waveform	13-15
To Connect the Print Device	13-15
Normal Print.....	13-16
PictBridge Print.....	13-17
14 Remote Control.....	14-1
Remote Control via USB	14-2
Remote Control via LAN	14-6
Remote Control via GPIB.....	14-8
15 Troubleshooting.....	15-1
16 Specifications	16-1
17 Appendix	17-1
Appendix A: Accessories and Options	17-1
Appendix B: Warranty.....	17-2
Index	1

1 Quick Start

This chapter introduces the precautions when using the oscilloscope for the first time. It also provides an overview of the front/rear panel of the oscilloscope, the user interface, and how to use the built-in help system.

Contents in this chapter:

- General Inspection
- Appearance and Dimensions
- Preparations for Use
- Front Panel Overview
- Rear Panel Overview
- Front Panel Function Overview
- User Interface
- Security Lock
- Desk Mount Instrument Arm
- Built-in Help System

General Inspection

1. Inspect the packaging

If the packaging has been damaged, do not dispose the damaged packaging or cushioning materials until the shipment has been checked for completeness and has passed both electrical and mechanical tests.

The consigner or carrier shall be liable for the damage to the instrument resulting from shipment. **RIGOL** would not be responsible for free maintenance/rework or replacement of the instrument.

2. Inspect the instrument

In case of any mechanical damage, missing parts, or failure in passing the electrical and mechanical tests, contact your **RIGOL** sales representative.

3. Check the accessories

Please check the accessories according to the packing lists. If the accessories are damaged or incomplete, please contact your **RIGOL** sales representative.

Appearance and Dimensions

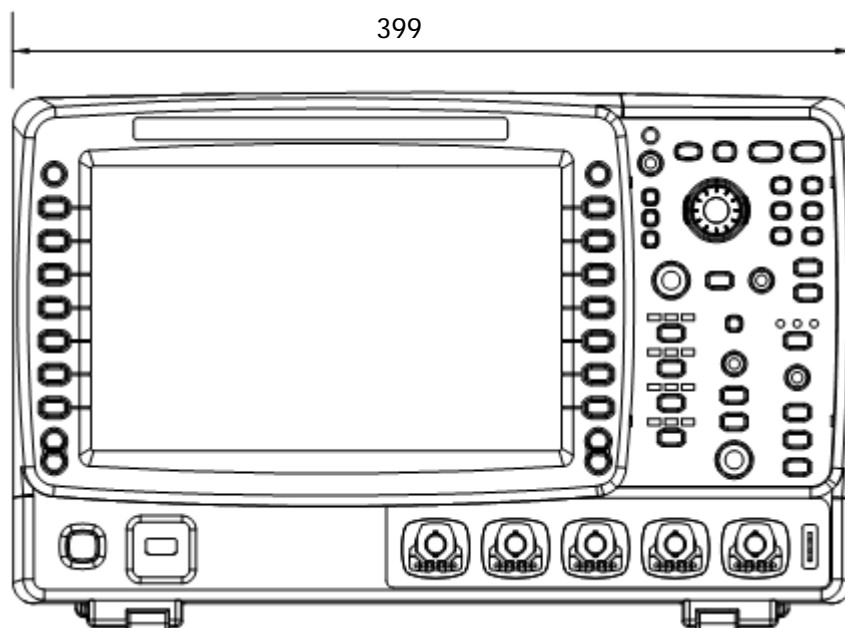

Figure 1-1 Front View

Unit: mm

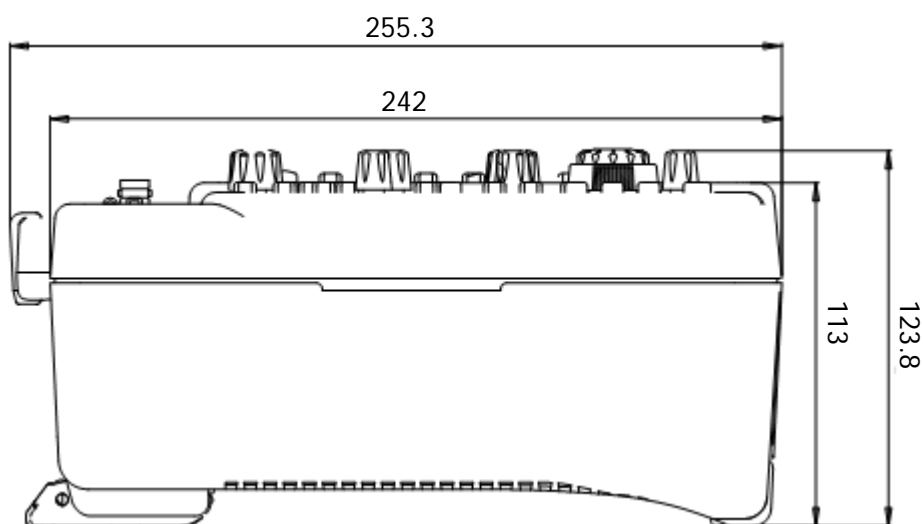

Figure 1-2 Side View

Unit: mm

Preparations for Use

To Remove the Cover

Before using the oscilloscope, remove the front panel cover by grasping the transverse grab on each side and pull them in the arrow directions as shown in the figure below.

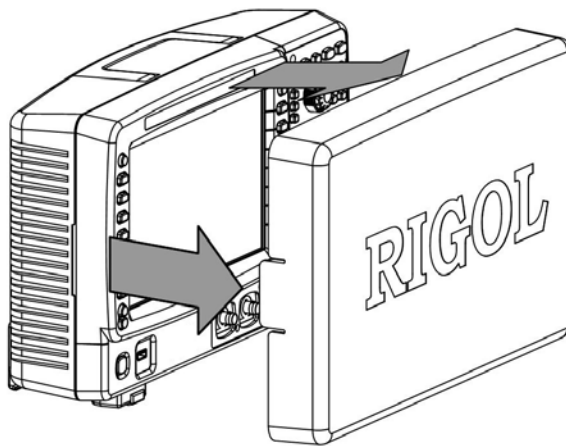

Figure 1-3 To Remove the Cover

To Adjust the Supporting Legs

Adjust the supporting legs properly to use them as stands to tilt the oscilloscope upwards for stable placement of the oscilloscope as well as better operation and observation of the display. Unfold or fold the supporting legs in the arrow directions as shown in the figures below.

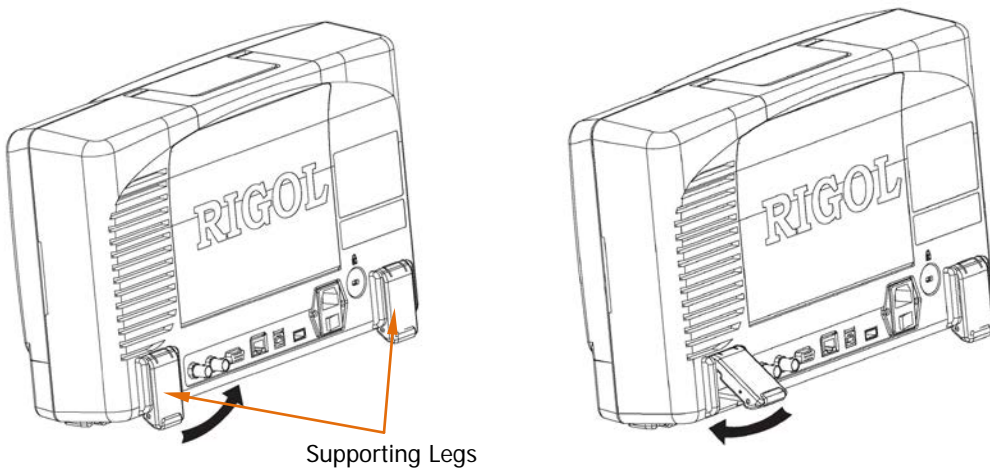



Figure 1-4 To Adjust the Supporting Legs

To Connect to AC Power Supply

This oscilloscope accepts two kinds of AC power supplies: 100-127 V, 45-440 Hz and 100-240 V, 45-65 Hz. Please use the power cord supplied with the accessories to connect the oscilloscope to the AC power supply via the power socket as shown in the figure below. After the power switch is turned on, the oscilloscope is energized and the power key  at the lower-left corner of the front panel is in breathing state.

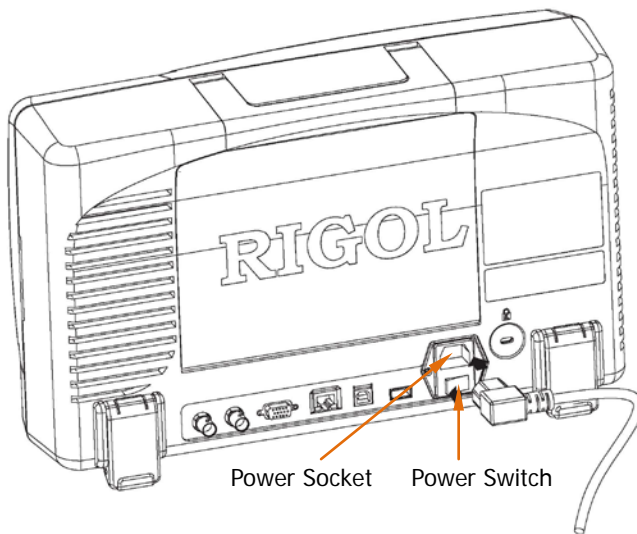



Figure 1-5 To Connect to AC Power Supply

To Use the Battery

This oscilloscope also provides optional rechargeable battery. Please install the battery by referring to the figure below. When the instrument leaves the factory, the battery holds certain electricity. When using the battery alone for power supply, a battery icon  and the remaining electricity (not displayed when the AC power and battery are used at the same time) will be displayed at the lower-right corner of the screen. When the electricity of the battery is too low, "Low Battery!" will be displayed.

If you need to recharge the battery, please install the battery correctly and then connect the oscilloscope to AC power supply to recharge the battery following the instructions in "**To Connect to AC Power Supply**". It needs about 15 hours for recharging the battery.

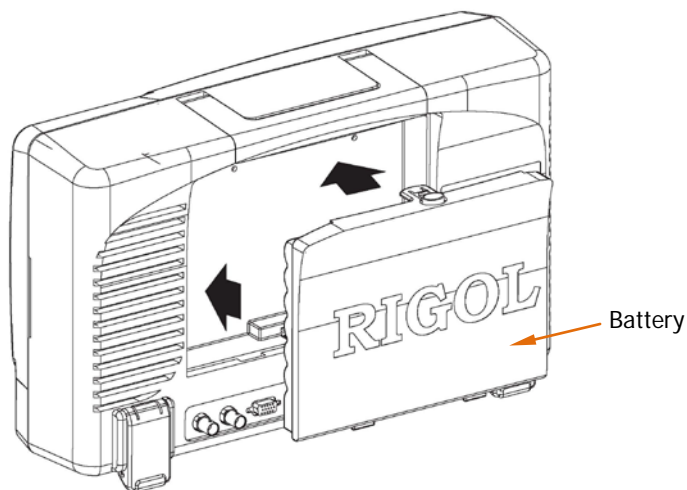



Figure 1-6 To Install the Battery

Power-on Inspection

When the oscilloscope is energized, press the power key  at the lower-left corner of the front panel to turn on the oscilloscope. During the start-up process, the oscilloscope performs a series of self-test items and you can hear the sound of relay switching. After the self-test is finished, the welcome screen is displayed and you can view the option name, option edition and left time of the option currently installed in the "Installed Options" pop-up dialog box on the screen if your instrument is installed with the trial version of the option. When the instrument leaves factory, the trial version of the option is provided and the left time is about 2000 minutes. You can press **UTIL** → **System** → **SelfTestInfo** to view the self-test results.

To Connect the Probe

RIGOL provides passive and active probes for DS6000 series oscilloscopes. For detailed technical information of the probes, please refer to corresponding Probe User's Guide. The following are the probes recommended for this oscilloscope.

Model	Description
RP5600A	600 MHz, passive probe, standard, auto detection
RP3500A	500 MHz, passive probe, optional, auto detection
RP6150A	1.5 GHz, passive probe, DS610X standard, auto detection
RP7150	1.5 GHz, active probe, optional, auto detection

Besides, DS6000 series oscilloscope also supports TekProbe-BNC 2 degree probes (with **RIGOL** T2R1000 interface adaptor, option) of Tektronix.

To connect the passive probe (take RP5600A as an example):

1. Connect the BNC terminal of the probe to the analog channel input terminal or external trigger input terminal of the oscilloscope on the front panel (please refer to "**Front Panel Overview**").
2. Connect the ground alligator clip or ground spring of the probe to the circuit ground terminal and connect the probe tip to the circuit point to be tested.

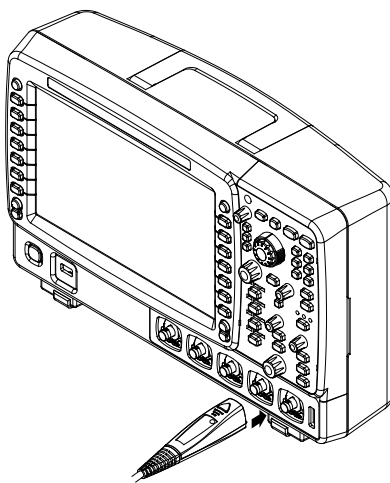
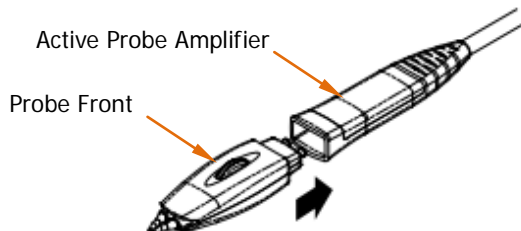

Figure 1-7 To Connect the Probe

After connecting the passive probe, you need to perform probe function inspection and probe compensation before making measurements. For the detailed steps, refer to "**Function Inspection**" and "**Probe Compensation**".

To connect the active probe (take RP7150 (with differential probe front) as an example):

1. Connect the probe front with the active probe amplifier.



2. Connect the other end of the active probe amplifier to the analog channel input terminal or external trigger input connector of the oscilloscope on the front panel (please refer to "**Front Panel Overview**") as shown in Figure 1-7. Note that you need to push the probe to the due position to lock it firmly.
3. Connect the probe front to the circuit under test using the probe auxiliary equipment.

After connecting the active probe, you can perform probe calibration and offset voltage adjustment according to your need. For the detailed steps, refer to "**Probe**".

To connect the Tek probe:

1. Insert the Tek probe to one end of T2R1000 adaptor correctly.

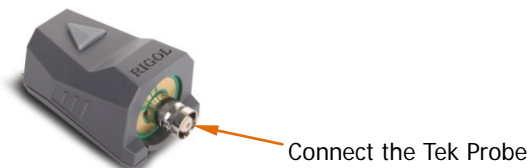

2. Connect the other end of T2R1000 adaptor to the analog channel input terminal or external trigger input terminal (refer to "**Front Panel Overview**") of the oscilloscope on the front panel correctly.

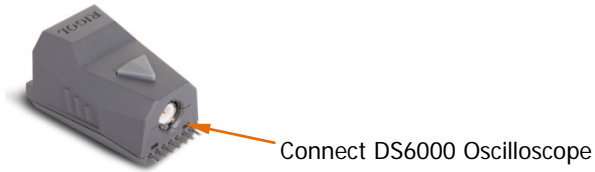

3. Connect the ground terminal of Tek probe to the ground terminal of the circuit. Connect the probe tip of Tek probe to the test point of the circuit under test.

For the specified model of Tek probe, you can perform probe calibration and offset voltage adjustment after the probe is connected according to your need. For the details, refer to "**Probe**".

Function Inspection

After the passive probe is successfully connected, you need to perform probe function inspection following the steps below.

1. Press **SAVE** → **Default** to restore the oscilloscope to its default configuration.
2. Connect the ground alligator clip of the probe to the "Ground Terminal" as shown in Figure 1-8.
3. Use the probe to connect the input terminal of CH1 of the oscilloscope and the "Probe Compensation Signal Output Terminal" as shown in Figure 1-8.

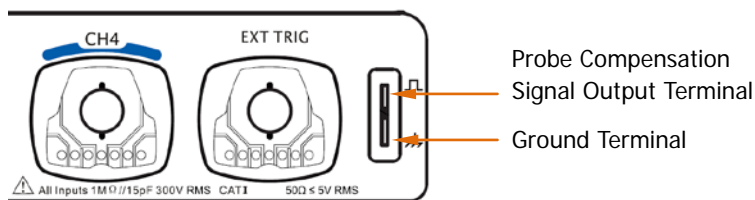

Figure 1-8 To Use the Compensation Signal

4. Press **Auto**.
5. Observe the waveform on the screen. In normal condition, a square waveform as shown in the figure below should be displayed; otherwise, please perform "**Probe Compensation**" in the next section.

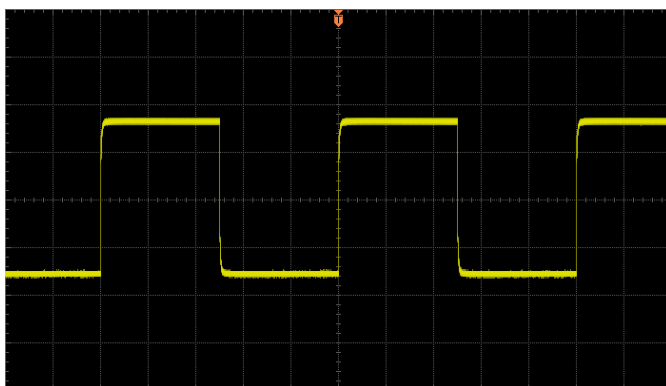

Figure 1-9 Square Waveform

6. Use the same method to test the other channels.

**WARNING**

To avoid electric shock when using the probe, please make sure that the insulated wire of the probe is in good condition and do not touch the metallic part of the probe when the probe is connected to high voltage source.

Tip

The signal output from the probe compensation connector can only be used for probe compensation adjustment and cannot be used for calibration.

Probe Compensation

When the passive probe is used for the first time or when the probe compensation signal does not match the signal as shown in Figure 1-9 (refer to "**Function Inspection**"), you should compensate the probe to make the passive probe match the input channel of the oscilloscope. Non-compensated or poorly compensated passive probes may cause measurement inaccuracy or error. The probe compensation procedures are as follows.

1. Perform steps 1, 2, 3 and 4 of "**Function Inspection**" in the previous section.
2. Check the waveform displayed on the oscilloscope screen and compare it with the waveforms shown in the figure below.

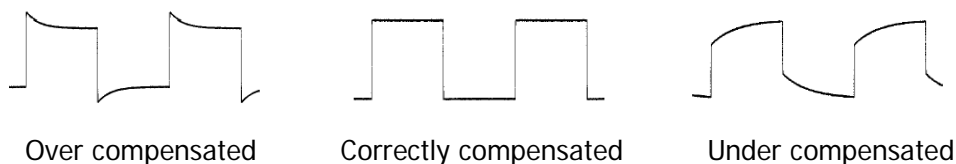

Figure 1-10 Probe Compensation

3. Use a nonmetallic driver to adjust the low-frequency compensation adjustment hole on the probe until the waveform displayed is as the "Correctly compensated" in the figure above.

Front Panel Overview

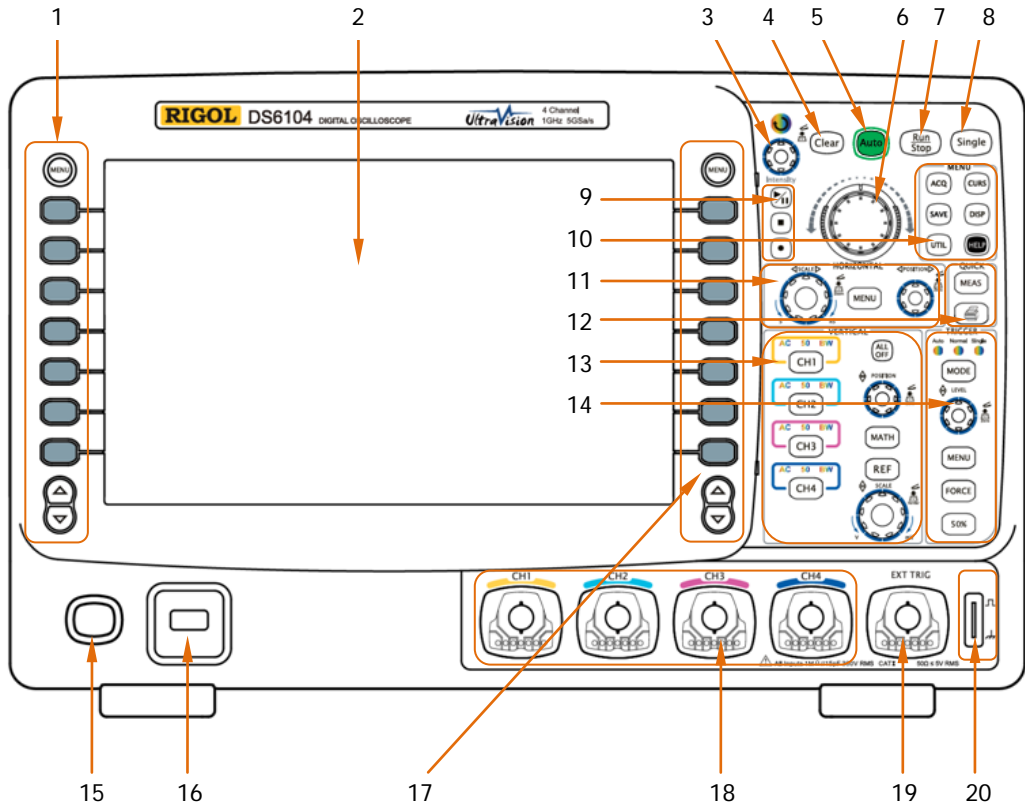

Figure 1-11 Front Panel Overview

Table 1-1 Front Panel Description

No.	Description	No.	Description
1	Parameter Measurement Menu Softkeys	11	HORIZONTAL Control Area
2	LCD	12	Measurement Setting and Quick Print Keys
3	Multifunction Knob	13	VERTICAL Control Area
4	Clear	14	TRIGGER Control Area
5	Waveform Auto Display	15	Power Key
6	Navigation Knob	16	USB HOST Interface
7	Run/Stop Control Key	17	Function Setting Menu Softkeys
8	Single Trigger Control Key	18	Analog Channel Input Terminal
9	Waveform Record and Playback Control Keys	19	EXT TRIG Input Terminal
10	Function Keys	20	Probe Compensation Signal Output Terminal and Ground Terminal

Rear Panel Overview

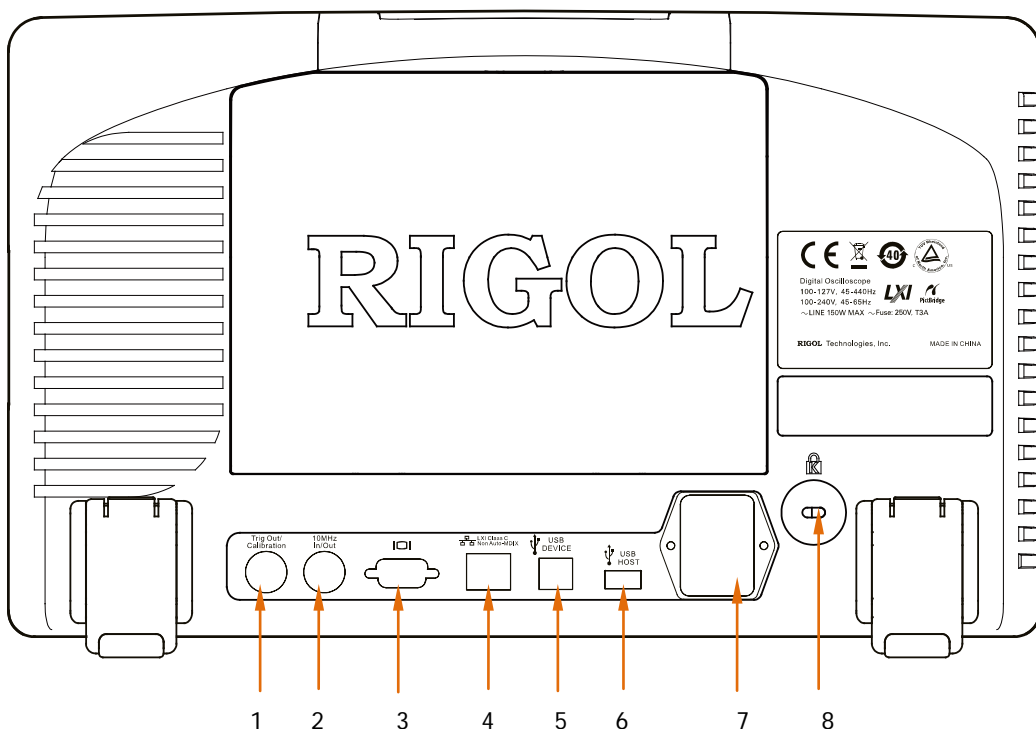

Figure 1-12 Rear Panel Overview

1. Trig Out/Calibration

This connector can output various signals (press **UTIL** → **AuxOutput** to select the desired output type):

- 1) **TrigOut:** after this type is selected, the oscilloscope output a signal that can reflect the current capture rate of the oscilloscope at each trigger.
- 2) **Fast:** after this type is selected, the oscilloscope can output a fast edge signal which can be used in the self-calibration of the oscilloscope.
- 3) **GND:** after this type is selected, the oscilloscope can output a ground level.
- 4) **PassFail:** after this type is selected, the oscilloscope will output a pulse signal when failed waveforms are detected. Connect this signal to other control systems to conveniently view the test results.

2. Reference Clock

Provide more precise sample clock signal for the oscilloscope and it can also

synchronize two or more oscilloscope clocks.

3. Video Output

Through this interface, the oscilloscope can be connected to external monitors such as projector to get clearer waveform display. Note that at this point, the display of the oscilloscope is still valid.

4. LAN

Through this interface, the oscilloscope can be connected to the network for remote control. As the oscilloscope conforms to the LXI-C instrument standard, a test system can be built quickly.

5. USB DEVICE

Through this interface, the oscilloscope can be connected to PictBridge printer to print waveform data or be connected to PC to control the oscilloscope through PC software.

6. USB HOST

Through this interface, the oscilloscope can be connected to normal printer to print waveform data or be connected to a USB storage device to perform external storage and recall. GPIB interface communication can be realized by using the USB-GPIB interface converter (optional) provided by **RIGOL**. There is also a USB HOST interface on the front panel of the oscilloscope.

7. AC Power Socket and Power Switch

When using the AC power supply, please insert the power cord plug into the socket vertically and use the power switch to power the oscilloscope on or off.

8. Lock Hole

Use the security lock (please buy it yourself) to lock the oscilloscope to a fixed location via this lock hole.

Front Panel Function Overview

VERTICAL

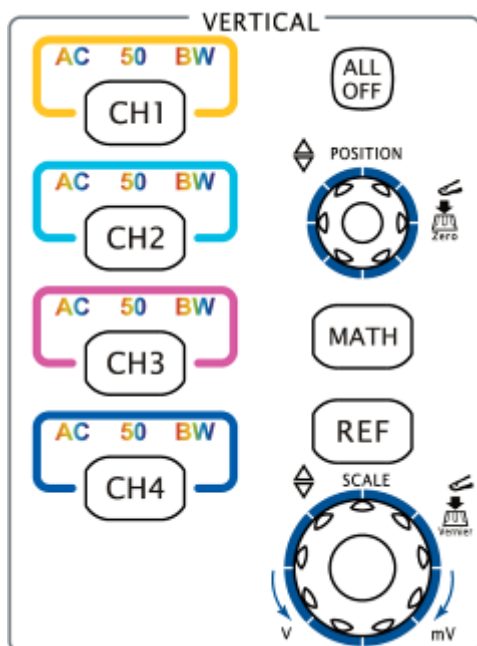

CH1, **CH2**, **CH3**, **CH4**: analog input channels. The four channels are marked by different colors which are also used to mark both the waveforms on the screen and the channel input connectors. Press any key to turn on the corresponding channel and channel menu; press again to turn off the channel.

AC: illuminated when the channel coupling mode is set to AC.

50: illuminated when the channel input impedance is 50 Ω .

BW: illuminated when the bandwidth limit is turned on.

ALL OFF: press this key to turn off all the channels that have been turned on.

MATH: press this key to turn on the math operation and decoding function menus under which to perform add, subtract, multiply, divide, FFT, logic and advanced operations as well as parallel decoding, RS232 decoding, SPI decoding, I2C decoding, CAN decoding and FlexRay decoding.

REF: press this key to turn on the reference waveform function to compare the waveform actually tested with the reference waveform to decide circuit failures.

VERTICAL  **POSITION**: modify the vertical position of the current channel waveform. Turn clockwise to increase the position and turn counterclockwise to decrease the position. During the modification, the waveform would move up and down and the vertical position message (e.g. **POS: -136.0mV**) at the lower-left

corner of the screen would change accordingly. Pressing down this knob can quickly reset the vertical position to zero.

VERTICAL  SCALE: modify the vertical scale of the current channel. Turn clockwise to decrease the scale and turn counterclockwise to increase the scale. During the modification, the display amplitude of the waveform would enlarge or reduce (the actual amplitude remains unchanged) and the vertical scale information

(e.g. ) at the lower side of the screen would change accordingly.

Pressing down this knob can quickly switch the vertical scale adjustment mode between "Coarse" and "Fine".

HORIZONTAL

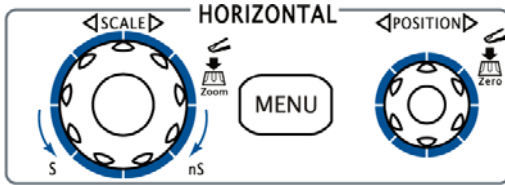

MENU: press this key to turn on the horizontal control menu. Through this menu, you can turn on or off the delayed sweep function, switch between different time base modes, switch between "Coarse" and "Fine" adjustment modes of the scale as well as modify the horizontal reference setting.

HORIZONTAL  SCALE: modify the horizontal time base. Turn clockwise to reduce the time base and turn counterclockwise to increase the time base. During the modification, waveforms of all the channels will be displayed in horizontally expanded or compressed mode and the time base message (e.g. **H 500.0us**) at the upper side of the screen would change accordingly. Pressing down this knob can quickly turn on or off the delayed sweep function.

HORIZONTAL  POSITION: modify the horizontal position. The trigger point moves left and right relative to the center of the screen when you turn the knob. During the modification, waveforms of all the channels would move right and left and the horizontal position message (e.g. **D 780.000000ns**) at the upper-right corner of the screen would change accordingly. Pressing down this knob can quickly reset the horizontal position or the delayed sweep position to zero.

TRIGGER



MODE: press this key to switch the trigger mode to **Auto**, **Normal** or **Single** and the corresponding state backlight of the current trigger mode would be illuminated.

TRIGGER LEVEL: modify the trigger level. Turn clockwise to increase the level and turn counterclockwise to reduce the level. During the modification, the trigger level line moves up and down and the value in the trigger

level message box (e.g. ) at the lower-left corner of the screen changes accordingly. Press down the knob to quickly reset the trigger level to zero point.

MENU: press this key to turn on the trigger operation menu. This oscilloscope provides various trigger types.

FORCE: in **Normal** and **Single** trigger modes, press this key to generate a trigger signal forcefully.

50%: press this key to set the trigger level to the vertical midpoint of the trigger signal amplitude.

Run/Stop



Press this key to set the state of the oscilloscope to "Run" or "Stop".

In "Run" state, the key is illuminated in yellow.

In "Stop" state, the key is illuminated in red.

Single



Press this key to set the trigger mode to "Single". In single trigger mode, the oscilloscope generates a trigger when the trigger conditions are met and then stops. When the oscilloscope is waiting for a trigger, this key is illuminated in orange.

Auto



Press this key to turn on the waveform auto setting function. The oscilloscope will automatically adjust the vertical scale, horizontal time base and trigger mode according to the input signal to realize optimum waveform display; besides, the oscilloscope provides the quick parameter measurement function (please refer to "**Quick Measurement after Auto**").

Note: The auto setting requires that the frequency of the sine waveform should be no lower than 20 Hz. If the parameter exceeds the limit, the waveform auto setting function might be invalid.

Multifunction Knob



Adjust waveform brightness:

In non-menu-operation mode (the menu is hidden), turn this knob to adjust the brightness of waveform display. The adjustable range of the brightness is from 0% to 100%. Turn clockwise to increase the brightness and counterclockwise to reduce. Press down this knob to reset the brightness to 50%.

You can also press **DISP** → **WaveIntensity** and use the knob to adjust the waveform brightness.

Multifunction Knob (the backlight goes on during operation):

In menu operation, for menu that includes multiple parameter items, press the corresponding menu softkey and turn the knob to select the specified parameter item (sometimes you need to press down the knob to select the parameter item). It can also be used to modify parameters and input filename.

Navigation Knob

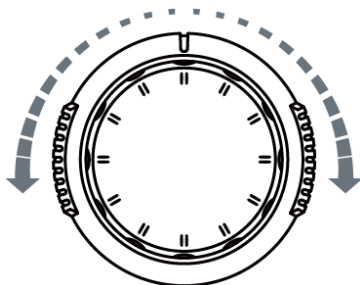

This knob provides quick Adjust/Locate function for numerical parameters with relatively large settable range. Turn clockwise (counter-clockwise) to increase (reduce) the value. The inner knob is used for fine adjustment and the outer knob for coarse adjustment. The change rate of the value depends on the rotation amplitude of the outer knob.

For example, this knob can be used to quickly locate the waveform frame to be played back (**CurFrame** menu) in the waveform playback. Similar parameters include trigger holdoff, pulse width setting, slope time and etc.

Function Keys

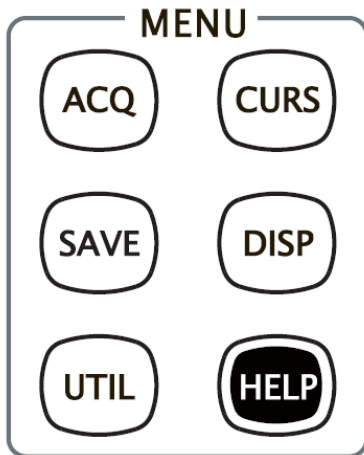

ACQ: press this key to enter sample setting menu to set the acquisition mode, the sampling mode, the memory depth and the anti-aliasing function of the oscilloscope.

CURS: press this key to enter cursor measurement menu. The oscilloscope provides three cursor modes: manual, track and auto.

SAVE: press this key to enter the file store and recall interface. The file types include traces, waveforms, setups, picture and CSV. The oscilloscope supports internal and external storages as well as disk management.

DISP: press this key to enter the display setting menu. Through this menu, you can set the display type, persistence time and wave intensity of the waveform as well as the grid type, grid brightness and menu display time of the screen.

UTIL: press this key to enter the system function setting menu. Through this menu, you can set the system-related functions or parameters, such as I/O setting, sound and language. The oscilloscope also supports some advanced functions such as pass/fail test, waveform record and print setting.

HELP: press this key to turn on the help interface. For detailed information, please refer to the introduction in "**Built-in Help System**".

Record



Play/Pause: in stop or pause state, press this key to play back the waveform and press again to pause the play. The backlight is illuminated in yellow.



Stop: press this key to stop the waveform in record or playback mode. The backlight is illuminated in orange.



Record: press this key to start recording the waveform. The backlight is illuminated in red.

MEAS



Press this key to enter the measurement menu which supports measurement parameter setting, all measure, statistic analysis and counter. Press **MENU** at the left of the screen to quickly turn on the selecting menu of the 29 measurement parameters and easily realize "one-key" measurement of the common parameters.

Clear



Press this key to clear all the waveforms on the screen. If the oscilloscope is in "Run" state, new waveforms will still be displayed.

Print



Press this key to execute the print function or save the content displayed on the screen in a USB storage device. If the oscilloscope is currently connected to a printer (PictBridge or normal printer) and the printer is in idle state, pressing this key will execute the print function. If no printer but a USB storage device is currently connected, pressing this key will save the content displayed on the screen to the USB storage device in the specified format (press **SAVE** → **Storage** to select "**Picture**"; then, press **Pic Type** to select "bmp", "png", "jpeg" or "tiff" and the default is "png"). When printer and USB storage device are connected at the same time, the printer enjoys higher priority.

User Interface

DS6000 oscilloscope provides 10.1 inch, WVGA (800*480) 160,000 color TFT LCD. What is worth mentioning is that the 14-grid ultra-wide screen makes you view "longer" waveform.

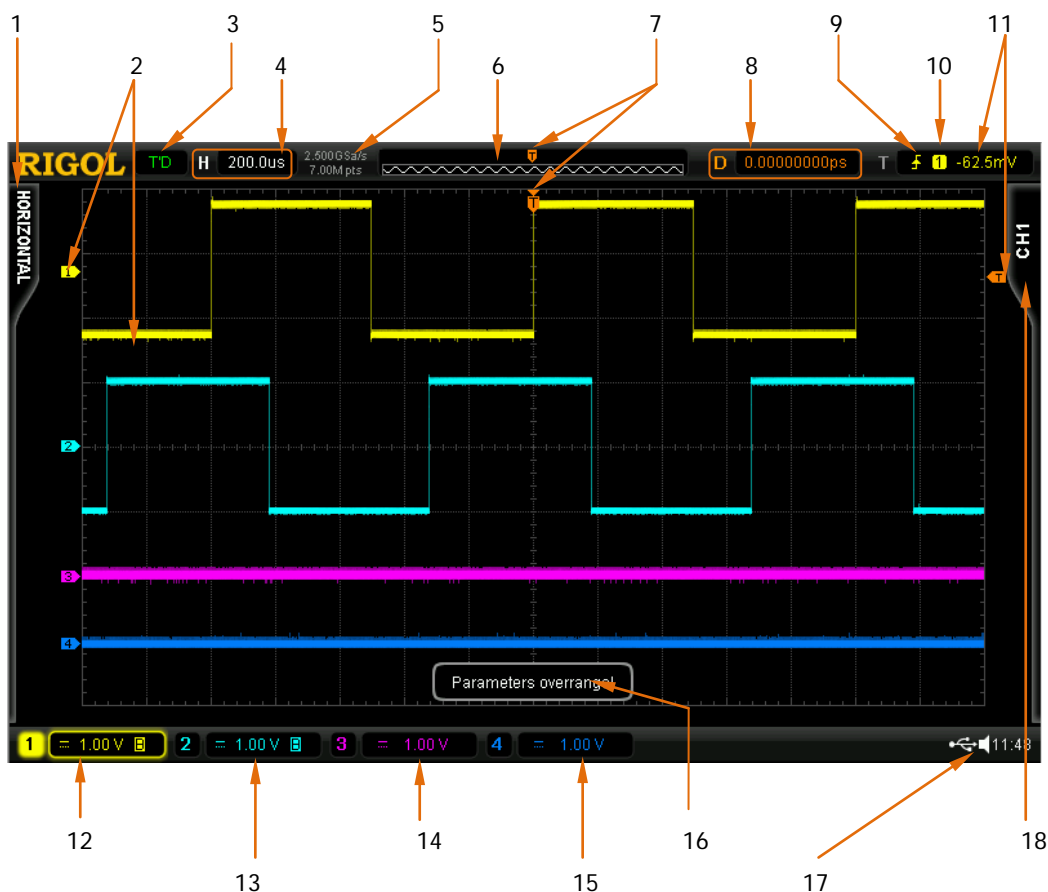



Figure 1-13 User Interface



1. Auto Measurement Items

Provide 16 horizontal (HORIZONTAL) and 13 vertical (VERTICAL) measurement parameters. Press **MENU** at the left of the screen continuously to switch among the horizontal measurement items and vertical measurement items or fold the measurement menu. When the measurement menu is unfolded, pressing the measurement menu softkey can turn on the auto measurement function of the

corresponding parameter.

Note: When the measurement menu is unfolded, the following symbols might appear in the grid at the lower-left corner of the screen.

 Denote that the current menu includes multiple pages. You can press menu page down  key at the left of the screen to turn on the next page of the menu.

 Denote that the current menu includes multiple pages. You can press menu page up  key at the left of the screen to turn on the previous page of the menu.

2. Channel Label/Waveform

Different channels are marked by different colors and the color of the waveform complies with the color of the channel label.

3. Running Status

Available states include RUN, STOP, T'D (triggered), WAIT and AUTO.

4. Horizontal Time Base

- Represent the time per grid on the horizontal axis on the screen.
- Use **HORIZONTAL**  **SCALE** to modify this parameter. The range available is from 500 ps to 1.000 ks.

5. Sample Rate/Memory Depth

- Display the current sample rate and memory depth of the oscilloscope.
- Use **HORIZONTAL**  **SCALE** to indirectly modify the sample rate and/or memory depth.

6. Waveform Memory

Provide the schematic diagram of the memory position of the waveform currently on the screen.

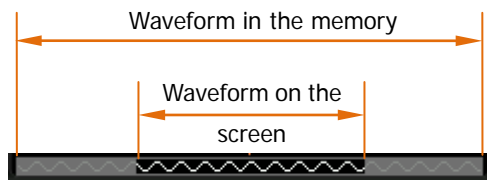

7. Trigger Position

Display the trigger positions of the waveform in the waveform memory and on the screen.

8. Horizontal Position

Use **HORIZONTAL**  **POSITION** to modify this parameter. Press down the knob to automatically set the parameter to zero.

9. Trigger Type

Display the currently selected trigger type and trigger condition setting. Different labels are displayed when different trigger types are selected. For example,  represents triggering on the rising edge in "Edge" trigger.



10. Trigger Source

Display the trigger source currently selected (CH1-CH4, EXT, EXT/5 or AC Line). Different labels are displayed when different trigger sources are selected and the color of the trigger parameters (include the "**Trigger Type**", "**Trigger Source**" and "**Trigger Level**") corresponds to the trigger source currently selected.

For example,  denotes that CH1 is selected as the trigger source.





11. Trigger Level

- When the trigger source is CH1 to CH4, the trigger level value is displayed and the trigger level icon () is displayed at the right of the screen.





Note: In slope trigger, there are two trigger levels; the difference between the two trigger levels is displayed at the upper-right corner of the screen and two trigger level labels ( and ) are displayed at the right side of the screen at the same time. For the detailed information, please refer to the introduction in "**Vertical Window**" on page 5-13.

- When the trigger source is EXT or EXT/5, the trigger level value is displayed and no trigger level icon is displayed.
- When the trigger source is AC line, there is no trigger level.
- When using **TRIGGER**  **LEVEL** to modify the trigger level, the trigger level value will change with the up and down of the trigger level icon.





12. CH1 Label

- Display the on/off status of CH1. When it is turned on, the channel label is highlighted.
- Display the vertical scale of CH1 (namely the voltage value per grid of the CH1 waveform in the vertical direction). You can use **VERTICAL**  **SCALE** to modify this parameter.
- Different labels may be displayed according to the current channel setting. For example,  is displayed when the "Channel Coupling" is AC;  is displayed when the "Bandwidth Limit" is enabled;  is displayed when the "Input Impedance" is 50 Ω.

13. CH2 Label

- Display the on/off status of CH2. When it is turned on, the channel label is highlighted.
- Display the vertical scale of CH2 (namely the voltage value per grid of the CH2 waveform in the vertical direction). You can use **VERTICAL**  **SCALE** to modify this parameter.
- Different labels may be displayed according to the current channel setting. For example,  is displayed when the "Channel Coupling" is AC;  is displayed when the "Bandwidth Limit" is enabled;  is displayed when the "Input Impedance" is 50 Ω.



14. CH3 Label

- Display the on/off status of CH3. When it is turned on, the channel label is highlighted.
- Display the vertical scale of CH3 (namely the voltage value per grid of the CH3 waveform in the vertical direction). You can use **VERTICAL**  **SCALE** to modify this parameter.
- Different labels may be displayed according to the current channel setting. For example,  is displayed when the "Channel Coupling" is AC;  is displayed when the "Bandwidth Limit" is enabled;  is displayed when the "Input Impedance" is 50 Ω.

15. CH4 Label

- Display the on/off status of CH4. When it is turned on, the channel label is highlighted.
- Display the vertical scale of CH4 (namely the voltage value per grid of the

CH4 waveform in the vertical direction). You can use **VERTICAL**  **SCALE** to modify this parameter.





- Different labels may be displayed according to the current channel setting. For example,  is displayed when the "Channel Coupling" is AC;  is displayed when the "Bandwidth Limit" is enabled;  is displayed when the "Input Impedance" is 50 Ω.

16. Message Box

Display prompt messages.

17. Notification Area



Display the system time, sound icon, battery icon, USB storage device icon and printer icon.

- System Time: displayed in "hh:mm (hour:minute)" format. When printing or storing the waveform, the output file will contain this time message. Press **UTIL** → **System** → **System Time** → **System Time** to set through the following format:
yyyy-mm-dd hh-mm-ss (year-month-date hour-minute-second)
- Sound Icon: when sound is turned on, this area displays . Press **UTIL** → **Sound** to turn the sound on or off.
- Battery Icon: when the battery is used for power supply, this area displays .
- USB storage device: when the oscilloscope detects a USB storage device, this area displays .
- Normal Printer Icon: when the oscilloscope is correctly connected to a normal printer, this area displays .
- PictBridge Printer Icon: when the oscilloscope is correctly connected to a PictBridge printer, this area displays .

18. Operation MENU

Press any softkey to activate the corresponding menu. The following symbols might be displayed in the menu:



Denote that  on the front panel can be used to select parameter items. The backlight of  turns on when parameter selection is valid.



Denote that ↩ can be used to modify parameter values. The backlight of ↩ turns on when parameter input is valid.



Denote that you can use the navigation knob to quickly adjust/locate parameters.



Denote that ↵ can be used to select the specified parameter item and then press ↵ to select the parameter.



Denote that the current menu has several options.



Denote that the current menu has a lower level menu.



Press this key to return to the previous menu.

Note: The following direction keys might appear in the grid at the lower-left corner of the menu bar:



Denote that you can turn on the next page of the menu.



Denote that you can turn back the previous page of the menu.

Security Lock

If needed, you can use the security lock (please buy it yourself) to lock the oscilloscope to a fixed location. The method is as follows, align the lock with the lock hole and plug it into the lock hole vertically, turn the key clockwise to lock the oscilloscope and then pull the key out.

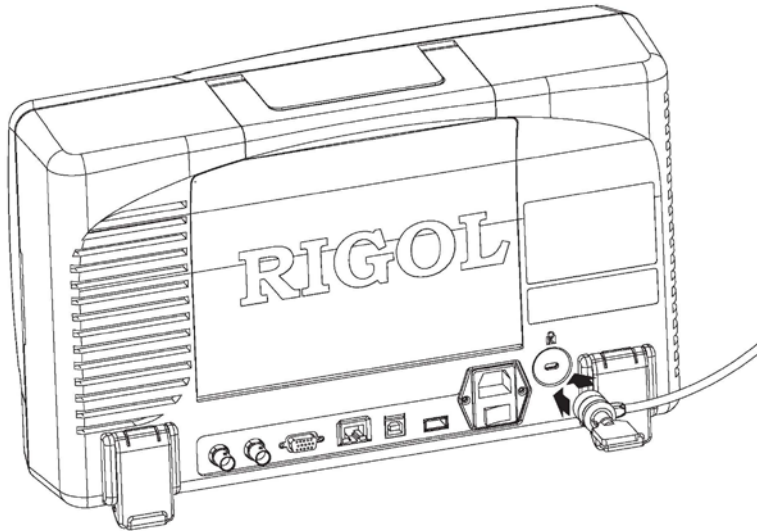

Figure 1-14 To Use the Security Lock

Note: Do not insert other articles into the security lock hole to avoid damaging the instrument.

Desk Mount Instrument Arm

Using an arm, the oscilloscope could be mounted on the workbench to save your operation space. The height and angle of the instrument could be adjusted freely to acquire supreme comfort and efficiency and to convenient your measurement and observation. If needed, please buy and install the corresponding option.



Figure 1-15 Working Sketch of the Instrument with the Desk Mount Instrument Arm

Built-in Help System

The help system of this oscilloscope provides instructions for all the function keys (include the menu keys) on the front panel. Press **HELP** to open the help interface and press again to close the interface. The help interface mainly consists of two parts. The left part is "Help Options". You can rotate the knob  to select "To Index" under "Button" or "To Button" under "Index", and then press it down to select the options. The right part is "Help Display Area".

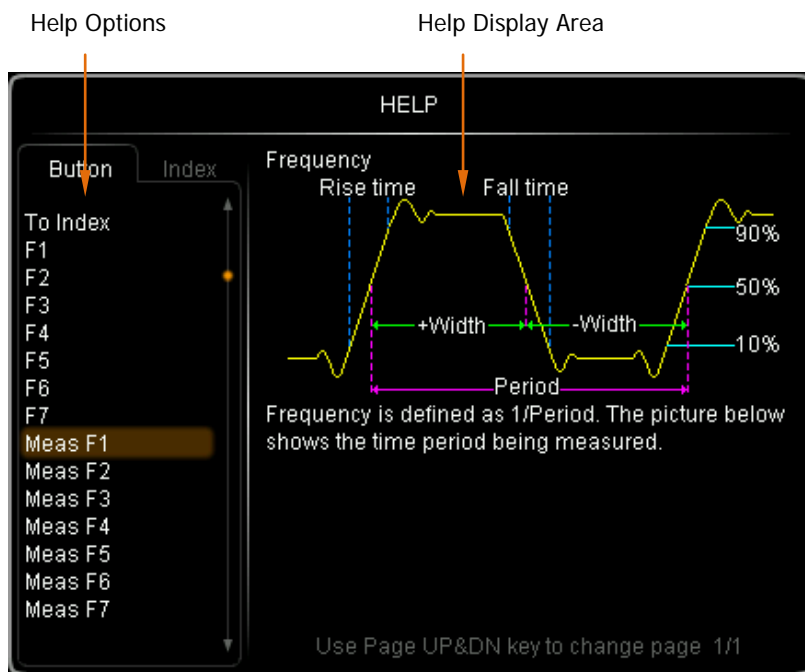









Figure 1-16 Help Information

Button:

The default mode. In this mode, you can directly press the keys or menu keys (except the power key , the multifunction knob  and menu page up/down key ) on the front panel or rotate the multifunction knob  to select the desired key and press the knob to get the corresponding help information of that key in the "Help Display Area". Besides, you can rotate the navigation knob  to quickly select "WaveFunder" and acquire the help information of the navigation knob. You can use  to select "To Index" and then press the knob to switch to **Index** mode.

Index:

In this mode, use  to select the item that needs to get help (for example, "Band

Width") and the item selected is displayed with brown shading. Press the knob to get the corresponding help information in the "Help Display Area". You can use  to select "To Button" and then press the knob to switch to **Button** mode.

2 To Set the Vertical System

The contents of this chapter:

- To Enable the Channel
- Channel Coupling
- Bandwidth Limit
- Probe
- Input Impedance
- Waveform Invert
- Vertical Scale
- Vertical Position
- Vertical Expansion
- Amplitude Unit
- Channel Label
- Delay Calibration

To Enable the Channel

DS6000 provides four analog input channels (CH1-CH4) and each channel can be controlled independently.

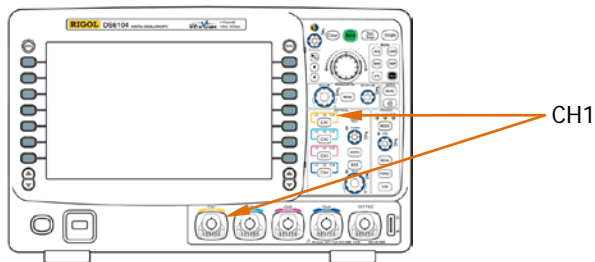

Connect a signal to the channel connector of any channel (for example, CH1) and then press **CH1** in the vertical control area (VERTICAL) on the front panel to enable CH1. At this point:

Panel:

The backlight of this key turns on. If the corresponding function in this menu has been turned on, the characters "AC", "50" or "BW" might also be illuminated. Note: The on/off state of the key light of "AC", "50" or "BW" is not limited by the on/off state of the channel.



Screen:

The channel setting menu is displayed at the right side of the screen and the channel label at the bottom of the screen (as shown in the figure below) is highlighted. The information displayed in the channel label is related to the current channel setting.



After the channel is turned on, modify the parameters such as the vertical scale, the horizontal time base and the trigger mode according to the input signal to make the waveform display easy to observe and measure.

Channel Coupling

Set the coupling mode to filter out the signals that is not needed. For example, the signal under test is a square waveform with DC offset.

- When the coupling mode is "DC": the DC and AC components of the signal under test can both pass the channel.
- When the coupling mode is "AC": the DC components of the signal under test are blocked.
- When the coupling mode is "GND": the DC and AC components of the signal under test are both blocked.

Press **CH1** → **Coupling** and use  to select the desired coupling mode (the default is DC). The current coupling mode is displayed in the channel label at the bottom of the screen. When "AC" is selected, the character "AC" above the CH1 channel key on the front panel will be illuminated. You can also press **Coupling** continuously to switch the coupling mode.

Bandwidth Limit

Set the bandwidth to reduce the display noise. For example, the signal under test is a pulse signal with high frequency oscillation.

- When the bandwidth limit is turned off, the high frequency components of the signal under test can pass the channel.
- When the bandwidth limit is turned on and is set to 20 MHz or 250 MHz, the high frequency components that exceed 20 MHz or 250 MHz of the signal under test are attenuated.

Press **CH1** → **BW Limit** and use  to set the status of the bandwidth limit (by default, it is turned off). When the bandwidth limit (20 MHz or 250 MHz) is turned on, the character "B" will be displayed in the channel label at the bottom of the screen. You can also press **BW Limit** continuously to switch the status of the bandwidth limit.



Probe

This oscilloscope supports normal passive probe, active probe and Tek probe (with **RIGOL** T2R1000 active probe adaptor, option). The oscilloscope can automatically identify the probe type and the probe ratio of the probe currently connected. Press **CH1** → **Probe** to turn on the probe operation menu.

1. Probe Type

You can read the probe type of the probe currently connected as "Nor-Probe", "Active Probe" or "Tek Probe". Note that when using a 50 Ω "Active Probe", the "**Input Impedance**" of the channel is set to "50 Ω " automatically; when Tek probe is used, the oscilloscope will set the input impedance of the channel automatically according to the model of the probe actually connected.

- Normal Probe: such as RP5600A, RP3500A and RP6150A of **RIGOL**.
- Active Probe: such as RP7150 of **RIGOL**.
- Tek Probe: such as P6245 of Tek.

2. Ratio

The oscilloscope can identify the probe ratio automatically. If the oscilloscope cannot identify, press this softkey to select the corresponding probe ratio. The probe ratio can be the values listed in the table on the next page.

Table 2-1 Probe Attenuation Coefficient

Menu	Attenuation Coefficient (signal display amplitude : actual signal amplitude)
0.01X	0.01:1
0.02X	0.02:1
0.05X	0.05:1
0.1X	0.1:1
0.2X	0.2:1
0.5X	0.5:1
1X	1:1
2X	2:1
5X	5:1
10X	10:1
20 X	20:1
50 X	50:1
100 X	100:1
200 X	200:1
500 X	500:1
1000 X	1000:1

When an active probe is inserted, the following menus are added in addition to the **Probe Type** and **Ratio** menus.

1. Front-End

Press this softkey to select the probe front end that matches the probe actually connected. You can select single-end or differential.

2. Probe-Cal

The oscilloscope provides the calibration function for active probes. This function uses the fast edge signal output from the **[Trig Out/Calibration]** connector on the rear panel of the instrument as the probe calibration signal. Before performing probe calibration, press **UTIL** → **AuxOutput** and select "Fast".

The following part introduces how to calibrate the probe via the oscilloscope (take CH1 as an example) using PCK100 active differential probe calibration kit by taking RP7150 as an example. For the detailed calibration procedures, please refer to *RP7000 Series Active Probe User's Guide*.

- 1) Connect RP7150 to CH1 input terminal of the oscilloscope correctly.
- 2) Press **CH1** → **Probe** → **Probe-Cal** to open the probe calibration menu. At

this time, the probe calibration prompt message is displayed.

- 3) Connect the calibration board to CH2 input terminal of the oscilloscope and the **[Trig Out/Calibration]** connector on the rear panel respectively using connectors according to the probe calibration prompt message.
- 4) Adjust the distance between the RP7150 probe tips. Connect the positive probe tip to the signal at the middle of the calibration board and connect the negative probe tip to both sides of the signal line.
- 5) Press **OK** and the oscilloscope starts to calibrate the probe.

Note: Please connect the probe calibration signal to the specified channel according to the probe calibration prompt message. If the active probe is connected to CH1, CH3 or CH4, the probe calibration signal should be connected to CH2 via the calibration board. If the active probe is connected to CH2, the probe calibration signal should be connected to CH1 via the calibration board.

3. Probe Info

Press this softkey to view information about the probe, such as the manufacturer, model, serial number and the date of last calibration.

4. Bias Voltage

The oscilloscope provides bias voltage for active probes. This bias voltage is used to adjust the signal under test that exceeds the input dynamic range of the probe amplifier to an appropriate range to ensure the completeness of the signal under test. Press this softkey and use  to adjust the bias voltage. The range is from -12 V to +12 V.

When a Tek probe is inserted, the following menus are added in addition to the **Probe Type** and **Ratio** menus.

1. **Model**

Press **Model** and use  to select the probe model corresponding to the probe currently connected. The probe models available include P6205, P6241, P6243, P6245, P6246, P6247, P6248, P6249, P6250, P6251, P5205, P5210, P670X, P671X and TCP202.

2. **Front-End**

Front-End displays the current probe front end.

Note: When the probe currently connected is P670X, P671X or TCP202, this menu is not available.

In addition, the oscilloscope supports the probe calibration and bias voltage adjustment of some Tek probes, including P6241, P6245, P6246, P6247, P6248, P6249, P6250 and P6251. For these probes, **Probe-Cal** and **Bias Voltage** are provided in the probe operation menu.

3. **Probe-Cal**

Press **Probe-Cal** and ground the probe input terminal according to the probe calibration prompt message. Press **OK** and the oscilloscope starts calibrating the probe.

4. **Bias Voltage**

Press **Bias Voltage** and use  to adjust the bias voltage. The adjustable range is related to the probe model and probe ratio (only for models that support multiple probe ratios). For the details, please refer to the technical specifications of the corresponding probe.

Input Impedance

To reduce the circuit load caused by the interaction of the oscilloscope and the circuit under test, this oscilloscope provides two input impedance modes: 1 M Ω (default) and 50 Ω .

- 1 M Ω : at this point, the input impedance of the oscilloscope is very high and the current flows into the oscilloscope from the circuit under test can be ignored.
- 50 Ω : match the oscilloscope with devices whose output impedance is 50 Ω .

Press **CH1** \rightarrow **Input** to set the input impedance of the oscilloscope. When "50 Ω " is selected, the character " Ω " is displayed in the channel label at the bottom of the screen.



Note: After the probe is automatically identified, the input impedance will be automatically identified and you do not need to set it manually.

Waveform Invert

When waveform invert is turned off, the waveform display is normal; when waveform invert is turned on, the waveform voltage values are inverted (as shown in the figures below). Press **CH1** \rightarrow **Invert** to turn waveform invert on or off.



(a) "Invert" is Off

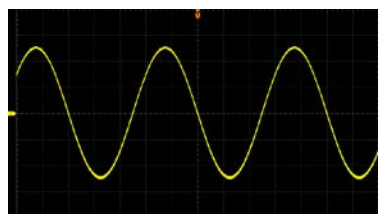



(b) "Invert" is On

Figure 2-1 Waveform Invert

Vertical Scale

The vertical scale adjustment has two modes: "Coarse" and "Fine".

Press **CH1** → **Volts/Div** to select the desired mode. Turn the **VERTICAL**  **SCALE** to adjust the vertical scale. Turn clockwise to reduce the scale and turn counterclockwise to increase the scale.

The scale information (e.g. ) in the channel label at the bottom of the screen will change accordingly during the adjustment. The adjustable range of the vertical scale is related to the current probe ratio and input impedance. By default, the probe attenuation ratio is 1X and the input impedance is 1 M Ω ; at this point, the adjustable range of the vertical scale is from 2 mV/div to 5 V/div.

- Coarse adjustment (take counterclockwise as an example): set the vertical scale in 1-2-5 step namely 2 mV/div, 5 mV/div, 10 mV/div...5 V/div.
- Fine adjustment: further adjust the vertical scale at a relatively smaller step to improve the vertical resolution. If the amplitude of the input waveform is a little bit greater than the full scale at the current scale and the amplitude would be a little bit lower if the next scale is used, fine adjustment can be used to improve the waveform display amplitude to view the details of the signal.

Note: You can also press **VERTICAL**  **SCALE** to quickly switch between coarse and fine adjustments.

Vertical Position

The unit of the vertical position is the same with the amplitude unit currently selected (refer to "**Amplitude Unit**").

Press **CH1** and rotate **VERTICAL**  **POSITION** to adjust the vertical position. Turning the knob clockwise will increase the position and turning the knob counterclockwise will reduce the position. Pressing down the knob will restore the vertical position to 0.

The adjustable range of the vertical position is related to the probe ratio, input impedance and vertical scale currently set. By default (the probe ratio is 1X and the input impedance is 1 M Ω), the adjustable range of the vertical position is from -2 V to 2 V when the vertical scale is from 2 mV/div to 225 mV/div; the adjustable range of the vertical position is from -40 V to 40 V when the vertical scale is from 230 mV/div to 5 V/div. The step of the vertical position is related to the current vertical scale.

When adjusting the vertical position, the waveform will move up and down and the vertical position information (for example, ) displayed at the lower-left corner of the screen will change accordingly.

Vertical Expansion

When using **VERTICAL**  **SCALE** to change the vertical scale of the analog channel, you can choose to expand or compress the vertical signal around the center of the screen or around the ground point of the signal.

Press **UTIL** → **System** → **VerticalExp** to select "Center" or "Ground" and the default is "Ground".

- Center: when the vertical scale is changed, the waveform will be expanded or compressed around the center of the screen.
- Ground: when the vertical scale is changed, the waveform ground level will remain at the same point on the screen and the waveform will be expanded or compressed around this point.

Amplitude Unit

Select the amplitude display unit for the current channel. The available units are W, A, V and U. When the unit is changed, the unit in the channel label will change accordingly.

Press **CH1** → **Unit** to select the desired unit and the default is V.

Channel Label

You can modify the labels used to mark the waveforms of the analog channels (CH1 to CH4) at the left side of the screen. The label is the number of the channel (e.g. **1**) by default. The new label can include uppercase English letters (A to Z), lowercase English letters (a to z), numbers (0 to 9), underlines and spaces and the length cannot exceed 4 characters.

Press **CH1** → **Label** to enter the label modification interface. As shown in the figure below:

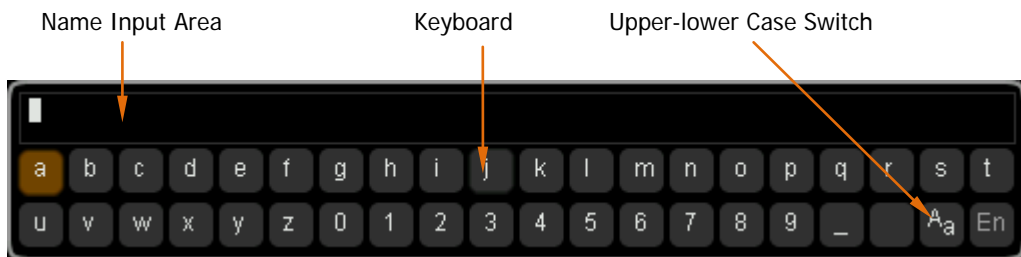

For example, change "**1**" to "**Chn1**".

Press **Keyboard** to select the "Keyboard" area. Select "**a**" using and press down to switch it to "**A**". Select "**C**" using and press down to input the character. Use the same method to input "hn1".

To modify or delete the inputted character, press **Name** to select the "Name Input Area" and use to select the character to be modified or deleted. Reenter the desired character or press **Delete** to delete the selected character.

After finishing the input, press **OK** and the channel label will change to "**Chn1**".

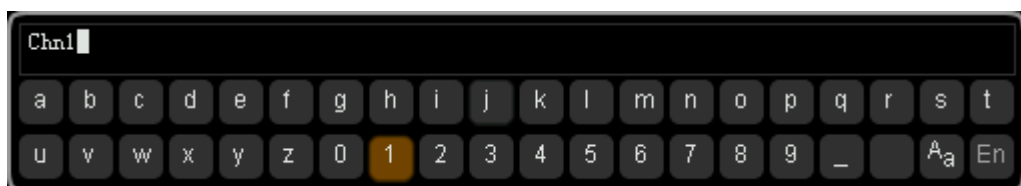

Delay Calibration

When using the oscilloscope for actual measurement, the transmission delay of the probe cable may bring relatively larger error (zero point offset). For DS6000, users can set a delay time to calibrate the zero point offset of the corresponding channel. Zero point offset is defined as the offset of the crossing of the waveform and trigger level line relative to the trigger position as shown in the figure below.

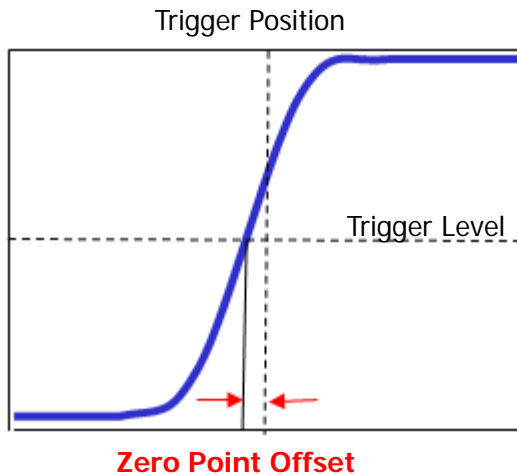

Press **CH1** → **Delay-Cal** and use the knob to set the desired delay time. The range is from -100 ns to 100 ns.

Note: This parameter is related to the horizontal time base currently set. For example, when the horizontal time base is 500 ns, the step of delay time setting is 10 ns; when the horizontal time base is 5 μ s, the step of delay time setting is 100 ns; when the horizontal time base is equal to or greater than 10 μ s, the delay calibration time cannot be adjusted.

3 To Set the Horizontal System

The contents of this chapter:

- Delayed Sweep
- Time Base Mode
- Horizontal Scale
- Horizontal Position
- Horizontal Reference

Delayed Sweep

Delayed sweep can be used to enlarge a length of waveform horizontally to view the details of the image.

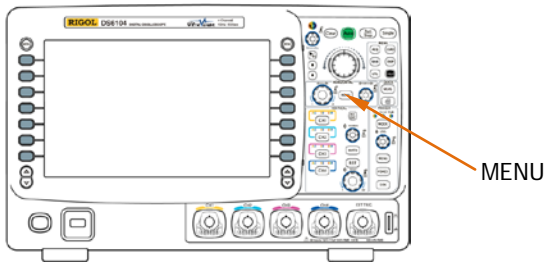

Press **MENU** in the horizontal control area (HORIZONTAL) and then press **Delayed** to turn the delayed sweep on or off. Note: To enable delayed sweep, the current time base mode must be "Y-T" and the "Pass/Fail test" must be disabled.

In delayed sweep mode, the screen is divided into two display areas as shown in the figure below.

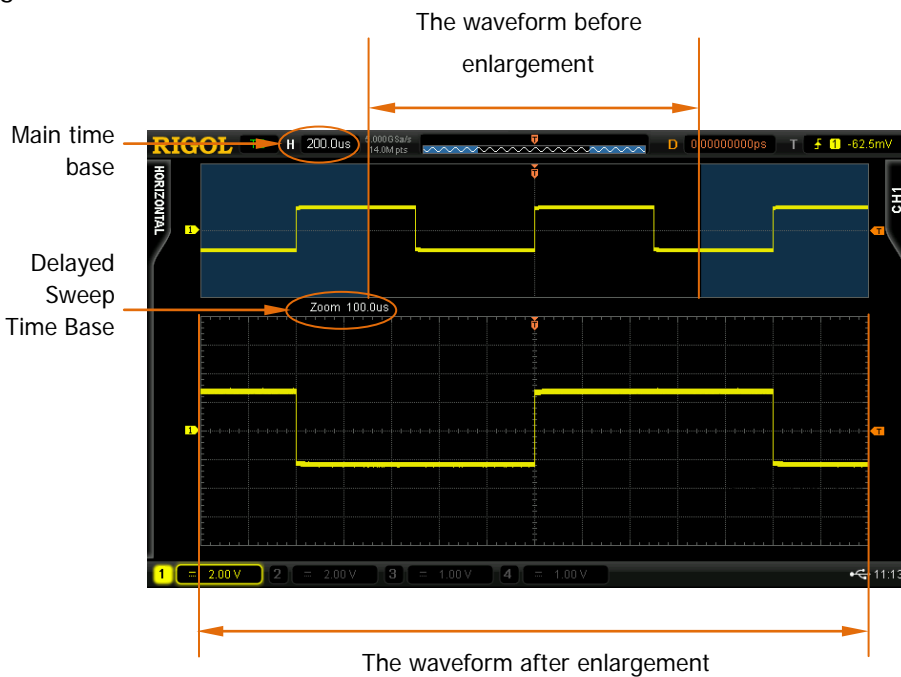

The waveform before enlargement:

The waveform in the area that has not been covered by the subtransparent blue in the upper part of the screen is the waveform before enlargement. You can turn

HORIZONTAL  **POSITION** to move the area left and right or turn

HORIZONTAL  **SCALE** to enlarge or reduce this area.

The waveform after enlargement:

The waveform in the lower part of the screen is the horizontally expanded waveform.

Note: The delayed sweep time base has increased its resolution relative to the main time base (as shown in the figure above). The delayed sweep time base should be lower than or equal to the main time base.

Tip

When the channel currently selected is CH1 to CH4, you can turn on or off the delayed sweep not only through **MENU** in the horizontal control area (HORIZONTAL) on the front panel but also by directly pressing **HORIZONTAL**  **SCALE** (the delayed sweep shortcut key) to switch the on/off status of the delayed sweep.

Time Base Mode

Press **MENU** in the horizontal control area on the front panel and then press **Time Base** to select the time base mode of the oscilloscope and the default is Y-T mode.

Y-T Mode

This mode is the main time base mode and is applicable to CH1-CH4 input channels. In this mode, the Y axis represents voltage and the X axis represents time.

Note: Only when this mode is enabled can "**Delayed Sweep**" be turned on.

X-Y Mode

In this mode, the oscilloscope automatically turns on all the four channels (CH1 to CH4) and the screen is divided into two coordinate areas (XY1 and XY2). In the XY1 area (at the left of the screen), the X axis and Y axis track the voltages of CH1 and CH2 respectively; in the XY2 area (at the right of the screen), the X axis and Y axis track the voltages of CH3 and CH4 respectively.

The phase deviation of two signals with the same frequency can be easily measured via Lissajous method. The figure below shows the measurement schematic diagram of the phase deviation.

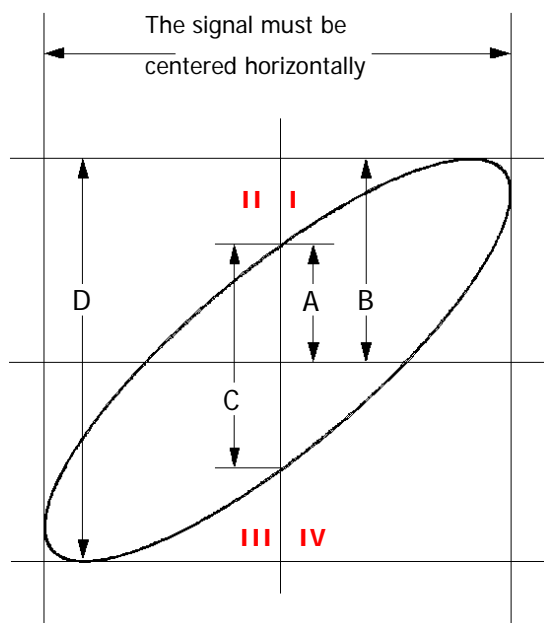

According to $\sin \theta = \frac{A}{B}$ or $\frac{C}{D}$ (θ is the phase deviation angle between the two channels and the definitions of A , B , C and D are as shown in the figure above), the phase deviation angle is obtained, that is:

$$\theta = \pm \arcsin \frac{A}{B} \text{ or } \pm \arcsin \frac{C}{D}$$

If the principal axis of the ellipse is within the quadrant I and quadrant III, the phase

deviation angle obtained should be within the quadrant I and quadrant IV (namely within $(0 \sim \pi/2)$ or $(3\pi/2 \sim 2\pi)$). If the principal axis of the ellipse is within the quadrant II and quadrant IV, the phase deviation angle obtained should be within the quadrant II and quadrant III (namely within $(\pi/2 \sim \pi)$ or $(\pi \sim 3\pi/2)$).

X-Y function can be used to measure the phase deviation occurred when the test signal passes through a circuit network. Connect the oscilloscope to the circuit to monitor the input and output signals of the circuit.

Application example:

Measure the phase deviation of the input signals of two channels.

Method 1: Use Lissajous method

1. Connect a sine signal to CH1 and then connect a sine signal with the same frequency and amplitude but a 90° phase deviation to CH2.
2. Press **Auto**, turn on the X-Y mode and rotate **HORIZONTAL**  **SCALE** to adjust the sample rate properly to get a better Lissajous figure for better observation and measurement.
3. Adjust the vertical positions of CH1 and CH2 respectively to display the signals at the center of the coordinate area and adjust the vertical scales of CH1 and CH2 respectively to make the signals easy to observe. At this point, the circle as shown in the figure below should be got.

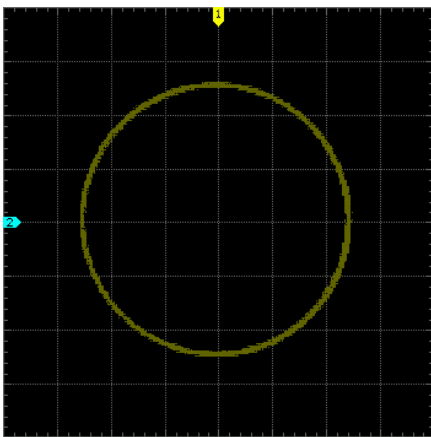

4. From the figure above, the distances from the points of intersection of the X/Y

axis and the circle to the origin of the coordinates are approximately equal. Thus, the phase deviation angle $\theta = \pm \arcsin 1 = \pm 90^\circ$.

Note:

- In Y-T mode, the oscilloscope could use arbitrary sample rate (within the guaranteed range) to capture waveform. The maximum sample rate of Y-T mode is 2.5 GSa/s. Generally, reducing the sample rate properly could get a Lissajous figure with relatively better display effect.
- When X-Y mode is turned on, "**Delayed Sweep**" will be turned off automatically.
- The following functions are not available in X-Y mode:
"**Horizontal Position**", "**Delayed Sweep**", "**Acquisition Mode**", "**To Trigger the Oscilloscope**", "**Math Operation**", "**One-key Measurement**", "**Measurement Range**", "**Protocol Decoding**", "**Reference Waveform**", "**Pass/Fail Test**", "**Waveform Recording**", "**Vectors Display**" and "**To Set the Persistence Time**".

Method 2: Use the shortcut measurement function

Please measure the phase deviation between the input waveforms of CH1 and CH2 by referring to the phase deviation measurement function in "Delay and Phase" on page 6-19.

Roll Mode

In this mode, the waveform scrolls from the right to the left to update the display and the waveform horizontal position and trigger control are not available. The range of horizontal scale adjustment is from 200.0 ms to 1.000 ks.

Note: When Roll mode is turned on, "**Horizontal Position**", "**Delayed Sweep**", "**To Trigger the Oscilloscope**", "**Measurement Range**", "**Protocol Decoding**", "**Pass/Fail Test**", "**Waveform Recording**" and "**To Set the Persistence Time**" are not available.

Slow Sweep

Another mode similar to the Roll mode. In Y-T time base mode, when the horizontal time base is set to 200 ms/div or slower, the instrument enters the "slow sweep" mode in which the instrument first acquires the data at the left of the trigger point and then waits for a trigger. After the trigger occurred, the instrument continues to finish the waveform at the right of the trigger point. When using the slow sweep mode to observe low frequency signal, it is recommended that the "**Channel Coupling**" is set to "DC".

Horizontal Scale

Being similar to "**Vertical Scale**", the horizontal scale adjustment has two modes: "Coarse" and "Fine".

Press **MENU** (in the horizontal control area (HORIZONTAL) on the front panel) → **ScaleAdjust** to select the desired mode. Turn **HORIZONTAL**  **SCALE** to adjust the horizontal scale. Turn clockwise to reduce the horizontal scale and turn counterclockwise to increase the scale.

The scale information (e.g. **H 500.0us**) at the upper-left corner of the screen will change accordingly during the adjustment. The adjustable range of horizontal scale is related to the model of the instrument.



DS610X: 500 ps/div to 1.000 ks/div

DS606X: 1 ns/div to 1.000 ks/div

- Coarse (take counterclockwise as an example): set the horizontal scale in 1-2-5 step namely 500 ps/div, 1 ns/div, 2 ns/div, 5 ns/div...1.000 ks/div.
- Fine: further adjust the horizontal scale at relatively smaller step.

Horizontal Position

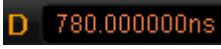

Turn **HORIZONTAL**  **POSITION** to adjust the horizontal position. Turning the knob clockwise to reduce the position and turning the knob counterclockwise to increase the position. Pressing down the knob can quickly reset the horizontal position or the delayed sweep position to 0.

In addition, to adjust the horizontal position with a small step value, you can perform the following operations: rotate the inner knob of the navigation knob ; or press **MENU** on the HORIZONTAL control area, and select **Offset**, then rotate the knob . To quickly adjust the horizontal position within a relatively larger range, you can rotate the outer knob of the navigation knob . (The greater the rotation amplitude of the outer knob, the faster the variations in the values.)

When adjusting the horizontal position, the waveform will move left and right and the horizontal position information (for example, ) displayed at the upper-right corner of the screen will change accordingly.

Horizontal Reference

Horizontal reference is the reference position according to which the screen waveform expands and compresses horizontally when adjusting **HORIZONTAL SCALE**. In Y-T mode, press **MENU** (in the horizontal control area (HORIZONTAL)) → **HorRef** to select the desired reference mode and the default is "Center".

- **Center:** when changing the horizontal time base, the waveform is expanded or compressed horizontally around the center of the screen.
- **Trig Pos:** when changing the horizontal time base, the waveform is expanded or compressed horizontally around the trigger point.
- **User:** when changing the horizontal time base, the waveform is expanded or compressed horizontally around the user-defined reference position. After selecting "User", press **RefPos** and use  to set the reference position; the range is from -350 (the rightmost of the screen) to 350 (the leftmost of the screen); the default is 0 (the center of the screen). Pressing  can quickly reset the user-defined reference position to 0.

4 To Set the Sample System

The contents of this chapter:

- Acquisition Mode
- Sample Mode
- Sample Rate
- Memory Depth
- Anti-aliasing

Acquisition Mode

The acquisition mode is used to control how to generate waveform points from the sample points.

Press **ACQ** → **Acquisition** and use  to select the desired acquisition mode (the default is normal), then press the knob to select this mode. You can press **Acquisition** continuously to switch the acquisition mode.

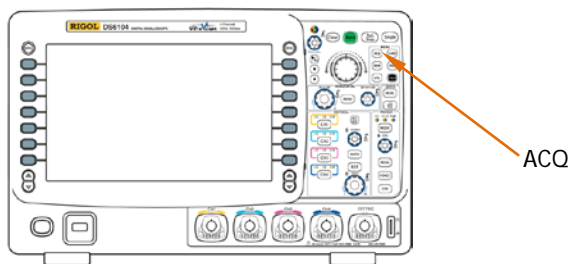

Normal

In this mode, the oscilloscope samples the signal at equal time interval to rebuild the waveform. For most of the waveforms, the best display effect is generated by using this mode.

Average

In this mode, the oscilloscope averages the waveforms from multiple samples to reduce the random noise of the input signal and improve the vertical resolution. The higher the number of averages is, the lower is the noise and the higher is the vertical resolution but the slower is the response of the displayed waveform to the waveform changes.

When "Average" mode is selected, press **Averages** and use  to set the desired

number of averages. The number of averages can be set to 2, 4, 8, 16, 32, 64, 128, 256, 512, 1024, 2048, 4096 or 8192 and the default is 2.

The Waveform before Average:

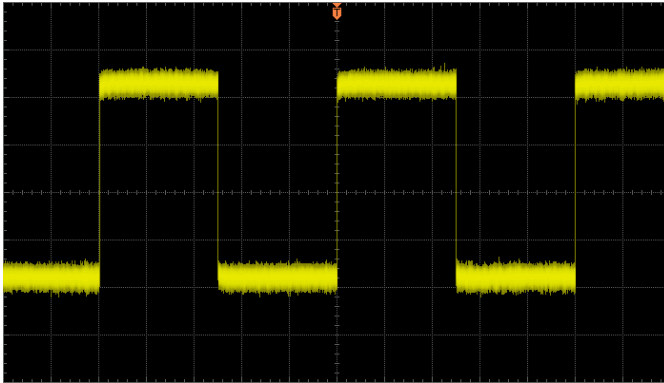

The Waveform after 256 Averages:

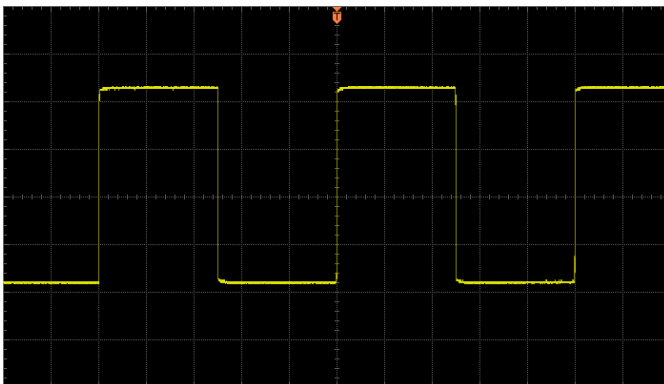

Peak Detect

In this mode, the oscilloscope acquires the maximum and minimum values of the sample interval signal to get the envelope or the narrow pulse of the signal that might be lost. Use this mode to avoid signal confusion at the expense of exaggerating the noise.

In this mode, the oscilloscope can display all the pulses whose pulse widths are at least as wide as the sample period.

High Resolution

This mode uses a kind of ultra-sample technique to average the neighboring points of the sample waveform to reduce the random noise on the input signal and generate much smoother waveforms on the screen. This is generally used when the sample rate of the digital converter is higher than the save rate of the acquisition memory.

Note: "Average" and "High Res" modes use different averaging methods. The former uses "Waveform Average" and the latter uses "Dot Average".

Sample Mode

Press **ACQ** → **Sampling** and press this softkey continuously to switch the sample mode (the default is real-time sample). Note: All the "**Acquisition Mode**" support real-time sample and equivalent sample.

Real-time Sample

In this mode, the oscilloscope samples and displays waveform within a trigger event. The maximum real-time sample rate of DS6000 is 5 GSa/s and the current sample rate is displayed under the **Sa Rate** menu.

Equivalent Sample

In this mode, the oscilloscope performs multiple trigger samples, samples at different positions of each trigger and uses the sample points from multiple triggers to rebuild the signal. The equivalent sample mode helps with detailed observation of the repeated periodic signals. The maximum equivalent sample rate of DS6000 is 100 GSa/s.

Tip

Press **Run/Stop** to stop the sample, the oscilloscope will hold the last display. At this point, you can still use the vertical control and horizontal control to pan and zoom the waveform.

Sample Rate

The sample rate of this oscilloscope is up to 5 GSa/s. Note: The sample rate is displayed in the status bar at the upper side of the screen and in the **Sa Rate** menu and can be changed by adjusting the horizontal time base (s/div) through **HORIZONTAL  SCALE** or modifying the "Memory Depth".

The influence on the waveform when the sample rate is too low:

1. **Waveform Distortion:** when the sample rate is too low, some waveform details are lost and the waveform displayed is rather different from the actual signal.

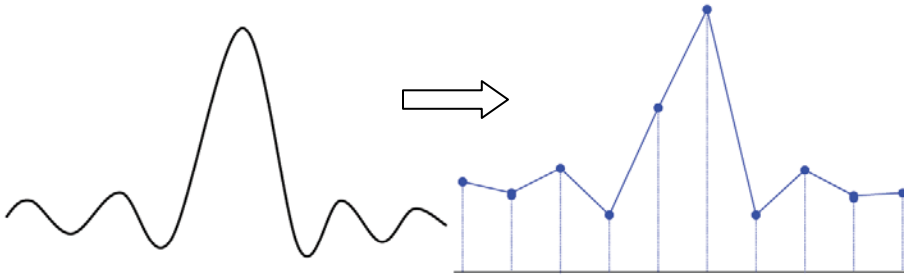

2. **Waveform Aliasing:** when the sample rate is lower than twice the actual signal frequency (Nyquist Frequency), the frequency of the waveform rebuilt by the sample data is lower than the actual signal frequency. The most common aliasing is the jitter on a fast edge.

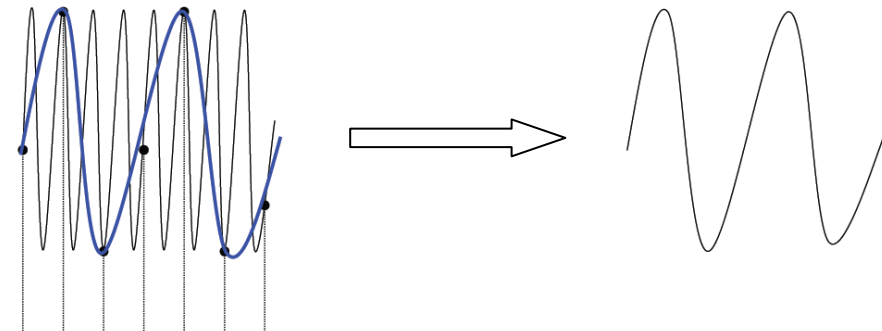

3. **Waveform Leakage:** when the sample rate is too low, the waveform rebuilt by the sample data does not reflect all the actual signal information.

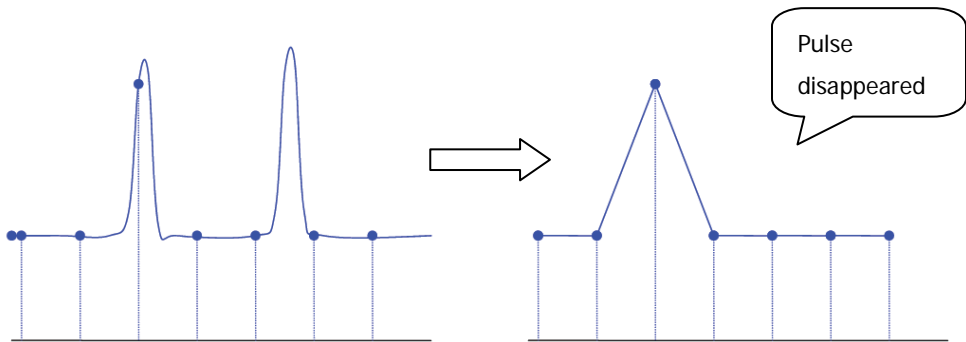

Memory Depth

Memory depth refers to the number of waveform points that the oscilloscope can store in a single trigger sample and it reflects the storage ability of the acquisition memory. DS6000 provides a memory depth up to 140 M points.

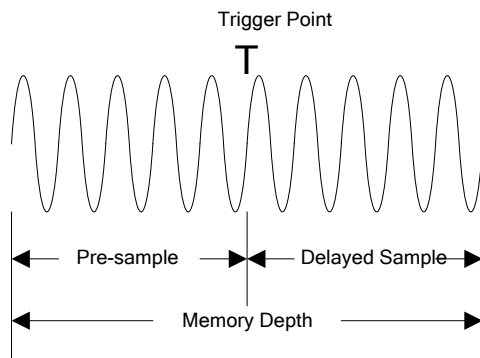

The relationship of memory depth, sample rate and waveform length fulfills the following equation:

$$\text{Memory Depth} = \text{Sample Rate (Sa/s)} \times \text{Waveform Length (s/div} \times \text{div)}$$

Press **ACQ** → **Mem Depth**, use  to select the desired memory depth (the default is auto) and then press the knob to select the option. You can also press **Mem Depth** continuously to switch the memory depth.

When a single channel (CH1 or CH2, CH3 or CH4) is turned on, the memory depth can be set to Auto, 14kPoints, 140kPoints, 1.4MPoints, 14MPoints or 140MPoints. In "Auto" mode, the oscilloscope selects the memory depth automatically according to the current sample rate.

When two channels are turned on (CH1 and CH2, CH3 and CH4), the memory depth can be set to Auto, 7kPoints, 70kPoints, 700kPoints, 7MPoints and 70MPoints. In "Auto" mode, the oscilloscope selects the memory depth automatically according to the current sample rate.

Anti-aliasing

At slower sweep speeds, the sample rate is reduced and a proprietary display algorithm is used to minimize the likelihood of aliasing.

Press **ACQ** → **Anti-Aliasing** to turn on or off the anti-aliasing function. By default, anti-aliasing is disabled. The displayed waveforms will be more susceptible to aliasing when this function is disabled.

5 To Trigger the Oscilloscope

For trigger, you set certain trigger condition according to the requirement and when a waveform in the waveform stream meets this condition, the oscilloscope captures this waveform as well as the neighbouring part and displays them on the screen. When the oscilloscope is working, it continuously acquires waveform data even if a valid trigger does not occur. However, only when valid triggers occur, can the display become stable. The trigger circuit guarantees that each sweep or sample starts when the input signal meets the user-defined trigger condition, namely each sweep and sample are synchronous and the waveforms acquired overlap to display stable waveform.

Trigger setting should be based on the features of the input signal, thus you need to have some knowledge of the signal under test to quickly capture the desired waveform. This oscilloscope provides abundant advanced trigger functions which help you to focus on the waveform details of interest.

The contents of this chapter:

- Trigger Source
- Trigger Mode
- Trigger Coupling
- Trigger Holdoff
- Trigger Type
- Trigger Output Connector

Trigger Source

Press **MENU** (in the trigger control area (TRIGGER) on the front panel) → **Source** to select the desired trigger source. Signals input from the analog channels CH1-CH4 and the **[EXT TRIG]** connector as well as the AC Line can all be used as the trigger source.

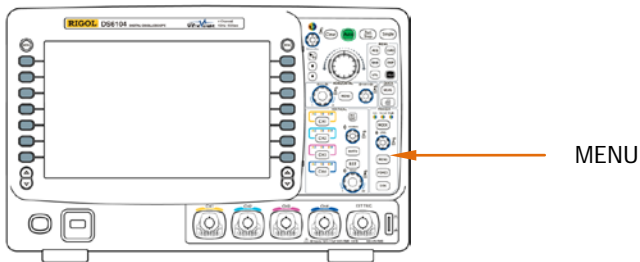

Analog channel input:

Signals input from analog channels CH1-CH4 can all be used as the trigger source. No matter whether the input from the channel selected is displayed, the channel can work normally.

External trigger input:

The external trigger source can be used to trigger on the fifth channel at the same time when all the four channels are acquiring data. The trigger signal (e.g. external clock, signal of the circuit to be tested) will be connected to **EXT** or **EXT/5** trigger source via the **[EXT TRIG]** connector. You can set the trigger conditions within the range of the trigger level from -0.8 V to +0.8 V.

AC Line:

The trigger signals are obtained from the AC power input of the oscilloscope. This kind of signals can be used to display the relationship between signal (such as illuminating device) and power (power supply device). For example, to stably trigger the waveform output from the transformer of a transformer substation; it is mainly used in related measurement of the power industry.

Trigger Mode

Trigger mode would influence the mode in which the oscilloscope searches for trigger event. The following is the schematic diagram of the acquisition memory from which you can see that the position of the trigger event is determined by the reference time point and the delay setting.

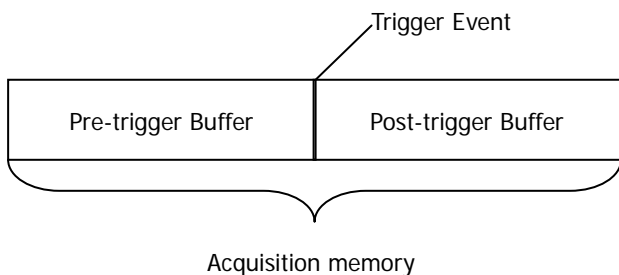

Pre-trigger/ Delayed trigger:

Acquire data before/after the trigger event. The trigger position is usually at the horizontal center of the screen. In full-screen display, you can view seven-grid pre-trigger and delayed trigger information. You can adjust the horizontal position of the waveform through **HORIZONTAL POSITION** to view more pre-trigger information or delayed trigger information, through which to know the signal information before/after the trigger (e.g. capture the glitch generated by the circuit and analyze the pre-trigger data to find out the reasons for generating glitch).

Press **MODE** in the trigger control area (TRIGGER) on the front panel or through the **MENU** → **Sweep** menu to select the desired trigger mode. The corresponding status light of the mode currently selected turns on.

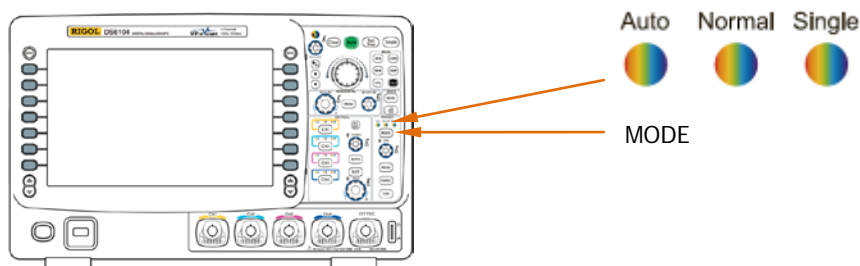

Auto:

No matter whether the trigger condition is met, there is always waveform display. A horizontal line is displayed when no signal is input.

When this mode is selected, the oscilloscope fills the pre-trigger buffer first and then search for a trigger while at the same time continues filling data. When the oscilloscope is searching for trigger, the data firstly filled into the pre-trigger buffer will overflow and be pushed out of the FIFO queue. When a trigger is found, the pre-trigger buffer would contain the data acquired before the trigger. If no trigger is found, the oscilloscope will trigger forcefully.

This trigger mode is applicable to signals with low repetitive rate and signals with unknown level. To display DC signals, this trigger mode must be used.

Normal:

Display the waveform when the trigger condition is met or hold the original waveform and wait for the next trigger when the trigger condition is not met.

When this mode is selected, the oscilloscope fills the pre-trigger buffer first and then search for a trigger while at the same time continues filling data. When the oscilloscope is searching for trigger, the data firstly filled into the pre-trigger buffer will overflow and be pushed out of the FIFO queue. When a trigger is found, the oscilloscope will fill the post-trigger buffer and display the acquisition memory.

This trigger mode is applicable to signal with low repetitive rate and signal that does not require auto trigger.

Note: In this mode, press **FORCE** to generate a trigger signal forcefully.

Single:

After this mode is selected, the backlight of **Single** turns on, the oscilloscope waits for a trigger and displays the waveform when the trigger condition is met and then stops.

Note: In this mode, press **FORCE** to generate a trigger signal forcefully.

Trigger Coupling

Trigger coupling decides which kind of components will be transmitted to the trigger circuit. Note to distinguish it with "**Channel Coupling**".

- DC: allow the DC and AC components to pass the trigger path.
- AC: block all the DC components and attenuate signals lower than 8 Hz.
- LF reject: block the DC components and reject the low frequency components lower than 5 kHz.
- HF reject: reject the high frequency components higher than 50 kHz.

Press **MENU** (in the trigger control area (TRIGGER) on the front panel) → **Setting** → **Coupling** to select the desired coupling type (the default is DC).



Note: Trigger coupling is only valid in edge trigger.

Trigger Holdoff

Trigger holdoff could trigger complicated waveforms (e.g. pulse sequence) stably. Holdoff time is the time the oscilloscope waits to re-enable the trigger module. Within the holdoff time, the oscilloscope will not trigger even if the triggering conditions are met. The oscilloscope will not re-enable the trigger module until the holdoff time expires.

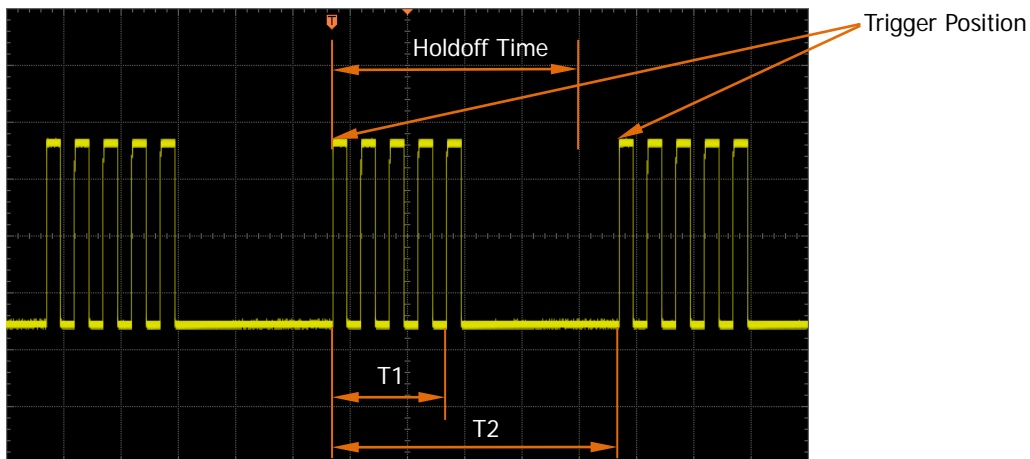
For example, to stably trigger the repeat pulse series as shown in the figure below, the holdoff time should be set to a value greater than T1 and lower than T2.



Press **MENU** (in the trigger control area (TRIGGER) on the front panel) → **Setting** → **Holdoff** and use  or the inner knob of the navigation knob  to adjust the holdoff time (the default is 100 ns) with a small step value, or use the outer knob of the navigation knob  to quickly adjust the holdoff time within a relatively larger range until the waveform triggers stably. (The greater the rotation amplitude of the outer knob, the faster the variations in the values.) The available range of the holdoff time for adjustment is from 100 ns to 10 s.

Note: The holdoff setting is disabled for video trigger, RS232 trigger, I2C trigger, SPI trigger, CAN trigger, FlexRay trigger, and USB trigger.

Trigger Type

DS6000 has abundant trigger functions, including a variety of serial bus triggers.

- Edge Trigger
- Pulse Trigger
- Slope Trigger
- Video Trigger
- Pattern Trigger
- RS232 Trigger
- I2C Trigger
- SPI Trigger
- CAN Trigger
- FlexRay Trigger
- USB Trigger

Edge Trigger

Trigger on the trigger threshold of the specified edge of the input signal.

Trigger Type:

Press **Type** to select "Edge". At this point, the trigger setting information as shown in the figure below is displayed at the upper-right corner of the screen.





Source Selection:

Press **Source** to select CH1-CH4, EXT, EXT/5 or AC Line as the **Trigger Source**. The current trigger source is displayed at the upper-right corner of the screen.

Note: Select channel with signal input as trigger source to obtain stable trigger.

Edge Type:

Press **Slope** to select to trigger on which kind of edge of the input signal. The current edge type is displayed at the upper-right corner of the screen.

- : trigger on the rising edge of the input signal when the voltage level meets the preset Trigger Level.
- : trigger on the falling edge of the input signal when the voltage level meets the preset Trigger Level.
- : trigger on the rising and falling edges of the input signal when the voltage level meets the preset Trigger Level.



Trigger Mode:

Press **Sweep** to select the **Trigger Mode** (page 5-3) under this trigger type as auto, normal or single. The corresponding status light of the current trigger mode turns on.

Trigger Setting:

Press **Setting** to set the trigger parameters (trigger coupling and trigger holdoff) under this trigger type.

Trigger Level:

Use **TRIGGER**  **LEVEL** to modify the level. An orange trigger level line and the trigger mark "" appear on the screen and move up and down with the turning of

the knob, while at the same time, the trigger level value (e.g. ) at the lower-left corner of the screen also changes accordingly. When stopping turning the knob, the trigger level line and the trigger mark disappear in about 2 seconds.

Pulse Trigger

Trigger on positive or negative pulse with specified width.

Trigger Type:

Press **Type** to select "Pulse". At this point, the trigger setting information as shown in the figure below is displayed at the upper-right corner of the screen.









Source Selection:

Press **Source** to select CH1-CH4 or EXT as the **Trigger Source**. The current trigger source is displayed at the upper-right corner of the screen.

Note: Select channel with signal input as trigger source to obtain stable trigger.

Pulse Condition:







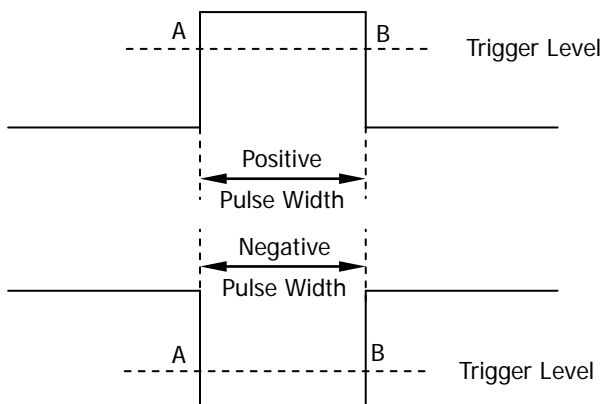

Press **When** to select the desired pulse condition.

- : trigger when the positive pulse width of the input signal is greater than the specified Pulse Width.
- : trigger when the positive pulse width of the input signal is lower than the specified Pulse Width.
- : trigger when the positive pulse width of the input signal is greater than the specified Lower Limit of Pulse Width and lower than the Upper Limit of Pulse Width.
- : trigger when the negative pulse width of the input signal is greater than the specified Pulse Width.
- : trigger when the negative pulse width of the input signal is lower than the specified Pulse Width.
- : trigger when the negative pulse width of the input signal is greater than the specified Lower Limit of Pulse Width and lower than the Upper Limit of Pulse Width.

Pulse Width Setting:

In this oscilloscope, positive pulse width is defined as the time difference between the two crossing points of the trigger level and positive pulse; negative pulse width is defined as the time difference between the two crossing points of the trigger level and negative pulse, as shown in the figure below.



- When the **Pulse Condition** is set to , ,  or , press **Setting** and use  to input the desired value. The range available is from 4 ns to 4 s.
- When the **Pulse Condition** is set to  or , press **Upper Limit** and **Lower Limit** respectively and use  to input the desired values. The range of the upper limit available is from 12 ns to 4 s. The range of the lower limit available is from 4 ns to 3.99 s. Note: The lower limit of the pulse width must be lower than the upper limit.

Trigger Mode:

Press **Sweep** to select the **Trigger Mode** (page 5-3) under this trigger type as auto, normal or single. The corresponding status light of the current trigger mode turns on.

Trigger Setting:

Press **Setting** to set the trigger parameters (trigger holdoff) under this trigger type.

Trigger Level:

Use **TRIGGER**  **LEVEL** to modify the level. For details, please refer to the description of **Trigger Level** on page 5-8.

Slope Trigger

Trigger on the positive or negative slope with specified time.

Trigger Type:

Press **Type** to select "Slope". At this point, the trigger setting information as shown in the figure below is displayed at the upper-right corner of the screen.









Source Selection:

Press **Source** to select CH1-CH4 as the **Trigger Source**. The current trigger source is displayed at the upper-right corner of the screen.

Note: Select channel with signal input as trigger source to obtain stable trigger.

Slope Condition:







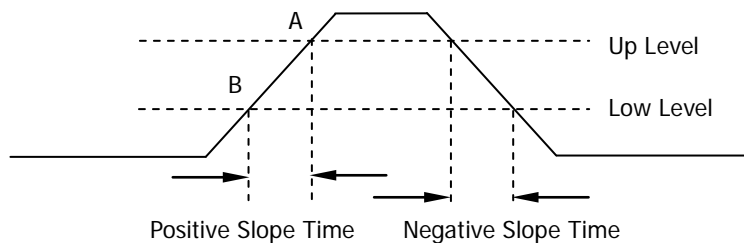

Press **When** to select the desired slope condition.

- : trigger when the positive slope time of the input signal is greater than the specified Time.
- : trigger when the positive slope time of the input signal is lower than the specified Time.
- : trigger when the positive slope time of the input signal is greater than the specified Lower Limit of Time and lower than the specified Upper Limit of Time.
- : trigger when the negative slope time of the input signal is greater than the specified Time.
- : trigger when the negative slope time of the input signal is lower than the specified Time.
- : trigger when the negative slope time of the input signal is greater than the specified Lower Limit of Time and lower than the specified Upper Limit of Time.

Time Setting:



In this oscilloscope, positive slope time is defined as the time difference between the two crossing points of the two trigger level lines (the trigger level upper limit (namaely Up Level) and the trigger level lower limit (namaely Low Level)) with the positive edge; negative slope time is defined as the time difference between the two crossing points of the two trigger level lines with the negative edge, as shown in the figure below:







- When the **Slope Condition** is set to , ,  or , press **Time** and use  to input the desired value. The range available is from 10 ns to 1 s.
- When the **Slope Condition** is set to  or , press **Upper Limit** and **Lower Limit** respectively and use  to input the desired values. The range of time upper limit available is from 20 ns to 1 s. The range of the time lower limit available is from 10 ns to 999 ms. Note: The time lower limit must be lower than the upper limit.

Vertical Window:

Press **Vertical** to select the desired vertical window.

You can select the boundaries of the trigger level and then use **TRIGGER**  **LEVEL** to adjust the trigger level. During the adjustment, two orange trigger level lines and two trigger marks ( and ) appear on the screen and move up and down with the turning of the knob. Meanwhile, the trigger level information is displayed at the lower-left corner of the screen. When stopping turning the knob, the trigger level lines and trigger level information will disappear in about 2 seconds.

When the **Slope Condition** is set to , , , or , the current trigger level and slope value will be displayed at the lower-left corner of the screen.

When the **Slope Condition** is set to  or , the current trigger level and slope range will be displayed at the lower-left corner of the screen.

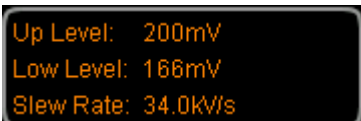

$$\text{SlewRate} = \frac{\text{UpLevel} - \text{LowLevel}}{\text{TimeSettingValue}}$$

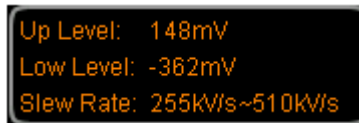

$$\text{SlewRate} = \frac{\text{UpLevel} - \text{LowLevel}}{\text{TimeUpperLimit}} \sim \frac{\text{UpLevel} - \text{LowLevel}}{\text{TimeLowerLimit}}$$

The adjustment mode of the trigger level is different when different vertical window is selected:

- : only adjust the upper limit of the trigger level. During the adjustment, the "UP Level" and the "Slew Rate" change accordingly but the "Low Level" remains unchanged.
- : only adjust the lower limit of the trigger level. During the adjustment, the "Low Level" and the "Slew Rate" change accordingly but the "UP Level" remains unchanged.
- : adjust the upper and lower limits of the trigger level at the same time. During the adjustment, the "UP Level" and the "Low Level" change accordingly but the "Slew Rate" remains unchanged.

Note: If you select "Slope" under the **Type** menu, you can press down **Trigger** **LEVEL** continuously to switch over the options under the **Vertical** menu.

Trigger Mode:

Press **Sweep** to select the **Trigger Mode** (page 5-3) under this trigger type as auto, normal or single. The corresponding status light of the current trigger mode turns on.

Trigger Setting:

Press **Setting** to set the trigger parameters (trigger holdoff) under this trigger type.

Video Trigger

Trigger on the standard video signal fields and lines of NTSC (National Television Standards Committee), PAL (Phase Alternating Line), SECAM (sequential color with memory) or HDTV (High Definition Television).

Trigger Type:

Press **Type** to select "Video". At this point, the trigger setting information as shown in the figure below is displayed at the upper-right corner of the screen.



Source Selection:

Press **Source** to select CH1-CH4 as the **Trigger Source**. The current trigger source is displayed at the upper-right corner of the screen.

Note: Select channel with signal input as trigger source to obtain stable trigger.

Video Polarity:

Press **Polarity** to select the desired video polarity. The polarities available are normal polarity (▬) and inverted polarity (▮).

Sync:

Press **Sync** to select the desired sync type.

- All lines: trigger on the first line found.
- Line number: for NTSC and PAL/SECAM video standards, trigger on the specified line in the odd or even field; for HDTV video standard, trigger on the specified line. Note that when this sync trigger mode is selected, you can modify the line number using ↻ in the **Line Num** menu with a step of 1. The range of the line number is from 1 to 525 (NTSC), 1 to 625 (PAL/SECAM), 1 to 525 (480P), 1 to 625 (576P), 1 to 750 (720P), 1 to 1125 (1080P) or 1 to 1125 (1080I).
- Odd field: trigger on the rising edge of the first ramp waveform pulse in the odd field.
- Even field: trigger on the rising edge of the first ramp waveform pulse in the even field.

Video Standard:

Press **Standard** to select the desired video standard.

- NTSC: the field frequency is 60 fields per second and the frame frequency is 30 frames per second. The TV sweep line is 525 with the even field goes first and the odd field follows behind.
- PAL/SECAM:
 - PAL: the frame frequency is 25 frames per second. The TV sweep line is 625 with the odd field goes first and the even field follows behind.
 - SECAM: the frame frequency is 25 frames per second. The sweep line is 625 with interlacing sweep.
- 480P: the frame frequency is 60 frames per second; the TV scan line is 525; progressive scan; the line frequency is 31.5 kHz.
- 576P: the frame frequency is 60 frames per second; the TV scan line is 625; progressive scan.
- HDTV: HDTV consists of 720P, 1080P, and 1080I display formats. The specified video standards are as follows:
 - 720P: the frame frequency is 60 frames per second; the TV scan line is 750; progressive scan; the line frequency is 45 kHz.
 - 1080P: the frame frequency is 60 frames per second; the TV scan line is 1125; progressive scan; professional format.
 - 1080I: the field frequency is 50 to 60 fields per second; the frame frequency is 25 to 30 frames per second; the TV scan line is 1125; interlaced sweep; the line frequency is 33.75 kHz.

Trigger Mode:

Press **Sweep** to select the **Trigger Mode** (page 5-3) under this trigger type as auto, normal or single. The corresponding status light of the current trigger mode turns on.

Trigger Level:

Use **TRIGGER**  **LEVEL** to modify the level. For details, please refer to the description of **Trigger Level** on page 5-8.

Pattern Trigger

Identify the trigger condition through searching for the specified pattern. Pattern is the logic "AND" combination of each channel and the value of each channel can be H (High), L (Low) or X (Don't Care). One channel in the pattern can be specified with rising edge or falling edge and if the pattern settings of all the other channels are "True" (namely, the actual pattern of the channel is the same with the preset pattern; H or L), the oscilloscope will trigger on the specified edge. If no edge is specified, the oscilloscope will trigger on the last edge that makes the pattern as "True". If patterns of all the channels are set to "Don't Care", the oscilloscope would not trigger.

Trigger Type:

Press **Type** to select "Pattern". At this point, the trigger setting information as shown in the figure below is displayed at the upper-right corner of the screen.

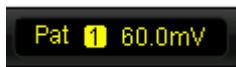

Channel Selection:

Press **Source** to select CH1-CH4 or EXT as the Trigger Source for H, L, X or edge condition. The current trigger source is displayed at the upper-right corner of the screen.

Pattern Setting:

Press **Code** to set the pattern code of the current channel. At this point, the pattern setting area will be displayed at the bottom of the screen, see below.



- **H**: set the pattern of the channel selected to "H", namely the voltage level is higher than the threshold level of the channel.
- **L**: set the pattern of the channel selected to "L", namely the voltage level is lower than the threshold level of the channel.
- **X**: set the pattern of the selected channel to "Don't Care", namely this channel is not a part of the pattern. When all the channels in the pattern are set to "Don't Care", the oscilloscope will not trigger.
- **↗** or **↘**: set the pattern to the rising or falling edge of the channel selected.

Note: In the pattern, you can only specify one rising edge or falling edge. If one edge item is currently defined and then another channel in the pattern is selected to define another edge item, thus the former edge item defined will be replaced by X.



Pat CH1 H XX CH4 X EXT



Pat CH1 HX X CH4 X EXT

Trigger Mode:

Press **Sweep** to select the **Trigger Mode** (page 5-3) under this trigger type as auto, normal or single. The corresponding status light of the current trigger mode turns on.

Trigger Setting:

Press **Setting** to set the trigger parameters (trigger holdoff) under this trigger type.

Trigger Level:

Use **TRIGGER**  **LEVEL** to modify the level. For details, please refer to the description of **Trigger Level** on page 5-8. Note that the trigger level of each channel needs to be set respectively.

RS232 Trigger

Trigger according to the start frame, error frame, check error or data. Below is the explanatory figure of RS232 protocol.

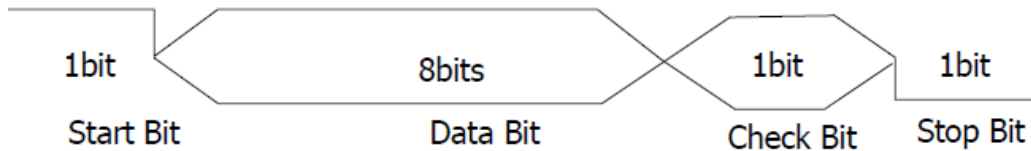

Trigger Type:

Press **Type** to select "RS232". At this point, the trigger setting information as shown in the figure below is displayed at the upper-right corner of the screen.

232 ⓘ -62.5mV

Source Selection:

Press **Source** to select CH1-CH4 as the **Trigger Source**. The current trigger source is displayed at the upper-right corner of the screen.

Polarity

Press **Polarity** to select the polarity of data transmission. It can be set to "Normal" or "Invert". The default is "Normal".

Trigger Condition:

Press **When** to select the desired trigger condition.

- Start: trigger on the start frame position.
- Error: trigger when error frame is detected. After this trigger condition is selected:
 - Press **Stop Bit** to select "1 bit" or "2 bit";
 - Press **Even-Odd** to select "None", "Odd", or "Even".
 The oscilloscope will determine the error frame according to the parameter settings.
- CheckError: trigger when a check error is detected. After this trigger condition is selected:
 - Press the **Stop Bit** softkey to select "1 bit" or "2 bit";

--Press the **Even-Odd** softkey to select "Odd" or "Even".

The oscilloscope will determine the check error according to the parameter settings.

- Data: trigger on the last bit of the preset data bits and even-odd check bits.

When this trigger condition is selected:

--Press **Data Bits** to select "5 bit", "6 bit", "7 bit", or "8 bit";



--Press **Data** and rotate the knob  to set the data value. The ranges of data value vary with the setting in **Data Bits**. The data value ranges from 0 to 31 if **Data Bits** is selected to be "5 bit"; the data value ranges from 0 to 63 if **Data Bits** is selected to be "6 bit"; the data value ranges from 0 to 127 if **Data Bits** is selected to be "7 bit"; and the data value ranges from 0 to 255 if **Data Bits** is selected to be "8 bit".

--Press the **Stop Bit** softkey to select "1 bit" or "2 bit";

--Press the **Even-Odd** softkey to select "None", "Odd", or "Even".

The oscilloscope will determine the data according to the parameter settings.

Baud Rate:

Press **Baud** to select the baud rate (equal to specifying a clock frequency) of the data transmission. The rates available include 2400 bps, 4800 bps, 9600 bps (default), 19200 bps, 38400 bps, 57600 bps, 115200 bps, 230400 bps, 460800 bps, 921600 bps, 1 Mbps and user-defined. After "User" is selected, press **Setup**; use  or the inner layer of the navigation knob  to adjust the baud rate at the specified step (1 bps), or use the outer layer of the navigation knob  to quickly adjust the baud rate within a relatively larger range. (The greater the rotation amplitude of the outer layer, the faster the variations in the values.) The settable range is from 110 bps to 20 Mbps.

Trigger Mode:

Press **Sweep** to select the **Trigger Mode** (page 5-3) under this trigger type as auto, normal or single. The corresponding status light of the current trigger mode turns on.

Trigger Level:

Use **TRIGGER**  **LEVEL** to modify the level. For details, please refer to the description of **Trigger Level** on page 5-8.

I2C Trigger

Trigger on the start condition, restart, stop and missing acknowledgement or on the read/write frame with specific device address and data value. When using I2C trigger, you need to specify the SCL and SDA data sources. The figure below shows the complete data transmission of I2C bus.

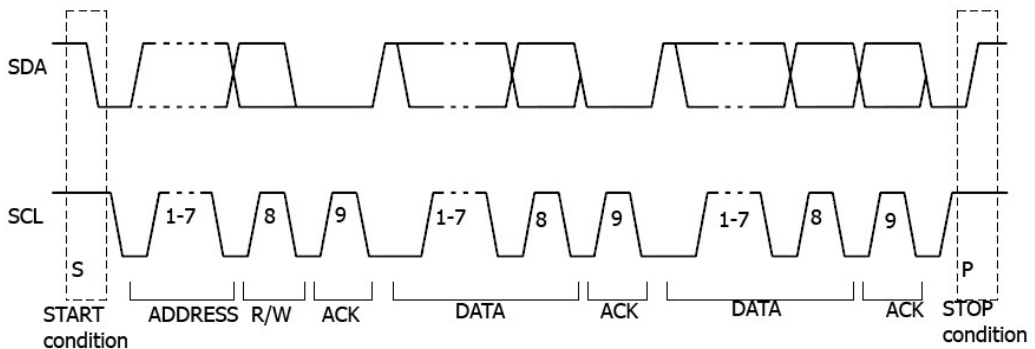

Trigger Type:

Press **Type** to select "I2C". At this point, the trigger setting information as shown in the figure below is displayed at the upper-right corner of the screen.

I2C 1 12.0mV

Source Selection:

Press **SCL** and **SDA** to specify the data sources of SCL and SDA respectively. CH1-CH4 can be selected as the data source. The current trigger source is displayed at the upper-right corner of the screen.

Trigger Condition:

Press **When** to select the desired trigger condition.

- Start: trigger when SDA data transitions from high to low while SCL is high.
- Restart: trigger when another start condition occurs before a stop condition.
- Stop: trigger when SDA data transitions from low to high while SCL is high.
- Missing ACK: trigger when the SDA data is high during any acknowledgement of SCL clock bit.

- Address: trigger on the clock (SCL) edge corresponding to the last byte data (SDA) behind the preset address (Write, Read or R/W direction). After this trigger condition is selected:
 - Press **AddrBits** to select "7 bit" , "8 bit" or "10 bit";
 - Press **Address** to set the address value according to the setting in **AddrBits** and the ranges are from 0 to 127, 0 to 255 and from 0 to 1023 respectively;
 - Press **Direction** to select "Read", "Write" or "R/W". (Note: When **AddrBits** is set to "8 bit", this setting is not available.)
- Data: the trigger searches for the control byte value on the data line (SDA) following which there is a reading bit and an acknowledgement bit and then searches for the specified data value and qualifier. During this event, the oscilloscope will trigger on the clock edge of the acknowledgement bit behind the data byte. After this trigger condition is selected:
 - Press **ByteLength** to set the length of data and the range is from 1 to 5;
 - Press **CurrentBit** to select the desired data bit and the range is from 0 to (ByteLength×8-1);
 - Press **Data** to set the data pattern of the current data bit to X, H or L.
 - Press **AllBits** to set the data pattern of all the data bits to the data pattern specified in **Data**.
- A&D: trigger when the "Address" and "Data" conditions are met at the same time. After this trigger condition is selected:
 - Press **AddrBits** to select "7 bit" , "8 bit" or "10 bit";
 - Press **Address** to set the address value according to the setting in **AddrBits** and the ranges are from 0 to 127, from 0 to 255 and from 0 to 1023 respectively;
 - Press **ByteLength** to set the length of data and the range is from 1 to 5;
 - Press **CurrentBit** to select the desired data bit and the range is from 0 to (ByteLength×8-1);
 - Press **Data** to set the data pattern of the current data bit to X, H or L.
 - Press **AllBits** to set the data pattern of all the data bits to the data pattern specified in **Data**.
 - Press **Direction** to select "Read", "Write" or "R/W". (Note: When **AddrBits** is set to "8 bit", this setting is not available.)

Trigger Mode:

Press **Sweep** to select the **Trigger Mode** (page 5-3) under this trigger type as auto, normal or single. The corresponding status light of the current trigger mode turns on.

Trigger Level:

Use **TRIGGER**  **LEVEL** to modify the trigger level of SCL or SDA channel. For details, please refer to the description of **Trigger Level** on page 5-8.

SPI Trigger

Trigger on the data pattern with specified edge. When using SPI trigger, you need to specify the SCL, SDA and CS data sources. Below is the sequence chart of SPI bus data.

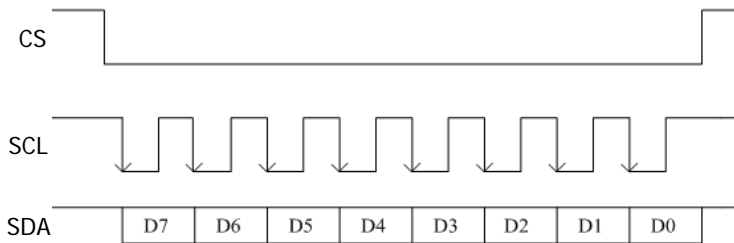

Trigger Type:

Press **Type** to select "SPI". At this point, the trigger setting information as shown in the figure below is displayed at the upper-right corner of the screen.



SPI 1 12.0mV

Source Selection:

Press **SCL** and **SDA** to specify the data sources of SCL and SDA respectively. CH1-CH4 can be selected as the data source. The current trigger source is displayed at the upper-right corner of the screen.

Trigger Condition:

Press **When** to select the desired trigger condition.

- CS: when this trigger condition is selected, press **CS** to specify the data source (CH1 to CH4) of CS. Press **Mode** to set the oscilloscope to trigger when the CS channel is "H" or "L".
- TimeOut: when this trigger condition is selected, press **TimeOut** to set the minimum time that the clock (SCL) signal must be idle before the oscilloscope will search for the data (SDA) on which to trigger. Use  or the inner knob of the navigation knob  to adjust the timeout time with a small step value or rotate the outer knob of the navigation knob  to quickly adjust the timeout time within a relatively larger range. (The greater the rotation amplitude of the outer knob, the faster the variations in the values.) The range is from 100 ns to 1 s.



Data Line Setting:

Press **Data** to set the instrument to trigger after the data channel (SDA) has transmitted data with specified bits and length.

- Press **Data Bits** to set the number of bits of the serial data character string. It can be set to any integer between 4 and 32.
- Press **CurrentBit** to input the data of the current bit and the range is from 0 to (the specified value in **Data Bits** -1).
- Press **Data** to set the value of the current bit to H, L or X.
- Press **AllBits** to set all the bits to the value specified in **Data** immediately.

Clock Edge:

Press **ClockEdge** to select the desired clock edge.

- : sample the SDA data on the rising edge of the clock.
- : sample the SDA data on the falling edge of the clock.

Trigger Mode:

Press **Sweep** to select the **Trigger Mode** (page 5-3) under this trigger type as auto, normal or single. The corresponding status light of the current trigger mode turns on.

Trigger Level:

Use **TRIGGER**  **LEVEL** to modify the level. For details, please refer to the description of **Trigger Level** on page 5-8.

CAN Trigger

Trigger on the specified frame type of the data frame. When using CAN trigger, you need to specify the signal source, signal rate and trigger signal type of the CAN signal. The figure below shows the format of the CAN bus data frame.

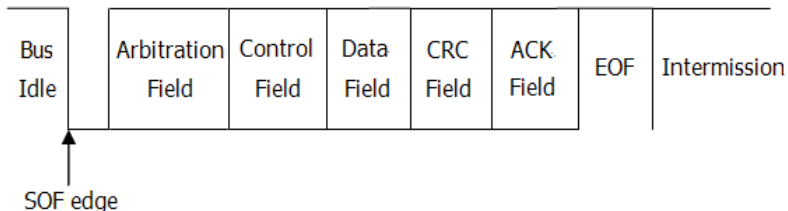

Trigger Type:

Press **Type** to select "CAN". At this point, the trigger setting information as shown in the figure below is displayed at the upper-right corner of the screen.



Source Selection:

Press **Source** to select CH1, CH2, CH3 or CH4 as the **Trigger Source**. The current trigger source is displayed at the upper-right corner of the screen.

Signal Type:

Press **Signal Type** to select the desired signal type.

- **Rx**: receiving signal from the CAN signal line.
- **Tx**: transmission signal from the CAN signal line.
- **CAN_H**: actual CAN_H bus signal.
- **CAN_L**: actual CAN_L bus signal.
- **Differential**: CAN differential bus signal connected to the analog channel by using the differential probe.



Trigger Condition:

Press **When** to select the desired trigger condition.

- **SOF**: trigger on the start frame position of the data frame.
- **EOF**: trigger on the end frame position of the data frame.

- **FrameType:** after this type is selected, press **FrameType** to select to trigger on "Data", "Remote", "Error" or "OverLoad".

"Data" trigger:

--Press **ID Setup** and select "SpecificID" or "Random ID". When "SpecificID" is selected, press **ID Format** and select "Standard" or "Expand"; press **ID Data** and use  or the inner knob of the navigation knob  to adjust the ID data at the specified step (1) or rotate the outer knob of the navigation knob  to quickly adjust the ID data within a relatively larger range. (The greater the rotation amplitude of the outer knob, the faster the variations in the values.) The range of the ID data is from 0 to 2047 (standard ID format) or 0 to 536870911 (expanded ID format).



--Press **Byte Length** and use  to set the desired value. The range is from 1 to 8.

--Press **CurrentBit** to select the desired data bit and the range is from 0 to (**Byte Length**×8-1).

--Press **Data** to set the data pattern of the current bit to X, H, or L.



--Press **AllBits** to set the data pattern of all the data bits to the data pattern specified in **Data**.

"Remote" trigger:

--Press **ID Setup** and select "SpecificID" or "Random ID". When "SpecifiedID" is selected, press **ID Format** and select "Standard" or "Expand"; press **ID Data** and use  or the inner knob of the navigation knob  to adjust the ID data at the specified step (1) or rotate the outer knob of the navigation knob  to quickly adjust the ID data within a relatively larger range. (The greater the rotation amplitude of the outer knob, the faster the variations in the values.) The range of the ID data is from 0 to 2047 (standard ID format) or 0 to 536870911 (expanded ID format).

- **FrameError:** after selecting this type, press **Error Type** to select to trigger on the "Bit Fill", "AnswerError", "CheckError", "FormatError", or "RandomError".

Baud:

Press **Baud** to set the CAN baud to match the CAN bus signal. The available values are 10 kb/s, 20 kb/s, 33.3 kb/s, 50 kb/s, 62.5 kb/s, 83.3 kb/s, 100 kb/s, 125 kb/s, 250 kb/s, 500 kb/s, 800 kb/s, 1 Mb/s (default), or User. After "User" is selected, press **User** and use  or the inner knob of the navigation knob  to adjust the signal rate with a small step value or rotate the outer knob of the navigation knob  to quickly adjust the signal rate within a relatively larger range. (The greater the

rotation amplitude of the outer knob, the faster the variations in the values.) The adjustable range is from 10 kb/s to 1 Mb/s.

Sample Point:

Sample point is the point within the bit time. The oscilloscope samples the bit level at this point. The sample point position is represented by the percentage that the "time from the start of the bit to the sample point" takes up in the "bit time".

Press **SamplePoint** and use  to modify the parameter with the step as 1% and the range is from 5% to 95%.

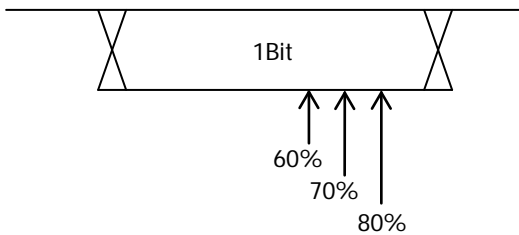

Trigger Mode:

Press **Sweep** to select the **Trigger Mode** (page 5-3) under this trigger type as auto, normal or single. The corresponding status light of the current trigger mode turns on.

Trigger Level:

Use **TRIGGER**  **LEVEL** to modify the level. For details, please refer to the description of **Trigger level** on page 5-8.

FlexRay Trigger

Trigger on the frame, symbol, error or TSS (Transmission Start Sequence) of FlexRay bus. FlexRay is a kind of differential serial bus configured with three continuous segments (namely packet header, payload and packet end). Its data transmission rate is up to 10 Mbps. Each frame contains a static and dynamic segment and ends with the bus idle time. The figure below shows the frame format of FlexRay protocol.

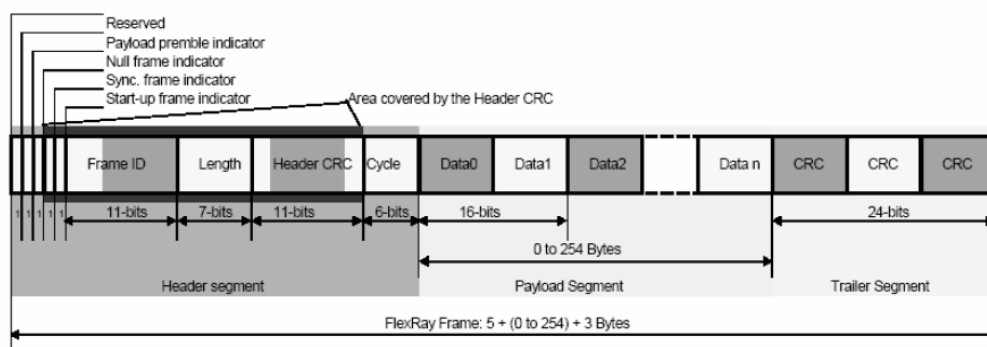

Trigger Type:

Press **Type** to select "FlexRay". At this point, the trigger setting information as shown in the figure below is displayed at the upper-right corner of the screen.



Source Selection:

Press **Source** to specify data source for FlexRay bus. CH1, CH2, CH3 or CH4 can be selected as the trigger source. The current signal source is displayed at the upper-right corner of the screen.

Baud:

Press **Baud** to set the signal rate to "2.5 Mb/s", "5 Mb/s" or "10 Mb/s".

Trigger Condition:

Press **When** to select the desired trigger condition.

- **FRAME:** trigger on the frame of FlexRay bus.
- **SYMBOL:** trigger on the CID (Channel Idle Delimiter), CAS (Collision Avoidance

Symbol), MTS (Media Access Test Symbol) and WUP (Wakeup Pattern) of FlexRay bus.

- **ERROR:** trigger when error occurs to FlexRay bus, including header CRC error and frame CRC error.
- **TSS:** trigger on the transmission start sequence of FlexRay bus.

Note: As the occurrence probability of specified FlexRay frame is very low, when the trigger condition is "Frame", it is recommended to set the oscilloscope to "Normal" trigger mode to prevent the instrument from triggering automatically when waiting for the specified frame. The same goes for "Error" trigger condition. What's more, the trigger holdoff might need to be adjusted to view a specified error when multiple FlexRay errors occur at the same time.

Trigger Mode:

Press **Sweep** to select the **Trigger Mode** (page 5-3) under this trigger type as auto, normal or single. The corresponding status light of the current trigger mode turns on.

Trigger Level:

Use **TRIGGER**  **LEVEL** to modify the level. For details, please refer to the description of **Trigger Level** on page 5-8.

USB Trigger

Trigger on the SOP, EOP, RC, Suspend and ExitSuspend of the data packet on the differential USB data cable (D+ and D-). This trigger supports USB Low Speed and Full Speed. The figure below shows the USB data transmission protocol.



Trigger Type:

Press **Type** to select "USB". At this point, the trigger setting information as shown in the figure below is displayed at the upper-right corner of the screen.

USB 1 12.0mV

Source Selection:

Press **D+** and **D-** to specify data sources for D+ and D- data cables respectively. CH1-CH4 can be selected as the data source. The current trigger source is displayed at the upper-right corner of the screen.

Signal Speed:

Press **Speed** to select "Low Speed" (1.5 Mb/s) or "Full Speed" (12 Mb/s).

Trigger Condition:

Press **When** to select the desired trigger condition.

- **SOP:** trigger at the sync bit at the beginning of the data packet (SOP).
- **EOP:** trigger at the end of the SEO portion of the data packet (EOP).
- **RC:** trigger when SEO is greater than 10 ms.
- **Suspend:** trigger when the bus enters the idle state for more than 3 ms.
- **ExitSuspend:** trigger when the bus exits from the idle state for more than 10 ms.

Trigger Mode:

Press **Sweep** to select the **Trigger Mode** (page 5-3) under this trigger type as auto, normal or single. The corresponding status light of the current trigger mode turns on.

Trigger Level:

Use **TRIGGER**  **LEVEL** to modify the level. For details, please refer to the description of **Trigger Level** on page 5-8.

Trigger Output Connector

The trigger output connector on the rear panel can output trigger signals decided by the current setting.

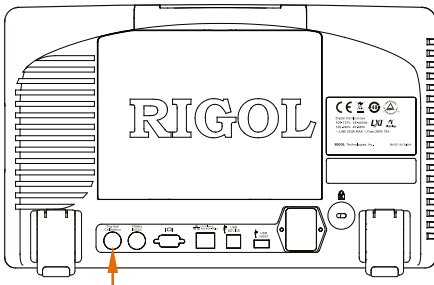

Trigger Output Connector

Press **UTIL** → **AuxOutput** to select "TrigOut". When the oscilloscope is triggered, it will output a signal that can reflect the current capture rate of the oscilloscope through the **[Trig Out/Calibration]** connector.

6 To Make Measurements

After data is sampled and displayed, DS6000 can make math operation, auto measurement and cursor measurement.

The contents of this chapter:

- Math Operation
- Auto Measure
- Cursor Measurement

Math Operation

DS6000 can realize various math operations of waveforms between channels including addition (A+B), subtraction (A-B), multiplication (AxB), division (A÷B), FFT, logic operation and advanced operation. The results of math operation also allows further measurement (for details, please refer to "**Cursor Measurement**").

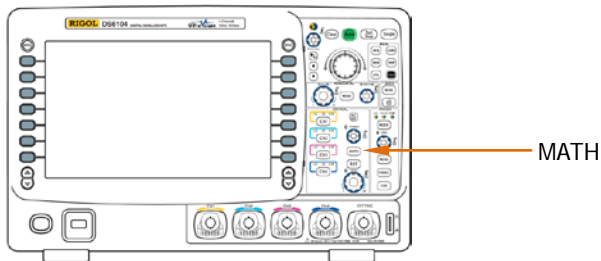

Press **MATH** (in the vertical control area (VERTICAL) on the front panel) → **Operate** to select the desired operation function. The result of the math operation is displayed on the waveform marked with "M" on the screen.

Addition

Add the waveform voltage values of signal source A and B point by point and display the results.

Press **MATH** → **Operate** to select "A+B":





- Press **Source A** and **Source B** to select the desired channels. The channels available are CH1, CH2, CH3 and CH4.
- Press **Invert** to turn the invert display of the operation results on or off.
- **VERTICAL** **POSITION**, **VERTICAL** **SCALE**, **HORIZONTAL** **POSITION** and **HORIZONTAL** **SCALE** can also be used to adjust the display of the operation results.
- Press **Label** to turn on the label modifying interface. You can refer to the introduction in "**Channel Label**" to set the label of the math operation waveform. Note: The new label can include uppercase English letters (A to Z), lowercase English letters (a to z), numbers (0 to 9), underlines and spaces and

the length cannot exceed 4 characters.

Subtraction

Subtract the waveform voltage values of signal source B from A point by point and display the results.





Press **MATH** → **Operate** to select "A-B":

- Press **Source A** and **Source B** to select the desired channels. The channels available are CH1, CH2, CH3 and CH4.
- Press **Invert** to turn the invert display of the operation results on or off.
- **VERTICAL**  **POSITION**, **VERTICAL**  **SCALE**, **HORIZONTAL**  **POSITION** and **HORIZONTAL**  **SCALE** can also be used to adjust the display of the operation results.
- Press **Label** to turn on the label modifying interface. You can refer to the introduction in "**Channel Label**" to set the label of the math operation waveform. Note: The new label can include uppercase English letters (A to Z), lowercase English letters (a to z), numbers (0 to 9), underlines and spaces and the length cannot exceed 4 characters.

Multiplication

Multiply the waveform voltage values of signal source A and B point by point and display the results.

Press **MATH** → **Operate** to select "AxB":





- Press **Source A** and **Source B** to select the desired channels. The channels available are CH1, CH2, CH3 and CH4.
- Press **Invert** to turn the invert display of the operation results on or off.
- **VERTICAL**  **POSITION**, **VERTICAL**  **SCALE**, **HORIZONTAL**  **POSITION** and **HORIZONTAL**  **SCALE** can also be used to adjust the display of the operation results.
- Press **Label** to turn on the label modifying interface. You can refer to the introduction in "**Channel Label**" to set the label of the math operation waveform. Note: The new label can include uppercase English letters (A to Z),

lowercase English letters (a to z), numbers (0 to 9), underlines and spaces and the length cannot exceed 4 characters.

Division

Divide the waveform voltage values of signal source A by B point by point and display the results. It can be used to analyze the multiple relationships of waveforms in two channels. Note that when the voltage value of the waveform of signal source B is 0, the result of the division is treated as 0.

Press **MATH** → **Operate** to select "A÷B":

- Press **Source A** and **Source B** to select the desired channels. The channels available are CH1, CH2, CH3 and CH4.
- Press **Invert** to turn the invert display of the operation results on or off.
- **VERTICAL**  **POSITION**, **VERTICAL**  **SCALE**, **HORIZONTAL**  **POSITION** and **HORIZONTAL**  **SCALE** can also be used to adjust the display of the operation results.
- Press **Label** to turn on the label modifying interface. You can refer to the introduction in "**Channel Label**" to set the label of the math operation waveform. Note: The new label can include uppercase English letters (A to Z), lowercase English letters (a to z), numbers (0 to 9), underlines and spaces and the length cannot exceed 4 characters.

FFT

FFT is used to quickly perform Fourier transform on specified signals and transform time domain signals to frequency domain signals. Use FFT to facilitate the following works:

- Measure harmonic components and distortion in the system
- Measure the characteristics of the noise in the DC power
- Analyze vibration

Press **MATH** → **Operate** to select "FFT" and set the parameters of FFT operation.

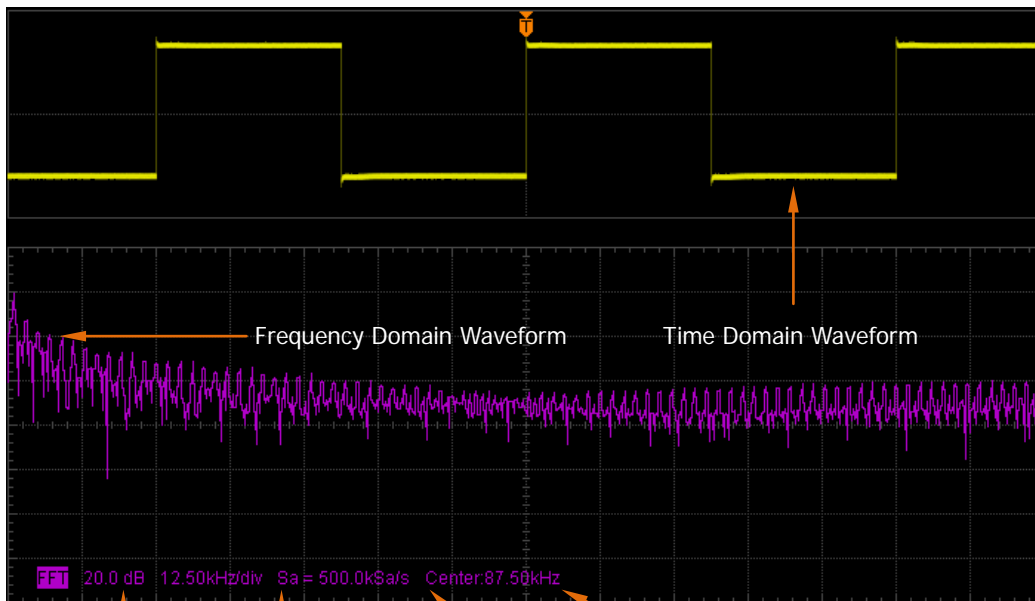

Vertical Amplitude Horizontal Scale FFT Sample Rate Center Frequency

1. Source Selection

Press **Source** to select the desired channel. The channels available are CH1, CH2, CH3 and CH4.

2. Select Window Function

Spectrum leakage can be considerably decreased when a window function is used. DS6000 provides four kinds of FFT window functions with different characteristics and are applicable to measure different waveforms. You need to

select the window function according to different waveforms and characteristics. Press **Window** to select the desired window function and the default is "Rectangle".

Table 6-1 Window Function

Window	Characteristics	Waveforms Suitable for Measurement
Rectangle	The best frequency resolution The poorest amplitude resolution Similar to the situation when no window is multiplied	Transient or short pulse, the signal levels before and after the multiplication are basically the same; Sine waveforms with the same amplitude and rather similar frequencies; Wide band random noise with relatively slowly changing waveform spectrum.
Hanning	Better frequency resolution poorer amplitude resolution	Sine, periodic and narrow band random noise.
Hamming	A little bit better frequency resolution than Hanning	Transient or short pulse, the signal levels before and after the multiplication are rather different.
Blackman	The best amplitude resolution The poorest frequency resolution	Single frequency signal, search for higher order harmonics.

3. Set the Display Mode

Press **Display** to select "Split" (default) or "Full Screen" display mode.



Split: the source channel waveform and the FFT operation results are displayed separately. The time domain and frequency domain signals are straightforward.

Full Screen: the source channel waveform and the FFT operation results are displayed in the same window to view the frequency spectrum more clearly and to perform more precise measurement.

Note: In FFT mode and when MATH is the active channel, you can also press **HORIZONTAL**  **SCALE** to switch to "Split" or "Full Screen".

4. Set the Horizontal Scale and Horizontal Position

In FFT measurement, the unit of the horizontal axis changes from Time to

Frequency, expressed in Hz. Use **HORIZONTAL**  **SCALE** and **HORIZONTAL**  **POSITION** to set the horizontal scale and the horizontal position of the FFT frequency spectrum respectively.

5. Set the Vertical Unit

The unit of the vertical axis can be in dB or Vrms, which displays the vertical amplitude in logarithmic mode and linear mode respectively. If you need to display the FFT frequency spectrum in a relatively larger dynamic range, dB is recommended. Press **Scale** to select the desired unit. The default unit is dB.

6. Set the Vertical Scale and Vertical Position

Use **VERTICAL**  **SCALE** and **VERTICAL**  **POSITION** to set the vertical scale and the vertical position of the FFT frequency spectrum respectively.

7. Turn on or off the anti-aliasing

Press **Anti-Aliasing** to turn the anti-aliasing on or off.

8. Modify the label of the math operation waveform

Press **Label** to turn on the label modifying interface. You can refer to the introduction in "**Channel Label**" to set the label of the math operation waveform. Note: The new label can include uppercase English letters (A to Z), lowercase English letters (a to z), numbers (0 to 9), underlines and spaces and the length cannot exceed 4 characters.

Tips

- Signals with DC components or deviation would cause error or deviation of the FFT waveform components. To reduce the DC components, set the "**Channel Coupling**" to "AC".
- To reduce the random noise and aliasing frequency components of repetitive or single pulse, set the "**Acquisition Mode**" of the oscilloscope to "Average".







Logic Operation

Perform logic operation on the voltage values of the waveform of the specified source channel point by point and display the results. In operation, when the voltage value of the waveform of the source channel is greater than the threshold of the corresponding channel, it is regarded as logic "1"; otherwise logic "0". The following common logic operation expressions are provided.

Table 6-2 Logic Operation

Operation	Description															
AND	<p>The results of logic AND operation of two binary bits are as follows:</p> <table> <thead> <tr> <th>A</th> <th>B</th> <th>A AND B</th> </tr> </thead> <tbody> <tr> <td>0</td> <td>0</td> <td>0</td> </tr> <tr> <td>0</td> <td>1</td> <td>0</td> </tr> <tr> <td>1</td> <td>0</td> <td>0</td> </tr> <tr> <td>1</td> <td>1</td> <td>1</td> </tr> </tbody> </table>	A	B	A AND B	0	0	0	0	1	0	1	0	0	1	1	1
A	B	A AND B														
0	0	0														
0	1	0														
1	0	0														
1	1	1														
OR	<p>The results of logic OR operation of two binary bits are as follows:</p> <table> <thead> <tr> <th>A</th> <th>B</th> <th>A OR B</th> </tr> </thead> <tbody> <tr> <td>0</td> <td>0</td> <td>0</td> </tr> <tr> <td>0</td> <td>1</td> <td>1</td> </tr> <tr> <td>1</td> <td>0</td> <td>1</td> </tr> <tr> <td>1</td> <td>1</td> <td>1</td> </tr> </tbody> </table>	A	B	A OR B	0	0	0	0	1	1	1	0	1	1	1	1
A	B	A OR B														
0	0	0														
0	1	1														
1	0	1														
1	1	1														
NOT	<p>The results of logic NOT operation of one binary bit are as follows:</p> <table> <thead> <tr> <th>A</th> <th>NOT A</th> </tr> </thead> <tbody> <tr> <td>0</td> <td>1</td> </tr> <tr> <td>1</td> <td>0</td> </tr> </tbody> </table>	A	NOT A	0	1	1	0									
A	NOT A															
0	1															
1	0															
XOR	<p>The results of logic XOR operation of two binary bits are as follows:</p> <table> <thead> <tr> <th>A</th> <th>B</th> <th>A XOR B</th> </tr> </thead> <tbody> <tr> <td>0</td> <td>0</td> <td>0</td> </tr> <tr> <td>0</td> <td>1</td> <td>1</td> </tr> <tr> <td>1</td> <td>0</td> <td>1</td> </tr> <tr> <td>1</td> <td>1</td> <td>0</td> </tr> </tbody> </table>	A	B	A XOR B	0	0	0	0	1	1	1	0	1	1	1	0
A	B	A XOR B														
0	0	0														
0	1	1														
1	0	1														
1	1	0														

Press **MATH** → **Operate** to select "Logic":

- Press **Formula** to select the desired operation formula and the default is AND.
- Press **Source A** and **Source B** to select the desired channels. The channels available are CH1, CH2, CH3 and CH4.
- Press **Invert** to turn the invert display of the operation results on or off.
- **VERTICAL**  **POSITION**, **VERTICAL**  **SCALE**, **HORIZONTAL**  **POSITION** and **HORIZONTAL**  **SCALE** can also be used to adjust the display of the operation results.
- Press **Threshold A** and use  to set the threshold of source A in logic operation.
- Press **Threshold B** and use  to set the threshold of source B in logic operation.
- Press **Label** to turn on the label modifying interface. You can refer to the introduction in "**Channel Label**" to set the label of the math operation waveform. Note: The new label can include uppercase English letters (A to Z), lowercase English letters (a to z), numbers (0 to 9), underlines and spaces and the length cannot exceed 4 characters.

Advanced Operation

DS6000 provides advanced operation function that allows user-defined operation functions. Press **MATH** → **Operate** → "Advanced" → **Expression** → "On", and the editing window as shown in the figure below is displayed on the screen.

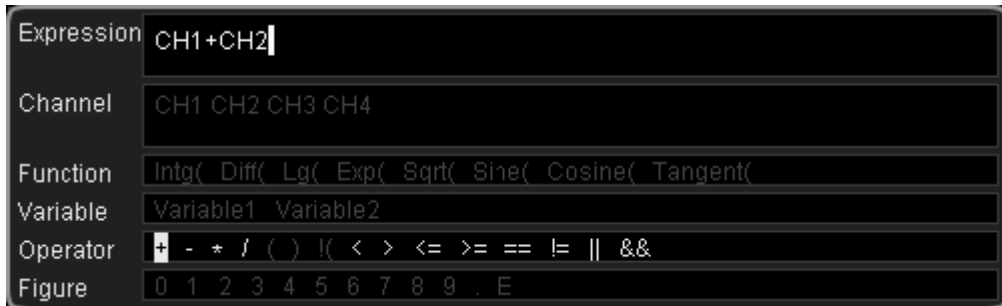

Turn  to select any item (if they are currently available for selection) in "Channel", "Function", "Variable", "Operator" and "Figure", then press down the knob and the item selected will be displayed in the entry box on the right of "Expression".

During the expression edit, you can press **Delete** to delete the character currently at the left of the cursor and press **Clear** to delete all the characters in the entry box at any time. After finishing the expression edit, press **Apply** and the oscilloscope will operate according to the expression you set and display the result. Note: After pressing **Apply**, the **Expression** menu will be automatically set to "OFF" but the preset expression will still be displayed at the bottom of the screen for your reference.

You can press **Invert** to turn the invert display of the operation results on or off. You can also press **Label** to turn on the label modifying interface and refer to the introduction in "**Channel Label**" to set the label of the math operation waveform.

Note: The new label can include uppercase English letters (A to Z), lowercase English letters (a to z), numbers (0 to 9), underlines and spaces and the length cannot exceed 4 characters.

The following are descriptions of the contents in the editing window.

1. Expression

Here, it refers to the formulas formed by channel, function, variable, operator and figure. The length of the expression is limited to 64 bytes.

2. Channel

You can select any of CH1, CH2, CH3 and CH4.

3. Function

Please refer to the following table to get the functions of each function. Note: The left brackets "(" here are only used to facilitate your entry and they are not a part of the function name.

Table 6-3 Function

Name	Function
Intg(Calculate the integral of the selected source. You can use integral to measure the area under a waveform or the pulse energy.
Diff(Calculate the discrete time derivative of the selected source. You can use differentiate to measure the instantaneous slope of a waveform.
Lg(Calculate the common logarithm of the selected source (use 10 as the base).
Exp(Calculate the exponent of the selected source. For example: Exp(A) means calculating the Ath power of e.
Sqrt(Calculate the square root of the selected source.
Sine(Calculate the sine value of the selected source.
Cosine(Calculate the cosine value of the selected source.
Tangent(Calculate the tangent value of the selected source.

4. Variable

Users can set Variable1 and Variable2 to desired values. Press **Variable** and turn on the setting menu as follows:

- **Variable:** press this softkey to select the variable needed to be set as "Variable1" and "Variable2".
- **Step:** press this softkey to set the step used when using the knob to modify

"Mantissa". The steps available are $\times 1$, $\times 0.1$, $\times 0.01$, $\times 0.001$ and $\times 0.0001$.

- **Mantissa:** press this softkey and turn  to modify the mantissa at the step specified in **Step**. The range available is from -9.9999 to 9.9999.
- **Exponent:** press this softkey to set the numeric values of the exponents with 10 as the base in the variables. The range is from -9 to 9.

For example, the following setting means set Variable1 to 6.1074×10^8 .

Variable: Variable1

Mantissa: 6.1074

Exponent: 8

5. Operator

Please refer to the following table to get the functions of each operator.

Table 6-4 Operator

Operator	Function
+ - * /	Arithmetic operators: add, subtract, multiply and divide
()	Parentheses: used to increase the priority of the operation enclosed in the parentheses
< > <= >= == !=	Relationship operators: lower than, greater than, lower than or equal to, greater than or equal to, equal to, not equal to
!(&&	Logic operator: NOT, OR, AND

Note: In division operation, when the divisor is 0, the result of the division is treated as 0.

6. Figure

Select from figure 0 to 9, decimal point and character E. Where, character E is used to refer to the n^{th} power of 10. For example, 1.5E3 means 1.5×10^3 .

Auto Measurement



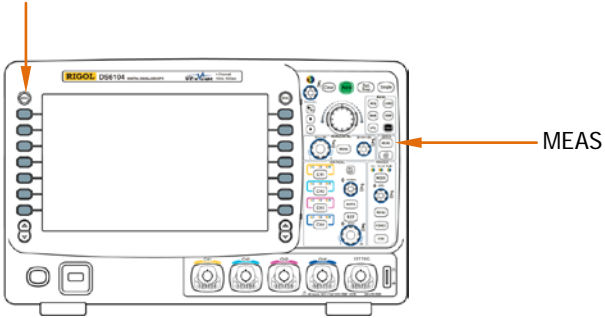

DS6000 provide auto measurements of 29 waveform parameters and the statistic and analytical functions of the measurement results. What's more, you can also use the frequency counter to realize more precise frequency measurement.

MENU



Quick Measurement after Auto

When the oscilloscope is correctly connected and has detected the input signal, press **Auto** to enable the waveform auto setting function and open the auto setting menu.

- : press this key; the oscilloscope automatically displays a single period of the signal on the screen and measures the "Period" and "Frequency" of the current signal within the period currently displayed. The measurement results are displayed at the bottom of the screen.
- : press this key; the oscilloscope automatically displays multiple periods of the signal on the screen and measures the "Period" and "Frequency" of the signal within the multiple periods currently displayed on the screen. The measurement results are displayed at the bottom of the screen.
- : press this key; the oscilloscope automatically displays a rising edge of the signal on the screen and measure the "Rise Time" of the rising edge currently displayed. The measurement result is displayed at the bottom of the screen.
- : press this key; the oscilloscope automatically displays a falling edge of the signal on the screen and measure the "Fall Time" of the falling edge currently displayed. The measurement result is displayed at the bottom of the screen.
- Pressing **Cancel** will automatically give up the auto setting and restore the parameter settings before **AUTO** is pressed.

Note: The waveform auto setting function requires that the frequency of the sine under test should be no lower than 20 Hz. If the parameter exceeds the limit, the waveform auto setting function might be invalid.

One-key Measurement

Press **MENU** at the left of the screen to turn on the measurement menu of the 29 parameters and then press the corresponding menu softkey to quickly realize "One-key" measurement. The measurement result will be displayed at the bottom of the screen. The 29 waveform parameters are as shown in the table below.

Table 6-5 29 Waveform Parameters

Parameter Type	Parameter Name
Time Parameter	Period, Frequency, Rise Time, Fall Time, + Width, -Width, +Duty Cycle, -Duty Cycle (please refer to "Time Parameters")
Delay and Phase Parameters	Delay A f \rightarrow B f , Delay A t \rightarrow B t , Delay A f \rightarrow B t , Delay A t \rightarrow B f , Phase A f \rightarrow B f , Phase A t \rightarrow B t , Phase A f \rightarrow B t , Phase A t \rightarrow B f (please refer to "Delay and Phase Parameters")
Voltage Parameter	Vmax, Vmin, Vpp, Vtop, Vbase, Vamp, Vavg, Vrms-N, Vrms-1, Overshoot, Preshoot (please refer to "Voltage Parameters")
Area Parameter	Area, Period Area (please refer to "Area Parameters")

The icons of time, voltage and area parameter menu items and the measurement results are always marked in the same color of the current measurement channel (**MEAS** \rightarrow **Source**) currently used. The delay and phase parameter menu items as well as the measurement results are displayed in white; the numbers in the menu items and results denote the source A and source B currently selected and the color of the numbers are the same with the color of the channel currently selected (**MEAS** \rightarrow **Setting** \rightarrow **Type** \rightarrow "Delay" or "Phase"). For example,

Parameter Icons:



Measurement Results:

Freq=1.000kHz

Max=62.50mV

Dly 1 \rightarrow 2 f =-5.000 μ s

Phs 1 \rightarrow 2 t =90.00 $^{\circ}$

Note: If the measurement result is displayed as "*****", it means that there is no signal input in the current source or the measurement result is not within the valid range (too large or too small).

Time Parameters

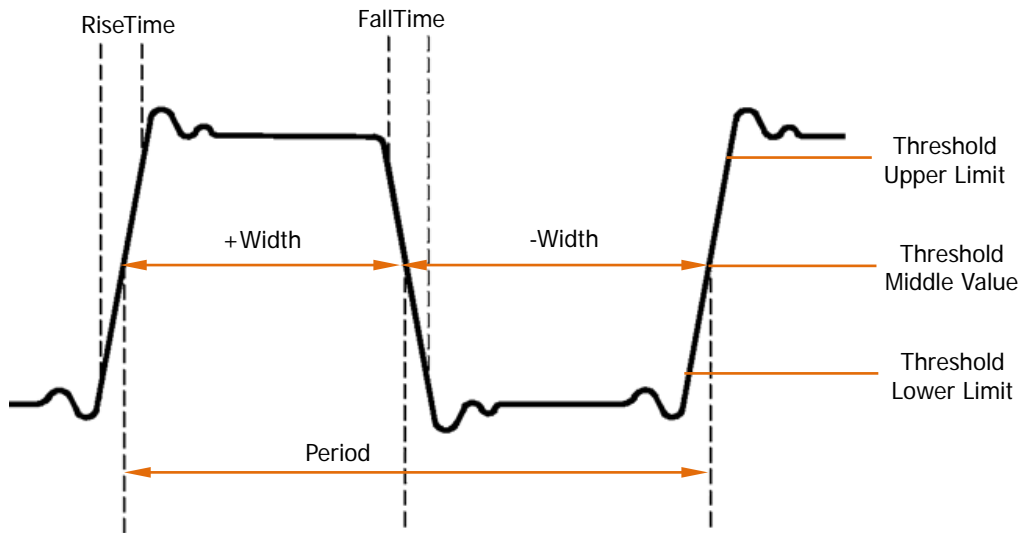

1. **Period:** the time between the threshold middle value of one edge to the threshold middle value of the next edge with the same polarity.
2. **Frequency:** the reciprocal of period.
3. **Rise Time:** the time for the signal amplitude to rise from the threshold lower limit to the threshold upper limit of the rising edge.
4. **Fall Time:** the time for the signal amplitude to fall from the threshold upper limit to the threshold lower limit of the falling edge.
5. **+ Width:** the time between the threshold middle value of a rising edge to the threshold middle value of the next falling edge.
6. **- Width:** the time between the threshold middle value of a falling edge to the threshold middle value of the next rising edge.
7. **+ Duty:** the ratio of the positive pulse width to the period.
8. **- Duty:** the ratio of the negative pulse width to the period.

Note: In the figure above, the default values of the threshold upper limit, threshold middle value and threshold lower limit are 90%, 50% and 10% respectively. You can also set them via **MEAS** → **Setting** → **Type** → "Threshold". For the setting method, refer to "**Measurement Setting**".

Delay and Phase Parameters

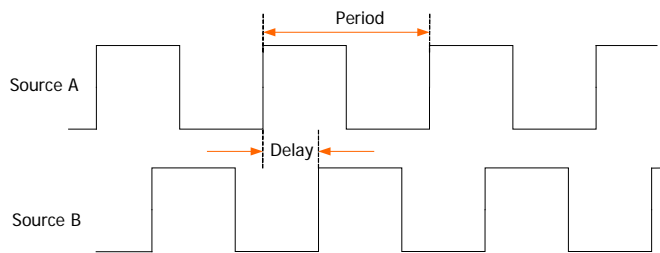

Source A and source B can be any of CH1, CH2, CH3 and CH4.

1. **Delay $A^f \rightarrow B^f$** : the time difference between the threshold middle values of the rising edges of source A and source B. Negative delay indicates that the rising edge of source A occurred after the rising edge of source B.
2. **Delay $A^{\bar{f}} \rightarrow B^{\bar{f}}$** : the time difference between the threshold middle values of the falling edges of source A and source B. Negative delay indicates that the falling edge of source A occurred after the falling edge of source B.
3. **Delay $A^f \rightarrow B^{\bar{f}}$** : the time difference between the threshold middle values of the rising edge of source A and the falling edge of source B. Negative delay indicates that the rising edge of source A occurred after the falling edge of source B.
4. **Delay $A^{\bar{f}} \rightarrow B^f$** : the time difference between the threshold middle values of the falling edge of source A and the rising edge of source B. Negative delay indicates that the falling edge of source A occurred after the rising edge of source B.
5. **Phase $A^f \rightarrow B^f$** : the phase difference (expressed in degree) between the threshold middle values of the rising edges of source A and source B and can be calculated according to "**Delay $A^f \rightarrow B^f$** " and the period of source A.
6. **Phase $A^{\bar{f}} \rightarrow B^{\bar{f}}$** : the phase difference (expressed in degree) between the threshold middle values of the falling edges of source A and source B and can be calculated according to "**Delay $A^{\bar{f}} \rightarrow B^{\bar{f}}$** " and the period of source A.
7. **Phase $A^f \rightarrow B^{\bar{f}}$** : the phase difference (expressed in degree) between the threshold middle values the rising edge of source A and the falling edge of source B and can be calculated according to "**Delay $A^f \rightarrow B^{\bar{f}}$** " and the period of source A.
8. **Phase $A^{\bar{f}} \rightarrow B^f$** : the phase difference (expressed in degree) between the

threshold middle values the falling edge of source A and the rising edge of source B and can be calculated according to "**Delay A_t → B_f**" and the period of source A.

The phase calculation formula: $Phase = \frac{Delay}{PeriodA} \times 360^\circ$

Wherein, *Phase* represents **Phase**, *Delay* represents **Delay**, *PeriodA* represents the period of source A.

Note: The default value of the threshold middle value is 50%. You can also set it via **MEAS** → **Setting** → **Type** → "Threshold". For the setting method, refer to "**Measurement Setting**".

Voltage Parameters

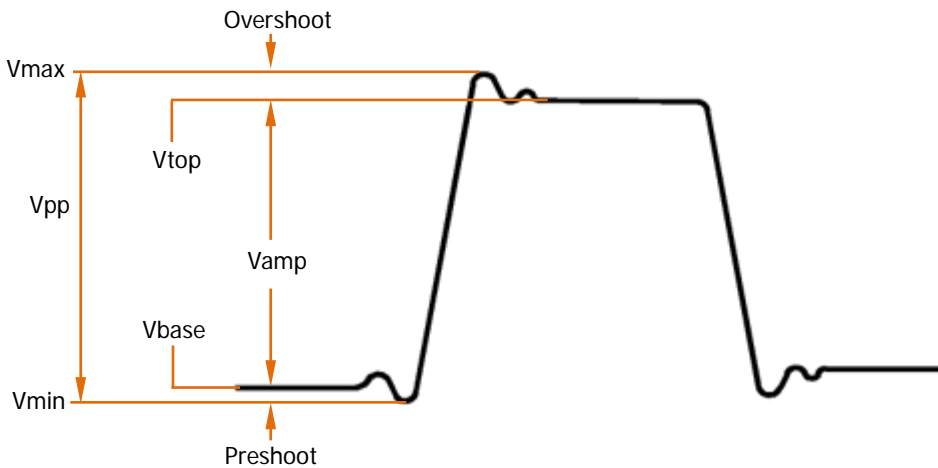

1. **Vmax**: the voltage value from the highest point of the waveform to the GND.
2. **Vmin**: the voltage value from the lowest point of the waveform to the GND.
3. **Vpp**: the voltage value from the highest point to the lowest point of the waveform.
4. **Vtop**: the voltage value from the flat top of the waveform to the GND.
5. **Vbase**: the voltage value from the flat base of the waveform to the GND.
6. **Vamp**: the voltage value from the top of the waveform to the base of the waveform.
7. **Vavg**: the arithmetic average value of the whole waveform or the waveform in the gating area.

$Average = \frac{\sum x_i}{n}$, where, x_i is the measurement result of the i^{th} point being measured, n is the number of points being measured.

8. **Vrms-N**: the root mean square value of the whole waveform or the waveform in the gating area.

$RMS = \sqrt{\frac{\sum_{i=1}^n x_i^2}{n}}$, where, x_i is the measurement result of the i^{th} point being measured, n is the number of points being measured.

9. **Vrms-1**: the root mean square value of a single period of waveform on the screen or in the gating area.

$$RMS = \sqrt{\frac{\sum_{i=1}^n x_i^2}{n}}, \text{ where, } x_i \text{ is the measurement result of the } i^{\text{th}} \text{ point being}$$

measured, n is the number of points being measured.

10. **Overshoot:** the ratio of the difference of the maximum value and top value of the waveform to the amplitude value.
11. **Preshoot:** the ratio of the difference of the minimum value and base value of the waveform to the amplitude value.

Area Parameters

1. **Area:** the area of the whole waveform or the waveform in the gating area and the unit is voltage-second. The area measured above the zero reference (namely the vertical offset) is positive and the area measured below the zero reference is negative. The area measured is the algebraic sum of the area of the whole waveform within the screen.
2. **Period Area:** the area of a single period of waveform on the screen or in the gating area and the unit is voltage-second. The area above the zero reference (namely the vertical offset) is positive and the area below the zero reference is negative. The area measured is the algebraic sum of the area of the whole period waveform.

Frequency Counter Measurement

The hardware frequency counter supplied with this oscilloscope can make more precise measurement of the signal frequency.

Press **MEAS** → **Counter** to select anyone of CH1-CH4 as the source. The measurement result is displayed at the upper-right corner of the screen and you can identify the current measurement source according to the color of the icon. The following figure is the result of the frequency measurement of the signal from CH1.



If "OFF" is selected, the frequency counter measurement function is turned off.



Note: When the frequency of the input signal of the measurement source is lower than 15 Hz, the measurement result displayed is "< 15 Hz".

Measurement Setting

1. Source Selection

Press **MEAS** → **Source** to select the desired channel for measurement (CH1-CH4 or MATH). The color of the parameter icon under **MENU** at the left of the screen will change with the source selected.

2. Measurement Range

Press **MEAS** → **Range** → **Range** to select "Screen" or "Cursor" for measurement. When "Cursor" is selected, two cursor lines appear on the screen. At this point, press **Cursor A** and **Cursor B** and use  to adjust the positions of the two cursor lines respectively so as to determine the measurement range. Or, press **CursorAB** and use  to adjust the positions of cursor A and cursor B at the same time. Note: You can press  continuously to switch among the cursors.

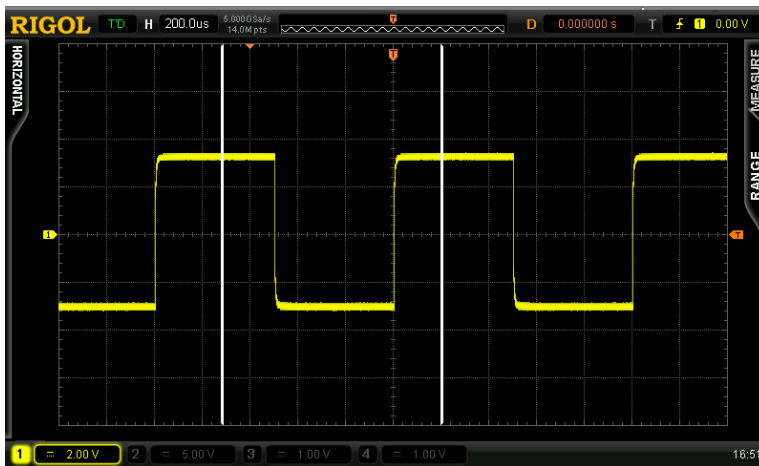

3. Delayed Measurement Setting

Specify the source A and source B in the measurement items "**Delay A^f → B^f**", "**Delay A^t → B^t**", "**Delay A^f → B^t**" and "**Delay A^t → B^f**".

Press **MEAS** → **Setting** → **Type** → "Delay" and then press **Source A** and **Source B** to set the two channel sources (CH1-CH4) of the delayed measurement respectively.

4. Phase Measurement Setting



Specify the source A and source B in the measurement items " **Phase A f →B f** ", " **Phase A t →B t** ", " **Phase A f →B t** " and " **Phase A t →B f** ".

Press **MEAS** → **Setting** → **Type** → "Phase" and then press **Source A** and **Source B** to set the two channel sources (CH1-CH4) of the phase measurement respectively.

5. Threshold Measurement Setting

Specify the vertical level (in percentage) being measured in the analog channel. Measurement of all the time, delay and phase parameters will be influenced by this setting.

Press **MEAS** → **Setting** → **Type** → "Threshold" and then:

- Press **Max** and use  to set the maximum value of the measurement. Reducing the maximum value to the current "Mid" will automatically reduce the middle value (might also include the minimum value) to keep it lower than the maximum value. The default is 90% and the range available is from 7% to 95%.
- Press **Mid** and use  to set the middle value of measurement. The middle value is limited by the settings of "Max" and "Min". The default is 50% and the range available is from 6% to 94%.
- Press **Min** and use  to set the minimum value of the measurement. Increasing the minimum value to the current "Mid" will automatically increase the middle value (might also include the maximum value) to keep it higher than the minimum value. The default is 10% and the range available is from 5% to 93%.

To Clear the Measurement

If you have currently turned on one or more items in the 29 measurement parameters, you can "Delete" or "Recover" at most 5 parameters that are turned on last or "Delete" or "Recover" all the measurement items that have been turned on. Note that the 5 parameters that are turned on last are determined according to the order in which you turned them on and they will not change as you delete one or more measurement items.

Press **MEAS** → **Clear** → **Item n** to "Delete" or "Recover" the specified measurement item. When one measurement item is deleted or recovered, the measurement result at the bottom of the screen will move one-item left or right.

Press **MEAS** → **Clear** → **All Items** to "Delete" or "Recover" all the measurement items that have been turned on.

Note: Press and hold **MEAS** to quickly remove and recover all the measurement items currently enabled.

All Measurement

All measurement could measure all the time, voltage and area parameters (each measurement source has 21 items, measurements can be performed on the five measurement sources at the same time) of the current measurement source and display the results on the screen. Press **MEAS** → **Display All** to turn the function on or off. Press **Measure Source** and use  to select the channel to be measured (CH1 to CH4 and MATH).

- When **Display All** is "On", one-key measurement is also valid.
- "**To Clear the Measurement**" will not clear all the measurement results.

Statistic Function

Make statistic and display the current, average, minimum (or standard deviation) and maximum (or count) values of at most 5 measurement items that are turned on last.

- Press **Measure** → **Statistic** to turn the statistic function on or off. When the statistic function is enabled, press **Mode** to select "Extremum" or "Difference" measurement. When "Extremum" is selected, the current value, average value, minimum value and maximum value are displayed. When "Difference" is selected, the current value, average value, standard deviation and count value are displayed.



Extremum Measurement

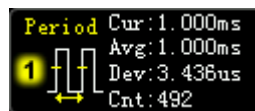

Difference Measurement

- Press **MEAS** → **Reset** to clear the history data and make statistic again.

Measurement History

To view the history measurement data, press **MEAS** → **History** → **History** → "On". The history data can be displayed in two modes:

- Graph: display the results of multiple measurements of at most 5 measurement items that are turned on last in graph mode. The measurement points are connected using linear interpolation.
- Table: display the results of the last 10 measurements of at most 5 measurement items that are turned on last in table mode.

Cursor Measurement

Cursors are the horizontal and vertical marks that can be used to measure the X axis values (usually Time) and Y axis values (usually Voltage) on a selected waveform. Please connect the signal to the oscilloscope and obtain stable display before using cursor measurement. All the "**Auto Measure**" parameters can be measured through cursor measurement.

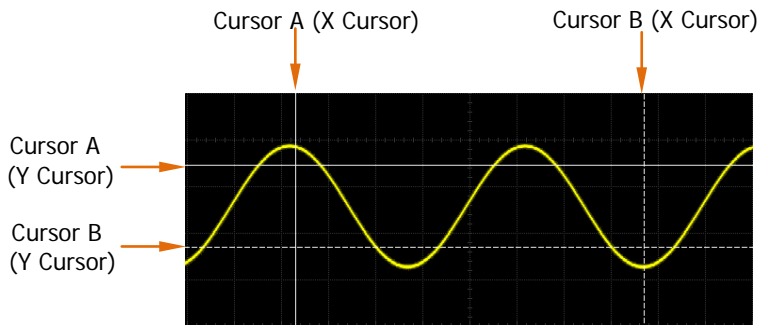

● X Cursors

The X cursors are a vertical solid line and a vertical dotted line used for horizontal adjustment. They can be used to measure the time (s), frequency (Hz), phase ($^{\circ}$) and ratio (%).

- Cursor A (X cursor) is a vertical solid line and cursor B (X cursor) is a vertical dotted line.
- When the measurement source is MATH and the operation type of MATH is FFT, the X cursors denote frequency.
- In X-Y cursor mode, the X cursors are used to measure the amplitude of the waveform of CH1 or CH3.

● Y Cursors

The Y cursors are a horizontal solid line and a horizontal dotted line used for vertical adjustment. They can be used to measure the amplitude (the unit is the same with the amplitude unit of the source channel) and ratio (%).

- Cursor A (Y cursor) is a horizontal solid line and cursor B (Y cursor) is a horizontal dotted line.
- When the measurement source is MATH, the measurement unit corresponds to the unit of the MATH function.

- In X-Y cursor mode, the Y cursors are used to measure the amplitude of the waveform of CH2 or CH4.

Press the front panel function menu **CURS** → **Mode**, use  to select the desired cursor mode (the default is Off) and then press the knob. The modes available include Manual, Track, Auto and X-Y. When "Off" is selected, the cursor measurement function will be turned off.

Note: You can only select X-Y cursor mode when the time base mode is set to "X-Y" (please refer to "**Time Base Mode**"); in addition, in "X-Y" time base mode, you can only use X-Y cursor mode.

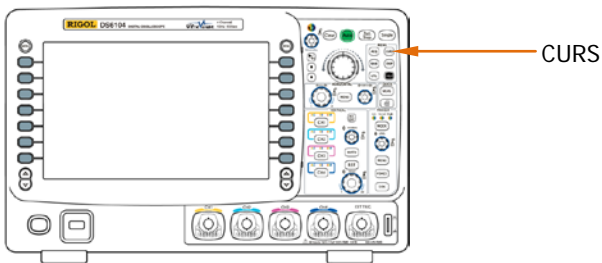

Manual Mode

In this mode, you can adjust the cursors manually to measure the X (or Y) values, the X increment (or Y increment) between the cursors and the reciprocal of the X increment of the waveform of the specified source (CH1-CH4 or MATH). The X cursors are a pair of vertical dotted lines and are usually used to measure the time parameters. The Y cursors are a pair of horizontal dotted lines and are usually used to measure the voltage parameters.

Press **CURS** → **Mode** → "Manual" to turn the manual mode on or press **CURS** continuously to switch to "Manual"; the measurement results will be displayed at the upper-left corner of the screen in the following mode.

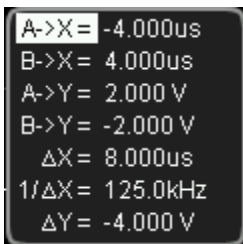

- The X value at cursor A (A->X): take the trigger position as reference.
- The X value at cursor B (B->X): take the trigger position as reference.
- The Y value at cursor A (A->Y): take the channel ground as reference.
- The Y value at cursor B (B->Y): take the channel ground as reference.
- The horizontal difference between cursors A and B (ΔX).
- The reciprocal of the horizontal difference between cursors A and B ($1/\Delta X$).
- The vertical difference between cursors A and B (ΔY).

If needed, please refer to the following steps to modify the parameters of manual cursor measurement.

1. Select the display mode

Press **DisplayMode** to select "X", "Y" or "X-Y".

- X: only display the X cursors (a pair of vertical solid/dotted lines).
- Y: only display the Y cursors (a pair of horizontal solid/dotted lines).
- X-Y: display the x cursors (a pair of vertical solid/dotted lines) and Y cursors

(a pair of horizontal solid/dotted lines) at the same time.

2. Select the measurement source

Press **Source** to select the waveform of the analog channels (CH1-CH4) or math operation result (MATH) for measurement (only channels enabled can be selected). If "None" is selected, no cursor will be displayed.

3. Select the X (Y) axis unit

When the current display mode is "X" or "X-Y", press **Time Unit** to select "s", "Hz", "°" or "%".

- s: when this unit is selected, in the measurement results, A->X, B->X and ΔX denote time and $1/\Delta X$ denotes frequency.
- Hz: when this unit is selected, in the measurement results, A->X, B->X and ΔX denote frequency and $1/\Delta X$ denotes time.
- °: when this unit is selected, in the measurement results, A->X, B->X and ΔX are in "°". At this point, A->X, B->X and ΔX will change to "0°", "360°" and "360°" respectively when you press **SetCursor**, no matter where cursors A and B are currently located. At the same time, two cursor lines (unmovable) appear on the screen as the reference positions.
- %: when this unit is selected, in the measurement results, A->X, B->X and ΔX are in percentage. At this point, A->X, B->X and ΔX will change to "0%", "100%" and "100%" respectively when you press **SetCursor**, no matter where cursors A and B are currently located. At the same time, two cursor lines (unmovable) appear on the screen as the reference positions.



When the current display mode is "Y" or "X-Y", press **Vertical Unit** to select "Source Unit" or "%".

- Source Unit: when this unit is selected, in the measurement, the units of A->X, B->X and ΔY will automatically be set to the unit of the current source.
- %: when this unit is selected, in the measurement results, A->X, B->X and ΔY are in percentage. At this point, A->X, B->X and ΔY will change to "0%", "100%" and "100%" respectively when you press **SetCursor**, no matter where cursor A and B are currently located. At the same time, two cursor lines (unmovable) appear on the screen as the reference positions.

4. Adjust the X (Y) cursor positions (note that under the same menu page, you can also press continuously to switch the current cursor)



When the display mode is "X" or when the display mode is "X-Y" and

SelectCursor is set to "X", you can adjust the positions of the X cursors.

- Adjust cursor A: press **CursorA** and use  to adjust the position of cursor A. During the adjustment, the measurement result will change accordingly. The adjustable range is limited within the screen.
- Adjust cursor B: press **CursorB** and use  to adjust the position of cursor B. During the adjustment, the measurement result will change accordingly. The adjustable range is limited within the screen.
- Adjust cursors A and B at the same time: press **CursorAB** and use  to adjust the positions of cursors A and B at the same time. During the adjustment, the measurement results will change accordingly. The adjustable ranges are limited within the screen.

When the display mode is "Y" or when the display mode is "X-Y" and

SelectCursor is set to "Y", you can adjust the positions of the Y cursors.

- Adjust cursor A: press **CursorA** and use  to adjust the position of cursor A. During the adjustment, the measurement result will change accordingly. The adjustable range is limited within the screen.
- Adjust cursor B: press **CursorB** and use  to adjust the position of cursor B. During the adjustment, the measurement result will change accordingly. The adjustable range is limited within the screen.
- Adjust cursors A and B at the same time: press **CursorAB** and use  to adjust the positions of cursors A and B at the same time. During the adjustment, the measurement results will change accordingly. The adjustable ranges are limited within the screen.

5. Measurement Example

Use manual cursor measurement to measure the period (ΔX) of a sine waveform and the result is 10 us equaling the result from auto measurement.

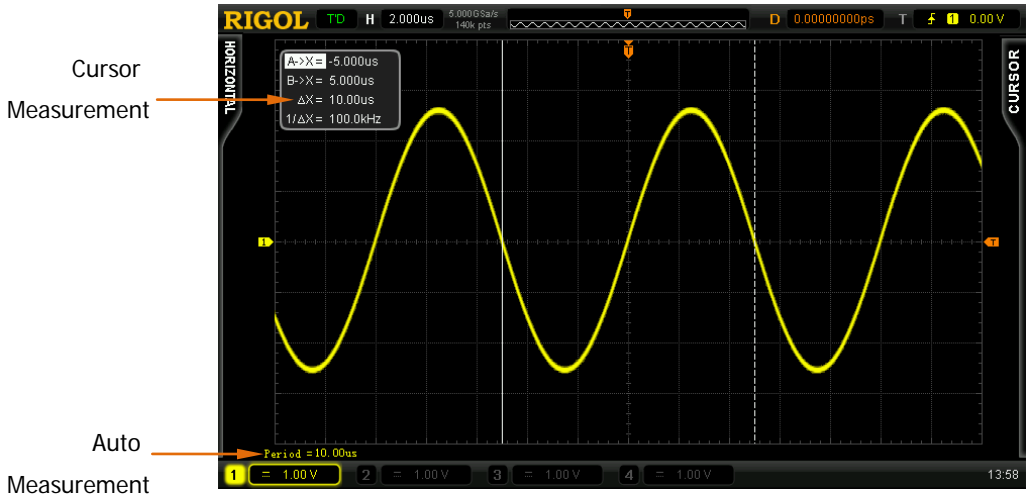

Track Mode

In this mode, when you adjust X cursor horizontally, Y cursor will automatically track the Y value of the waveform of the corresponding channel; when you adjust Y cursor vertically, X cursor will automatically track the X value of the waveform of the corresponding channel. The crossing points of X cursor and Y cursor are marked by an orange rectangle (Cursor A) and rhombus (Cursor B) respectively. When the cursors are moved horizontally or vertically, the marks will position themselves on the waveform automatically. When the waveform is expanded or compressed horizontally or vertically, the marks will track the points being marked in the last adjustment of the cursors.

Press **CURS** → **Mode** → "Track" to turn the track mode on or press **CURS** continuously to switch to "Track"; the measurement results will be displayed at the upper-left corner of the screen.

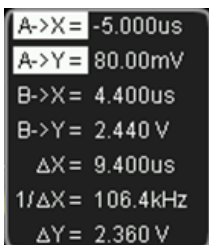

- The X value at cursor A (A->X): take the trigger position as reference and denote time or frequency (when measuring FFT waveform).
- The Y value at cursor A (A->Y): take the GND as reference and use the same unit with the unit of the current source.
- The X value at cursor B (B->X): take the trigger position as reference and denote time or frequency (when measuring FFT waveform).
- The Y value at cursor B (B->Y): take the GND as reference and use the same unit with the unit of the current source.
- The horizontal difference between cursor A and cursor B (ΔX).
- The reciprocal of the horizontal difference between cursor A and cursor B ($1/\Delta X$).
- The vertical difference between cursor A and cursor B (ΔY).

If needed, please refer to the following steps to modify track cursor measurement parameters.

1. Select Track Axes

Press **AXIS** to select "X" or "Y" to be the current track axis. The default axis is "Y".



- X: You can adjust the vertical position of Y cursor, and X cursor will automatically track the time or frequency of the wave of the corresponding measurement source at Y cursor. You can also press **Type** to select the track type of X cursor.
- Y: You can adjust the horizontal position of X cursor, and Y cursor will automatically track the vertical amplitude of the wave of the corresponding measurement source at X cursor.

2. Select Measurement Source

Press **Cursor A** to select the waveform in analog channels (CH1-CH4) or math operation results (MATH) as the measurement source of cursor A (only channels enabled are available). You can also select "None", namely do not use cursor A. Press **Cursor B** to select the waveform in analog channels (CH1-CH4) or math operation results (MATH) as the measurement source of cursor B (only channels enabled are available). You can also select "None", namely do not use cursor B.

3. Adjust Cursor Position (Note: On the same menu page, you can also press continuously to switch the current cursor.)



When **AXIS** is set to "X",

- Adjust cursor A: press **CursorA** and use  to adjust the vertical position of cursor A. During the adjustment, the measurement result will change accordingly. The adjustable range is limited within the screen.
- Adjust cursor B: press **CursorB** and use  to adjust the vertical position of cursor B. During the adjustment, the measurement result will change accordingly. The adjustable range is limited within the screen.
- Adjust cursor A and B at the same time: press **CursorAB** and use  to adjust the vertical positions of cursor A and B at the same time. During the adjustment, the measurement results will change accordingly. The adjustable range is limited within the screen.

Note: The cursor will track the marked point (namely moves left and right

with the transient moving of the waveform). Thus, the X value might change even though you do not adjust the cursor.

When **AXIS** is set to "Y",

- Adjust cursor A: press **CursorA** and use  to adjust the horizontal position of cursor A. During the adjustment, the measurement result will change accordingly. The adjustable range is limited within the screen.
- Adjust cursor B: press **CursorB** and use  to adjust the horizontal position of cursor B. During the adjustment, the measurement result will change accordingly. The adjustable range is limited within the screen.
- Adjust cursor A and B at the same time: press **CursorAB** and use  to adjust the horizontal positions of cursor A and B at the same time. During the adjustment, the measurement results will change accordingly. The adjustable range is limited within the screen.

Note: The cursor will track the marked point (namely jumps up and down with the transient moving of the waveform). Thus, the Y value might change even though you do not adjust the cursor.

4. Select Track Type

Press **Type** to select "Oldest" or "Latest" to be the track type of X cursor.

Note: The **Type** softkey is only available when **AXIS** is set to "X".

- Oldest: When you adjust the vertical position of Y cursor, if the waveforms of corresponding measurement channels have formed multiple crossing points along the cursor, then the X cursor will be automatically positioned from the crossing point at the most left side of the screen.
- Latest: When you adjust the vertical position of Y cursor, if the waveforms of corresponding measurement channels have formed multiple crossing points along the cursor, then the X cursor will be automatically positioned from the crossing point at the most right side of the screen.

5. Measurement Example (When **AXIS** is set to "Y")

Use cursor A and B to measure the waveforms in CH1 and CH2 respectively. You would discover that the cursors would track the marked points when the waveforms are expanded or compressed horizontally.

Cursor Track (Before Horizontal Expansion):

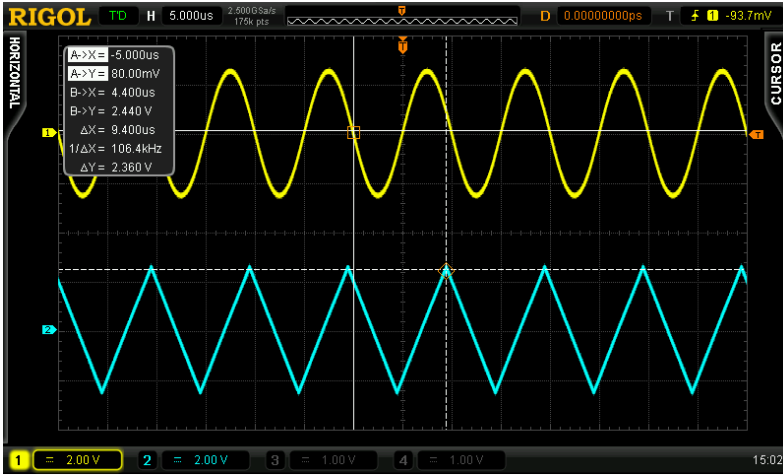

Cursor Track (After Horizontal Expansion):

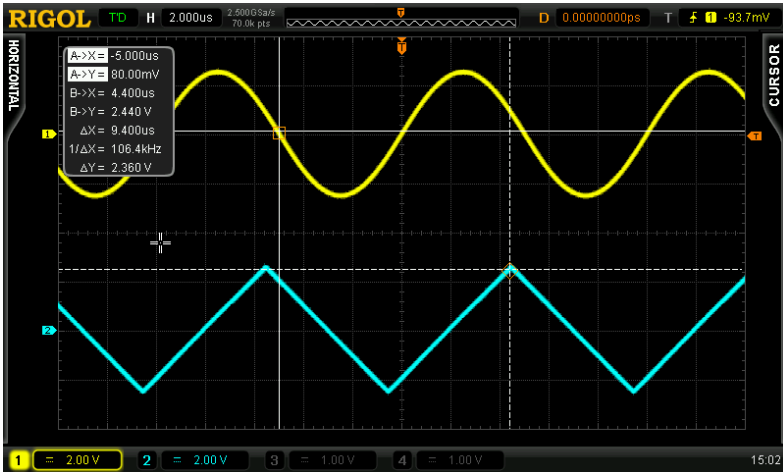

Auto Mode

In this mode, one or more cursors will appear. You can use auto cursor measurement to measure anyone of the 29 waveform parameters. Before using this mode, you need to at least turn on one auto measurement parameter and the number of cursors will change with the measurement parameters.

Press **CURS** → **Mode** → "Auto" or press **CURS** continuously to switch to "Auto". The number of cursors displayed on the screen is determined by **Meas.Para.** that you last selected. (Different measurement parameters need different number of cursors.) Note: No cursor will be displayed if no auto cursor measurement parameter is selected or there is no input of the measurement source. When the waveform is expanded or compressed horizontally, the cursor will change accordingly.

If multiple measurement parameters are turned on later, you can use **Meas.Para.** to switch among at most five measurement parameters that are turned on last and the measurement parameter currently selected is high-lighted at the bottom of the screen.

The following figure shows the example of auto measurement of the period of CH1 waveform.

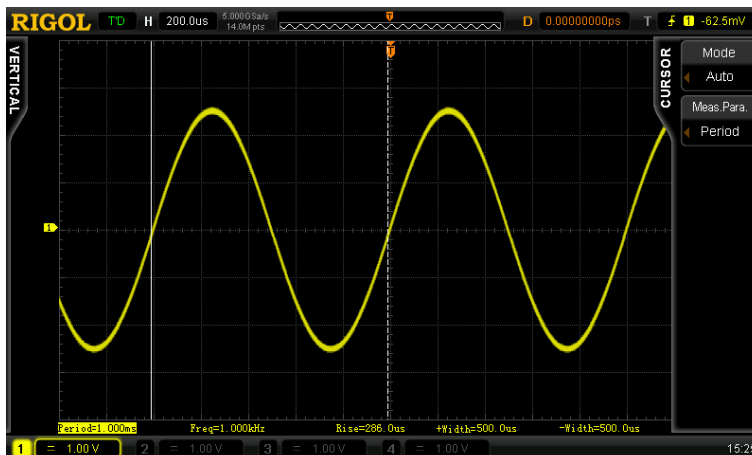

X-Y Mode

In this mode, the X cursor and Y cursor denote the amplitudes of the waveforms of the specified channels respectively. You can measure the waveform amplitude at the crossing point of the cursors by adjusting the cursor positions.

Note: You can only select X-Y cursor mode when the time base mode is set to "X-Y" (please refer to "**Time Base Mode**"); in addition, in "X-Y" time base mode, you can only use X-Y cursor mode.

In "X-Y" time base mode, press **CURS** → **Mode** → "X-Y" to turn the X-Y mode on or press **CURS** continuously to switch to "X-Y"; the measurement results will be displayed at the upper-left corner of the screen in the following mode.

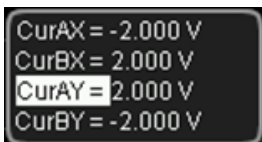

- The X value at cursor A (CurAX).
- The X value at cursor B (CurBX).
- The Y value at cursor A (CurAY).
- The Y value at cursor B (CurBY).

Note: In the measurement results, the amplitude unit is the same with the amplitude unit currently selected for the corresponding channel.

If necessary, please modify the X-Y cursor measurement parameters by referring to the following steps.

1. Specify the cursor region



Press **Region** to select "XY1" or "XY2".

- XY1: the X cursors and Y cursors are used to measure the amplitudes of the specified points (the crossing points of the cursors) of the waveforms of CH1 and CH2 respectively.
- XY2: the X cursors and Y cursors are used to measure the amplitudes of the



specified points (the crossing points of the cursors) of the waveforms of CH3 and CH4 respectively.

2. Adjust the positions of the X/Y cursors

When the cursor type is "X", you can adjust the positions of the X cursors.

- Adjust cursor A: press **CursorA** and use  to adjust the position of cursor A. During the adjustment, the measurement result will change accordingly. The adjustable range is limited within the screen.
- Adjust cursor B: press **CursorB** and use  to adjust the position of cursor B. During the adjustment, the measurement result will change accordingly. The adjustable range is limited within the screen.
- Adjust cursors A and B at the same time: press **CursorAB** and use  to adjust the positions of cursors A and B at the same time. During the adjustment, the measurement results will change accordingly. The adjustable ranges are limited within the screen.

When the cursor type is "Y", you can adjust the positions of the Y cursors.

- Adjust cursor A: press **CursorA** and use  to adjust the position of cursor A. During the adjustment, the measurement result will change accordingly. The adjustable range is limited within the screen.
- Adjust cursor B: press **CursorB** and use  to adjust the position of cursor B. During the adjustment, the measurement result will change accordingly. The adjustable range is limited within the screen.
- Adjust cursors A and B at the same time: press **CursorAB** and use  to adjust the positions of cursors A and B at the same time. During the adjustment, the measurement results will change accordingly. The adjustable ranges are limited within the screen.

7 Protocol Decoding

Protocol analysis can be used by users to discover errors, debug hardware and accelerate development, so as to guarantee quick and high-quality accomplishment of projects. Protocol decoding is the basis of protocol analysis. Only protocol analyses with correct protocol decoding are acceptable and only correct protocol decoding can provide more error information. DS6000 provides two buses to make common protocol decoding (including Parallel (standard), RS232 (option), SPI (option), I2C (option), CAN (option), and FlexRay (option)) of the analog channels (CH1-CH4). Because the decoding functions and setting method of the two buses are the same, this chapter only takes BUS1 for illustration.

To get the decoding option information, please refer to "**Appendix A: Accessories and Options**" on page 17-1.

When you have ordered the decoding option, please refer to "**Option Management**" on page 13-13 to activate the corresponding option.

The contents of this chapter:

- Parallel Decoding
- RS232 Decoding (Option)
- I2C Decoding (Option)
- SPI Decoding (Option)
- CAN Decoding (Option)
- FlexRay Decoding (Option)

Parallel Decoding

Parallel bus consists of clock line and data line. As shown in the figure below, CLK is the clock line, while Bit0 and Bit1 are the 0 bit and 1 bit on the data line respectively.

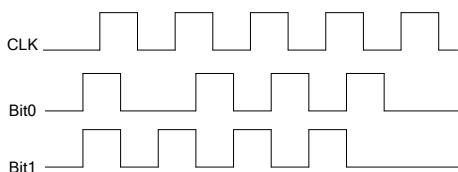



The oscilloscope will sample the channel data on the rising edge, falling edge or the rising&falling edges of the clock and judge whether each data point is logic "1" or logic "0" according to the preset threshold level.

Press **MATH** → **BUS1** → **Decode** to select "Parallel" and turn on the parallel decoding function menu.

1. Clock Line Setting (CLK)

Press **CLKChannel** to select any channel (CH1-CH4) as the clock channel. If "None" is selected, no clock channel is set.

Press **Slope** to select to sample the channel data on the rising edge () , falling edge () or rising&falling edges (). If clock channel is not selected, the instrument will sample when the channel data jumps in the decoding.

2. Data Line Setting

- **Set the bus bits**

Press **Bus Bits** to set the data width of the parallel bus namely the number of bits per frame. The default is 1 and the maximum is 4 bits (Bit0, Bit1, Bit2, Bit3).

- **Specify data channel for each bit.**

First, press **CurrentBit** to select the bit that need to specify channel. The default is 0 and the range available is always 1 smaller than the data width. For example, when the data width is 4, the range available is 0, 1, 2, 3.

Next, press **Channel** to specify a channel source for the bit currently selected in **CurrentBit**.

3. Analog Channel Threshold Setting

To judge logic "1" and logic "0" of the buses, you need to set a threshold for each analog channel (CH1, CH2, CH3 and CH4). When the signal amplitude is greater than the preset value, it is considered as "1", otherwise "0".

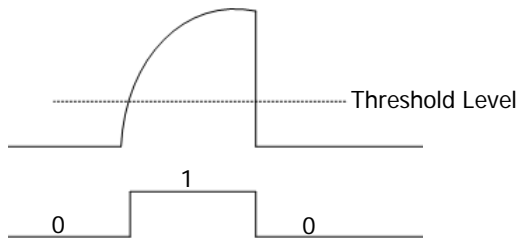

Press **Threshold** to turn the threshold setting menu on.

Channel	Select the channel that needs to set a threshold.
TTL	Press this softkey to set the threshold of the specified channel to TTL level immediately.
CMOS	Press this softkey to set the threshold of the specified channel to CMOS level immediately.
ECL	Press this softkey to set the threshold of the specified channel to ECL level immediately.
Threshold	Press this softkey and use  to set the threshold. The default is 0 V.

Note: When the threshold selected is beyond the specified range, it will be automatically limited within the range.

4. Display-related Setting

Press **Format** to select the display format of the bus as Hex, Decimal, Binary or ASCII.

Press **Offset** and use  to adjust the vertical display position of the bus.

Press **BusStatus** to turn the bus display on or off.

5. Decoding Table

The decoding table displays the decoded data and the corresponding line number and time in table format. It can be used to observe relatively longer decoded data to solve the problem that some data could not be seen clearly on the screen.

Press **Event Table** → **Event Table** to select "ON" (note that this operation is only available when **BusStatus** is set to "ON") to enter the decoding table interface as shown in the figure below. If a USB storage device is currently connected to the instrument, press **Export** to export the data table to the external USB storage device in CSV format.

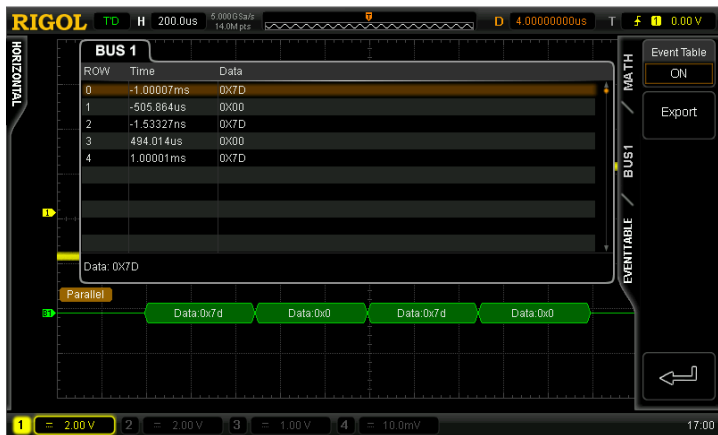

RS232 Decoding (Option)

RS232 serial bus consists of the transmitting data line (TX) and the receiving data line (RX).

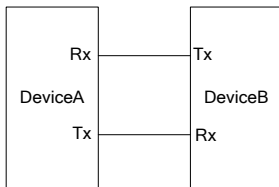

The industry standard of RS232 uses "Negative Logic", namely high level is logic "0" and low level is logic "1".

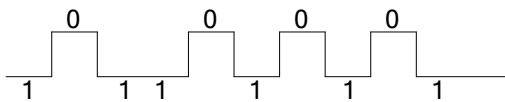

By default, RS232 uses LSB (Least Significant Bit) transmission sequence, namely the lowest bit of the data is transmitted first. While for MSB (Most Significant Bit), the highest bit of the data is transmitted first.

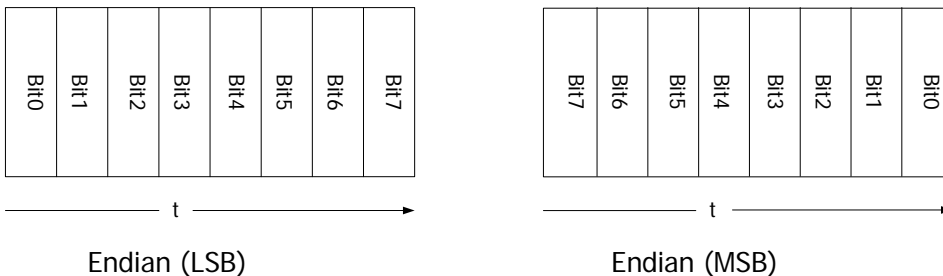

In RS232, baud rate is used to represent the transmitting rate (namely bits per second) of the data.

In RS232, you need to set the start bit, the data bits, the check bit (optional) and the stop bit of each frame of data.

Start Bit	Data Bits	Check Bit	Stop Bit
-----------	-----------	-----------	----------

Start Bit: represent when the data starts outputting. Setting the **Polarity** is equivalent to specifying the "Start Bit".

Data Bits: represent the number of data bits actually contained in each frame of data.

Check Bit: be used to check the correctness of the data transmission.

- Odd Checkout: the sum of the number of "1" in the data bit and check bit is an odd. For example, when 0x55 (01010101) is sent, a 1 needs to be filled in the check bit to make the number of 1 to be an odd.
- Even Checkout: the sum of the number of "1" in data bit and check bit is an even. For example, when 0x55 (01010101), a 0 should be filled in the check bit.
- None: if it is not set, there would not be check bit during the transmission.

Stop Bit: represent when the data stops outputting.

Press **MATH** → **BUS1** → **Decode** to select "RS232" to turn the RS232 decoding function menu on.

If the current trigger type of the trigger system is RS232, press **CopyTrig** to copy the current RS232 trigger configurations (include the source channel, polarity, stop bit, even-odd check mode, data bits, baud rate and etc.) to the RS232 decoding configurations. After that, you can still set the RS232 decoding parameters according to the introductions below.

Note: The copy function is only available when the current trigger type is "RS232"; otherwise, **CopyTrig** is not available.

1. TX and RX Channel Setting

Press **TX** to select any channel (CH1-CH4) as the transmitting channel and when "None" is selected, no transmitting channel is set. Use the same method to set the **RX** channel. What's more, you need to set the thresholds of the input channels of **TX** and **RX**. Switch the menu page and press **TX** and **RX**

respectively to input the desired threshold values.

Note: You cannot set both **TX** and **RX** channel to be "None".

2. Polarity Setting

Press **Polarity** to select "Normal" or "Invert" and the default is "Normal". The oscilloscope will sample data on the rising or falling edge of the corresponding channel according to this setting.

3. Endian Setting

Press **Endian** to select "LSB" or "MSB" and the default is "LSB".

4. Baud Rate Setting

Press **Baud** to select the desired baud rate and the default is 9600 bps.

5. Data Packet Setting

As mentioned before, in RS232 decoding, you need to set the start bit, the data bits, the check bit (optional) and the stop bit of each frame of data. "Start Bit" has been specified by the "Polarity Setting". The setting methods of other parameters are introduced below.

- Press **Data Bits** to set the data width of each frame of data. It can be set to 5, 6, 7, 8 or 9 and the default is 8.
- Press **Stop Bit** to set the stop bit after each frame of data. It can be set to 1 bit, 1.5 bits or 2 bits.
- Press **Even-Odd** to set the even-odd check mode of the data transmission. It can be set to None, Odd Checkout or Even Checkout.
- Press **Packet** to enable or disable the packet end of data transmission. When packet end is enabled, several data blocks are combined according to the packet end.
- Press **PacketEnd** to set the packet end during the data transmission and it can be set to 00 (NULL), 0A (LF), 0D (CR), 20 (SP) or FF.

6. Display-related Setting

Press **Format** to select the display format of the bus: Hex, Decimal, Binary or ASCII.

Press **Offset** and use  to adjust the vertical display position of the bus.

Press **BusStatus** to turn the bus display on or off.

7. Decoding Table

The decoding table displays the decoded data, the corresponding line number, time and error information on TX and/or RX data lines in table format. It can be used to observe relatively longer decoded data to solve the problem that some data could not be seen clearly on the screen. Note: When the TX or RX channel is set to "None", the information of this data line will not be displayed in the decoding table.

Press **Event Table** → **Event Table** to select "ON" (note that this operation is only available when **BusStatus** is set to "ON") to enter the decoding table interface as shown in the figure below. If error occurs during the decoding, the corresponding error information is displayed. If a USB storage device is currently connected to the instrument, press **Export** to export the data table to the external USB storage device in CSV format.

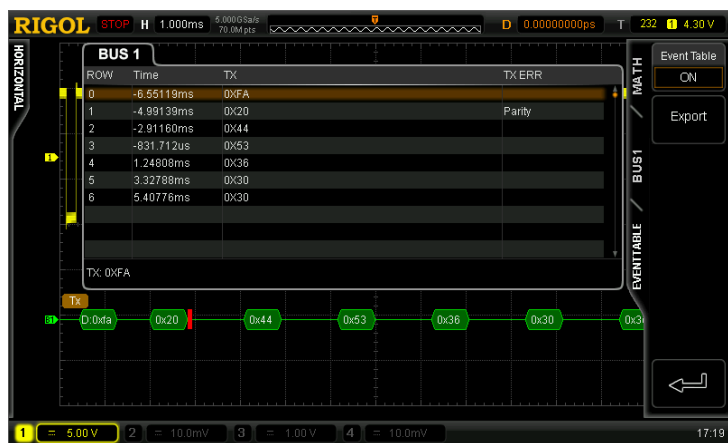

8. The Error Expression During Decoding

DS6000 makes full use of the resources such as color and view to express the results of the protocol decoding effectively and let users find the desired information quickly. When decoding error occurs, red error mark (Note: The display form of the red error mark is related to the horizontal time base. When the time base is relatively smaller, [red error mark] is displayed; otherwise, [red error mark] is displayed) is displayed.

End Frame Error:

It refers to the error generated when the end frame condition is not met. When the stop bit is set to 1.5, red error mark will be displayed if the stop bit is less

than 1.5 bit.

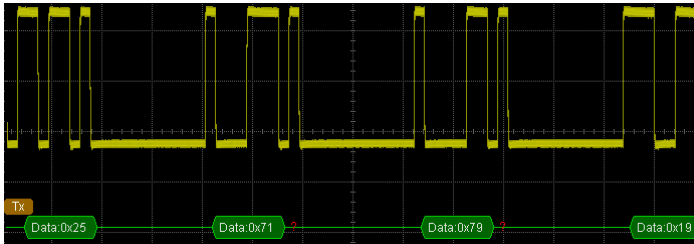

Check Error:

When a check bit error is detected during the decoding, a red error mark will be displayed. For example, when the transmitting terminal is set to none check and the decoder is set to odd check, the following check error occurs.

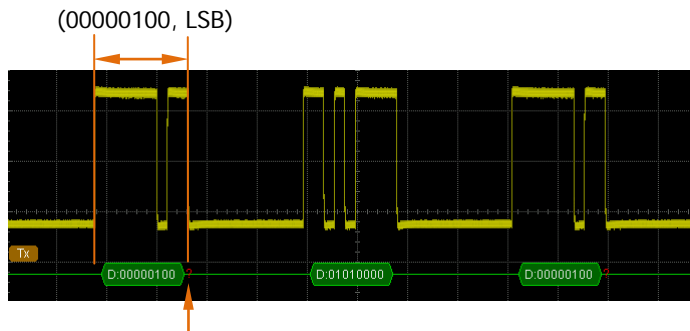

The check bit detected is 1

Wherein, there are odd number of 1 in the 8 bit data 00000100 and the check bit should be 0. However, check error is generated as the check bit on TX is 1.

After the decoder is set to none check, the decoding becomes normal.

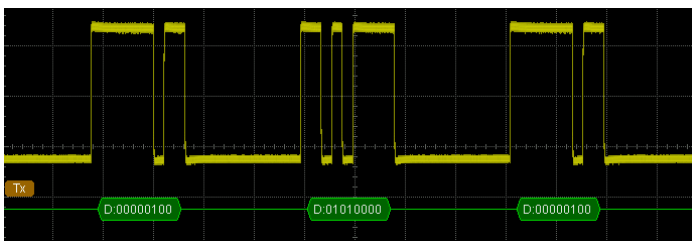

Note: Two error marks will be displayed when end frame error and check error are detected at the same time.

I2C Decoding (Option)

I2C serial bus consists of the clock line (SCLK) and the data line (SDA).

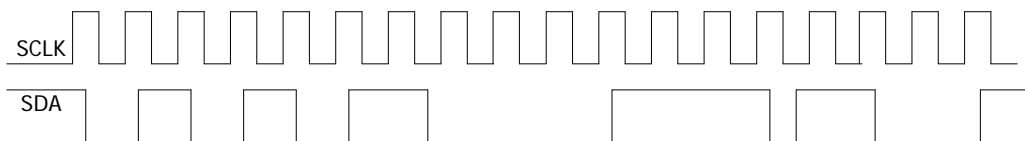
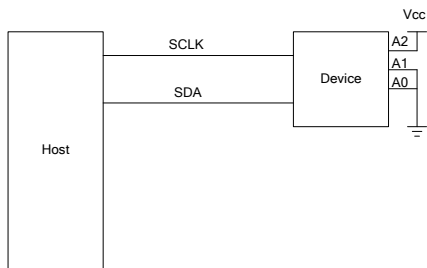

SCLK: sample the SDA on the clock rising edge or falling edge.

SDA: denote the data channel.

Press **MATH** → **BUS1** → **Decode** to select "I2C" and turn the I2C decoding function menu on.

If the current trigger type of the trigger system is I2C, press **CopyTrig** to copy the current I2C trigger configurations (include the clock signal (SCL) and data signal (SDA)) to the I2C decoding configurations. After that, you can still set the I2C decoding parameters according to the introductions below.

Note: The copy function is only available when the current trigger type is "I2C"; otherwise, **CopyTrig** is not available.

1. SCLK Setting

Press **SCLK** to select any channel (CH1-CH4) as the clock channel.

Press **SCLK** to set the threshold of the clock channel.

2. SDA Setting

Press **SDA** to select any channel (CH1-CH4) as the data channel.

Press **SDA** to set the threshold of the data channel.

3. Display-related Setting

Press **Format** to select the display format of the bus as Hex, Decimal, Binary or ASCII.

Press **Offset** and use  to adjust the vertical display position of the bus.

Press **BusStatus** to turn the bus display on or off.

4. Decoding Table

The decoding table displays the decoded data, the corresponding line number, time, data direction, ID and ACK information in table format.

Press **Event Table** → **Event Table** to select "ON" (note that this operation is only available when **BusStatus** is set to "ON") to enter the decoding table interface as shown in the figure below. If a USB storage device is currently connected to the instrument, press **Export** to export the data table to the external USB storage device in CSV format.

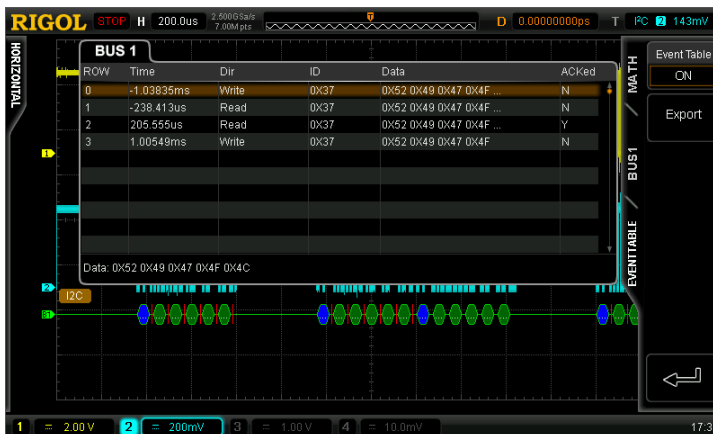

5. Error Expressions during Decoding

In I2C bus, the front part of each frame of data contains the address information and blue patches are used to represent address ID. In the ID, "Write" is used to represent writing address and "Read" is used to represent reading address.

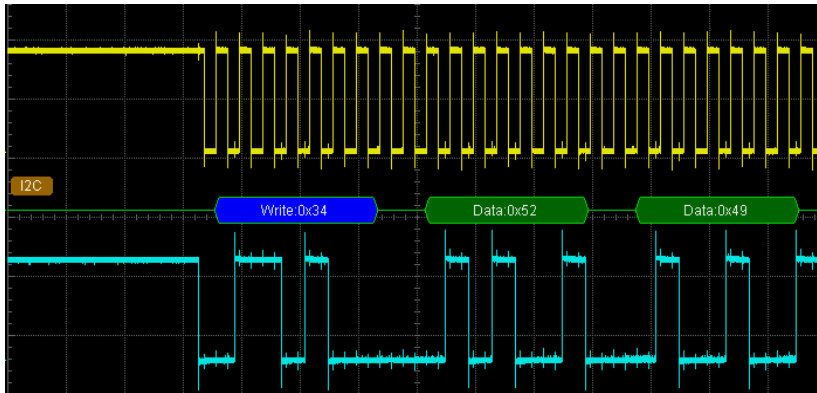

When the ACK (ACKnowledge Character) is not met, the red error marks as shown in the figure below will be displayed.

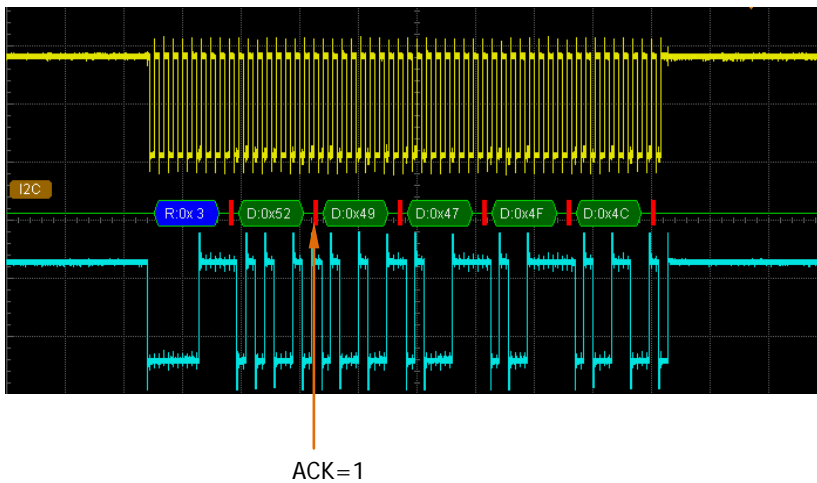

SPI Decoding (Option)

SPI serial bus consists of chip select line (SS), clock line (SCLK), MISO and MOSI.

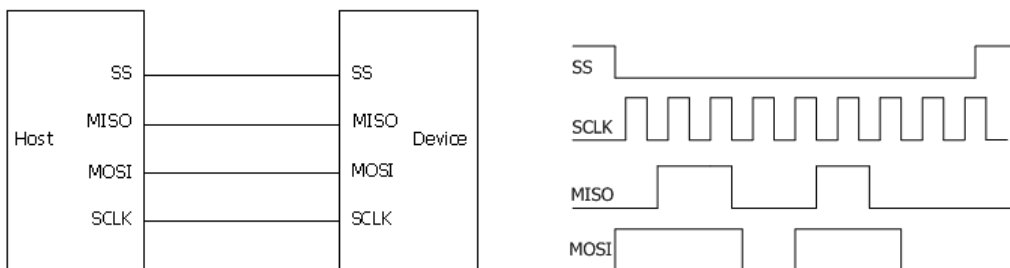

SS: set the polarity to "Low" or "High". When SS selection is valid, the SPI bus samples data from MISO and MOSI at the jumping point of SCLK.

SCLK: sample data from MISO and MOSI on the clock rising edge or falling edge.

MISO: master input/slave output. Set the polarity to "Low" or "High".

MOSI: master output/slave input. Set the polarity to "Low" or "High".



Press **MATH** → **BUS1** → **Decode** to select "SPI" and turn the SPI decoding function menu on.

If the current trigger type of the trigger system is SPI, press **CopyTrig** to copy the current SPI trigger configurations (include the CS/timeout mode, clock channel, data channel, data bits and etc.) to the SPI decoding configurations. After that, you can still set the SPI decoding parameters according to the introductions below.



Note: The copy function is only available when the current trigger type is "SPI"; otherwise, **CopyTrig** is not available.

1. Decoding Mode Setting

Press **Mode** to select the "TimeOut" or "CS" decoding mode.



- When "TimeOut" is selected, press **TimeOut**; use  or the inner knob of the navigation knob  to adjust the timeout time with a small step value or rotate the outer knob of the navigation knob  to quickly adjust the timeout time within a relatively larger range. (The greater the rotation amplitude of the outer knob, the faster the variations in the values.) The

adjustable range of the timeout time is from 100 ns to 1 s. The default is 1 μ s.

- When "CS" is selected, press **SS** to enter the SS (chip select line) setting interface.
 - Press **Channel** and select any channel of CH1 to CH4 as the CS channel.
 - Press **Polarity** to set the polarity of the chip select channel to high () or low () .
 - Press **Threshold** to set the threshold of the chip select channel.



2. SCLK Setting

Press **SCLK** to turn on the clock line setting interface.

- Press **Channel** to select any channel (CH1-CH4) as the clock channel.
- Press **Slope** to set the oscilloscope to sample MISO and MOSI on the rising edge () or falling edge () of SCLK.
- Press **Threshold** to set the threshold of the clock channel.



3. MISO Setting

Press **MISO** to turn on the MISO data line setting interface.

- Press **Channel** to select any channel (CH1 to CH4) as the MISO channel. When "None" is selected, this data line will not be set. Note: When the MOSI data line is set to "None", the MISO data channel cannot be set to "None".
- Press **Polarity** to set the polarity of the MISO data line to high () or low () .
- Press **Threshold** to set the threshold of the MISO data line.

4. MOSI Setting

Press **MOSI** to turn on the MOSI data line setting interface.

- Press **Channel** to select any channel (CH1-CH4) as the MOSI channel. When "None" is selected, this data line will not be set. Note: When the MISO data line is set to "None", the MOSI data channel cannot be set to "None".
- Press **Polarity** to set the polarity of the MOSI data line to high () or low () .
- Press **Threshold** to set the threshold of the MOSI data line.

5. Data Bits Setting

Press **Data Bits** to set the number of bits of each frame of data. The range available is from 4 to 32.

6. Endian Setting

Press **Endian** to select "LSB" or "MSB" and the default is "MSB".

7. Display-related Setting

Press **Format** to select the display format of the bus as Hex, Decimal, Binary or ASCII.

Press **Offset** and use ↺ to adjust the vertical display position of the bus.

Press **BusStatus** to turn the bus display on or off.

8. Decoding Table

The decoding table displays the decoded data, the corresponding line number, time and error information on the MOSI and/or MISO data line in table format. It can be used to observe relatively longer decoded data to solve the problem that some data could not be seen clearly on the screen. Note: When the MISO or MOSI channel is set to "None", the information of the corresponding data line will not be displayed in the decoding table.

Press **Event Table** → **Event Table** to select "ON" (note that this operation is only available when **BusStatus** is set to "ON") to enter the decoding table interface as shown in the figure below. If a USB storage device is currently connected to the instrument, press **Export** to export the data table to the external USB storage device in CSV format.

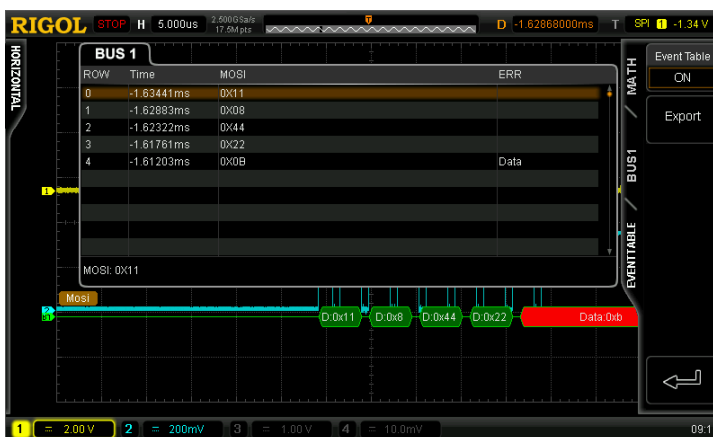

9. Error Expressions During Decoding

When the clock for a frame in SPI is not enough, the data is filled with red patches. For example, when Data Bits is set to 7 and SCLK slope is set to rising edge, decoding error will be generated.

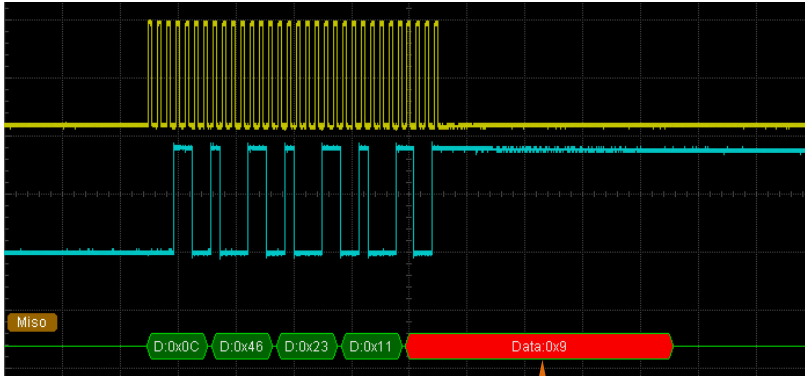

Not enough for 7 bits

CAN Decoding (Option)

For the data frame format of the CAN bus, please refer to "**CAN Trigger**". The oscilloscope samples the CAN signal at the specified sample position. For CAN decoding, you need to specify the CAN signal type and the sample position.

Press **MATH** → **BUS1** → **Decode** and select "CAN" to open the CAN decoding function menu.

If the current trigger type of the trigger system is CAN, press **CopyTrig** to copy the current CAN trigger configurations (including the source channel, signal type, signal rate, and sample point) to the CAN decoding configurations. After that, you can still set the CAN decoding parameters according to the introductions below.

Note: The copy function is only available when the current trigger type is "CAN"; otherwise, **CopyTrig** is not available.

1. Source



Press **Source** and select any channel (CH1-CH4) as the source channel.

2. Signal Type

Press **Signal Type** to select the desired signal type.

- **Rx**: the receiving signal from the CAN signal line.
- **Tx**: the transmitting signal from the CAN signal line.
- **CAN_H**: the actual CAN_H bus signal.
- **CAN_L**: the actual CAN_L bus signal.
- **Differential**: the CAN differential bus signals connected to an analog channel using a differential probe. Connect the probe's positive lead to CAN_H and connect the negative lead to CAN_L.

3. Baud

Press **Baud** to select a baud rate (100 kb/s, 125 kb/s, 250 kb/s, 400 kb/s, 500 kb/s, 800 kb/s, 1 Mb/s or User) that matches your CAN bus signal. When "User" is selected, press **Setup**; use  or the inner knob of the navigation knob  to adjust the signal rate with a small step value or rotate the outer knob of the navigation knob  to quickly adjust the signal rate within a relatively larger

range. (The greater the rotation amplitude of the outer knob, the faster the variations in the values.) The range is from 10 kb/s to 1 Mb/s.

4. Sample Point

The sample point is the point within the bit time. The oscilloscope samples the bit level at this point. The sample point position is represented by the percentage that the "time from the start of bit to the sample point" takes up in the "bit time".

Press **Sample Point** and use  to adjust this parameter with a step of 1%. The range is from 5% to 95%.

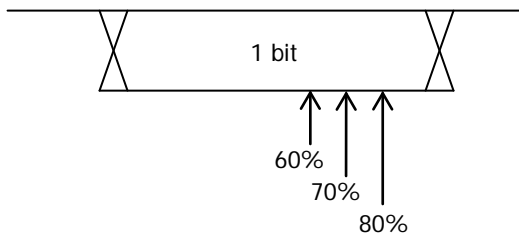

5. Threshold

Refer to the introduction in "**Parallel Decoding**".

6. Display-related Setting

Press **Format** and set the bus display format to Hex, Decimal, Binary or ASCII.

Press **Offset** and use  to adjust the vertical display position of the bus.

Press **BusStatus** to enable or disable bus display.

7. Decoding Table

The decoding table displays the decoded data, the corresponding line number, time, frame ID, DLC, CRC and ACK information in table format.

Press **Event Table** → **Event Table** to select "ON" (note that this operation is only available when **BusStatus** is set to "ON") to enter the decoding table interface as shown in the figure below. If a USB storage device is currently connected to the instrument, press **Export** to export the data table to the external USB storage device in CSV format.

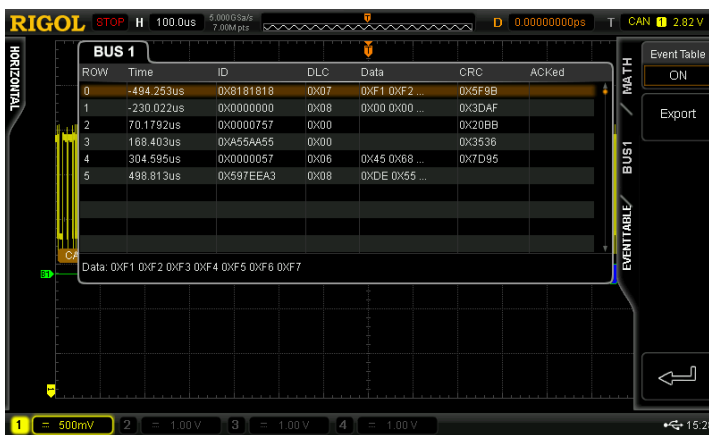

8. Interpreting Decoded CAN Data

- Data Frame ID: hexadecimal number and is expressed by blue patch.
- Data Length Code (DLC): hexadecimal number and is expressed by chartreuse patch.
- Data: displayed in the format specified in **Format** (can be hex, decimal, binary or ASCII). It is expressed by green patch. It is expressed by red patch if the data frame is lost.
- Cyclic Redundancy Check (CRC): hexadecimal number. When it is valid, it is expressed by blue-green patch; when error occurs, it is expressed by red patch.
- Acknowledgement (ACK): when it is valid, it is expressed by green patch; when error occurs (the detected ACK is 1), it is expressed by red patch.

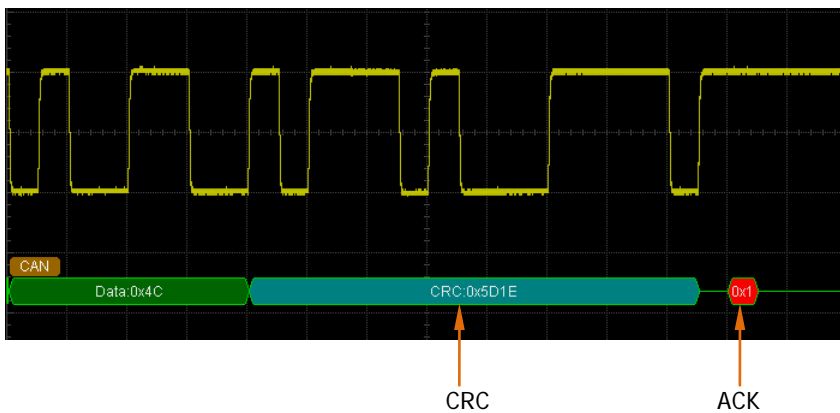
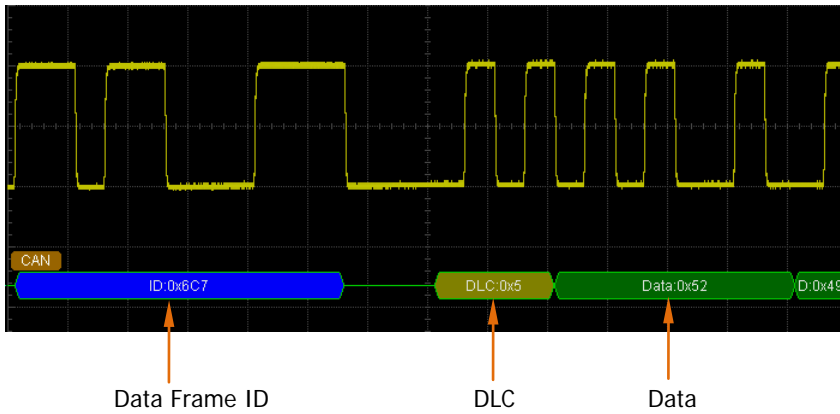

FlexRay Decoding (Option)

For the frame format of the FlexRay bus protocol, please refer to "**FlexRay Trigger**". The oscilloscope samples the FlexRay signal at the specified sample position. For FlexRay decoding, you need to specify the signal type and signal rate.

Press **MATH** → **BUS1** → **Decode** and select "FlexRay" to open the FlexRay decoding function menu.

If the current trigger type of the trigger system is FlexRay, press **CopyTrig** to copy the current FlexRay trigger configurations (include the source channel and signal rate) to the FlexRay decoding configurations. After that, you can still set the FlexRay decoding parameters according to the introductions below.

Note: The copy function is only available when the current trigger type is "FlexRay"; otherwise, **CopyTrig** is not available.

1. Source

Press **Source** to select any channel (CH1 to CH4) as the signal source channel.

2. Signal Path

Press **Signal Path** to select the signal path (A or B) that matches the FlexRay bus signal.

3. Signal Type

Press **Signal Type** to select the type of signal that matches the FlexRay bus. The signal types available include BP, BM and RX/TX.

4. Baud

Press **Baud** to set the signal rate (2.5 Mb/s, 5Mb/s or 10 Mb/s) that matches the FlexRay bus signal.

5. Sample Point

The sample point is the point within the bit time. The oscilloscope samples the bit level at this point. The sample point position is expressed by the percentage of the "time from the start of bit to the sample bit" takes up in "bit time".

Press **Sample Point** and use ↻ to adjust this parameter with a step of 1% and the range is from 5% to 95%.

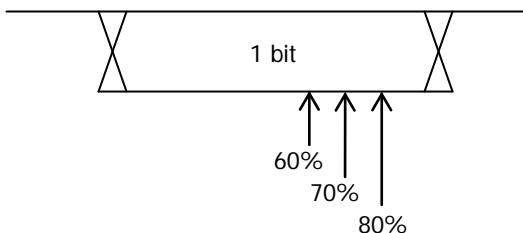

6. Threshold

Refer to the introduction in "**Parallel Decoding**".

7. Display-related Setting

Press **Format** to set the display format of the bus to Hex, Decimal, Binary or ASCII.

Press **Offset** and use ↻ to adjust the vertical display position of the bus.

Press **BusStatus** to enable or disable bus display.

8. Decoding Table

The decoding table lists the decoded data, the corresponding line number, time, error information, and other information in table format. It can be used to observe relatively longer decoded data to solve the problem that some data could not be seen clearly on the screen.

Press **Event Table** → **Event Table** to select "ON" (note that this operation is only available when **BusStatus** is set to "ON") to enter the decoding table interface as shown in the figure below. If a USB storage device is currently connected to the instrument, press **Export** to export the data table to the external USB storage device in CSV format.

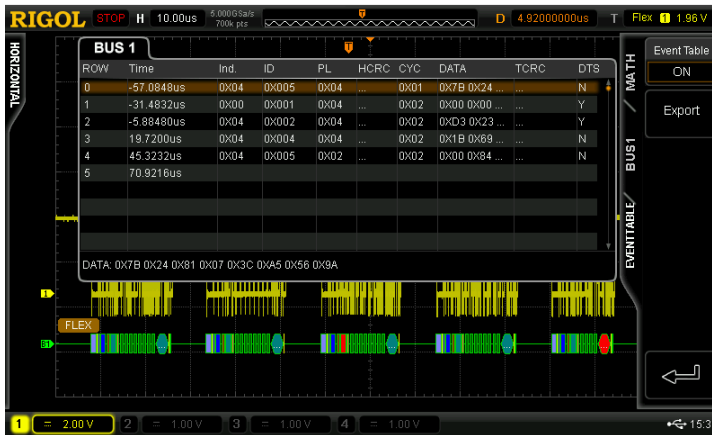

9. Explanation of the Decoded FlexRay Frame Data

- TSS: transmission start sequence and is expressed by light purple patch.
- Frame Type: the FlexRay frame type can be NORMAL, SYNC, SUP or NULL. It is expressed by purple patch.
- Frame ID: hexadecimal number and is expressed by blue patch.
- Effective Loading Length: hexadecimal number and is expressed by brown patch.
- Header CRC: hexadecimal number and is expressed by blue-green patch. When CRC is invalid, it is expressed by red patch.
- Number of Cycles: hexadecimal number and is expressed by pink patch.

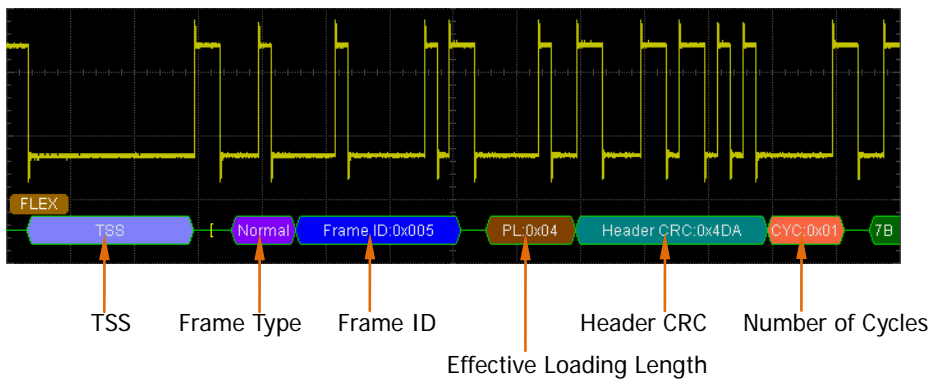

- Data: displayed in the format (Hex, Decimal, Binary or ASCII) specified in **Format** and expressed by green patch.
- Tail CRC: hexadecimal number and is expressed by blue-green patch. When CRC is invalid, it is expressed by red patch.
- DTS: dynamic end sequence and is expressed by purple patch.

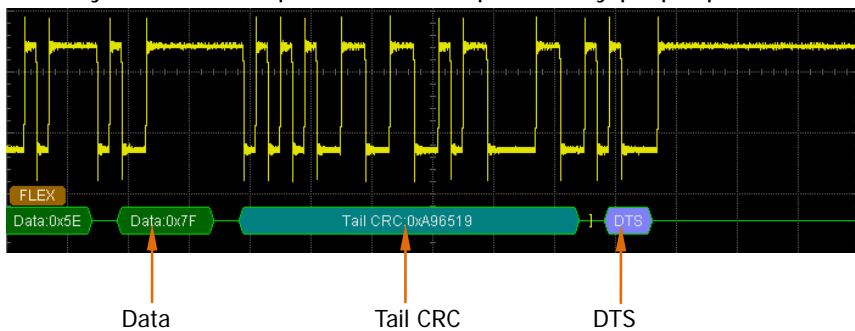

8 Reference Waveform

In actual testing process, the waveform can be compared with the reference waveform to judge the reasons for the failures.



The contents of the chapter:

- To Enable REF Function
- To Set the Color
- To Select REF Source
- To Save to Internal Memory
- To Adjust REF Waveform Display
- To Export to Internal or External Memory
- To Import from Internal or External Memory

To Enable REF Function

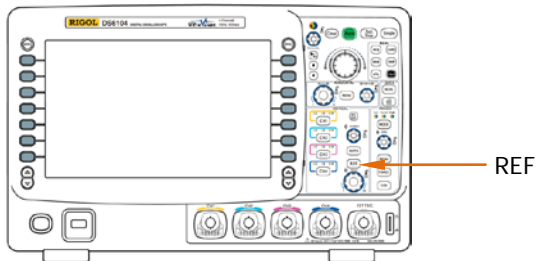
Press **REF** in the vertical control area (VERTICAL) on the front panel to enable REF function. Note that when the time base is in X-Y mode, REF function cannot be enabled.



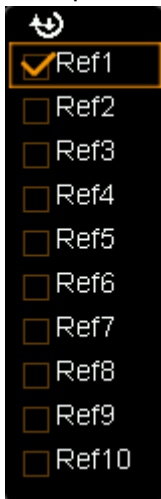

DS6000 provides 10 reference waveform channels. Press **Channel** and use  to select to turn the desired reference channel on or off and a channel icon of the channel that is turned on will be display at the left side of the screen grid. For example, .



When REF function is enabled, you can select different color for each reference waveform, set the source of each reference channel, adjust the vertical scale and position of the reference waveform and save the reference waveform to internal or external memory as well as recall it when needed. For details, please refer to the introduction below.

To Set the Color

DS6000 series oscilloscope provides five colors (gray, green, light blue, magenta and orange) to mark the reference waveforms of different channels in order to distinguish them.

Press **Current** and use  to select any of the reference channel (Ref1-Ref10) enabled. Then, press **Color** to specify a different color for the reference waveform of that channel. The corresponding icon at the left of the channel currently selected will be filled with the specified color, for example, .

To Select REF Source





Press **Current** and use  to select any reference channel (Ref1-Ref10) that has been turned on and then press **Source** to specify a reference source (CH1-CH4 or MATH) for this channel. Note: Only channels currently enabled can be selected.

To Save to Internal Memory

Press **Save** to save the waveform (screen region) in the specified source to internal memory as reference waveform and display it on the screen. Note that this operation only saves the reference waveform to the volatile memory and it will be lost after power-off.

To Adjust REF Waveform Display

To adjust the reference waveform in specified **Current**:

Press **REF** to set the oscilloscope to REF function state. Then, press  and use  to adjust the vertical position of the reference waveform and press  and use  to adjust the vertical scale of the reference waveform.

Press **Reset** and the reference waveform returns to the position where the source channel waveform is located when **Save** is pressed down.

To Export to Internal or External Memory

Users can also save the reference waveform to the Flash memory inside the instrument or to the external USB storage device. The file format of the reference waveform is "*.ref". At most 10 reference files (LocalREF0.ref to LocalREF9.ref) can be saved inside the instrument.

Press **Export** to enter file storage interface. Please refer to the relative descriptions in "**Store and Recall**" to save the reference waveform to internal or external memory.

To Import from Internal or External Memory

Users can also import the stored reference waveform in the Flash memory inside the instrument or in the external USB storage device to the internal memory.

Press **Import** to enter file recalling interface. Please refer to the relative descriptions in "**Store and Recall**" to import the reference waveform to the internal memory of the instrument.

9 Pass/Fail Test

Monitor the change of the signal by judging whether the input signal is within the mask created. The test result can be displayed on the screen as well as be prompted by the system sound or the pulse signal output from the **[Trig Out/Calibration]** connector on the rear panel.

The contents of this chapter:

- To Enable Pass/Fail Test Function
- To Select Source
- Mask Range
- Test and Output
- To Save the Test Mask
- To Load the Test Mask

To Enable Pass/Fail Test Function

Press **UTIL** → **Pass/Fail** → **Enable** to select "ON".

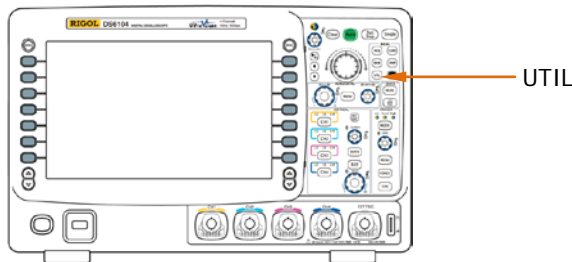

Note: The pass/fail test function cannot be enabled when the oscilloscope is in any of the following states.

- In X-Y time base mode.
- In ROLL time base mode.
- In Y-T time base mode and the horizontal time base is set to 200 ms/div or slower (the instrument enters the "Slow Sweep" mode).
- The waveform recording function is enabled.

To start testing, press **Enable** and select "ON". Then, press **Operate**. Select "▶" to start testing and select "■" to stop testing. The figure below is the test interface.

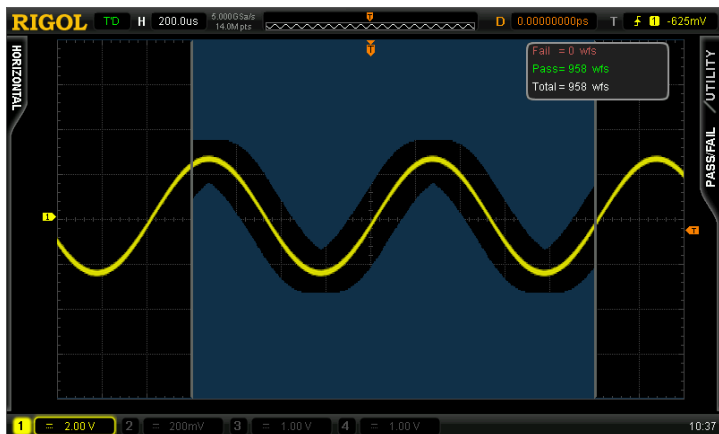



You can select the signal source, set the test mask range, create mask as well as save and load the test mask. For details, please refer to the following introduction.

To Select Source

Press **Source** to select the channel (channel enabled from CH1 to CH4) to be tested. During the test, the oscilloscope will judge whether each frame of the waveform in the source complies with the current test mask and those waveforms that are beyond the test mask area (namely the waveforms enter the blue area) are considered as failed waveforms.

Mask Range

Users can define their desired test masks.

Press **Range** → **Range** to select "Screen" or "Cursor" for test. When "Cursor" is selected, two gray cursor lines appear on the screen. At this point, press **Cursor A** and **Cursor B**; then, use  to adjust the positions of the two cursor lines respectively to determine the test range. Or, press **CursorAB** and use  to adjust the positions of cursor A and cursor B at the same time. Note that you can press down  continuously to switch the current cursor.

Press **X Mask** and **Y Mask** respectively and turn , the mask lines appear on the screen. Press **Create** to apply the mask currently created. The ranges of the horizontal and vertical adjustments are from 0.02 div to 4 div and 0.03 div to 4 div respectively.

Test and Output

Before the test, you can use the following method to set the output mode of the test results.

Press **Message** to select "ON" or "OFF". When "ON" is selected, the test results will be displayed at the upper-right corner of the screen.

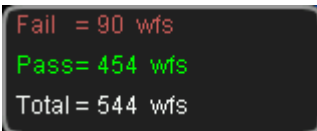

```
Fail = 90 wfs
Pass = 454 wfs
Total = 544 wfs
```

Press **StopOnFail** to select "ON" or "OFF".

- ON: when failed waveforms are detected, the oscilloscope will stop the test and enter the "STOP" state. At this point, the results of the test remain the same with the display on the screen (if display is turned on) and the **[Trig Out/Calibration]** (if enabled) connector on the rear panel only outputs one pulse.
- OFF: the oscilloscope will continue with the test even though failed waveforms are detected. The test results on the screen will update continuously (if the display is turned on) and the **[Trig Out/Calibration]** connector (if it is enabled) on the rear panel will output a pulse each time a failed waveform is detected.

Press **Output** to select "Fail" or "Fail+".

- Fail: when failed waveforms are detected, there are display and output but the beeper does not sound.
- Fail+: when failed waveforms are detected, there are display and output and the beeper sounds (not related to the on/off state of the sound).

Press **AuxOutput** to quickly turn "ON" or "OFF" the test result output of the **[Trig Out/Calibration]** connector on the rear panel. You can also press **UTIL** → **AuxOutput** and select "PassFail" to set this output.

To Save the Test Mask

Users can save the current test mask to the Flash memory inside the instrument or external USB storage device. The file format of the test mask file is "*.pf". The internal memory can store at most 10 test mask files (LocalPF0.pf to LocalPF9.pf).

Press **Save** to enter file saving interface. Please refer to the relative description in "**Store and Recall**" to save the test mask file to the internal or external memory.

To Load the Test Mask

Users can also load the test mask files (*.pf) stored in the Flash memory inside the instrument or the external USB storage device to the internal memory.

Press **Load** to enter the file loading interface. Please refer to the relative description in "**Store and Recall**" to load the test masks to the internal memory of the instrument.

10 Waveform Recording

Waveform recording can record the waveforms in the input channels (CH1-CH4). Waveform playback and waveform analysis can provide better waveform analysis effect.

The contents of this chapter:

- Waveform Recording
- Record Constant On
- Waveform Playback
- Waveform Analysis

Waveform Recording

Waveforms from all the channels currently turned on will be recorded during waveform recording.

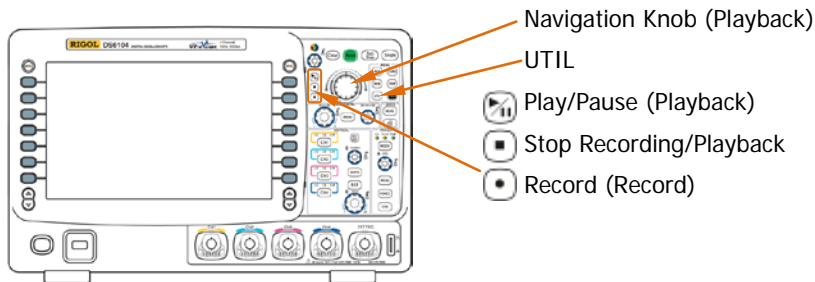

Press **UTIL** → **Record** → **Mode** and use to select "Record" to turn the waveform recording operation menu on.

1. End Frame



Press **End Frame**; use or the inner knob of the navigation knob to adjust the number of frames to be recorded at the specified step (1) or rotate the outer knob of the navigation knob to quickly adjust the number of frames to be recorded within a relatively larger range. (The greater the rotation amplitude of the outer knob, the faster the variations in the values.) The number of frames available is related to the memory depth currently selected.

2. Recording Operation

Waveform recoding can be realized via the shortcut buttons in the menu or on the front panel.

Menu	Front Panel
Press Operate and select "●" to start recoding.	Press , the backlight goes on (in red) and starts to flash, which indicates that the recording is started.
When the recording is finished, "●" changes to "■" automatically. You can also select "■" manually to stop the recording.	When the recoding is finished, the backlight of goes off automatically and the backlight of goes on (in orange). You can also press directly to stop the recording.

3. Interval

The time interval refers to the time interval between the frames in waveform recording. Press **Interval**; use  or the inner knob of the navigation knob  to adjust the time interval with a small step value or rotate the outer knob of the navigation knob  to quickly adjust the time interval within a relatively larger range. (The greater the rotation amplitude of the outer knob, the faster the variations in the values.) The range available is from 100 ns to 10 s.

4. Total Frames

The menu shows the maximum number of frames that can be recorded currently.

As the capacity of the waveform memory is fixed, the more the number of points of each frame of waveform has, the less the number of waveform frames can be recorded. Thus, the maximum end frame of waveform recording is decided by the "Memory Depth". Please refer to the instruction in "**Memory Depth**" to select the desired memory depth.



Table 10-1 Memory Depth and Maximum Number of Frames Recorded

Memory Depth	Maximum End Frame
14 k points (when a single channel is turned on ^[1]) 7 k points (when dual channels are turned on ^[1])	31986
140 k points (when a single channel is turned on) 70 k points (when dual channels are turned on)	1999
1.4 M points (when a single channel is turned on) 700 k points (when dual channels are turned on)	249
14 M points (when a single channel is turned on) 7 M points (when dual channels are turned on)	31
140 M points (when a single channel is turned on) 70 M points (when dual channels are turned on)	2
Auto	Related to the current "Horizontal Time Base"

Note^[1]: Turning on a single channel means turning on CH1 or CH2, CH3 or CH4; turning on dual channels means turning on CH1 and CH2, CH3 and CH4.

Record Constant On

In the "Open" mode, the oscilloscope records the waveforms of all the channels currently turned on in real-time until users press **RUN/STOP**. The maximum number of frames can be recorded is limited by the memory depth. When the number of frames recorded reaches the maximum number of frames can be recorded, the oscilloscope will continue to record the waveform in real-time and the waveform data recorded formerly will be overwritten by the waveform data recorded latterly.

Press **UTIL** → **Record** → **Mode** and use  to select "Open". The backlight of the waveform recording key  on the front panel turns on (in red) and flashes. The oscilloscope records the waveform in real-time according to the current memory depth until users press **RUN/STOP**. After the oscilloscope stops recording the waveform, you can play back or analyze the recorded waveform.

Note: In this mode, the "**Acquisition Mode**", "**Sample Mode**", "**Memory Depth**", "**Pass/Fail Test**", "**Protocol Decoding**" and "**Time Base Mode**" functions are disabled; other function are not affected.

Waveform Playback

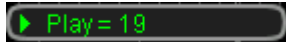

Waveform playback can play back the waveforms currently recorded. Press **UTIL** → **Record** → **Mode** and use  to select "Play back". At this point, the information as shown in the figure below is displayed at the upper-right corner of the screen, indicating the specific frame currently displayed on the screen. During the playback, this value would change continuously.





Please refer to the following descriptions to set the playback parameters.

1. Play Mode

Press this softkey to set the playback mode to cycle or single.

- : cycle playback. Play from the start frame to the end frame and then repeat until you stop it manually.
- : single playback. Play from the start frame to the end frame and then stop.



2. Interval

Press this softkey; use  or the inner knob of the navigation knob  to adjust the time interval of the playback with a small step value or rotate the outer knob of the navigation knob  to quickly adjust the time interval of the playback within a relatively larger range. (The greater the rotation amplitude of the outer knob, the faster the variations in the values.) The range available is from 100 ns to 10 s and the default is 100 ns.

3. Start Frame

Press this softkey and use  to set the start frame of the playback. The default is 1 and the maximum is the maximum number of frames recorded.

4. Current Frame

Press this softkey; use  or the inner knob of the navigation knob  to adjust the current frame at the specified step (1) or rotate the outer knob of the navigation knob  to quickly adjust the current frame within a relatively larger range. (The greater the rotation amplitude of the outer knob, the faster the variations in the values.) By default, the current frame is the same with the end frame. The setting range of the current frame is related to the start frame and

end frame settings. During the setting process, the screen will display the corresponding waveform of the current frame synchronously, namely manual playback.



If you perform the playback operation after setting this parameter, this menu will be adjusted to the value corresponding to the "Start Frame" automatically and will change continuously during the playback process.

5. End Frame

Press this softkey and use  to set the end frame of the playback. The default is the number of frames of the waveform to be played back.

6. Playback Operation

Waveform playback can be realized through the shortcut buttons in the menu or on the front panel.

Menu	Front Panel
Press Operate and select "▶" to start playing back.	Press  to start the playback. The backlight was illuminated yellow and starts to blink.
Press Operate and select " " to pause the playback.	Press  again to pause the playback. The backlight was illuminated yellow continuously and stops blinking.
Press Operate and select "■" to stop the playback.	Press  to stop the playback. The backlight was illuminated orange.

Tip

In waveform playback, use **Run/Stop** to switch between play and pause. Each time **Single** is pressed, the **Current Frame** moves one frame forward.

Waveform Analysis

This function is used to analyze the recorded waveform. Press **UTIL** → **Record** → **Mode** and use  to select "Analyze" to open the waveform analysis menu. At this point, the screen is divided into two display areas as shown in the figure below.

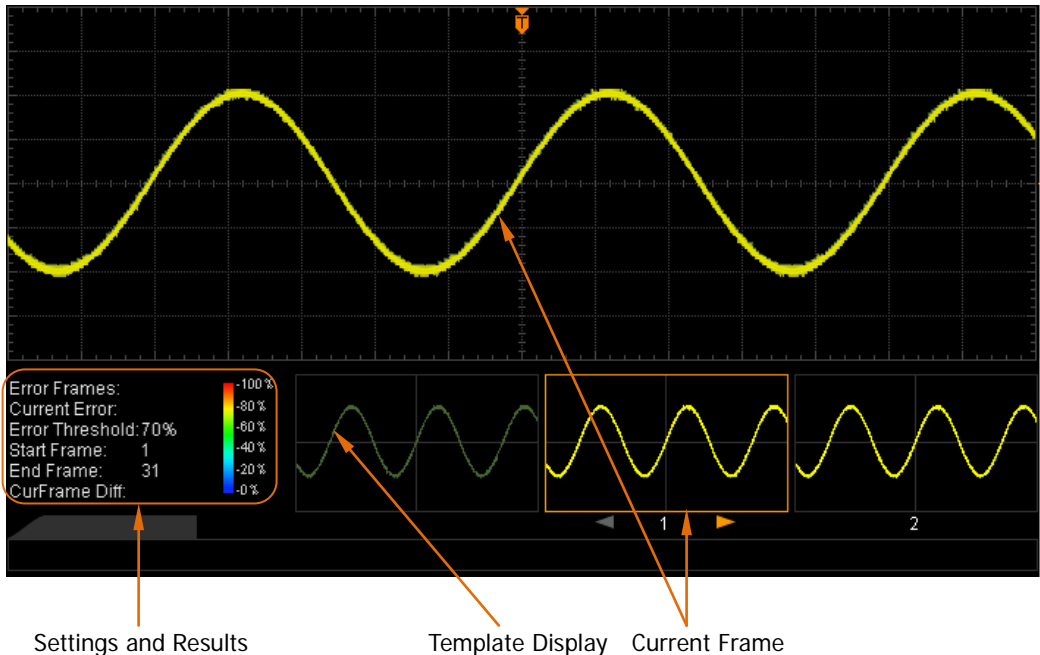

Please set the related parameters of waveform analysis by referring to the following explanations.

1. Analysis

Press **Analyze** to select the desired analysis mode.

- Trace: Perform analysis on the basis of the template selected by users. For detailed introduction, refer to "**Analysis Based on Trace**".
- Pass/Fail: perform analysis on the basis of the Pass/Fail mask created by users. For detailed introduction, refer to "**Analysis Based on Pass/Fail Mask**".

2. Source

Press **Source** to select the channel (CH1-CH4) to be analyzed. Note that only channels currently enabled can be selected.

3. Start

Press **Start** to enable waveform analysis. Note that during the analysis process, the progress bar is displayed and the parameters cannot be modified. After the analysis finishes, the analysis results of "Error Frames", "Current Error" and "CurFrame Diff" are displayed, at the same time, the first error frame is located, as shown in the figure below. At this point, using menu can locate the next error frame, the previous error frame as well as every frame in this waveform analysis.

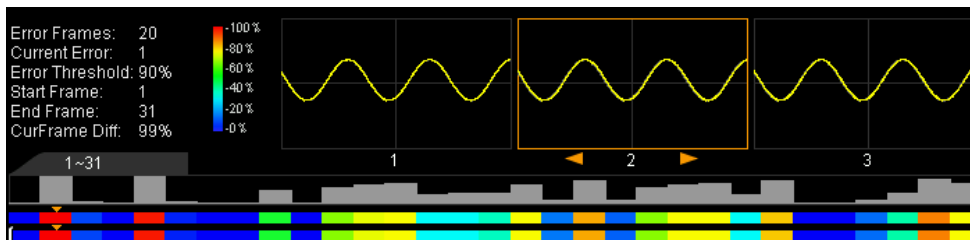

Error Frames: the total number of error frames discovered in this analysis. The number of error frames is related to the error frame threshold currently set.

Current Error: the order number of the error frame lately located in all the error frames when locating every data frame in this analysis.

CurFrame Diff:

- During the analysis based on trace, the oscilloscope compares each frame of data with the template to compute the difference value and normalizes each value using the maximum one, then, compares the normalized value with the threshold selected to judge whether the frame is an error frame. "CurFrame Diff" (relative difference) is the normalized value of the difference between current frame and template.
- During the analysis based on pass/fail mask, the oscilloscope compares each frame with the mask to compute the difference value and recognizes the frame whose difference value is equal to or larger than the threshold selected as an error frame and the corresponding "CurFrame Diff" is 100%; otherwise, the frame is judged as correct and the "CurFrame Diff" is 0%. Note: There are only two "CurFrame Diff" values (100% and 0%) under the analysis based on pass/fail mask.

4. Cancel

During the analysis, users can press **Cancel** to stop the analysis and press **Start** again to restart the analysis.



5. Previous

After the waveform analysis finishes, press **Previous** can locate the error frame before the current error frame. Pressing **Run/Stop** can also perform the operation.

6. Next





After the waveform analysis finishes, press **Next** can locate the error frame following the current error frame. Pressing **Single** can also perform the operation.

7. Current Frame

Press **Current Frame**; use  or the inner knob of the navigation knob  to adjust the data frame currently displayed at the specified step (1) or rotate the outer knob of the navigation knob  to quickly adjust the data frame currently displayed within a relatively larger range. (The greater the rotation amplitude of the outer knob, the faster the variations in the values.) The adjustable range is from 1 to the total number of frames in this waveform analysis.

8. Setup

Press **Setup** to open the detailed setting menu.

- Screen Start: press this key to set the start point of waveform analysis and the range is from 5 to 685. The start point must be lower than the "Screen End-10" currently set.
- Screen End: press this key to set the end point of waveform analysis and the range is from 15 to 695. The end point must be greater than the "Screen Start+10" currently set.
- Start Frame: press this key to set the start frame of waveform analysis (use  or the navigation knob  (quickly adjust the start frame within a large range)) and the default is the first frame.
- End Frame: press this key to set the end frame of waveform analysis (use  or the navigation knob  (quickly adjust the end frame within a large range)) and the default is the last frame.
- Threshold: press this key to set the threshold of waveform analysis and the range is from 1% to 99%. The threshold is used to judge whether the frame

is an error frame. A frame can be recognize as an error one if the (relative) difference between the frame and the template is equal to or larger than the threshold currently set.

Analysis Based on Trace

Press **Analyze** and select "Trace". Then, set the template used in analysis based on trace through the method below.

1. Trace

Press **Trace** to select the creation method of analysis template.

- Current Frame: select the current frame as the analysis template.
- Average: select the average of the current data frame as the analysis template.

2. Setup Template

Press **Template** to configure the template immediately. After the analysis starts, the oscilloscope compares each frame with the template to compute the difference and determines whether error frame exists by comparing the difference with the threshold currently set.

3. Template Display



Press **Template** to turn on or off the display of the template.

Analysis Based on Pass/Fail Mask

Press **Analyze** and select "Pass/Fail". Then, set the template used in analysis based on Pass/Fail mask through the method below.

Press **Range** to open the following setting menus.

1. Mask Range

Press **Range** to select "Screen" or "Cursor" for the analysis (the default is "Screen"). When "Cursor" is selected, two gray cursor lines appear on the screen. At this point, press **CursorA** and **CursorB**; then, use  to adjust the positions of the two cursor lines respectively to determine the analysis range. Or, press **CursorAB** and use  to adjust the positions of cursor A and cursor B at the same time. Note that you can press down  continuously to switch the current cursor.

2. X Mask

Press this softkey and use  to adjust the horizontal threshold and the range is from 0.02 div to 4.00div. During the adjustment, two curves would be displayed to show the outline of the current mask, see the figure below.

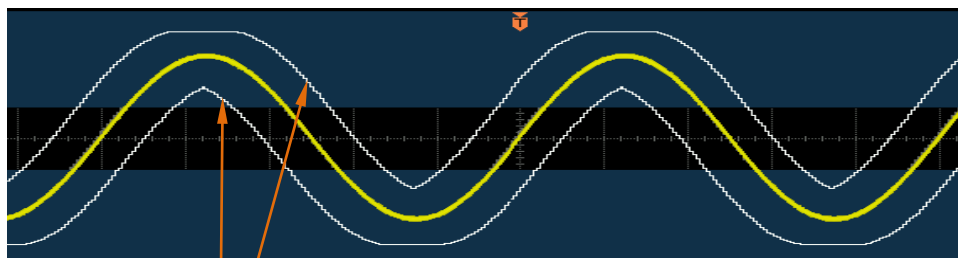

Current Mask Outline

3. Y Mask

Press this softkey and use  to adjust the vertical threshold and the range is from 0.03 div to 4.00 div. During the adjustment, two curves would be displayed to show the outline of the current mask.

4. Create Mask

Mask is the template used in waveform analysis. Press **Create** to immediately apply the mask (X Mask and Y Mask) currently created.

Users can store the current test mask into the internal Flash memory or external USB storage device or load the test mask file (*.pf) stored in the internal Flash memory or external USB storage device into the internal memory.

Press **Save** to enter the file storage interface. Store the test mask file to internal or external memory by referring to the introduction in "**Store and Recall**".

Press **Load** to enter the file load interface. Load the test mask into the internal memory of the instrument by referring to the introduction in "**Store and Recall**".

11 Display Control

You can set the type, the persistence time and the brightness of waveform display as well as the grid type, grid brightness of the screen display and the menu display time.

The contents of this chapter:

- To Select the Display Type
- To Set the Persistence Time
- To set the Waveform Brightness
- To Set the Screen Grid
- To Set the Grid Brightness
- To Set the Menu Display

To Select the Display Type

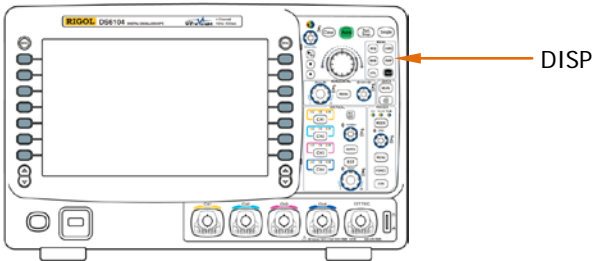

Press **DISP** → **Type** to set the waveform display mode to "Vectors" or "Dots".

- Vectors: the sample points are connected using lines and displayed. Normally, this mode can provide the most vivid waveform to view the steep edge of the waveform (e.g. square waveform).
- Dots: display the sample points directly. You can directly view each sample point and use the cursor to measure the X and Y values of the sample point.

To Set the Persistence Time

Press **DISP** → **PersistTime** to set the persistence time of the oscilloscope to Vmin, specific values (from 50 ms to 20 s) or Infinite.

In the following part, a frequency sweep signal of the sine waveform is used to demonstrate the waveform effects in different persistence times.

1. Vmin

Enable to view the waveform changing in high refresh rate.

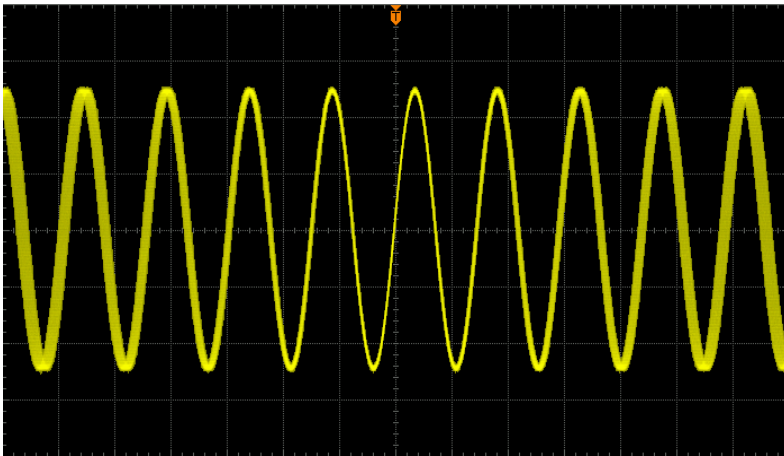

2. Specific Values

Enable to observe glitch that changes relatively slowly or glitch with low occurrence probability. The persistence time can be set to 50 ms, 100 ms, 200 ms, 500 ms, 1 s, 2 s, 5 s, 10 s or 20 s.

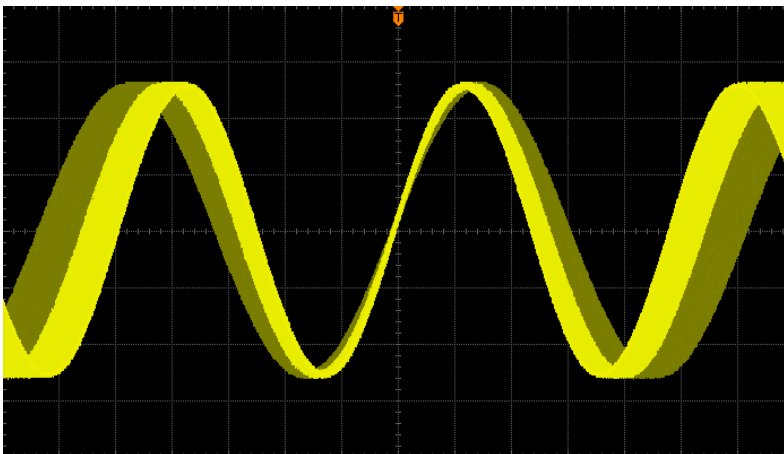

3. Infinite

In this mode, the oscilloscope displays the waveform newly acquired without clearing the waveforms acquired formerly. The waveforms acquired formerly will be displayed in relatively low-brightness color and the waveform newly acquired will be displayed in normal brightness and color. Infinite persistence can be used to measure noise and jitter and to capture incidental events.





To set the Waveform Brightness

When you press **DISP** → **WaveIntensity** or when the menu is hidden, you can turn  to adjust the waveform brightness of the analog channel. The default is 50% and the range available is from 0% to 100%.

To Set the Screen Grid

Press **DISP** → **Grid** to set the screen grid type.

- : turn the background grid and coordinate on.
- : turn the background grid off and turn the coordinate on.
- : turn the background grid and coordinate off.

To Set the Grid Brightness

Press **DISP** → **Brightness** to set the brightness of the screen grid. Turn  to adjust the grid brightness. The default is 50% and the range available is from 0% to 100%.

To Set the Menu Display

Press **DISP** → **MenuDisplay** to set the menu display time. The menu will hold for a specified period of time after the last button-pressing action and then hide. The display time can be set to 1 s, 2 s, 5 s, 10 s, 20 s or Infinite (the menu does not hide).

12 Store and Recall

Users can save the current settings, waveforms, and screen image in internal memory or external USB storage device (U disk) in various formats and recall the stored settings or waveforms when needed.

The contents of this chapter:

- Storage System
- Storage Type
- Internal Store and Recall
- External Store and Recall
- Disk Management
- Factory

Storage System

Press **SAVE** to enter the store and recall setting interface.

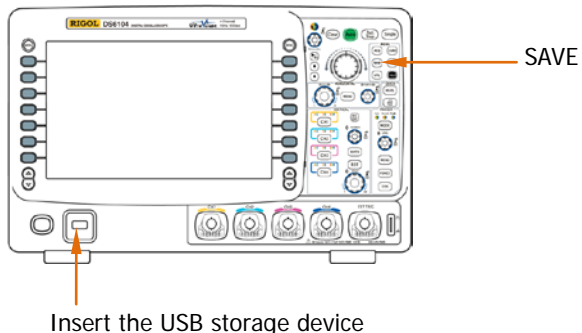

This oscilloscope provides a USB Host interfaces at the front and rear panels respectively to connect USB storage device for external storage. The USB storage device connected is marked with "Disk E" (front panel) and "Disk D" (rear panel). The internal memory (Local Disk) of the instrument can store 10 trace files, 10 waveform files and 10 setting files as well as 10 reference waveform files and 10 test mask files of the Pass/Fail test. Below is the disk selecting interface.

Name	Size	Time
Up...		
Local Disk	1.00G	
Disk D	124.6M	
Disk E	124.6M	

Table 12-1 Probable Icons

Icon	Description	Icon	Description
	Return to the previous disk management interface		Waveform File
	Local Disk Memory		JPEG File
	External USB Storage Device		Pass/Fail Mask File
	Folder		PNG File
	Return to the previous folder		Waveform Recording File
	Unknown File		Reference Waveform File
	Bitmap File		Setting File
	CSV File		Trace File
	TIFF Format File		

Storage Type

Press **SAVE** → **Storage** to select the desired storage type. The descriptions of the save and load methods for each storage type are as follows. If a USB storage device does not connect to the instrument, "Picture" and "CSV" under the **Storage** menu are disabled.

1. Traces

Save the waveform data in internal or external memory in "*.trc" format. At most 10 trace files (from LocalTrace0.trc to LocalTrace9.trc) can be stored in the internal memory. The data of all the channels turned on can be saved in the same file. At recall, the data will be displayed on the screen directly.

Note:

- You can only save and load the files in "*.trc" format through the operation buttons on the front panel of the digital oscilloscope.
- After loading the files in "*.trc" format, press **Clear** to clear the loaded waveforms; and meanwhile, the waveforms displayed on the screen will all be cleared. (If the oscilloscope is in the "RUN" state, it will continue to display the new waveforms.)

2. Waveforms

Save the waveform data in internal or external memory in "*.wfm" format. At most 10 waveform files (from LocalWfm0.wfm to LocalWfm9.wfm) can be stored in internal memory. The stored files contain the waveform data of the four analog channels and the main setting information of the oscilloscope and all the data can be recalled.

Note:

- You can only save and load the files in "*.wfm" format through the operation buttons on the front panel of the digital oscilloscope.
- After loading the files in "*.wfm" format, the oscilloscope is in the "Stop" state. Change the state of the oscilloscope into "RUN", and the oscilloscope will restart the waveform sampling. (The loaded waveform data will be cleared.)

3. Setups

Save the settings of the oscilloscope in internal or external memory in "*.stp"

format. At most 10 setting files (from LocalSetup0.stp to LocalSetup9.stp) can be stored in internal memory. The stored settings can be recalled.

4. Picture

Save the screen image in external memory in ".bmp", ".png", ".jpeg" or ".tiff" format. You can specify the file name and saving directory and save the corresponding parameter file (*.txt) under the same directory using the same file name. The recall of image and reference files is not supported.

After selecting this type:

Press **Pic Type** to select the desired storage format.

Press **Para.Save** to enable or disable the parameter save function.

Press **Inverted** to turn the invert function when storing pictures on or off.

Press **Color** to select the desired color.

Press **Header** to turn the header display on or off.

Press **Footer** to turn the footer display on or off.

Tip

After a USB storage device is connected (no PictBridge printer is connected), press the print key  on the front panel to quickly save the current screen image under the root directory of the USB storage device in the picture format currently selected. When a PictBridge printer and USB storage device are connected at the same time, the printer enjoys higher priority.

5. CSV

Save the waveform data displayed on the screen or of the specified channel in external memory in a single ".csv" file. You can specify the file name and the saving directory and save the corresponding parameter file (*.txt) under the same directory using the same file name. The recall of CSV and parameter files is not supported.

After selecting this type:

Press **DataDepth** to select "Displayed" or "Maximum". After selecting "Maximum", press **Channel** to select the desired channel (note that only channels currently enabled can be selected).

Press **Para.Save** to enable or disable the parameter save function.

Press **Sequence** to select whether to add a sequence number to the waveform point in the CSV file.

Internal Store and Recall

Internal store and recall support "Traces", "Waveforms" and "Setups" in **Storage**. In the following part, "Traces" are taken as an example for illustration.

1. Save the specified type of file in internal memory.

- 1) Connect the signal to the oscilloscope and obtain stable display.
- 2) Press **SAVE** → **Storage** to select "Traces" and press **Save** to turn on the interface as shown in Figure a. use ↶ to select " Local Disk" and press ↶ to turn on the local disk (Figure b).



Figure a





- 3) As shown in Figure b, the local disk can at most store 10 trace files. Use  to select the desired storage position, **Save** is illuminated and then press the menu to execute the saving operation. If the current position contains a file, the original file can be overwritten or be deleted by pressing **Delete**. Use  to select  and then press down  to return to the previous directory.



Figure b

Note: In internal storage, **New File** and **New Folder** are not available.

2. Load the specified type of file in the internal memory.

- 1) Press **SAVE** → **Storage** to select "Traces" and then press **Load** to turn on the interface as shown in Figure c. Use ↻ to select "Local Disk" and then press down ↵ to open the local disk.



Figure c

- 2) Use ↻ to select the desired file to be loaded and press **Load** to load the file selected.

External Store and Recall

Before using external store and recall, make sure that a USB storage device is connected correctly. External storage supports all the types of files in **Storage** but in recall, "Picture" and "CSV" are not supported.

1. Save the specified type of file in the external USB storage device.

- 1) Connect the signal to the oscilloscope and obtain stable display.
- 2) Press **SAVE** → **Storage** to select "CSV" and press **Save** to turn on the interface as shown in Figure d. Use ↻ to select "Disk E" and press down ↻ to open the USB storage device.



Figure d

- 3) Use ↻ to select the desired storage position. Enable to store under the root directory or in a certain folder under the root directory of the USB storage device.
- 4) After the storage position is selected, press **New File** and create a new filename by referring to the descriptions in "**To Create a New File or Folder**".
- 5) Press **OK** to execute the saving operation.

2. Load the specified type of file in the external USB storage device.



- 1) Press **SAVE** → **Storage** to select "Traces" and then press **Load** to turn on the interface as shown in Figure e. Use ↻ to select "Disk E" and press down ↻ to open the USB storage device.



Figure e

- 2) Use ↻ to select the desired file to load and then press **Load** to load the selected file.

Disk Management

Press **SAVE** → **Disk.Manage** to turn on the disk management interface as shown in the figure below and use  to select the desired disk. The disk currently selected is displayed in green and press down  to open the selecte disk.

Name	Size	Time
 Up...		
 Local Disk	1.00G	
 Disk D	124.6M	
 Disk E	124.6M	

Execute the following operations through the disk management menu:

- To Select File Type
- To Create a New File or Folder
- To Delete a File or Folder
- To Rename a File or Folder
- To Clear the Local Memory

To Select File Type

Except the file types in **Storage**, the oscilloscope can also display, save or read some files for advanced applications such as mask file of the Pass/Fail test (*.pf), waveform recording file (*.rec), update file (.gel), parameter file (*.txt) and reference waveform file (*.ref).

Press **SAVE** → **Disk.Manage** → **File Type** to select the desired file type. The default is "*. *". Under the current directory, only files of which the suffixes of the file name match with the file type selected will be displayed in the current disk.

To Create a New File or Folder

This operation is only valid in external storage. Before using external store and recall, make sure that a USB storage device is connected correctly.

First, press **SAVE** → **Disk Manage** and use  to select and open the external disk ("Disk D" or "Disk E").



Second, select the desired directory under which to create a new file or folder. The default is the root directory of the USB storage device.

Then, press **File Type** to select the desired file type and press **New File** or **New Folder** to turn on the interface as shown in the figure below.



This oscilloscope supports Chinese/English input method. The file name or folder name can contain letters, numbers, underlines, spaces and Chinese characters and the length of the characters is limited to 31 bytes. The following part introduces how to input a file name or folder name using Chinese/English input method.





Operation Tip

During the name input, use the menu softkeys to select different operation areas, then turn  to select the desired content and press down  to input the content selected.

English Input Method

For example, create a file or folder using the name "Filename".

1. Press **Keyboard**.

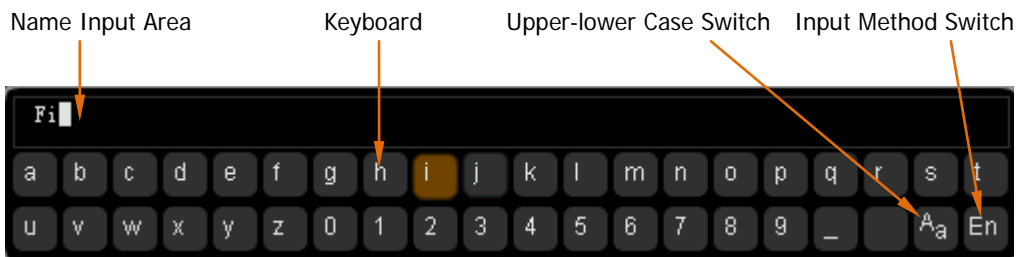

- 1) Use  to select English input method "En" and uppercase input state "A".
- 2) Use  to input the letter "F". If the input is wrong, press **Delete** to delete the character input.
- 3) Use  to select lowercase input state "Aa".
- 4) Use  to input the remaining letters "ilename".



2. During the name input, you can press **Name** to select the "Name Input Area" and use  to move the cursor, then press **Delete** to delete the characters on the left of the cursor one by one.
3. After finishing the input, press **OK** and the oscilloscope will create a folder or a specified type of file with this file name under the current directory.

Chinese Input Method

For example, create a file or folder using the name "文件名".

1. Press **Keyboard**.
 - 1) Use  to select Chinese input method "中". Note that the "Chinese" menu item is added in the menu items at the right of the screen.
 - 2) Use  to input the pinyin "wen". If the input is wrong, press **Delete** to delete the pinyin input. After "wen" is input, a series of Chinese characters appear in the "Chinese Character Selecting Area".
 - 3) Press **Chinese** and use  to select and input "文".
 - 4) Use the same method to input "件" and "名".





2. During name input, you can press **Name** to select the "Name Input Area" and then press **Delete** to delete the characters on the left of the cursor one by one.
3. After finishing the input, press **OK** and the oscilloscope will create a folder or a specified type of file with this file name under the current directory.



To Delete a File or Folder

Folder operation is valid only in external storage. Before using the external disk, make sure that a USB storage device is connected correctly.

1. Delete a file in internal memory.



- 1) Press **SAVE** → **Disk.Manage** and use  to select and open the local disk ("Local Disk").
- 2) Press **File Type** to select the desired file type to be deleted (note that the file types that support internal storage include "*.stp", "*.trc", "*.ref", "*.pf" and "*.wfm").
- 3) Use  to select the desired file to be deleted.
- 4) Press **Delete** to delete the file selected.

2. Delete a file or folder in external memory.

Press **SAVE** → **Disk.Manage** and use  to select and open the external disk ("Disk D" or "Disk E"). Use  to select the file (or folder) to be deleted and then press **Delete** to delete the selected file (or folder).

To Rename a File or Folder

Rename operation is valid only in external storage. Before using the external disk, make sure that a USB storage device is connected correctly.

Press **SAVE** → **Disk.Manage** and use  to select and open the external disk ("Disk D" or "Disk E"). Use  to select the desired file or folder to rename and then press **Rename** to open the rename interface. For specific operations, please refer to the descriptions in "To Create a New File or Folder".

To Clear the Local Memory

You can clear all the files stored in the local memory with one operation.

Press **SAVE** → **Disk.Manage** and select "Local Disk", then turn to the next menu page and press **Security Clear** → **OK** to delete all the files stored in the local memory.

Note: After selecting the local disk ("Local Disk"), do not press ; otherwise, **Security Clear** will be grayed out and disabled.

Factory

Press **SAVE** → **Default** to return the oscilloscope to its factory state. Refer to the table below.

Table 12-2 Factory

Parameter	Factory
Horizontal Setting (HORIZONTAL)	
Channel Setting (VERTICAL)	
Acquisition Setting (ACQ)	
Trigger Setting (TRIGGER)	
Display Setting (DISP)	
Cursor Setting (CURS)	
Storage Setting (SAVE)	
Utility Function Setting (UTIL)	
Math Operation Setting (MATH→Operation)	
Protocol Decoding (MATH→BUS1/BUS2)	
Reference Waveform Setting (REF)	
Horizontal Setting (HORIZONTAL)	
Horizontal Time Base	1 μ s
Horizontal Offset	0 s
Delayed Sweep	OFF
Time Base Type	Y-T
Time Base Scale	Coarse
Horizontal Reference	The Center of the Screen
Channel Setting (VERTICAL)	
Vertical Scale	1 V
Vertical Offset	0 V
CH1 Switch	ON
CH2 Switch	OFF
CH3 Switch	OFF
CH4 Switch	OFF
Channel Coupling	DC
Bandwidth	OFF
Input Impedance	1 M Ω

Channel Invert	OFF
Vertical Scale	Coarse
Channel Unit	V
Acquisition Setting (ACQ)	
Acquisition Mode	Normal
Sampling Mode	Real Time
Memory Depth	Auto
Anti-Aliasing	OFF
Trigger Setting (TRIGGER)	
Trigger Type	Edge
Source	CH1
Slope	Rising Edge
Trigger Mode	Auto
Trigger Coupling	DC
Trigger Holdoff	100 ns
Display Setting (DISP)	
Display Type	Vectors
Persistence Time	Min
Waveform Intensity	50%
Screen Grid	
Brightness	50%
Menu Display	Infinite
Cursor Setting (CURS)	
Mode	OFF
Manual	
Cursor Type	X-Y
Source	CH1
Select Cursor	X
Time Unit	s
Vertical Unit	The unit of the signal source
Horizontal Positions of the X Cursors	
CursorA	-4*1 μ s
CursorB	4*1 μ s
Vertical Positions of the Y Cursors	
CursorA	2*1 V
CursorB	-2*1 V

Track	
AXIS	Y
Cursor A	CH1
Cursor B	CH1
Horizontal Positions of the X Cursors	
CursorA	-4*1 μ s
CursorB	4*1 μ s
Storage Setting (SAVE)	
Storage Type	Picture
Picture Storage	
Picture Type	png
Parameter Save	OFF
Inverted	OFF
Color	Color
Header	OFF
Footer	OFF
CSV Storage	
Data Depth	Displayed
Parameter Save	OFF
Sequence	ON
Utility Function Setting (UTIL)	
I/O Setting	
Network Configuration Mode	DHCP, Auto IP
USB Device	Computer
Sound	
Sound	OFF
Pass/Fail Test	
Enable Test	OFF
Source	CH1
Operate	OFF
X Mask	0.24div
Y Mask	0.38div
Message Display	OFF
Stop On Output	OFF
Output	Fail

AuxOutput	OFF
Waveform Recording	
Mode	OFF
Record	
End Frame	3998
Operate	OFF
Interval	100 ns
Max End Frame	3998
Playback	
Operate	OFF
Play Mode	Single
Interval	100 ns
Start Frame	1
Analyze	
Analysis Mode	Trace
Source	CH1
Trace Mode	Current Frame
Current Frame	1
Template Display	ON
System Setting	
Vertical Expansion	Ground
Screen Saver	Default
Screen Saver Time	OFF
External Trigger Impedance	1 M Ω
Aux Output	TrigOut
Reference Clock	ClockOutput
Math Operation Setting (MATH→Operation)	
Operate	OFF
A+B	
Source A	CH1
Source B	CH1
Invert	OFF
Vertical Scale	2 V
A-B	
Source A	CH1

Source B	CH1
Invert	OFF
Vertical Scale	2 V
A × B	
Source A	CH1
Source B	CH1
Invert	OFF
Vertical Scale	2 U
A ÷ B	
Source A	CH1
Source B	CH1
Invert	OFF
Vertical Scale	2 U
FFT	
Source	CH1
Window Function	Rectangle
Display	Split
Scale	dB
Vertical Scale	20 dBV
Horizontal Scale	1.25 MHz/div
FFT Sample Rate	50 MSa/s
Anti-Aliasing	OFF
Logic Operation	
Expression	AND
Source A	CH1
Source B	CH1
Invert	OFF
Vertical Scale	1 U
Threshold A	0 V
Threshold B	0 V
Advanced Operation	
Expression	OFF
Expression	CH1+CH2
Invert	OFF
Vertical Scale	2 V
Protocol Decoding (MATH→BUS1/BUS2)	

Decoding Type	Parallel
Bus Status	OFF
Format	Hex
Offset	0
Threshold	0
Parallel	
Clock Channel	CH1
Slope	Rising Edge
Bus Bits	1
Current Bit	0
Channel	CH1
RS232	
TX	CH1
RX	None
Polarity	Normal
Endian	LSB
Baud	9600 bps
Data Bits	8
Stop Bit	1
Even-Odd Check	None
Packet	OFF
Packet End	00 (NULL)
I2C	
SCLK	CH1
SDA	CH2
Include R/W	Close
SPI	
Decoding Mode	TimeOut
Timeout	1.00 μ s
SS Channel	CH2
SS Polarity	Low
SCLK Channel	CH1
SCLK Slope	Rising Edge
MISO Channel	CH2
MISO Polarity	High
MOSI Channel	None

MOSI Polarity	High
Data Bits	8
Endian	MSB
CAN	
Source	CH1
Signal Type	Rx
Baud Rate	500 kb/s
Sample Point	50%
FlexRay	
Source	CH1
Signal Path	A
Signal Type	BP
Baud Rate	10 Mb/s
Sample Point	50%
Reference Waveform Setting (REF)	
Channel Setting	Ref1
Current Channel	Ref1
Source	CH1
Color	Gray

13 System Function Setting

The contents of this chapter:

- Remote Interface Configuration
- System-related
- To Print the Waveform

Remote Interface Configuration

DS6000 can communicate with PC via LAN, USB and GPIB (with the USB to GPIB interface converter of **RIGOL**) buses. Please refer to the introduction below to configure the corresponding interface before using the remote interfaces.

LAN Setting

Press **UTIL** → **IO Setting** → **LAN Set** to open the LAN setting interface. You can view the network connection status and configure the network parameters.

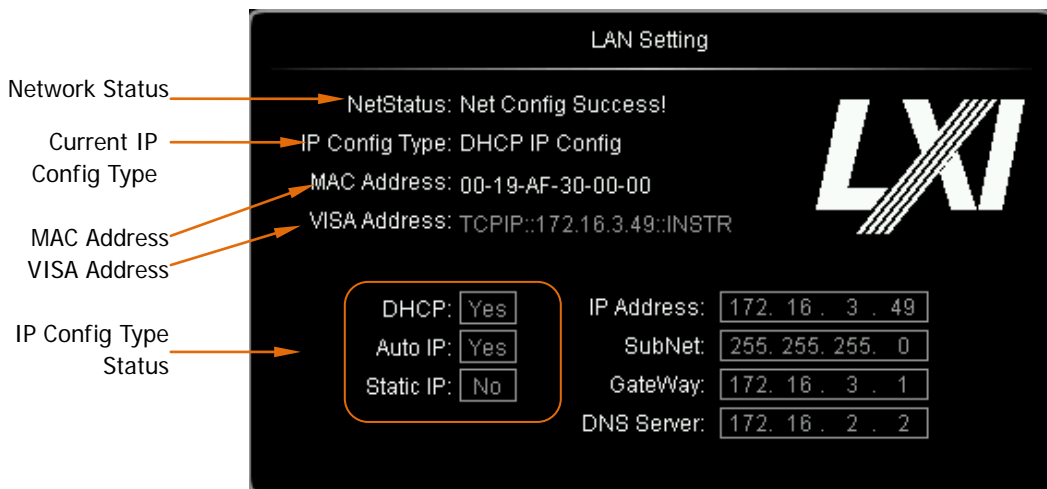



Network Status

Connect the oscilloscope to your local area network using the network cable. The LAN interface of the oscilloscope is on the rear panel. The oscilloscope will give different prompts according to the current network connection status.

- Net Config Success!
- Acquire IP...
- IP Conflict!
- Unconnected!
- DHCP Fail!



IP Configuration Type (DHCP)

The configuration type of the IP address can be DHCP, auto IP or static IP. In different IP configuration type, the configuration mode of the network parameters such as the IP address is different.



Press **Config Mode** and use  to select "DHCP". Then press down  to select this type. When DHCP type is valid, the DHCP server will assign the network parameters such as the IP address for the oscilloscope.



IP Configuration Type (Auto IP)

Press **Config Mode** and use  to select "Auto IP". Then press down  to select this type. When the auto IP type is valid, **Gate** and **DNS** are added to the right side of the screen and users can define the gateway and DNS server address of the oscilloscope. In auto IP mode, the oscilloscope will get the IP address ranging from 169.254.0.1 to 169.254.255.254 and the subnet mask 255.255.0.0 automatically according to the current network configuration.

IP Configuration Type (Static IP)

Press **Config Mode** and use  to select "Static IP". Then press down  to select this type. When this type is valid, disable DHCP and auto IP manually, **IP Address**, **Mask**, **Gate** and **DNS** are added to the right of the screen. At this point, users can define their own network parameters (such as the IP address) of the oscilloscope.

1. Set the IP Address

The format of the IP address is nnn.nnn.nnn.nnn, where, the range of the first

nnn is from 1 to 223 (except 127) and the ranges of the other three nnn are from 0 to 255. You are recommended to ask your network administrator for an IP address available.

Press **IP Address** and use  to input the desired IP address. This setting will be saved in the non-volatile memory and if "**Power-off Recall**" is set to "Last" and **DHCP** and **Auto IP** is set to "Off" at the next power-on, the oscilloscope will load the preset IP address automatically.

2. Set the Subnet Mask.

The format of the subnet mask is nnn.nnn.nnn.nnn, where, the range of the nnn is from 0 to 255. You are recommended to ask your network administrator for a subnet mask available.

Press **Mask** and use  to input the desired subnet mask. This setting will be saved in the non-volatile memory and if "**Power-off Recall**" is set to "Last" and **DHCP** and **Auto IP** is set to "Off" at the next power-on, the oscilloscope will load the preset subnet mask automatically.

Set the Gate

You can set this parameter in **Auto IP** and **Static IP** mode.

The format of the gate is nnn.nnn.nnn.nnn, where, the range of the first nnn is from 1 to 223 (except 127) and the ranges of the other three nnn are from 0 to 255. You are recommended to ask your network administrator for a gate address available.

Press **Gate** and use  to input the desired gate address. This setting will be saved in the non-volatile memory and if "**Power-off Recall**" is set to "Last" and **DHCP** and **Auto IP** is set to "Off" at the next power-on, the oscilloscope will load the preset gate address automatically.

Set the Domain Name Server

You can set this parameter in **Auto IP** and **Static IP** mode.

The address format of the domain name server is nnn.nnn.nnn.nnn, where, the range of the first nnn is from 1 to 223 (except 127) and the ranges of the other three nnn are from 0 to 255. You are recommended to ask your network administrator for an address available.

press **DNS** and use ↻ to input the desired address. Generally, users do not need to set the DNS, therefore this parameter setting can be ignored.

Tips

- When the three IP configuration types are all turned on, the priority of the parameter configuration from high to low is "DHCP", "Auto IP" and "Static IP".
- The three IP configuration types cannot be all turned off at the same time.

Apply the Network Parameter Setting

Press **Apply** to validate the current network parameter setting.

Initialize the network Parameters

Press **Initialize** to return the network parameters to the default state.

MAC Address

For each oscilloscope, the MAC address is unique. When attributing the IP address for the oscilloscope, the MAC address is usually used to identify the instrument.

VISA Address

Display the VISA address currently used by the oscilloscope.

USB Device

This oscilloscope can communicate with a PC or PictBridge printer via the **USB DEVICE** interface on the rear panel. You need to set the oscilloscope to make it match with different device types.

Press **UTIL** → **IO Setting** → **USB Device** and use  to select the desired device type.

- Computer: under this type, the oscilloscope can communicate with a PC.
- PictBridge: under this type, the oscilloscope can communicate with a PictBridge printer.

To Set the GPIB Address



When using the GPIB method to control the oscilloscope, you need to use the USB-GPIB interface converter (need to order separately) to extend a GPIB interface for the oscilloscope.

To set the GPIB address, press **UTIL** → **IO Setting** → **GPIB** and use  to input the desired address. The default is 1 and the range available is from 1 to 30.

System-related



Sound

When the sound is enabled, you can hear the sound of the beeper when you press a key or a menu softkey on the front panel or when a prompt message pops up.

Press **UTIL** → **Sound** to select  (on) or  (off). The default is off. When the sound is turned on, a trumpet icon  will be displayed at the lower-right corner of the screen.

Language

This oscilloscope supports multiple language menus as well as Chinese/English help information, prompt messages, and interface display.

Press **UTIL** → **Language** and use  to select the desired language and press down . You can also press down the **Language** softkey to switch the current language type.

System Information

Press **UTIL** → **System** → **System Info** to view the system information including the manufacturer, model, serial number, software version number and hardware version number.

Power-off Recall

You can set the system configuration to be recalled when the oscilloscope is powered on again after power-off.



Press **UTIL** → **System** → **Power On** to select "Last" or "Default".

- Last: restore the instrument to the setting at the last power-off.
- Default: return to the factory setting of the system.

System Time

The system time is displayed at the lower-right corner of the screen in "hh:mm (hour:minute)" format. When printing or storing a waveform, the file output will contain this time information.

Press **UTIL** → **System** → **System Time** to turn on the time setting interface.

In the system time setting menu, press **System Time** to turn on the system time interface. In this interface, the system time is displayed in "yyyy-mm-dd hh:mm:ss" format. The item that can be modified currently (namely the item currently selected) is in green and the other items are in white. Use  to modify the item currently selected; then, press down  to confirm the modification and automatically select the next item. The order of the time modifications is year → month → date → hour → minute → second. The setting range of each item conforms to the convention.

- Year: 1999 to 2099
- Month: 01-12
- Date: 01-31 (28, 29 or 30)
- Hour: 00 to 23
- Minute: 00 to 59
- Second: 00 to 59

Press **Apply** to put the current setting into effect. The time at the lower-right corner of the screen will be updated.

Self-calibration Information

Press **UTIL** → **System** → **SelfTestInfo** to view the result of the last self-calibration of the oscilloscope. The self-calibration result usually contains the system voltage, battery status and etc.

Note: If the oscilloscope is installed with battery, the self-calibration information will also display the electricity, voltage and current of the battery.

Screen

When the oscilloscope enters the idle state and holds for a certain period of time, the screen saver program will be enabled.

Press **UTIL** → **System** → **Screen** to turn on the screen saver setting menu. "Default" means using the icon **RIGOL** as the screen saver icon.

Press **Time** to select the time of the screen saver. When "OFF" is selected, the screen saver program is disabled. The time of the screen saver can be set to 1 min, 2 min, 5 min, 15 min, 30 min, 45 min, 60 min, 2 hour or 5 hour.

Error Information

The error information that might appear includes: the temperature of the main board is too high, the fan stops rotating etc. If the above-mentioned information appears, users need to return the instruments back to our factory for repair. At most 16 error messages lately appeared can be viewed. The error information is stored in volatile memory and will be cleared automatically after power-off.

If there are error messages in the oscilloscope currently, an exclamation mark is displayed in the status bar at the lower-right corner of the screen. At this point, you can press **UTIL** → **System** → **ErrorInfo** to view the error messages. If the oscilloscope works normally, **ErrorInfo** is grayed out and disabled.

Self-calibration

Self-calibration program can quickly help the oscilloscope to reach the best working state and get the most precise measurement values. You can perform self-calibration at any time especially when the change range of the environment temperature is up to or more than 5°C. Make sure that the oscilloscope has been warmed up or operated for more than 30 minutes.

The self-calibration uses the fast edge signal output from the **[Trig Out/Calibration]** connector on the rear panel as the calibration signal. Please connect this signal to the four input channels and the external trigger input channel, and then press **UTIL** → **Self-Cal** to turn on the self-calibration menu and self-calibration interface.

Press **Start** and the oscilloscope will start to execute the self-calibration program. Press **Exit** to give up the self-calibration operation at any time and return to the previous menu.

Note: Most of the keys are disabled during the self-calibration.

Power Status

Users can set the power status of the oscilloscope after power-on. Connect the oscilloscope to the AC source using the power cord and turn on the power switch on the rear panel, the oscilloscope is powered on.

Press **UTIL** → **PowerStatus** to select "Default" or "Open".

- Default: after the oscilloscope is powered on, you need to press the power key on the front panel to start up the oscilloscope.
- Open: after the oscilloscope is powered on, it starts up directly. Note: At this point, you can still press the power key on the front panel to turn off the oscilloscope.

External Trigger Impedance

Users can set the input impedance of the **[EXT TRIG]** connector on the front panel.

Press **UTIL** → **Extimpedance** to select "1 M Ω " (default) or "50 Ω ".

Aux Output

Users can set the signal type output from the **[Trig Out/Calibration]** connector on the rear panel.

Press **UTIL** → **AuxOutput** to select the desired output type.

1. TrigOut

After this type is selected, the oscilloscope output a signal that can reflect the current capture rate of the oscilloscope at each trigger.

2. Fast

After this type is selected, the oscilloscope can output a fast edge signal which can be used in the self-calibration of the oscilloscope.

3. GND

After this type is selected, the oscilloscope can output a ground level.

4. PassFail

After this type is selected, the oscilloscope will output a pulse signal when failed waveforms are detected. Connect this signal to other control systems to conveniently view the test results.

Reference Clock

This oscilloscope can output the internal 10 MHz sample clock from the **[10MHz In/Out]** connector on the rear panel and receive an external 10 MHz clock to synchronize multiple oscilloscopes.

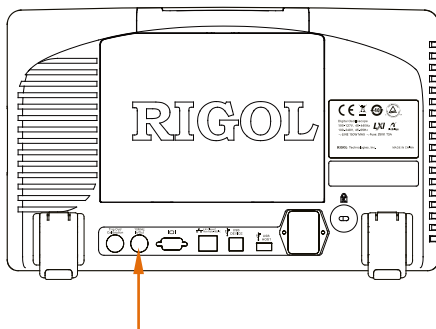

10MHz In/Out

Press **UTIL** → **RefClock** to select the desired clock type.

- ClockOutput: configure the **[10MHz In/Out]** connector as an output and output the internal 10 MHz clock.
- ClockInput: configure the **[10MHz In/Out]** connector as an input and the oscilloscope will receive an external 10 MHz clock input from this connector.

Option Management

This oscilloscope provides multiple options to fulfill your measurement requirements. Please order the corresponding options according to the order numbers provided in "**Appendix A: Accessories and Options**" in this manual. You can view the options currently installed on the oscilloscope and activate the newly bought option.

To install an option, the option license is required (each instrument corresponds to a license). The option license is a 28-byte string and can include uppercase English letters and numbers. After you purchase the desired option, you can get the key used to generate the option license (used to install the option).

Please follow the steps below to generate the option license using the key.

- 1) Log in **RIGOL** official website; click **SERVICE** → **Software License Register** to enter the registered product license code interface.
- 2) Input the correct key, instrument serial number (press **UTIL** → **System** → **System Info** to acquire the instrument serial number) and verification code in the registered product license code interface and click **Generate** to acquire the option license.

Press **UTIL** → **Options** → **Installed** to view the options currently installed in the oscilloscope and the related information. Press **Setup** to open the option installation menu.

- Editor: press this key to open the option license input interface as shown in the figure below. Use  to select the characters on the virtual keyboard and press down the knob to input the character. Note: The option license does not include the hyphens.

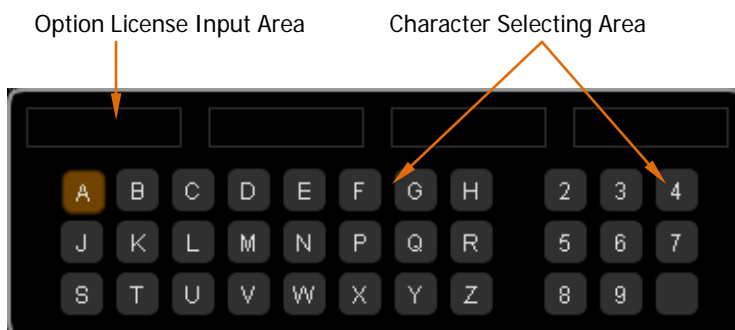

- Backspace: press this softkey to delete the characters in the "Option License Input Area" from the right to the left.
- Clear: press this softkey to clear all the characters in the "Option License Input Area".
- Apply: press this softkey and the oscilloscope will activate the corresponding option using the option license currently input.

To Print the Waveform

To Connect the Print Device

DS6000 oscilloscope supports normal and PictBridge printers; you can set the print parameters and print the current screen image. The connection modes of different print devices are different. Use the USB HOST interface (one on the front panel and rear panel respectively) to connect normal printer and use the USB DEVICE interface to connect PictBridge printer.

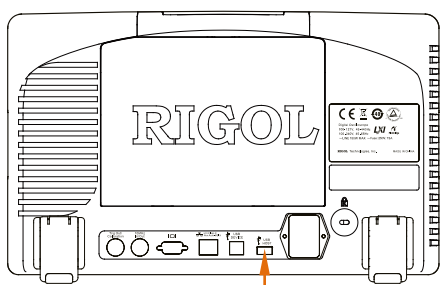

To Connect Normal Printer

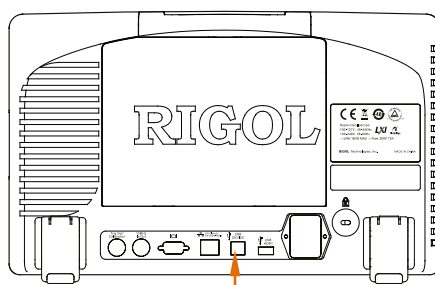

To Connect PictBridge Printer

After the printer is connected, press **UTIL** → **Print** → **Print Mode** to set the print mode to "Normal" or "PictBridge" according to the printer currently connected. When PictBridge printer is connected, you also need to press **UTIL** → **IO Setting** → **USB Device** to select "PictBridge".

Normal Print

After "Normal" is selected, please refer to the following steps to set the print parameters to execute print.

1. Print Range

Press this softkey to select "Screen" (default) or "Wave".

- Screen: print the whole screen image.
- Wave: only print the waveform and the basic information.

2. Palette

Press this softkey to select "Color" (default) or "GrayScale".

3. Invert

Press this softkey to turn the invert print on or off.

4. Print

After setting the print parameters, press this softkey or press the  shortcut key on the front panel directly to execute the print operation.

PictBridge Print

PictBridge is a new print standard. If your oscilloscope and the printer both comply with the PictBridge standard, you can connect the oscilloscope to the printer using a USB cable to print the screen image directly.

Devices comply with the PictBridge standard always have the icon as shown in the figure on the right.



After selecting the "PictBridge" print mode, please refer to the following steps to set the print parameters and execute print.

1. Status

A prompting frame will appear to show the current print status after you press this softkey.

2. Print Range

Press this softkey to select "Screen" (default) or "Wave".

- Screen: print the whole screen image.
- Wave: only print the waveform and the basic information.

3. Palette

Press this softkey to select "Color" (default) or "GrayScale".

4. Paper Size

Press this softkey to select the size of the paper of the print. You can select default, A2, A3, A4, A5, A6 or B5.

5. File Type

Press this softkey to select the picture type of the print. You can select default, Jpeg or Bmp.

Note: The picture types available are related to the property of the printer connected. Picture types not supported by the printer cannot be selected.

6. Print Quality

Press this softkey to select the print quality. You can select Default, Normal, Draft or Fine.

Note: The print qualities available are related to the property of the printer connected. Print qualities not supported by the printer cannot be selected.

7. Date Print

Press this softkey to turn the date print on or off.

Note: The date print is determined by the property of the printer connected. It cannot be printed if the printer does not support this function.

8. Invert

Press this softkey to turn the invert print on or off.

9. Copies

Press this softkey and use  to set the copies to be printed. The range is from 1 to 999.

10. Print

After setting the print parameters, press this softkey or press the  shortcut key on the front panel directly to execute the print operation.

11. Abort

As the PictBridge printer is the master device, you need to terminate the print via the oscilloscope by pressing **Abort**.

Note: This menu is only displayed during the print.

12. Continue

When the print operation is paused, pressing this softkey can continue the unfinished print operation.

14 Remote Control

The oscilloscope can be controlled remotely mainly using the following two methods:

User-defined programming

Users can program and control the oscilloscope by using the SCPI (Standard Commands for Programmable Instruments) commands. For more information about the commands and programming, refer to the *DS6000 Programming Guide*.

Use PC software

Users can use the PC software to send commands to remotely control the oscilloscope. Ultra Sigma of **RIGOL** is recommended. You can acquire Ultra Sigma from the resource CD in the standard accessories or download the latest version from **RIGOL** official website (www.rigol.com).

This oscilloscope can communicate with the PC through USB, LAN or GPIB (together with the USB to GPIB interface converter of **RIGOL**) instrument bus. This chapter provides a detailed introduction of how to use **Ultra Sigma** to control DS6000 remotely through various interfaces.

The contents of this chapter:

- Remote Control via USB
- Remote Control via LAN
- Remote Control via GPIB

Remote Control via USB

1. Connect the device

Connect the oscilloscope (USB DEVICE) and PC using a USB cable.

2. Install the USB driver

This oscilloscope is a USB-TMC device. After you connect the oscilloscope to the PC and turn both on for the first time (the oscilloscope will be automatically set to USB interface; at the same time, please confirm that "Computer" is currently selected in **UTIL** → **IO Setting** → **USB Device**), the PC will display the **Found New Hardware Wizard** dialog box as shown in the figure below. Please install the "USB Test and Measurement Device (IVI)" driver following the directions in the wizard. The steps are as follows.

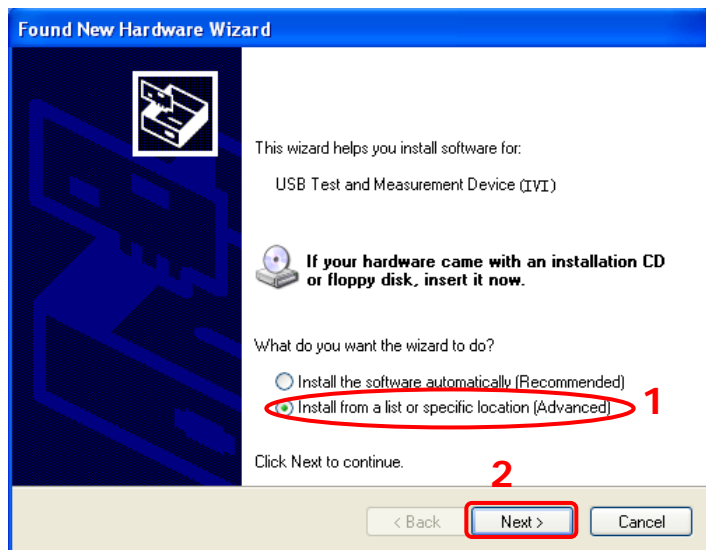

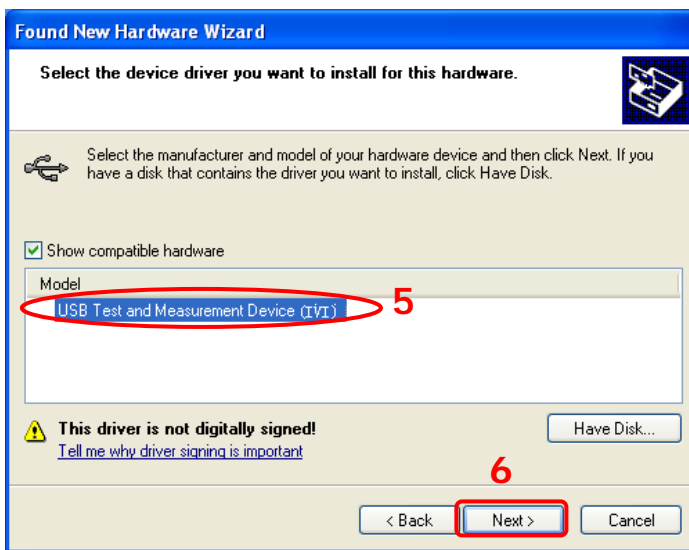
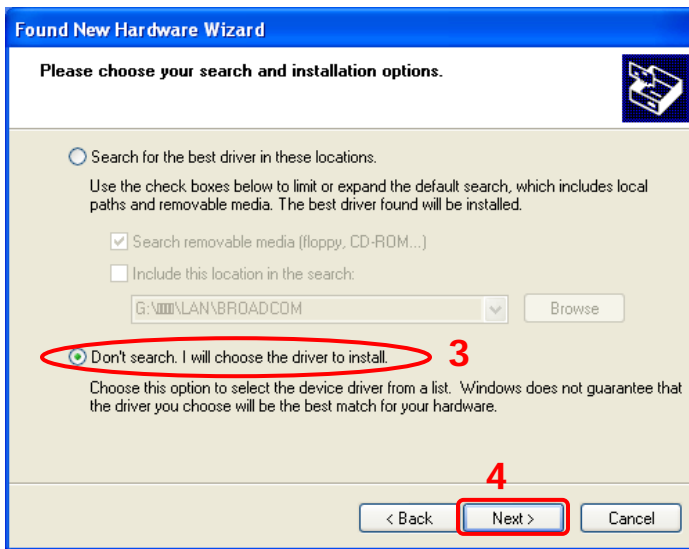

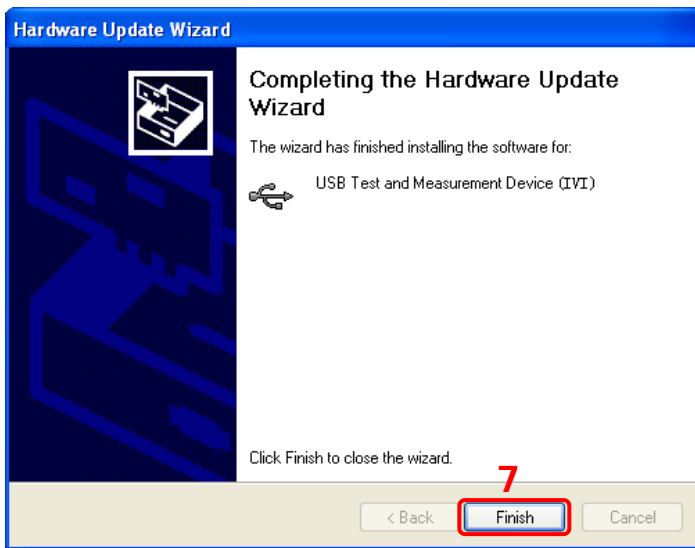
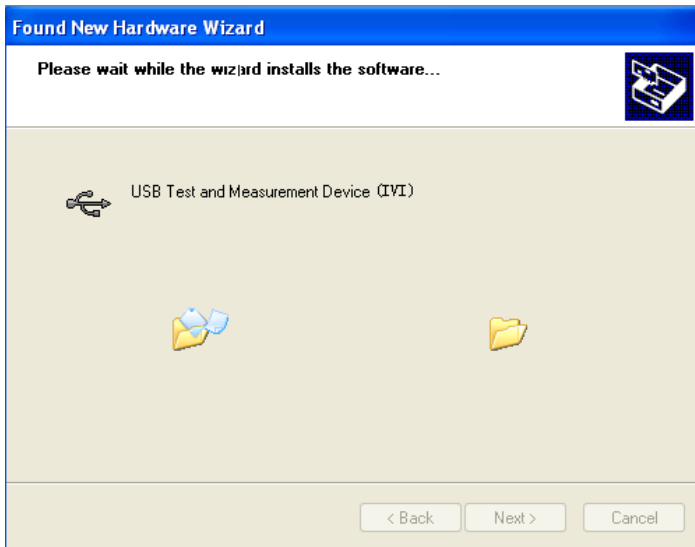

3. Search device resource

Start up **Ultra Sigma** and the software will automatically search for the instrument resource currently connected to the PC through the USB interface. You can also click **USB-TMC** to search for the resource.

4. View the device resource

The resource found will appear under the "RIGOL Online Resource" directory and the model number and USB interface information of the instrument will also

be displayed.

For example, DS6104 (USB0::0x1AB1::0x04B0::DS6A000000001::INSTR).

5. Control the instrument remotely

Right click the resource name

"DS6104 (USB0::0x1AB1::0x04B0::DS6A000000001::INSTR)" to select "SCPI Panel Control" to turn on the remote command control panel from which you can send commands and read data.

Remote Control via LAN

1. Connect the device

Connect the oscilloscope to your LAN using a network cable.

2. Configure network parameters

Configure the network parameters of the oscilloscope according to the description in "LAN Setting".

3. Search device resource

Start up **Ultra Sigma** and click **LAN** to open the panel as shown in the figure below. Click **Search** and the software will automatically search for the instrument resource currently connected to the LAN; the name of the instrument resource found is displayed at the right of the panel. Click **OK** to add the resource. Note that if you want to remove the unwanted resource, click the resource name to select it and then click **Remove**.

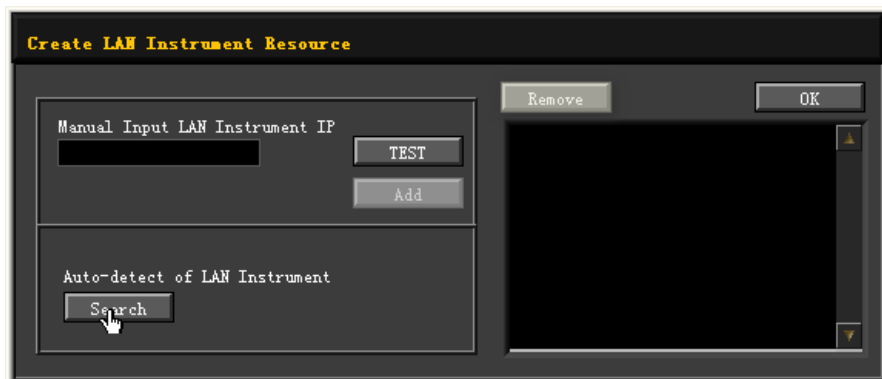

4. View device resource

The resource found will appear under the "RIGOL Online Resource" directory. For example, DS6104 (TCPIP::172.16.3.161::INSTR).

5. Control the instrument remotely

Right click the resource name "DS6104 (TCPIP::172.16.3.161::INSTR)" to select "SCPI Panel Control" to turn on the remote command control panel from which you can send commands and read data.

6. Load LXI webpage

As this oscilloscope conforms to LXI-C standards, you can load LXI webpage through Ultra Sigma (right-click the resource name and select "LXI-Web"). Important information about the oscilloscope including the model number, manufacturer, serial number, description, MAC address and IP address will be displayed on the webpage.

In the LXI webpage, click "Network Settings" at the left side; then, input the initial password "111111" in the pop-up window (by default, the user name is empty) and click "OK" to view or modify the current network settings of the instrument. Besides, you can click "Security" to reset the password.

Tip

You can also load the LXI webpage by entering the IP address of the instrument in the address bar of the PC browser.

Remote Control via GPIB

1. Connect the device

Use the USB to GPIB interface converter to extend a GPIB interface for the oscilloscope. Then connect the oscilloscope to your PC using a GPIB cable.

2. Install the driver of GPIB card

Install the driver of the GPIB card which has been connected to the PC correctly.

3. Set the GPIB address

Set the GPIB address of the oscilloscope according to the description in "To Set the GPIB Address".

4. Search device resource

Start up **Ultra Sigma** and click **GPIB** to open the panel as shown in the figure below. Click **Search** and the software will automatically search for the instrument resource currently connected to the PC through the GPIB interface. The name of the device resource found will be displayed on the right side of the panel. Click **OK** to add the resource. Note that if you want to remove the unwanted resource, click the resource name to select it and then click **Remove**.

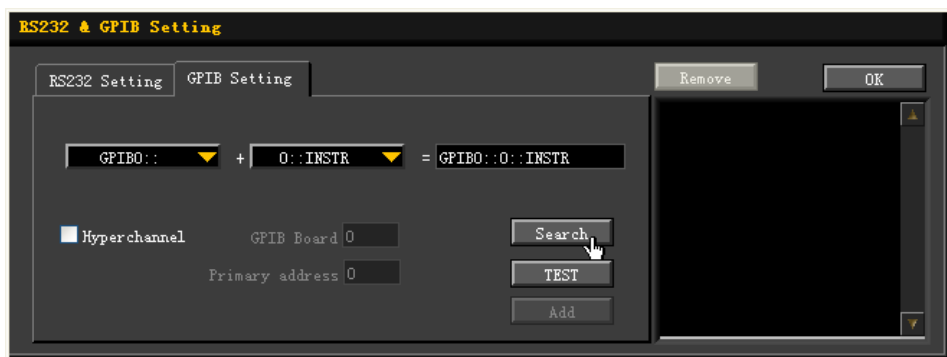

If resource cannot be found automatically:

- Select the GPIB card address of the PC from the dropdown box of "GPIB::" and select the GPIB address set in the oscilloscope from the dropdown box of "::INSTR".
- Click **TEST** to check whether the GPIB communication works

normally; if not, please follow the corresponding prompt messages to solve the problem.

5. View device resource

The resource found will appear under the "RIGOL Online Resource" directory. For example, DS6104 (GPIB0::18::INSTR).

6. Control the instrument remotely

Right-click the resource name "DS6104 (GPIB0::18::INSTR)" to select "SCPI Panel Control" to turn on the remote command control panel from which you can send commands and read data.

15 Troubleshooting

The commonly encountered failures and their solutions are listed below. When you encounter those problems, please solve them following the corresponding steps. If the problem remains still, please contact **RIGOL** and provide your device information (acquisition method: **UTIL** → **System** → **System Info**).

1. The screen is still dark (no display) after power on:

- (1) Check whether the power is correctly connected or if the battery is correctly installed.
- (2) Check whether the power switch is really on.
- (3) Check whether the fuse is burned out. If the fuse needs to be changed, please return the instrument to the factory and the **RIGOL** authorized personnel will change the fuse for you.
- (4) Restart the instrument after finishing the above inspections.
- (5) If it still does not work correctly, please contact **RIGOL**.

2. The signal is sampled but no waveform of the signal is displayed:

- (1) Check whether the probe is correctly connected to the oscilloscope and the item to be tested.
- (2) Check whether there are signals generated from the item under test (you can connect the probe compensation signal to the problematic channel to determine which has problems, the channel or the item under test).
- (3) Resample the signal.

3. The tested voltage amplitude is greater or lower than the actual value (note that this problem usually occurs when probe is used):

Check whether the attenuation coefficient of the channel complies with the attenuation ratio of the probe.

4. There is waveform display but not stable:

- (1) Check the trigger signal source: press **MENU** in the trigger control area (TRIGGER) on the front panel; check whether the setting of **Source** complies with the signal channel actually used.
- (2) Check the trigger type: general signals should use "Edge" trigger and video

signal should use "Video" trigger. Only when the proper trigger type is used, can the waveform be displayed stably.

- (3) Check the trigger level: adjust the trigger level to the middle position of the signal.
- (4) Change the trigger coupling type: if edge trigger is currently selected, press **MENU** (in the trigger control area (TRIGGER) on the front panel) → **Setting** → **Coupling** to select "HF Reject" or "LF Reject" to filter out the high-frequency or low-frequency noise that disturbs the trigger.
- (5) Change the trigger holdoff setting.

5. No display after pressing **Run/Stop**:

Check the trigger control panel (TRIGGER) on the front panel to check whether the trigger mode is set to "Normal" or "Single" and whether the trigger level exceeds the waveform range. If yes, set the trigger level to the middle or set the trigger mode to "Auto".

Note: Using the **Auto** key could automatically finish the above setting.

6. The display of waveform is ladder-like:

- (1) The horizontal time base might be too low. Increase the horizontal time base properly to improve the display.
- (2) If **DISP** → **Type** is set to "Vectors", the lines between the sample points may cause ladder-like display of the waveform. Set **Type** to "Dots" to solve the problem.

7. Fail to connect the PC or PictBridge printer through the USB interface:

Press **UTIL** → **IO Setting** and check whether the setting in **USB Device** matches the currently connected device. If needed, restart the oscilloscope.

8. The USB storage device cannot be recognized:

- (1) Check whether the USB storage device can work normally.
- (2) Make sure that the USB storage device being used is flash storage type. This oscilloscope does not support hardware storage type.
- (3) Make sure whether the capacity of the USB storage device is too large. It is recommended that the capacity of the USB storage device being used with this oscilloscope is no larger than 4 GBytes.
- (4) Restart the instrument and then insert the USB storage to check it.
- (5) If the USB storage device still cannot be used normally, please contact **RIGOL**.

16 Specifications

All the specifications are guaranteed except the parameters marked with "Typical" and the oscilloscope needs to operate for more than 30 minutes under the specified operation temperature.

Sample

Sample Mode	Real-time Sample, Equivalent Sample
Real Time Sample Rate	5 GSa/s (single-channel) 2.5 GSa/s (dual-channel)
Equivalent Sample Rate	100 GSa/s
Peak Detect	200 ps (single-channel) 400 ps (dual-channel)
Averaging	After all the channels finish N samples at the same time, N can be 2, 4, 8, 16, 32, 64, 128, 256, 512, 1024, 2048, 4096 or 8192.
High Resolution	12 bit resolution when $\geq 5 \mu\text{s}/\text{div}$ @ 5 GSa/s (or $\geq 10 \mu\text{s}/\text{div}$ @ 2.5 GSa/s).
Memory Depth	single-channel: Auto, 14k pts, 140k pts, 1.4M pts, 14M pts and 140M pts are available dual-channel: Auto, 7k pts, 70k pts, 700k pts, 7M pts and 70M pts are available

Input

Number of Channels	DS6XX4: four channels DS6XX2: two channels
Input Coupling	DC, AC, GND
Input Impedance	(1 M Ω \pm 1%) (13 pF \pm 3 pF) or 50 Ω \pm 1.5%
Probe Attenuation Coefficient	0.01X to 1000X, in 1-2-5 step
Maximum Input Voltage (1M Ω)	Maximum Input Voltage of the Analog Channel CAT I 300 Vrms, CAT II 100 Vrms, Transient Overvoltage 1000V pk with RP2200 10:1 probe: CAT II 300 Vrms with RP3300A 10:1 probe: CAT II 300 Vrms with RP3500A 10:1 probe: CAT II 300 Vrms with RP5600A 10:1 probe: CAT II 300 Vrms

Horizontal

Timebase Scale	DS606X: 1 ns to 1000 s DS610X: 500 ps to 1000 s
Deviation Between Channels	± 0.5 div*minimum time base
Max Recording Length	140 Mpts
Timebase Accuracy	$\leq \pm 4$ ppm
Clock Drift	$\leq \pm 2$ ppm/year
Delay Range	Pre-trigger (negative delay): memory depth/sample rate Post-trigger (positive delay): 1 s to 100,000 s
Timebase Mode	Y-T, X-Y, Roll, Delayed Sweep
Number of X-Ys	2 paths simultaneously (four-channel models)
Waveform Capture Rate ¹¹	150,000 wfms (vector display); 180,000 wfms (dots display)
Zero Point Offset	± 0.5 div*minimum time base

Vertical

Bandwidth (-3 dB) (50 Ω)	DS606X: DC to 600 MHz DS610X: DC to 1 GHz
Single-shot Bandwidth (50 Ω)	DS606X: DC to 600 MHz DS610X: DC to 1 GHz (each channel)
Vertical Resolution	8 bits, two channels sample at the same time
Vertical Scale	2 mV/div to 5 V/div (1 MΩ) 2 mV/div to 1 V/div (50 Ω)
Offset Range	2 mV/div to 124 mV/div: ±1.2 V (50 Ω) 126 mV/div to 1 V/div: ±12 V (50 Ω) 2 mV/div to 225 mV/div: ±2 V (1 MΩ) 230 mV/div to 5 V/div: ±40 V (1 MΩ)
Bandwidth Limit ^[2]	20 MHz or 250 MHz
Low Frequency Response (AC Coupling -3 dB)	≤5 Hz (on BNC)
Calculated Rise Time ^[2]	DS606X: 600 ps DS610X: 400 ps
DC Gain Accuracy	±2% full scale
DC Offset Accuracy	200 mV/div to 5 V/div: ±0.1 div ± 2 mV±0.5% offset value 1 mV/div to 195 mV/div: ±0.1 div ± 2 mV±1.5% offset value
ESD Tolerance	±2 kV
Channel to Channel Isolation	DC to maximum band width: >40 dB

Trigger

Trigger Level Range	Internal	± 6 div from center screen
	EXT	± 0.8 V
Trigger Mode	Auto, Normal, Single	
Holdoff Range	100 ns to 10 s	
High Frequency Rejection ^[2]	50 kHz	
Low Frequency Rejection ^[2]	5 kHz	

Edge Trigger

Edge Type	Rising, Falling, Rising&Falling
-----------	---------------------------------

Pulse Trigger

Pulse Condition	Positive Pulse Width (greater than, lower than, within specific interval) Negative Pulse Width (greater than, lower than, within specific interval)
Pulse Width Range	4 ns to 4 s

Slope Trigger

Slope Condition	Positive Slope (greater than, lower than, within specific interval) Negative Slope (greater than, lower than, within specific interval)
Time Setting	10 ns to 1 s

Video Trigger

Signal Standard	Support standard NTSC, PAL and SECAM broadcasting standards; support 480P, 576P, 720P, 1080P and 1080I HDTV standards
-----------------	---

Pattern Trigger

Pattern Setting	H, L, X, Rising Edge, Falling Edge
-----------------	------------------------------------

RS232/UART Trigger

Trigger Condition	Start, Error, Check Error, Data
Polarity	Normal, Invert
Baud Rate	2400 bps, 4800 bps, 9600 bps, 19200 bps, 38400 bps, 57600 bps, 115200 bps, 230400 bps, 460800 bps, 921600 bps, 1 Mbps, User

Data Bits	5 bit, 6 bit, 7 bit, 8 bit
I2C Trigger	
Trigger Condition	Start, Restart, Stop, Missing ACK, Address, Data, A&D
Address Bits	7 bit, 8 bit, 10 bit
Address Range	0 to 127, 0 to 255, 0 to 1023
Byte Length	1 to 5
SPI Trigger	
Trigger Condition	CS, Timeout
Timeout Value	100 ns to 1 s
Data Bits	4 bit to 32 bit
Data	H, L, X
Clock Edge	Rising Edge, Falling Edge
CAN Trigger	
Signal Type	Rx, Tx, CAN_H, CAN_L, Differential
Trigger Condition	SOF, EOF, Frame Type, Frame Error
Baud Rate	10 kbps, 20 kbps, 33.3 kbps, 50 kbps, 62.5 kbps, 83.3 kbps, 100 kbps, 125 kbps, 250 kbps, 500 kbps, 800 kbps, 1 Mbps, User
Sample Point	5% to 95%
Frame Type	Data, Remote, Error, OverLoad
Error Frame Type	Bit Fill, Answer Error, Check Error, Format Error, Random Error
FlaxRay Trigger	
Baud Rate	2.5 Mb/s, 5 Mb/s, 10 Mb/s
Trigger Condition	Frame, Symbol, Error, TSS
USB Trigger	
Signal Speed	Low Speed, Full Speed
Trigger condition	SOP, EOP, RC, Suspend, ExitSuspend

Measure

Cursor	Manual Mode	Voltage Deviation between Cursors (ΔV) Time Deviation between Cursors (ΔT) Reciprocal of ΔT (Hz) ($1/\Delta T$)
	Track Mode	Voltage and Time Values of the Waveform Point
	Auto Mode	Allow to display cursors during auto measurement
Auto Measurement	Maximum, Minimum, Peak-Peak Value, Top Value, Base Value, Amplitude, Average, Vrms-N, Vrms-1, Overshoot, Pre-shoot, Area, Period Area, Frequency, Period, Rise Time, Fall Time, Positive Pulse Width, Negative Pulse Width, Positive Duty Cycle, Negative Duty Cycle, Delay $A_f \rightarrow B_f$, Delay $A_t \rightarrow B_t$, Delay $A_f \rightarrow B_t$, Delay $A_t \rightarrow B_f$, Phase $A_f \rightarrow B_f$, Phase $A_t \rightarrow B_t$, Phase $A_f \rightarrow B_t$, Phase $A_t \rightarrow B_f$	
Number of Measurements	Display 5 measurements at the same time.	
Measurement Range	Screen, Cursor	
Statistic Mode	Extremum, Difference	
Measurement Statistic	Average, Max, Min, Standard Deviation, Number of Measurements	
Frequency Counter	Hardware 6 bits frequency counter (channels available: DS606x, CH1/CH2; DS610x, CH1/CH2/CH3/CH4)	

Math Operation

Waveform Operation	A+B, A-B, A×B, A÷B, FFT, Editable Advanced Operation, Logic Operation
FFT Window Function	Rectangle, Hanning, Blackman, Hamming
FFT Display	Split, Full Screen
FFT Vertical Scale	Vrms, dB
Anti-aliasing	OFF
Logic Operation	AND, OR, NOT, XOR
Math Function	Intg, Diff, Lg, Exp, Sqrt, Sine, Cosine, Tangent
Number of Buses for Decoding	2
Decoding Type	Parallel (standard), RS232/UART (option), I2C (option) , SPI (DS6XX4 option), CAN (option), FlaxRay (option)

Display

Display Type	10.1 inches (257 mm) TFT LCD display
Display Resolution	800 Horizontal ×RGB×480 Vertical Pixel
Display Color	160,000 Color
Persistence Time	Minimum, 50 ms, 100 ms, 200 ms, 500ms, 1 s, 2 s, 5 s, 10 s, 20 s, Infinite
Display Type	Dots, Vectors
Real-time Clock	Time and Date (user adjustable)

I/O

Standard Ports	Dual USB HOST, USB device, LAN, VGA Output, 10 MHz Input/Output, Aux output (TrigOut, Fast, GND, PassFail)
Printer Compatibility	PictBridge

General Specifications

Probe Compensation Output

Output Voltage ^[2]	About 3 V, peak-peak
Frequency ^[2]	1kHz

Power

Power Voltage	100-127 V, 45-440 Hz 100-240 V, 45-65 Hz
Power	Maximum 150W
Fuse	3 A, T Degree, 250 V

Environment

Temperature Range	Operating: 0°C to +50°C
	Non-operating: -20°C to +70°C
Cooling Method	Fan cooling
Humidity Range	Under +35°C: ≤90% Relative Humidity
	+35°C to +50°C: ≤60% Relative Humidity
Altitude	Operating: under 3,000 meters
	Non-operating: under 15,000 meters

Mechanical Characteristics

Size ^[3]	W × H × D = 399.0 mm × 255.3 mm × 123.8 mm	
Weight ^[4]	Package Excluded	5.345 kg ± 0.2 kg
	Package Included	10.8 kg ± 1 kg

Calibration Interval

The recommended calibration interval is one year.

Regulatory Information

Electromagnetic Compatibility	2004/108/EC Execution standard EN 61326-1:2006 EN 61326-2-1:2006
Safety	UL 61010-1:2004 ; CAN/CSA-C22.2 NO. 61010-1-2004 ; EN 61010-1:2001 ; IEC 61010-1:2001

Note^[1]: Maximum value. In single-channel mode, sine signal with 10 ns horizontal scale, 4 div input amplitude and 10 MHz frequency, edge trigger.

Note^[2]: Typical.

Note^[3]: Supporting legs and handle folded, knob height included, front panel cover excluded.

Note^[4]: DS6104 model, standard configuration.

17 Appendix

Appendix A: Accessories and Options

	Description	Order Number
Model	DS6104 (1 GHz, 4-channel)	DS6104
	DS6102 (1 GHz, dual-channel)	DS6102
	DS6064 (600 MHz, 4-channel)	DS6064
	DS6062 (600 MHz, dual-channel)	DS6062
Standard Accessories	Power Cord conforming to the standard of the country	--
	Front Panel Cover	FPCS-DS6000
	USB Cable	CB-USBA-USBB-FF-150
	2 or 4 Passive Probes (600 MHz)	RP5600A
	1 or 2 Passive Probes (1.5 GHz)	RP6150A (for DS610X)
	Quick Guide	--
	Resource CD (User's Guide and Application Software)	--
Optional Accessories	Active Differential Probe (1.5 GHz)	RP7150
	Passive Probes (500 MHz)	RP3500A
	11.1 V, 147 Wh Lithium Battery Set	BAT
	USB to GPIB Interface Converter	USB-GPIB
	Desk Mount Instrument Arm	ARM
	Rack Mount Kit	RM-DS6000
	TekProbe Interface Adaptor	T2R1000
Decoding Options	RS232/UART Decoding Kit	SD-RS232-DS6000
	I2C /SPI Decoding Kit	SD-I2C/SPI-DS6000
	CAN Decoding Kit	SD-CAN-DS6000
	FlexRay Decoding Kit	SD-FLEXRAY-DS6000

Note: All the options or accessories can be ordered from your local **RIGOL** office.

Appendix B: Warranty

RIGOL warrants that the product mainframe and product accessories will be free from defects in materials and workmanship within the warranty period.

If a product proves defective within the respective period, **RIGOL** guarantees free replacement or repair of any defective products within a reasonable period of time. To get repair service, please contact with your nearest **RIGOL** sales or service office.

There is no other warranty, expressed or implied, except such as is expressly set forth herein or other applicable warranty card. There is no implied warranty of merchantability or fitness for a particular purpose. Under no circumstances shall **RIGOL** be liable for any consequential, indirect, ensuing or special damages for any breach of warranty in any case.

Index

- Duty 6-18
- Width 6-18
- + Duty 6-18
- + Width 6-18
- Acquisition Mode 4-2
- Addition 6-2
- AND 6-9
- Anti-aliasing 4-9
- Area 6-22
- Auto 5-4
- Auto IP 13-3
- Auto Mode 6-39
- Aux Output 13-11
- Average 4-2
- BandWidth Limit 2-4
- Blackman 6-7
- CAN Decoding 7-17
- Channel Coupling 2-3
- Channel Label 2-13
- CSV 12-4
- Cursor 6-29
- Decoding Table 7-4
- Default Gate 13-4
- Delay 6-19
- Delay Calibration 2-14
- Delayed Sweep 3-2
- DHCP 13-3
- Division 6-5
- Domain Name Server 13-5
- Dots 11-2
- Edge Trigger 5-8
- Edge Type 5-8
- Equivalent Sample 4-5
- Expression 6-12
- Factory 12-17
- Fall Time 6-18
- FFT 6-6
- FlexRay Decoding 7-21
- FlexRay Trigger 5-29
- Frequency 6-18
- Frequency Counter 6-23
- GPIOB 13-6
- Hamming 6-7
- Hanning 6-7
- High Resolution 4-4
- Horizontal Position 3-9
- Horizontal Reference 3-11
- Horizontal Scale 3-9
- I2C Decoding 7-10
- Input Impedance 2-9
- IP Address 13-3
- LAN 13-2
- MAC 13-5
- Manual Mode 6-31
- Memory Depth 4-8
- Multiplication 6-3
- Network Status 13-2
- Normal 4-2, 5-4
- NOT 6-9
- Operator 6-13
- OR 6-9
- Overshoot 6-22
- Parallel Decoding 7-2
- Pattern Setting 5-17
- Pattern Trigger 5-17
- Peak Detect 4-4
- Period 6-18
- Period Area 6-22

Persistence Time	11-3	Variable.....	6-12
Phase	6-19	Vavg	6-21
Picture.....	12-4	Vbase	6-21
Preshoot.....	6-22	Vectors	11-2
Pulse Condition	5-10	Vertical Expansion	2-12
Pulse Width Setting.....	5-11	Vertical Position	2-11
Real-time Sample	4-5	Vertical Scale	2-10
Record Constant On.....	10-4	Vertical Window	5-13
Rectangle	6-7	Video Polarity	5-15
Rise Time	6-18	Video Standard	5-16
Roll	3-8	Video Trigger	5-15
RS232 Decoding.....	7-5	VISA	13-5
Sample Rate	4-6	Vmax	6-21
Setups.....	12-3	Vmin.....	6-21
Single.....	5-4	Vpp	6-21
Slope Condition	5-12	Vrms-1.....	6-21
Slope Trigger.....	5-12	Vrms-N	6-21
SPI Decoding	7-13	Vtop	6-21
Static IP	13-3	Waveform Aliasing.....	4-6
Subnet Mask	13-4	Waveform Analysis	10-7
Substraction.....	6-3	Waveform Distortion.....	4-6
Sync.....	5-15	Waveform Invert	2-9
Threshold	6-25	Waveform Leakage.....	4-7
Time Setting	5-13	Waveform Playback	10-5
Traces	12-3	Waveform Recording	10-2
Track Mode.....	6-35	Waveforms	12-3
Trigger Coupling.....	5-5	Window Function	6-6
Trigger Holdoff	5-6	X Cursors	6-29
Trigger Level	5-8	XOR.....	6-9
Trigger Mode.....	5-3	X-Y	3-5
Trigger Source.....	5-2	X-Y Mode.....	6-40
USB.....	13-6	Y Cursors	6-29
Vamp	6-21	Y-T	3-4